

## Schema FundsXML4.xsd

schema location: <L:\13 Statistik\FundsXML\Schemata\FundsXML 4.2.5\FundsXML 4.2.5\FundsXML 4.2.5\FundsXML4.xsd>  
attribute form default: **unqualified**  
element form default: **qualified**

|                           |  |
|---------------------------|--|
| Elements                  | Complex types                            |
| <a href="#">FundsXML4</a> | <a href="#">ControlDataType</a>          |
|                           | <a href="#">DirectReportingType</a>      |
|                           | <a href="#">DocumentsType</a>            |
|                           | <a href="#">DocumentType</a>             |
|                           | <a href="#">FundType</a>                 |
|                           | <a href="#">IndirectReportingType</a>    |
|                           | <a href="#">RegulatoryReportingsType</a> |
|                           | <a href="#">SegmentDynamicDataType</a>   |
|                           | <a href="#">SegmentStaticDataType</a>    |
|                           | <a href="#">SegmentType</a>              |
|                           | <a href="#">SingleFundType</a>           |
|                           | <a href="#">SubfundType</a>              |

schema location: <L:\13 Statistik\FundsXML\Schemata\FundsXML 4.2.5\FundsXML 4.2.5\FundsXML 4.2.5\FundsXML4 Core.xsd>  
attribute form default: **unqualified**  
element form default: **qualified**

|   |   |
|---|---|
| Complex types                                   | Simple types                                    |
| <a href="#">AddressType</a>                     | <a href="#">BicCodeType</a>                     |
| <a href="#">AmountType</a>                      | <a href="#">CompanyListedClassificationType</a> |
| <a href="#">AttributesType</a>                  | <a href="#">EmailAddressType</a>                |
| <a href="#">AttributeType</a>                   | <a href="#">FrequencyType</a>                   |
| <a href="#">AUMType</a>                         | <a href="#">ISINType</a>                        |
| <a href="#">ClassificationsType</a>             | <a href="#">ISOCountryCodeType</a>              |
| <a href="#">ClassificationType</a>              | <a href="#">ISOCurrencyCodeType</a>             |
| <a href="#">CompanyType</a>                     | <a href="#">ISOLanguageCodeType</a>             |
| <a href="#">DataSupplierType</a>                | <a href="#">LEICodeType</a>                     |
| <a href="#">DayMonthType</a>                    | <a href="#">ListedIdentifierType</a>            |
| <a href="#">DynLenNamesType</a>                 | <a href="#">MICCodeType</a>                     |
| <a href="#">FundAmountType</a>                  | <a href="#">PercentageType</a>                  |
| <a href="#">FundOrShareClassIdentifiersType</a> | <a href="#">positiveDecimals</a>                |
| <a href="#">FundRelatedTextType</a>             | <a href="#">Text1000Type</a>                    |
| <a href="#">FXRatesType</a>                     | <a href="#">Text100Type</a>                     |
| <a href="#">FXRateType</a>                      | <a href="#">Text128Type</a>                     |
| <a href="#">HedgingStrategyType</a>             | <a href="#">Text16Type</a>                      |
| <a href="#">IdentifiersType</a>                 | <a href="#">Text1Type</a>                       |
| <a href="#">IssuerType</a>                      | <a href="#">Text200Type</a>                     |
| <a href="#">LanguageNamesType</a>               | <a href="#">Text256Type</a>                     |
| <a href="#">NamesType</a>                       | <a href="#">Text2Type</a>                       |
| <a href="#">OtherPricesType</a>                 | <a href="#">Text300Type</a>                     |
| <a href="#">PositiveAmountType</a>              | <a href="#">Text32Type</a>                      |
| <a href="#">ShareClassTypeType</a>              | <a href="#">Text4Type</a>                       |
| <a href="#">SingleAmountType</a>                | <a href="#">Text500Type</a>                     |
| <a href="#">TotalAssetValueType</a>             | <a href="#">Text64Type</a>                      |

[Text8Type](#)

[YesNoType](#)

schema location: <L:\13 Statistik\FundsXML\Schemata\FundsXML 4.2.5\FundsXML 4.2.5\FundsXML 4.2.5\FundsXML4 CountrySpecificData.xsd>

attribute form **unqualified**

default:

element form **qualified**

default:

Complex types

[CountrySpecificDataType](#)

[CountrySpecificEMT41DataType](#)

[CountrySpecificEMTDataType](#)

[CountrySpecificFundDataType](#)

[CountrySpecificShareClassDataType](#)

schema location: <L:\13 Statistik\FundsXML\Schemata\FundsXML 4.2.5\FundsXML 4.2.5\FundsXML 4.2.5\FundsXML4 FundStaticData.xsd>

attribute form **unqualified**

default:

element form **qualified**

default:

Complex types

[BenchmarkProviderCompany](#)

[BenchmarkStaticDataType](#)

[FundCompaniesType](#)

[FundCompanyType](#)

[FundStaticDataType](#)

[SingleFundStaticDataType](#)

[SubfundCompaniesType](#)

[SubfundCompanyType](#)

[SubfundStaticDataType](#)

Simple types

[BenchmarkUsageType](#)

schema location: <L:\13 Statistik\FundsXML\Schemata\FundsXML 4.2.5\FundsXML 4.2.5\FundsXML 4.2.5\FundsXML4 FundDynamicData.xsd>

attribute form **unqualified**

default:

element form **qualified**

default:

Complex types

[BenchmarkDynamicDataType](#)

[FundDynamicDataType](#)

schema location: [L:\13 Statistik\FundsXML\Schemata\FundsXML 4.2.5\FundsXML 4.2.5\FundsXML 4.2.5\FundsXML4\\_ShareClassData.xsd](L:\13 Statistik\FundsXML\Schemata\FundsXML 4.2.5\FundsXML 4.2.5\FundsXML 4.2.5\FundsXML4_ShareClassData.xsd)

attribute form **unqualified**

default:

element form **qualified**

default:

Complex types

[AllocationType](#)

[DataPointType](#)

[DistributionType](#)

[FeePeriodDataType](#)

[FeesType](#)

[FlowType](#)

[HighWatermarkType](#)

[InvestorType](#)

[InvestorTypesType](#)

[PerformanceFiguresType](#)

[PerformanceType](#)

[RatingType](#)

[ShareClassFeeType](#)

[ShareClassPriceType](#)

[ShareClassType](#)

[TotalReturnType](#)

Simple types

[CalculationPeriodType](#)

[DateIntervalType](#)

schema location: [L:\13 Statistik\FundsXML\Schemata\FundsXML 4.2.5\FundsXML 4.2.5\FundsXML 4.2.5\FundsXML4\\_AssetMasterData.xsd](L:\13 Statistik\FundsXML\Schemata\FundsXML 4.2.5\FundsXML 4.2.5\FundsXML 4.2.5\FundsXML4_AssetMasterData.xsd)

attribute form **unqualified**

default:

element form **qualified**

default:

Complex types

[AccountType](#)

[AssetDetailsType](#)

[AssetMasterDataType](#)

[AssetType](#)

[BenchmarkType](#)

[BondType](#)

[CallCapitalType](#)

[CertificateType](#)

[CommercialPaperType](#)

[ConvertibleBondType](#)

[CounterpartyType](#)

[EquityType](#)

[FeeType](#)

[FixedTimeDepositType](#)

Simple types

[AssetTypeType](#)

[ForeignExchangeTradeType](#)

[FutureType](#)

[IndexType](#)

[IndustryCodeType](#)

[IndustryProviderType](#)

[LegType](#)

[LoanType](#)

[OptionType](#)

[PrivateEquityType](#)

[RatingsType](#)

[RealEstateType](#)

[REITType](#)

[ReposType](#)

[ShareClassDetailsType](#)

[SwapType](#)

[UnderlyingType](#)

[WarrantType](#)

schema location: <L:\13 Statistik\FundsXML\Schemata\FundsXML 4.2.5\FundsXML 4.2.5\FundsXML 4.2.5\FundsXML4 AssetMgmtCompDynData.xsd>

attribute form **unqualified**

default:

element form **qualified**

default:

Complex types

[AssetManagementClosedDataType](#)

[AssetManagementCompanyAggregatedType](#)

[AssetManagementCompanyDataType](#)

[AssetManagementCompanyFundAssetsType](#)

[AssetManagementCompanySalesType](#)

[AssetMgmtCompanyDynDataType](#)

[ClientStatisticType](#)

[FundStatisticClosedFundType](#)

[FundStatisticType](#)

schema location: <L:\13 Statistik\FundsXML\Schemata\FundsXML 4.2.5\FundsXML 4.2.5\FundsXML 4.2.5\FundsXML4 RegulatoryReporting EMIR.xsd>

attribute form **unqualified**

default:

element form **qualified**

default:

Complex types

[EMIR\\_ReportType](#)

[EMIRType](#)

Simple types

[EMIRIDType](#)

schema location: [L:\13 Statistik\FundsXML\Schemata\FundsXML 4.2.5\FundsXML 4.2.5\FundsXML 4.2.5\FundsXML4\\_RegulatoryReporting\\_EMT.xsd](L:\13 Statistik\FundsXML\Schemata\FundsXML 4.2.5\FundsXML 4.2.5\FundsXML 4.2.5\FundsXML4_RegulatoryReporting_EMT.xsd)

attribute form **unqualified**

default:

element form **qualified**

default:

Complex types

[EMT\\_V3\\_FinancialInstrumentType](#)

[EMT\\_V41\\_FinancialInstrumentType](#)

[EMT\\_V4\\_FinancialInstrumentType](#)

[EMTFinancialInstrumentType](#)

[EMTType](#)

[EMTType\\_V3](#)

[EMTType\\_V4](#)

[EMTType\\_V41](#)

Simple types

[EMTYesEmptyType](#)

[EMTYesNeutralType](#)

[EMTYesNoNeutralType](#)

[EMTYesNoType](#)

[RetailProfessionalBothNeitherType](#)

schema location: [L:\13 Statistik\FundsXML\Schemata\FundsXML 4.2.5\FundsXML 4.2.5\FundsXML 4.2.5\FundsXML4\\_RegulatoryReporting\\_KIID.xsd](L:\13 Statistik\FundsXML\Schemata\FundsXML 4.2.5\FundsXML 4.2.5\FundsXML 4.2.5\FundsXML4_RegulatoryReporting_KIID.xsd)

attribute form **unqualified**

default:

element form **qualified**

default:

Complex types

[KIIDsType](#)

[KIIDType](#)

schema location: [L:\13 Statistik\FundsXML\Schemata\FundsXML 4.2.5\FundsXML 4.2.5\FundsXML 4.2.5\FundsXML4\\_RegulatoryReporting\\_PRIIPS.xsd](L:\13 Statistik\FundsXML\Schemata\FundsXML 4.2.5\FundsXML 4.2.5\FundsXML 4.2.5\FundsXML4_RegulatoryReporting_PRIIPS.xsd)

attribute form **unqualified**

default:

element form **qualified**

default:

Complex types

[CEPT\\_PriceType](#)

[CEPT\\_RHPSType](#)

[CEPTV2\\_RHPSType](#)

[CEPTV2HistoryType](#)

[CEPTV2PerformanceType](#)

[CEPTV2PriceType](#)

[PRIIPS\\_AverageReturnType](#)

[PRIIPS\\_InvestmentAmountType](#)

[PRIIPS\\_NarrativesType](#)

[PRIIPS\\_ReportType](#)

[PRIIPS\\_ReturnScenarioType](#)

[PRIIPS\\_SecurityCodificationType](#)

Simple types

[PRIIPSFrequencyType](#)

[PRIIPS\\_V2\\_NarrativesType](#)  
[PRIIPS\\_V2\\_ReturnScenarioType](#)  
[PRIIPSType](#)  
[PRIIPSType\\_V20](#)

schema location: [L:\13\\_Statistik\FundsXML\Schemata\FundsXML\\_4.2.5\FundsXML\\_4.2.5\FundsXML\\_4.2.5\FundsXML4\\_RegulatoryReporting\\_SolvencyII.xsd](L:\13_Statistik\FundsXML\Schemata\FundsXML_4.2.5\FundsXML_4.2.5\FundsXML_4.2.5\FundsXML4_RegulatoryReporting_SolvencyII.xsd)  
attribute form: **unqualified**  
default:  
element form: **qualified**  
default:

Complex types

[CodificationType](#)  
[CodificationType\\_V5](#)  
[CodificationType\\_V6](#)  
[ContributionToSCRTType](#)  
[ContributionToSCRTType\\_V5](#)  
[ContributionToSCRTType\\_V6](#)  
[CreditRiskDataType](#)  
[CreditRiskDataType\\_V5](#)  
[CreditRiskDataType\\_V6](#)  
[RedemptionType](#)  
[RedemptionType\\_V5](#)  
[RedemptionType\\_V6](#)  
[SIIIssuerType](#)  
[SIIIssuerType\\_V5](#)  
[SIIIssuerType\\_V6](#)  
[SIIPositionType](#)  
[SIIPositionType\\_V5](#)  
[SIIPositionType\\_V6](#)  
[SIISecurityCodificationType](#)  
[SIISecurityCodificationType\\_V5](#)  
[SIISecurityCodificationType\\_V6](#)  
[SolvencyIIPortfolioType](#)  
[SolvencyIIPortfolioType\\_V5](#)  
[SolvencyIIPortfolioType\\_V6](#)  
[TripartiteTemplateSolvencyIIType](#)  
[TripartiteTemplateSolvencyIIType\\_V5](#)  
[TripartiteTemplateSolvencyIIType\\_V6](#)

Simple types

[CICCodeType](#)  
[CQSType](#)  
[EconomicArea2Type](#)  
[EconomicAreaType](#)  
[NACECodeType](#)  
[SIICouponFrequencyType](#)  
[SIICouponFrequencyType\\_V5](#)  
[SIICouponFrequencyType\\_V6](#)  
[YesNoL1Type](#)

schema location: [L:\13\\_Statistik\FundsXML\Schemata\FundsXML\\_4.2.5\FundsXML\\_4.2.5\FundsXML\\_4.2.5\FundsXML4\\_RegulatoryReporting\\_EFT.xsd](L:\13_Statistik\FundsXML\Schemata\FundsXML_4.2.5\FundsXML_4.2.5\FundsXML_4.2.5\FundsXML4_RegulatoryReporting_EFT.xsd)  
attribute form: **unqualified**  
default:  
element form: **qualified**  
default:

Complex types

[EFTReportType](#)  
[EFTType](#)

schema location: [L:\13 Statistikk\FundsXML\Schemata\FundsXML 4.2.5\FundsXML 4.2.5\FundsXML 4.2.5\FundsXML4\\_RegulatoryReporting\\_EET.xsd](L:\13 Statistikk\FundsXML\Schemata\FundsXML 4.2.5\FundsXML 4.2.5\FundsXML 4.2.5\FundsXML4_RegulatoryReporting_EET.xsd)

attribute form **unqualified**  
default:  
element form **qualified**  
default:

Complex types

[EETEnhancedExclusionType](#)  
[EETEnhancedExclusionType1.1](#)  
[EETExclusionType](#)  
[EETExclusionType1.1](#)

[EETReportType](#)

[EETReportType1.1](#)

[EETReportType1.1.1](#)

[EETReportType1.1.2](#)

[EETsType](#)

[EETsType1.1](#)

[EETsType1.1.1](#)

[EETsType1.1.2](#)

[EETWeightNumberType](#)

[EETWeightNumberType1.1](#)

[PercentageStrategyCoverageType](#)

[PercentageStrategyCoverageType1.1](#)

[PercentageStrategyCoverageType1.1.2](#)

[ValueStrategyCoverageType](#)

[ValueStrategyCoverageType1.1](#)

[ValueStrategyCoverageType1.1.2](#)

Simple types

[EETYesNeutralType](#)  
[EETYesNoNeutralType](#)  
[EETYesNoType](#)

schema location: [L:\13 Statistikk\FundsXML\Schemata\FundsXML 4.2.5\FundsXML 4.2.5\FundsXML 4.2.5\FundsXML4\\_CountrySpecificData\\_AT.xsd](L:\13 Statistikk\FundsXML\Schemata\FundsXML 4.2.5\FundsXML 4.2.5\FundsXML 4.2.5\FundsXML4_CountrySpecificData_AT.xsd)

attribute form **unqualified**  
default:  
element form **qualified**  
default:

Complex types

[CountrySpecificAssetMasterDataATType](#)  
[CountrySpecificControlDataATType](#)  
[CountrySpecificDataATType](#)  
[CountrySpecificEMTATType](#)  
[CountrySpecificFundDataATType](#)  
[CountrySpecificShareClassDataATType](#)

Simple types

[IdentnummerType](#)

schema location: [L:\13\\_Statistik\FundsXML\Schemata\FundsXML\\_4.2.5\FundsXML\\_4.2.5\FundsXML\\_4.2.5\FundsXML4\\_CountrySpecificData\\_DE.xsd](L:\13_Statistik\FundsXML\Schemata\FundsXML_4.2.5\FundsXML_4.2.5\FundsXML_4.2.5\FundsXML4_CountrySpecificData_DE.xsd)  
attribute form default: **unqualified**  
element form default: **qualified**

Complex types  
[CountrySpecificAssetMasterDataDEType](#)  
[CountrySpecificControlDataDEType](#)  
[CountrySpecificDataDEType](#)  
[CountrySpecificEMTDEType](#)  
[CountrySpecificFundDataDEType](#)  
[CountrySpecificShareClassDataDEType](#)  
[PRIIPS\\_DE\\_EPT\\_PiaType](#)  
[PRIIPS\\_V2\\_Country\\_Specific\\_DE](#)

schema location: [L:\13\\_Statistik\FundsXML\Schemata\FundsXML\\_4.2.5\FundsXML\\_4.2.5\FundsXML\\_4.2.5\FundsXML4\\_CountrySpecificData\\_DK.xsd](L:\13_Statistik\FundsXML\Schemata\FundsXML_4.2.5\FundsXML_4.2.5\FundsXML_4.2.5\FundsXML4_CountrySpecificData_DK.xsd)  
attribute form default: **unqualified**  
element form default: **qualified**

Complex types  
[CountrySpecificAssetMasterDataDKType](#)  
[CountrySpecificControlDataDKType](#)  
[CountrySpecificDataDKType](#)  
[CountrySpecificEMTDKType](#)  
[CountrySpecificFundDataDKType](#)  
[CountrySpecificShareClassDataDKType](#)

schema location: [L:\13\\_Statistik\FundsXML\Schemata\FundsXML\\_4.2.5\FundsXML\\_4.2.5\FundsXML\\_4.2.5\FundsXML4\\_CountrySpecificData\\_FR.xsd](L:\13_Statistik\FundsXML\Schemata\FundsXML_4.2.5\FundsXML_4.2.5\FundsXML_4.2.5\FundsXML4_CountrySpecificData_FR.xsd)  
attribute form default: **unqualified**  
element form default: **qualified**

Complex types  
[CountrySpecificAssetMasterDataFRType](#)  
[CountrySpecificControlDataFRType](#)  
[CountrySpecificDataFRType](#)  
[CountrySpecificEMTFRType](#)  
[CountrySpecificFundDataFRType](#)  
[CountrySpecificShareClassDataFRType](#)

schema location: [L:\13\\_Statistik\FundsXML\Schemata\FundsXML\\_4.2.5\FundsXML\\_4.2.5\FundsXML\\_4.2.5\FundsXML4\\_CountrySpecificData\\_LU.xsd](L:\13_Statistik\FundsXML\Schemata\FundsXML_4.2.5\FundsXML_4.2.5\FundsXML_4.2.5\FundsXML4_CountrySpecificData_LU.xsd)



attribute form            **unqualified**  
default:  
element form            **qualified**  
default:

Complex types

[CountrySpecificAssetMasterDataLUType](#)  
[CountrySpecificControlDataLUType](#)  
[CountrySpecificDataLUType](#)  
[CountrySpecificEMTLUType](#)  
[CountrySpecificFundDataLUType](#)  
[CountrySpecificShareClassDataLUType](#)

schema location:        [L:\13 Statistik\FundsXML\Schemata\FundsXML 4.2.5\FundsXML 4.2.5\FundsXML 4.2.5\FundsXML4\\_CountrySpecificData\\_NL.xsd](#)  
attribute form            **unqualified**  
default:  
element form            **qualified**  
default:

Complex types

[CountrySpecificAssetMasterDataNLType](#)  
[CountrySpecificControlDataNLType](#)  
[CountrySpecificDataNLType](#)  
[CountrySpecificEMTNLType](#)  
[CountrySpecificFundDataNLType](#)  
[CountrySpecificShareClassDataNLType](#)

schema location:        [L:\13 Statistik\FundsXML\Schemata\FundsXML 4.2.5\FundsXML 4.2.5\FundsXML 4.2.5\FundsXML4\\_PortfolioData.xsd](#)  
attribute form            **unqualified**  
default:  
element form            **qualified**  
default:

Complex types

[BreakDownsType](#)  
[ExposureType](#)  
[OtherTotalValueType](#)  
[PortfolioType](#)  
[PositionsDecomposedType](#)  
[PositionsType](#)  
[PositionType](#)  
[PositionUnderlyingType](#)  
[PositionValuationType](#)  
[RiskCodeType](#)

schema location:        [L:\13 Statistik\FundsXML\Schemata\FundsXML 4.2.5\FundsXML 4.2.5\FundsXML 4.2.5\FundsXML4\\_TransactionData.xsd](#)  
attribute form            **unqualified**  
default:  
element form            **qualified**  
default:

- Complex types
- [EarningsType](#)
- [EarningType](#)
- [TransactionsType](#)
- [TransactionType](#)

element **FundsXML4**

|            |  |
|------------|--|
| diagram    | <p><b>FundsXML4</b><br/>Root element of FundsXML 4.2.5</p> <ul style="list-style-type: none"> <li><b>ControlData</b><br/>Meta data of xml document (like unique id, date, data supplier, language, ...)</li> <li><b>Funds</b><br/>List of funds, umbrellas, sicavs, portfolios ...</li> <li><b>AssetMgmtCompanyDynData</b><br/>Dynamic data of asset management companies</li> <li><b>AssetMasterData</b><br/>Master data of securities, derivatives and all other portfolio assets</li> <li><b>Documents</b><br/>List of documents related to Fund / Subfunds / Share Classes (with link and/or content along with document attributes like type, format, language, ...)</li> <li><b>RegulatoryReportings</b><br/>Direct and indirect regulatory reporting</li> <li><b>CountrySpecificData</b><br/>Country specific data on top level (as defined in 'FundsXML4_CountrySpecificData_xx.xsd')</li> </ul> |
| properties | content complex  |
| children   | <a href="#">ControlData</a> <a href="#">Funds</a> <a href="#">AssetMgmtCompanyDynData</a> <a href="#">AssetMasterData</a> <a href="#">Documents</a> <a href="#">RegulatoryReportings</a> <a href="#">CountrySpecificData</a>   |
| annotation | documentation<br>Root element of FundsXML 4.2.5  |

element **FundsXML4/ControlData**

|                   |   |
|-------------------|---|
| <p>diagram</p>    | <p><b>ControlData</b><br/>Meta data of xml document (like unique id, date, data supplier, language, ...)</p> <p><b>ControlDataType</b></p> <ul style="list-style-type: none"> <li><b>UniqueDocumentID</b><br/>Document identifier (unique per data supplier)</li> <li><b>DocumentGenerated</b><br/>Timestamp of document generation</li> <li><b>Version</b><br/>FundsXML Schema Version (4.0.0, 4.0.1, 4.1.0, ...)</li> <li><b>ContentDate</b><br/>Main date for content, if not specified different within section</li> <li><b>DataSupplier</b><br/>Definition of data source (investment company, vendor, ...)</li> <li><b>DataOperation</b><br/>INITIAL, AMEND, DELETE</li> <li><b>RelatedDocumentIDs</b><br/>Identifiers of related documents for non-initial data deliveries</li> <li><b>Language</b><br/>ISO code of language with two characters</li> <li><b>ModuleUsage</b><br/>List of used schema modules</li> <li><b>CountrySpecificData</b><br/>Country specific document data</li> </ul> |
| <p>type</p>       | <p><a href="#">ControlDataType</a></p>  |
| <p>properties</p> | <p>isRef 0<br/>content complex</p>  |
| <p>children</p>   | <p><a href="#">UniqueDocumentID</a> <a href="#">DocumentGenerated</a> <a href="#">Version</a> <a href="#">ContentDate</a> <a href="#">DataSupplier</a> <a href="#">DataOperation</a> <a href="#">RelatedDocumentIDs</a> <a href="#">Language</a> <a href="#">ModuleUsage</a> <a href="#">CountrySpecificData</a></p>  |
| <p>annotation</p> | <p>documentation<br/>Meta data of xml document (like unique id, date, data supplier, language, ...)</p>   |

element **FundsXML4/Funds**

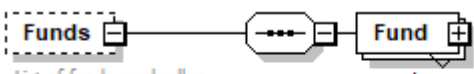
|                   |   |
|-------------------|---|
| <p>diagram</p>    |  <p><b>Funds</b><br/>List of funds, umbrellas, sicavs, portfolios ...</p> <p><b>Fund</b><br/>1..∞<br/>All single fund, umbrella, sicav, portfolio related data</p> |
| <p>properties</p> | <p>isRef 0<br/>minOcc 0<br/>maxOcc 1<br/>content complex</p>  |
| <p>children</p>   | <p><a href="#">Fund</a></p>   |
| <p>annotation</p> | <p>documentation<br/>List of funds, umbrellas, sicavs, portfolios ...</p>   |

element FundsXML4/Funds/Fund

diagram

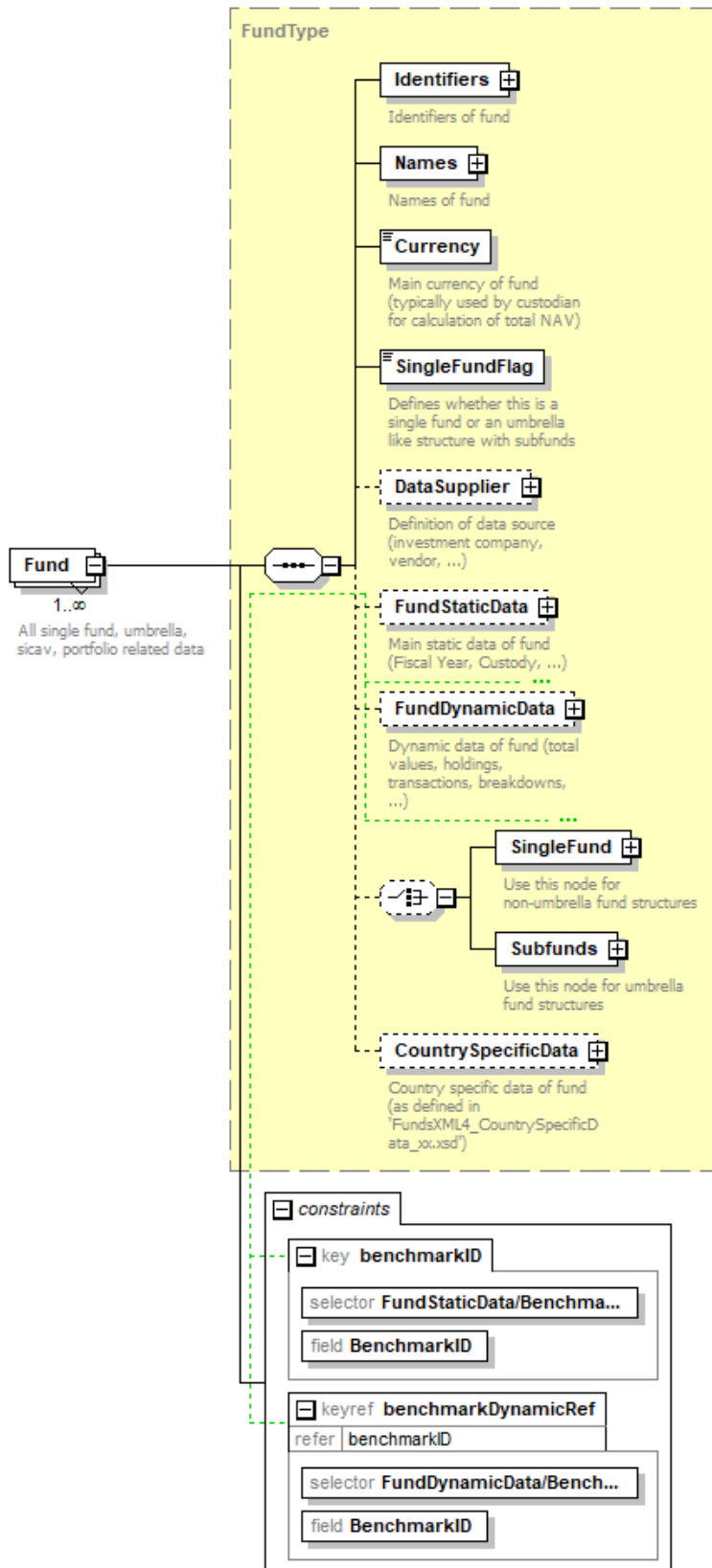

|                      |   |                     |             |                                      |             |
|----------------------|---|---------------------|-------------|--------------------------------------|-------------|
| type                 | <a href="#">FundType</a>  |                     |             |                                      |             |
| properties           | isRef   | 0                   |             |                                      |             |
|                      | minOcc  | 1                   |             |                                      |             |
|                      | maxOcc  | unbounded           |             |                                      |             |
|                      | content   | complex             |             |                                      |             |
| children             | <a href="#">Identifiers</a> <a href="#">Names</a> <a href="#">Currency</a> <a href="#">SingleFundFlag</a> <a href="#">DataSupplier</a> <a href="#">FundStaticData</a> <a href="#">FundDynamicData</a> <a href="#">SingleFund</a> <a href="#">Subfunds</a> <a href="#">CountrySpecificData</a> |                     |             |                                      |             |
| identity constraints | key   | Name                | Refer       | Selector                             | Field(s)    |
|                      | keyref  | benchmarkID         | benchmarkID | FundStaticData/Benchmarks/Benchmark  | BenchmarkID |
|                      | keyref  | benchmarkDynamicRef | benchmarkID | FundDynamicData/Benchmarks/Benchmark | BenchmarkID |
| annotation           | documentation<br>All single fund, umbrella, sicav, portfolio related data   |                     |             |                                      |             |

#### element FundsXML4/AssetMgmtCompanyDynData

|            |   |         |  |  |  |
|------------|---|---------|--|--|--|
| diagram    |   |         |  |  |  |
| type       | <a href="#">AssetMgmtCompanyDynDataType</a>                 |         |  |  |  |
| properties | isRef   | 0       |  |  |  |
|            | minOcc  | 0       |  |  |  |
|            | maxOcc  | 1       |  |  |  |
|            | content   | complex |  |  |  |
| children   | <a href="#">AssetMgmtCompanyDynDataSet</a>                  |         |  |  |  |
| annotation | documentation<br>Dynamic data of asset management companies |         |  |  |  |

#### element FundsXML4/AssetMasterData

|            |  |         |  |  |  |
|------------|--|---------|--|--|--|
| diagram    |  |         |  |  |  |
| type       | <a href="#">AssetMasterDataType</a>  |         |  |  |  |
| properties | isRef  | 0       |  |  |  |
|            | minOcc   | 0       |  |  |  |
|            | maxOcc   | 1       |  |  |  |
|            | content  | complex |  |  |  |
| children   | <a href="#">Asset</a>  |         |  |  |  |
| annotation | documentation<br>Master data of securities, derivatives and all other portfolio assets |         |  |  |  |

element **FundsXML4/Documents**

|            |   |
|------------|---|
| diagram    | <p>The diagram shows a dashed box labeled <b>DocumentsType</b>. Inside, there is a list icon (a rectangle with three dots) labeled <b>Documents</b> with a description: "List of documents related to Fund / Subfunds / Share Classes (with link and/or content along with document attributes like type, format, language, ...)". To the right of this list is a <b>Document</b> element icon (a rectangle with a plus sign) with a multiplicity of <b>1..∞</b>.</p> |
| type       | <a href="#">DocumentsType</a>   |
| properties | isRef 0<br>minOcc 0<br>maxOcc 1<br>content complex  |
| children   | <a href="#">Document</a>  |
| annotation | documentation<br>List of documents related to Fund / Subfunds / Share Classes (with link and/or content along with document attributes like type, format, language, ...)  |

element **FundsXML4/RegulatoryReportings**

|            |   |
|------------|---|
| diagram    | <p>The diagram shows a dashed box labeled <b>RegulatoryReportingsType</b>. Inside, there is a list icon (a rectangle with three dots) labeled <b>RegulatoryReportings</b> with a description: "Direct and indirect regulatory reporting". To the right of this list are two sub-elements: <b>DirectReporting</b> (with a plus sign icon) described as "Direct reporting according to European regulatory reporting frameworks", and <b>IndirectReporting</b> (with a plus sign icon) described as "Reporting data for investors".</p> |
| type       | <a href="#">RegulatoryReportingsType</a>  |
| properties | isRef 0<br>minOcc 0<br>maxOcc 1<br>content complex  |
| children   | <a href="#">DirectReporting</a> <a href="#">IndirectReporting</a>   |
| annotation | documentation<br>Direct and indirect regulatory reporting   |

element **FundsXML4/CountrySpecificData**

|                   |  |
|-------------------|--|
| <p>diagram</p>    | <p>The diagram illustrates the structure of the <b>CountrySpecificData</b> element. It is a complex type containing a <b>CountrySpecificDataType</b>. This type is composed of six child elements, each representing a country's top-level data: <b>AT</b> (Austria), <b>DE</b> (Germany), <b>DK</b> (Denmark), <b>FR</b> (France), <b>LU</b> (Luxembourg), and <b>NL</b> (Netherlands). Each country element is shown as a dashed box with a plus sign icon, indicating it is a complex type. The <b>CountrySpecificData</b> element is shown as a dashed box with a plus sign icon and a description: "Country specific data on top level (as defined in 'FundsXML4_CountrySpecificData_xx.xsd')".</p> |
| <p>type</p>       | <p><a href="#">CountrySpecificDataType</a></p>   |
| <p>properties</p> | <p>isRef 0<br/>minOcc 0<br/>maxOcc 1<br/>content complex</p>   |
| <p>children</p>   | <p><a href="#">AT</a> <a href="#">DE</a> <a href="#">DK</a> <a href="#">FR</a> <a href="#">LU</a> <a href="#">NL</a></p>   |
| <p>annotation</p> | <p>documentation<br/>Country specific data on top level (as defined in 'FundsXML4_CountrySpecificData_xx.xsd')</p>   |



### complexType ControlDataType

|                 |  |
|-----------------|--|
| <p>diagram</p>  |  |
| <p>children</p> | <p><a href="#">UniqueDocumentID</a> <a href="#">DocumentGenerated</a> <a href="#">Version</a> <a href="#">ContentDate</a> <a href="#">DataSupplier</a> <a href="#">DataOperation</a> <a href="#">RelatedDocumentIDs</a> <a href="#">Language</a> <a href="#">ModuleUsage</a> <a href="#">CountrySpecificData</a></p> |
| <p>used by</p>  | <p>element <a href="#">FundsXML4/ControlData</a></p>   |

### element ControlDataType/UniqueDocumentID

|                   |                                    |
|-------------------|------------------------------------|
| <p>diagram</p>    |                                    |
| <p>type</p>       | <p><a href="#">Text128Type</a></p> |
| <p>properties</p> | <p>isRef 0<br/>content simple</p>  |

|            |   |
|------------|---|
| facets     | Kind Value annotation<br>maxLength 128                          |
| annotation | documentation<br>Document identifier (unique per data supplier) |

### element **ControlDataType/DocumentGenerated**

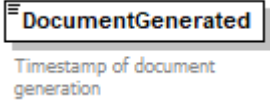
|            |   |
|------------|---|
| diagram    |  |
| type       | <b>xs:dateTime</b>  |
| properties | isRef 0<br>content simple   |
| annotation | documentation<br>Timestamp of document generation                                 |

### element **ControlDataType/Version**

|            |   |
|------------|---|
| diagram    |  |
| type       | restriction of <b>xs:string</b>   |
| properties | isRef 0<br>minOcc 0<br>maxOcc 1<br>content simple                                 |
| annotation | documentation<br>FundsXML Schema Version (4.0.0, 4.0.1, 4.1.0, ...)               |

### element **ControlDataType/ContentDate**

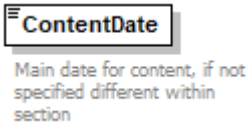
|            |   |
|------------|---|
| diagram    |  |
| type       | <b>xs:date</b>  |
| properties | isRef 0<br>content simple   |
| annotation | documentation<br>Main date for content, if not specified different within section   |

### element ControlDataType/DataSupplier

|            |   |
|------------|---|
| diagram    | <p>The diagram shows a <b>DataSupplier</b> element (Definition of data source) connected to a complex content container. This container is linked to several child elements: <b>SystemCountry</b> (Country of authority), <b>Short</b> (Code of supplier), <b>Name</b> (Name of data supplier), <b>Type</b> (Type of data supplier), and <b>Contact</b> (Contact details). The <b>Contact</b> element is shown with a dashed border and a plus sign, indicating it is optional.</p> |
| type       | <a href="#">DataSupplierType</a>  |
| properties | isRef 0<br>content complex  |
| children   | <a href="#">SystemCountry</a> <a href="#">Short</a> <a href="#">Name</a> <a href="#">Type</a> <a href="#">Contact</a>   |
| annotation | documentation<br>Definition of data source (investment company, vendor, ...)  |

### element ControlDataType/DataOperation

|            |   |
|------------|---|
| diagram    | <p>The diagram shows the <b>DataOperation</b> element, which is a restriction of <code>xs:string</code>. It is represented as a dashed box containing the text <code>INITIAL, AMEND, DELETE</code>.</p> |
| type       | restriction of <code>xs:string</code>   |
| properties | isRef 0<br>minOcc 0<br>maxOcc 1<br>content simple   |
| facets     | Kind Value annotation<br>minLength 5<br>maxLength 7   |
| annotation | documentation<br>INITIAL, AMEND, DELETE   |

### element ControlDataType/RelatedDocumentIDs

|         |  |
|---------|--|
| diagram | <p>The diagram shows the <b>RelatedDocumentIDs</b> element (Identifiers of related documents for non-initial data deliveries) connected to a <b>RelatedDocumentID</b> element. The <b>RelatedDocumentID</b> element has a cardinality of 1..∞.</p> |
|---------|--|

|            |   |
|------------|---|
| properties | isRef 0<br>minOcc 0<br>maxOcc 1<br>content complex                                |
| children   | <a href="#">RelatedDocumentID</a>   |
| annotation | documentation<br>Identifiers of related documents for non-initial data deliveries |

element **ControlDataType/RelatedDocumentIDs/RelatedDocumentID**

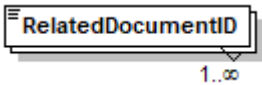
|            |   |
|------------|---|
| diagram    |  |
| type       | <a href="#">Text128Type</a>   |
| properties | isRef 0<br>minOcc 1<br>maxOcc unbounded<br>content simple                         |
| facets     | Kind Value annotation<br>maxLength 128  |

element **ControlDataType/Language**

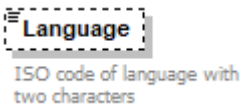
|            |  |
|------------|--|
| diagram    |  |
| type       | <b>xs:language</b>   |
| properties | isRef 0<br>minOcc 0<br>maxOcc 1<br>content simple                                  |
| annotation | documentation<br>ISO code of language with two characters                          |

element **ControlDataType/ModuleUsage**

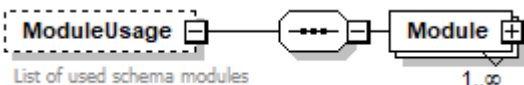
|            |   |
|------------|---|
| diagram    |  |
| properties | isRef 0<br>minOcc 0<br>maxOcc 1<br>content complex                                  |
| children   | <a href="#">Module</a>  |
| annotation | documentation<br>List of used schema modules  |

element **ControlDataType/ModuleUsage/Module**

|            |  |
|------------|--|
| diagram    |  |
| properties | isRef 0<br>minOcc 1<br>maxOcc unbounded<br>content complex |
| children   | <a href="#">Name</a> <a href="#">SubModule</a>             |

element **ControlDataType/ModuleUsage/Module/Name**

|            |   |
|------------|---|
| diagram    |   |
| type       | restriction of <b>xs:string</b>                       |
| properties | isRef 0<br>content simple                             |
| annotation | documentation<br>Module name as listed in enumeration |

element **ControlDataType/ModuleUsage/Module/SubModule**

|            |   |
|------------|---|
| diagram    |   |
| type       | <b>xs:string</b>  |
| properties | isRef 0<br>minOcc 0<br>maxOcc unbounded<br>content simple |

element **ControlDataType/CountrySpecificData**

|         |  |
|---------|--|
| diagram |  |
|---------|--|

|            |   |
|------------|---|
| properties | isRef 0<br>minOcc 0<br>maxOcc 1<br>content complex  |
| children   | <a href="#">AT</a> <a href="#">DE</a> <a href="#">DK</a> <a href="#">FR</a> <a href="#">LU</a> <a href="#">NL</a> |
| annotation | documentation<br>Country specific document data   |

element **ControlDataType/CountrySpecificData/AT**

|            |   |
|------------|---|
| diagram    |   |
| type       | <a href="#">CountrySpecificControlDataATType</a>                          |
| properties | isRef 0<br>minOcc 0<br>maxOcc 1<br>content complex                        |
| children   | <a href="#">FundDataPortalContent</a> <a href="#">FundDataPortalInfos</a> |

element **ControlDataType/CountrySpecificData/DE**

|            |  |
|------------|--|
| diagram    |  |
| type       | <a href="#">CountrySpecificControlDataDEType</a>   |
| properties | isRef 0<br>minOcc 0<br>maxOcc 1<br>content complex |

element **ControlDataType/CountrySpecificData/DK**

|            |   |       |   |        |   |        |   |         |         |
|------------|---|-------|---|--------|---|--------|---|---------|---------|
| diagram    |   |       |   |        |   |        |   |         |         |
| type       | <a href="#">CountrySpecificControlDataDKType</a>  |       |   |        |   |        |   |         |         |
| properties | <table border="0"> <tr><td>isRef</td><td>0</td></tr> <tr><td>minOcc</td><td>0</td></tr> <tr><td>maxOcc</td><td>1</td></tr> <tr><td>content</td><td>complex</td></tr> </table> | isRef | 0 | minOcc | 0 | maxOcc | 1 | content | complex |
| isRef      | 0   |       |   |        |   |        |   |         |         |
| minOcc     | 0   |       |   |        |   |        |   |         |         |
| maxOcc     | 1   |       |   |        |   |        |   |         |         |
| content    | complex   |       |   |        |   |        |   |         |         |

element **ControlDataType/CountrySpecificData/FR**

|            |   |       |   |        |   |        |   |         |         |
|------------|---|-------|---|--------|---|--------|---|---------|---------|
| diagram    |   |       |   |        |   |        |   |         |         |
| type       | <a href="#">CountrySpecificControlDataFRType</a>  |       |   |        |   |        |   |         |         |
| properties | <table border="0"> <tr><td>isRef</td><td>0</td></tr> <tr><td>minOcc</td><td>0</td></tr> <tr><td>maxOcc</td><td>1</td></tr> <tr><td>content</td><td>complex</td></tr> </table> | isRef | 0 | minOcc | 0 | maxOcc | 1 | content | complex |
| isRef      | 0   |       |   |        |   |        |   |         |         |
| minOcc     | 0   |       |   |        |   |        |   |         |         |
| maxOcc     | 1   |       |   |        |   |        |   |         |         |
| content    | complex   |       |   |        |   |        |   |         |         |

element **ControlDataType/CountrySpecificData/LU**

|            |   |       |   |        |   |        |   |
|------------|---|-------|---|--------|---|--------|---|
| diagram    |   |       |   |        |   |        |   |
| type       | <a href="#">CountrySpecificControlDataLUType</a>  |       |   |        |   |        |   |
| properties | <table border="0"> <tr><td>isRef</td><td>0</td></tr> <tr><td>minOcc</td><td>0</td></tr> <tr><td>maxOcc</td><td>1</td></tr> </table> | isRef | 0 | minOcc | 0 | maxOcc | 1 |
| isRef      | 0   |       |   |        |   |        |   |
| minOcc     | 0   |       |   |        |   |        |   |
| maxOcc     | 1   |       |   |        |   |        |   |

|  |         |         |
|--|---------|---------|
|  | content | complex |
|--|---------|---------|

element **ControlDataType/CountrySpecificData/NL**

|            |   |       |   |        |   |        |   |         |         |
|------------|---|-------|---|--------|---|--------|---|---------|---------|
| diagram    |   |       |   |        |   |        |   |         |         |
| type       | <a href="#">CountrySpecificControlDataNLType</a>  |       |   |        |   |        |   |         |         |
| properties | <table border="0"> <tr> <td>isRef</td> <td>0</td> </tr> <tr> <td>minOcc</td> <td>0</td> </tr> <tr> <td>maxOcc</td> <td>1</td> </tr> <tr> <td>content</td> <td>complex</td> </tr> </table> | isRef | 0 | minOcc | 0 | maxOcc | 1 | content | complex |
| isRef      | 0   |       |   |        |   |        |   |         |         |
| minOcc     | 0   |       |   |        |   |        |   |         |         |
| maxOcc     | 1   |       |   |        |   |        |   |         |         |
| content    | complex   |       |   |        |   |        |   |         |         |



complexType DirectReportingType

diagram

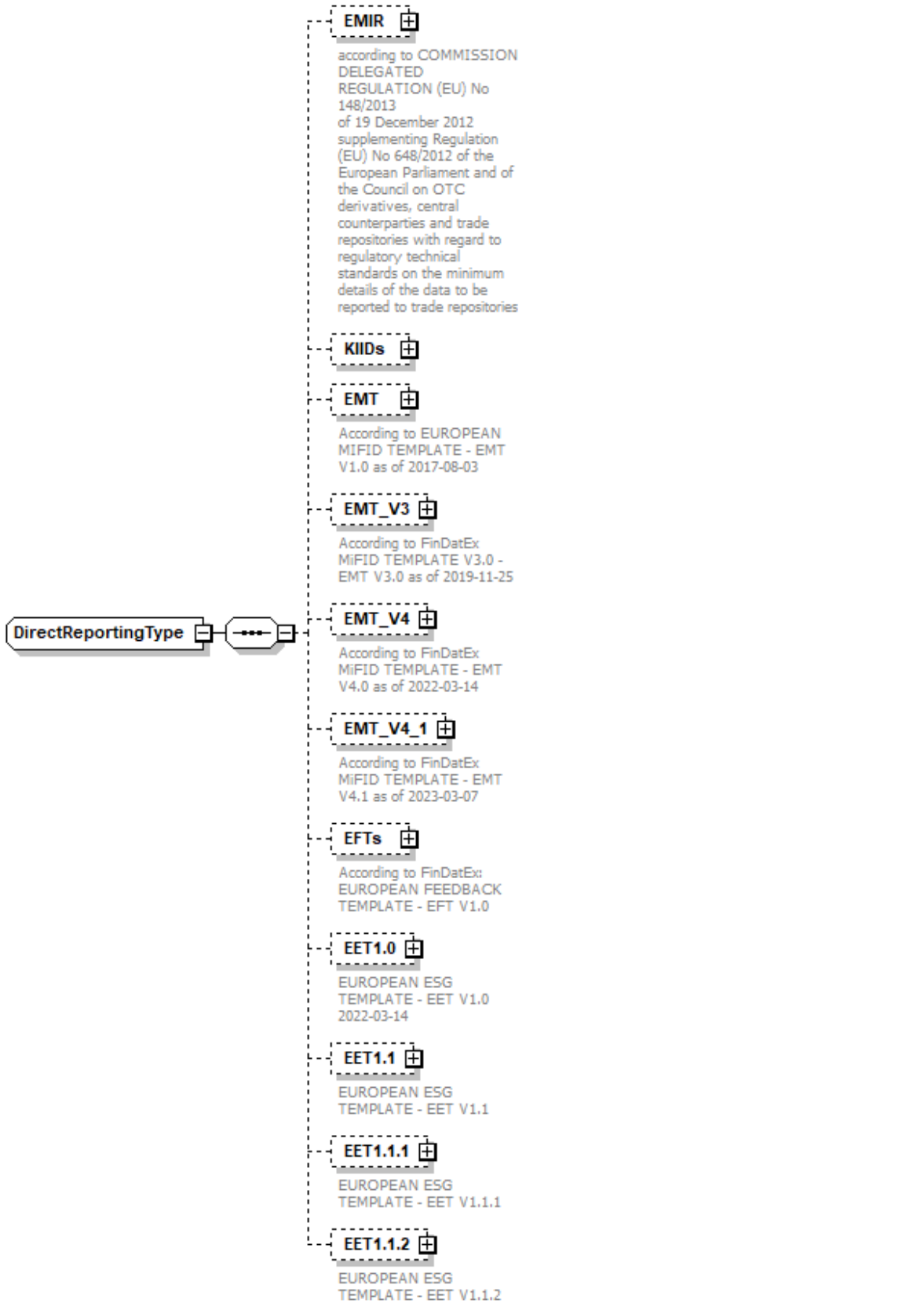

|          |  |
|----------|--|
| children | <a href="#">EMIR KIIDs</a> <a href="#">EMT</a> <a href="#">EMT_V3</a> <a href="#">EMT_V4</a> <a href="#">EMT_V4_1</a> <a href="#">EFTs</a> <a href="#">EET1.0</a> <a href="#">EET1.1</a> <a href="#">EET1.1.1</a> <a href="#">EET1.1.2</a> |
| used by  | element <a href="#">RegulatoryReportingsType/DirectReporting</a>   |

element **DirectReportingType/EMIR**

|            |  |
|------------|--|
| diagram    | <p>The diagram shows a dashed box labeled 'EMIR' connected to a larger dashed box labeled 'EMIRType'. Inside 'EMIRType', there is a sequence of elements: a dashed box with four dots, followed by a box labeled 'EMIR_Report' with a cardinality of '1..∞' below it.</p> <p>according to COMMISSION DELEGATED REGULATION (EU) No 148/2013 of 19 December 2012 supplementing Regulation (EU) No 648/2012 of the European Parliament and of the Council on OTC derivatives, central counterparties and trade repositories with regard to regulatory technical standards on the minimum details of the data to be reported to trade repositories</p> |
| type       | <a href="#">EMIRType</a>   |
| properties | isRef 0<br>minOcc 0<br>maxOcc 1<br>content complex   |
| children   | <a href="#">EMIR_Report</a>  |
| annotation | documentation<br>according to COMMISSION DELEGATED REGULATION (EU) No 148/2013 of 19 December 2012 supplementing Regulation (EU) No 648/2012 of the European Parliament and of the Council on OTC derivatives, central counterparties and trade repositories with regard to regulatory technical standards on the minimum details of the data to be reported to trade repositories   |

element **DirectReportingType/KIIDs**

|            |   |
|------------|---|
| diagram    | <p>The diagram shows a dashed box labeled 'KIIDs' connected to a larger dashed box labeled 'KIIDsType'. Inside 'KIIDsType', there is a sequence of elements: a dashed box with four dots, followed by a box labeled 'KIID' with a cardinality of '1..∞' below it.</p> |
| type       | <a href="#">KIIDsType</a>   |
| properties | isRef 0<br>minOcc 0<br>maxOcc 1<br>content complex  |
| children   | <a href="#">KIID</a>  |

element **DirectReportingType/EMT**

|            |  |
|------------|--|
| diagram    |  |
| type       | <a href="#">EMTType</a>  |
| properties | <ul style="list-style-type: none"> <li>isRef 0</li> <li>minOcc 0</li> <li>maxOcc 1</li> <li>content complex</li> </ul> |
| children   | <a href="#">FinancialInstrument</a>  |
| annotation | documentation<br>According to EUROPEAN MIFID TEMPLATE - EMT V1.0 as of 2017-08-03                                      |

element **DirectReportingType/EMT\_V3**

|            |  |
|------------|--|
| diagram    |  |
| type       | <a href="#">EMTType_V3</a>   |
| properties | <ul style="list-style-type: none"> <li>isRef 0</li> <li>minOcc 0</li> <li>maxOcc 1</li> <li>content complex</li> </ul> |
| children   | <a href="#">FinancialInstrument</a>  |
| annotation | documentation<br>According to FinDatEx MiFID TEMPLATE V3.0 - EMT V3.0 as of 2019-11-25                                 |

element **DirectReportingType/EMT\_V4**

|            |  |
|------------|--|
| diagram    |  |
| type       | <a href="#">EMTType_V4</a>   |
| properties | <ul style="list-style-type: none"> <li>isRef 0</li> <li>minOcc 0</li> <li>maxOcc 1</li> <li>content complex</li> </ul> |
| children   | <a href="#">FinancialInstrument</a>  |
| annotation | documentation<br>According to FinDatEx MiFID TEMPLATE - EMT V4.0 as of 2022-03-14                                      |

element **DirectReportingType/EMT\_V4\_1**

|            |  |
|------------|--|
| diagram    | <p>EMT_V4_1</p> <p>According to FinDatEx MiFID TEMPLATE - EMT V4.1 as of 2023-03-07</p> <p>EMTType_V41</p> <p>FinancialInstrument 1..∞</p> <p>EMT Version 4.1 Report</p> |
| type       | <a href="#">EMTType_V41</a>  |
| properties | isRef 0<br>minOcc 0<br>maxOcc 1<br>content complex   |
| children   | <a href="#">FinancialInstrument</a>  |
| annotation | documentation<br>According to FinDatEx MiFID TEMPLATE - EMT V4.1 as of 2023-03-07  |

element **DirectReportingType/EFTs**

|            |  |
|------------|--|
| diagram    | <p>EFTs</p> <p>According to FinDatEx: EUROPEAN FEEDBACK TEMPLATE - EFT V1.0</p> <p>EFTType</p> <p>EFT 1..∞</p> |
| type       | <a href="#">EFTType</a>  |
| properties | isRef 0<br>minOcc 0<br>maxOcc 1<br>content complex   |
| children   | <a href="#">EFT</a>  |
| annotation | documentation<br>According to FinDatEx: EUROPEAN FEEDBACK TEMPLATE - EFT V1.0                                  |

element **DirectReportingType/EET1.0**

|            |  |
|------------|--|
| diagram    | <p>EET1.0</p> <p>EUROPEAN ESG TEMPLATE - EET V1.0 2022-03-14</p> <p>EETsType</p> <p>EET 1..∞</p> |
| type       | <a href="#">EETsType</a>   |
| properties | isRef 0<br>minOcc 0<br>maxOcc 1<br>content complex   |
| children   | <a href="#">EET</a>  |

|            |  |
|------------|--|
| annotation | documentation<br>EUROPEAN ESG TEMPLATE - EET V1.0 2022-03-14 |
|------------|--|

element **DirectReportingType/EET1.1**

|            |  |
|------------|--|
| diagram    |  |
| type       | <a href="#">EETsType1.1</a>                        |
| properties | isRef 0<br>minOcc 0<br>maxOcc 1<br>content complex |
| children   | <a href="#">EET1.1</a>                             |
| annotation | documentation<br>EUROPEAN ESG TEMPLATE - EET V1.1  |

element **DirectReportingType/EET1.1.1**

|            |   |
|------------|---|
| diagram    |   |
| type       | <a href="#">EETsType1.1.1</a>                       |
| properties | isRef 0<br>minOcc 0<br>maxOcc 1<br>content complex  |
| children   | <a href="#">EET1.1.1</a>                            |
| annotation | documentation<br>EUROPEAN ESG TEMPLATE - EET V1.1.1 |

element **DirectReportingType/EET1.1.2**

|            |  |
|------------|--|
| diagram    |  |
| type       | <a href="#">EETsType1.1.2</a>                      |
| properties | isRef 0<br>minOcc 0<br>maxOcc 1<br>content complex |
| children   | <a href="#">EET1.1.2</a>                           |

|            |   |
|------------|---|
| annotation | documentation<br>EUROPEAN ESG TEMPLATE - EET V1.1.2 |
|------------|---|

**complexType DocumentsType**

|          |   |
|----------|---|
| diagram  |   |
| children | <a href="#">Document</a>                    |
| used by  | element <a href="#">FundsXML4/Documents</a> |

element **DocumentsType/Document**

diagram

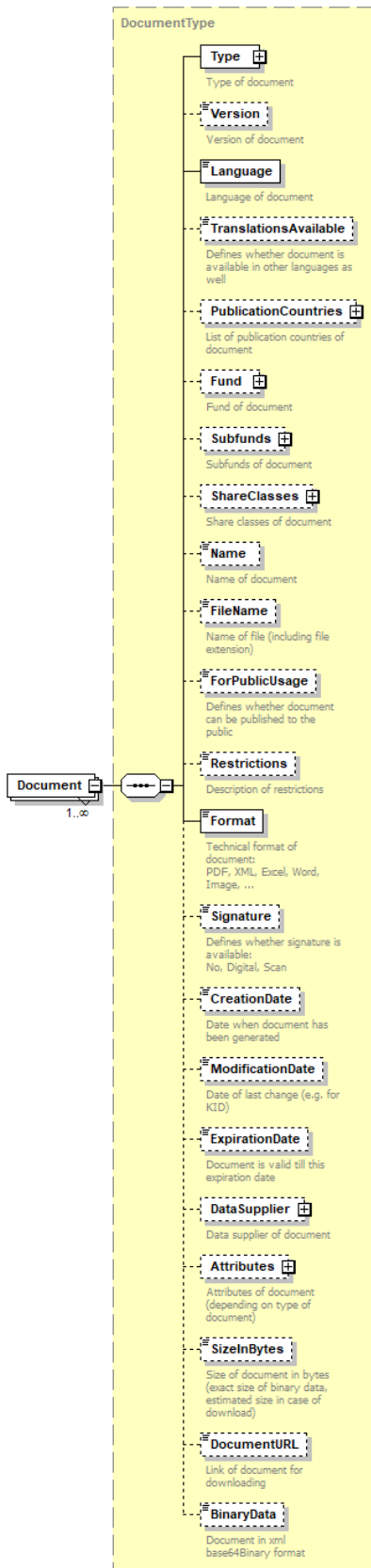



|            |  |
|------------|--|
| type       | <a href="#"><u>DocumentType</u></a>  |
| properties | isRef 0<br>minOcc 1<br>maxOcc unbounded<br>content complex   |
| children   | <a href="#"><u>Type</u></a> <a href="#"><u>Version</u></a> <a href="#"><u>Language</u></a> <a href="#"><u>TranslationsAvailable</u></a> <a href="#"><u>PublicationCountries</u></a> <a href="#"><u>Fund</u></a> <a href="#"><u>Subfunds</u></a> <a href="#"><u>ShareClasses</u></a> <a href="#"><u>Name</u></a> <a href="#"><u>FileName</u></a> <a href="#"><u>ForPublicUsage</u></a> <a href="#"><u>Restrictions</u></a> <a href="#"><u>Format</u></a> <a href="#"><u>Signature</u></a> <a href="#"><u>CreationDate</u></a> <a href="#"><u>ModificationDate</u></a> <a href="#"><u>ExpirationDate</u></a> <a href="#"><u>DataSupplier</u></a> <a href="#"><u>Attributes</u></a> <a href="#"><u>SizeInBytes</u></a> <a href="#"><u>DocumentURL</u></a> <a href="#"><u>BinaryData</u></a> |

# complexType DocumentType

diagram

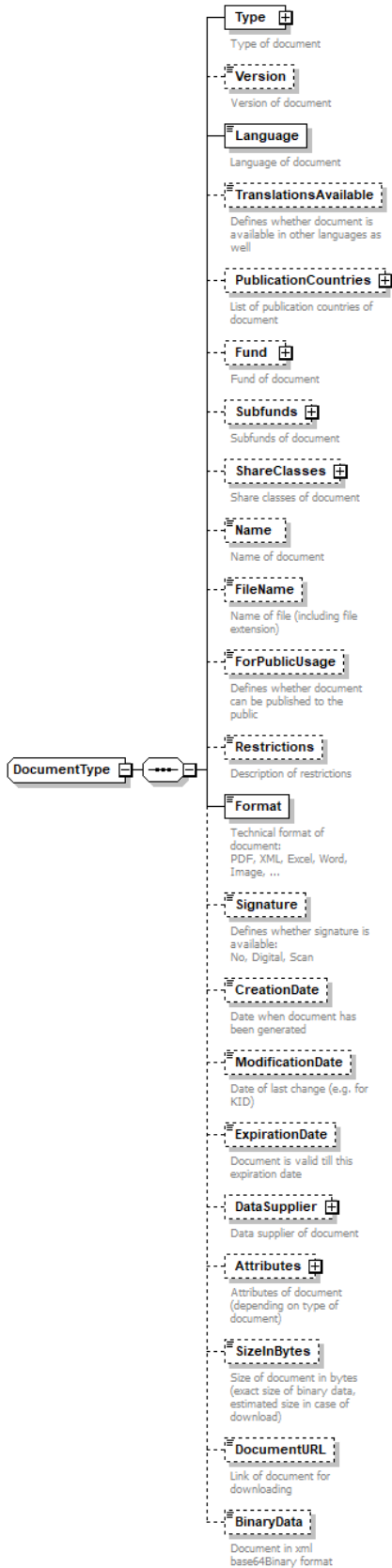

|          |  |
|----------|--|
| children | <a href="#">Type</a> <a href="#">Version</a> <a href="#">Language</a> <a href="#">TranslationsAvailable</a> <a href="#">PublicationCountries</a> <a href="#">Fund</a> <a href="#">Subfunds</a> <a href="#">ShareClasses</a> <a href="#">Name</a> <a href="#">FileName</a> <a href="#">ForPublicUsage</a> <a href="#">Restrictions</a> <a href="#">Format</a> <a href="#">Signature</a> <a href="#">CreationDate</a> <a href="#">ModificationDate</a> <a href="#">ExpirationDate</a> <a href="#">DataSupplier</a> <a href="#">Attributes</a> <a href="#">SizeInBytes</a> <a href="#">DocumentURL</a> <a href="#">BinaryData</a> |
| used by  | element <a href="#">DocumentsType/Document</a>   |

element **DocumentType/Type**

|            |   |
|------------|---|
| diagram    |   |
| properties | isRef 0<br>content complex                              |
| children   | <a href="#">ListedType</a> <a href="#">UnlistedType</a> |
| annotation | documentation<br>Type of document                       |

element **DocumentType/Type/ListedType**

| diagram    |  |            |       |            |           |   |  |           |    |  |
|------------|--|------------|-------|------------|-----------|---|--|-----------|----|--|
| type       | restriction of <b>xs:string</b>  |            |       |            |           |   |  |           |    |  |
| properties | isRef 0<br>content simple  |            |       |            |           |   |  |           |    |  |
| facets     | <table border="1"> <thead> <tr> <th>Kind</th> <th>Value</th> <th>annotation</th> </tr> </thead> <tbody> <tr> <td>minLength</td> <td>3</td> <td></td> </tr> <tr> <td>maxLength</td> <td>12</td> <td></td> </tr> </tbody> </table> | Kind       | Value | annotation | minLength | 3 |  | maxLength | 12 |  |
| Kind       | Value  | annotation |       |            |           |   |  |           |    |  |
| minLength  | 3  |            |       |            |           |   |  |           |    |  |
| maxLength  | 12   |            |       |            |           |   |  |           |    |  |
| annotation | documentation<br>Document Type with enumeration:<br>AIFMD<br>AnnualReport<br>AuditReport<br>Factsheet<br>KID<br>Prospectus<br>PRIIPS-KID   |            |       |            |           |   |  |           |    |  |

element **DocumentType/Type/UnlistedType**

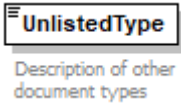
|            |   |
|------------|---|
| diagram    |  |
| type       | restriction of <a href="#">Text128Type</a>  |
| properties | isRef 0<br>content simple   |
| facets     | Kind Value annotation<br>minLength 1<br>maxLength 128                             |
| annotation | documentation<br>Description of other document types                              |

element **DocumentType/Version**

|            |   |
|------------|---|
| diagram    |  |
| type       | <a href="#">Text64Type</a>  |
| properties | isRef 0<br>minOcc 0<br>maxOcc 1<br>content simple                                 |
| facets     | Kind Value annotation<br>maxLength 64   |
| annotation | documentation<br>Version of document  |

element **DocumentType/Language**

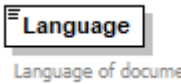
|            |   |
|------------|---|
| diagram    |  |
| type       | <b>xs:language</b>  |
| properties | isRef 0<br>content simple   |
| annotation | documentation<br>Language of document   |

element **DocumentType/TranslationsAvailable**

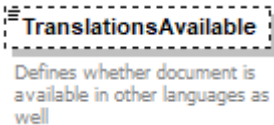
|            |   |
|------------|---|
| diagram    |  |
| type       | <b>xs:boolean</b>   |
| properties | isRef 0<br>minOcc 0<br>maxOcc 1<br>content simple                                   |
| annotation | documentation   |

|  |  |
|--|--|
|  | Defines whether document is available in other languages as well |
|--|--|

element **DocumentType/PublicationCountries**

|            |   |
|------------|---|
| diagram    | <p>The diagram shows a dashed box labeled <b>PublicationCountries</b> with the text "List of publication countries of document" below it. A solid box labeled <b>Country</b> with the text "Three letter ISO code of country" below it is connected to the dashed box by a line with a multiplicity of <math>1..∞</math>.</p> |
| properties | isRef 0<br>minOcc 0<br>maxOcc 1<br>content complex  |
| children   | <a href="#">Country</a>   |
| annotation | documentation<br>List of publication countries of document  |

element **DocumentType/PublicationCountries/Country**

|            |  |
|------------|--|
| diagram    | <p>The diagram shows a solid box labeled <b>Country</b> with the text "Three letter ISO code of country" below it and a multiplicity of <math>1..∞</math>.</p> |
| type       | <a href="#">ISOCountryCodeType</a>   |
| properties | isRef 0<br>minOcc 1<br>maxOcc unbounded<br>content simple  |
| facets     | Kind Value annotation<br>minLength 2<br>maxLength 2  |
| annotation | documentation<br>Three letter ISO code of country  |

element **DocumentType/Fund**

|            |  |
|------------|--|
| diagram    | <p>The diagram shows a dashed box labeled <b>Fund</b> with the text "Fund of document" below it. A solid box labeled <b>Identifiers</b> with a plus sign icon is connected to the dashed box by a line with a multiplicity of <math>1..∞</math>. Below the Identifiers box are two dashed boxes labeled <b>Name</b> and <b>Currency</b>, connected to the Identifiers box by dashed lines.</p> |
| properties | isRef 0<br>minOcc 0<br>maxOcc 1<br>content complex   |
| children   | <a href="#">Identifiers</a> <a href="#">Name</a> <a href="#">Currency</a>  |
| annotation | documentation<br>Fund of document  |

element **DocumentType/Fund/Identifiers**

diagram

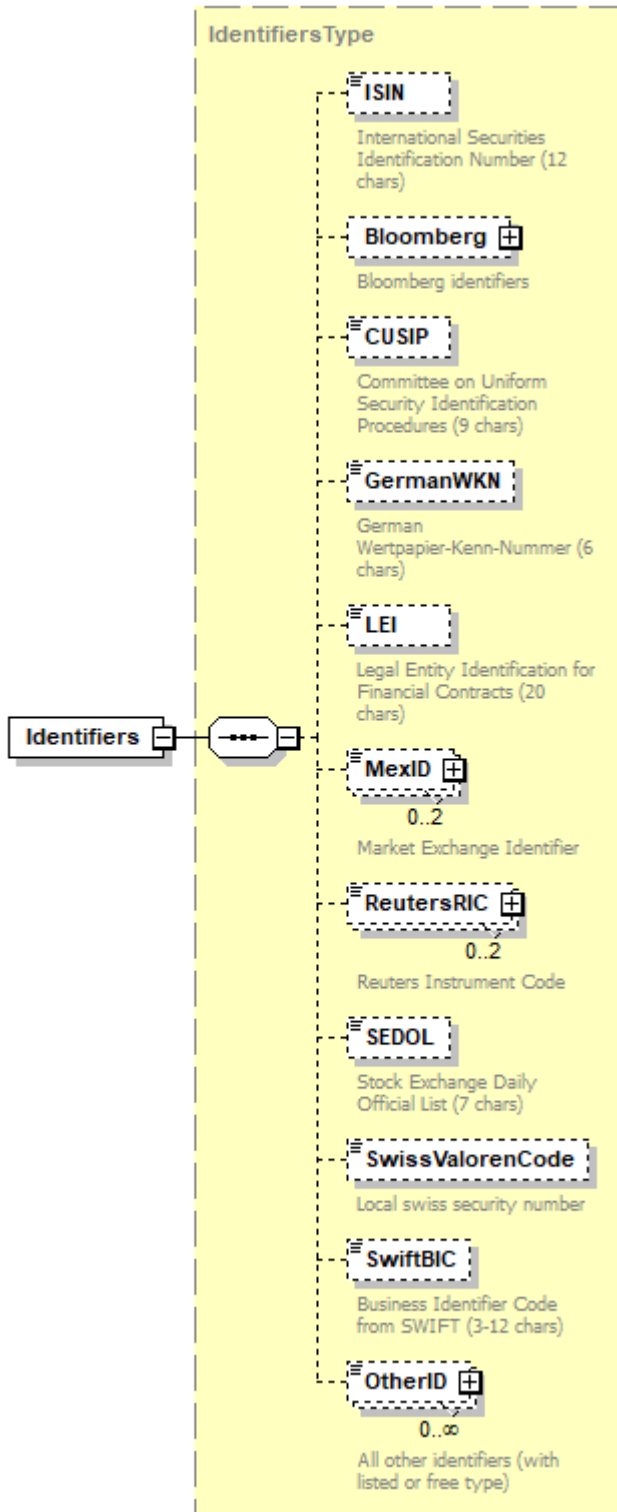

|            |   |
|------------|---|
| type       | <a href="#">IdentifiersType</a>   |
| properties | isRef 0<br>content complex  |
| children   | <a href="#">ISIN</a> <a href="#">Bloomberg</a> <a href="#">CUSIP</a> <a href="#">GermanWKN</a> <a href="#">LEI</a> <a href="#">MexID</a> <a href="#">ReutersRIC</a> <a href="#">SEDOL</a> <a href="#">SwissValorenCode</a> <a href="#">SwiftBIC</a> <a href="#">OtherID</a> |

element **DocumentType/Fund/Name**

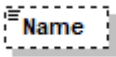
|            |   |
|------------|---|
| diagram    |  |
| type       | <a href="#">Text256Type</a>   |
| properties | isRef 0<br>minOcc 0<br>maxOcc 1<br>content simple                                 |
| facets     | Kind Value annotation<br>maxLength 256  |

element **DocumentType/Fund/Currency**

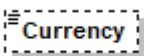
|            |   |
|------------|---|
| diagram    |  |
| type       | <a href="#">ISOCurrencyCodeType</a>   |
| properties | isRef 0<br>minOcc 0<br>maxOcc 1<br>content simple                                 |
| facets     | Kind Value annotation<br>minLength 3<br>maxLength 3<br>pattern [A-Z]{3}           |

element **DocumentType/Subfunds**

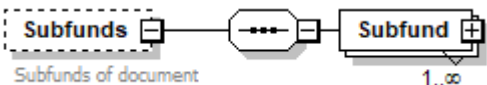
|            |   |
|------------|---|
| diagram    |  |
| properties | isRef 0<br>minOcc 0<br>maxOcc 1<br>content complex                                  |
| children   | <a href="#">Subfund</a>   |
| annotation | documentation<br>Subfunds of document   |

element **DocumentType/Subfunds/Subfund**

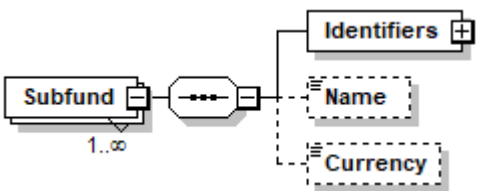
|            |   |
|------------|---|
| diagram    |  |
| properties | isRef 0<br>minOcc 1<br>maxOcc unbounded   |

|          |   |
|----------|---|
|          | content complex   |
| children | <a href="#">Identifiers</a> <a href="#">Name</a> <a href="#">Currency</a> |



element **DocumentType/Subfunds/Subfund/Identifiers**

diagram

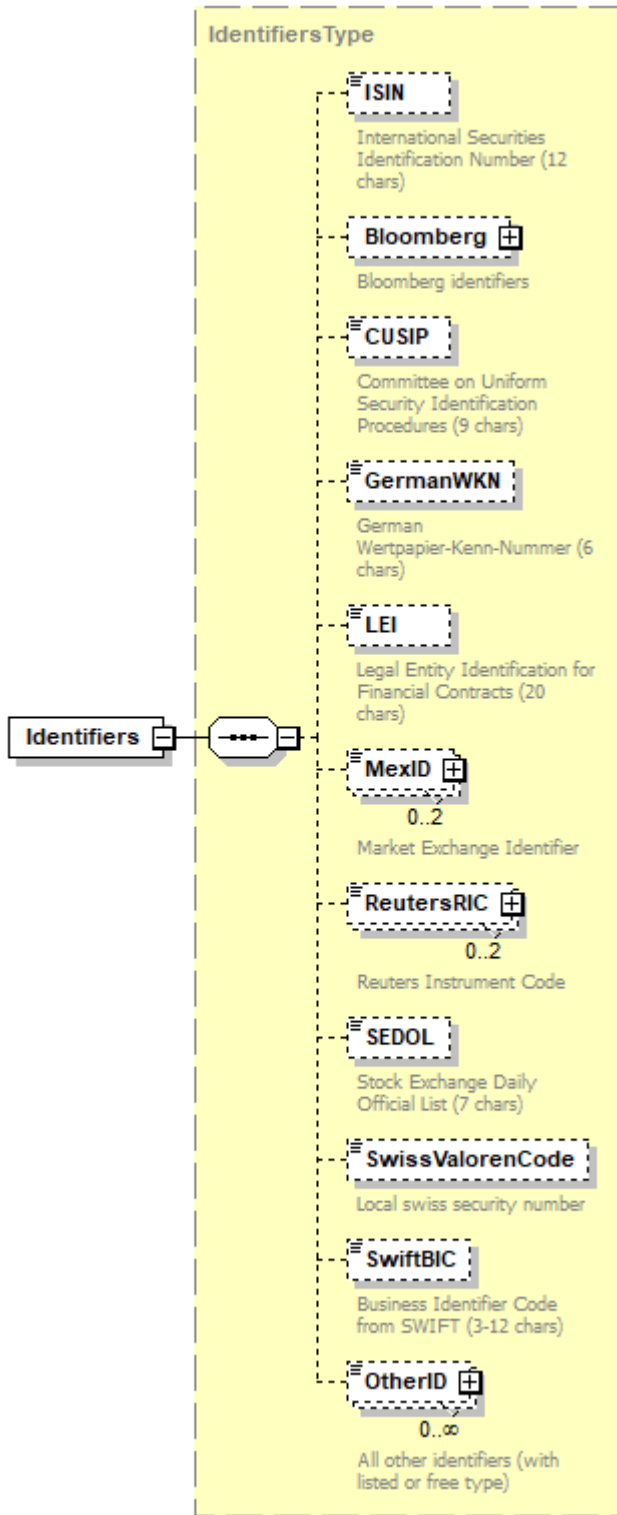

|            |   |
|------------|---|
| type       | <a href="#">IdentifiersType</a>   |
| properties | isRef 0<br>content complex  |
| children   | <a href="#">ISIN</a> <a href="#">Bloomberg</a> <a href="#">CUSIP</a> <a href="#">GermanWKN</a> <a href="#">LEI</a> <a href="#">MexID</a> <a href="#">ReutersRIC</a> <a href="#">SEDOL</a> <a href="#">SwissValorenCode</a> <a href="#">SwiftBIC</a> <a href="#">OtherID</a> |

element **DocumentType/Subfunds/Subfund/Name**

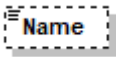
|            |   |
|------------|---|
| diagram    |  |
| type       | <a href="#">Text256Type</a>   |
| properties | isRef 0<br>minOcc 0<br>maxOcc 1<br>content simple                                 |
| facets     | Kind Value annotation<br>maxLength 256  |

element **DocumentType/Subfunds/Subfund/Currency**

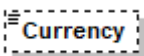
|            |   |
|------------|---|
| diagram    |  |
| type       | <a href="#">ISOCurrencyCodeType</a>   |
| properties | isRef 0<br>minOcc 0<br>maxOcc 1<br>content simple                                 |
| facets     | Kind Value annotation<br>minLength 3<br>maxLength 3<br>pattern [A-Z]{3}           |

element **DocumentType/ShareClasses**

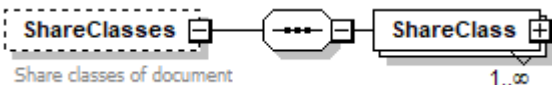
|            |   |
|------------|---|
| diagram    |  |
| properties | isRef 0<br>minOcc 0<br>maxOcc 1<br>content complex                                  |
| children   | <a href="#">ShareClass</a>  |
| annotation | documentation<br>Share classes of document  |

element **DocumentType/ShareClasses/ShareClass**

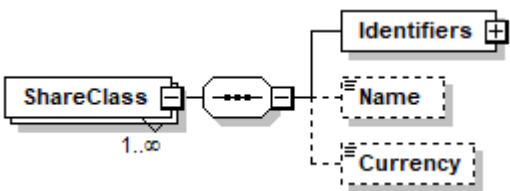
|            |   |
|------------|---|
| diagram    |  |
| properties | isRef 0<br>minOcc 1<br>maxOcc unbounded   |

|          |   |
|----------|---|
|          | content complex   |
| children | <a href="#">Identifiers</a> <a href="#">Name</a> <a href="#">Currency</a> |

element **DocumentType/ShareClasses/ShareClass/Identifiers**

diagram

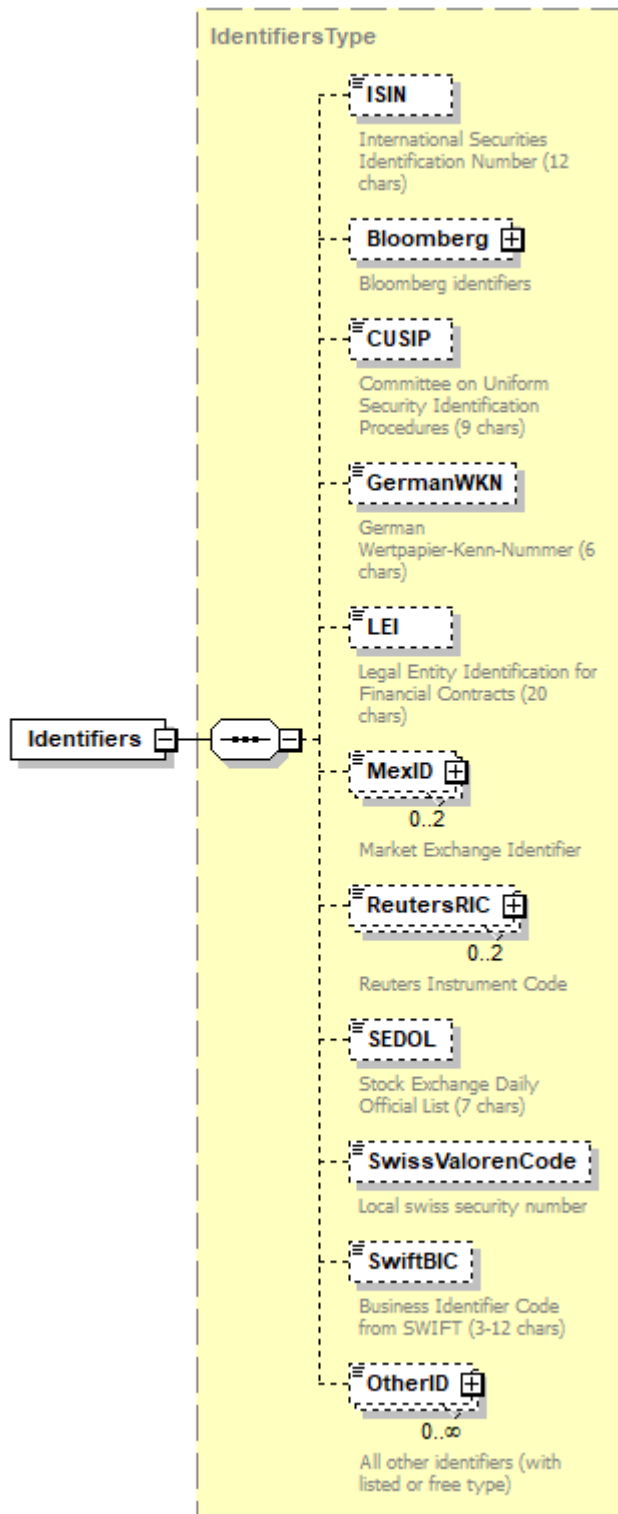

type [IdentifiersType](#)

properties isRef 0  
content complex

children [ISIN](#) [Bloomberg](#) [CUSIP](#) [GermanWKN](#) [LEI](#) [MexID](#) [ReutersRIC](#) [SEDOL](#) [SwissValorenCode](#) [SwiftBIC](#) [OtherID](#)

element **DocumentType/ShareClasses/ShareClass/Name**

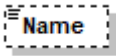
|            |   |
|------------|---|
| diagram    |  |
| type       | <a href="#">Text256Type</a>   |
| properties | isRef 0<br>minOcc 0<br>maxOcc 1<br>content simple                                 |
| facets     | Kind Value annotation<br>maxLength 256  |

element **DocumentType/ShareClasses/ShareClass/Currency**

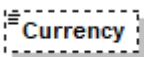
|            |   |
|------------|---|
| diagram    |  |
| type       | <a href="#">ISOCurrencyCodeType</a>   |
| properties | isRef 0<br>minOcc 0<br>maxOcc 1<br>content simple                                 |
| facets     | Kind Value annotation<br>minLength 3<br>maxLength 3<br>pattern [A-Z]{3}           |

element **DocumentType/Name**

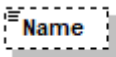
|            |   |
|------------|---|
| diagram    | <br>Name of document |
| type       | <a href="#">Text256Type</a>   |
| properties | isRef 0<br>minOcc 0<br>maxOcc 1<br>content simple   |
| facets     | Kind Value annotation<br>maxLength 256  |
| annotation | documentation<br>Name of document   |

element **DocumentType/FileName**

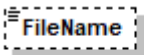
|            |  |
|------------|--|
| diagram    | <br>Name of file (including file extension) |
| type       | <a href="#">Text256Type</a>  |
| properties | isRef 0<br>minOcc 0  |

|            |  |
|------------|--|
|            | maxOcc 1<br>content simple                               |
| facets     | Kind Value annotation<br>maxLength 256                   |
| annotation | documentation<br>Name of file (including file extension) |

#### element **DocumentType/ForPublicUsage**

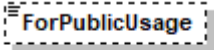
|            |  |
|------------|--|
| diagram    |  <p>Defines whether document can be published to the public</p> |
| type       | <b>xs:boolean</b>  |
| properties | isRef 0<br>minOcc 0<br>maxOcc 1<br>content simple  |
| annotation | documentation<br>Defines whether document can be published to the public   |

#### element **DocumentType/Restrictions**

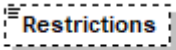
|            |  |
|------------|--|
| diagram    |  <p>Description of restrictions</p> |
| type       | <b>xs:string</b>   |
| properties | isRef 0<br>minOcc 0<br>maxOcc 1<br>content simple  |
| annotation | documentation<br>Description of restrictions   |

#### element **DocumentType/Format**

|            |  |
|------------|--|
| diagram    |  <p>Technical format of document:<br/>PDF, XML, Excel, Word, Image, ...</p> |
| type       | <a href="#">Text256Type</a>  |
| properties | isRef 0<br>content simple  |
| facets     | Kind Value annotation<br>maxLength 256   |
| annotation | documentation<br>Technical format of document:<br>PDF, XML, Excel, Word, Image, ...  |

element **DocumentType/Signature**

|            |   |
|------------|---|
| diagram    |  |
| type       | restriction of <b>xs:string</b>   |
| properties | isRef 0<br>minOcc 0<br>maxOcc 1<br>content simple                                 |
| annotation | documentation<br>Defines whether signature is available:<br>No, Digital, Scan     |

element **DocumentType/CreationDate**

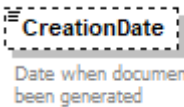
|            |   |
|------------|---|
| diagram    |  |
| type       | <b>xs:date</b>  |
| properties | isRef 0<br>minOcc 0<br>maxOcc 1<br>content simple                                 |
| annotation | documentation<br>Date when document has been generated                            |

element **DocumentType/ModificationDate**

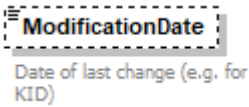
|            |   |
|------------|---|
| diagram    |  |
| type       | <b>xs:date</b>  |
| properties | isRef 0<br>minOcc 0<br>maxOcc 1<br>content simple                                   |
| annotation | documentation<br>Date of last change (e.g. for KID)                                 |

element **DocumentType/ExpirationDate**

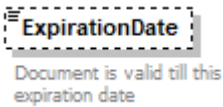
|            |   |
|------------|---|
| diagram    |  |
| type       | <b>xs:date</b>  |
| properties | isRef 0<br>minOcc 0<br>maxOcc 1<br>content simple                                   |

|            |  |
|------------|--|
| annotation | documentation<br>Document is valid till this expiration date |
|------------|--|

element **DocumentType/DataSupplier**

|            |   |
|------------|---|
| diagram    |   |
| type       | <a href="#">DataSupplierType</a>  |
| properties | isRef 0<br>minOcc 0<br>maxOcc 1<br>content complex  |
| children   | <a href="#">SystemCountry</a> <a href="#">Short</a> <a href="#">Name</a> <a href="#">Type</a> <a href="#">Contact</a> |
| annotation | documentation<br>Data supplier of document  |

element **DocumentType/Attributes**

|            |   |
|------------|---|
| diagram    |   |
| type       | <a href="#">AttributesType</a>  |
| properties | isRef 0<br>minOcc 0<br>maxOcc 1<br>content complex                      |
| children   | <a href="#">Attribute</a>   |
| annotation | documentation<br>Attributes of document (depending on type of document) |



element **DocumentType/SizeInBytes**

|            |  |
|------------|--|
| diagram    |  <p>Size of document in bytes<br/>(exact size of binary data,<br/>estimated size in case of<br/>download)</p> |
| type       | <b>xs:positiveInteger</b>  |
| properties | isRef 0<br>minOcc 0<br>maxOcc 1<br>content simple  |
| annotation | documentation<br>Size of document in bytes (exact size of binary data, estimated size in case of download)   |

element **DocumentType/DocumentURL**

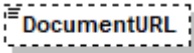
|            |   |
|------------|---|
| diagram    |  <p>Link of document for<br/>downloading</p> |
| type       | <b>xs:anyURI</b>  |
| properties | isRef 0<br>minOcc 0<br>maxOcc 1<br>content simple   |
| annotation | documentation<br>Link of document for downloading   |

element **DocumentType/BinaryData**

|            |  |
|------------|--|
| diagram    |  <p>Document in xml<br/>base64Binary format</p> |
| type       | <b>xs:base64Binary</b>   |
| properties | isRef 0<br>minOcc 0<br>maxOcc 1<br>content simple  |
| annotation | documentation<br>Document in xml base64Binary format   |

## complexType FundType

diagram

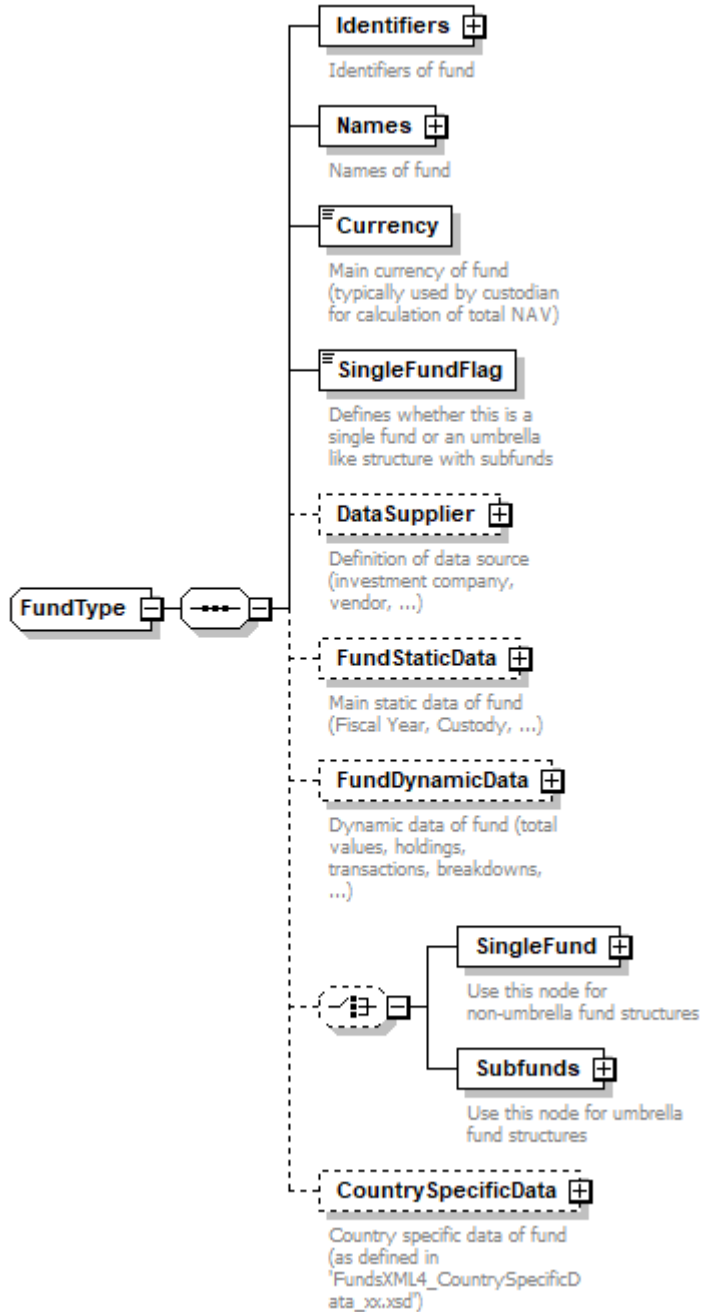

children

[Identifiers](#) [Names](#) [Currency](#) [SingleFundFlag](#) [DataSupplier](#) [FundStaticData](#) [FundDynamicData](#) [SingleFund](#) [Subfunds](#) [CountrySpecificData](#)

used by

element [FundsXML4/Funds/Fund](#)

element **FundType/Identifiers**

diagram

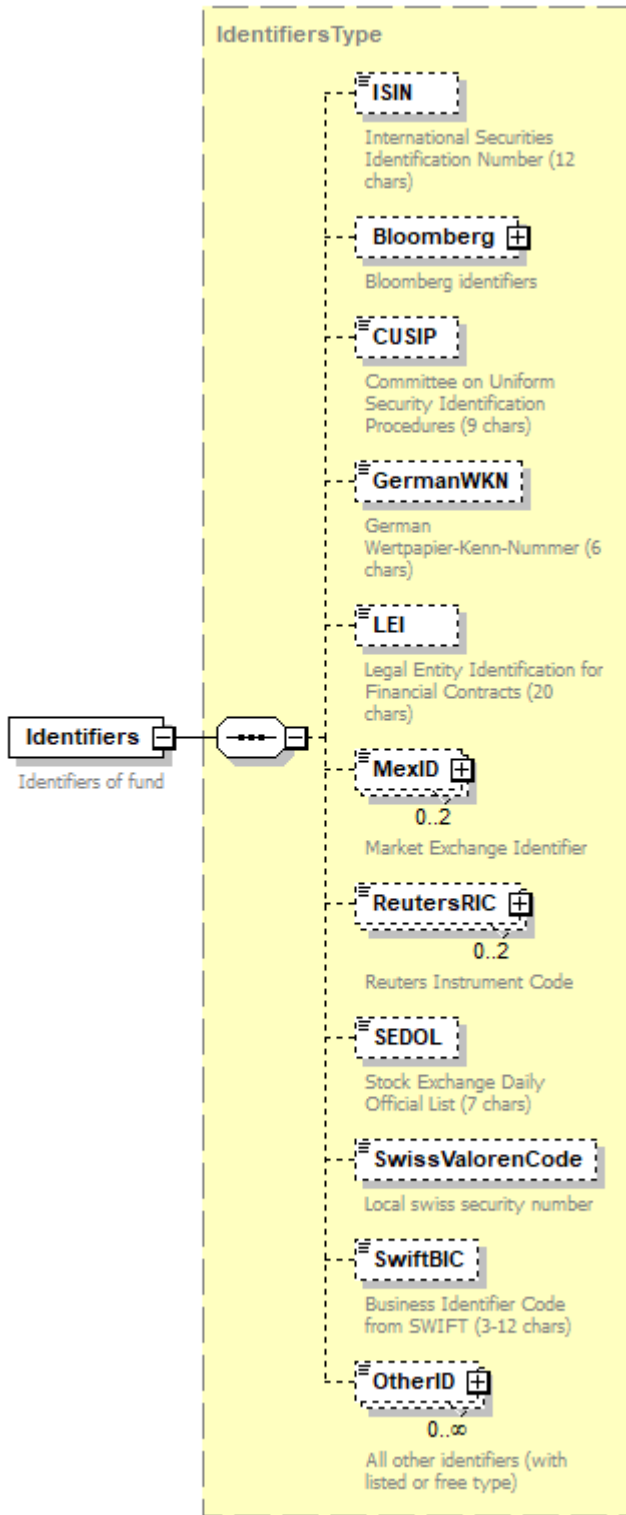

|            |   |
|------------|---|
| type       | <a href="#">IdentifiersType</a>   |
| properties | isRef 0<br>content complex  |
| children   | <a href="#">ISIN</a> <a href="#">Bloomberg</a> <a href="#">CUSIP</a> <a href="#">GermanWKN</a> <a href="#">LEI</a> <a href="#">MexID</a> <a href="#">ReutersRIC</a> <a href="#">SEDOL</a> <a href="#">SwissValorenCode</a> <a href="#">SwiftBIC</a> <a href="#">OtherID</a> |

|            |                                      |
|------------|--------------------------------------|
| annotation | documentation<br>Identifiers of fund |
|------------|--------------------------------------|

element **FundType/Names**

|            |  |
|------------|--|
| diagram    |  |
| type       | <a href="#">NamesType</a>  |
| properties | isRef 0<br>content complex   |
| children   | <a href="#">OfficialName</a> <a href="#">FullName</a> <a href="#">MarketingName</a> <a href="#">ShortName</a> <a href="#">PreviousName</a> <a href="#">DynLenNames</a> <a href="#">LanguageNames</a> |
| annotation | documentation<br>Names of fund   |

element **FundType/Currency**

|         |                                     |
|---------|-------------------------------------|
| diagram |                                     |
| type    | <a href="#">ISOCurrencyCodeType</a> |

|            |   |
|------------|---|
| properties | isRef 0<br>content simple   |
| facets     | Kind Value annotation<br>minLength 3<br>maxLength 3<br>pattern [A-Z]{3}                           |
| annotation | documentation<br>Main currency of fund (typically used by custodian for calculation of total NAV) |

element **FundType/SingleFundFlag**

|            |  |
|------------|--|
| diagram    |                   |
| type       | <b>xs:boolean</b>  |
| properties | isRef 0<br>content simple  |
| annotation | documentation<br>Defines whether this is a single fund or an umbrella like structure with subfunds |

element **FundType/DataSupplier**

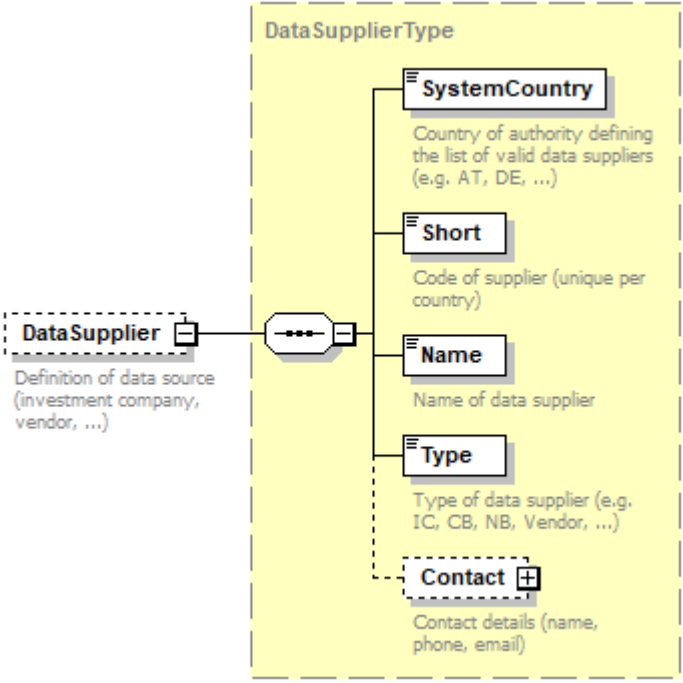
|            |   |
|------------|---|
| diagram    |                                     |
| type       | <a href="#">DataSupplierType</a>  |
| properties | isRef 0<br>minOcc 0<br>maxOcc 1<br>content complex  |
| children   | <a href="#">SystemCountry</a> <a href="#">Short</a> <a href="#">Name</a> <a href="#">Type</a> <a href="#">Contact</a> |
| annotation | documentation<br>Definition of data source (investment company, vendor, ...)  |



# element FundType/FundStaticData

diagram

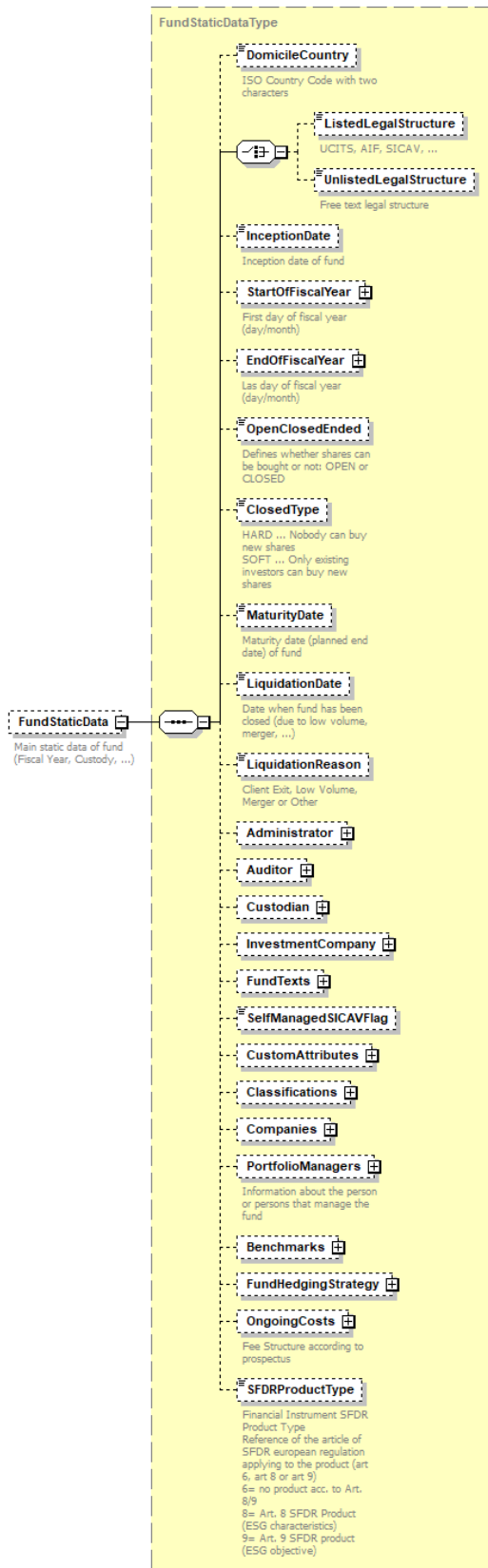

|            |   |
|------------|---|
| type       | <a href="#">FundStaticDataType</a>  |
| properties | isRef 0<br>minOcc 0<br>maxOcc 1<br>content complex  |
| children   | <a href="#">DomicileCountry</a> <a href="#">ListedLegalStructure</a> <a href="#">UnlistedLegalStructure</a> <a href="#">InceptionDate</a> <a href="#">StartOfFiscalYear</a> <a href="#">EndOfFiscalYear</a> <a href="#">OpenClosedEnded</a> <a href="#">ClosedType</a> <a href="#">MaturityDate</a> <a href="#">LiquidationDate</a> <a href="#">LiquidationReason</a> <a href="#">Administrator</a> <a href="#">Auditor</a> <a href="#">Custodian</a> <a href="#">InvestmentCompany</a> <a href="#">FundTexts</a> <a href="#">SelfManagedSICAVFlag</a> <a href="#">CustomAttributes</a> <a href="#">Classifications</a> <a href="#">Companies</a> <a href="#">PortfolioManagers</a> <a href="#">Benchmarks</a> <a href="#">FundHedgingStrategy</a> <a href="#">OngoingCosts</a> <a href="#">SFDRProductType</a> |
| annotation | documentation<br>Main static data of fund (Fiscal Year, Custody, ...)   |

element **FundType/FundDynamicData**

|            |   |
|------------|---|
| diagram    | <pre> classDiagram     class FundDynamicData {         +FundDynamicDataType     }     class FundDynamicDataType {         +TotalAssetValues         +Portfolios         +Benchmarks     }     FundDynamicData -- FundDynamicDataType     FundDynamicDataType -- TotalAssetValues     FundDynamicDataType -- Portfolios     FundDynamicDataType -- Benchmarks </pre> |
| type       | <a href="#">FundDynamicDataType</a>   |
| properties | isRef 0<br>minOcc 0<br>maxOcc 1<br>content complex  |
| children   | <a href="#">TotalAssetValues</a> <a href="#">Portfolios</a> <a href="#">Benchmarks</a>  |
| annotation | documentation<br>Dynamic data of fund (total values, holdings, transactions, breakdowns, ...)   |

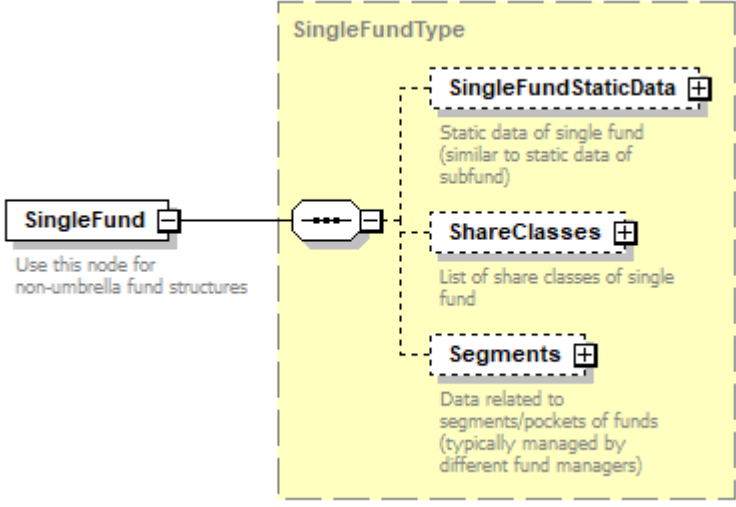

### element FundType/SingleFund

|                   |  |
|-------------------|--|
| <p>diagram</p>    |  <p>The diagram shows a <b>SingleFund</b> node connected to a <b>SingleFundType</b> container. The <b>SingleFund</b> node has the text "Use this node for non-umbrella fund structures". The <b>SingleFundType</b> container is highlighted in yellow and contains three sub-nodes: <b>SingleFundStaticData</b> (with text: "Static data of single fund (similar to static data of subfund)"), <b>ShareClasses</b> (with text: "List of share classes of single fund"), and <b>Segments</b> (with text: "Data related to segments/pockets of funds (typically managed by different fund managers)").</p> |
| <p>type</p>       | <p><a href="#">SingleFundType</a></p>  |
| <p>properties</p> | <p>isRef 0<br/>content complex</p>   |
| <p>children</p>   | <p><a href="#">SingleFundStaticData</a> <a href="#">ShareClasses</a> <a href="#">Segments</a></p>  |
| <p>annotation</p> | <p>documentation<br/>Use this node for non-umbrella fund structures</p>  |

### element FundType/Subfunds

|                   |  |
|-------------------|--|
| <p>diagram</p>    |  <p>The diagram shows a <b>Subfunds</b> node connected to a <b>Subfund</b> node. The <b>Subfunds</b> node has the text "Use this node for umbrella fund structures". The <b>Subfund</b> node has the text "Static and dynamic data of a subfund" and a cardinality of "1..∞".</p> |
| <p>properties</p> | <p>isRef 0<br/>content complex</p>   |
| <p>children</p>   | <p><a href="#">Subfund</a></p>   |
| <p>annotation</p> | <p>documentation<br/>Use this node for umbrella fund structures</p>  |

element **FundType/Subfunds/Subfund**

|                   |   |
|-------------------|---|
| <p>diagram</p>    | <p>The diagram illustrates the structure of a Subfund element. On the left, a box labeled 'Subfund' with a multiplicity of '1..∞' and the description 'Static and dynamic data of a subfund' is connected to a dashed-line container labeled 'SubfundType'. Inside the 'SubfundType' container, there are seven sub-elements:</p> <ul style="list-style-type: none"> <li><b>Identifiers</b> (+): Identifiers of subfund</li> <li><b>Names</b> (+): Names of subfund</li> <li><b>Currency</b> (=): Currency of subfund</li> <li><b>SubfundStaticData</b> (+): Static data of subfund (similar to static data of single fund)</li> <li><b>SubfundDynamicData</b> (+): Total asset values, portfolio data</li> <li><b>ShareClasses</b> (+): List of share classes of subfund</li> <li><b>Segments</b> (+): Data related to segments/pockets of funds (typically managed by different fund managers)</li> </ul> |
| <p>type</p>       | <p><a href="#">SubfundType</a></p>  |
| <p>properties</p> | <p>isRef 0<br/>minOcc 1<br/>maxOcc unbounded<br/>content complex</p>  |
| <p>children</p>   | <p><a href="#">Identifiers</a> <a href="#">Names</a> <a href="#">Currency</a> <a href="#">SubfundStaticData</a> <a href="#">SubfundDynamicData</a> <a href="#">ShareClasses</a> <a href="#">Segments</a></p>  |
| <p>annotation</p> | <p>documentation<br/>Static and dynamic data of a subfund</p>   |

element **FundType/CountrySpecificData**

|                   |  |
|-------------------|--|
| <p>diagram</p>    | <p>The diagram illustrates the structure of the <b>CountrySpecificData</b> element. It is a complex type containing a choice of six <b>CountrySpecificFundDataType</b> elements, each representing a different country: AT (Austria), DE (Germany), DK (Denmark), FR (France), LU (Luxembourg), and NL (Netherlands). Each country-specific type is represented by a dashed box with a plus sign icon, indicating it is a complex type. The <b>CountrySpecificData</b> element is shown as a solid box with a plus sign icon, indicating it is a complex type. A dashed line connects the <b>CountrySpecificData</b> element to the choice container, which then branches into the six country-specific types.</p> |
| <p>type</p>       | <p><a href="#">CountrySpecificFundDataType</a></p>   |
| <p>properties</p> | <p>isRef 0<br/>minOcc 0<br/>maxOcc 1<br/>content complex</p>   |
| <p>children</p>   | <p><a href="#">AT</a> <a href="#">DE</a> <a href="#">DK</a> <a href="#">FR</a> <a href="#">LU</a> <a href="#">NL</a></p>   |
| <p>annotation</p> | <p>documentation<br/>Country specific data of fund (as defined in 'FundsXML4_CountrySpecificData_xx.xsd')</p>  |

complexType IndirectReportingType

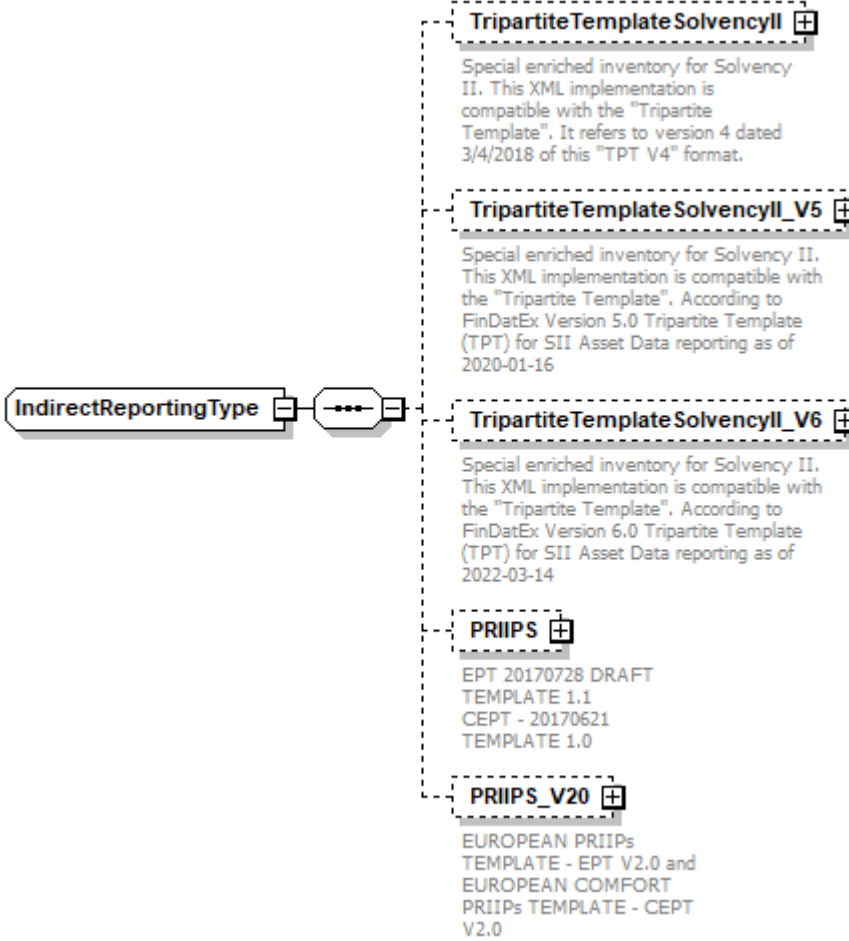
|                 |   |
|-----------------|---|
| <p>diagram</p>  |  <p><b>TripartiteTemplateSolvencyII</b> </p> <p>Special enriched inventory for Solvency II. This XML implementation is compatible with the "Tripartite Template". It refers to version 4 dated 3/4/2018 of this "TPT V4" format.</p> <p><b>TripartiteTemplateSolvencyII_V5</b> </p> <p>Special enriched inventory for Solvency II. This XML implementation is compatible with the "Tripartite Template". According to FinDatEx Version 5.0 Tripartite Template (TPT) for SII Asset Data reporting as of 2020-01-16</p> <p><b>TripartiteTemplateSolvencyII_V6</b> </p> <p>Special enriched inventory for Solvency II. This XML implementation is compatible with the "Tripartite Template". According to FinDatEx Version 6.0 Tripartite Template (TPT) for SII Asset Data reporting as of 2022-03-14</p> <p><b>PRIIPS</b> </p> <p>EPT 20170728 DRAFT<br/>TEMPLATE 1.1<br/>CEPT - 20170621<br/>TEMPLATE 1.0</p> <p><b>PRIIPS_V20</b> </p> <p>EUROPEAN PRIIPs<br/>TEMPLATE - EPT V2.0 and<br/>EUROPEAN COMFORT<br/>PRIIPs TEMPLATE - CEPT<br/>V2.0</p> |
| <p>children</p> | <p><a href="#">TripartiteTemplateSolvencyII</a> <a href="#">TripartiteTemplateSolvencyII_V5</a> <a href="#">TripartiteTemplateSolvencyII_V6</a> <a href="#">PRIIPS</a> <a href="#">PRIIPS_V20</a></p>   |
| <p>used by</p>  | <p>element <a href="#">RegulatoryReportingsType/IndirectReporting</a></p>   |

element **IndirectReportingType/TripartiteTemplateSolvencyII**

|                   |   |
|-------------------|---|
| <p>diagram</p>    | <p><b>TripartiteTemplateSolvencyII</b><br/>Special enriched inventory for Solvency II. This XML implementation is compatible with the "Tripartite Template". It refers to version 4 dated 3/4/2018 of this "TPT V4" format.</p> <p><b>TripartiteTemplateSolvencyIIType</b><br/>The Portfolio is analysed from investor's point of view. If Portfolio is a Fund with share classes, there is one Portfolio for each share class. For hedged shares, hedging instruments are included in the portfolio. References to Club AMPERE Excel "Template for Solvency 2 reporting": Ann in Annotations refers to row #nn in column A (or "NUM") of the Spreadsheet</p> |
| <p>type</p>       | <p><a href="#">TripartiteTemplateSolvencyIIType</a></p>   |
| <p>properties</p> | <p>isRef 0<br/>minOcc 0<br/>maxOcc 1<br/>content complex</p>  |
| <p>children</p>   | <p><a href="#">Portfolio</a></p>  |
| <p>annotation</p> | <p>documentation<br/>Special enriched inventory for Solvency II. This XML implementation is compatible with the "Tripartite Template". It refers to version 4 dated 3/4/2018 of this "TPT V4" format.</p>   |

element **IndirectReportingType/TripartiteTemplateSolvencyII\_V5**

|                   |  |
|-------------------|--|
| <p>diagram</p>    | <p><b>TripartiteTemplateSolvencyII_V5</b><br/>Special enriched inventory for Solvency II. This XML implementation is compatible with the "Tripartite Template". According to FinDatEx Version 5.0 Tripartite Template (TPT) for SII Asset Data reporting as of 2020-01-16</p> <p><b>TripartiteTemplateSolvencyIIType_V5</b><br/>The Portfolio is analysed from investor's point of view. If Portfolio is a Fund with share classes, there is one Portfolio for each share class. For hedged shares, hedging instruments are included in the portfolio.</p> |
| <p>type</p>       | <p><a href="#">TripartiteTemplateSolvencyIIType_V5</a></p>   |
| <p>properties</p> | <p>isRef 0<br/>minOcc 0<br/>maxOcc 1<br/>content complex</p>   |
| <p>children</p>   | <p><a href="#">Portfolio</a></p>   |
| <p>annotation</p> | <p>documentation<br/>Special enriched inventory for Solvency II. This XML implementation is compatible with the "Tripartite Template". According to FinDatEx Version 5.0 Tripartite Template (TPT) for SII Asset Data reporting as of 2020-01-16</p>   |

element **IndirectReportingType/TripartiteTemplateSolvencyII\_V6**

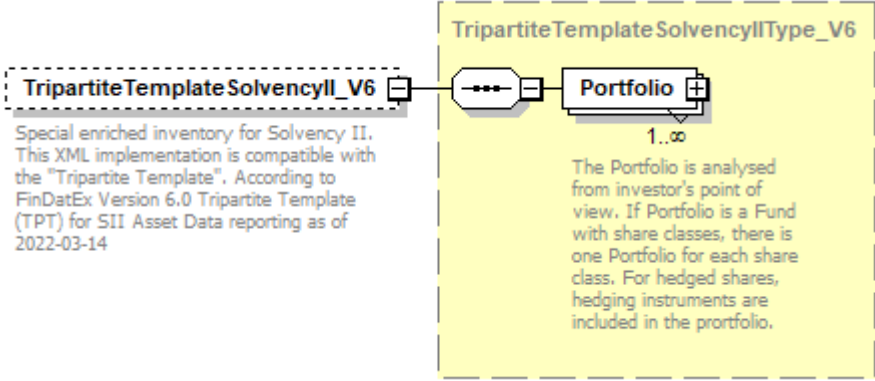
|                   |   |
|-------------------|---|
| <p>diagram</p>    |  <p><b>TripartiteTemplateSolvencyII_V6</b></p> <p>Special enriched inventory for Solvency II. This XML implementation is compatible with the "Tripartite Template". According to FinDatEx Version 6.0 Tripartite Template (TPT) for SII Asset Data reporting as of 2022-03-14</p> <p><b>Portfolio</b></p> <p>1..∞</p> <p>The Portfolio is analysed from investor's point of view. If Portfolio is a Fund with share classes, there is one Portfolio for each share class. For hedged shares, hedging instruments are included in the portfolio.</p> |
| <p>type</p>       | <p><a href="#">TripartiteTemplateSolvencyIIType_V6</a></p>  |
| <p>properties</p> | <p>isRef 0<br/>minOcc 0<br/>maxOcc 1<br/>content complex</p>  |
| <p>children</p>   | <p><a href="#">Portfolio</a></p>  |
| <p>annotation</p> | <p>documentation<br/>Special enriched inventory for Solvency II. This XML implementation is compatible with the "Tripartite Template". According to FinDatEx Version 6.0 Tripartite Template (TPT) for SII Asset Data reporting as of 2022-03-14</p>  |

element **IndirectReportingType/PRIIPS**

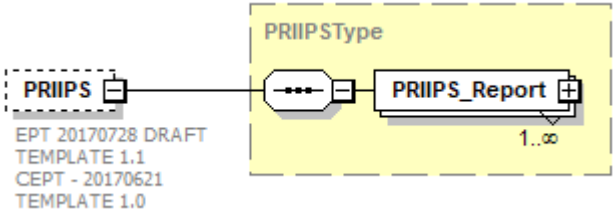
|                   |   |
|-------------------|---|
| <p>diagram</p>    |  <p><b>PRIIPS</b></p> <p>EPT 20170728 DRAFT<br/>TEMPLATE 1.1<br/>CEPT - 20170621<br/>TEMPLATE 1.0</p> <p><b>PRIIPS_Report</b></p> <p>1..∞</p> <p><b>PRIIPSType</b></p> |
| <p>type</p>       | <p><a href="#">PRIIPSType</a></p>   |
| <p>properties</p> | <p>isRef 0<br/>minOcc 0<br/>maxOcc 1<br/>content complex</p>  |
| <p>children</p>   | <p><a href="#">PRIIPS_Report</a></p>  |
| <p>annotation</p> | <p>documentation<br/>EPT 20170728 DRAFT TEMPLATE 1.1<br/>CEPT - 20170621 TEMPLATE 1.0</p>   |

element **IndirectReportingType/PRIIPS\_V20**

|            |   |
|------------|---|
| diagram    | <p>EUROPEAN PRIIPs<br/>TEMPLATE - EPT V2.0 and<br/>EUROPEAN COMFORT<br/>PRIIPs TEMPLATE - CEPT<br/>V2.0</p> |
| type       | <a href="#">PRIIPSType V20</a>  |
| properties | isRef 0<br>minOcc 0<br>maxOcc 1<br>content complex  |
| children   | <a href="#">EPTV2</a> <a href="#">CEPTV2History</a> <a href="#">CEPTV2Performance</a>                       |
| annotation | documentation<br>EUROPEAN PRIIPs TEMPLATE - EPT V2.0 and EUROPEAN COMFORT PRIIPs TEMPLATE - CEPT V2.0       |

complexType **RegulatoryReportingsType**

|          |   |
|----------|---|
| diagram  | <p>DirectReporting<br/>Direct reporting according to<br/>European regulatory<br/>reporting frameworks</p> <p>IndirectReporting<br/>Reporting data for investors</p> |
| children | <a href="#">DirectReporting</a> <a href="#">IndirectReporting</a>   |
| used by  | element <a href="#">FundsXML4/RegulatoryReportings</a>  |

element **RegulatoryReportingsType/DirectReporting**

diagram

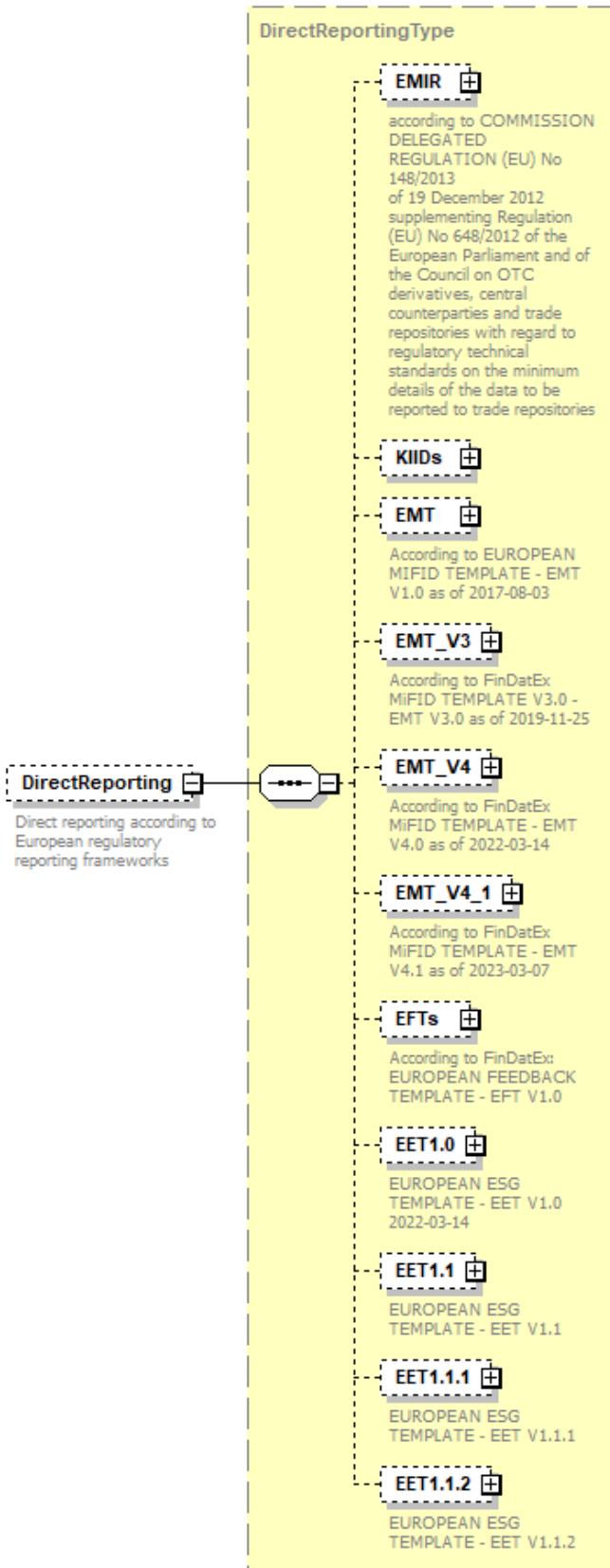



|            |  |
|------------|--|
| type       | <a href="#">DirectReportingType</a>  |
| properties | isRef 0<br>minOcc 0<br>maxOcc 1<br>content complex   |
| children   | <a href="#">EMIR KIIDs</a> <a href="#">EMT</a> <a href="#">EMT_V3</a> <a href="#">EMT_V4</a> <a href="#">EMT_V4_1</a> <a href="#">EFTs</a> <a href="#">EET1.0</a> <a href="#">EET1.1</a> <a href="#">EET1.1.1</a> <a href="#">EET1.1.2</a> |
| annotation | documentation<br>Direct reporting according to European regulatory reporting frameworks  |

element **RegulatoryReportingsType/IndirectReporting**

|            |  |
|------------|--|
| diagram    | <p>The diagram illustrates the structure of the <b>IndirectReportingType</b> element. It is a base class (represented by a dashed box with a plus sign icon) that contains five child elements, also represented by dashed boxes with plus sign icons. The children are:</p> <ul style="list-style-type: none"> <li><b>TripartiteTemplateSolvencyII</b>: Special enriched inventory for Solvency II. This XML implementation is compatible with the "Tripartite Template". It refers to version 4 dated 3/4/2018 of this "TPT V4" format.</li> <li><b>TripartiteTemplateSolvencyII_V5</b>: Special enriched inventory for Solvency II. This XML implementation is compatible with the "Tripartite Template". According to FinDatEx Version 5.0 Tripartite Template (TPT) for SII Asset Data reporting as of 2020-01-16.</li> <li><b>TripartiteTemplateSolvencyII_V6</b>: Special enriched inventory for Solvency II. This XML implementation is compatible with the "Tripartite Template". According to FinDatEx Version 6.0 Tripartite Template (TPT) for SII Asset Data reporting as of 2022-03-14.</li> <li><b>PRIIPS</b>: EPT 20170728 DRAFT TEMPLATE 1.1<br/>CEPT - 20170621 TEMPLATE 1.0</li> <li><b>PRIIPS_V20</b>: EUROPEAN PRIIPs TEMPLATE - EPT V2.0 and EUROPEAN COMFORT PRIIPs TEMPLATE - CEPT V2.0</li> </ul> <p>The <b>IndirectReportingType</b> element is described as "Reporting data for investors".</p> |
| type       | <a href="#">IndirectReportingType</a>  |
| properties | isRef 0<br>minOcc 0<br>maxOcc 1<br>content complex   |
| children   | <a href="#">TripartiteTemplateSolvencyII</a> <a href="#">TripartiteTemplateSolvencyII_V5</a> <a href="#">TripartiteTemplateSolvencyII_V6</a> <a href="#">PRIIPS</a> <a href="#">PRIIPS_V20</a>   |
| annotation | documentation<br>Reporting data for investors  |

complexType **SegmentDynamicDataType**

|          |   |
|----------|---|
| diagram  |   |
| children | <a href="#">TotalAssetValues</a> <a href="#">Portfolios</a> |
| used by  | element <a href="#">SegmentType/SegmentDynamicData</a>      |

element **SegmentDynamicDataType/TotalAssetValues**

|            |  |
|------------|--|
| diagram    |  |
| properties | isRef 0<br>minOcc 0<br>maxOcc 1<br>content complex |
| children   | <a href="#">TotalAssetValue</a>                    |
| annotation | documentation<br>Total NAV (volume) of fund        |

element **SegmentDynamicDataType/TotalAssetValues/TotalAssetValue**

|                   |   |
|-------------------|---|
| <p>diagram</p>    |   |
| <p>type</p>       | <p><a href="#">TotalAssetValueType</a></p>  |
| <p>properties</p> | <p>isRef 0<br/>minOcc 1<br/>maxOcc unbounded<br/>content complex</p>  |
| <p>children</p>   | <p><a href="#">NavDate</a> <a href="#">TotalAssetNature</a> <a href="#">TotalNetAssetValue</a> <a href="#">TotalGrossAssetValue</a> <a href="#">SharesOutstanding</a> <a href="#">Ratio</a> <a href="#">OtherTotalAssetValues</a></p> |

element **SegmentDynamicDataType/Portfolios**

|                   |                             |
|-------------------|-----------------------------|
| <p>diagram</p>    |                             |
| <p>properties</p> | <p>isRef 0<br/>minOcc 0</p> |

|            |   |
|------------|---|
|            | maxOcc 1<br>content complex                 |
| children   | <a href="#">Portfolio</a>                   |
| annotation | documentation<br>All portfolio related data |

element **SegmentDynamicDataType/Portfolios/Portfolio**

|            |   |
|------------|---|
| diagram    | <p>The diagram illustrates the structure of the <b>PortfolioType</b> element. It shows a <b>Portfolio</b> entity (represented by a box with a small square on the right) connected to a <b>PortfolioType</b> container (represented by a dashed yellow box). The <b>Portfolio</b> entity has a cardinality of <b>1..∞</b>. The <b>PortfolioType</b> container includes the following sections:</p> <ul style="list-style-type: none"> <li><b>NavDate</b>: NavDate for all data within this section</li> <li><b>Positions</b>: All positions/holdings of fund/portfolio (including accounts, earnings and fees)</li> <li><b>Transactions</b>: Transactions within the portfolio (securities and other assets bought or sold)</li> <li><b>Earnings</b>: Earnings data (coupons, dividends, distributions) resulting from security positions</li> <li><b>PositionsDecomposed</b>: Decomposed positions (holdings of share classes are replaced by the scaled down positions of the subfund)</li> <li><b>BreakDowns</b>: All kind of break down data (including currency exposure)</li> <li><b>RiskCodes</b>: List of risk codes (risk indicators, key risk figures)</li> </ul> |
| type       | <a href="#">PortfolioType</a>   |
| properties | isRef 0<br>minOcc 1<br>maxOcc unbounded<br>content complex  |
| children   | <a href="#">NavDate</a> <a href="#">Positions</a> <a href="#">Transactions</a> <a href="#">Earnings</a> <a href="#">PositionsDecomposed</a> <a href="#">BreakDowns</a> <a href="#">RiskCodes</a>  |

### complexType SegmentStaticDataType

|            |  |
|------------|--|
| diagram    |  |
| children   | <a href="#">InceptionDate</a> <a href="#">LiquidationDate</a> <a href="#">Manager</a> <a href="#">Description</a> <a href="#">CustomAttributes</a> |
| used by    | element <a href="#">SegmentType/SegmentStaticData</a>  |
| annotation | documentation<br>All static data for Segments  |

### element SegmentStaticDataType/InceptionDate

|            |   |       |   |        |   |        |   |         |        |
|------------|---|-------|---|--------|---|--------|---|---------|--------|
| diagram    |   |       |   |        |   |        |   |         |        |
| type       | <b>xs:date</b>  |       |   |        |   |        |   |         |        |
| properties | <table> <tr><td>isRef</td><td>0</td></tr> <tr><td>minOcc</td><td>0</td></tr> <tr><td>maxOcc</td><td>1</td></tr> <tr><td>content</td><td>simple</td></tr> </table> | isRef | 0 | minOcc | 0 | maxOcc | 1 | content | simple |
| isRef      | 0   |       |   |        |   |        |   |         |        |
| minOcc     | 0   |       |   |        |   |        |   |         |        |
| maxOcc     | 1   |       |   |        |   |        |   |         |        |
| content    | simple  |       |   |        |   |        |   |         |        |

### element SegmentStaticDataType/LiquidationDate

|            |   |       |   |        |   |        |   |         |        |
|------------|---|-------|---|--------|---|--------|---|---------|--------|
| diagram    |   |       |   |        |   |        |   |         |        |
| type       | <b>xs:date</b>  |       |   |        |   |        |   |         |        |
| properties | <table> <tr><td>isRef</td><td>0</td></tr> <tr><td>minOcc</td><td>0</td></tr> <tr><td>maxOcc</td><td>1</td></tr> <tr><td>content</td><td>simple</td></tr> </table> | isRef | 0 | minOcc | 0 | maxOcc | 1 | content | simple |
| isRef      | 0   |       |   |        |   |        |   |         |        |
| minOcc     | 0   |       |   |        |   |        |   |         |        |
| maxOcc     | 1   |       |   |        |   |        |   |         |        |
| content    | simple  |       |   |        |   |        |   |         |        |

element **SegmentStaticDataType/Manager**

|                   |   |
|-------------------|---|
| <p>diagram</p>    |   |
| <p>type</p>       | <p><a href="#">CompanyType</a></p>  |
| <p>properties</p> | <p>isRef 0<br/>minOcc 0<br/>maxOcc 1<br/>content complex</p>  |
| <p>children</p>   | <p><a href="#">Identifiers</a> <a href="#">Name</a> <a href="#">LegalName</a> <a href="#">LegalForm</a> <a href="#">Address</a> <a href="#">BusinessCountry</a> <a href="#">ParentCompany</a> <a href="#">OtherClassification</a></p> |

element **SegmentStaticDataType/Description**

|                   |  |
|-------------------|--|
| <p>diagram</p>    |  |
| <p>type</p>       | <p>extension of <b>xs:string</b></p>                                 |
| <p>properties</p> | <p>isRef 0<br/>minOcc 0<br/>maxOcc unbounded<br/>content complex</p> |

attribute **SegmentStaticData/Description/@language**

|            |                         |
|------------|-------------------------|
| type       | xs:language             |
| properties | isRef 0<br>use required |

element **SegmentStaticData/CustomAttributes**

|            |   |
|------------|---|
| diagram    | <p>The diagram shows a dashed box labeled 'CustomAttributes' containing a solid box labeled 'AttributesType'. Inside 'AttributesType', there is a sequence of elements: a solid box with three dots (representing a sequence) followed by a solid box labeled 'Attribute' with a '1..∞' cardinality constraint.</p> |
| type       | <a href="#">AttributesType</a>  |
| properties | isRef 0<br>minOcc 0<br>maxOcc 1<br>content complex  |
| children   | <a href="#">Attribute</a>   |

complexType **SegmentType**

|          |  |
|----------|--|
| diagram  | <p>The diagram shows a solid box labeled 'SegmentType' containing a sequence of elements: a solid box with three dots (representing a sequence) followed by a solid box with a '+' icon. This '+' icon branches into seven dashed boxes, each representing a child element with a '+' icon: 'Identifiers' (Fund identifiers), 'Name' (Name of segment), 'Currency' (Currency of segment), 'SegmentStaticData' (Inception, manager, description, ...), 'SegmentDynamicData' (Total asset values, portfolio data), 'ShareClasses' (List of share classes of segment), and 'Segments' (Data related to subsegments / subpockets of funds (typically managed by different fund managers)).</p> |
| children | <a href="#">Identifiers</a> <a href="#">Name</a> <a href="#">Currency</a> <a href="#">SegmentStaticData</a> <a href="#">SegmentDynamicData</a> <a href="#">ShareClasses</a> <a href="#">Segments</a>   |
| used by  | elements <a href="#">SegmentType/Segments/Segment</a> <a href="#">SubfundType/Segments/Segment</a> <a href="#">SingleFundType/Segments/Segment</a>   |

element **SegmentType/Identifiers**

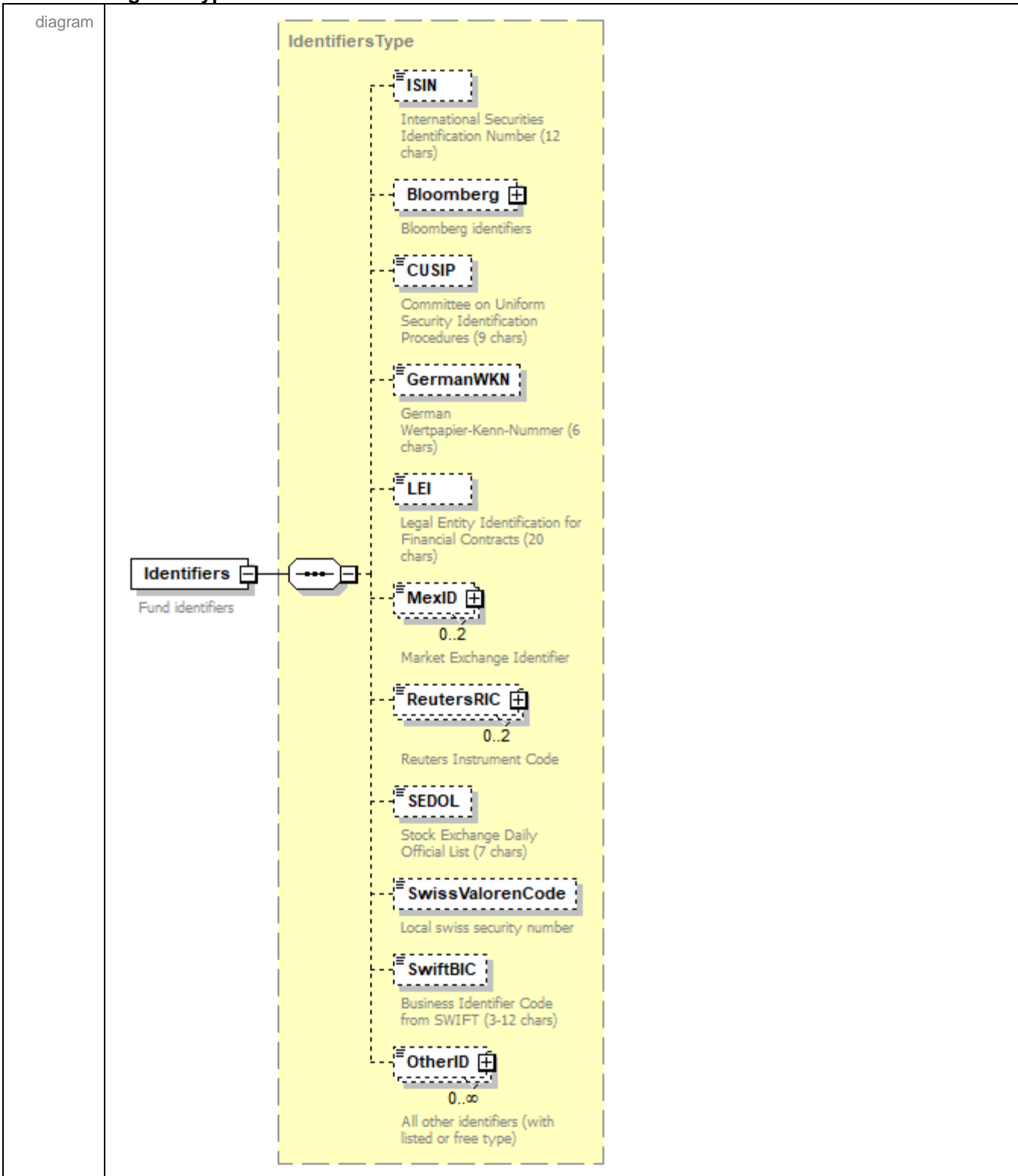

|            |                                 |
|------------|---------------------------------|
| type       | <a href="#">IdentifiersType</a> |
| properties | isRef 0<br>content complex      |



|            |   |
|------------|---|
| children   | <a href="#">ISIN</a> <a href="#">Bloomberg</a> <a href="#">CUSIP</a> <a href="#">GermanWKN</a> <a href="#">LEI</a> <a href="#">MexID</a> <a href="#">ReutersRIC</a> <a href="#">SEDOL</a> <a href="#">SwissValorenCode</a> <a href="#">SwiftBIC</a> <a href="#">OtherID</a> |
| annotation | documentation<br>Fund identifiers   |

### element SegmentType/Name

|            |  |
|------------|--|
| diagram    |  |
| type       | <a href="#">Text500Type</a>            |
| properties | isRef 0<br>content simple              |
| facets     | Kind Value annotation<br>maxLength 500 |
| annotation | documentation<br>Name of segment       |

### element SegmentType/Currency

|            |   |
|------------|---|
| diagram    |   |
| type       | <a href="#">ISOCurrencyCodeType</a>                                     |
| properties | isRef 0<br>content simple   |
| facets     | Kind Value annotation<br>minLength 3<br>maxLength 3<br>pattern [A-Z]{3} |
| annotation | documentation<br>Currency of segment                                    |

### element SegmentType/SegmentStaticData

|            |                                       |
|------------|---------------------------------------|
| diagram    |                                       |
| type       | <a href="#">SegmentStaticDataType</a> |
| properties | isRef 0<br>minOcc 0                   |

|            |  |
|------------|--|
|            | maxOcc 1<br>content complex  |
| children   | <a href="#">InceptionDate</a> <a href="#">LiquidationDate</a> <a href="#">Manager</a> <a href="#">Description</a> <a href="#">CustomAttributes</a> |
| annotation | documentation<br>Inception, manager, description, ...  |

element **SegmentType/SegmentDynamicData**

|            |   |
|------------|---|
| diagram    |   |
| type       | <a href="#">SegmentDynamicDataType</a>                      |
| properties | isRef 0<br>minOcc 0<br>maxOcc 1<br>content complex          |
| children   | <a href="#">TotalAssetValues</a> <a href="#">Portfolios</a> |
| annotation | documentation<br>Total asset values, portfolio data         |

element **SegmentType/ShareClasses**

|            |  |
|------------|--|
| diagram    |  |
| properties | isRef 0<br>minOcc 0<br>maxOcc 1<br>content complex |
| children   | <a href="#">ShareClass</a>                         |
| annotation | documentation<br>List of share classes of segment  |

element **SegmentType/ShareClasses/ShareClass**

diagram

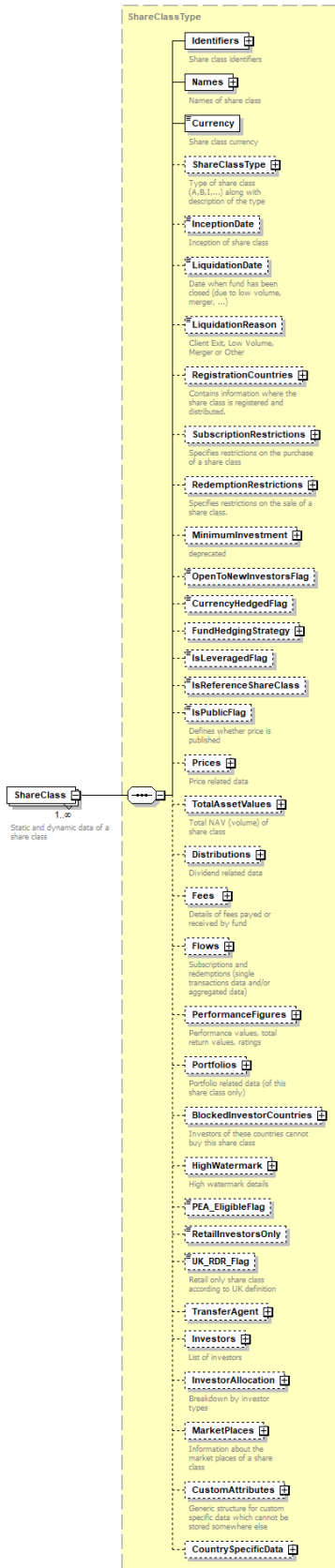

|            |  |
|------------|--|
| type       | <a href="#">ShareClassType</a>   |
| properties | isRef 0<br>minOcc 1<br>maxOcc unbounded<br>content complex   |
| children   | <a href="#">Identifiers</a> <a href="#">Names</a> <a href="#">Currency</a> <a href="#">ShareClassType</a> <a href="#">InceptionDate</a> <a href="#">LiquidationDate</a> <a href="#">LiquidationReason</a> <a href="#">RegistrationCountries</a> <a href="#">SubscriptionRestrictions</a> <a href="#">RedemptionRestrictions</a> <a href="#">MinimumInvestment</a> <a href="#">OpenToNewInvestorsFlag</a> <a href="#">CurrencyHedgedFlag</a> <a href="#">FundHedgingStrategy</a> <a href="#">IsLeveragedFlag</a> <a href="#">IsReferenceShareClass</a> <a href="#">IsPublicFlag</a> <a href="#">Prices</a> <a href="#">TotalAssetValues</a> <a href="#">Distributions</a> <a href="#">Fees</a> <a href="#">Flows</a> <a href="#">PerformanceFigures</a> <a href="#">Portfolios</a> <a href="#">BlockedInvestorCountries</a> <a href="#">HighWatermark</a> <a href="#">PEA</a> <a href="#">EligibleFlag</a> <a href="#">RetailInvestorsOnly</a> <a href="#">UK</a> <a href="#">RDR</a> <a href="#">Flag</a> <a href="#">TransferAgent</a> <a href="#">Investors</a> <a href="#">InvestorAllocation</a> <a href="#">MarketPlaces</a> <a href="#">CustomAttributes</a> <a href="#">CountrySpecificData</a> |
| annotation | documentation<br>Static and dynamic data of a share class  |

element **SegmentType/Segments**

|            |   |
|------------|---|
| diagram    | <pre> classDiagram     class Segments {     }     class Segment {     }     Segments "1" -- "1..∞" Segment   </pre> <p>Data related to subsegments / subpockets of funds (typically managed by different fund managers)</p> |
| properties | isRef 0<br>minOcc 0<br>maxOcc 1<br>content complex  |
| children   | <a href="#">Segment</a>   |
| annotation | documentation<br>Data related to subsegments / subpockets of funds (typically managed by different fund managers)   |

element **SegmentType/Segments/Segment**

|                   |   |
|-------------------|---|
| <p>diagram</p>    |   |
| <p>type</p>       | <p><a href="#">SegmentType</a></p>  |
| <p>properties</p> | <p>isRef 0<br/> minOcc 1<br/> maxOcc unbounded<br/> content complex</p>   |
| <p>children</p>   | <p><a href="#">Identifiers</a> <a href="#">Name</a> <a href="#">Currency</a> <a href="#">SegmentStaticData</a> <a href="#">SegmentDynamicData</a> <a href="#">ShareClasses</a> <a href="#">Segments</a></p> |

complexType **SingleFundType**

|                |  |
|----------------|--|
| <p>diagram</p> |  |
|----------------|--|

|          |  |
|----------|--|
| children | <a href="#">SingleFundStaticData</a> <a href="#">ShareClasses</a> <a href="#">Segments</a> |
| used by  | element <a href="#">FundType/SingleFund</a>  |

element **SingleFundType/SingleFundStaticData**

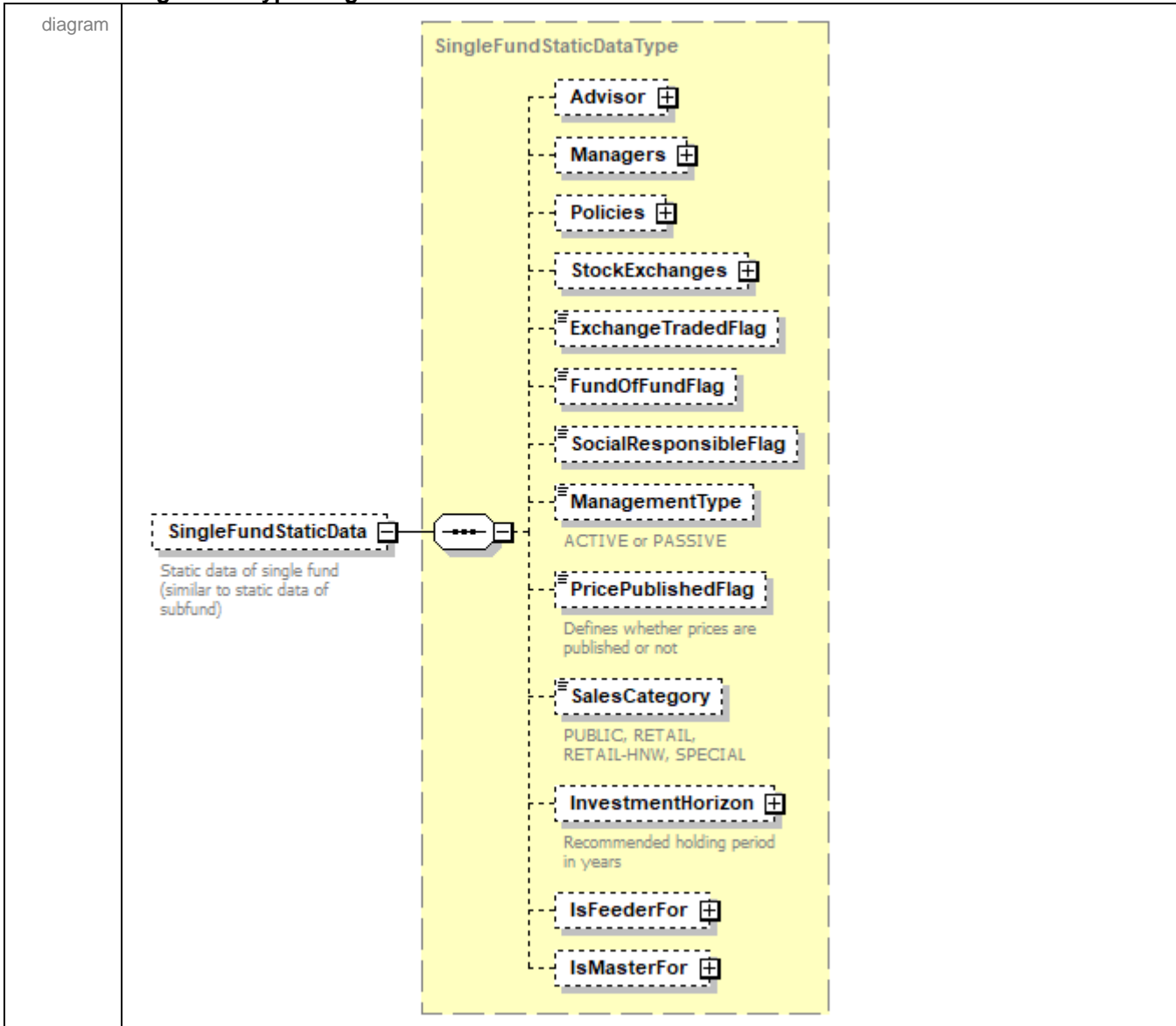

|            |  |
|------------|--|
| type       | <a href="#">SingleFundStaticDataType</a>   |
| properties | isRef 0<br>minOcc 0<br>maxOcc 1<br>content complex   |
| children   | <a href="#">Advisor</a> <a href="#">Managers</a> <a href="#">Policies</a> <a href="#">StockExchanges</a> <a href="#">ExchangeTradedFlag</a> <a href="#">FundOfFundFlag</a> <a href="#">SocialResponsibleFlag</a> <a href="#">ManagementType</a> <a href="#">PricePublishedFlag</a> <a href="#">SalesCategory</a> <a href="#">InvestmentHorizon</a> <a href="#">IsFeederFor</a> <a href="#">IsMasterFor</a> |
| annotation | documentation<br>Static data of single fund (similar to static data of subfund)  |

element **SingleFundType/ShareClasses**

|                   |   |
|-------------------|---|
| <p>diagram</p>    |  <p>UML class diagram showing a dashed box labeled <b>ShareClasses</b> containing a list of three dots, connected to a box labeled <b>ShareClass</b> with a multiplicity of <math>1..∞</math>. The <b>ShareClasses</b> box has the text "List of share classes of single fund" below it. The <b>ShareClass</b> box has the text "Static and dynamic data of a share class" below it.</p> |
| <p>properties</p> | <p>isRef 0<br/> minOcc 0<br/> maxOcc 1<br/> content complex</p>   |
| <p>children</p>   | <p><a href="#">ShareClass</a></p>   |
| <p>annotation</p> | <p>documentation<br/> List of share classes of single fund</p>  |



element **SingleFundType/ShareClasses/ShareClass**

diagram

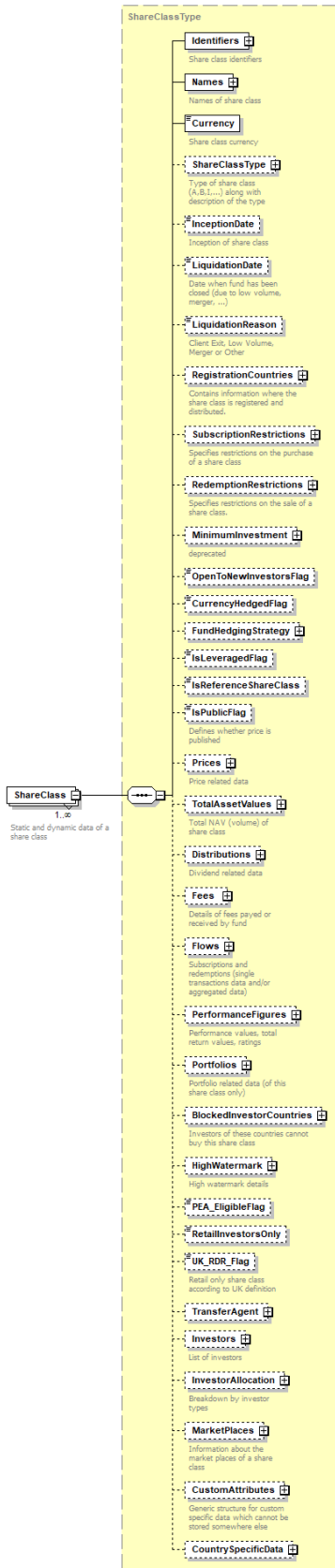

ShareClass  
1..\*  
Static and dynamic data of a share class

Identifiers

Share class identifiers

Names

Names of share class

Currency

Share class currency

ShareClassType

Type of share class (A,B,...) along with description of the type

InceptionDate

Inception of share class

LiquidationDate

Date when fund has been closed (Due to low volume, merger, ...)

LiquidationReason

Client Exit, Low Volume, Merger or Other

RegistrationCountries

Contains information where the share class is registered and distributed.

SubscriptionRestrictions

Specifies restrictions on the purchase of a share class

RedemptionRestrictions

Specifies restrictions on the sale of a share class.

MinimumInvestment

deprecated

OpenToNewInvestorsFlag

CurrencyHedgeFlag

FundHedgingStrategy

IsLeveragedFlag

IsReferenceShareClass

IsPublicFlag

Defines whether price is published

Prices

Price related data

TotalAssetValues

Total NAV (volume) of share class

Distributions

Dividend related data

Fees

Details of fees paid or received by fund

Flows

Subscriptions and redemptions (single transactions data and/or aggregated data)

PerformanceFigures

Performance values, total return values, ratings

Portfolios

Portfolio related data (of this share class only)

BlockedInvestorCountries

Investors of these countries cannot buy this share class

HighWatermark

High watermark details

PCA\_EligibleFlag

RetailInvestorsOnly

Retail only share class

UK\_RDR\_Flag

Retail only share class according to UK definition

TransferAgent

Investors

List of investors

InvestorAllocation

Breakdown by investor types

MarketPlaces

Information about the market places of a share class

CustomAttributes

Generic structure for custom specific data which cannot be stored somewhere else

CountrySpecificData

|            |  |
|------------|--|
| type       | <a href="#">ShareClassType</a>   |
| properties | isRef 0<br>minOcc 1<br>maxOcc unbounded<br>content complex   |
| children   | <a href="#">Identifiers</a> <a href="#">Names</a> <a href="#">Currency</a> <a href="#">ShareClassType</a> <a href="#">InceptionDate</a> <a href="#">LiquidationDate</a> <a href="#">LiquidationReason</a> <a href="#">RegistrationCountries</a> <a href="#">SubscriptionRestrictions</a> <a href="#">RedemptionRestrictions</a> <a href="#">MinimumInvestment</a> <a href="#">OpenToNewInvestorsFlag</a> <a href="#">CurrencyHedgedFlag</a> <a href="#">FundHedgingStrategy</a> <a href="#">IsLeveragedFlag</a> <a href="#">IsReferenceShareClass</a> <a href="#">IsPublicFlag</a> <a href="#">Prices</a> <a href="#">TotalAssetValues</a> <a href="#">Distributions</a> <a href="#">Fees</a> <a href="#">Flows</a> <a href="#">PerformanceFigures</a> <a href="#">Portfolios</a> <a href="#">BlockedInvestorCountries</a> <a href="#">HighWatermark</a> <a href="#">PEA</a> <a href="#">EligibleFlag</a> <a href="#">RetailInvestorsOnly</a> <a href="#">UK</a> <a href="#">RDR</a> <a href="#">Flag</a> <a href="#">TransferAgent</a> <a href="#">Investors</a> <a href="#">InvestorAllocation</a> <a href="#">MarketPlaces</a> <a href="#">CustomAttributes</a> <a href="#">CountrySpecificData</a> |
| annotation | documentation<br>Static and dynamic data of a share class  |

element **SingleFundType/Segments**

|            |   |
|------------|---|
| diagram    | <pre> classDiagram     class Segments     class Segment     Segments "1" -- "1..∞" Segment </pre> <p>Data related to segments/pockets of funds (typically managed by different fund managers)</p> |
| properties | isRef 0<br>minOcc 0<br>maxOcc 1<br>content complex  |
| children   | <a href="#">Segment</a>   |
| annotation | documentation<br>Data related to segments/pockets of funds (typically managed by different fund managers)   |

element **SingleFundType/Segments/Segment**

|                   |   |
|-------------------|---|
| <p>diagram</p>    | <p>The diagram illustrates the structure of the <b>SegmentType</b> element. It is a complex type containing several sub-elements:</p> <ul style="list-style-type: none"> <li><b>Identifiers</b>: Fund identifiers</li> <li><b>Name</b>: Name of segment</li> <li><b>Currency</b>: Currency of segment</li> <li><b>SegmentStaticData</b>: Inception, manager, description, ...</li> <li><b>SegmentDynamicData</b>: Total asset values, portfolio data</li> <li><b>ShareClasses</b>: List of share classes of segment</li> <li><b>Segments</b>: Data related to subsegments / subpockets of funds (typically managed by different fund managers)</li> </ul> <p>The <b>Segment</b> element is shown with a multiplicity of <b>1..∞</b> and is connected to the <b>SegmentType</b> container.</p> |
| <p>type</p>       | <p><a href="#">SegmentType</a></p>  |
| <p>properties</p> | <p>isRef 0<br/> minOcc 1<br/> maxOcc unbounded<br/> content complex</p>   |
| <p>children</p>   | <p><a href="#">Identifiers</a> <a href="#">Name</a> <a href="#">Currency</a> <a href="#">SegmentStaticData</a> <a href="#">SegmentDynamicData</a> <a href="#">ShareClasses</a> <a href="#">Segments</a></p>   |

complexType **SubfundType**

|                 |   |
|-----------------|---|
| <p>diagram</p>  | <pre> classDiagram     class SubfundType {         Identifiers         Names         Currency         SubfundStaticData         SubfundDynamicData         ShareClasses         Segments     }     </pre> <p><b>Identifiers</b> </p> <p>Identifiers of subfund</p> <p><b>Names</b> </p> <p>Names of subfund</p> <p><b>Currency</b> </p> <p>Currency of subfund</p> <p><b>SubfundStaticData</b> </p> <p>Static data of subfund<br/>(similar to static data of single fund)</p> <p><b>SubfundDynamicData</b> </p> <p>Total asset values, portfolio data</p> <p><b>ShareClasses</b> </p> <p>List of share classes of subfund</p> <p><b>Segments</b> </p> <p>Data related to segments/pockets of funds<br/>(typically managed by different fund managers)</p> |
| <p>children</p> | <p><a href="#">Identifiers</a> <a href="#">Names</a> <a href="#">Currency</a> <a href="#">SubfundStaticData</a> <a href="#">SubfundDynamicData</a> <a href="#">ShareClasses</a> <a href="#">Segments</a></p>  |
| <p>used by</p>  | <p>element <a href="#">FundType/Subfunds/Subfund</a></p>  |

element **SubfundType/Identifiers**

|                   |  |
|-------------------|--|
| <p>diagram</p>    |  |
| <p>type</p>       | <p><a href="#">IdentifiersType</a></p>   |
| <p>properties</p> | <p>isRef 0<br/>content complex</p>   |
| <p>children</p>   | <p><a href="#">ISIN</a> <a href="#">Bloomberg</a> <a href="#">CUSIP</a> <a href="#">GermanWKN</a> <a href="#">LEI</a> <a href="#">MexID</a> <a href="#">ReutersRIC</a> <a href="#">SEDOL</a> <a href="#">SwissValorenCode</a> <a href="#">SwiftBIC</a> <a href="#">OtherID</a></p> |

|            |   |
|------------|---|
| annotation | documentation<br>Identifiers of subfund |
|------------|---|

element **SubfundType/Names**

|            |  |
|------------|--|
| diagram    |  |
| type       | <a href="#">NamesType</a>  |
| properties | isRef 0<br>content complex   |
| children   | <a href="#">OfficialName</a> <a href="#">FullName</a> <a href="#">MarketingName</a> <a href="#">ShortName</a> <a href="#">PreviousName</a> <a href="#">DynLenNames</a> <a href="#">LanguageNames</a> |
| annotation | documentation<br>Names of subfund  |

element **SubfundType/Currency**

|            |                                     |
|------------|-------------------------------------|
| diagram    |                                     |
| type       | <a href="#">ISOCurrencyCodeType</a> |
| properties | isRef 0<br>content simple           |

|            |                     |          |            |
|------------|---------------------|----------|------------|
| facets     | Kind                | Value    | annotation |
|            | minLength           | 3        |            |
|            | maxLength           | 3        |            |
|            | pattern             | [A-Z]{3} |            |
| annotation | documentation       |          |            |
|            | Currency of subfund |          |            |



element **SubfundType/SubfundStaticData**

diagram

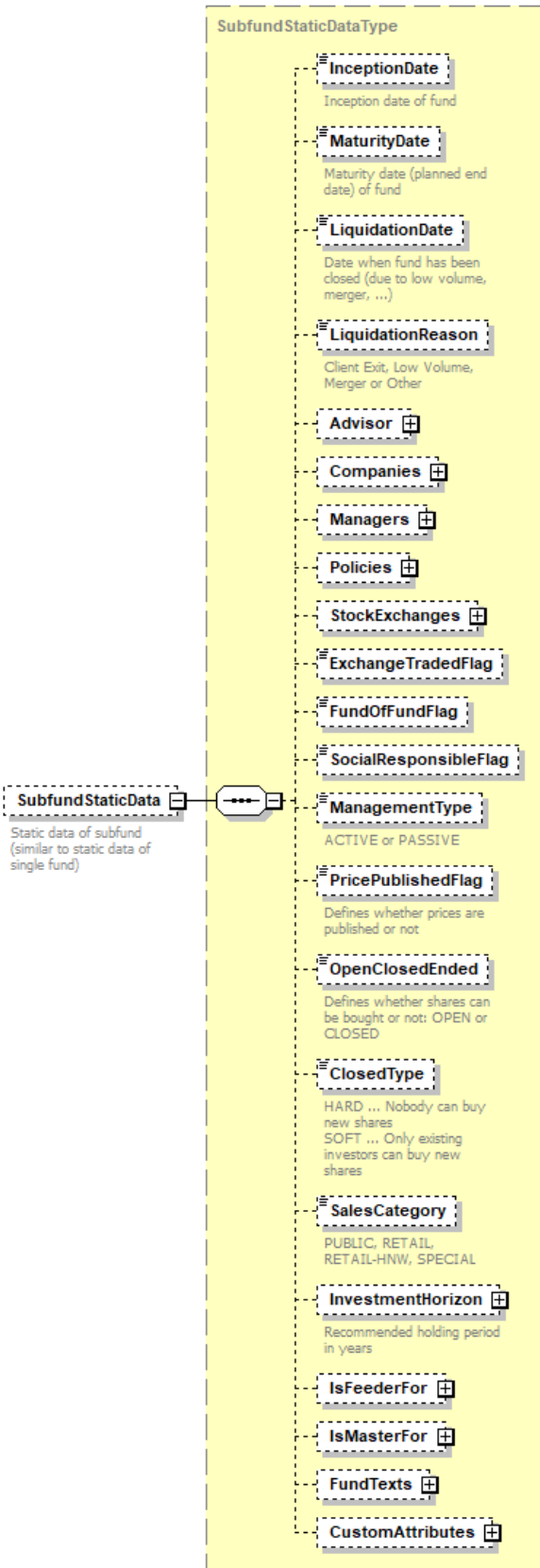

|            |   |
|------------|---|
| type       | <a href="#">SubfundStaticDataType</a>   |
| properties | isRef 0<br>minOcc 0<br>maxOcc 1<br>content complex  |
| children   | <a href="#">InceptionDate</a> <a href="#">MaturityDate</a> <a href="#">LiquidationDate</a> <a href="#">LiquidationReason</a> <a href="#">Advisor</a> <a href="#">Companies</a> <a href="#">Managers</a> <a href="#">Policies</a> <a href="#">StockExchanges</a> <a href="#">ExchangeTradedFlag</a> <a href="#">FundOfFundFlag</a> <a href="#">SocialResponsibleFlag</a> <a href="#">ManagementType</a> <a href="#">PricePublishedFlag</a> <a href="#">OpenClosedEnded</a> <a href="#">ClosedType</a> <a href="#">SalesCategory</a> <a href="#">InvestmentHorizon</a> <a href="#">IsFeederFor</a> <a href="#">IsMasterFor</a> <a href="#">FundTexts</a> <a href="#">CustomAttributes</a> |
| annotation | documentation<br>Static data of subfund (similar to static data of single fund)   |

element **SubfundType/SubfundDynamicData**

|            |  |
|------------|--|
| diagram    | <p>The diagram illustrates the structure of SubfundDynamicData. It is represented as a dashed box containing three sub-elements: TotalAssetValues, Portfolios, and Benchmarks. Each sub-element is also shown as a dashed box with a plus sign icon. TotalAssetValues is described as 'Total NAV (volume) of fund'. Portfolios is described as 'All portfolio related data (not to be used for umbrella structures)'. Benchmarks is described as 'Benchmark Data of fund'. A central connector symbol (a circle with three dots) is connected to each of the three sub-elements, indicating they are all contained within the main SubfundDynamicData element.</p> |
| type       | <a href="#">FundDynamicDataType</a>  |
| properties | isRef 0<br>minOcc 0<br>maxOcc 1<br>content complex   |
| children   | <a href="#">TotalAssetValues</a> <a href="#">Portfolios</a> <a href="#">Benchmarks</a>   |
| annotation | documentation<br>Total asset values, portfolio data  |

element **SubfundType/ShareClasses**

|            |  |
|------------|--|
| diagram    | <p>The diagram illustrates the structure of ShareClasses. It is represented as a dashed box containing a list of ShareClass elements. Each ShareClass element is shown as a solid box with a plus sign icon. A central connector symbol (a circle with three dots) is connected to the list of ShareClass elements, indicating they are all contained within the main ShareClasses element. The multiplicity '1..∞' is shown next to the ShareClass element, indicating that there can be one or more share classes.</p> |
| properties | isRef 0<br>minOcc 0<br>maxOcc 1<br>content complex   |
| children   | <a href="#">ShareClass</a>   |
| annotation | documentation<br>List of share classes of subfund  |

element **SubfundType/ShareClasses/ShareClass**

diagram

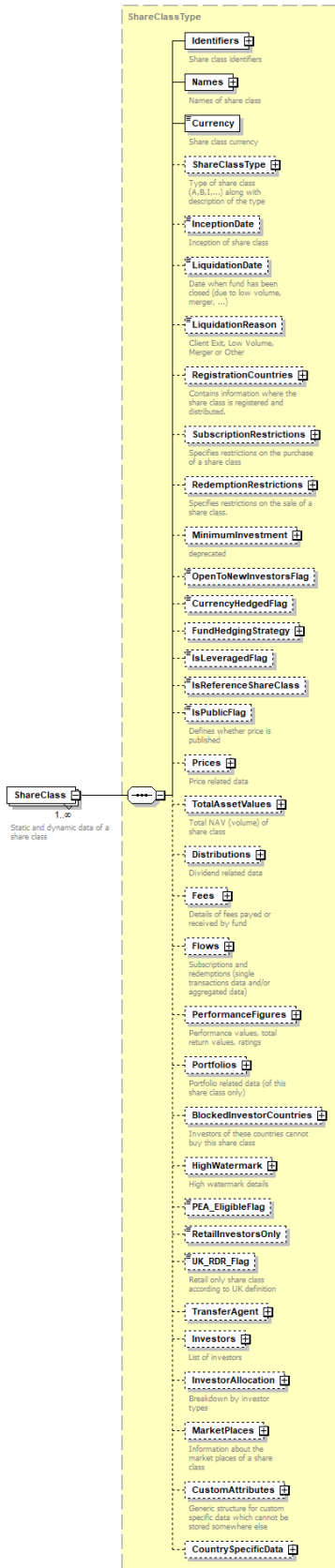

ShareClass 1..\*  
Static and dynamic data of a share class

Identifiers

Share class identifiers

Names

Names of share class

Currency

Share class currency

ShareClassType

Type of share class (A,B,...) along with description of the type

InceptionDate

Inception of share class

LiquidationDate

Date when fund has been closed (Due to low volume, merger, ...)

LiquidationReason

Client Exit, Low Volume, Merger or Other

RegistrationCountries

Contains information where the share class is registered and distributed.

SubscriptionRestrictions

Specifies restrictions on the purchase of a share class

RedemptionRestrictions

Specifies restrictions on the sale of a share class.

MinimumInvestment

deprecated

OpenToNewInvestorsFlag

CurrencyHedgeFlag

FundHedgingStrategy

IsLeveragedFlag

IsReferenceShareClass

IsPublicFlag

Defines whether price is published

Prices

Price related data

TotalAssetValues

Total NAV (volume) of share class

Distributions

Dividend related data

Fees

Details of fees paid or received by fund

Flows

Subscriptions and redemptions (single transactions data and/or aggregated data)

PerformanceFigures

Performance values, total return values, ratings

Portfolios

Portfolio related data (of this share class only)

BlockedInvestorCountries

Investors of these countries cannot buy this share class

HighWatermark

High watermark details

PCA\_EligibleFlag

RetailInvestorsOnly

Retail only share class according to UK definition

TransferAgent

Investors

List of investors

InvestorAllocation

Breakdown by investor types

MarketPlaces

Information about the market places of a share class

CustomAttributes

Generic structure for custom specific data which cannot be stored somewhere else

CountrySpecificData

|            |  |
|------------|--|
| type       | <a href="#">ShareClassType</a>   |
| properties | isRef 0<br>minOcc 1<br>maxOcc unbounded<br>content complex   |
| children   | <a href="#">Identifiers</a> <a href="#">Names</a> <a href="#">Currency</a> <a href="#">ShareClassType</a> <a href="#">InceptionDate</a> <a href="#">LiquidationDate</a> <a href="#">LiquidationReason</a> <a href="#">RegistrationCountries</a> <a href="#">SubscriptionRestrictions</a> <a href="#">RedemptionRestrictions</a> <a href="#">MinimumInvestment</a> <a href="#">OpenToNewInvestorsFlag</a> <a href="#">CurrencyHedgedFlag</a> <a href="#">FundHedgingStrategy</a> <a href="#">IsLeveragedFlag</a> <a href="#">IsReferenceShareClass</a> <a href="#">IsPublicFlag</a> <a href="#">Prices</a> <a href="#">TotalAssetValues</a> <a href="#">Distributions</a> <a href="#">Fees</a> <a href="#">Flows</a> <a href="#">PerformanceFigures</a> <a href="#">Portfolios</a> <a href="#">BlockedInvestorCountries</a> <a href="#">HighWatermark</a> <a href="#">PEA</a> <a href="#">EligibleFlag</a> <a href="#">RetailInvestorsOnly</a> <a href="#">UK</a> <a href="#">RDR</a> <a href="#">Flag</a> <a href="#">TransferAgent</a> <a href="#">Investors</a> <a href="#">InvestorAllocation</a> <a href="#">MarketPlaces</a> <a href="#">CustomAttributes</a> <a href="#">CountrySpecificData</a> |
| annotation | documentation<br>Static and dynamic data of a share class  |

element **SubfundType/Segments**

|            |   |
|------------|---|
| diagram    | <pre> classDiagram     class Segments {     }     class Segment {     }     Segments "1" -- "1..∞" Segment           </pre> <p>Data related to segments/pockets of funds (typically managed by different fund managers)</p> |
| properties | isRef 0<br>minOcc 0<br>maxOcc 1<br>content complex  |
| children   | <a href="#">Segment</a>   |
| annotation | documentation<br>Data related to segments/pockets of funds (typically managed by different fund managers)   |

element **SubfundType/Segments/Segment**

|                   |   |
|-------------------|---|
| <p>diagram</p>    | <p>The diagram shows a class <b>Segment</b> with a multiplicity of <math>1..∞</math> connected to a class <b>SegmentType</b>. <b>SegmentType</b> is a complex type containing several elements:</p> <ul style="list-style-type: none"> <li><b>Identifiers</b>: Fund identifiers</li> <li><b>Name</b>: Name of segment</li> <li><b>Currency</b>: Currency of segment</li> <li><b>SegmentStaticData</b>: Inception, manager, description, ...</li> <li><b>SegmentDynamicData</b>: Total asset values, portfolio data</li> <li><b>ShareClasses</b>: List of share classes of segment</li> <li><b>Segments</b>: Data related to subsegments / subpockets of funds (typically managed by different fund managers)</li> </ul> |
| <p>type</p>       | <p><a href="#">SegmentType</a></p>  |
| <p>properties</p> | <p>isRef 0<br/> minOcc 1<br/> maxOcc unbounded<br/> content complex</p>   |
| <p>children</p>   | <p><a href="#">Identifiers</a> <a href="#">Name</a> <a href="#">Currency</a> <a href="#">SegmentStaticData</a> <a href="#">SegmentDynamicData</a> <a href="#">ShareClasses</a> <a href="#">Segments</a></p>   |

complexType **AddressType**

|          |   |
|----------|---|
| diagram  |   |
| children | <a href="#">StreetName</a> <a href="#">StreetNumber</a> <a href="#">Building</a> <a href="#">CityName</a> <a href="#">CityCode</a> <a href="#">State</a> <a href="#">Country</a> <a href="#">Phone</a> <a href="#">Fax</a> <a href="#">Email</a> <a href="#">Homepage</a> |
| used by  | element <a href="#">CompanyType/Address</a>   |

element **AddressType/StreetName**

|            |   |
|------------|---|
| diagram    |   |
| type       | <a href="#">Text256Type</a>                       |
| properties | isRef 0<br>minOcc 0<br>maxOcc 1<br>content simple |
| facets     | Kind Value annotation<br>maxLength 256            |

element **AddressType/StreetNumber**

|            |   |
|------------|---|
| diagram    |   |
| type       | <a href="#">Text32Type</a>                        |
| properties | isRef 0<br>minOcc 0<br>maxOcc 1<br>content simple |
| facets     | Kind Value annotation<br>maxLength 32             |

element **AddressType/Building**

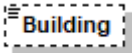
|            |   |
|------------|---|
| diagram    |  |
| type       | <a href="#">Text256Type</a>   |
| properties | isRef 0<br>minOcc 0<br>maxOcc 1<br>content simple                                 |
| facets     | Kind Value annotation<br>maxLength 256  |

element **AddressType/CityName**

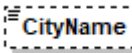
|            |   |
|------------|---|
| diagram    |  |
| type       | <a href="#">Text256Type</a>   |
| properties | isRef 0<br>minOcc 0<br>maxOcc 1<br>content simple                                 |
| facets     | Kind Value annotation<br>maxLength 256  |

element **AddressType/CityCode**

|            |   |
|------------|---|
| diagram    |  |
| type       | <a href="#">Text32Type</a>  |
| properties | isRef 0<br>minOcc 0<br>maxOcc 1<br>content simple                                   |
| facets     | Kind Value annotation<br>maxLength 32   |

element **AddressType/State**

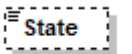
|            |   |
|------------|---|
| diagram    |  |
| type       | <a href="#">Text256Type</a>   |
| properties | isRef 0<br>minOcc 0<br>maxOcc 1<br>content simple                                   |
| facets     | Kind Value annotation<br>maxLength 256  |



element **AddressType/Country**

|            |   |
|------------|---|
| diagram    |  |
| type       | <a href="#">ISOCountryCodeType</a>  |
| properties | isRef 0<br>content simple   |
| facets     | Kind Value annotation<br>minLength 2<br>maxLength 2                               |

element **AddressType/Phone**

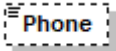
|            |   |
|------------|---|
| diagram    |  |
| type       | <a href="#">Text256Type</a>   |
| properties | isRef 0<br>minOcc 0<br>maxOcc 1<br>content simple                                 |
| facets     | Kind Value annotation<br>maxLength 256  |

element **AddressType/Fax**

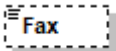
|            |   |
|------------|---|
| diagram    |  |
| type       | <a href="#">Text64Type</a>  |
| properties | isRef 0<br>minOcc 0<br>maxOcc 1<br>content simple                                   |
| facets     | Kind Value annotation<br>maxLength 64   |

element **AddressType/Email**

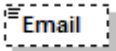
|            |  |
|------------|--|
| diagram    |                             |
| type       | <a href="#">EmailAddressType</a>   |
| properties | isRef 0<br>minOcc 0<br>maxOcc 1<br>content simple  |
| facets     | Kind Value annotation<br>pattern <code>[_\-\a-zA-Z0-9\.\+]+\@[a-zA-Z0-9](\.[\-\a-zA-Z0-9]*[a-zA-Z0-9])*</code> |

element **AddressType/Homepage**

|            |   |
|------------|---|
| diagram    |   |
| type       | <b>xs:anyURI</b>                                  |
| properties | isRef 0<br>minOcc 0<br>maxOcc 1<br>content simple |

complexType **AmountType**

|            |  |
|------------|--|
| diagram    |  |
| children   | <a href="#">Amount</a>   |
| used by    | elements <a href="#">CountrySpecificFundDataATType/OeNB/Distribution AUMType/GrossAssets</a><br><a href="#">ShareClassType/RedemptionRestrictions/MaxRedemptionAmount</a><br><a href="#">ShareClassType/SubscriptionRestrictions/MinRegularInvestmentAmount</a><br><a href="#">ShareClassType/SubscriptionRestrictions/MinSubscriptionAmount</a><br><a href="#">ShareClassType/SubscriptionRestrictions/MinSubscriptionAmountSubsequent</a><br><a href="#">TransactionType/OrderPrice OptionType/Quotation/QuotationAmount</a><br><a href="#">FutureType/Quotation/QuotationAmount WarrantType/Quotation/QuotationAmount</a><br><a href="#">CountrySpecificFundDataATType/OeNB/Redemption OptionType/StrikePrice WarrantType/StrikePrice</a><br><a href="#">CountrySpecificFundDataATType/OeNB/Subscription OptionType/Tick/TickValue</a><br><a href="#">FutureType/Tick/TickValue WarrantType/Tick/TickValue</a><br><a href="#">CountrySpecificFundDataATType/OeNB/TotalNetAssetPreviousMonth AUMType/TotalNetAssets</a><br><a href="#">CountrySpecificFundDataATType/PKG2012/Details/Position/Value</a><br><a href="#">CountrySpecificFundDataATType/PKG2012/Summary/Position/Value</a><br><a href="#">BenchmarkDynamicDataType/Values/Value/Value</a><br><a href="#">BenchmarkDynamicDataType/Values/Value/Components/Component/Value</a><br><a href="#">FundStaticDataType/OnngoingCosts/OnngoingCost/YearlyAmount</a> |
| annotation | documentation<br>Amount in different currencies<br>documentation<br>Betrag in verschiedenen Waehrungen   |

element **AmountType/Amount**

|            |   |
|------------|---|
| diagram    |   |
| type       | extension of <b>xs:decimal</b>  |
| properties | isRef 0<br>minOcc 1<br>maxOcc unbounded<br>content complex  |
| annotation | documentation<br>Amounts in currency as defined in attribute<br>documentation<br>Betrag in frei waehlbarer Waehrung |

attribute **AmountType/Amount/@ccy**

|            |   |
|------------|---|
| type       | <a href="#">ISOCurrencyCodeType</a>                                     |
| properties | isRef 0<br>use required   |
| facets     | Kind Value annotation<br>minLength 3<br>maxLength 3<br>pattern [A-Z]{3} |

complexType **AttributesType**

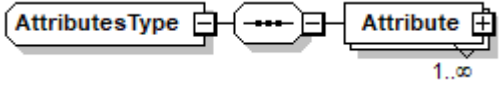
|          |  |
|----------|--|
| diagram  |   |
| children | <a href="#">Attribute</a>  |
| used by  | elements <a href="#">DocumentType/Attributes</a> <a href="#">SegmentStaticDataType/CustomAttributes</a> <a href="#">FundStaticDataType/CustomAttributes</a> <a href="#">SubfundStaticDataType/CustomAttributes</a> <a href="#">PositionType/CustomAttributes</a> <a href="#">TransactionType/CustomAttributes</a> <a href="#">ShareClassType/CustomAttributes</a> <a href="#">AssetType/CustomAttributes</a> |

element **AttributesType/Attribute**

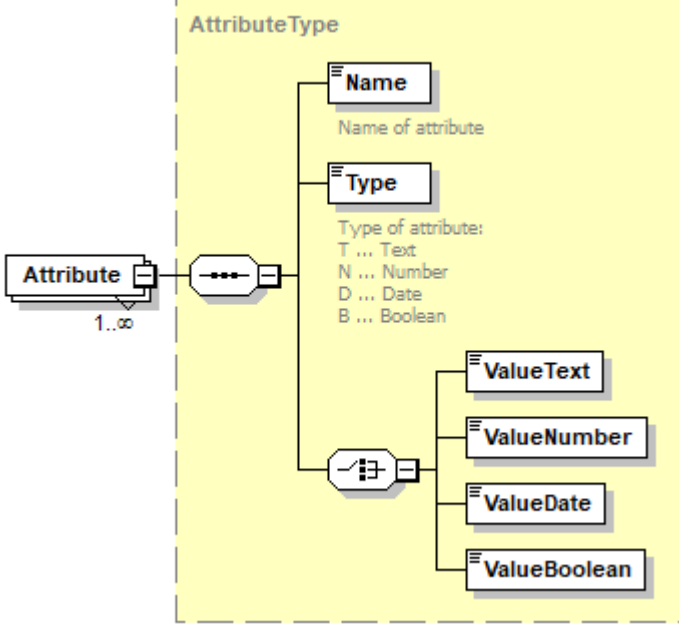
|            |  |
|------------|--|
| diagram    |    |
| type       | <a href="#">AttributeType</a>  |
| properties | isRef 0<br>minOcc 1<br>maxOcc unbounded<br>content complex   |
| children   | <a href="#">Name</a> <a href="#">Type</a> <a href="#">ValueText</a> <a href="#">ValueNumber</a> <a href="#">ValueDate</a> <a href="#">ValueBoolean</a> |

### complexType AttributeType

|          |  |
|----------|--|
| diagram  |  |
| children | <a href="#">Name</a> <a href="#">Type</a> <a href="#">ValueText</a> <a href="#">ValueNumber</a> <a href="#">ValueDate</a> <a href="#">ValueBoolean</a> |
| used by  | element <a href="#">AttributesType/Attribute</a>   |

### element AttributeType/Name

|            |  |
|------------|--|
| diagram    |  |
| type       | <a href="#">Text256Type</a>            |
| properties | isRef 0<br>content simple              |
| facets     | Kind Value annotation<br>maxLength 256 |
| annotation | documentation<br>Name of attribute     |

### element AttributeType/Type

|            |   |
|------------|---|
| diagram    |   |
| type       | restriction of <b>xs:string</b>   |
| properties | isRef 0<br>content simple   |
| facets     | Kind Value annotation<br>length 1   |
| annotation | documentation<br>Type of attribute:<br>T ... Text<br>N ... Number<br>D ... Date |

|  |               |
|--|---------------|
|  | B ... Boolean |
|--|---------------|

element **AttributeType/ValueText**

|            |   |
|------------|---|
| diagram    |  |
| type       | <b>xs:string</b>  |
| properties | isRef 0<br>content simple   |

element **AttributeType/ValueNumber**

|            |   |
|------------|---|
| diagram    |  |
| type       | <b>xs:decimal</b>   |
| properties | isRef 0<br>content simple   |

element **AttributeType/ValueDate**

|            |   |
|------------|---|
| diagram    |  |
| type       | <b>xs:date</b>  |
| properties | isRef 0<br>content simple   |

element **AttributeType/ValueBoolean**

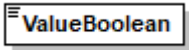
|            |   |
|------------|---|
| diagram    |  |
| type       | <b>xs:boolean</b>   |
| properties | isRef 0<br>content simple   |

### complexType AUMType

|            |  |
|------------|--|
| diagram    | <p><b>AUMType</b><br/>Assets under Management Type</p> <p><b>Date</b><br/>Date for which the information is valid</p> <p><b>Currency</b><br/>Currency</p> <p><b>TotalNetAssets</b><br/>The amount of net assets of an investment vehicle calculated as the sum of all portfolio holdings including liabilities, which one has to subtract</p> <p><b>GrossAssets</b><br/>Gross assets of closed ended funds and open material assets funds, which means the still existing retail and special real estate funds of the "old" world. Real investment without taking into account liabilities</p> |
| children   | <a href="#">Date</a> <a href="#">Currency</a> <a href="#">TotalNetAssets</a> <a href="#">GrossAssets</a>   |
| annotation | documentation<br>Assets under Management Type  |

### element AUMType/Date

|            |  |
|------------|--|
| diagram    | <p><b>Date</b><br/>Date for which the information is valid</p> |
| type       | <b>xs:date</b>   |
| properties | isRef 0<br>content simple                                      |
| annotation | documentation<br>Date for which the information is valid       |

### element AUMType/Currency

|            |   |
|------------|---|
| diagram    | <p><b>Currency</b><br/>Currency</p>                                     |
| type       | <a href="#">ISOCurrencyCodeType</a>                                     |
| properties | isRef 0<br>minOcc 0<br>maxOcc 1<br>content simple                       |
| facets     | Kind Value annotation<br>minLength 3<br>maxLength 3<br>pattern [A-Z]{3} |

|            |                           |
|------------|---------------------------|
| annotation | documentation<br>Currency |
|------------|---------------------------|

element **AUMType/TotalNetAssets**

|            |   |
|------------|---|
| diagram    | <p>The amount of net assets of an investment vehicle calculated as the sum of all portfolio holdings including liabilities, which one has to subtract</p>           |
| type       | <a href="#">AmountType</a>  |
| properties | isRef 0<br>minOcc 0<br>maxOcc 1<br>content complex  |
| children   | <a href="#">Amount</a>  |
| annotation | documentation<br>The amount of net assets of an investment vehicle calculated as the sum of all portfolio holdings including liabilities, which one has to subtract |

element **AUMType/GrossAssets**

|            |   |
|------------|---|
| diagram    | <p>Gross assets of closed ended funds and open material assets funds, which means the still existing retail and special real estate funds of the "old" world. Real investment without taking into account liabilities</p>           |
| type       | <a href="#">AmountType</a>  |
| properties | isRef 0<br>minOcc 0<br>maxOcc 1<br>content complex  |
| children   | <a href="#">Amount</a>  |
| annotation | documentation<br>Gross assets of closed ended funds and open material assets funds, which means the still existing retail and special real estate funds of the "old" world. Real investment without taking into account liabilities |

complexType **ClassificationsType**

|          |                                |
|----------|--------------------------------|
| diagram  |                                |
| children | <a href="#">Classification</a> |

|         |   |
|---------|---|
| used by | elements <a href="#">FundStaticDataType/Classifications</a> <a href="#">AssetType/Classifications</a> |
|---------|---|

element **ClassificationsType/Classification**

|            |   |
|------------|---|
| diagram    |   |
| type       | <a href="#">ClassificationType</a>  |
| properties | isRef 0<br>minOcc 1<br>maxOcc unbounded<br>content complex  |
| children   | <a href="#">ListedGroup</a> <a href="#">UnlistedGroup</a> <a href="#">Type</a> <a href="#">Language</a> <a href="#">Value</a> |

complexType **ClassificationType**

|          |   |
|----------|---|
| diagram  |   |
| children | <a href="#">ListedGroup</a> <a href="#">UnlistedGroup</a> <a href="#">Type</a> <a href="#">Language</a> <a href="#">Value</a> |
| used by  | element <a href="#">ClassificationsType/Classification</a>  |

element **ClassificationType/ListedGroup**

|            |   |
|------------|---|
| diagram    |   |
| type       | restriction of <a href="#">Text64Type</a> |
| properties | isRef 0<br>content simple                 |



|        |                   |             |            |
|--------|-------------------|-------------|------------|
| facets | Kind<br>maxLength | Value<br>64 | annotation |
|--------|-------------------|-------------|------------|

element **ClassificationType/UnlistedGroup**

|            |   |             |                |
|------------|---|-------------|----------------|
| diagram    |  |             |                |
| type       | <a href="#">Text64Type</a>  |             |                |
| properties | isRef   | 0           | content simple |
| facets     | Kind<br>maxLength   | Value<br>64 | annotation     |

element **ClassificationType/Type**

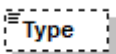
|            |   |             |  |
|------------|---|-------------|--|
| diagram    |  |             |  |
| type       | <a href="#">Text64Type</a>  |             |  |
| properties | isRef   | 0           | minOcc 0<br>maxOcc 1<br>content simple |
| facets     | Kind<br>maxLength   | Value<br>64 | annotation                             |

element **ClassificationType/Language**

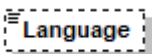
|            |   |   |  |
|------------|---|---|--|
| diagram    |  |   |  |
| type       | xs:language   |   |  |
| properties | isRef   | 0 | minOcc 0<br>maxOcc 1<br>content simple |

element **ClassificationType/Value**

|            |   |              |   |
|------------|---|--------------|---|
| diagram    |  |              |   |
| type       | extension of <a href="#">Text256Type</a>  |              |   |
| properties | isRef   | 0            | minOcc 1<br>maxOcc unbounded<br>content complex |
| facets     | Kind<br>maxLength   | Value<br>256 | annotation                                      |

attribute **ClassificationType/Value/@level**

|            |                           |
|------------|---------------------------|
| type       | <b>xs:positiveInteger</b> |
| properties | isRef 0                   |

complexType **CompanyType**

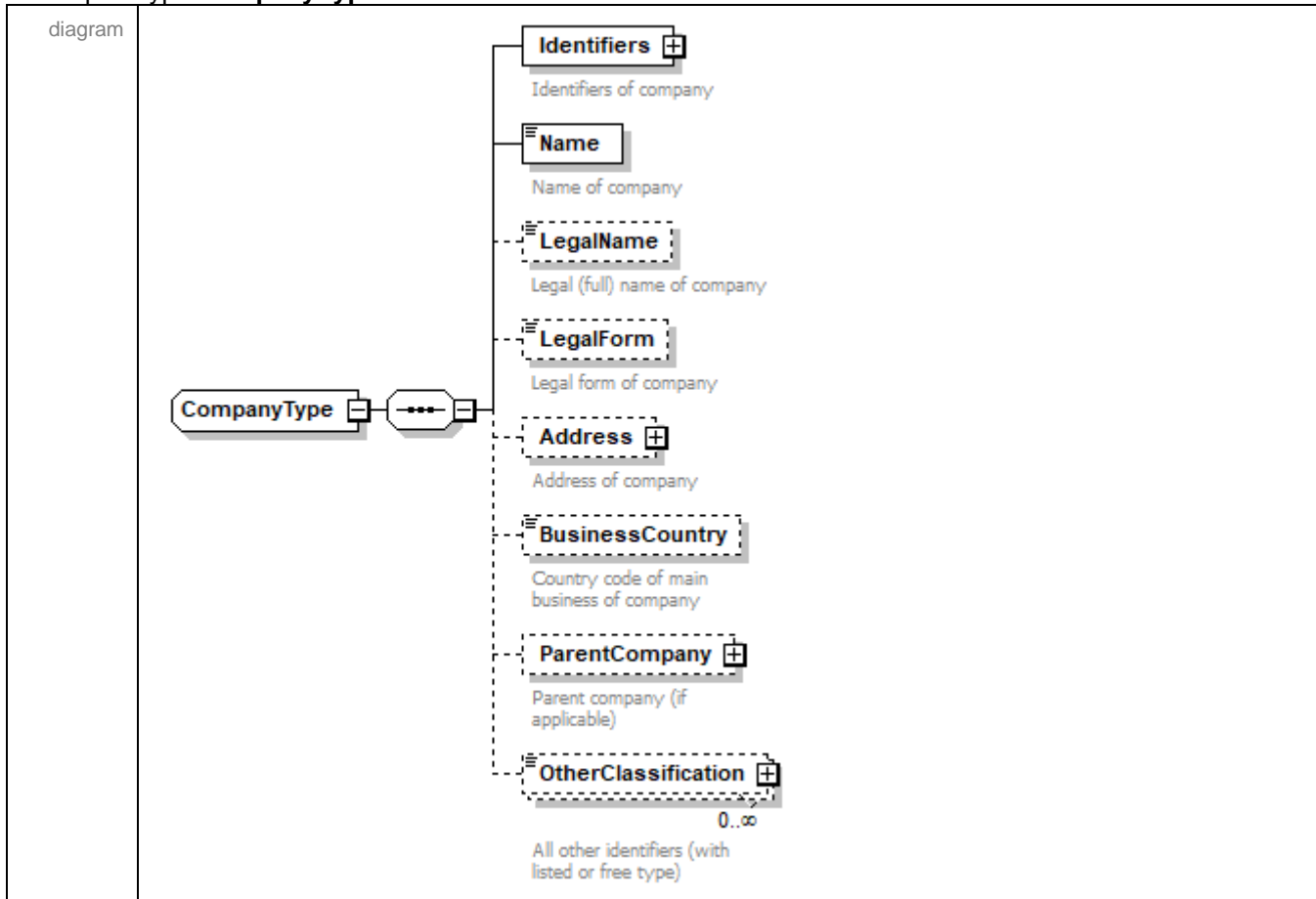

children [Identifiers](#) [Name](#) [LegalName](#) [LegalForm](#) [Address](#) [BusinessCountry](#) [ParentCompany](#) [OtherClassification](#)

used by

elements [FundStaticDataType/Administrator](#) [SubfundStaticDataType/Advisor](#) [SingleFundStaticDataType/Advisor](#) [FundStaticDataType/Auditor](#) [AssetMgmtCompanyDynDataType/AssetMgmtCompanyDynDataSet/Company](#) [PrivateEquityType/Company](#) [FixedTimeDepositType/Counterparty](#) [AccountType/Counterparty](#) [SwapType/Counterparty](#) [TransactionType/Counterparty](#) [ForeignExchangeTradeType/Counterparty](#) [FutureType/Counterparty](#) [OptionType/Counterparty](#) [CallCapitalType/Counterparty](#) [ReposType/Counterparty](#) [LoanType/Counterparty](#) [FeeType/Counterparty](#) [WarrantType/Counterparty](#) [FundStaticDataType/Custodian](#) [FundCompanyType/Details](#) [SubfundCompanyType/Details](#) [BondType/Guarantor](#) [FundStaticDataType/InvestmentCompany](#) [AssetDetailsType/Right/Issuer](#) [EquityType/Issuer](#) [BondType/Issuer](#) [REITType/Issuer](#) [ShareClassDetailsType/Issuer](#) [WarrantType/Issuer](#) [OptionType/Issuer](#) [CertificateType/Issuer](#) [CommercialPaperType/Issuer](#) [SingleFundStaticDataType/Managers/Manager](#) [SubfundStaticDataType/Managers/Manager](#) [SegmentStaticDataType/Manager](#) [CompanyType/ParentCompany](#) [AssetType/RealEstateCompany](#) [IndexType/SourceCompany](#) [ShareClassType/TransferAgent](#) [RatingType/UnlistedAgency](#) [BenchmarkProviderCompany](#)

complexType

element **CompanyType/Identifiers**

diagram

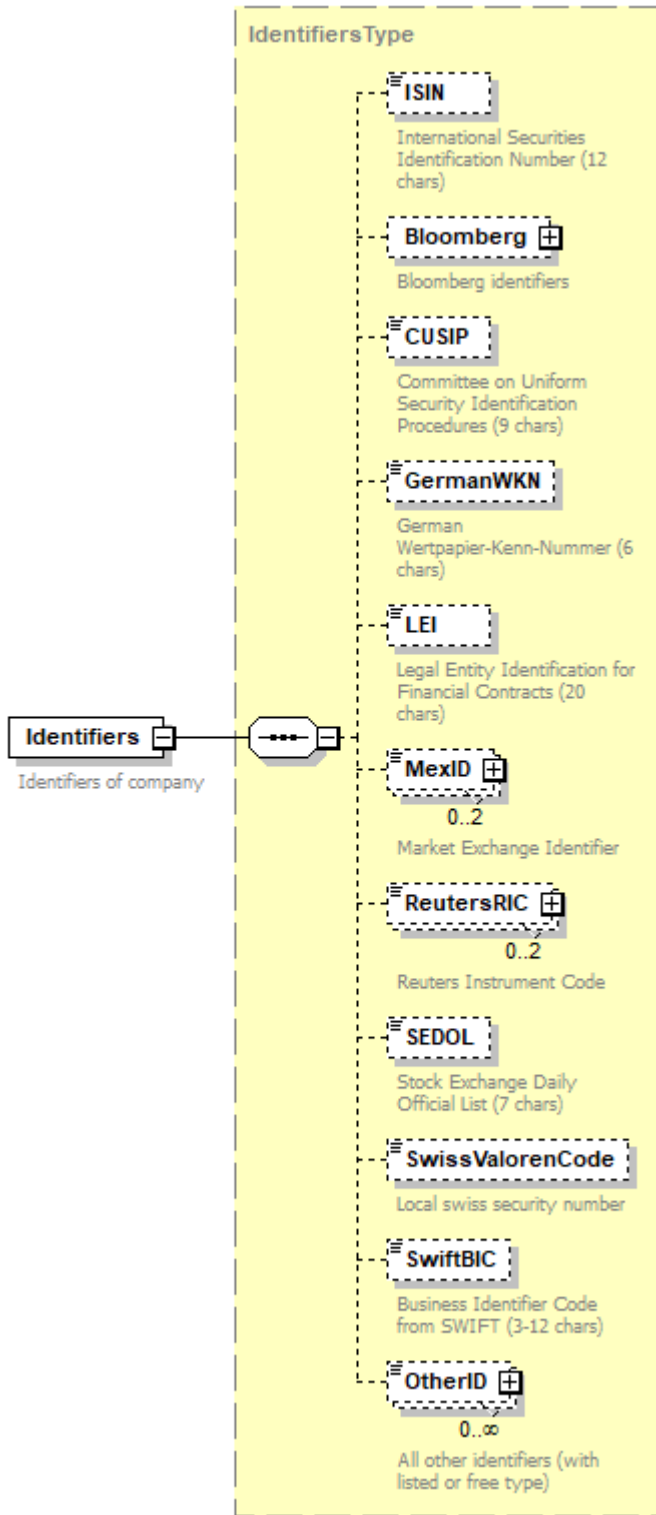

|            |   |
|------------|---|
| type       | <a href="#">IdentifiersType</a>   |
| properties | isRef 0<br>content complex  |
| children   | <a href="#">ISIN</a> <a href="#">Bloomberg</a> <a href="#">CUSIP</a> <a href="#">GermanWKN</a> <a href="#">LEI</a> <a href="#">MexID</a> <a href="#">ReutersRIC</a> <a href="#">SEDOL</a> <a href="#">SwissValorenCode</a> <a href="#">SwiftBIC</a> <a href="#">OtherID</a> |

|            |   |
|------------|---|
| annotation | documentation<br>Identifiers of company |
|------------|---|

### element **CompanyType/Name**

|            |   |
|------------|---|
| diagram    |  |
| type       | <a href="#">Text500Type</a>   |
| properties | isRef 0<br>content simple   |
| facets     | Kind Value annotation<br>maxLength 500  |
| annotation | documentation<br>Name of company  |

### element **CompanyType/LegalName**

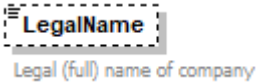
|            |   |
|------------|---|
| diagram    |  |
| type       | <a href="#">Text500Type</a>   |
| properties | isRef 0<br>minOcc 0<br>maxOcc 1<br>content simple                                 |
| facets     | Kind Value annotation<br>maxLength 500  |
| annotation | documentation<br>Legal (full) name of company                                     |

### element **CompanyType/LegalForm**

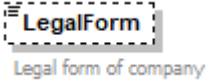
|            |   |
|------------|---|
| diagram    |  |
| type       | <a href="#">Text256Type</a>   |
| properties | isRef 0<br>minOcc 0<br>maxOcc 1<br>content simple                                   |
| facets     | Kind Value annotation<br>maxLength 256  |
| annotation | documentation<br>Legal form of company  |

element **CompanyType/Address**

|            |   |
|------------|---|
| diagram    |   |
| type       | <a href="#">AddressType</a>   |
| properties | isRef 0<br>minOcc 0<br>maxOcc 1<br>content complex  |
| children   | <a href="#">StreetName</a> <a href="#">StreetNumber</a> <a href="#">Building</a> <a href="#">CityName</a> <a href="#">CityCode</a> <a href="#">State</a> <a href="#">Country</a> <a href="#">Phone</a> <a href="#">Fax</a> <a href="#">Email</a> <a href="#">Homepage</a> |
| annotation | documentation<br>Address of company   |

element **CompanyType/BusinessCountry**

|            |   |
|------------|---|
| diagram    |   |
| type       | <a href="#">ISOCountryCodeType</a>                        |
| properties | isRef 0<br>minOcc 0<br>maxOcc 1<br>content simple         |
| facets     | Kind Value annotation<br>minLength 2<br>maxLength 2       |
| annotation | documentation<br>Country code of main business of company |

element **CompanyType/ParentCompany**

|                   |   |
|-------------------|---|
| <p>diagram</p>    |   |
| <p>type</p>       | <p><a href="#">CompanyType</a></p>  |
| <p>properties</p> | <p>isRef 0<br/>minOcc 0<br/>maxOcc 1<br/>content complex</p>  |
| <p>children</p>   | <p><a href="#">Identifiers</a> <a href="#">Name</a> <a href="#">LegalName</a> <a href="#">LegalForm</a> <a href="#">Address</a> <a href="#">BusinessCountry</a> <a href="#">ParentCompany</a> <a href="#">OtherClassification</a></p> |
| <p>annotation</p> | <p>documentation<br/>Parent company (if applicable)</p>   |

element **CompanyType/OtherClassification**

|                |                                      |
|----------------|--------------------------------------|
| <p>diagram</p> |                                      |
| <p>type</p>    | <p>extension of <b>xs:string</b></p> |

|            |   |
|------------|---|
| properties | isRef 0<br>minOcc 0<br>maxOcc unbounded<br>content complex        |
| annotation | documentation<br>All other identifiers (with listed or free type) |

attribute **CompanyType/OtherClassification/@ListedType**

|            |   |
|------------|---|
| type       | <a href="#">CompanyListedClassificationType</a> |
| properties | isRef 0   |

attribute **CompanyType/OtherClassification/@FreeType**

| type       | restriction of <b>xs:string</b>  |            |       |            |           |     |  |
|------------|--|------------|-------|------------|-----------|-----|--|
| properties | isRef 0  |            |       |            |           |     |  |
| facets     | <table border="1"> <thead> <tr> <th>Kind</th> <th>Value</th> <th>annotation</th> </tr> </thead> <tbody> <tr> <td>maxLength</td> <td>100</td> <td></td> </tr> </tbody> </table> | Kind       | Value | annotation | maxLength | 100 |  |
| Kind       | Value  | annotation |       |            |           |     |  |
| maxLength  | 100  |            |       |            |           |     |  |

complexType **DataSupplierType**

|          |   |
|----------|---|
| diagram  |   |
| children | <a href="#">SystemCountry</a> <a href="#">Short</a> <a href="#">Name</a> <a href="#">Type</a> <a href="#">Contact</a>   |
| used by  | <p>elements</p> <p><a href="#">DocumentType/DataSupplier</a> <a href="#">ControlDataType/DataSupplier</a> <a href="#">FundType/DataSupplier</a><br/> <a href="#">SolvencyIIPortfolioType_V6/DataSupplier</a> <a href="#">SolvencyIIPortfolioType/DataSupplier</a><br/> <a href="#">SolvencyIIPortfolioType_V5/DataSupplier</a> <a href="#">AssetType/DataSupplier</a> <a href="#">EMIR_ReportType/DataSupplier</a><br/> <a href="#">EMT_V4_FinancialInstrumentType/DataSupplier</a> <a href="#">EMT_V41_FinancialInstrumentType/DataSupplier</a><br/> <a href="#">EMTFinancialInstrumentType/DataSupplier</a> <a href="#">EMT_V3_FinancialInstrumentType/DataSupplier</a><br/> <a href="#">KIIDType/DataSupplier</a> <a href="#">PRIIPS_ReportType/DataSupplier</a> <a href="#">CEPTV2PerformanceType/DataSupplier</a><br/> <a href="#">CEPTV2HistoryType/DataSupplier</a> <a href="#">PRIIPSType_V20/EPTV2/DataSupplier</a> <a href="#">EFTReportType/DataSupplier</a><br/> <a href="#">CountrySpecificShareClassDataATTType/OeKBStammdatenblatt/Verwaltungsgesellschaft</a></p> |

element **DataSupplierType/SystemCountry**

|            |  |
|------------|--|
| diagram    |  |
| type       | <a href="#">ISOCountryCodeType</a>   |
| properties | isRef 0<br>content simple  |
| facets     | Kind Value annotation<br>minLength 2<br>maxLength 2  |
| annotation | documentation<br>Country of authority defining the list of valid data suppliers (e.g. AT, DE, ...) |

element **DataSupplierType/Short**

|            |  |
|------------|--|
| diagram    |  |
| type       | <a href="#">Text64Type</a>                             |
| properties | isRef 0<br>content simple                              |
| facets     | Kind Value annotation<br>maxLength 64                  |
| annotation | documentation<br>Code of supplier (unique per country) |

element **DataSupplierType/Name**

|            |  |
|------------|--|
| diagram    |  |
| type       | <a href="#">Text256Type</a>            |
| properties | isRef 0<br>content simple              |
| facets     | Kind Value annotation<br>maxLength 256 |
| annotation | documentation<br>Name of data supplier |

element **DataSupplierType/Type**

|            |                            |
|------------|----------------------------|
| diagram    |                            |
| type       | <a href="#">Text64Type</a> |
| properties | isRef 0<br>content simple  |
| facets     | Kind Value annotation      |



|            |   |
|------------|---|
|            | maxLength 64  |
| annotation | documentation<br>Type of data supplier (e.g. IC, CB, NB, Vendor, ...) |

**element DataSupplierType/Contact**

|            |  |
|------------|--|
| diagram    | <p>Contact details (name, phone, email)</p>                      |
| properties | isRef 0<br>minOcc 0<br>maxOcc 1<br>content complex               |
| children   | <a href="#">Name</a> <a href="#">Phone</a> <a href="#">Email</a> |
| annotation | documentation<br>Contact details (name, phone, email)            |

**element DataSupplierType/Contact/Name**

|            |   |
|------------|---|
| diagram    |   |
| type       | <a href="#">Text256Type</a>                       |
| properties | isRef 0<br>minOcc 0<br>maxOcc 1<br>content simple |
| facets     | Kind Value annotation<br>maxLength 256            |

**element DataSupplierType/Contact/Phone**

|            |   |
|------------|---|
| diagram    |   |
| type       | <a href="#">Text64Type</a>                        |
| properties | isRef 0<br>minOcc 0<br>maxOcc 1<br>content simple |
| facets     | Kind Value annotation<br>maxLength 64             |

**element DataSupplierType/Contact/Email**

|            |                                  |
|------------|----------------------------------|
| diagram    |                                  |
| type       | <a href="#">EmailAddressType</a> |
| properties | isRef 0<br>minOcc 0              |

|        |  |  |
|--------|--|--|
|        | maxOcc 1<br>content simple   |  |
| facets | Kind Value annotation<br>pattern [_\-a-zA-Z0-9\.\+]+\@[a-zA-Z0-9](\.[^\-a-zA-Z0-9]*[a-zA-Z0-9])* |  |

### complexType DayMonthType

|          |   |  |
|----------|---|--|
| diagram  |   |  |
| children | <a href="#">Day</a> <a href="#">Month</a> |  |
| used by  | elements                                  | <a href="#">CountrySpecificShareClassDataATType/OeKBStammdatenblatt/Ausschueittungsdatum</a><br><a href="#">FundStaticDataType/EndOfFiscalYear</a><br><a href="#">CountrySpecificShareClassDataATType/OeKBStammdatenblatt/GeschaeftsjahrBeginn</a><br><a href="#">CountrySpecificShareClassDataATType/OeKBStammdatenblatt/GeschaeftsjahrEnde</a><br><a href="#">FundStaticDataType/StartOfFiscalYear</a> |

### element DayMonthType/Day

|            |  |                      |
|------------|--|----------------------|
| diagram    |  |                      |
| type       | restriction of <b>xs:positiveInteger</b>                   |                      |
| properties | isRef 0<br>content simple                                  |                      |
| facets     | Kind Value annotation<br>minInclusive 1<br>maxInclusive 31 |                      |
| annotation | documentation  | Day between 1 and 31 |

### element DayMonthType/Month

|            |  |                        |
|------------|--|------------------------|
| diagram    |  |                        |
| type       | restriction of <b>xs:positiveInteger</b>                   |                        |
| properties | isRef 0<br>content simple                                  |                        |
| facets     | Kind Value annotation<br>minInclusive 1<br>maxInclusive 12 |                        |
| annotation | documentation  | Month between 1 and 12 |

### complexType DynLenNamesType

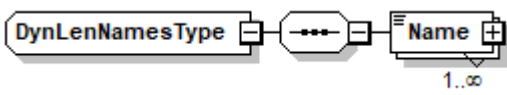
|          |   |
|----------|---|
| diagram  |  |
| children | <a href="#">Name</a>  |
| used by  | element <a href="#">NamesType/DynLenNames</a>                                     |

### element DynLenNamesType/Name

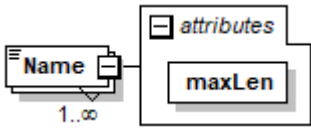
|            |   |
|------------|---|
| diagram    |  |
| type       | extension of <b>xs:string</b>   |
| properties | isRef 0<br>minOcc 1<br>maxOcc unbounded<br>content complex                        |

### attribute DynLenNamesType/Name/@maxLen

|            |                           |
|------------|---------------------------|
| type       | <b>xs:positiveInteger</b> |
| properties | isRef 0<br>use required   |

### complexType FundAmountType

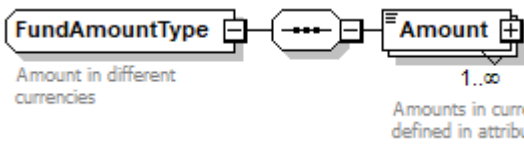
|          |  |
|----------|--|
| diagram  |   |
| children | <a href="#">Amount</a>   |
| used by  | elements <a href="#">PositionType/RealEstate/AncillaryCosts/Accrued</a> <a href="#">FeePeriodDataType/Values/ActualFeeAmount</a> <a href="#">TransactionType/AgreedPrice</a> <a href="#">HighWatermarkType/Amount</a> <a href="#">PositionType/AveragePurchasePrice</a> <a href="#">FeePeriodDataType/Values/CalculationBasis/BasisValue</a> <a href="#">PositionType/ShareClass/BookRate</a> <a href="#">PositionType/Equity/BookRate</a> <a href="#">PositionType/Bond/BookRate</a> <a href="#">PositionType/Warrant/BookRate</a> <a href="#">PositionType/Option/BookRate</a> <a href="#">PositionType/Future/BookRate</a> <a href="#">TransactionType/CapitalGainsTaxPerShare</a> <a href="#">PositionType/CapitalYieldsTaxClaim</a> <a href="#">EarningType/FundDistribution/CapitalYieldsTaxOverallValue</a> <a href="#">EarningType/FundDistribution/CapitalYieldsTaxUnitValue</a> <a href="#">EarningType/Coupon/CapitalYieldsTaxValue</a> <a href="#">TransactionType/Bonds/CapitalYieldsTaxValue</a> <a href="#">TransactionType/Bonds/CapitalYieldsTaxZeroValue</a> <a href="#">TransactionType/CleanPrice</a> <a href="#">PositionType/CallMoney/CollateralValue</a> <a href="#">PositionType/Bond/CollateralValue</a> <a href="#">TransactionType/CorporateAction/to/CostValue</a> <a href="#">TransactionType/CorporateAction/from/CostValue</a> <a href="#">PositionType/CommercialPaper/DirtyPrice</a> <a href="#">PositionType/Bond/DirtyPrice</a> <a href="#">TransactionType/DirtyPrice</a> <a href="#">TransactionType/DirtyValue</a> <a href="#">EarningType/Dividend/DividendGrossValue</a> <a href="#">EarningType/Dividend/DividendNetValue</a> <a href="#">EarningType/Dividend/DividendPerUnitValue</a> <a href="#">PositionType/Equity/DividendsDue</a> <a href="#">PositionType/REIT/DividendsDue</a> <a href="#">PositionType/ShareClass/DividendsDue</a> <a href="#">TransactionType/Bonds/EntryConditionalInflationaryAdjustment</a> <a href="#">EarningType/EntryValue</a> <a href="#">TransactionType/CorporateAction/from/EUWithholdingTax</a> <a href="#">TransactionType/CorporateAction/to/EUWithholdingTax</a> <a href="#">TransactionType/Bonds/EUWithholdingTaxInterests</a> |

|            |  |
|------------|--|
|            | <p> <a href="#">EarningType/FundDistribution/EUWithholdingTaxOverallValue</a><br/> <a href="#">TransactionType/EUWithholdingTaxPerShare</a><br/> <a href="#">EarningType/FundDistribution/EUWithholdingTaxUnitValue</a><br/> <a href="#">TransactionType/Bonds/EUWithholdingTaxValue</a> <a href="#">EarningType/Coupon/EUWithholdingTaxValue</a><br/> <a href="#">TransactionType/Bonds/EUWithholdingTaxZeroValue</a> <a href="#">TransactionType/Expenses</a><br/> <a href="#">TransactionType/CorporateAction/Expenses</a> <a href="#">TransactionType/Bonds/IndexBondAccrual</a><br/> <a href="#">TransactionType/Bonds/InflationaryAdjustment</a> <a href="#">PositionType/Loan/InterestAccruals</a><br/> <a href="#">PositionType/Bond/InterestClaimGross</a> <a href="#">PositionType/CommercialPaper/InterestClaimGross</a><br/> <a href="#">TransactionType/InterestClaimGross</a> <a href="#">PositionType/Bond/InterestClaimNet</a><br/> <a href="#">PositionType/CommercialPaper/InterestClaimNet</a> <a href="#">TransactionType/CorporateAction/from/Interests</a><br/> <a href="#">PositionType/Account/Interests</a> <a href="#">PositionType/CallMoney/Interests</a> <a href="#">EarningType/Interests</a><br/> <a href="#">PositionType/FixedTimeDeposit/Interests</a> <a href="#">TransactionType/CorporateAction/to/Interests</a><br/> <a href="#">PositionType/RealEstate/MaintenanceProvision</a> <a href="#">PositionType/RealEstate/MaintenanceReserve</a><br/> <a href="#">CountrySpecificShareClassDataATType/TotalNetAssetValue/ManagedExternally</a><br/> <a href="#">PositionType/Right/MarketValue</a> <a href="#">TransactionType/MarketValue</a><br/> <a href="#">PositionType/FixedTimeDeposit/MarketValue</a> <a href="#">PositionType/Loan/MarketValue</a><br/> <a href="#">PositionType/CallMoney/MarketValue</a> <a href="#">PositionType/REIT/MarketValue</a><br/> <a href="#">PositionType/CommercialPaper/MarketValue</a> <a href="#">TransactionType/CorporateAction/to/MarketValue</a><br/> <a href="#">PositionType/Equity/MarketValue</a> <a href="#">PositionType/RealEstate/MarketValue</a><br/> <a href="#">PositionType/Bond/MarketValue</a> <a href="#">PositionType/Account/MarketValue</a><br/> <a href="#">TransactionType/CorporateAction/from/MarketValue</a> <a href="#">ShareClassType/MinimumInvestment</a><br/> <a href="#">TransactionType/CorporateAction/from/NetDividend</a> <a href="#">PositionType/RealEstate/OtherAssets</a><br/> <a href="#">PositionType/RealEstate/OtherIncome</a> <a href="#">PositionType/RealEstate/OtherLiabilities</a><br/> <a href="#">PositionType/RealEstate/OtherNonFinancialAssetValue</a><br/> <a href="#">PositionType/RealEstate/AncillaryCosts/Outstanding</a><br/> <a href="#">CountrySpecificShareClassDataATType/TotalNetAssetValue/OwnSubfunds</a><br/> <a href="#">EarningType/FundDistribution/PayoutGrossValue</a><br/> <a href="#">EarningType/FundDistribution/PayoutIdentificEarningsValue</a><br/> <a href="#">EarningType/FundDistribution/PayoutPerUnitValue</a><br/> <a href="#">PositionType/RealEstate/PlannedMaintenanceCosts</a> <a href="#">PositionType/Future/PrelProfitLoss</a><br/> <a href="#">PositionType/Swap/PresentValueOfPayments</a> <a href="#">PositionType/ShareClass/Price</a><br/> <a href="#">PositionType/Warrant/Price</a> <a href="#">PositionType/Certificate/Price</a> <a href="#">PositionType/Future/Price</a><br/> <a href="#">PositionType/Option/Price</a> <a href="#">PositionType/REIT/Price</a> <a href="#">PositionType/CommercialPaper/Price</a><br/> <a href="#">PositionType/Right/Price</a> <a href="#">PositionType/Bond/Price</a> <a href="#">PositionType/Loan/Price</a><br/> <a href="#">PositionType/Equity/Price</a> <a href="#">TransactionType/ProfitLoss</a><br/> <a href="#">TransactionType/CorporateAction/from/ProfitLoss</a> <a href="#">PositionType/Option/PurchaseValue</a><br/> <a href="#">PositionType/REIT/PurchaseValue</a> <a href="#">PositionType/Equity/PurchaseValue</a><br/> <a href="#">PositionType/CommercialPaper/PurchaseValue</a> <a href="#">PositionType/Warrant/PurchaseValue</a><br/> <a href="#">PositionType/Right/PurchaseValue</a> <a href="#">PositionType/ShareClass/PurchaseValue</a><br/> <a href="#">PositionType/Bond/PurchaseValue</a> <a href="#">TransactionType/CorporateAction/from/Quest</a><br/> <a href="#">PositionType/RealEstate/RentAccruals</a> <a href="#">PositionType/RealEstate/RentDeposit</a><br/> <a href="#">PositionType/RealEstate/RentIncome</a> <a href="#">PositionType/RealEstate/RentReceivables</a><br/> <a href="#">TotalReturnType/Investment/SavingsPlanInvestment</a><br/> <a href="#">PerformanceType/Investment/SavingsPlanInvestment</a> <a href="#">TransactionType/SettlementAmount</a><br/> <a href="#">TotalReturnType/Investment/SingleInvestment</a> <a href="#">PerformanceType/Investment/SingleInvestment</a><br/> <a href="#">CountrySpecificShareClassDataATType/TotalNetAssetValue/SubscriptionRedemption</a><br/> <a href="#">PositionType/RealEstate/TaxLiabilities</a> <a href="#">FeePeriodDataType/Values/TNA</a><br/> <a href="#">TotalAssetValueType/OtherTotalAssetValues/TotalGrossAssetValue</a><br/> <a href="#">TotalAssetValueType/TotalGrossAssetValue</a><br/> <a href="#">TotalAssetValueType/OtherTotalAssetValues/TotalNetAssetValue</a><br/> <a href="#">TotalAssetValueType/TotalNetAssetValue</a> <a href="#">PositionType/TotalValue</a> <a href="#">FlowType/TotalValue</a><br/> <a href="#">TransactionType/CorporateAction/UnitInterestEUWithholdingTax</a><br/> <a href="#">TransactionType/Bonds/UnitInterests</a> <a href="#">EarningType/Coupon/UnitInterestsGrossValue</a><br/> <a href="#">EarningType/Coupon/UnitInterestsNetValue</a><br/> <a href="#">TransactionType/CorporateAction/to/UnitsInterestCapitalYieldsTax</a><br/> <a href="#">TransactionType/CorporateAction/from/UnitsInterestCapitalYieldsTax</a><br/> <a href="#">PositionType/RealEstate/VacancyCosts</a> <a href="#">OtherTotalValueType/Value</a> <a href="#">ExposureType/Exposure/Value</a><br/> <a href="#">PositionType/Swap/LegValues/LegValue/Value</a> <a href="#">PositionType/Future/VariationMarginDaily</a><br/> <a href="#">PositionType/Future/VariationMarginOverall</a> <a href="#">EarningType/Dividend/WithholdingTaxValue</a><br/> <a href="#">PositionType/Bond/ZeroBondCapitalYieldsTaxClaim</a> <a href="#">TransactionType/ZeroBondInterestClaimGross</a><br/> <a href="#">PositionType/Bond/ZeroBondInterestClaimGross</a> <a href="#">PositionType/Bond/ZeroBondInterestClaimNet</a> </p> |
| annotation | <p> documentation<br/> Amount in different currencies<br/> documentation<br/> Betrag in verschiedenen Waehrungen </p>  |

element **FundAmountType/Amount**

|            |  |
|------------|--|
| diagram    |  |
| type       | extension of <b>xs:decimal</b>   |
| properties | isRef 0<br>minOcc 1<br>maxOcc unbounded<br>content complex   |
| annotation | documentation<br>Amounts in currency as defined in attribute<br>documentation<br>Betrag in frei wählbarer Waehrung |

attribute **FundAmountType/Amount/@ccy**

|            |   |            |       |            |           |   |  |           |   |  |         |          |  |
|------------|---|------------|-------|------------|-----------|---|--|-----------|---|--|---------|----------|--|
| type       | <a href="#">ISOCurrencyCodeType</a>   |            |       |            |           |   |  |           |   |  |         |          |  |
| properties | isRef 0<br>use required   |            |       |            |           |   |  |           |   |  |         |          |  |
| facets     | <table border="0"> <tr> <td>Kind</td> <td>Value</td> <td>annotation</td> </tr> <tr> <td>minLength</td> <td>3</td> <td></td> </tr> <tr> <td>maxLength</td> <td>3</td> <td></td> </tr> <tr> <td>pattern</td> <td>[A-Z]{3}</td> <td></td> </tr> </table> | Kind       | Value | annotation | minLength | 3 |  | maxLength | 3 |  | pattern | [A-Z]{3} |  |
| Kind       | Value   | annotation |       |            |           |   |  |           |   |  |         |          |  |
| minLength  | 3   |            |       |            |           |   |  |           |   |  |         |          |  |
| maxLength  | 3   |            |       |            |           |   |  |           |   |  |         |          |  |
| pattern    | [A-Z]{3}  |            |       |            |           |   |  |           |   |  |         |          |  |

attribute **FundAmountType/Amount/@isFundCcy**

|            |                   |
|------------|-------------------|
| type       | <b>xs:boolean</b> |
| properties | isRef 0           |

attribute **FundAmountType/Amount/@isSubfundCcy**

|            |                   |
|------------|-------------------|
| type       | <b>xs:boolean</b> |
| properties | isRef 0           |

attribute **FundAmountType/Amount/@isShareClassCcy**

|            |                   |
|------------|-------------------|
| type       | <b>xs:boolean</b> |
| properties | isRef 0           |

### complexType FundOrShareClassIdentifiersType

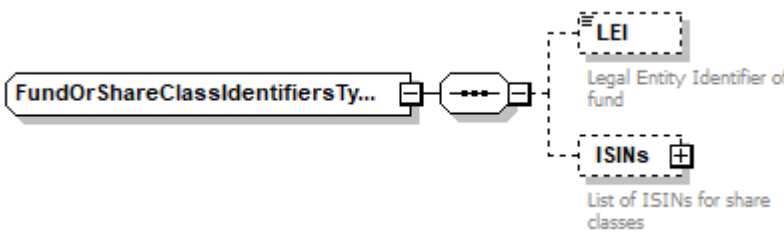
|          |  |   |
|----------|--|---|
| diagram  |  |   |
| children | <a href="#">LEI</a> <a href="#">ISINs</a>  |   |
| used by  | elements   | <a href="#">SolvencyIIPortfolioType_V6/FundOrShareClassIdentifiers</a><br><a href="#">SolvencyIIPortfolioType/FundOrShareClassIdentifiers</a><br><a href="#">SolvencyIIPortfolioType_V5/FundOrShareClassIdentifiers</a><br><a href="#">EMIR_ReportType/FundOrShareClassIdentifiers</a><br><a href="#">EMT_V4_FinancialInstrumentType/FundOrShareClassIdentifiers</a><br><a href="#">EMT_V41_FinancialInstrumentType/FundOrShareClassIdentifiers</a><br><a href="#">EMTFinancialInstrumentType/FundOrShareClassIdentifiers</a><br><a href="#">EMT_V3_FinancialInstrumentType/FundOrShareClassIdentifiers</a><br><a href="#">KIIDType/FundOrShareClassIdentifiers PRIIPS_ReportType/FundOrShareClassIdentifiers</a><br><a href="#">CEPTV2PerformanceType/FundOrShareClassIdentifiers</a><br><a href="#">CEPTV2HistoryType/FundOrShareClassIdentifiers</a><br><a href="#">PRIIPSType_V20/EPTV2/FundOrShareClassIdentifiers EFTReportType/FundOrShareClassIdentifiers</a> |

### element FundOrShareClassIdentifiersType/LEI

|            |  |                                 |
|------------|--|---------------------------------|
| diagram    |  |                                 |
| type       | <a href="#">LEICodeType</a>  |                                 |
| properties | isRef  | 0                               |
|            | minOcc   | 0                               |
|            | maxOcc   | 1                               |
|            | content  | simple                          |
| facets     | Kind   | Value annotation                |
|            | minLength  | 20                              |
|            | maxLength  | 20                              |
|            | pattern  | ([0-9a-zA-Z]{18})[0-9]{2}       |
| annotation | documentation  | Legal Entity Identifier of fund |

### element FundOrShareClassIdentifiersType/ISINs

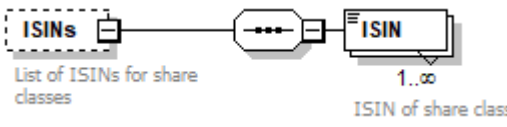
|            |   |                                 |
|------------|---|---------------------------------|
| diagram    |  |                                 |
| properties | isRef   | 0                               |
|            | minOcc  | 0                               |
|            | maxOcc  | 1                               |
|            | content   | complex                         |
| children   | <a href="#">ISIN</a>  |                                 |
| annotation | documentation   | List of ISINs for share classes |

element **FundOrShareClassIdentifiersType/ISINs/ISIN**

|            |   |
|------------|---|
| diagram    |   |
| type       | <a href="#">ISINType</a>  |
| properties | isRef 0<br>minOcc 1<br>maxOcc unbounded<br>content simple                 |
| facets     | Kind Value annotation<br>length 12<br>pattern [A-Z]{2}[A-Z0-9]{9}[0-9]{1} |
| annotation | documentation<br>ISIN of share class                                      |

complexType **FundRelatedTextType**

|            |  |
|------------|--|
| diagram    |  |
| children   | <a href="#">Language</a> <a href="#">Date</a> <a href="#">ListedType</a> <a href="#">UnlistedType</a> <a href="#">Title</a> <a href="#">Content</a> <a href="#">CountriesWhereApplicable</a> |
| used by    | elements <a href="#">FundStaticDataType/FundTexts/FundText</a> <a href="#">SubfundStaticDataType/FundTexts/FundText</a>  |
| annotation | documentation<br>complex Element designed to describe any text or commentary related to a fund like "Investment strategy", "Management outlook", "company profile"...                        |

### element **FundRelatedTextType/Language**

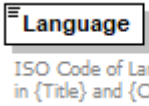
|            |   |
|------------|---|
| diagram    |    |
| type       | <b>xs:language</b>  |
| properties | isRef 0<br>content simple   |
| annotation | documentation<br>ISO Code of Language used in {Title} and {Content}<br>documentation<br>Sprache der Feldinhalte von {Title} und {Content} |

### element **FundRelatedTextType/Date**

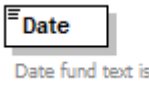
|            |   |
|------------|---|
| diagram    |              |
| type       | <b>xs:date</b>  |
| properties | isRef 0<br>content simple   |
| annotation | documentation<br>Date fund text is valid<br>documentation<br>Gültigkeitsdatum des Fondstextes |

### element **FundRelatedTextType/ListedType**

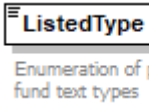
|            |  |
|------------|--|
| diagram    |   |
| type       | restriction of <b>xs:string</b>  |
| properties | isRef 0<br>content simple  |
| annotation | documentation<br>Enumeration of predefined fund text types<br>documentation<br>Art des Fondstextes (gemäß vorderfinierter Liste) |

### element **FundRelatedTextType/UnlistedType**

|            |  |
|------------|--|
| diagram    |           |
| type       | <a href="#">Text100Type</a>  |
| properties | isRef 0<br>content simple  |
| facets     | Kind Value annotation<br>maxLength 100   |
| annotation | documentation<br>Free description of fund text (for those not listed above)<br>documentation |



|  |  |
|--|--|
|  | Freie Beschreibung der Art des Fondstextes (falls nicht in vorderfinierter Liste der Fondstextarten vorhanden) |
|--|--|

**element FundRelatedTextType/Title**

|            |   |
|------------|---|
| diagram    |   |
| type       | <b>xs:string</b>  |
| properties | isRef 0<br>minOcc 0<br>maxOcc 1<br>content simple   |
| annotation | documentation<br><b>Title of fund text in specified language</b><br>documentation<br><b>Titel/Überschrift des Fondstextes in oben angegebener Sprache</b> |

**element FundRelatedTextType/Content**

|            |  |
|------------|--|
| diagram    |  |
| type       | <b>xs:string</b>   |
| properties | isRef 0<br>content simple  |
| annotation | documentation<br><b>Fund text itself in specified language</b><br>documentation<br><b>Inhalt des Fondstextes in oben angegebener Sprache</b> |

**element FundRelatedTextType/CountriesWhereApplicable**

|            |   |
|------------|---|
| diagram    |   |
| properties | isRef 0<br>minOcc 0<br>maxOcc 1<br>content complex  |
| children   | <a href="#">Country</a>   |
| annotation | documentation<br><b>Fund text can be used in these countries</b><br>documentation<br><b>Fondstext kann in den diesen Ländern verwendet werden</b> |

element **FundRelatedTextype/CountriesWhereApplicable/Country**

|            |   |            |       |            |           |        |           |           |        |  |
|------------|---|------------|-------|------------|-----------|--------|-----------|-----------|--------|--|
| diagram    |   |            |       |            |           |        |           |           |        |  |
| type       | <a href="#">ISOCountryCodeType</a>  |            |       |            |           |        |           |           |        |  |
| properties | <table> <tr><td>isRef</td><td>0</td></tr> <tr><td>minOcc</td><td>1</td></tr> <tr><td>maxOcc</td><td>unbounded</td></tr> <tr><td>content</td><td>simple</td></tr> </table> | isRef      | 0     | minOcc     | 1         | maxOcc | unbounded | content   | simple |  |
| isRef      | 0   |            |       |            |           |        |           |           |        |  |
| minOcc     | 1   |            |       |            |           |        |           |           |        |  |
| maxOcc     | unbounded   |            |       |            |           |        |           |           |        |  |
| content    | simple  |            |       |            |           |        |           |           |        |  |
| facets     | <table> <tr><td>Kind</td><td>Value</td><td>annotation</td></tr> <tr><td>minLength</td><td>2</td><td></td></tr> <tr><td>maxLength</td><td>2</td><td></td></tr> </table>    | Kind       | Value | annotation | minLength | 2      |           | maxLength | 2      |  |
| Kind       | Value   | annotation |       |            |           |        |           |           |        |  |
| minLength  | 2   |            |       |            |           |        |           |           |        |  |
| maxLength  | 2   |            |       |            |           |        |           |           |        |  |
| annotation | <p>documentation<br/>ISO Country Code of the countries where fund text is applicable</p>  |            |       |            |           |        |           |           |        |  |

complexType **FXRatesType**

|          |   |
|----------|---|
| diagram  |   |
| children | <a href="#">FXRate</a>  |
| used by  | <p>elements <a href="#">PositionType/AveragePurchaseFXRate</a> <a href="#">FlowType/FXRate</a> <a href="#">PositionType/FXRates</a><br/> <a href="#">PositionUnderlyingType/FXRates</a> <a href="#">EarningType/FXRates</a> <a href="#">TransactionType/FXRates</a></p> |

element **FXRatesType/FXRate**

|            |  |       |   |        |   |        |           |         |         |
|------------|--|-------|---|--------|---|--------|-----------|---------|---------|
| diagram    |  |       |   |        |   |        |           |         |         |
| type       | <a href="#">FXRateType</a>   |       |   |        |   |        |           |         |         |
| properties | <table> <tr><td>isRef</td><td>0</td></tr> <tr><td>minOcc</td><td>1</td></tr> <tr><td>maxOcc</td><td>unbounded</td></tr> <tr><td>content</td><td>complex</td></tr> </table> | isRef | 0 | minOcc | 1 | maxOcc | unbounded | content | complex |
| isRef      | 0  |       |   |        |   |        |           |         |         |
| minOcc     | 1  |       |   |        |   |        |           |         |         |
| maxOcc     | unbounded  |       |   |        |   |        |           |         |         |
| content    | complex  |       |   |        |   |        |           |         |         |

### complexType FXRateType

|            |  |
|------------|--|
| diagram    |  |
| type       | extension of <b>xs:decimal</b>             |
| properties | base <b>xs:decimal</b>                     |
| used by    | element <a href="#">FXRatesType/FXRate</a> |

### attribute FXRateType/@fromCcy

|            |   |
|------------|---|
| type       | <a href="#">ISOCurrencyCodeType</a>                                     |
| properties | isRef 0<br>use required   |
| facets     | Kind Value annotation<br>minLength 3<br>maxLength 3<br>pattern [A-Z]{3} |

### attribute FXRateType/@toCcy

|            |   |
|------------|---|
| type       | <a href="#">ISOCurrencyCodeType</a>                                     |
| properties | isRef 0<br>use required   |
| facets     | Kind Value annotation<br>minLength 3<br>maxLength 3<br>pattern [A-Z]{3} |

### attribute FXRateType/@mulDiv

|            |                                 |
|------------|---------------------------------|
| type       | restriction of <b>xs:string</b> |
| properties | isRef 0<br>use required         |

complexType **HedgingStrategyType**

|                 |  |
|-----------------|--|
| <p>diagram</p>  |  <p>A net asset value (NAV) hedge: This aims to minimise the effect of currency movements between the base currency of a fund and the currency of the relevant hedged share class.<br/> A portfolio hedge: This aims to minimise the effect of currency movements between the currencies of the assets of the fund and the currency of the relevant hedged share class with the exception of currencies where it is impractical or not cost effective to do so. In other words, it looks through to the underlying currency exposures of the fund.<br/> Full hedge: Open position that eliminates over 90% or more of the risk arising from another open position.<br/> Partial hedge: Open position that eliminates below 90% but more than 0% of the risk arising from another open position.</p> |
| <p>children</p> | <p><a href="#">HedgingStrategy</a></p>   |
| <p>used by</p>  | <p>elements <a href="#">FundStaticDataType/FundHedgingStrategy</a> <a href="#">ShareClassType/FundHedgingStrategy</a></p>  |

element **HedgingStrategyType/HedgingStrategy**

|                   |   |
|-------------------|---|
| <p>diagram</p>    | <div data-bbox="293 239 513 285" style="border: 1px solid black; padding: 2px;"> <p><b>Hedging Strategy</b></p> </div> <p>A net asset value (NAV) hedge: This aims to minimise the effect of currency movements between the base currency of a fund and the currency of the relevant hedged share class.</p> <p>A portfolio hedge: This aims to minimise the effect of currency movements between the currencies of the assets of the fund and the currency of the relevant hedged share class with the exception of currencies where it is impractical or not cost effective to do so. In other words, it looks through to the underlying currency exposures of the fund.</p> <p>Full hedge: Open position that eliminates over 90% or more of the risk arising from another open position.</p> <p>Partial hedge: Open position that eliminates below 90% but more than 0% of the risk arising from another open position.</p> |
| <p>type</p>       | <p>restriction of <b>xs:string</b></p>  |
| <p>properties</p> | <p>isRef 0<br/>content simple</p>   |
| <p>annotation</p> | <p>documentation</p> <p>A net asset value (NAV) hedge: This aims to minimise the effect of currency movements between the base currency of a fund and the currency of the relevant hedged share class.</p> <p>A portfolio hedge: This aims to minimise the effect of currency movements between the currencies of the assets of the fund and the currency of the relevant hedged share class with the exception of currencies where it is impractical or not cost effective to do so. In other words, it looks through to the underlying currency exposures of the fund.</p> <p>Full hedge: Open position that eliminates over 90% or more of the risk arising from another open position.</p> <p>Partial hedge: Open position that eliminates below 90% but more than 0% of the risk arising from another open position.</p>   |

## complexType IdentifiersType

|                 |   |
|-----------------|---|
| <p>diagram</p>  | <p><b>ISIN</b><br/>International Securities Identification Number (12 chars)</p> <p><b>Bloomberg</b><br/>Bloomberg identifiers</p> <p><b>CUSIP</b><br/>Committee on Uniform Security Identification Procedures (9 chars)</p> <p><b>GermanWKN</b><br/>German Wertpapier-Kenn-Nummer (6 chars)</p> <p><b>LEI</b><br/>Legal Entity Identification for Financial Contracts (20 chars)</p> <p><b>MexID</b><br/>0..2<br/>Market Exchange Identifier</p> <p><b>ReutersRIC</b><br/>0..2<br/>Reuters Instrument Code</p> <p><b>SEDOL</b><br/>Stock Exchange Daily Official List (7 chars)</p> <p><b>SwissValorenCode</b><br/>Local swiss security number</p> <p><b>SwiftBIC</b><br/>Business Identifier Code from SWIFT (3-12 chars)</p> <p><b>OtherID</b><br/>0..∞<br/>All other identifiers (with listed or free type)</p> |
| <p>children</p> | <p><a href="#">ISIN</a> <a href="#">Bloomberg</a> <a href="#">CUSIP</a> <a href="#">GermanWKN</a> <a href="#">LEI</a> <a href="#">MexID</a> <a href="#">ReutersRIC</a> <a href="#">SEDOL</a> <a href="#">SwissValorenCode</a> <a href="#">SwiftBIC</a> <a href="#">OtherID</a></p>  |
| <p>used by</p>  | <p>elements <a href="#">BondType/Coupon/BaselIndex</a> <a href="#">CommercialPaperType/Coupon/BaselIndex</a> <a href="#">LoanType/CorrespondingRealEstate</a> <a href="#">BenchmarkStaticDataType/BenchmarkComponents/BenchmarkComponent/Identifier</a> <a href="#">ShareClassType/MarketPlaces/MarketPlace/MarketMaker/Identifier</a> <a href="#">DocumentType/Fund/Identifiers</a> <a href="#">DocumentType/Subfunds/Subfund/Identifiers</a> <a href="#">DocumentType/ShareClasses/ShareClass/Identifiers</a> <a href="#">SegmentType/Identifiers</a> <a href="#">FundType/Identifiers</a> <a href="#">SubfundType/Identifiers</a> <a href="#">CompanyType/Identifiers</a> <a href="#">IssuerType/Identifiers</a> <a href="#">CountrySpecificFundDataATTtype/PKG2012/Details/Position/Identifiers</a></p>         |

|  |  |
|--|--|
|  | <a href="#">PositionType/Identifiers</a> <a href="#">PositionUnderlyingType/Identifiers</a> <a href="#">EarningType/Identifiers</a><br><a href="#">TransactionType/Identifiers</a> <a href="#">TransactionType/CorporateAction/from/Identifiers</a><br><a href="#">TransactionType/CorporateAction/to/Identifiers</a> <a href="#">ShareClassType/Identifiers</a> <a href="#">AssetType/Identifiers</a><br><a href="#">BenchmarkType/Components/Component/Identifiers</a> <a href="#">UnderlyingType/Identifiers</a><br><a href="#">SubfundStaticDataType/IsFeederFor</a> <a href="#">SingleFundStaticDataType/IsFeederFor</a><br><a href="#">SubfundStaticDataType/IsMasterFor</a> <a href="#">SingleFundStaticDataType/IsMasterFor</a><br><a href="#">ReposType/Security/IDPledge</a> <a href="#">SwapType/Legs/Leq/Underlying</a> <a href="#">ConvertibleBondType/Underlying</a> |
|--|--|

**element IdentifiersType/ISIN**

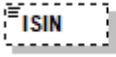
|            |  |
|------------|--|
| diagram    |  <p>International Securities Identification Number (12 chars)</p> |
| type       | <a href="#">ISINType</a>   |
| properties | isRef 0<br>minOcc 0<br>maxOcc 1<br>content simple  |
| facets     | Kind Value annotation<br>length 12<br>pattern [A-Z]{2}[A-Z0-9]{9}[0-9]{1}  |
| annotation | documentation<br>International Securities Identification Number (12 chars)   |

**element IdentifiersType/Bloomberg**

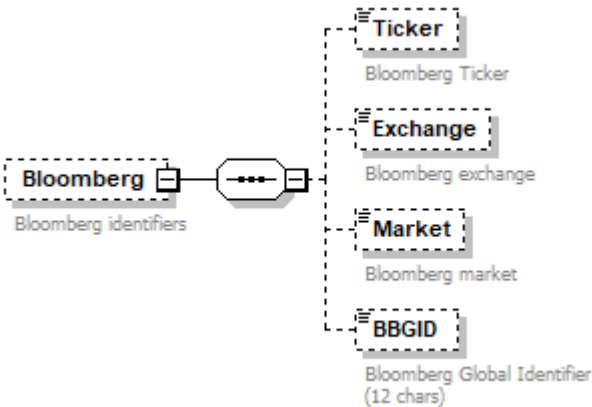
|            |  |
|------------|--|
| diagram    |           |
| properties | isRef 0<br>minOcc 0<br>maxOcc 1<br>content complex   |
| children   | <a href="#">Ticker</a> <a href="#">Exchange</a> <a href="#">Market</a> <a href="#">BBGID</a> |
| annotation | documentation<br>Bloomberg identifiers   |

**element IdentifiersType/Bloomberg/Ticker**

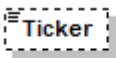
|         |   |
|---------|---|
| diagram |  <p>Bloomberg Ticker</p> |
|---------|---|

|            |   |
|------------|---|
| type       | <a href="#">Text32Type</a>                        |
| properties | isRef 0<br>minOcc 0<br>maxOcc 1<br>content simple |
| facets     | Kind Value annotation<br>maxLength 32             |
| annotation | documentation<br>Bloomberg Ticker                 |

#### element IdentifiersType/Bloomberg/Exchange

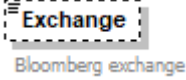
|            |   |
|------------|---|
| diagram    |  |
| type       | <a href="#">Text16Type</a>  |
| properties | isRef 0<br>minOcc 0<br>maxOcc 1<br>content simple                                 |
| facets     | Kind Value annotation<br>maxLength 16   |
| annotation | documentation<br>Bloomberg exchange   |

#### element IdentifiersType/Bloomberg/Market

|            |   |
|------------|---|
| diagram    |  |
| type       | restriction of <a href="#">Text16Type</a>   |
| properties | isRef 0<br>minOcc 0<br>maxOcc 1<br>content simple                                   |
| facets     | Kind Value annotation<br>maxLength 16   |
| annotation | documentation<br>Bloomberg market   |

#### element IdentifiersType/Bloomberg/BBGID

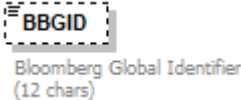
|            |   |
|------------|---|
| diagram    |  |
| type       | restriction of <b>xs:string</b>   |
| properties | isRef 0<br>minOcc 0<br>maxOcc 1<br>content simple                                   |
| facets     | Kind Value annotation<br>length 12<br>pattern [A-Z0-9]{12}                          |



|            |   |
|------------|---|
| annotation | documentation<br>Bloomberg Global Identifier (12 chars) |
|------------|---|

### element IdentifiersType/CUSIP

|            |  |
|------------|--|
| diagram    |   |
| type       | restriction of <b>xs:string</b>  |
| properties | isRef 0<br>minOcc 0<br>maxOcc 1<br>content simple                                  |
| facets     | Kind Value annotation<br>length 9  |
| annotation | documentation<br>Committee on Uniform Security Identification Procedures (9 chars) |

### element IdentifiersType/GermanWKN

|            |  |
|------------|--|
| diagram    |  |
| type       | restriction of <b>xs:string</b>  |
| properties | isRef 0<br>minOcc 0<br>maxOcc 1<br>content simple                                  |
| facets     | Kind Value annotation<br>length 6  |
| annotation | documentation<br>German Wertpapier-Kenn-Nummer (6 chars)                           |

### element IdentifiersType/LEI

|            |   |
|------------|---|
| diagram    |                      |
| type       | restriction of <a href="#">LEICodeType</a>  |
| properties | isRef 0<br>minOcc 0<br>maxOcc 1<br>content simple   |
| facets     | Kind Value annotation<br>length 20<br>minLength 20<br>maxLength 20<br>pattern ([0-9a-zA-Z]{18}[0-9]{2}) |

|            |   |
|------------|---|
| annotation | documentation<br>Legal Entity Identification for Financial Contracts (20 chars) |
|------------|---|

### element IdentifiersType/MexID

|            |  |
|------------|--|
| diagram    |  |
| type       | extension of <a href="#">Text64Type</a>            |
| properties | isRef 0<br>minOcc 0<br>maxOcc 2<br>content complex |
| facets     | Kind Value annotation<br>maxLength 64              |
| annotation | documentation<br>Market Exchange Identifier        |

### attribute IdentifiersType/MexID/@type

|            |                                       |
|------------|---------------------------------------|
| type       | <a href="#">Text16Type</a>            |
| properties | isRef 0                               |
| facets     | Kind Value annotation<br>maxLength 16 |

### element IdentifiersType/ReutersRIC

|            |  |
|------------|--|
| diagram    |  |
| type       | extension of <a href="#">Text32Type</a>            |
| properties | isRef 0<br>minOcc 0<br>maxOcc 2<br>content complex |
| facets     | Kind Value annotation<br>maxLength 32              |
| annotation | documentation<br>Reuters Instrument Code           |

### attribute IdentifiersType/ReutersRIC/@type

|            |                                       |
|------------|---------------------------------------|
| type       | <a href="#">Text16Type</a>            |
| properties | isRef 0                               |
| facets     | Kind Value annotation<br>maxLength 16 |

### element IdentifiersType/SEDOL

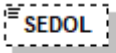
|            |   |
|------------|---|
| diagram    |  <p>Stock Exchange Daily<br/>Official List (7 chars)</p> |
| type       | restriction of <b>xs:string</b>   |
| properties | isRef 0<br>minOcc 0<br>maxOcc 1<br>content simple   |
| facets     | Kind Value annotation<br>minLength 6<br>maxLength 7<br>pattern [B-DF-HJ-NP-TV-Z0-9]{6}[0-9]{1}  |
| annotation | documentation<br>Stock Exchange Daily Official List (7 chars)   |

### element IdentifiersType/SwissValorenCode

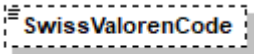
|            |  |
|------------|--|
| diagram    |  <p>Local swiss security number</p> |
| type       | <b>xs:int</b>  |
| properties | isRef 0<br>minOcc 0<br>maxOcc 1<br>content simple  |
| annotation | documentation<br>Local swiss security number   |

### element IdentifiersType/SwiftBIC

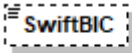
|            |   |
|------------|---|
| diagram    |  <p>Business Identifier Code<br/>from SWIFT (3-12 chars)</p> |
| type       | <a href="#">BicCodeType</a>   |
| properties | isRef 0<br>minOcc 0<br>maxOcc 1<br>content simple   |
| facets     | Kind Value annotation<br>minLength 3<br>maxLength 12  |
| annotation | documentation<br>Business Identifier Code from SWIFT (3-12 chars)   |

### element IdentifiersType/OtherID

|            |   |
|------------|---|
| diagram    | <p>All other identifiers (with listed or free type)</p>           |
| type       | extension of <a href="#">Text256Type</a>                          |
| properties | isRef 0<br>minOcc 0<br>maxOcc unbounded<br>content complex        |
| facets     | Kind Value annotation<br>maxLength 256                            |
| annotation | documentation<br>All other identifiers (with listed or free type) |

### attribute IdentifiersType/OtherID/@ListedType

|            |                                      |
|------------|--------------------------------------|
| type       | <a href="#">ListedIdentifierType</a> |
| properties | isRef 0                              |

### attribute IdentifiersType/OtherID/@FreeType

|            |  |
|------------|--|
| type       | <a href="#">Text100Type</a>            |
| properties | isRef 0                                |
| facets     | Kind Value annotation<br>maxLength 100 |

### complexType IssuerType

|          |   |
|----------|---|
| diagram  |   |
| children | <a href="#">Identifiers</a> <a href="#">Name</a> <a href="#">Country</a> <a href="#">BusinessCountry</a> <a href="#">ParentIssuer</a> |
| used by  | element <a href="#">IssuerType/ParentIssuer</a>   |

element **IssuerType/Identifiers**

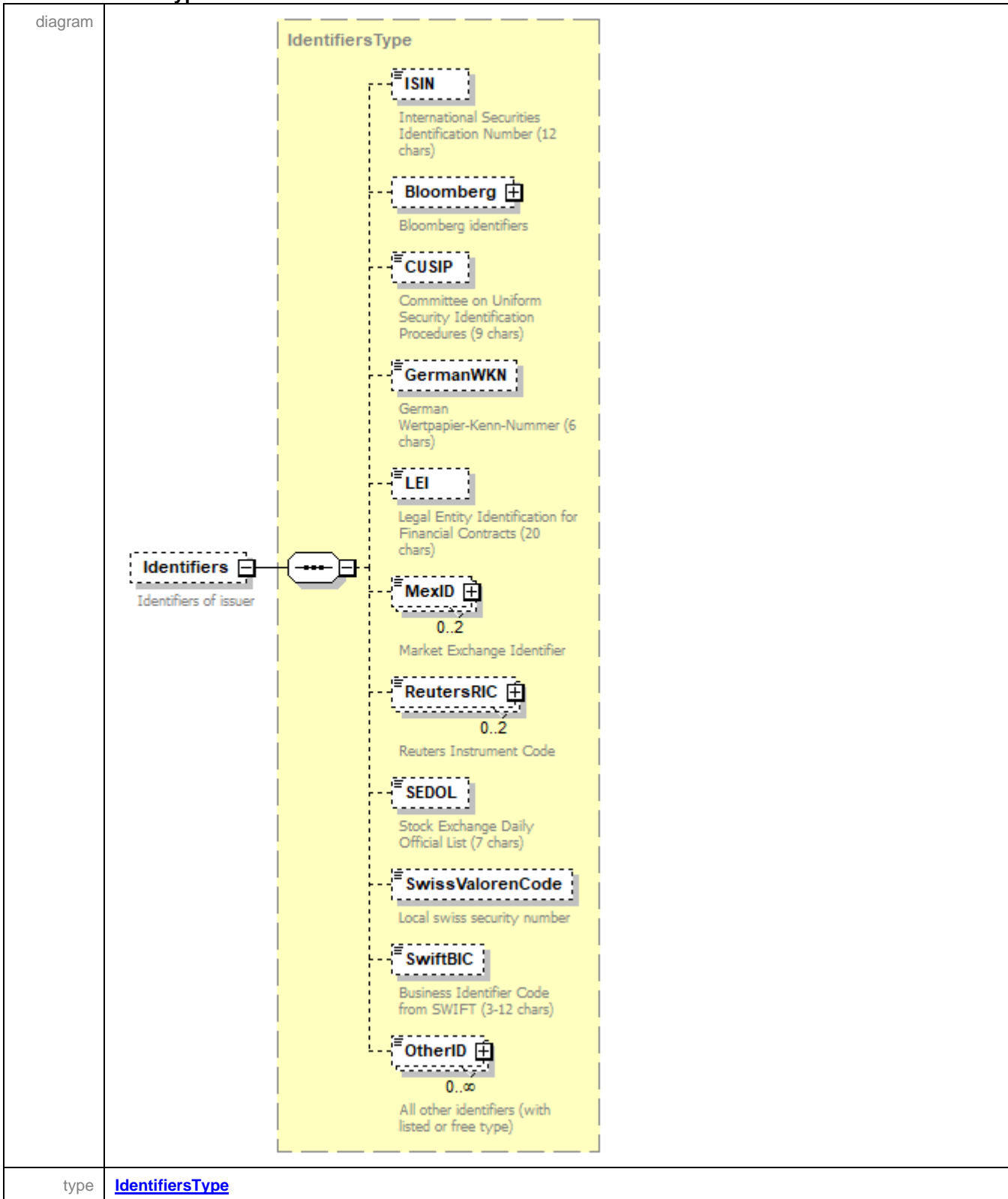

|            |   |
|------------|---|
| properties | isRef 0<br>minOcc 0<br>maxOcc 1<br>content complex  |
| children   | <a href="#">ISIN</a> <a href="#">Bloomberg</a> <a href="#">CUSIP</a> <a href="#">GermanWKN</a> <a href="#">LEI</a> <a href="#">MexID</a> <a href="#">ReutersRIC</a> <a href="#">SEDOL</a> <a href="#">SwissValorenCode</a> <a href="#">SwiftBIC</a> <a href="#">OtherID</a> |
| annotation | documentation<br>Identifiers of issuer  |

#### element IssuerType/Name

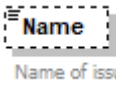
|            |   |
|------------|---|
| diagram    |  |
| type       | <b>xs:string</b>  |
| properties | isRef 0<br>minOcc 0<br>maxOcc 1<br>content simple                                 |
| annotation | documentation<br>Name of issuer   |

#### element IssuerType/Country

|            |  |
|------------|--|
| diagram    |  |
| type       | <a href="#">ISOCountryCodeType</a>   |
| properties | isRef 0<br>minOcc 0<br>maxOcc 1<br>content simple                                  |
| facets     | Kind Value annotation<br>minLength 2<br>maxLength 2                                |
| annotation | documentation<br>Country code of issuer (country of headquarter)                   |

#### element IssuerType/BusinessCountry

|            |   |
|------------|---|
| diagram    |  |
| type       | <a href="#">ISOCountryCodeType</a>  |
| properties | isRef 0<br>minOcc 0<br>maxOcc 1<br>content simple                                   |
| facets     | Kind Value annotation<br>minLength 2<br>maxLength 2                                 |
| annotation | documentation<br>Country code of main business of issuer                            |

element **IssuerType/ParentIssuer**

|            |   |
|------------|---|
| diagram    |   |
| type       | <a href="#">IssuerType</a>  |
| properties | isRef 0<br>minOcc 0<br>maxOcc 1<br>content complex  |
| children   | <a href="#">Identifiers</a> <a href="#">Name</a> <a href="#">Country</a> <a href="#">BusinessCountry</a> <a href="#">ParentIssuer</a> |

complexType **LanguageNamesType**

|          |   |
|----------|---|
| diagram  |   |
| children | <a href="#">Name</a>                            |
| used by  | element <a href="#">NamesType/LanguageNames</a> |

element **LanguageNamesType/Name**

|            |  |
|------------|--|
| diagram    |  |
| type       | extension of <a href="#">Text500Type</a>                   |
| properties | isRef 0<br>minOcc 1<br>maxOcc unbounded<br>content complex |
| facets     | Kind Value annotation<br>maxLength 500                     |

attribute **LanguageNamesType/Name/@language**

|            |                         |
|------------|-------------------------|
| type       | <b>xs:language</b>      |
| properties | isRef 0<br>use required |

complexType **NamesType**

|          |  |
|----------|--|
| diagram  |  |
| children | <a href="#">OfficialName</a> <a href="#">FullName</a> <a href="#">MarketingName</a> <a href="#">ShortName</a> <a href="#">PreviousName</a> <a href="#">DynLenNames</a> <a href="#">LanguageNames</a> |
| used by  | elements <a href="#">FundType/Names</a> <a href="#">SubfundType/Names</a> <a href="#">ShareClassType/Names</a>   |

element **NamesType/OfficialName**

|            |                             |
|------------|-----------------------------|
| diagram    |                             |
| type       | <a href="#">Text500Type</a> |
| properties | isRef 0<br>content simple   |
| facets     | Kind Value annotation       |



|            |  |
|------------|--|
|            | maxLength 500  |
| annotation | documentation<br>Official name of fund or corresponding object |

### element **NamesType/FullName**

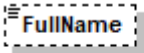
|            |   |
|------------|---|
| diagram    |  <p>Full name of fund or share class for umbrella structures</p> |
| type       | <a href="#">Text500Type</a>   |
| properties | isRef 0<br>minOcc 0<br>maxOcc 1<br>content simple   |
| facets     | Kind Value annotation<br>maxLength 500  |
| annotation | documentation<br>Full name of fund or share class for umbrella structures   |

### element **NamesType/MarketingName**

|            |   |
|------------|---|
| diagram    |  <p>Marketing name of fund or corresponding object</p> |
| type       | <a href="#">Text500Type</a>   |
| properties | isRef 0<br>minOcc 0<br>maxOcc 1<br>content simple   |
| facets     | Kind Value annotation<br>maxLength 500  |
| annotation | documentation<br>Marketing name of fund or corresponding object   |

### element **NamesType/ShortName**

|            |   |
|------------|---|
| diagram    |  <p>Short name of fund or corresponding object (max. 100 characters)</p> |
| type       | <a href="#">Text100Type</a>   |
| properties | isRef 0<br>minOcc 0<br>maxOcc 1<br>content simple   |
| facets     | Kind Value annotation<br>maxLength 100  |
| annotation | documentation<br>Short name of fund or corresponding object (max. 100 characters)   |

element **NamesType/PreviousName**

|            |  |
|------------|--|
| diagram    |  |
| type       | extension of <a href="#">Text500Type</a>                       |
| properties | isRef 0<br>minOcc 0<br>maxOcc 1<br>content complex             |
| facets     | Kind Value annotation<br>maxLength 500                         |
| annotation | documentation<br>Previous name of fund or corresponding object |

attribute **NamesType/PreviousName/@until**

|            |   |
|------------|---|
| type       | <b>xs:date</b>  |
| properties | isRef 0   |
| annotation | documentation<br>Date until previous name of fund or object was valid |

element **NamesType/DynLenNames**

|            |  |
|------------|--|
| diagram    |  |
| type       | <a href="#">DynLenNamesType</a>  |
| properties | isRef 0<br>minOcc 0<br>maxOcc 1<br>content complex                             |
| children   | <a href="#">Name</a>   |
| annotation | documentation<br>Name of fund or share classfor different max-space situations |

element **NamesType/LanguageNames**

|         |                                   |
|---------|-----------------------------------|
| diagram |                                   |
| type    | <a href="#">LanguageNamesType</a> |

|            |  |
|------------|--|
| properties | isRef 0<br>minOcc 0<br>maxOcc 1<br>content complex                     |
| children   | <a href="#">Name</a>   |
| annotation | documentation<br>Name of fund or share classes in additional languages |

### complexType OtherPricesType

|          |   |
|----------|---|
| diagram  |   |
| children | <a href="#">Price</a>   |
| used by  | elements <a href="#">PositionType/Equity/OtherPrices</a> <a href="#">PositionType/Bond/OtherPrices</a><br><a href="#">PositionType/ShareClass/OtherPrices</a> <a href="#">PositionType/Warrant/OtherPrices</a><br><a href="#">PositionType/Option/OtherPrices</a> <a href="#">PositionType/Future/OtherPrices</a> <a href="#">PositionType/REIT/OtherPrices</a><br><a href="#">PositionType/Right/OtherPrices</a> <a href="#">ShareClassPriceType/OtherPrices</a> |

### element OtherPricesType/Price

|            |  |
|------------|--|
| diagram    |  |
| properties | isRef 0<br>minOcc 1<br>maxOcc unbounded<br>content complex   |
| children   | <a href="#">PriceType</a> <a href="#">NavPrice</a> <a href="#">SubscriptionPrice</a> <a href="#">RedemptionPrice</a> |
| annotation | documentation<br>Inform on the price type (different from the official NAV) used for other price communication       |

element **OtherPricesType/Price/PriceType**

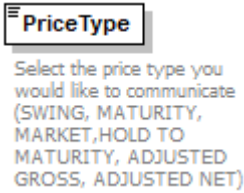
|            |  |
|------------|--|
| diagram    |   |
| type       | restriction of <b>xs:string</b>  |
| properties | isRef 0<br>content simple  |
| facets     | Kind Value annotation<br>minLength 5<br>maxLength 16   |
| annotation | documentation<br>Select the price type you would like to communicate (SWING, MATURITY, MARKET, HOLD TO MATURITY, ADJUSTED GROSS, ADJUSTED NET) |

element **OtherPricesType/Price/NavPrice**

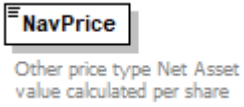
|            |   |
|------------|---|
| diagram    |  |
| type       | <b>xs:decimal</b>   |
| properties | isRef 0<br>content simple   |
| annotation | documentation<br>Other price type Net Asset value calculated per share            |

element **OtherPricesType/Price/SubscriptionPrice**

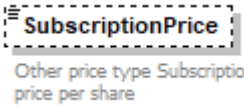
|            |   |
|------------|---|
| diagram    |  |
| type       | <b>xs:decimal</b>   |
| properties | isRef 0<br>minOcc 0<br>maxOcc 1<br>content simple                                   |
| annotation | documentation<br>Other price type Subscription price per share                      |

element **OtherPricesType/Price/RedemptionPrice**

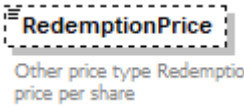
|            |   |
|------------|---|
| diagram    |  |
| type       | <b>xs:decimal</b>   |
| properties | isRef 0<br>minOcc 0<br>maxOcc 1   |

|            |  |
|------------|--|
|            | content simple   |
| annotation | documentation<br>Other price type Redemption price per share |

### complexType PositiveAmountType

|            |   |
|------------|---|
| diagram    |   |
| children   | <a href="#">Amount</a>  |
| used by    | elements <a href="#">DistributionType/GrossDividendAmount/PerShare</a> <a href="#">DistributionType/NetDividendAmount/PerShare</a><br><a href="#">DistributionType/GrossDividendAmount/Total</a> <a href="#">DistributionType/NetDividendAmount/Total</a> |
| annotation | documentation<br>Amount in different currencies - only positive values<br>documentation<br>Betrag in verschiedenen Waehrungen - nur positive Werte erlaubt  |

### element PositiveAmountType/Amount

|            |   |
|------------|---|
| diagram    |   |
| type       | extension of <a href="#">positiveDecimals</a>   |
| properties | isRef 0<br>minOcc 1<br>maxOcc unbounded<br>content complex  |
| facets     | Kind Value annotation<br>minExclusive 0   |
| annotation | documentation<br>Amounts in currency as defined in attribute - only positive values<br>documentation<br>Betrag in frei waehlbarer Waehrung - nur positive Werte erlaubt |

### attribute PositiveAmountType/Amount/@ccy

|            |   |
|------------|---|
| type       | <a href="#">ISOCurrencyCodeType</a>                                     |
| properties | isRef 0<br>use required   |
| facets     | Kind Value annotation<br>minLength 3<br>maxLength 3<br>pattern [A-Z]{3} |

attribute **PositiveAmountType/Amount/@isFundCcy**

|            |                   |
|------------|-------------------|
| type       | <b>xs:boolean</b> |
| properties | isRef 0           |

attribute **PositiveAmountType/Amount/@isSubfundCcy**

|            |                   |
|------------|-------------------|
| type       | <b>xs:boolean</b> |
| properties | isRef 0           |

attribute **PositiveAmountType/Amount/@isShareClassCcy**

|            |                   |
|------------|-------------------|
| type       | <b>xs:boolean</b> |
| properties | isRef 0           |

complexType **ShareClassTypeType**

|          |   |
|----------|---|
| diagram  |   |
| children | <a href="#">Code</a> <a href="#">EarningUse</a> <a href="#">Name</a> <a href="#">Description</a>            |
| used by  | elements <a href="#">ShareClassType/ShareClassType</a> <a href="#">ShareClassDetailsType/ShareClassType</a> |

element **ShareClassTypeType/Code**

|            |                                       |
|------------|---------------------------------------|
| diagram    |                                       |
| type       | <a href="#">Text32Type</a>            |
| properties | isRef 0<br>content simple             |
| facets     | Kind Value annotation<br>maxLength 32 |

|            |   |
|------------|---|
| annotation | documentation<br>Country specific code for share class type |
|------------|---|

element **ShareClassType/EarningUse**

|            |   |
|------------|---|
| diagram    |      |
| type       | restriction of <b>xs:string</b>   |
| properties | isRef 0<br>minOcc 0<br>maxOcc 1<br>content simple                                     |
| facets     | Kind Value annotation<br>length 1   |
| annotation | documentation<br>D ... Distributing<br>P ... Partly Distributing<br>R ... Reinvesting |

element **ShareClassType/Name**

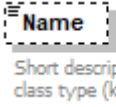
|            |  |
|------------|--|
| diagram    |  |
| type       | <a href="#">Text256Type</a>  |
| properties | isRef 0<br>minOcc 0<br>maxOcc 1<br>content simple                                  |
| facets     | Kind Value annotation<br>maxLength 256   |
| annotation | documentation<br>Short description of share class type (keywords)                  |

element **ShareClassType/Description**

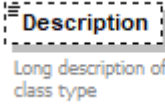
|            |   |
|------------|---|
| diagram    |  |
| type       | <a href="#">Text1000Type</a>  |
| properties | isRef 0<br>minOcc 0<br>maxOcc 1<br>content simple                                   |
| facets     | Kind Value annotation<br>maxLength 1000   |
| annotation | documentation<br>Long description of share class type                               |

complexType **SingleAmountType**

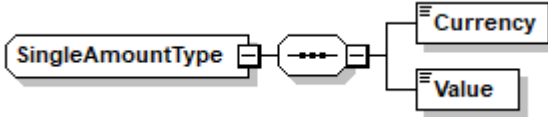
|          |  |
|----------|--|
| diagram  |                               |
| children | <a href="#">Currency</a> <a href="#">Value</a>   |
| used by  | elements <a href="#">TransactionType/FxSpot/BoughtAmount</a> <a href="#">TransactionType/FxSpot/SoldAmount</a> |

element **SingleAmountType/Currency**

|            |   |
|------------|---|
| diagram    |  |
| type       | <a href="#">ISOCurrencyCodeType</a>   |
| properties | isRef 0<br>content simple   |
| facets     | Kind Value annotation<br>minLength 3<br>maxLength 3<br>pattern [A-Z]{3}           |

element **SingleAmountType/Value**

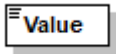
|            |   |
|------------|---|
| diagram    |  |
| type       | <b>xs:decimal</b>   |
| properties | isRef 0<br>content simple   |



complexType **TotalAssetValueType**

|                 |  |
|-----------------|--|
| <p>diagram</p>  | <p><b>TotalAssetValueType</b></p> <ul style="list-style-type: none"> <li><b>NavDate</b></li> <li><b>TotalAssetNature</b><br/>Information whether the calculated total asset value is an official, estimated or technical value</li> <li><b>TotalNetAssetValue</b> (+)<br/>The total amount of net assets of an investment vehicle calculated as the sum of all portfolio holdings including liabilities</li> <li><b>TotalGrossAssetValue</b> (+)<br/>Total gross assets of closed ended funds and open material assets funds, which means the still existing retail and special real estate funds of the "old" world. Real investment excluding liabilities</li> <li><b>SharesOutstanding</b><br/>Number of shares which are issued and used as a basis for the calculation of the NAV</li> <li><b>Ratio</b><br/>Weight of the share class within the fund in percentage (sum is 100%)</li> <li><b>OtherTotalAssetValues</b> (+)<br/>Additional total asset values (Swing, Maturity, ...)</li> </ul> |
| <p>children</p> | <p><a href="#">NavDate</a> <a href="#">TotalAssetNature</a> <a href="#">TotalNetAssetValue</a> <a href="#">TotalGrossAssetValue</a> <a href="#">SharesOutstanding</a> <a href="#">Ratio</a> <a href="#">OtherTotalAssetValues</a></p>  |
| <p>used by</p>  | <p>elements <a href="#">SegmentDynamicDataType/TotalAssetValues/TotalAssetValue</a><br/> <a href="#">FundDynamicDataType/TotalAssetValues/TotalAssetValue</a><br/> <a href="#">ShareClassType/TotalAssetValues/TotalAssetValue</a></p>   |

element **TotalAssetValueType/NavDate**

|                   |                                   |
|-------------------|-----------------------------------|
| <p>diagram</p>    | <p><b>NavDate</b></p>             |
| <p>type</p>       | <p><b>xs:date</b></p>             |
| <p>properties</p> | <p>isRef 0<br/>content simple</p> |

element **TotalAssetValueType/TotalAssetNature**

|            |   |
|------------|---|
| diagram    |  <p><b>TotalAssetNature</b></p> <p>Information whether the calculated total asset value is an official, estimated or technical value</p> |
| type       | restriction of <b>xs:string</b>   |
| properties | isRef 0<br>content simple   |
| facets     | Kind Value annotation<br>minLength 8<br>maxLength 9   |
| annotation | documentation<br>Information whether the calculated total asset value is an official, estimated or technical value  |

element **TotalAssetValueType/TotalNetAssetValue**

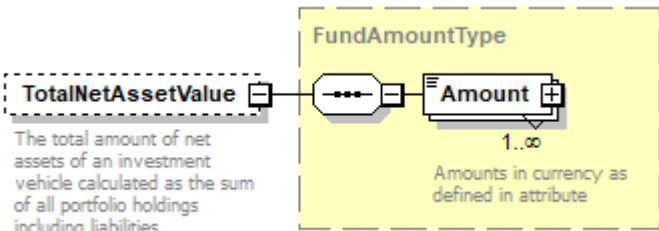
|            |  |
|------------|--|
| diagram    |  <p><b>TotalNetAssetValue</b></p> <p>The total amount of net assets of an investment vehicle calculated as the sum of all portfolio holdings including liabilities</p> <p><b>FundAmountType</b></p> <p><b>Amount</b></p> <p>1..∞</p> <p>Amounts in currency as defined in attribute</p> |
| type       | <a href="#">FundAmountType</a>   |
| properties | isRef 0<br>minOcc 0<br>maxOcc 1<br>content complex   |
| children   | <a href="#">Amount</a>   |
| annotation | documentation<br>The total amount of net assets of an investment vehicle calculated as the sum of all portfolio holdings including liabilities   |

element **TotalAssetValueType/TotalGrossAssetValue**

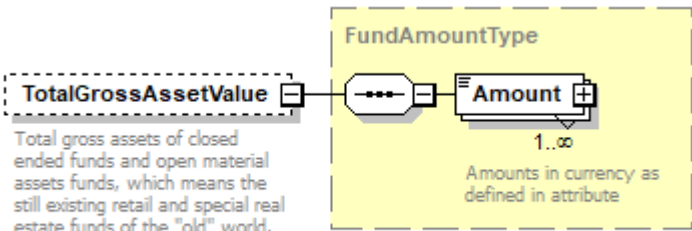
|            |   |
|------------|---|
| diagram    |  <p><b>TotalGrossAssetValue</b></p> <p>Total gross assets of closed ended funds and open material assets funds, which means the still existing retail and special real estate funds of the "old" world. Real investment excluding liabilities</p> <p><b>FundAmountType</b></p> <p><b>Amount</b></p> <p>1..∞</p> <p>Amounts in currency as defined in attribute</p> |
| type       | <a href="#">FundAmountType</a>  |
| properties | isRef 0<br>minOcc 0<br>maxOcc 1<br>content complex  |
| children   | <a href="#">Amount</a>  |

|            |   |
|------------|---|
| annotation | documentation<br>Total gross assets of closed ended funds and open material assets funds, which means the still existing retail and special real estate funds of the "old" world. Real investment excluding liabilities |
|------------|---|

element **TotalAssetValueType/SharesOutstanding**

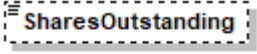
|            |   |
|------------|---|
| diagram    |  <p>Number of shares which are issued and used as a basis for the calculation of the NAV</p> |
| type       | <b>xs:decimal</b>   |
| properties | isRef 0<br>minOcc 0<br>maxOcc 1<br>content simple   |
| annotation | documentation<br>Number of shares which are issued and used as a basis for the calculation of the NAV   |

element **TotalAssetValueType/Ratio**

|            |  |
|------------|--|
| diagram    |  <p>Weight of the share class within the fund in percentage (sum is 100%)</p>   |
| type       | <a href="#">PercentageType</a>   |
| properties | isRef 0<br>minOcc 0<br>maxOcc 1<br>content simple  |
| annotation | documentation<br>Weight of the share class within the fund in percentage (sum is 100%)<br>appinfo<br><altova:exampleValues><br><altova:example value="30"/><br><altova:example value="70"/><br></altova:exampleValues> |

element **TotalAssetValueType/OtherTotalAssetValues**

|                   |   |
|-------------------|---|
| <p>diagram</p>    | <p><b>TotalAssetType</b><br/>Select the total asset type you would like to communicate (SWING, MATURITY, MARKET,HOLD TO MATURITY)</p> <p><b>TotalNetAssetValue</b> +<br/>The total amount of net assets of an investment vehicle calculated as the sum of all portfolio holdings including liabilities</p> <p><b>TotalGrossAssetValue</b> +<br/>Total gross assets of closed ended funds and open material assets funds, which means the still existing retail and special real estate funds of the "old" world. Real investment excluding liabilities</p> <p><b>Ratio</b><br/>Weight of the share class within the fund in percentage (sum is 100%)</p> <p><b>OtherTotalAssetValues</b> +<br/>Additional total asset values (Swing, Maturity, ...)</p> |
| <p>properties</p> | <p>isRef 0<br/>minOcc 0<br/>maxOcc 1<br/>content complex</p>  |
| <p>children</p>   | <p><a href="#">TotalAssetType</a> <a href="#">TotalNetAssetValue</a> <a href="#">TotalGrossAssetValue</a> <a href="#">Ratio</a></p>   |
| <p>annotation</p> | <p>documentation<br/>Additional total asset values (Swing, Maturity, ...)</p>   |

element **TotalAssetValueType/OtherTotalAssetValues/TotalAssetType**

|                   |   |
|-------------------|---|
| <p>diagram</p>    | <p><b>TotalAssetType</b><br/>Select the total asset type you would like to communicate (SWING, MATURITY, MARKET,HOLD TO MATURITY)</p> |
| <p>type</p>       | <p>restriction of <b>xs:string</b></p>  |
| <p>properties</p> | <p>isRef 0<br/>content simple</p>   |
| <p>facets</p>     | <p>Kind Value annotation<br/>minLength 5<br/>maxLength 16</p>   |
| <p>annotation</p> | <p>documentation<br/>Select the total asset type you would like to communicate (SWING, MATURITY, MARKET,HOLD TO MATURITY)</p>         |

element **TotalAssetValueType/OtherTotalAssetValues/TotalNetAssetValue**

|            |  |
|------------|--|
| diagram    | <p>The total amount of net assets of an investment vehicle calculated as the sum of all portfolio holdings including liabilities</p>           |
| type       | <a href="#">FundAmountType</a>   |
| properties | isRef 0<br>minOcc 0<br>maxOcc 1<br>content complex   |
| children   | <a href="#">Amount</a>   |
| annotation | documentation<br>The total amount of net assets of an investment vehicle calculated as the sum of all portfolio holdings including liabilities |

element **TotalAssetValueType/OtherTotalAssetValues/TotalGrossAssetValue**

|            |   |
|------------|---|
| diagram    | <p>Total gross assets of closed ended funds and open material assets funds, which means the still existing retail and special real estate funds of the "old" world. Real investment excluding liabilities</p>           |
| type       | <a href="#">FundAmountType</a>  |
| properties | isRef 0<br>minOcc 0<br>maxOcc 1<br>content complex  |
| children   | <a href="#">Amount</a>  |
| annotation | documentation<br>Total gross assets of closed ended funds and open material assets funds, which means the still existing retail and special real estate funds of the "old" world. Real investment excluding liabilities |

element **TotalAssetValueType/OtherTotalAssetValues/Ratio**

|            |  |
|------------|--|
| diagram    | <p>Weight of the share class within the fund in percentage (sum is 100%)</p>           |
| type       | <a href="#">PercentageType</a>   |
| properties | isRef 0<br>minOcc 0<br>maxOcc 1<br>content simple                                      |
| annotation | documentation<br>Weight of the share class within the fund in percentage (sum is 100%) |

### simpleType BicCodeType

|            |  |            |       |            |           |   |  |           |    |  |
|------------|--|------------|-------|------------|-----------|---|--|-----------|----|--|
| type       | restriction of <b>xs:string</b>  |            |       |            |           |   |  |           |    |  |
| properties | base <b>xs:string</b>  |            |       |            |           |   |  |           |    |  |
| used by    | elements <a href="#">CounterpartyType/BIC IdentifiersType/SwiftBIC</a>   |            |       |            |           |   |  |           |    |  |
| facets     | <table border="1"> <tr> <td>Kind</td> <td>Value</td> <td>annotation</td> </tr> <tr> <td>minLength</td> <td>3</td> <td></td> </tr> <tr> <td>maxLength</td> <td>12</td> <td></td> </tr> </table> | Kind       | Value | annotation | minLength | 3 |  | maxLength | 12 |  |
| Kind       | Value  | annotation |       |            |           |   |  |           |    |  |
| minLength  | 3  |            |       |            |           |   |  |           |    |  |
| maxLength  | 12   |            |       |            |           |   |  |           |    |  |
| annotation | documentation<br>BIC Code (SWIFT)  |            |       |            |           |   |  |           |    |  |

### simpleType CompanyListedClassificationType

|            |   |
|------------|---|
| type       | restriction of <b>xs:string</b>                                       |
| properties | base <b>xs:string</b>   |
| used by    | attribute <a href="#">CompanyType/OtherClassification/@ListedType</a> |
| annotation | documentation<br>List of company classifications                      |

### simpleType EmailAddressType

|            |   |            |       |            |         |  |  |
|------------|---|------------|-------|------------|---------|--|--|
| type       | restriction of <b>xs:string</b>   |            |       |            |         |  |  |
| properties | base <b>xs:string</b>   |            |       |            |         |  |  |
| used by    | elements <a href="#">DataSupplierType/Contact/Email AddressType/Email</a><br><a href="#">CountrySpecificShareClassDataAType/OeKBStammdatenblatt/EMail</a><br><a href="#">EMT_V4_FinancialInstrumentType/GeneralInformation/ManufacturerEmail</a><br><a href="#">EMT_V41_FinancialInstrumentType/GeneralInformation/ManufacturerEmail</a><br><a href="#">EMT_V3_FinancialInstrumentType/GeneralInformation/ManufacturerEmail</a><br><a href="#">EMT_V4_FinancialInstrumentType/DataSetInformation/ProducerEmail</a><br><a href="#">EMT_V41_FinancialInstrumentType/DataSetInformation/ProducerEmail</a><br><a href="#">EMT_V3_FinancialInstrumentType/DataSetInformation/ProducerEmail</a> |            |       |            |         |  |  |
| facets     | <table border="1"> <tr> <td>Kind</td> <td>Value</td> <td>annotation</td> </tr> <tr> <td>pattern</td> <td><code>[_\a-zA-Z0-9\.\+]+\@[a-zA-Z0-9](\.[a-zA-Z0-9]*[a-zA-Z0-9])*</code></td> <td></td> </tr> </table>   | Kind       | Value | annotation | pattern | <code>[_\a-zA-Z0-9\.\+]+\@[a-zA-Z0-9](\.[a-zA-Z0-9]*[a-zA-Z0-9])*</code> |  |
| Kind       | Value   | annotation |       |            |         |  |  |
| pattern    | <code>[_\a-zA-Z0-9\.\+]+\@[a-zA-Z0-9](\.[a-zA-Z0-9]*[a-zA-Z0-9])*</code>  |            |       |            |         |  |  |

### simpleType FrequencyType

|            |  |
|------------|--|
| type       | restriction of <b>xs:string</b>  |
| properties | base <b>xs:string</b>  |
| used by    | elements <a href="#">FlowType/DataGroupedByFrequency SwapType/Legs/Leg/FixingFrequency RiskCodeType/Frequency</a><br><a href="#">BondType/Redemption/Frequency SwapType/Legs/Leg/PayFrequency</a><br><a href="#">BondType/Coupon/PaymentFrequency CommercialPaperType/Coupon/PaymentFrequency</a><br><a href="#">HighWatermarkType/ResetFrequency TotalReturnType/Investment/SavingsPlanFrequency</a><br><a href="#">PerformanceType/Investment/SavingsPlanFrequency</a> |
| annotation | documentation<br>Frequency:<br>DAIL ... Daily<br>MNTH ... Monthly<br>QURT ... Quarterly<br>SEMI ... Semiannual<br>TWMN ... Twomonthly<br>TWWK ... Twoweekly<br>WEEK ... Weekly<br>YEAR   |

### simpleType ISINType

|            |   |  |            |
|------------|---|--|------------|
| type       | restriction of <b>xs:string</b>   |  |            |
| properties | base <b>xs:string</b>   |  |            |
| used by    | elements  | <a href="#">IdentifiersType/ISIN</a> <a href="#">FundOrShareClassIdentifiersType/ISINs/ISIN</a><br><a href="#">CountrySpecificAssetMasterDataATType/OeKBStammdatenblatt/Block1/ISIN</a><br><a href="#">CountrySpecificAssetMasterDataATType/OeKBStammdatenblatt/Block1/BestehendeTranchen/ISIN</a><br><a href="#">CountrySpecificShareClassDataATType/OeKBStammdatenblatt/ISIN</a><br><a href="#">SIIPositionType_V6/LookThroughIdentifier</a> <a href="#">SIIPositionType/LookThroughISIN</a><br><a href="#">SIIPositionType_V5/LookThroughISIN</a> |            |
| facets     | Kind  | Value  | annotation |
|            | length  | 12   |            |
|            | pattern   | [A-Z]{2}[A-Z0-9]{9}[0-9]{1}  |            |
| annotation | documentation<br>International Securities Identification Number (according to ISO 6166) |  |            |

### simpleType ISOCountryCodeType

|            |   |   |            |
|------------|---|---|------------|
| type       | restriction of <b>xs:string</b>   |   |            |
| properties | base <b>xs:string</b>   |   |            |
| used by    | elements  | <a href="#">CompanyType/BusinessCountry</a> <a href="#">IssuerType/BusinessCountry</a><br><a href="#">DocumentType/PublicationCountries/Country</a><br><a href="#">SolvencyIIPortfolioType/QRTPortfolioInformation/FundIssuer/Country</a> <a href="#">IssuerType/Country</a><br><a href="#">AddressType/Country</a> <a href="#">FundRelatedTextType/CountriesWhereApplicable/Country</a><br><a href="#">SolvencyIIPortfolioType_V5/QRTPortfolioInformation/FundIssuer/Country</a><br><a href="#">SIIPositionType/DerivativeOrConvertible/UnderlyingInstrument/Valuation/Country</a><br><a href="#">SIIPositionType_V5/DerivativeOrConvertible/UnderlyingInstrument/Valuation/Country</a><br><a href="#">ShareClassType/BlockedInvestorCountries/Country</a> <a href="#">AssetType/Country</a><br><a href="#">InvestorTypesType/CentralBank/Country</a> <a href="#">CounterpartyType/Country</a><br><a href="#">SolvencyIIPortfolioType_V6/QRTPortfolioInformation/FundIssuer/Country</a><br><a href="#">AssetManagementCompanyAggregatedType/Country</a><br><a href="#">SIIPositionType_V6/DerivativeOrConvertible/UnderlyingInstrument/Valuation/Country</a><br><a href="#">ShareClassType/RegistrationCountries/RegistrationCountry/CountryCode</a><br><a href="#">KIIDType/PracticalInformation/MasterFundInformation/CountryOfDomicile</a><br><a href="#">FundStaticDataType/DomicileCountry</a><br><a href="#">SolvencyIIPortfolioType_V6/QRTPortfolioInformation/FundCustodianCountry</a><br><a href="#">SolvencyIIPortfolioType_V5/QRTPortfolioInformation/FundCustodianCountry</a><br><a href="#">SolvencyIIPortfolioType/QRTPortfolioInformation/FundCustodianCountry</a><br><a href="#">KIIDType/PracticalInformation/FurtherInformation/FurtherInformationLanguage</a><br><a href="#">CountrySpecificShareClassDataATType/OeKBStammdatenblatt/GeltendesRecht</a><br><a href="#">FlowType/InvestorCountry</a> <a href="#">InvestorType/InvestorCountry</a> <a href="#">CreditRiskDataType/IssuerCountry</a><br><a href="#">CreditRiskDataType_V5/IssuerCountry</a> <a href="#">CreditRiskDataType_V6/IssuerCountry</a><br><a href="#">KIIDType/PracticalInformation/MasterFundInformation/Prospectus/Language</a><br><a href="#">EETReportType1.1.2/ComplementaryInformation/Social/ListOfInvestedCountries</a><br><a href="#">DataSupplierType/SystemCountry</a> |            |
| facets     | Kind  | Value   | annotation |
|            | minLength   | 2   |            |
|            | maxLength   | 2   |            |
| annotation | documentation<br>The ISOCountryCodeType is a type for decoding ISO-CountryCodes. It is used the two-letter ISO-CountryCodes (ISO 3166-1alpha-2). It is of the type string and has a length from exactly two letters.<br>documentation<br>Der ISOCountryCodeType stellt einen einfachen Typ zur Verarbeitung von ISO-Laendercodes bereit. Verwendet werden die zweistelligen ISO-Waehrungscodes (ISO 3166-1alpha-2). Er ist vom Typ string und hat eine Laenge von zwei Zeichen. |   |            |

## simpleType ISOCurrencyCodeType

|            |   |
|------------|---|
| type       | restriction of <b>xs:string</b>   |
| properties | base <b>xs:string</b>   |
| used by    | <p>elements</p> <p><a href="#">EMIR_ReportType/CounterpartyData/CollateralCurrency</a><br/> <a href="#">EMIR_ReportType/CounterpartyData/ContractMtMValueCurrency</a> <a href="#">DocumentType/Fund/Currency</a><br/> <a href="#">DocumentType/Subfunds/Subfund/Currency</a> <a href="#">DocumentType/ShareClasses/ShareClass/Currency</a><br/> <a href="#">SegmentType/Currency</a> <a href="#">FundType/Currency</a> <a href="#">SubfundType/Currency</a> <a href="#">SingleAmountType/Currency</a><br/> <a href="#">AUMType/Currency</a> <a href="#">TransactionType/Currency</a> <a href="#">BenchmarkStaticDataType/Currency</a><br/> <a href="#">PositionType/Currency</a> <a href="#">PositionUnderlyingType/Currency</a><br/> <a href="#">AssetManagementCompanyAggregatedType/Currency</a><br/> <a href="#">RealEstateType/InvestmentCosts/ConstructionCosts/Currency</a><br/> <a href="#">RealEstateType/InvestmentCosts/PurchasePrice/Currency</a> <a href="#">AssetType/Currency</a><br/> <a href="#">SIIPositionType_V6/DerivativeOrConvertible/UnderlyingInstrument/Valuation/Currency</a><br/> <a href="#">TransactionType/CorporateAction/to/Currency</a> <a href="#">ShareClassType/Currency</a><br/> <a href="#">SIIPositionType/DerivativeOrConvertible/UnderlyingInstrument/Valuation/Currency</a><br/> <a href="#">SIIPositionType_V5/DerivativeOrConvertible/UnderlyingInstrument/Valuation/Currency</a><br/> <a href="#">SwapType/Legs/Leg/Currency</a> <a href="#">TotalReturnType/Currency</a><br/> <a href="#">EETReportType1.1.1/GeneralFinancialInstrumentInformation/Currency</a><br/> <a href="#">EETReportType1.1.2/GeneralFinancialInstrumentInformation/Currency</a><br/> <a href="#">EETReportType/GeneralFinancialInstrumentInformation/Currency</a><br/> <a href="#">EETReportType1.1/GeneralFinancialInstrumentInformation/Currency</a><br/> <a href="#">EMIR_ReportType/CommonData/ForeignExchange/Currency2</a><br/> <a href="#">ForeignExchangeTradeType/CurrencyBuy</a> <a href="#">ForeignExchangeTradeType/CurrencySell</a><br/> <a href="#">KIIDType/PastPerformances/CurrencyUsed</a><br/> <a href="#">EMIR_ReportType/CommonData/ContractType/DeliverableCurrency</a><br/> <a href="#">TransactionType/CorporateAction/from/DividendCurrency</a> <a href="#">EarningType/EntryCurrency</a><br/> <a href="#">CountrySpecificAssetMasterDataATTtype/OeKBStammdatenblatt/Block2/Fondswaehrung</a><br/> <a href="#">EarningType/IncomeCurrency</a> <a href="#">AssetType/IncomeCurrency</a><br/> <a href="#">EMT_V4_FinancialInstrumentType/GeneralInformation/InstrumentCurrency</a><br/> <a href="#">EMT_V41_FinancialInstrumentType/GeneralInformation/InstrumentCurrency</a><br/> <a href="#">EMTFinancialInstrumentType/GeneralInformation/InstrumentCurrency</a><br/> <a href="#">EMT_V3_FinancialInstrumentType/GeneralInformation/InstrumentCurrency</a><br/> <a href="#">TransactionType/CorporateAction/from/InterestsCurrency</a><br/> <a href="#">TransactionType/CorporateAction/to/InterestsCurrency</a><br/> <a href="#">CountrySpecificShareClassDataATTtype/OeKBStammdatenblatt/ISIN-Waehrung</a><br/> <a href="#">ShareClassType/MarketPlaces/MarketPlace/NAV/Currency</a><br/> <a href="#">EMIR_ReportType/CommonData/ContractType/NotionalCurrency1</a><br/> <a href="#">EMIR_ReportType/CommonData/ContractType/NotionalCurrency2</a><br/> <a href="#">CEPT_PriceType/Old_share_class_currency</a> <a href="#">DistributionType/PaymentCurrency</a><br/> <a href="#">SolvencyIIPortfolioType_V6/PortfolioCurrency</a> <a href="#">SolvencyIIPortfolioType/PortfolioCurrency</a><br/> <a href="#">PRIIPSType_V20/EPTV2/GeneralPortfolioInformation/PortfolioCurrency</a><br/> <a href="#">SolvencyIIPortfolioType_V5/PortfolioCurrency</a> <a href="#">ShareClassPriceType/PriceCurrency</a><br/> <a href="#">EMIR_ReportType/CommonData/TransactionDetails/PriceNotation</a><br/> <a href="#">SIIPositionType_V6/Valuation/QuotationCurrency</a> <a href="#">SIIPositionType_V5/Valuation/QuotationCurrency</a><br/> <a href="#">SIIPositionType/Valuation/QuotationCurrency</a><br/> <a href="#">CountrySpecificShareClassDataATTtype/OeKBStammdatenblatt/SchwerpunktAnlagewaehrung</a><br/> <a href="#">TransactionType/SettlementCurrency</a><br/> <a href="#">PRIIPS_ReportType/GeneralPortfolioInformation/ShareClassCurrency</a><br/> <a href="#">CEPTV2HistoryType/GeneralPortfolioInformation/ShareClassCurrency</a><br/> <a href="#">CEPTV2PerformanceType/GeneralPortfolioInformation/ShareClassCurrency</a><br/> <a href="#">CEPT_PriceType/SharePriceCurrency</a> <a href="#">ShareClassType/MarketPlaces/MarketPlace/TradingCurrency</a><br/> <a href="#">AmountType/Amount/@ccy</a> <a href="#">PositiveAmountType/Amount/@ccy</a> <a href="#">FundAmountType/Amount/@ccy</a><br/> <a href="#">FXRateType/@fromCcy</a> <a href="#">FXRateType/@toCcy</a></p> <p>attributes</p> |
| facets     | <p>Kind Value annotation</p> <p>minLength 3</p> <p>maxLength 3</p> <p>pattern [A-Z]{3}</p>  |
| annotation | <p>documentation<br/> Three-letter ISO-CurrencyCode (ISO 4217)</p> <p>documentation<br/> Dreistelliger ISO-Waehrungscode (ISO 4217)</p>   |



### simpleType ISOLanguageCodeType

|            |   |
|------------|---|
| type       | restriction of <b>xs:string</b>   |
| properties | base <b>xs:string</b>   |
| used by    | elements <a href="#">FundStaticDataType/PortfolioManagers/PortfolioManager/Biography/BiographyLanguage</a><br><a href="#">PRIIPS_NarrativesType/ReferenceLanguage</a> |
| facets     | Kind Value annotation<br>minLength 2<br>maxLength 2   |
| annotation | documentation<br>The ISOLanguageCodeType is a type for decoding ISO 639-1 Language Code. It is of the type string and has a length from exactly two letters.          |

### simpleType LEICodeType

|            |  |
|------------|--|
| type       | restriction of <b>xs:string</b>  |
| properties | base <b>xs:string</b>  |
| used by    | elements <a href="#">SIIIssuerType_V6/Code SIIIssuerType/Code SIIIssuerType_V5/Code IdentifiersType/LEI</a><br><a href="#">FundOrShareClassIdentifiersType/LEI</a><br><a href="#">CountrySpecificShareClassDataATType/OeKBStammdatenblatt/LEI CounterpartyType/LEI</a><br><a href="#">EETReportType/DataSetInformation/DataSetInformation/Producer/LEI</a><br><a href="#">EETReportType1.1/DataSetInformation/DataSetInformation/Producer/LEI</a><br><a href="#">EETReportType1.1.1/DataSetInformation/DataSetInformation/Producer/LEI</a><br><a href="#">EETReportType1.1.2/DataSetInformation/DataSetInformation/Producer/LEI</a><br><a href="#">CountrySpecificShareClassDataATType/OeKBStammdatenblatt/LEI Depotbank</a><br><a href="#">CountrySpecificShareClassDataATType/OeKBStammdatenblatt/LEI SteuerlicherVertreter</a><br><a href="#">EMT_V4_FinancialInstrumentType/GeneralInformation/ManufacturerLEI</a><br><a href="#">EMT_V41_FinancialInstrumentType/GeneralInformation/ManufacturerLEI</a><br><a href="#">EMT_V3_FinancialInstrumentType/GeneralInformation/ManufacturerLEI</a><br><a href="#">PRIIPSType_V20/EPTV2/GeneralPortfolioInformation/PortfolioManufacturerLEI</a><br><a href="#">EMT_V4_FinancialInstrumentType/DataSetInformation/ProducerLEI</a><br><a href="#">EMT_V41_FinancialInstrumentType/DataSetInformation/ProducerLEI</a><br><a href="#">EMT_V3_FinancialInstrumentType/DataSetInformation/ProducerLEI</a> |
| facets     | Kind Value annotation<br>minLength 20<br>maxLength 20<br>pattern ([0-9a-zA-Z]{18}[0-9]{2})   |
| annotation | documentation<br>Legal Entity Identifier (LEI) (ISO 17442 standard) of the Entity or if not available the Interim Entity Identifier (IEI):<br>•Characters 1-4: A four character prefix allocated uniquely to each LOU.<br>•Characters 5-6: Two reserved characters set to zero.<br>•Characters 7-18: Entity - specific part of the code generated and assigned by LOUs according to transparent, sound and robust allocation policies.<br>•Characters 19-20: Two check digits  |

### simpleType ListedIdentifierType

|            |   |
|------------|---|
| type       | restriction of <b>xs:string</b>                               |
| properties | base <b>xs:string</b>   |
| used by    | attribute <a href="#">IdentifiersType/OtherID/@ListedType</a> |
| annotation | documentation<br>List of all public available Identifiers     |

### simpleType MICCodeType

|      |                                 |
|------|---------------------------------|
| type | restriction of <b>xs:string</b> |
|------|---------------------------------|

|            |  |
|------------|--|
| properties | base xs:string   |
| used by    | elements <a href="#">EquityType/StockMarket</a> <a href="#">BondType/StockMarket</a> <a href="#">ShareClassDetailsType/StockMarket</a> <a href="#">OptionType/StockMarket</a> <a href="#">FutureType/StockMarket</a> <a href="#">CertificateType/StockMarket</a> <a href="#">ReposType/StockMarket</a> <a href="#">CommercialPaperType/StockMarket</a> |
| facets     | Kind Value annotation<br>length 4  |
| annotation | documentation<br>Market Identifier Code - ISO 10383  |

### simpleType PercentageType

|            |   |
|------------|---|
| type       | xs:decimal  |
| properties | base xs:decimal   |
| used by    | elements <a href="#">CountrySpecificAssetMasterDataATType/OeKBStammdatenblatt/Block2/Ausgabeaufschlag</a> <a href="#">SIIPositionType_V6/DerivativeOrConvertible/UnderlyingInstrument/Coupon/CouponRate</a> <a href="#">SIIPositionType/InterestRateInstrumentCharacteristics/CouponRate</a> <a href="#">SIIPositionType_V5/DerivativeOrConvertible/UnderlyingInstrument/Coupon/CouponRate</a> <a href="#">SIIPositionType_V5/InterestRateInstrumentCharacteristics/CouponRate</a> <a href="#">SIIPositionType/DerivativeOrConvertible/UnderlyingInstrument/Coupon/CouponRate</a> <a href="#">SIIPositionType_V6/InterestRateInstrumentCharacteristics/CouponRate</a> <a href="#">DistributionType/EqualizationRate</a> <a href="#">FeePeriodDataType/Values/CalculationBasis/FeeAsPercentageOfBasis</a> <a href="#">FeePeriodDataType/Values/FeeAsPercentageOfTNA</a> <a href="#">PositionType/Option/HedgeRatio</a> <a href="#">PositionType/Swap/HedgeRatio</a> <a href="#">PositionType/Future/HedgeRatio</a> <a href="#">PositionType/FXForward/HedgeRatio</a> <a href="#">PositionType/InflationaryAdjustment</a> <a href="#">EETReportType1.1.1/LastReportedSustainableInvestments/LastReportedInvestmentsNotSustainableOther</a> <a href="#">EETReportType1.1/LastReportedSustainableInvestments/LastReportedInvestmentsNotSustainableOther</a> <a href="#">EETReportType1.1.2/LastReportedSustainableInvestments/LastReportedInvestmentsNotSustainableOther</a> <a href="#">EETReportType1.1.1/LastReportedSustainableInvestments/LastReportedInvestmentsSustainableInvestments</a> <a href="#">EETReportType1.1/LastReportedSustainableInvestments/LastReportedInvestmentsSustainableInvestments</a> <a href="#">EETReportType1.1.2/LastReportedSustainableInvestments/LastReportedInvestmentsSustainableInvestments</a> <a href="#">EETReportType1.1.1/LastReportedSustainableInvestments/LastReportedInvestmentsSustainableInvestmentsEnvironmental</a> <a href="#">EETReportType1.1/LastReportedSustainableInvestments/LastReportedInvestmentsSustainableInvestmentsEnvironmental</a> <a href="#">EETReportType1.1.2/LastReportedSustainableInvestments/LastReportedInvestmentsSustainableInvestmentsEnvironmental</a> <a href="#">EETReportType1.1.1/LastReportedSustainableInvestments/LastReportedInvestmentsSustainableInvestmentsOtherEnvironmental</a> <a href="#">EETReportType1.1.2/LastReportedSustainableInvestments/LastReportedInvestmentsSustainableInvestmentsOtherEnvironmental</a> <a href="#">EETReportType1.1/LastReportedSustainableInvestments/LastReportedInvestmentsSustainableInvestmentsOtherEnvironmental</a> <a href="#">EETReportType1.1/LastReportedSustainableInvestments/LastReportedInvestmentsSustainableInvestmentsSocial</a> <a href="#">EETReportType1.1.2/LastReportedSustainableInvestments/LastReportedInvestmentsSustainableInvestmentsSocial</a> <a href="#">EETReportType1.1.1/LastReportedSustainableInvestments/LastReportedInvestmentsSustainableInvestmentsSocial</a> <a href="#">EETReportType1.1.1/LastReportedSustainableInvestments/LastReportedInvestmentsSustainableInvestmentsTaxonomyAligned</a> <a href="#">EETReportType1.1/LastReportedSustainableInvestments/LastReportedInvestmentsSustainableInvestmentsTaxonomyAligned</a> <a href="#">EETReportType1.1.2/LastReportedSustainableInvestments/LastReportedInvestmentsSustainableInvestmentsTaxonomyAligned</a> <a href="#">EETReportType1.1.1/LastReportedSustainableInvestments/LastReportedInvestmentsWithEnvironmentalOrSocialCharacteristics</a> <a href="#">EETReportType1.1/LastReportedSustainableInvestments/LastReportedInvestmentsWithEnvironmentalOrSocialCharacteristics</a> <a href="#">EETReportType1.1.2/LastReportedSustainableInvestments/LastReportedInvestmentsWithEnvironmentalOrSocialCharacteristics</a> <a href="#">EETReportType1.1.2/LastReportedSustainableInvestments/LastReportedOtherInvestmentsWithEnvironmentalOrSocialCharacteristics</a> |

|                   |  |
|-------------------|--|
|                   | <p> <a href="#">EETReportType1.1/LastReportedSustainableInvestments/LastReportedOtherInvestmentsWithEnvironmentalOrSocialCharacteristics</a><br/> <a href="#">EETReportType1.1.1/LastReportedSustainableInvestments/LastReportedOtherInvestmentsWithEnvironmentalOrSocialCharacteristics</a><br/> <a href="#">EMT_V41_FinancialInstrumentType/TargetMarket/AbilityToBearLosses/LimitedCapitalLossLevel</a><br/> <a href="#">EMT_V4_FinancialInstrumentType/TargetMarket/AbilityToBearLosses/LimitedCapitalLossLevel</a><br/> <a href="#">EMTFinancialInstrumentType/AbilityToBearLosses/LimitedCapitalLossLevel</a><br/> <a href="#">EMT_V3_FinancialInstrumentType/TargetMarket/AbilityToBearLosses/LimitedCapitalLossLevel</a><br/> <a href="#">PositionsDecomposedType/LookThroughLimit</a><br/> <a href="#">SIIPositionType_V6/InterestRateInstrumentCharacteristics/VariableRate/Margin</a><br/> <a href="#">SIIPositionType/InterestRateInstrumentCharacteristics/VariableRate/Margin</a><br/> <a href="#">SIIPositionType_V5/InterestRateInstrumentCharacteristics/VariableRate/Margin</a><br/> <a href="#">CountrySpecificShareClassDataAType/OeKBStammdatenblatt/MaxAusgabeaufschlag</a><br/> <a href="#">ShareClassFeeType/Maximum</a><br/> <a href="#">CountrySpecificShareClassDataAType/OeKBStammdatenblatt/MaxRuecknahmespesen</a><br/> <a href="#">CountrySpecificShareClassDataAType/OeKBStammdatenblatt/MaxVerwaltungsgebuehr</a><br/> <a href="#">ShareClassFeeType/Minimum</a><br/> <a href="#">EETReportType1.1.1/MinimumSustainableInvestments/MinimumInvestmentsSustainableInvestments</a><br/> <a href="#">EETReportType1.1/MinimumSustainableInvestments/MinimumInvestmentsSustainableInvestments</a><br/> <a href="#">EETReportType1.1.2/MinimumSustainableInvestments/MinimumInvestmentsSustainableInvestments</a><br/> <a href="#">EETReportType1.1.2/MinimumSustainableInvestments/MinimumInvestmentsSustainableInvestmentsEnvironmental</a><br/> <a href="#">EETReportType1.1/MinimumSustainableInvestments/MinimumInvestmentsSustainableInvestmentsEnvironmental</a><br/> <a href="#">EETReportType1.1.1/MinimumSustainableInvestments/MinimumInvestmentsSustainableInvestmentsEnvironmental</a><br/> <a href="#">EETReportType1.1.1/MinimumSustainableInvestments/MinimumInvestmentsSustainableInvestmentsOtherEnvironmental</a><br/> <a href="#">EETReportType1.1.2/MinimumSustainableInvestments/MinimumInvestmentsSustainableInvestmentsOtherEnvironmental</a><br/> <a href="#">EETReportType1.1/MinimumSustainableInvestments/MinimumInvestmentsSustainableInvestmentsOtherEnvironmental</a><br/> <a href="#">EETReportType1.1.1/MinimumSustainableInvestments/MinimumInvestmentsSustainableInvestmentsSocial</a><br/> <a href="#">EETReportType1.1/MinimumSustainableInvestments/MinimumInvestmentsSustainableInvestmentsSocial</a><br/> <a href="#">EETReportType1.1.2/MinimumSustainableInvestments/MinimumInvestmentsSustainableInvestmentsSocial</a><br/> <a href="#">EETReportType1.1.2/MinimumSustainableInvestments/MinimumInvestmentsSustainableInvestmentsTaxonomyAligned</a><br/> <a href="#">EETReportType1.1/MinimumSustainableInvestments/MinimumInvestmentsSustainableInvestmentsTaxonomyAligned</a><br/> <a href="#">EETReportType1.1.1/MinimumSustainableInvestments/MinimumInvestmentsSustainableInvestmentsTaxonomyAligned</a><br/> <a href="#">EETReportType1.1.2/MinimumSustainableInvestments/MinimumInvestmentsWithEnvironmentalOrSocialCharacteristics</a><br/> <a href="#">EETReportType1.1.1/MinimumSustainableInvestments/MinimumInvestmentsWithEnvironmentalOrSocialCharacteristics</a><br/> <a href="#">EETReportType1.1/MinimumSustainableInvestments/MinimumInvestmentsWithEnvironmentalOrSocialCharacteristics</a><br/> <a href="#">EETReportType1.1.2/MinimumSustainableInvestments/MinimumOtherInvestmentsWithEnvironmentalOrSocialCharacteristics</a><br/> <a href="#">EETReportType1.1/MinimumSustainableInvestments/MinimumOtherInvestmentsWithEnvironmentalOrSocialCharacteristics</a><br/> <a href="#">EETReportType1.1.1/MinimumSustainableInvestments/MinimumOtherInvestmentsWithEnvironmentalOrSocialCharacteristics</a><br/> <a href="#">EETReportType1.1/SpecificInformationForArt8and9/MinimumSustainableInvestmentSocialObjectiveArt9</a><br/> <a href="#">EETReportType1.1.2/SpecificInformationForArt8and9/MinimumSustainableInvestmentSocialObjectiveArt9</a><br/> <a href="#">EETReportType1.1.1/SpecificInformationForArt8and9/MinimumSustainableInvestmentSocialObjectiveArt9</a><br/> <a href="#">PositionType/PrivateEquity/OwnershipPercentage_HighWatermarkType/Percentage</a><br/> <a href="#">BreakDownsType/BreakDown/Values/Value/Percentage</a><br/> <a href="#">FundStaticDataType/OngoingCosts/OngoingCost/Percentage_TotalReturnType/Value/PercentageValue</a><br/> <a href="#">PerformanceType/PercentageValue_TotalAssetValueType/OtherTotalAssetValues/Ratio</a><br/> <a href="#">TotalAssetValueType/Ratio_DistributionType/ReinvestmentRate</a><br/> <a href="#">CountrySpecificAssetMasterDataAType/OeKBStammdatenblatt/Block2/Ruecknahmespesen</a><br/> <a href="#">PositionType/TotalPercentage</a><br/> <a href="#">CountrySpecificAssetMasterDataAType/OeKBStammdatenblatt/Block2/VerwaltungsgebuehrPA</a><br/> <a href="#">PositionUnderlyingType/Weight</a><br/> <a href="#">BenchmarkStaticDataType/BenchmarkComponents/BenchmarkComponent/Weight</a><br/> <a href="#">EETWeightNumberType1.1/Weight_EarningType/Dividend/WithholdingTaxQuota</a> </p> |
| <p>annotation</p> | <p>documentation<br/> The PercentageType defines the percentage-values. It is derived from decimal. To decimal there is no modification. Percentage values can be expressed in three ways: For 3.5 % it can be written as 3.5 or 1.035 or 0.035. For FundsXML</p>  |

|  |  |
|--|--|
|  | <p>percentage value has to be written as 3.5</p> <p>documentation</p> <p>Der PercentageType definiert die Prozentwerte. Abgeleitet ist er von decimal. Veraendert wurde er nicht. Bei Prozentwerten kann man je nach Definition fuer 3, 5 % die Werte 3.5 oder 1.035 oder 0.035 angeben. Mit diesem Typ dokumentiert FundsXML, dass fuer Prozentwerte die Auspraegung 3.5 benutzt werden muss um eine einheitliche Auspraegung fuer den Datenaustausch zwischen Firmen zu erreichen.</p> |
|--|--|

### simpleType **positiveDecimals**

|              |  |            |       |            |              |   |  |
|--------------|--|------------|-------|------------|--------------|---|--|
| type         | restriction of <b>xs:decimal</b>   |            |       |            |              |   |  |
| properties   | base xs:decimal  |            |       |            |              |   |  |
| used by      | element <a href="#">PositiveAmountType/Amount</a>  |            |       |            |              |   |  |
| facets       | <table> <tr> <td>Kind</td> <td>Value</td> <td>annotation</td> </tr> <tr> <td>minExclusive</td> <td>0</td> <td></td> </tr> </table> | Kind       | Value | annotation | minExclusive | 0 |  |
| Kind         | Value  | annotation |       |            |              |   |  |
| minExclusive | 0  |            |       |            |              |   |  |

### simpleType **Text1000Type**

|            |   |            |       |            |           |      |  |
|------------|---|------------|-------|------------|-----------|------|--|
| type       | restriction of <b>xs:string</b>   |            |       |            |           |      |  |
| properties | base xs:string  |            |       |            |           |      |  |
| used by    | elements <a href="#">ShareClassFeeType/CalculationMethod</a> <a href="#">DistributionType/Comments</a><br><a href="#">ShareClassType/Description</a> <a href="#">RiskCodeType/Description</a> <a href="#">HighWatermarkType/Description</a><br><a href="#">TransactionType/CorporateAction/CorporateActionDocument/DocumentURL</a><br><a href="#">EarningType/PostingText</a> |            |       |            |           |      |  |
| facets     | <table> <tr> <td>Kind</td> <td>Value</td> <td>annotation</td> </tr> <tr> <td>maxLength</td> <td>1000</td> <td></td> </tr> </table>  | Kind       | Value | annotation | maxLength | 1000 |  |
| Kind       | Value   | annotation |       |            |           |      |  |
| maxLength  | 1000  |            |       |            |           |      |  |
| annotation | documentation<br>Text (max. 1000 characters)  |            |       |            |           |      |  |

### simpleType **Text100Type**

|            |  |            |       |            |           |     |  |
|------------|--|------------|-------|------------|-----------|-----|--|
| type       | restriction of <b>xs:string</b>  |            |       |            |           |     |  |
| properties | base xs:string   |            |       |            |           |     |  |
| used by    | elements <a href="#">EarningType/ReferenceNumber</a> <a href="#">NamesType/ShortName</a> <a href="#">FundRelatedTextType/UnlistedType</a><br>attribute <a href="#">IdentifiersType/OtherID/@FreeType</a> |            |       |            |           |     |  |
| facets     | <table> <tr> <td>Kind</td> <td>Value</td> <td>annotation</td> </tr> <tr> <td>maxLength</td> <td>100</td> <td></td> </tr> </table>  | Kind       | Value | annotation | maxLength | 100 |  |
| Kind       | Value  | annotation |       |            |           |     |  |
| maxLength  | 100  |            |       |            |           |     |  |
| annotation | documentation<br>Text (max. 100 characters)  |            |       |            |           |     |  |

### simpleType **Text128Type**

|            |  |            |       |            |           |     |  |
|------------|--|------------|-------|------------|-----------|-----|--|
| type       | restriction of <b>xs:string</b>  |            |       |            |           |     |  |
| properties | base xs:string   |            |       |            |           |     |  |
| used by    | elements <a href="#">ControlDataType/RelatedDocumentIDs/RelatedDocumentID</a> <a href="#">ControlDataType/UniqueDocumentID</a><br><a href="#">DocumentType/Type/UnlistedType</a> |            |       |            |           |     |  |
| facets     | <table> <tr> <td>Kind</td> <td>Value</td> <td>annotation</td> </tr> <tr> <td>maxLength</td> <td>128</td> <td></td> </tr> </table>  | Kind       | Value | annotation | maxLength | 128 |  |
| Kind       | Value  | annotation |       |            |           |     |  |
| maxLength  | 128  |            |       |            |           |     |  |
| annotation | documentation<br>Text (max. 128 characters)  |            |       |            |           |     |  |

### simpleType Text16Type

|            |   |
|------------|---|
| type       | restriction of <b>xs:string</b>   |
| properties | base <b>xs:string</b>   |
| used by    | elements <a href="#">IdentifiersType/Bloomberg/Exchange</a> <a href="#">IdentifiersType/Bloomberg/Market</a><br>attributes <a href="#">IdentifiersType/MexID/@type</a> <a href="#">IdentifiersType/ReutersRIC/@type</a> |
| facets     | Kind Value annotation<br>maxLength 16   |
| annotation | documentation<br>Text (max. 16 characters)  |

### simpleType Text1Type

|            |  |
|------------|--|
| type       | restriction of <b>xs:string</b>  |
| properties | base <b>xs:string</b>  |
| used by    | elements <a href="#">EMT_V4_FinancialInstrumentType/GeneralInformation/Fund/ExPostCostCalculationBasisItaly</a><br><a href="#">EMT_V41_FinancialInstrumentType/GeneralInformation/Fund/ExPostCostCalculationBasisItaly</a><br><a href="#">EMT_V3_FinancialInstrumentType/GeneralInformation/Fund/ExPostCostCalculationBasisItaly</a> |
| facets     | Kind Value annotation<br>maxLength 1   |
| annotation | documentation<br>Text (max. 1 characters)  |

### simpleType Text200Type

|            |  |
|------------|--|
| type       | restriction of <b>xs:string</b>  |
| properties | base <b>xs:string</b>  |
| used by    | elements <a href="#">PositionType/PricingSource/Unlisted</a> <a href="#">FundStaticDataType/UnlistedLegalStructure</a><br><a href="#">FundCompanyType/UnlistedRole</a> <a href="#">SubfundCompanyType/UnlistedRole</a> |
| facets     | Kind Value annotation<br>maxLength 200   |
| annotation | documentation<br>Text (max. 200 characters)  |

### simpleType Text256Type

|            |   |
|------------|---|
| type       | restriction of <b>xs:string</b>   |
| properties | base <b>xs:string</b>   |
| used by    | elements <a href="#">AddressType/Building</a> <a href="#">FlowType/Channel</a> <a href="#">AddressType/CityName</a><br><a href="#">AssetDetailsType/Commodity/Description</a> <a href="#">EarningType/EarningID</a> <a href="#">DocumentType/FileName</a><br><a href="#">DocumentType/Format</a> <a href="#">TransactionType/CorporateAction/CorporateActionDocument/Format</a><br><a href="#">FlowType/InvestorID</a> <a href="#">InvestorType/InvestorID</a> <a href="#">CompanyType/LegalForm</a><br><a href="#">DocumentType/Subfunds/Subfund/Name</a> <a href="#">DocumentType/ShareClasses/ShareClass/Name</a><br><a href="#">DocumentType/Name</a> <a href="#">AttributeType/Name</a> <a href="#">DataSupplierType/Name</a> <a href="#">DataSupplierType/Contact/Name</a><br><a href="#">ShareClassType/Name</a> <a href="#">FundStaticDataType/PortfolioManagers/PortfolioManager/Name</a><br><a href="#">AssetType/Name</a> <a href="#">DocumentType/Fund/Name</a> <a href="#">UnderlyingType/Name</a> <a href="#">RatingType/Note</a><br><a href="#">EarningType/OriginalEarningID</a> <a href="#">TransactionType/OriginalTransactionID</a><br><a href="#">FlowType/OriginalTransactionID</a> <a href="#">IdentifiersType/OtherID</a> <a href="#">AddressType/Phone</a><br><a href="#">PRIIPS_ReportType/GeneralPortfolioInformation/PortfolioName</a><br><a href="#">PRIIPSType_V20/EPTV2/GeneralPortfolioInformation/PortfolioName</a> <a href="#">TransactionType/PostingText</a><br><a href="#">AddressType/State</a> <a href="#">AddressType/StreetName</a> <a href="#">FlowType/TransactionID</a><br><a href="#">TransactionType/TransactionID</a> <a href="#">ShareClassFeeType/Type</a> <a href="#">ClassificationType/Value</a> |
| facets     | Kind Value annotation<br>maxLength 256  |
| annotation | documentation<br>Text (max. 256 characters)   |

### simpleType Text2Type

|            |   |
|------------|---|
| type       | restriction of <b>xs:string</b>           |
| properties | base <b>xs:string</b>                     |
| facets     | Kind Value annotation<br>maxLength 2      |
| annotation | documentation<br>Text (max. 2 characters) |

### simpleType Text300Type

|            |   |
|------------|---|
| type       | restriction of <b>xs:string</b>             |
| properties | base <b>xs:string</b>                       |
| facets     | Kind Value annotation<br>maxLength 300      |
| annotation | documentation<br>Text (max. 300 characters) |

### simpleType Text32Type

|            |   |
|------------|---|
| type       | restriction of <b>xs:string</b>   |
| properties | base <b>xs:string</b>   |
| used by    | elements <a href="#">AddressType/CityCode</a> <a href="#">ShareClassType/Code</a> <a href="#">IdentifiersType/ReutersRIC</a><br><a href="#">AddressType/StreetNumber</a> <a href="#">IdentifiersType/Bloomberg/Ticker</a> |
| facets     | Kind Value annotation<br>maxLength 32   |
| annotation | documentation<br>Text (max. 32 characters)  |

### simpleType Text4Type

|            |  |
|------------|--|
| type       | restriction of <b>xs:string</b>  |
| properties | base <b>xs:string</b>  |
| used by    | elements <a href="#">EMT_V4_FinancialInstrumentType/GeneralInformation/StructuredSecurity/ProductCategoryNature</a><br><a href="#">EMT_V41_FinancialInstrumentType/GeneralInformation/StructuredSecurity/ProductCategoryNature</a><br><a href="#">EMT_V3_FinancialInstrumentType/GeneralInformation/StructuredSecurity/ProductCategoryNature</a> |
| facets     | Kind Value annotation<br>maxLength 4   |
| annotation | documentation<br>Text (max. 4 characters)  |

### simpleType Text500Type

|            |  |
|------------|--|
| type       | restriction of <b>xs:string</b>  |
| properties | base <b>xs:string</b>  |
| used by    | elements <a href="#">TotalReturnType/CalculationMethod</a> <a href="#">NamesType/FullName</a> <a href="#">InvestorType/InvestorName</a><br><a href="#">CompanyType/LegalName</a> <a href="#">NamesType/MarketingName</a> <a href="#">SegmentType/Name</a> <a href="#">CompanyType/Name</a><br><a href="#">LanguageNamesType/Name</a> <a href="#">NamesType/OfficialName</a> <a href="#">NamesType/PreviousName</a> |
| facets     | Kind Value annotation<br>maxLength 500   |
| annotation | documentation<br>Text (max. 500 characters)  |

### simpleType Text64Type

|            |   |
|------------|---|
| type       | restriction of <b>xs:string</b>   |
| properties | base <b>xs:string</b>   |
| used by    | elements <a href="#">AddressType/Fax</a> <a href="#">ClassificationType/ListedGroup</a> <a href="#">IdentifiersType/MexID</a> <a href="#">DataSupplierType/Contact/Phone</a> <a href="#">DataSupplierType/Short</a> <a href="#">DataSupplierType/Type</a> <a href="#">ClassificationType/Type</a> <a href="#">ClassificationType/UnlistedGroup</a> <a href="#">DocumentType/Version</a> |
| facets     | Kind Value annotation<br>maxLength 64   |
| annotation | documentation<br>Text (max. 64 characters)  |

### simpleType Text8Type

|            |   |
|------------|---|
| type       | restriction of <b>xs:string</b>           |
| properties | base <b>xs:string</b>                     |
| facets     | Kind Value annotation<br>maxLength 8      |
| annotation | documentation<br>Text (max. 8 characters) |

### simpleType YesNoType

|            |   |
|------------|---|
| type       | restriction of <b>xs:string</b>   |
| properties | base <b>xs:string</b>   |
| used by    | elements <a href="#">PRIIPSType V20/EPTV2/DataSetInformation/AdditionalInformationStructuredProductsRIY</a> <a href="#">PRIIPS V2 ReturnScenarioType/AutoCallApplied</a> <a href="#">PRIIPS NarrativesType/CapitalGuarantee</a> <a href="#">PRIIPS V2 NarrativesType/CapitalGuarantee</a> <a href="#">PRIIPS NarrativesType/ComprehensionAlert</a> <a href="#">PRIIPSType V20/EPTV2/DataSetInformation/Data ReportingNarratives</a> <a href="#">PRIIPSType V20/EPTV2/DataSetInformation/DataReportingAdditionalRequirementsGermanMOPs</a> <a href="#">PRIIPSType V20/EPTV2/DataSetInformation/DataReportingCosts</a> <a href="#">PRIIPS V2 NarrativesType/DoCostsDependOnInvestedAmount</a> <a href="#">PRIIPS ReportType/GeneralPortfolioInformation/EOSPortfolio</a> <a href="#">PRIIPS DE EPT PiaType/CapitalPreservation/Existing Capital Preservation</a> <a href="#">PRIIPS V2 Country Specific DE/CapitalPreservation/Existing Capital Preservation</a> <a href="#">PRIIPSType V20/EPTV2/RiskAssessment/Existing Credit Risk</a> <a href="#">PRIIPS ReportType/EPT BaseData/RiskAssessment/Existing Credit Risk</a> <a href="#">PRIIPSType V20/EPTV2/Costs/Incidental/ExistingIncidentalCostsPortfolio</a> <a href="#">PRIIPSType V20/EPTV2/Costs/Incidental/ExistingIncidentalCostsPortfolio</a> <a href="#">PRIIPS ReportType/EPT BaseData/Costs/Incidental/ExistingPerformanceFees</a> <a href="#">PRIIPSType V20/EPTV2/RiskAssessment/HasAContractualMaturityDate</a> <a href="#">PRIIPSType V20/EPTV2/RiskAssessment/IS Flexible</a> <a href="#">PRIIPS ReportType/EPT BaseData/RiskAssessment/IS Flexible</a> <a href="#">PRIIPS ReportType/EPT BaseData/RiskAssessment/IS Risk Limit Relevant</a> <a href="#">PRIIPSType V20/EPTV2/RiskAssessment/IS Risk Limit Relevant</a> <a href="#">PRIIPSType V20/EPTV2/GeneralPortfolioInformation/IsAnAutocallableProduct</a> <a href="#">CommercialPaperType/IsAssetBacked</a> <a href="#">PRIIPSType V20/EPTV2/RiskAssessment/IsSRIAdjusted</a> <a href="#">PRIIPSType V20/EPTV2/PerformanceScenario/PortfolioPastPerformanceDisclosureRequired</a> <a href="#">PRIIPS ReportType/EPT SpecificUCITS/PRIIPDataDelivery</a> <a href="#">CEPTV2PriceType/ProxyBenchmarkUsage</a> <a href="#">PRIIPS ReportType/EPT BaseData/Costs/OneOff/SlidingExitCostIndicator</a> <a href="#">PRIIPSType V20/EPTV2/Costs/OneOff/SlidingExitCostIndicator</a> <a href="#">PRIIPS ReportType/EPT SpecificUCITS/UCITS data delivery</a> <a href="#">PRIIPS ReportType/CountrySpecificData/UK/UCITSExistingPerformanceFees</a> <a href="#">PRIIPS ReportType/CountrySpecificData/UK/UCITSExistingPerformanceFees</a> <a href="#">PRIIPS DE EPT PiaType/CapitalPreservation/UsesPI</a> <a href="#">PRIIPS V2 Country Specific DE/CapitalPreservation/UsesPI</a> |
| annotation | documentation   |

|           |
|-----------|
| YES or NO |
|-----------|

**complexType CountrySpecificDataType**

|          |   |
|----------|---|
| diagram  |   |
| children | <a href="#">AT</a> <a href="#">DE</a> <a href="#">DK</a> <a href="#">FR</a> <a href="#">LU</a> <a href="#">NL</a> |
| used by  | element <a href="#">FundsXML4/CountrySpecificData</a>   |

**element CountrySpecificDataType/AT**

|            |  |
|------------|--|
| diagram    |  |
| type       | <a href="#">CountrySpecificDataATType</a>          |
| properties | isRef 0<br>minOcc 0<br>maxOcc 1<br>content complex |
| annotation | documentation<br>Top level data for Austria        |



element **CountrySpecificDataType/DE**

|            |   |
|------------|---|
| diagram    |   |
| type       | <a href="#">CountrySpecificDataDEType</a>                           |
| properties | isRef 0<br>minOcc 0<br>maxOcc 1<br>content complex                  |
| children   | <a href="#">Characteristics</a> <a href="#">CapitalPreservation</a> |
| annotation | documentation<br>Top level data for Germany                         |

element **CountrySpecificDataType/DK**

|            |  |
|------------|--|
| diagram    |  |
| type       | <a href="#">CountrySpecificDataDKType</a>          |
| properties | isRef 0<br>minOcc 0<br>maxOcc 1<br>content complex |
| annotation | documentation<br>Top level data for Denmark        |

element **CountrySpecificDataType/FR**

|            |  |
|------------|--|
| diagram    |  |
| type       | <a href="#">CountrySpecificDataFRType</a>          |
| properties | isRef 0<br>minOcc 0<br>maxOcc 1<br>content complex |
| annotation | documentation<br>Top level data for France         |

element **CountrySpecificDataType/LU**

|            |  |
|------------|--|
| diagram    |  |
| type       | <a href="#">CountrySpecificDataLUType</a>          |
| properties | isRef 0<br>minOcc 0<br>maxOcc 1<br>content complex |
| annotation | documentation<br>Top level data for Luxembourg     |

element **CountrySpecificDataType/NL**

|         |  |
|---------|--|
| diagram |  |
|---------|--|

|            |   |
|------------|---|
| type       | <a href="#">CountrySpecificDataNLType</a>           |
| properties | isRef 0<br>minOcc 0<br>maxOcc 1<br>content complex  |
| annotation | documentation<br>Top level data for the Netherlands |

complexType **CountrySpecificEMT41DataType**

|          |   |
|----------|---|
| diagram  |   |
| children | <a href="#">AT</a> <a href="#">DE</a> <a href="#">DK</a> <a href="#">FR</a> <a href="#">LU</a> <a href="#">NL</a> |

element **CountrySpecificEMT41DataType/AT**

|            |  |
|------------|--|
| diagram    |  |
| type       | <a href="#">CountrySpecificEMT41DataType</a>       |
| properties | isRef 0<br>minOcc 0<br>maxOcc 1<br>content complex |

|            |  |
|------------|--|
| annotation | documentation<br>Shareclass related data for Austria |
|------------|--|

element **CountrySpecificEMT41DataType/DE**

|            |  |
|------------|--|
| diagram    |  |
| type       | <a href="#">CountrySpecificEMTDEType</a>             |
| properties | isRef 0<br>minOcc 0<br>maxOcc 1<br>content complex   |
| children   | <a href="#">EMT_Additional</a>                       |
| annotation | documentation<br>Shareclass related data for Germany |

element **CountrySpecificEMT41DataType/DK**

|            |  |
|------------|--|
| diagram    |  |
| type       | <a href="#">CountrySpecificEMTDKType</a>             |
| properties | isRef 0<br>minOcc 0<br>maxOcc 1<br>content complex   |
| annotation | documentation<br>Shareclass related data for Denmark |

element **CountrySpecificEMT41DataType/FR**

|         |  |
|---------|--|
| diagram |  |
|---------|--|

|            |   |
|------------|---|
| type       | <a href="#">CountrySpecificEMTFRType</a>            |
| properties | isRef 0<br>minOcc 0<br>maxOcc 1<br>content complex  |
| annotation | documentation<br>Shareclass related data for France |

element **CountrySpecificEMT41DataType/LU**

|            |   |
|------------|---|
| diagram    |   |
| type       | <a href="#">CountrySpecificEMTLUType</a>                |
| properties | isRef 0<br>minOcc 0<br>maxOcc 1<br>content complex      |
| annotation | documentation<br>Shareclass related data for Luxembourg |

element **CountrySpecificEMT41DataType/NL**

|            |  |
|------------|--|
| diagram    |  |
| type       | <a href="#">CountrySpecificEMTNLType</a>                     |
| properties | isRef 0<br>minOcc 0<br>maxOcc 1<br>content complex           |
| annotation | documentation<br>Shareclass related data for the Netherlands |

### complexType CountrySpecificEMTDataType

|          |   |
|----------|---|
| diagram  |   |
| children | <a href="#">AT</a> <a href="#">DE</a> <a href="#">DK</a> <a href="#">FR</a> <a href="#">LU</a> <a href="#">NL</a>   |
| used by  | elements <a href="#">EMT_V4_FinancialInstrumentType/CountrySpecificData</a><br><a href="#">EMTFinancialInstrumentType/CountrySpecificData</a><br><a href="#">EMT_V3_FinancialInstrumentType/CountrySpecificData</a> |

### element CountrySpecificEMTDataType/AT

|            |  |
|------------|--|
| diagram    |  |
| type       | <a href="#">CountrySpecificEMTAType</a>              |
| properties | isRef 0<br>minOcc 0<br>maxOcc 1<br>content complex   |
| annotation | documentation<br>Shareclass related data for Austria |

element **CountrySpecificEMTDataType/DE**

|            |  |
|------------|--|
| diagram    |  |
| type       | <a href="#">CountrySpecificEMTDEType</a>             |
| properties | isRef 0<br>minOcc 0<br>maxOcc 1<br>content complex   |
| children   | <a href="#">EMT_Additional</a>                       |
| annotation | documentation<br>Shareclass related data for Germany |

element **CountrySpecificEMTDataType/DK**

|            |  |
|------------|--|
| diagram    |  |
| type       | <a href="#">CountrySpecificEMTDKType</a>             |
| properties | isRef 0<br>minOcc 0<br>maxOcc 1<br>content complex   |
| annotation | documentation<br>Shareclass related data for Denmark |

element **CountrySpecificEMTDataType/FR**

|            |  |
|------------|--|
| diagram    |  |
| type       | <a href="#">CountrySpecificEMTFRType</a> |
| properties | isRef 0<br>minOcc 0<br>maxOcc 1          |

|            |   |
|------------|---|
|            | content complex                                     |
| annotation | documentation<br>Shareclass related data for France |

element **CountrySpecificEMTDataType/LU**

|            |  |
|------------|--|
| diagram    | <p>The diagram shows a yellow box labeled 'CountrySpecificEMTLUType'. Inside, there is a container labeled 'attributes' which contains an 'any' element. To the left, a dashed box labeled 'LU' contains the text 'Shareclass related data for Luxembourg'. A line connects the 'LU' box to the 'any' element inside the 'attributes' container. Below the 'any' element, there is a dashed box containing 'any' and '0..∞'.</p> |
| type       | <a href="#">CountrySpecificEMTLUType</a>   |
| properties | isRef 0<br>minOcc 0<br>maxOcc 1<br>content complex   |
| annotation | documentation<br>Shareclass related data for Luxembourg  |

element **CountrySpecificEMTDataType/NL**

|            |   |
|------------|---|
| diagram    | <p>The diagram shows a yellow box labeled 'CountrySpecificEMTNLType'. Inside, there is a container labeled 'attributes' which contains an 'any' element. To the left, a dashed box labeled 'NL' contains the text 'Shareclass related data for the Netherlands'. A line connects the 'NL' box to the 'any' element inside the 'attributes' container. Below the 'any' element, there is a dashed box containing 'any' and '0..∞'.</p> |
| type       | <a href="#">CountrySpecificEMTNLType</a>  |
| properties | isRef 0<br>minOcc 0<br>maxOcc 1<br>content complex  |
| annotation | documentation<br>Shareclass related data for the Netherlands  |



### complexType CountrySpecificFundDataType

|                 |  |
|-----------------|--|
| <p>diagram</p>  |  |
| <p>children</p> | <p><a href="#">AT</a> <a href="#">DE</a> <a href="#">DK</a> <a href="#">FR</a> <a href="#">LU</a> <a href="#">NL</a></p> |
| <p>used by</p>  | <p>element <a href="#">FundType/CountrySpecificData</a></p>  |

### element CountrySpecificFundDataType/AT

|                   |   |
|-------------------|---|
| <p>diagram</p>    |   |
| <p>type</p>       | <p><a href="#">CountrySpecificFundDataATType</a></p>                                    |
| <p>properties</p> | <p>isRef 0<br/>minOcc 0<br/>maxOcc 1<br/>content complex</p>                            |
| <p>children</p>   | <p><a href="#">OeNB</a> <a href="#">PKG2012</a> <a href="#">FundDataPortalInfos</a></p> |

|            |  |
|------------|--|
| annotation | documentation<br>Fund related data for Austria |
|------------|--|

element **CountrySpecificFundDataDE**

|            |   |
|------------|---|
| diagram    | <p>The diagram shows a dashed box labeled 'CountrySpecificFundDataDEType'. Inside, there is a box labeled 'attributes' containing an 'any' element. Below this, there is a sequence of 'any' elements, with the second one having a cardinality of '0..∞'. A dashed box labeled 'DE' with the text 'Fund related data for Germany' is connected to the 'CountrySpecificFundDataDEType' box.</p> |
| type       | <a href="#">CountrySpecificFundDataDEType</a>   |
| properties | isRef 0<br>minOcc 0<br>maxOcc 1<br>content complex  |
| annotation | documentation<br>Fund related data for Germany  |

element **CountrySpecificFundDataDK**

|            |   |
|------------|---|
| diagram    | <p>The diagram shows a dashed box labeled 'CountrySpecificFundDataDKType'. Inside, there is a box labeled 'attributes' containing an 'any' element. Below this, there is a sequence of 'any' elements, with the second one having a cardinality of '0..∞'. A dashed box labeled 'DK' with the text 'Fund related data for Denmark' is connected to the 'CountrySpecificFundDataDKType' box.</p> |
| type       | <a href="#">CountrySpecificFundDataDKType</a>   |
| properties | isRef 0<br>minOcc 0<br>maxOcc 1<br>content complex  |
| annotation | documentation<br>Fund related data for Denmark  |

element **CountrySpecificFundDataType/FR**

|            |   |
|------------|---|
| diagram    | <p>The diagram shows a dashed box labeled 'CountrySpecificFundDataFRType'. Inside, there is a container labeled 'attributes' containing an 'any' element. Below this, there is a list of 'any' elements, with a multiplicity of '0..∞'. A dashed box labeled 'FR' with the text 'Fund related data for France' is connected to the 'CountrySpecificFundDataFRType' box.</p> |
| type       | <a href="#">CountrySpecificFundDataFRType</a>   |
| properties | <ul style="list-style-type: none"> <li>isRef 0</li> <li>minOcc 0</li> <li>maxOcc 1</li> <li>content complex</li> </ul>  |
| annotation | <ul style="list-style-type: none"> <li>documentation</li> <li>Fund related data for France</li> </ul>   |

element **CountrySpecificFundDataType/LU**

|            |   |
|------------|---|
| diagram    | <p>The diagram shows a dashed box labeled 'CountrySpecificFundDataLUType'. Inside, there is a container labeled 'attributes' containing an 'any' element. Below this, there is a list of 'any' elements, with a multiplicity of '0..∞'. A dashed box labeled 'LU' with the text 'Fund related data for Luxembourg' is connected to the 'CountrySpecificFundDataLUType' box.</p> |
| type       | <a href="#">CountrySpecificFundDataLUType</a>   |
| properties | <ul style="list-style-type: none"> <li>isRef 0</li> <li>minOcc 0</li> <li>maxOcc 1</li> <li>content complex</li> </ul>  |
| annotation | <ul style="list-style-type: none"> <li>documentation</li> <li>Fund related data for Luxembourg</li> </ul>   |

element **CountrySpecificFundDataType/NL**

|         |  |
|---------|--|
| diagram | <p>The diagram shows a dashed box labeled 'CountrySpecificFundDataNLType'. Inside, there is a container labeled 'attributes' containing an 'any' element. Below this, there is a list of 'any' elements, with a multiplicity of '0..∞'. A dashed box labeled 'NL' with the text 'Fund related data for the Netherlands' is connected to the 'CountrySpecificFundDataNLType' box.</p> |
|---------|--|

|            |  |
|------------|--|
| type       | <a href="#">CountrySpecificFundDataNLType</a>          |
| properties | isRef 0<br>minOcc 0<br>maxOcc 1<br>content complex     |
| annotation | documentation<br>Fund related data for the Netherlands |

### complexType [CountrySpecificShareClassDataType](#)

|          |   |
|----------|---|
| diagram  |   |
| children | <a href="#">AT</a> <a href="#">DE</a> <a href="#">DK</a> <a href="#">FR</a> <a href="#">LU</a> <a href="#">NL</a> |
| used by  | element <a href="#">ShareClassType/CountrySpecificData</a>  |

### element [CountrySpecificShareClassDataType/AT](#)

|            |   |
|------------|---|
| diagram    |   |
| type       | <a href="#">CountrySpecificShareClassDataATType</a> |
| properties | isRef 0<br>minOcc 0<br>maxOcc 1<br>content complex  |

|            |  |
|------------|--|
| children   | <a href="#">OeKBStammdatenblatt TotalNetAssetValue</a> |
| annotation | documentation<br>Shareclass related data for Austria   |

### element **CountrySpecificShareClassData/DE**

|            |  |
|------------|--|
| diagram    |  |
| type       | <a href="#">CountrySpecificShareClassDataDEType</a>  |
| properties | isRef 0<br>minOcc 0<br>maxOcc 1<br>content complex   |
| annotation | documentation<br>Shareclass related data for Germany |

### element **CountrySpecificShareClassData/DK**

|            |  |
|------------|--|
| diagram    |  |
| type       | <a href="#">CountrySpecificShareClassDataDKType</a>  |
| properties | isRef 0<br>minOcc 0<br>maxOcc 1<br>content complex   |
| annotation | documentation<br>Shareclass related data for Denmark |

element **CountrySpecificShareClassDataFR**

|            |   |
|------------|---|
| diagram    |   |
| type       | <a href="#">CountrySpecificShareClassDataFRType</a> |
| properties | isRef 0<br>minOcc 0<br>maxOcc 1<br>content complex  |
| annotation | documentation<br>Shareclass related data for France |

element **CountrySpecificShareClassDataLU**

|            |   |
|------------|---|
| diagram    |   |
| type       | <a href="#">CountrySpecificShareClassDataLUType</a>     |
| properties | isRef 0<br>minOcc 0<br>maxOcc 1<br>content complex      |
| annotation | documentation<br>Shareclass related data for Luxembourg |

element **CountrySpecificShareClassDataNL**

|         |  |
|---------|--|
| diagram |  |
|---------|--|

|            |  |
|------------|--|
| type       | <a href="#">CountrySpecificShareClassDataNLType</a>          |
| properties | isRef 0<br>minOcc 0<br>maxOcc 1<br>content complex           |
| annotation | documentation<br>Shareclass related data for the Netherlands |

complexType **BenchmarkProviderCompany**

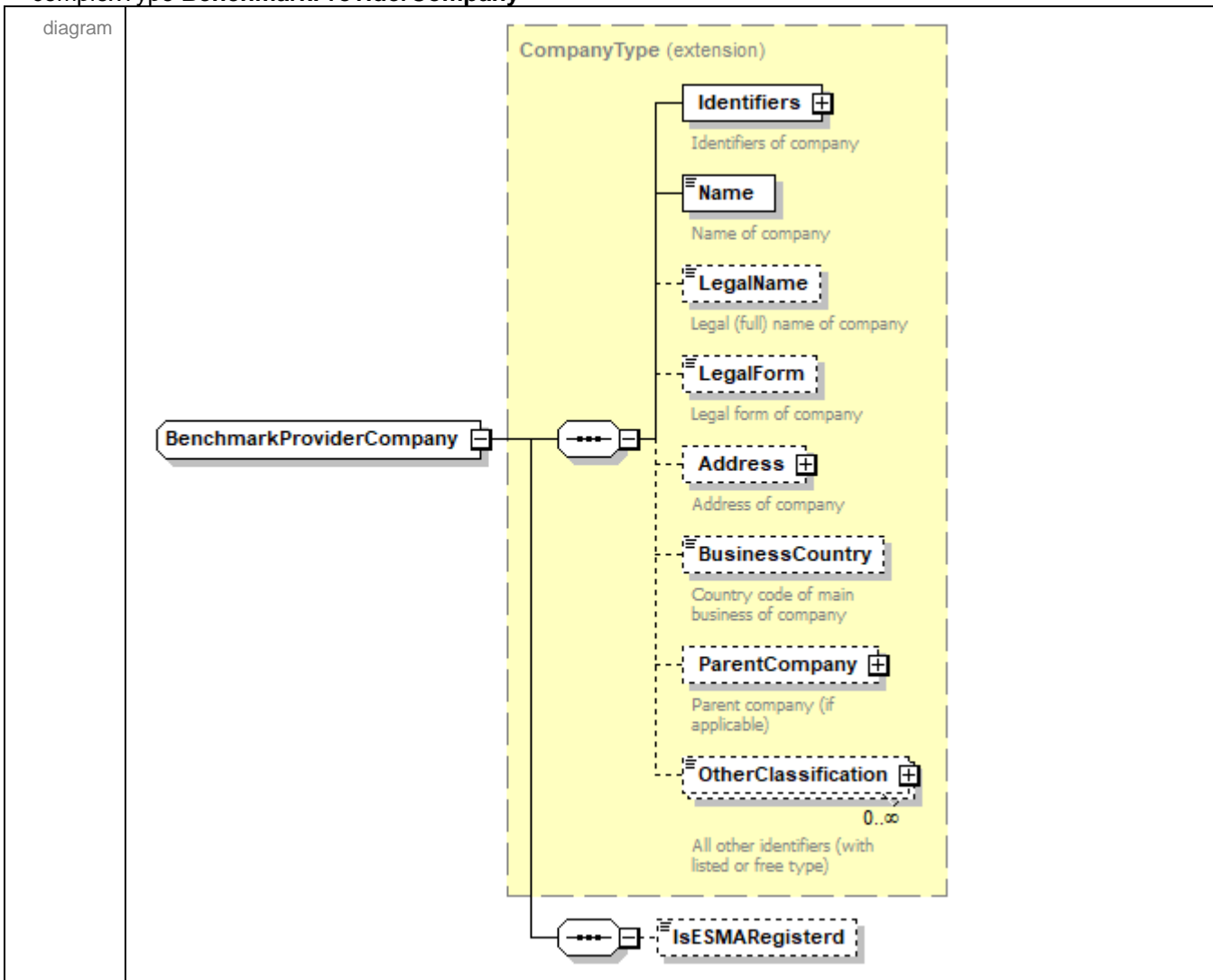

|            |   |
|------------|---|
| type       | extension of <a href="#">CompanyType</a>  |
| properties | base <a href="#">CompanyType</a>  |
| children   | <a href="#">Identifiers</a> <a href="#">Name</a> <a href="#">LegalName</a> <a href="#">LegalForm</a> <a href="#">Address</a> <a href="#">BusinessCountry</a> <a href="#">ParentCompany</a> <a href="#">OtherClassification</a> <a href="#">IsESMARRegisterd</a> |
| used by    | elements <a href="#">BenchmarkStaticDataType/Provider</a><br><a href="#">BenchmarkStaticDataType/BenchmarkComponents/BenchmarkComponent/Provider</a>  |

element **BenchmarkProviderCompany/IsESMARegisterd**

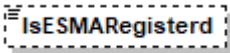
|            |  |       |   |        |   |        |   |         |        |
|------------|--|-------|---|--------|---|--------|---|---------|--------|
| diagram    |   |       |   |        |   |        |   |         |        |
| type       | <b>xs:boolean</b>  |       |   |        |   |        |   |         |        |
| properties | <table border="0"> <tr><td>isRef</td><td>0</td></tr> <tr><td>minOcc</td><td>0</td></tr> <tr><td>maxOcc</td><td>1</td></tr> <tr><td>content</td><td>simple</td></tr> </table> | isRef | 0 | minOcc | 0 | maxOcc | 1 | content | simple |
| isRef      | 0  |       |   |        |   |        |   |         |        |
| minOcc     | 0  |       |   |        |   |        |   |         |        |
| maxOcc     | 1  |       |   |        |   |        |   |         |        |
| content    | simple   |       |   |        |   |        |   |         |        |

complexType **BenchmarkStaticDataType**

|          |   |
|----------|---|
| diagram  |   |
| children | <a href="#">BenchmarkID</a> <a href="#">Name</a> <a href="#">Currency</a> <a href="#">Provider</a> <a href="#">BenchmarkType</a> <a href="#">BenchmarkUsage</a> <a href="#">BenchmarkComponents</a> |
| used by  | element <a href="#">FundStaticDataType/Benchmarks/Benchmark</a>   |

element **BenchmarkStaticDataType/BenchmarkID**

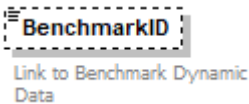
|            |  |            |       |            |           |        |   |         |        |
|------------|--|------------|-------|------------|-----------|--------|---|---------|--------|
| diagram    |   |            |       |            |           |        |   |         |        |
| type       | restriction of <b>xs:string</b>  |            |       |            |           |        |   |         |        |
| properties | <table border="0"> <tr><td>isRef</td><td>0</td></tr> <tr><td>minOcc</td><td>0</td></tr> <tr><td>maxOcc</td><td>1</td></tr> <tr><td>content</td><td>simple</td></tr> </table> | isRef      | 0     | minOcc     | 0         | maxOcc | 1 | content | simple |
| isRef      | 0  |            |       |            |           |        |   |         |        |
| minOcc     | 0  |            |       |            |           |        |   |         |        |
| maxOcc     | 1  |            |       |            |           |        |   |         |        |
| content    | simple   |            |       |            |           |        |   |         |        |
| facets     | <table border="0"> <tr><td>Kind</td><td>Value</td><td>annotation</td></tr> <tr><td>maxLength</td><td>255</td><td></td></tr> </table>   | Kind       | Value | annotation | maxLength | 255    |   |         |        |
| Kind       | Value  | annotation |       |            |           |        |   |         |        |
| maxLength  | 255  |            |       |            |           |        |   |         |        |
| annotation | documentation<br>Link to Benchmark Dynamic Data  |            |       |            |           |        |   |         |        |

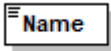

element **BenchmarkStaticDataType/Name**

|            |   |
|------------|---|
| diagram    |  |
| type       | restriction of <b>xs:string</b>   |
| properties | isRef 0<br>content simple   |
| facets     | Kind Value annotation<br>maxLength 255  |

element **BenchmarkStaticDataType/Currency**

|            |   |
|------------|---|
| diagram    |  |
| type       | <a href="#">ISOCurrencyCodeType</a>   |
| properties | isRef 0<br>content simple   |
| facets     | Kind Value annotation<br>minLength 3<br>maxLength 3<br>pattern [A-Z]{3}           |

element **BenchmarkStaticDataType/Provider**

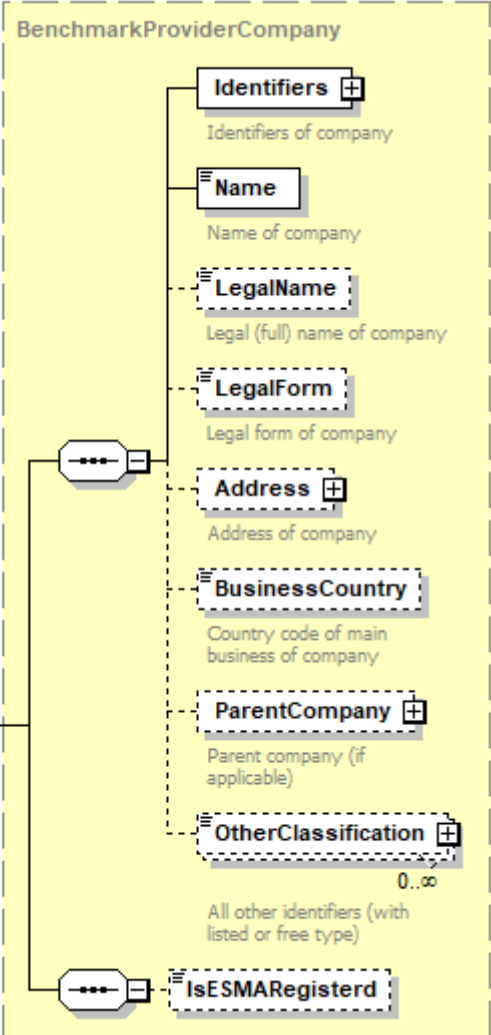
|                   |  |
|-------------------|--|
| <p>diagram</p>    |  <p>The diagram illustrates the structure of the <b>BenchmarkProviderCompany</b> element. It is a complex type containing several child elements:</p> <ul style="list-style-type: none"> <li><b>Identifiers</b>: Identifiers of company (required, 1 occurrence)</li> <li><b>Name</b>: Name of company (required, 1 occurrence)</li> <li><b>LegalName</b>: Legal (full) name of company (required, 1 occurrence)</li> <li><b>LegalForm</b>: Legal form of company (required, 1 occurrence)</li> <li><b>Address</b>: Address of company (required, 1 occurrence)</li> <li><b>BusinessCountry</b>: Country code of main business of company (required, 1 occurrence)</li> <li><b>ParentCompany</b>: Parent company (if applicable) (required, 1 occurrence)</li> <li><b>OtherClassification</b>: All other identifiers (with listed or free type) (required, 0..∞ occurrences)</li> <li><b>IsESMARegistered</b>: (required, 1 occurrence)</li> </ul> <p>The <b>Provider</b> element is shown as a dashed box containing the <b>BenchmarkProviderCompany</b> structure.</p> |
| <p>type</p>       | <p><a href="#">BenchmarkProviderCompany</a></p>  |
| <p>properties</p> | <p>isRef 0<br/>minOcc 0<br/>maxOcc 1<br/>content complex</p>   |
| <p>children</p>   | <p><a href="#">Identifiers</a> <a href="#">Name</a> <a href="#">LegalName</a> <a href="#">LegalForm</a> <a href="#">Address</a> <a href="#">BusinessCountry</a> <a href="#">ParentCompany</a> <a href="#">OtherClassification</a> <a href="#">IsESMARegistered</a></p>   |

element **BenchmarkStaticDataType/BenchmarkType**

|                   |  |
|-------------------|--|
| <p>diagram</p>    |  <p>The diagram shows the <b>BenchmarkType</b> element as a dashed box.</p> |
| <p>type</p>       | <p>restriction of <b>xs:string</b></p>   |
| <p>properties</p> | <p>isRef 0<br/>minOcc 0<br/>maxOcc 1<br/>content simple</p>  |

element **BenchmarkStaticDataType/BenchmarkUsage**

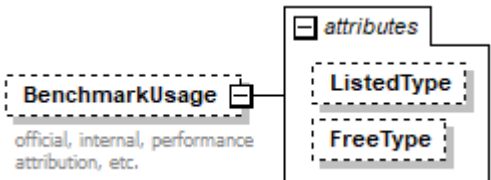
|            |   |
|------------|---|
| diagram    |  |
| properties | isRef 0<br>minOcc 0<br>maxOcc 1<br>content complex                                |
| annotation | documentation<br>official, internal, performance attribution, etc.                |

attribute **BenchmarkStaticDataType/BenchmarkUsage/@ListedType**

|            |                                    |
|------------|------------------------------------|
| type       | <a href="#">BenchmarkUsageType</a> |
| properties | isRef 0                            |

attribute **BenchmarkStaticDataType/BenchmarkUsage/@FreeType**

|            |  |            |       |            |           |     |  |
|------------|--|------------|-------|------------|-----------|-----|--|
| type       | restriction of <b>xs:string</b>  |            |       |            |           |     |  |
| properties | isRef 0  |            |       |            |           |     |  |
| facets     | <table border="0"> <tr> <td>Kind</td> <td>Value</td> <td>annotation</td> </tr> <tr> <td>maxLength</td> <td>100</td> <td></td> </tr> </table> | Kind       | Value | annotation | maxLength | 100 |  |
| Kind       | Value  | annotation |       |            |           |     |  |
| maxLength  | 100  |            |       |            |           |     |  |

element **BenchmarkStaticDataType/BenchmarkComponents**

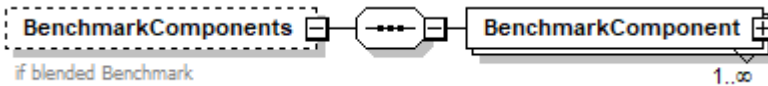
|            |  |
|------------|--|
| diagram    |  |
| properties | isRef 0<br>minOcc 0<br>maxOcc 1<br>content complex                                   |
| children   | <a href="#">BenchmarkComponent</a>   |
| annotation | documentation<br>if blended Benchmark  |

element **BenchmarkStaticDataType/BenchmarkComponents/BenchmarkComponent**

|            |  |
|------------|--|
| diagram    |  |
| properties | isRef 0<br>minOcc 1<br>maxOcc unbounded<br>content complex   |
| children   | <a href="#">BenchmarkComponentID</a> <a href="#">ValidFrom</a> <a href="#">ValidTo</a> <a href="#">Name</a> <a href="#">Provider</a> <a href="#">Identifier</a> <a href="#">Weight</a> |

element **BenchmarkStaticDataType/BenchmarkComponents/BenchmarkComponent/BenchmarkComponentID**

|            |   |
|------------|---|
| diagram    |   |
| type       | restriction of <b>xs:string</b>                   |
| properties | isRef 0<br>minOcc 0<br>maxOcc 1<br>content simple |
| facets     | Kind Value annotation<br>maxLength 255            |

element **BenchmarkStaticDataType/BenchmarkComponents/BenchmarkComponent/ValidFrom**

|            |                           |
|------------|---------------------------|
| diagram    |                           |
| type       | <b>xs:date</b>            |
| properties | isRef 0<br>content simple |

element **BenchmarkStaticDataType/BenchmarkComponents/BenchmarkComponent/ValidTo**

|            |                                 |
|------------|---------------------------------|
| diagram    |                                 |
| type       | <b>xs:date</b>                  |
| properties | isRef 0<br>minOcc 0<br>maxOcc 1 |

|  |                |
|--|----------------|
|  | content simple |
|--|----------------|

element **BenchmarkStaticDataType/BenchmarkComponents/BenchmarkComponent/Name**

|            |  |
|------------|--|
| diagram    |  |
| type       | restriction of <b>xs:string</b>        |
| properties | isRef 0<br>content simple              |
| facets     | Kind Value annotation<br>maxLength 255 |

element **BenchmarkStaticDataType/BenchmarkComponents/BenchmarkComponent/Provider**

|            |  |
|------------|--|
| diagram    | <p>The diagram shows a complex structure for <b>BenchmarkProviderCompany</b>. It is enclosed in a dashed yellow box. The structure includes the following elements:</p> <ul style="list-style-type: none"> <li><b>Identifiers (+)</b>: Identifiers of company</li> <li><b>Name</b>: Name of company</li> <li><b>LegalName</b>: Legal (full) name of company</li> <li><b>LegalForm</b>: Legal form of company</li> <li><b>Address (+)</b>: Address of company</li> <li><b>BusinessCountry</b>: Country code of main business of company</li> <li><b>ParentCompany (+)</b>: Parent company (if applicable)</li> <li><b>OtherClassification (+)</b>: All other identifiers (with listed or free type), with a cardinality of 0..∞</li> <li><b>IsESMARegisterd</b>: A boolean element at the bottom.</li> </ul> <p>A <b>Provider</b> element (shown in a dashed box) is connected to the main structure via a choice connector (a circle with a horizontal line and a minus sign).</p> |
| type       | <a href="#">BenchmarkProviderCompany</a>   |
| properties | isRef 0<br>minOcc 0<br>maxOcc 1<br>content complex   |

|          |  |
|----------|--|
| children | <a href="#">Identifiers</a> <a href="#">Name</a> <a href="#">LegalName</a> <a href="#">LegalForm</a> <a href="#">Address</a> <a href="#">BusinessCountry</a> <a href="#">ParentCompany</a> <a href="#">OtherClassification</a><br><a href="#">IsESMARegistered</a> |
|----------|--|

element **BenchmarkStaticDataType/BenchmarkComponents/BenchmarkComponent/Identifier**

diagram

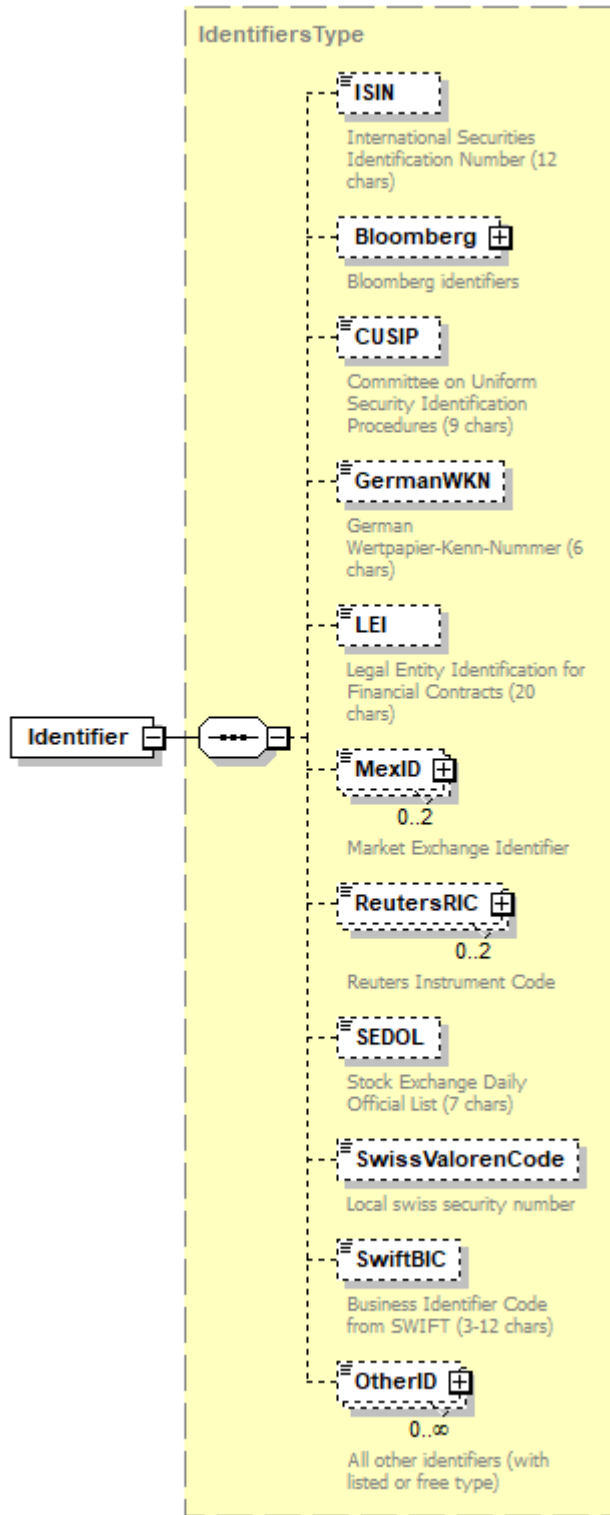

|            |   |
|------------|---|
| type       | <a href="#">IdentifiersType</a>   |
| properties | isRef 0<br>content complex  |
| children   | <a href="#">ISIN</a> <a href="#">Bloomberg</a> <a href="#">CUSIP</a> <a href="#">GermanWKN</a> <a href="#">LEI</a> <a href="#">MexID</a> <a href="#">ReutersRIC</a> <a href="#">SEDOL</a> <a href="#">SwissValorenCode</a> <a href="#">SwiftBIC</a> <a href="#">OtherID</a> |

element **BenchmarkStaticDataType/BenchmarkComponents/BenchmarkComponent/Weight**

|            |   |
|------------|---|
| diagram    |  |
| type       | <a href="#">PercentageType</a>  |
| properties | isRef 0<br>content simple   |

complexType **FundCompaniesType**

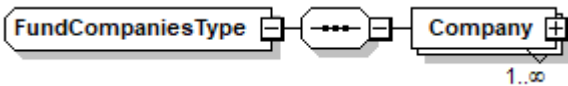
|          |   |
|----------|---|
| diagram  |  |
| children | <a href="#">Company</a>   |
| used by  | element <a href="#">FundStaticDataType/Companies</a>                              |

element **FundCompaniesType/Company**

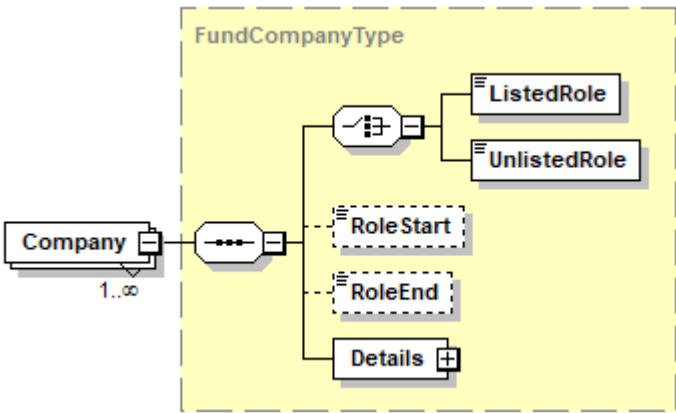
|            |   |
|------------|---|
| diagram    |   |
| type       | <a href="#">FundCompanyType</a>   |
| properties | isRef 0<br>minOcc 1<br>maxOcc unbounded<br>content complex  |
| children   | <a href="#">ListedRole</a> <a href="#">UnlistedRole</a> <a href="#">RoleStart</a> <a href="#">RoleEnd</a> <a href="#">Details</a> |



### complexType FundCompanyType

|          |   |
|----------|---|
| diagram  |   |
| children | <a href="#">ListedRole</a> <a href="#">UnlistedRole</a> <a href="#">RoleStart</a> <a href="#">RoleEnd</a> <a href="#">Details</a> |
| used by  | element <a href="#">FundCompaniesType/Company</a>   |

### element FundCompanyType/ListedRole

|            |                                 |
|------------|---------------------------------|
| diagram    |                                 |
| type       | restriction of <b>xs:string</b> |
| properties | isRef 0<br>content simple       |

### element FundCompanyType/UnlistedRole

|            |  |
|------------|--|
| diagram    |  |
| type       | <a href="#">Text200Type</a>            |
| properties | isRef 0<br>content simple              |
| facets     | Kind Value annotation<br>maxLength 200 |

### element FundCompanyType/RoleStart

|            |   |
|------------|---|
| diagram    |   |
| type       | <b>xs:date</b>                                    |
| properties | isRef 0<br>minOcc 0<br>maxOcc 1<br>content simple |

### element FundCompanyType/RoleEnd

|         |                |
|---------|----------------|
| diagram |                |
| type    | <b>xs:date</b> |

|            |   |
|------------|---|
| properties | isRef 0<br>minOcc 0<br>maxOcc 1<br>content simple |
|------------|---|

element **FundCompanyType/Details**

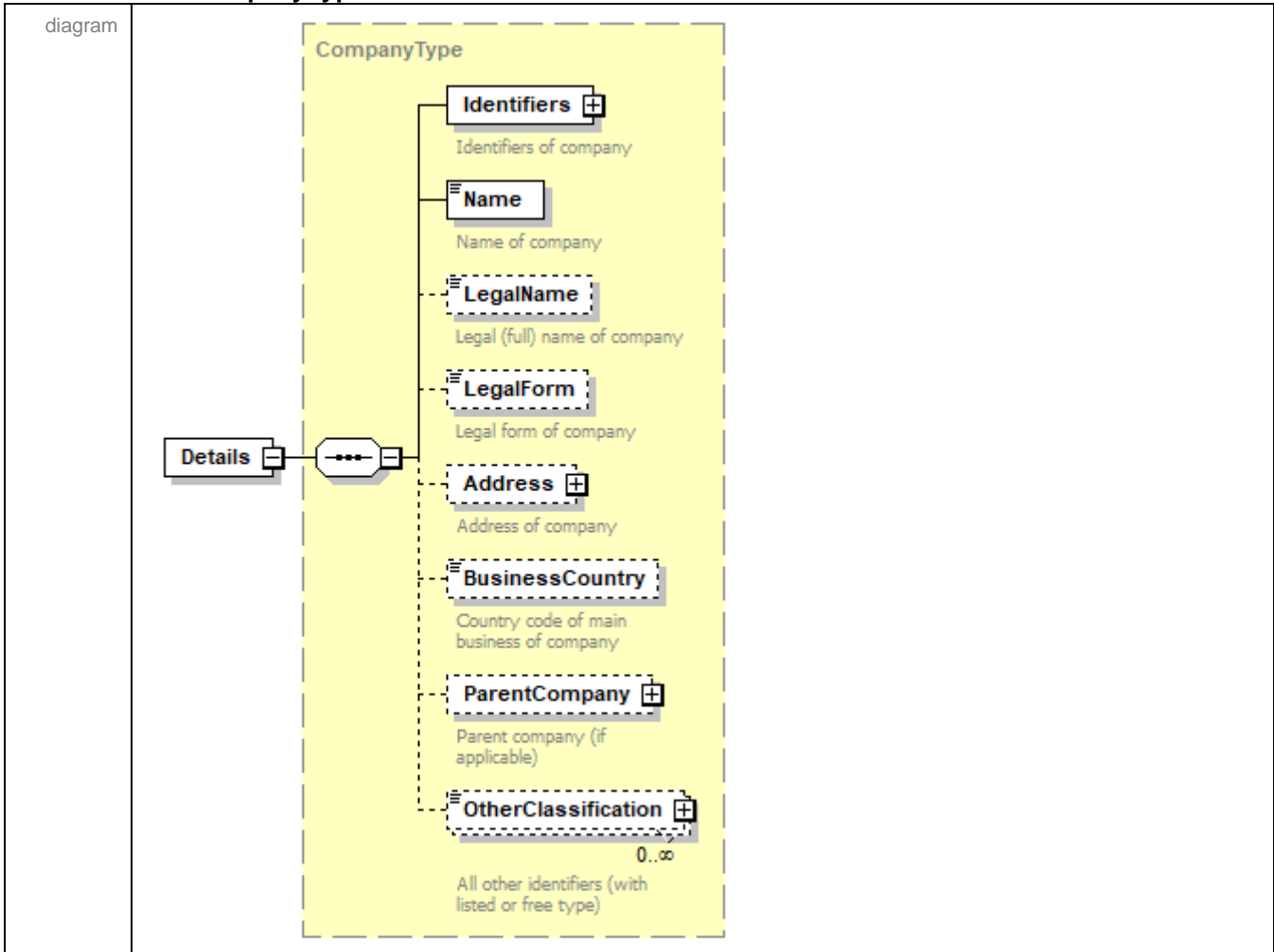

|            |  |
|------------|--|
| type       | <a href="#">CompanyType</a>  |
| properties | isRef 0<br>content complex   |
| children   | <a href="#">Identifiers</a> <a href="#">Name</a> <a href="#">LegalName</a> <a href="#">LegalForm</a> <a href="#">Address</a> <a href="#">BusinessCountry</a> <a href="#">ParentCompany</a> <a href="#">OtherClassification</a> |

# complexType FundStaticDataType

diagram

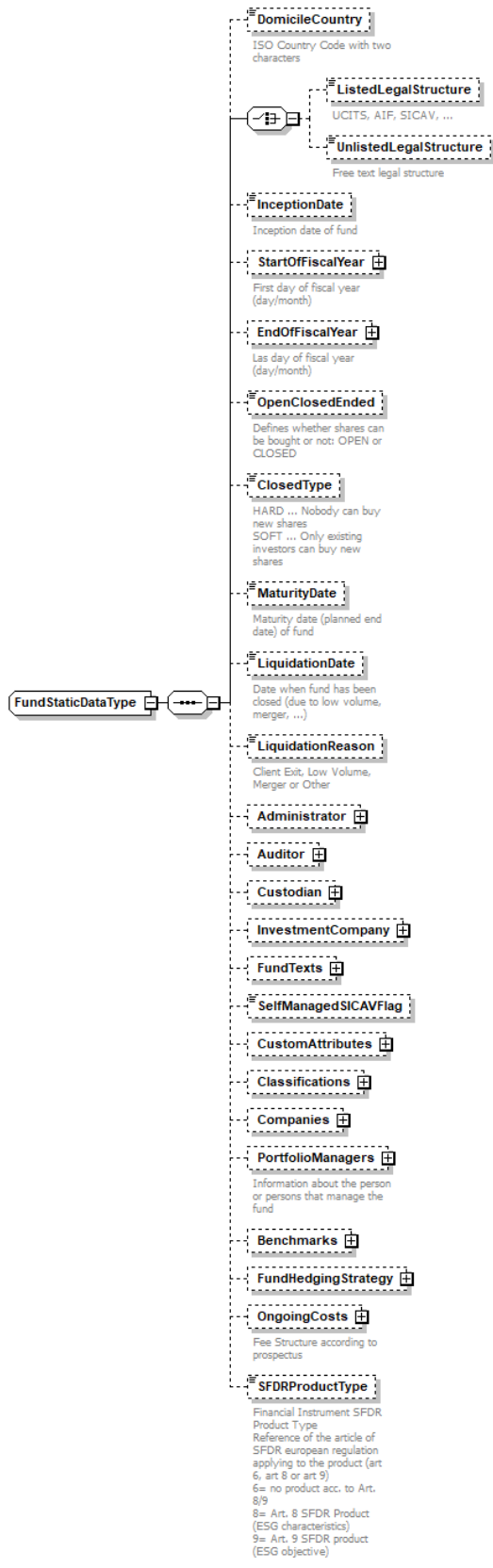

|          |   |
|----------|---|
| children | <a href="#">DomicileCountry</a> <a href="#">ListedLegalStructure</a> <a href="#">UnlistedLegalStructure</a> <a href="#">InceptionDate</a> <a href="#">StartOfFiscalYear</a> <a href="#">EndOfFiscalYear</a> <a href="#">OpenClosedEnded</a> <a href="#">ClosedType</a> <a href="#">MaturityDate</a> <a href="#">LiquidationDate</a> <a href="#">LiquidationReason</a> <a href="#">Administrator</a> <a href="#">Auditor</a> <a href="#">Custodian</a> <a href="#">InvestmentCompany</a> <a href="#">FundTexts</a> <a href="#">SelfManagedSICAVFlag</a> <a href="#">CustomAttributes</a> <a href="#">Classifications</a> <a href="#">Companies</a> <a href="#">PortfolioManagers</a> <a href="#">Benchmarks</a> <a href="#">FundHedgingStrategy</a> <a href="#">OngoingCosts</a> <a href="#">SFDRProductType</a> |
| used by  | element <a href="#">FundType/FundStaticData</a>   |

#### element [FundStaticDataType/DomicileCountry](#)

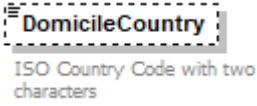
|            |   |
|------------|---|
| diagram    |  |
| type       | <a href="#">ISOCountryCodeType</a>  |
| properties | isRef 0<br>minOcc 0<br>maxOcc 1<br>content simple                                 |
| facets     | Kind Value annotation<br>minLength 2<br>maxLength 2                               |
| annotation | documentation<br>ISO Country Code with two characters                             |

#### element [FundStaticDataType/ListedLegalStructure](#)

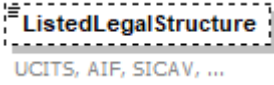
|            |   |
|------------|---|
| diagram    |  |
| type       | restriction of <a href="#">xs:string</a>  |
| properties | isRef 0<br>minOcc 0<br>maxOcc 1<br>content simple                                   |
| annotation | documentation<br>UCITS, AIF, SICAV, ...   |

#### element [FundStaticDataType/UnlistedLegalStructure](#)

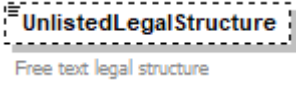
|            |   |
|------------|---|
| diagram    |  |
| type       | <a href="#">Text200Type</a>   |
| properties | isRef 0<br>minOcc 0<br>maxOcc 1<br>content simple                                   |
| facets     | Kind Value annotation<br>maxLength 200  |
| annotation | documentation<br>Free text legal structure  |

element **FundStaticDataType/InceptionDate**

|            |   |
|------------|---|
| diagram    |   |
| type       | <b>xs:date</b>                                    |
| properties | isRef 0<br>minOcc 0<br>maxOcc 1<br>content simple |
| annotation | documentation<br>Inception date of fund           |

element **FundStaticDataType/StartOfFiscalYear**

|            |   |
|------------|---|
| diagram    |   |
| type       | <a href="#">DayMonthType</a>                          |
| properties | isRef 0<br>minOcc 0<br>maxOcc 1<br>content complex    |
| children   | <a href="#">Day</a> <a href="#">Month</a>             |
| annotation | documentation<br>First day of fiscal year (day/month) |

element **FundStaticDataType/EndOfFiscalYear**

|            |   |
|------------|---|
| diagram    |   |
| type       | <a href="#">DayMonthType</a>                        |
| properties | isRef 0<br>minOcc 0<br>maxOcc 1<br>content complex  |
| children   | <a href="#">Day</a> <a href="#">Month</a>           |
| annotation | documentation<br>Las day of fiscal year (day/month) |

element **FundStaticDataType/OpenClosedEnded**

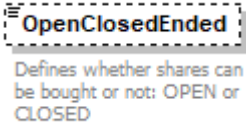
|            |   |
|------------|---|
| diagram    |  |
| type       | restriction of <b>xs:string</b>   |
| properties | isRef 0<br>minOcc 0<br>maxOcc 1<br>content simple                                 |
| annotation | documentation<br>Defines whether shares can be bought or not: OPEN or CLOSED      |

element **FundStaticDataType/ClosedType**

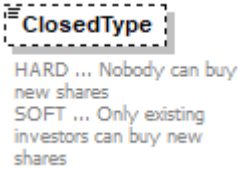
|            |  |
|------------|--|
| diagram    |                           |
| type       | restriction of <b>xs:string</b>  |
| properties | isRef 0<br>minOcc 0<br>maxOcc 1<br>content simple  |
| annotation | documentation<br>HARD ... Nobody can buy new shares<br>SOFT ... Only existing investors can buy new shares |

element **FundStaticDataType/MaturityDate**

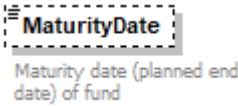
|            |   |
|------------|---|
| diagram    |  |
| type       | <b>xs:date</b>  |
| properties | isRef 0<br>minOcc 0<br>maxOcc 1<br>content simple                                   |
| annotation | documentation<br>Maturity date (planned end date) of fund                           |

element **FundStaticDataType/LiquidationDate**

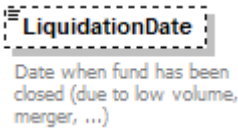
|            |   |
|------------|---|
| diagram    |  |
| type       | <b>xs:date</b>  |
| properties | isRef 0<br>minOcc 0   |

|            |  |
|------------|--|
|            | maxOcc 1<br>content simple   |
| annotation | documentation<br>Date when fund has been closed (due to low volume, merger, ...) |

element **FundStaticDataType/LiquidationReason**

|            |   |
|------------|---|
| diagram    |   |
| type       | restriction of xs:string                                  |
| properties | isRef 0<br>minOcc 0<br>maxOcc 1<br>content simple         |
| annotation | documentation<br>Client Exit, Low Volume, Merger or Other |

element **FundStaticDataType/Administrator**

|         |                             |
|---------|-----------------------------|
| diagram |                             |
| type    | <a href="#">CompanyType</a> |

|            |  |
|------------|--|
| properties | isRef 0<br>minOcc 0<br>maxOcc 1<br>content complex   |
| children   | <a href="#">Identifiers</a> <a href="#">Name</a> <a href="#">LegalName</a> <a href="#">LegalForm</a> <a href="#">Address</a> <a href="#">BusinessCountry</a> <a href="#">ParentCompany</a> <a href="#">OtherClassification</a> |

element **FundStaticDataType/Auditor**

|            |   |
|------------|---|
| diagram    | <p>The diagram illustrates the relationship between <b>Auditor</b> and <b>CompanyType</b>. <b>CompanyType</b> is the base class, represented by a yellow-shaded box with a dashed border. It contains the following attributes:</p> <ul style="list-style-type: none"> <li><b>Identifiers</b>: Identifiers of company (multiplicity 0..1)</li> <li><b>Name</b>: Name of company (multiplicity 0..1)</li> <li><b>LegalName</b>: Legal (full) name of company (multiplicity 0..1)</li> <li><b>LegalForm</b>: Legal form of company (multiplicity 0..1)</li> <li><b>Address</b>: Address of company (multiplicity 0..1)</li> <li><b>BusinessCountry</b>: Country code of main business of company (multiplicity 0..1)</li> <li><b>ParentCompany</b>: Parent company (if applicable) (multiplicity 0..1)</li> <li><b>OtherClassification</b>: All other identifiers (with listed or free type) (multiplicity 0..∞)</li> </ul> <p><b>Auditor</b> is a specialization of <b>CompanyType</b>, shown as a dashed box with a hollow triangle arrowhead pointing to the <b>CompanyType</b> box.</p> |
| type       | <a href="#">CompanyType</a>   |
| properties | isRef 0<br>minOcc 0<br>maxOcc 1<br>content complex  |
| children   | <a href="#">Identifiers</a> <a href="#">Name</a> <a href="#">LegalName</a> <a href="#">LegalForm</a> <a href="#">Address</a> <a href="#">BusinessCountry</a> <a href="#">ParentCompany</a> <a href="#">OtherClassification</a>  |



element **FundStaticDataType/Custodian**

|                   |   |
|-------------------|---|
| <p>diagram</p>    | <p>The diagram illustrates the structure of the <b>CompanyType</b> element. It is a complex type containing several child elements:</p> <ul style="list-style-type: none"> <li><b>Identifiers</b>: Identifiers of company (0..1 occurrence)</li> <li><b>Name</b>: Name of company (1 occurrence)</li> <li><b>LegalName</b>: Legal (full) name of company (0..1 occurrence)</li> <li><b>LegalForm</b>: Legal form of company (0..1 occurrence)</li> <li><b>Address</b>: Address of company (0..1 occurrence)</li> <li><b>BusinessCountry</b>: Country code of main business of company (0..1 occurrence)</li> <li><b>ParentCompany</b>: Parent company (if applicable) (0..1 occurrence)</li> <li><b>OtherClassification</b>: All other identifiers (with listed or free type) (0..∞ occurrence)</li> </ul> <p>The <b>Custodian</b> element is shown as a reference to the <b>CompanyType</b> element, indicated by a dashed line and a small square icon.</p> |
| <p>type</p>       | <p><a href="#">CompanyType</a></p>  |
| <p>properties</p> | <p>isRef 0<br/> minOcc 0<br/> maxOcc 1<br/> content complex</p>   |
| <p>children</p>   | <p><a href="#">Identifiers</a> <a href="#">Name</a> <a href="#">LegalName</a> <a href="#">LegalForm</a> <a href="#">Address</a> <a href="#">BusinessCountry</a> <a href="#">ParentCompany</a> <a href="#">OtherClassification</a></p>   |

element **FundStaticDataType/InvestmentCompany**

|                   |   |
|-------------------|---|
| <p>diagram</p>    |   |
| <p>type</p>       | <p><a href="#">CompanyType</a></p>  |
| <p>properties</p> | <p>isRef 0<br/>minOcc 0<br/>maxOcc 1<br/>content complex</p>  |
| <p>children</p>   | <p><a href="#">Identifiers</a> <a href="#">Name</a> <a href="#">LegalName</a> <a href="#">LegalForm</a> <a href="#">Address</a> <a href="#">BusinessCountry</a> <a href="#">ParentCompany</a> <a href="#">OtherClassification</a></p> |

element **FundStaticDataType/FundTexts**

|                   |  |
|-------------------|--|
| <p>diagram</p>    |  |
| <p>properties</p> | <p>isRef 0<br/>minOcc 0<br/>maxOcc 1<br/>content complex</p> |
| <p>children</p>   | <p><a href="#">FundText</a></p>                              |

element **FundStaticDataType/FundTexts/FundText**

|            |  |       |   |        |   |        |           |         |         |
|------------|--|-------|---|--------|---|--------|-----------|---------|---------|
| diagram    |  |       |   |        |   |        |           |         |         |
| type       | <a href="#">FundRelatedTextType</a>  |       |   |        |   |        |           |         |         |
| properties | <table> <tr><td>isRef</td><td>0</td></tr> <tr><td>minOcc</td><td>1</td></tr> <tr><td>maxOcc</td><td>unbounded</td></tr> <tr><td>content</td><td>complex</td></tr> </table>                   | isRef | 0 | minOcc | 1 | maxOcc | unbounded | content | complex |
| isRef      | 0  |       |   |        |   |        |           |         |         |
| minOcc     | 1  |       |   |        |   |        |           |         |         |
| maxOcc     | unbounded  |       |   |        |   |        |           |         |         |
| content    | complex  |       |   |        |   |        |           |         |         |
| children   | <a href="#">Language</a> <a href="#">Date</a> <a href="#">ListedType</a> <a href="#">UnlistedType</a> <a href="#">Title</a> <a href="#">Content</a> <a href="#">CountriesWhereApplicable</a> |       |   |        |   |        |           |         |         |

element **FundStaticDataType/SelfManagedSICAVFlag**

|            |   |       |   |        |   |        |   |         |        |
|------------|---|-------|---|--------|---|--------|---|---------|--------|
| diagram    |   |       |   |        |   |        |   |         |        |
| type       | <b>xs:boolean</b>   |       |   |        |   |        |   |         |        |
| properties | <table> <tr><td>isRef</td><td>0</td></tr> <tr><td>minOcc</td><td>0</td></tr> <tr><td>maxOcc</td><td>1</td></tr> <tr><td>content</td><td>simple</td></tr> </table> | isRef | 0 | minOcc | 0 | maxOcc | 1 | content | simple |
| isRef      | 0   |       |   |        |   |        |   |         |        |
| minOcc     | 0   |       |   |        |   |        |   |         |        |
| maxOcc     | 1   |       |   |        |   |        |   |         |        |
| content    | simple  |       |   |        |   |        |   |         |        |

element **FundStaticDataType/CustomAttributes**

|            |   |
|------------|---|
| diagram    | <p>The diagram shows a dashed box labeled 'CustomAttributes' containing a container with three dots. This container is connected to a box labeled 'Attribute' with a cardinality of '1..∞'. The entire structure is enclosed in a yellow dashed box labeled 'AttributesType'.</p> |
| type       | <a href="#">AttributesType</a>  |
| properties | isRef 0<br>minOcc 0<br>maxOcc 1<br>content complex  |
| children   | <a href="#">Attribute</a>   |

element **FundStaticDataType/Classifications**

|            |  |
|------------|--|
| diagram    | <p>The diagram shows a dashed box labeled 'Classifications' containing a container with three dots. This container is connected to a box labeled 'Classification' with a cardinality of '1..∞'. The entire structure is enclosed in a yellow dashed box labeled 'ClassificationsType'.</p> |
| type       | <a href="#">ClassificationsType</a>  |
| properties | isRef 0<br>minOcc 0<br>maxOcc 1<br>content complex   |
| children   | <a href="#">Classification</a>   |

element **FundStaticDataType/Companies**

|            |   |
|------------|---|
| diagram    | <p>The diagram shows a dashed box labeled 'Companies' containing a container with three dots. This container is connected to a box labeled 'Company' with a cardinality of '1..∞'. The entire structure is enclosed in a yellow dashed box labeled 'FundCompaniesType'.</p> |
| type       | <a href="#">FundCompaniesType</a>   |
| properties | isRef 0<br>minOcc 0<br>maxOcc 1<br>content complex  |
| children   | <a href="#">Company</a>   |

element **FundStaticDataType/PortfolioManagers**

|            |   |
|------------|---|
| diagram    | <p>The diagram shows a dashed box labeled 'PortfolioManagers' containing a container with three dots. This container is connected to a box labeled 'PortfolioManager' with a cardinality of '1..∞'. Below the diagram, there is a descriptive text: 'Information about the person or persons that manage the fund'.</p> |
| type       | <a href="#">PortfolioManager</a>  |
| properties | isRef 0<br>minOcc 0<br>maxOcc 1<br>content complex  |
| children   | <a href="#">PortfolioManager</a>  |

|            |   |
|------------|---|
| properties | isRef 0<br>minOcc 0<br>maxOcc 1<br>content complex                            |
| children   | <a href="#">PortfolioManager</a>  |
| annotation | documentation<br>Information about the person or persons that manage the fund |

element **FundStaticDataType/PortfolioManagers/PortfolioManager**

|            |  |
|------------|--|
| diagram    | <p><b>PortfolioManager</b> 1..∞</p> <ul style="list-style-type: none"> <li><b>Name</b><br/>Indicates the name of the person in charge of the management of the portfolio</li> <li><b>StartDate</b><br/>Indicates the start date from which on the fund manager was made responsible for managing the portfolio.</li> <li><b>Role</b><br/>Indicates the role of the person in charge of the management of the portfolio</li> <li><b>YearOfBirth</b><br/>Indicates the date of birth of the person in charge of the management of the portfolio</li> <li><b>Gender</b><br/>Indicates the gender of the person in charge of the management of the portfolio</li> <li><b>StartOfCareer</b><br/>Indicates when the person in charge of the management of the portfolio started his professional career in the financial industry</li> <li><b>Biography</b> <br/>Biography of the Portfolio Manager</li> </ul> |
| properties | isRef 0<br>minOcc 1<br>maxOcc unbounded<br>content complex   |
| children   | <a href="#">Name</a> <a href="#">StartDate</a> <a href="#">Role</a> <a href="#">YearOfBirth</a> <a href="#">Gender</a> <a href="#">StartOfCareer</a> <a href="#">Biography</a>   |

element **FundStaticDataType/PortfolioManagers/PortfolioManager/Name**

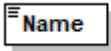
|            |  |
|------------|--|
| diagram    |  <p>Indicates the name of the person in charge of the management of the portfolio</p> |
| type       | <a href="#">Text256Type</a>  |
| properties | isRef 0<br>content simple  |
| facets     | Kind Value annotation<br>maxLength 256   |
| annotation | documentation<br>Indicates the name of the person in charge of the management of the portfolio   |

element **FundStaticDataType/PortfolioManagers/PortfolioManager/StartDate**

|            |   |
|------------|---|
| diagram    |  <p>Indicates the start date from which on the fund manager was made responsible for managing the portfolio.</p> |
| type       | <b>xs:date</b>  |
| properties | isRef 0<br>content simple   |
| annotation | documentation<br>Indicates the start date from which on the fund manager was made responsible for managing the portfolio.   |

element **FundStaticDataType/PortfolioManagers/PortfolioManager/Role**

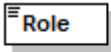
|            |  |
|------------|--|
| diagram    |  <p>Indicates the role of the person in charge of the management of the portfolio</p> |
| type       | <b>xs:string</b>   |
| properties | isRef 0<br>content simple  |
| annotation | documentation<br>Indicates the role of the person in charge of the management of the portfolio   |

element **FundStaticDataType/PortfolioManagers/PortfolioManager/YearOfBirth**

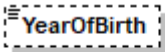
|            |   |
|------------|---|
| diagram    |  <p>Indicates the date of birth of the person in charge of the management of the portfolio</p> |
| type       | <b>xs:date</b>  |
| properties | isRef 0<br>minOcc 0<br>maxOcc 1<br>content simple   |
| annotation | documentation<br>Indicates the date of birth of the person in charge of the management of the portfolio   |

element **FundStaticDataType/PortfolioManagers/PortfolioManager/Gender**

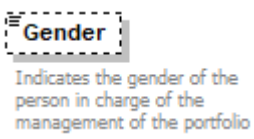
|            |  |
|------------|--|
| diagram    |                 |
| type       | restriction of <b>xs:string</b>  |
| properties | isRef 0<br>minOcc 0<br>maxOcc 1<br>content simple  |
| annotation | documentation<br>Indicates the gender of the person in charge of the management of the portfolio |

element **FundStaticDataType/PortfolioManagers/PortfolioManager/StartOfCareer**

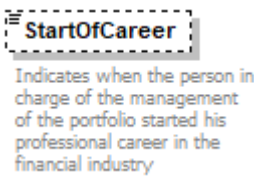
|            |   |
|------------|---|
| diagram    |    |
| type       | <b>xs:date</b>  |
| properties | isRef 0<br>minOcc 0<br>maxOcc 1<br>content simple   |
| annotation | documentation<br>Indicates when the person in charge of the management of the portfolio started his professional career in the financial industry |

element **FundStaticDataType/PortfolioManagers/PortfolioManager/Biography**

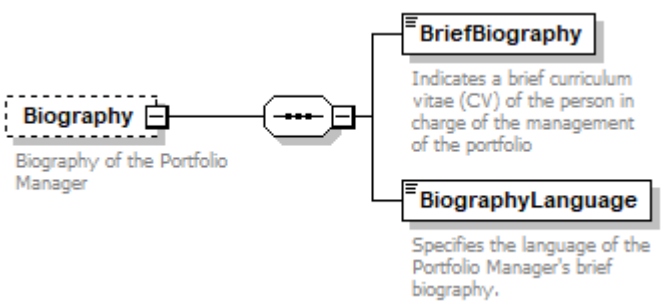
|            |   |
|------------|---|
| diagram    |  |
| properties | isRef 0<br>minOcc 0<br>maxOcc 1<br>content complex                                  |
| children   | <a href="#">BriefBiography</a> <a href="#">BiographyLanguage</a>                    |
| annotation | documentation<br>Biography of the Portfolio Manager                                 |

element **FundStaticDataType/PortfolioManagers/PortfolioManager/Biography/BriefBiography**

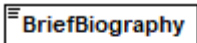
|            |  |
|------------|--|
| diagram    |  <p><b>BriefBiography</b></p> <p>Indicates a brief curriculum vitae (CV) of the person in charge of the management of the portfolio</p> |
| type       | <b>xs:string</b>   |
| properties | isRef 0<br>content simple  |
| annotation | documentation<br>Indicates a brief curriculum vitae (CV) of the person in charge of the management of the portfolio  |

element **FundStaticDataType/PortfolioManagers/PortfolioManager/Biography/BiographyLanguage**

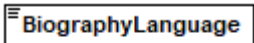
|            |   |
|------------|---|
| diagram    |  <p><b>BiographyLanguage</b></p> <p>Specifies the language of the Portfolio Manager's brief biography.</p> |
| type       | <a href="#">ISOLanguageCodeType</a>   |
| properties | isRef 0<br>content simple   |
| facets     | Kind Value annotation<br>minLength 2<br>maxLength 2   |
| annotation | documentation<br>Specifies the language of the Portfolio Manager's brief biography.   |

element **FundStaticDataType/Benchmarks**

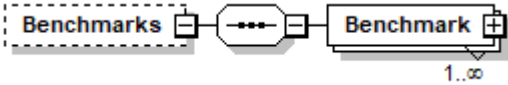
|            |  |
|------------|--|
| diagram    |  <p><b>Benchmarks</b> [1..∞]</p> <p><b>Benchmark</b> [1..∞]</p> |
| properties | isRef 0<br>minOcc 0<br>maxOcc 1<br>content complex   |
| children   | <a href="#">Benchmark</a>  |



element **FundStaticDataType/Benchmarks/Benchmark**

|                   |   |
|-------------------|---|
| <p>diagram</p>    | <p>The diagram illustrates the structure of the <b>Benchmark</b> element. It is an extension of <b>BenchmarkStaticDataType</b>. The <b>Benchmark</b> element (multiplicity 1..∞) is connected to a complex content container. This container includes the following elements:</p> <ul style="list-style-type: none"> <li><b>BenchmarkID</b>: Link to Benchmark Dynamic Data</li> <li><b>Name</b></li> <li><b>Currency</b></li> <li><b>Provider</b> (+)</li> <li><b>BenchmarkType</b></li> <li><b>BenchmarkUsage</b> (+): official, internal, performance attribution, etc.</li> <li><b>BenchmarkComponents</b> (+): if blended Benchmark</li> </ul> |
| <p>type</p>       | <p>extension of <a href="#">BenchmarkStaticDataType</a></p>   |
| <p>properties</p> | <p>isRef 0<br/> minOcc 1<br/> maxOcc unbounded<br/> content complex</p>   |
| <p>children</p>   | <p><a href="#">BenchmarkID</a> <a href="#">Name</a> <a href="#">Currency</a> <a href="#">Provider</a> <a href="#">BenchmarkType</a> <a href="#">BenchmarkUsage</a> <a href="#">BenchmarkComponents</a></p>  |

element **FundStaticDataType/FundHedgingStrategy**

|            |  |
|------------|--|
| diagram    | <p><b>FundHedgingStrategy</b> is connected to <b>HedgingStrategyType</b>. <b>HedgingStrategyType</b> contains <b>HedgingStrategy</b>.</p> <p><b>HedgingStrategyType</b></p> <p>A net asset value (NAV) hedge: This aims to minimise the effect of currency movements between the base currency of a fund and the currency of the relevant hedged share class.</p> <p>A portfolio hedge: This aims to minimise the effect of currency movements between the currencies of the assets of the fund and the currency of the relevant hedged share class with the exception of currencies where it is impractical or not cost effective to do so. In other words, it looks through to the underlying currency exposures of the fund.</p> <p>Full hedge: Open position that eliminates over 90% or more of the risk arising from another open position.</p> <p>Partial hedge: Open position that eliminates below 90% but more than 0% of the risk arising from another open position.</p> |
| type       | <a href="#">HedgingStrategyType</a>  |
| properties | <p>isRef 0</p> <p>minOcc 0</p> <p>maxOcc 1</p> <p>content complex</p>  |
| children   | <a href="#">HedgingStrategy</a>  |

element **FundStaticDataType/OngoingCosts**

|            |  |
|------------|--|
| diagram    | <p><b>OngoingCosts</b> is connected to <b>OngoingCost</b> with multiplicity 1..∞.</p> <p>Fee Structure according to prospectus</p> |
| properties | <p>isRef 0</p> <p>minOcc 0</p> <p>maxOcc 1</p> <p>content complex</p>  |
| children   | <a href="#">OngoingCost</a>  |
| annotation | <p>documentation</p> <p>Fee Structure according to prospectus</p>  |

element **FundStaticDataType/OngoingCosts/OngoingCost**

|            |  |
|------------|--|
| diagram    | <p><b>CostType</b><br/>OGC (= "Management fees and other administrative or operating cost")<br/>Performance Fee<br/>Transaction Costs</p> <p><b>PublicationDate</b></p> <p><b>ValidFrom</b></p> <p><b>ValidTo</b></p> <p><b>Percentage</b></p> <p><b>YearlyAmount</b> +<br/>Absolute Amount per 10.000<br/>in Fund CCY</p> |
| properties | isRef 0<br>content complex   |
| children   | <a href="#">CostType</a> <a href="#">PublicationDate</a> <a href="#">ValidFrom</a> <a href="#">ValidTo</a> <a href="#">Percentage</a> <a href="#">YearlyAmount</a>   |

element **FundStaticDataType/OngoingCosts/OngoingCost/CostType**

|            |   |
|------------|---|
| diagram    | <p><b>CostType</b><br/>OGC (= "Management fees and other administrative or operating cost")<br/>Performance Fee<br/>Transaction Costs</p> |
| type       | restriction of <b>xs:string</b>   |
| properties | isRef 0<br>content simple   |
| annotation | documentation<br>OGC (= "Management fees and other administrative or operating cost")<br>Performance Fee<br>Transaction Costs             |

element **FundStaticDataType/OngoingCosts/OngoingCost/PublicationDate**

|            |                               |
|------------|-------------------------------|
| diagram    | <p><b>PublicationDate</b></p> |
| type       | <b>xs:date</b>                |
| properties | isRef 0<br>content simple     |

element **FundStaticDataType/OngoingCosts/OngoingCost/ValidFrom**

|         |                         |
|---------|-------------------------|
| diagram | <p><b>ValidFrom</b></p> |
|---------|-------------------------|

|            |   |
|------------|---|
| type       | <b>xs:date</b>                                    |
| properties | isRef 0<br>minOcc 0<br>maxOcc 1<br>content simple |

element **FundStaticDataType/OngoingCosts/OngoingCost/ValidTo**

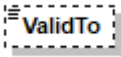
|            |   |
|------------|---|
| diagram    |  |
| type       | <b>xs:date</b>  |
| properties | isRef 0<br>minOcc 0<br>maxOcc 1<br>content simple                                 |

element **FundStaticDataType/OngoingCosts/OngoingCost/Percentage**

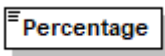
|            |   |
|------------|---|
| diagram    |  |
| type       | <a href="#">PercentageType</a>  |
| properties | isRef 0<br>content simple   |

element **FundStaticDataType/OngoingCosts/OngoingCost/YearlyAmount**

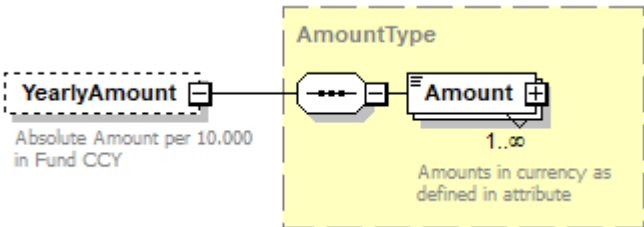
|            |   |
|------------|---|
| diagram    |  |
| type       | <a href="#">AmountType</a>  |
| properties | isRef 0<br>minOcc 0<br>maxOcc 1<br>content complex                                  |
| children   | <a href="#">Amount</a>  |
| annotation | documentation<br>Absolute Amount per 10.000 in Fund CCY                             |

element **FundStaticDataType/SFDRProductType**

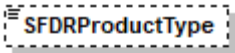
|                   |   |
|-------------------|---|
| <p>diagram</p>    |  <p>Financial Instrument SFDR Product Type<br/> Reference of the article of SFDR european regulation applying to the product (art 6, art 8 or art 9)<br/> 6= no product acc. to Art. 8/9<br/> 8= Art. 8 SFDR Product (ESG characteristics)<br/> 9= Art. 9 SFDR product (ESG objective)</p> |
| <p>type</p>       | <p>restriction of <b>xs:int</b></p>   |
| <p>properties</p> | <p>isRef 0<br/> minOcc 0<br/> maxOcc 1<br/> content simple</p>  |
| <p>annotation</p> | <p>documentation<br/> Financial Instrument SFDR Product Type<br/> Reference of the article of SFDR european regulation applying to the product (art 6, art 8 or art 9)<br/> 6= no product acc. to Art. 8/9<br/> 8= Art. 8 SFDR Product (ESG characteristics)<br/> 9= Art. 9 SFDR product (ESG objective)</p>  |

complexType **SingleFundStaticDataType**

|                 |   |
|-----------------|---|
| <p>diagram</p>  |   |
| <p>children</p> | <p><a href="#">Advisor</a> <a href="#">Managers</a> <a href="#">Policies</a> <a href="#">StockExchanges</a> <a href="#">ExchangeTradedFlag</a> <a href="#">FundOfFundFlag</a> <a href="#">SocialResponsibleFlag</a> <a href="#">ManagementType</a> <a href="#">PricePublishedFlag</a> <a href="#">SalesCategory</a> <a href="#">InvestmentHorizon</a> <a href="#">IsFeederFor</a> <a href="#">IsMasterFor</a></p> |
| <p>used by</p>  | <p>element <a href="#">SingleFundType/SingleFundStaticData</a></p>  |

element **SingleFundStaticDataType/Advisor**

|            |  |
|------------|--|
| diagram    | <p>The diagram illustrates the structure of the <b>CompanyType</b> element. It is a container for several sub-elements, each with a specific description and cardinality:</p> <ul style="list-style-type: none"> <li><b>Identifiers</b>: Identifiers of company (cardinality: 1..∞)</li> <li><b>Name</b>: Name of company (cardinality: 1..∞)</li> <li><b>LegalName</b>: Legal (full) name of company (cardinality: 1..∞)</li> <li><b>LegalForm</b>: Legal form of company (cardinality: 1..∞)</li> <li><b>Address</b>: Address of company (cardinality: 1..∞)</li> <li><b>BusinessCountry</b>: Country code of main business of company (cardinality: 1..∞)</li> <li><b>ParentCompany</b>: Parent company (if applicable) (cardinality: 1..∞)</li> <li><b>OtherClassification</b>: All other identifiers (with listed or free type) (cardinality: 0..∞)</li> </ul> <p>The <b>Advisor</b> element is shown as a separate entity connected to the <b>CompanyType</b> element.</p> |
| type       | <a href="#">CompanyType</a>  |
| properties | isRef 0<br>minOcc 0<br>maxOcc 1<br>content complex   |
| children   | <a href="#">Identifiers</a> <a href="#">Name</a> <a href="#">LegalName</a> <a href="#">LegalForm</a> <a href="#">Address</a> <a href="#">BusinessCountry</a> <a href="#">ParentCompany</a> <a href="#">OtherClassification</a>   |

element **SingleFundStaticDataType/Managers**

|            |   |
|------------|---|
| diagram    | <p>The diagram illustrates the structure of the <b>Managers</b> element. It is a container for the <b>Manager</b> element, which has a cardinality of 1..∞.</p> |
| properties | isRef 0<br>minOcc 0<br>maxOcc 1<br>content complex  |
| children   | <a href="#">Manager</a>   |

element **SingleFundStaticDataType/Managers/Manager**

|                   |   |
|-------------------|---|
| <p>diagram</p>    |   |
| <p>type</p>       | <p><a href="#">CompanyType</a></p>  |
| <p>properties</p> | <p>isRef 0<br/>minOcc 1<br/>maxOcc unbounded<br/>content complex</p>  |
| <p>children</p>   | <p><a href="#">Identifiers</a> <a href="#">Name</a> <a href="#">LegalName</a> <a href="#">LegalForm</a> <a href="#">Address</a> <a href="#">BusinessCountry</a> <a href="#">ParentCompany</a> <a href="#">OtherClassification</a></p> |

element **SingleFundStaticDataType/Policies**

|                   |  |
|-------------------|--|
| <p>diagram</p>    |  |
| <p>properties</p> | <p>isRef 0<br/>minOcc 0<br/>maxOcc 1<br/>content complex</p> |
| <p>children</p>   | <p><a href="#">Policy</a></p>                                |

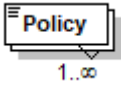

element **SingleFundStaticDataType/Policies/Policy**

|            |   |
|------------|---|
| diagram    |  |
| type       | <b>xs:string</b>  |
| properties | isRef 0<br>minOcc 1<br>maxOcc unbounded<br>content simple                         |

element **SingleFundStaticDataType/StockExchanges**

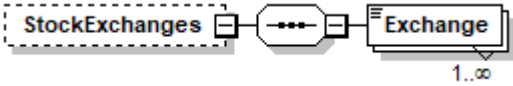
|            |   |
|------------|---|
| diagram    |  |
| properties | isRef 0<br>minOcc 0<br>maxOcc 1<br>content complex                                |
| children   | <a href="#">Exchange</a>  |

element **SingleFundStaticDataType/StockExchanges/Exchange**

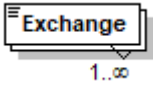
|            |  |
|------------|--|
| diagram    |  |
| type       | restriction of <b>xs:string</b>  |
| properties | isRef 0<br>minOcc 1<br>maxOcc unbounded<br>content simple                          |
| facets     | Kind Value annotation<br>length 4  |

element **SingleFundStaticDataType/ExchangeTradedFlag**

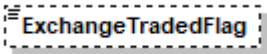
|            |   |
|------------|---|
| diagram    |  |
| type       | <b>xs:boolean</b>   |
| properties | isRef 0<br>minOcc 0<br>maxOcc 1<br>content simple                                   |

element **SingleFundStaticDataType/FundOfFundFlag**

|         |   |
|---------|---|
| diagram |  |
| type    | <b>xs:boolean</b>   |

|            |   |
|------------|---|
| properties | isRef 0<br>minOcc 0<br>maxOcc 1<br>content simple |
|------------|---|

element **SingleFundStaticDataType/SocialResponsibleFlag**

|            |   |
|------------|---|
| diagram    |  |
| type       | <b>xs:boolean</b>   |
| properties | isRef 0<br>minOcc 0<br>maxOcc 1<br>content simple                                 |

element **SingleFundStaticDataType/ManagementType**

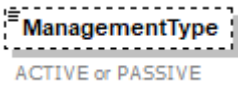
|            |   |
|------------|---|
| diagram    |  |
| type       | restriction of <b>xs:string</b>   |
| properties | isRef 0<br>minOcc 0<br>maxOcc 1<br>content simple                                 |
| annotation | documentation<br>ACTIVE or PASSIVE  |

element **SingleFundStaticDataType/PricePublishedFlag**

|            |   |
|------------|---|
| diagram    |  |
| type       | <b>xs:boolean</b>   |
| properties | isRef 0<br>minOcc 0<br>maxOcc 1<br>content simple                                   |
| annotation | documentation<br>Defines whether prices are published or not                        |

element **SingleFundStaticDataType/SalesCategory**

|            |   |
|------------|---|
| diagram    |  |
| type       | restriction of <b>xs:string</b>   |
| properties | isRef 0<br>minOcc 0<br>maxOcc 1<br>content simple                                   |

|            |  |
|------------|--|
| annotation | documentation<br>PUBLIC, RETAIL, RETAIL-HNW, SPECIAL |
|------------|--|

element **SingleFundStaticDataType/InvestmentHorizon**

|            |  |
|------------|--|
| diagram    |  |
| properties | isRef 0<br>minOcc 0<br>maxOcc 1<br>content complex   |
| children   | <a href="#">Minimum</a> <a href="#">Optimum</a>      |
| annotation | documentation<br>Recommended holding period in years |

element **SingleFundStaticDataType/InvestmentHorizon/Minimum**

|            |   |
|------------|---|
| diagram    |   |
| type       | <b>xs:decimal</b>                                 |
| properties | isRef 0<br>minOcc 0<br>maxOcc 1<br>content simple |

element **SingleFundStaticDataType/InvestmentHorizon/Optimum**

|            |   |
|------------|---|
| diagram    |   |
| type       | <b>xs:decimal</b>                                 |
| properties | isRef 0<br>minOcc 0<br>maxOcc 1<br>content simple |

element **SingleFundStaticDataType/IsFeederFor**

diagram

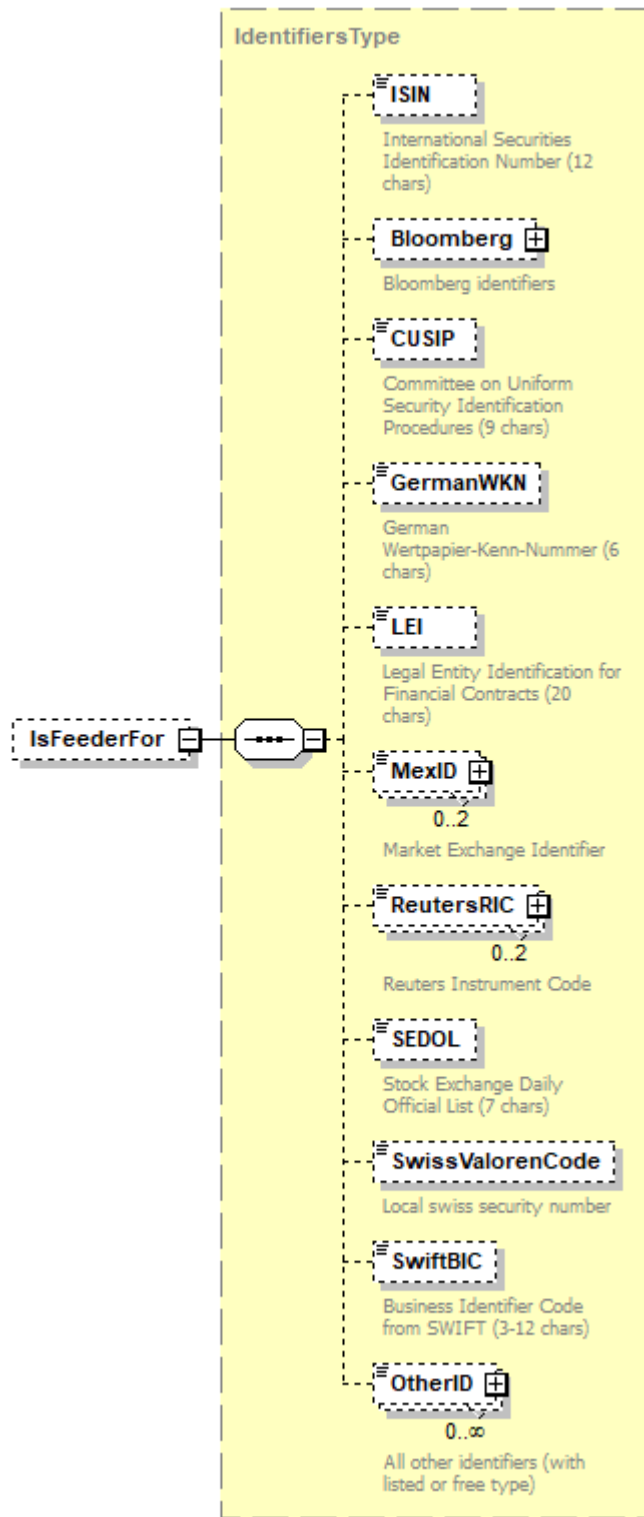

type [IdentifiersType](#)

properties  
 isRef 0  
 minOcc 0  
 maxOcc 1

|          |   |
|----------|---|
|          | content complex   |
| children | <a href="#">ISIN</a> <a href="#">Bloomberg</a> <a href="#">CUSIP</a> <a href="#">GermanWKN</a> <a href="#">LEI</a> <a href="#">MexID</a> <a href="#">ReutersRIC</a> <a href="#">SEDOL</a> <a href="#">SwissValorenCode</a> <a href="#">SwiftBIC</a> <a href="#">OtherID</a> |

element **SingleFundStaticDataType/IsMasterFor**

diagram

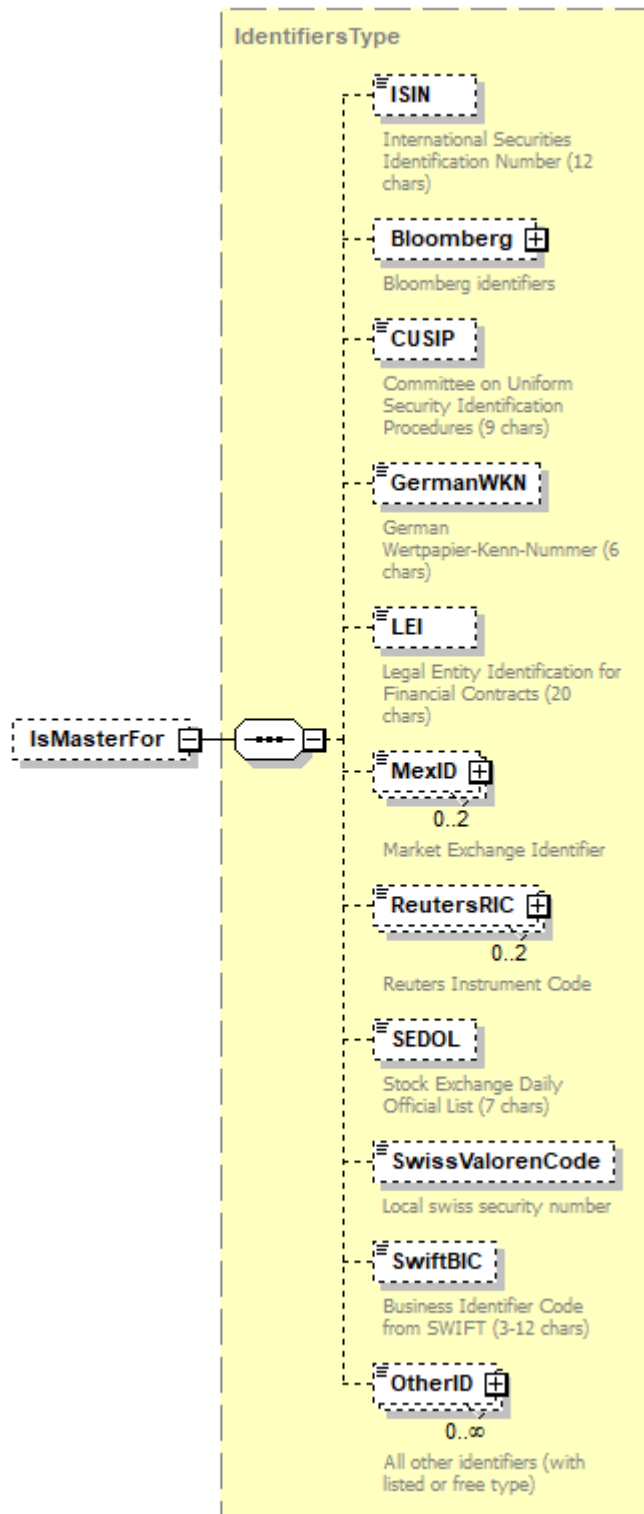

type [IdentifiersType](#)

properties  
 isRef 0  
 minOcc 0  
 maxOcc 1

|          |   |
|----------|---|
|          | content complex   |
| children | <a href="#">ISIN</a> <a href="#">Bloomberg</a> <a href="#">CUSIP</a> <a href="#">GermanWKN</a> <a href="#">LEI</a> <a href="#">MexID</a> <a href="#">ReutersRIC</a> <a href="#">SEDOL</a> <a href="#">SwissValorenCode</a> <a href="#">SwiftBIC</a> <a href="#">OtherID</a> |

complexType **SubfundCompaniesType**

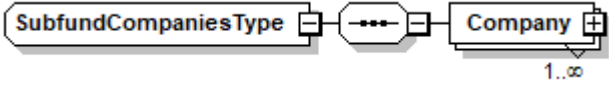
|          |  |
|----------|--|
| diagram  |  The diagram shows a complex type 'SubfundCompaniesType' connected to a choice element containing a 'Company' element. The 'Company' element has a cardinality of 1..∞. |
| children | <a href="#">Company</a>  |
| used by  | element <a href="#">SubfundStaticDataType/Companies</a>  |

element **SubfundCompaniesType/Company**

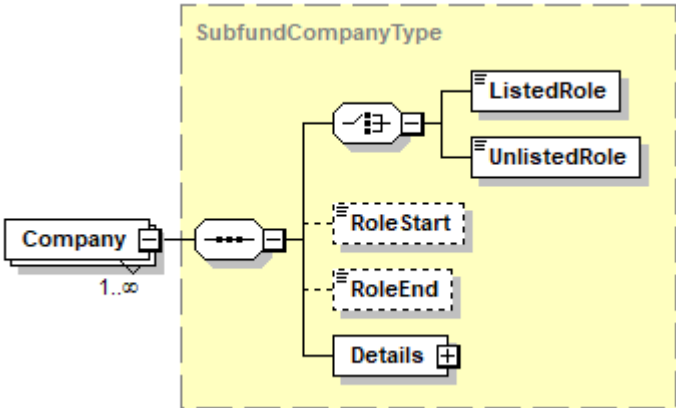
|            |   |
|------------|---|
| diagram    |  The diagram shows the 'SubfundCompanyType' element (highlighted in yellow) containing a choice element. This choice element has four branches: 'ListedRole' and 'UnlistedRole' (both solid boxes), 'Role Start' and 'Role End' (both dashed boxes), and 'Details' (solid box). The 'SubfundCompanyType' element has a cardinality of 1..∞. |
| type       | <a href="#">SubfundCompanyType</a>  |
| properties | isRef 0<br>minOcc 1<br>maxOcc unbounded<br>content complex  |
| children   | <a href="#">ListedRole</a> <a href="#">UnlistedRole</a> <a href="#">RoleStart</a> <a href="#">RoleEnd</a> <a href="#">Details</a>   |

complexType **SubfundCompanyType**

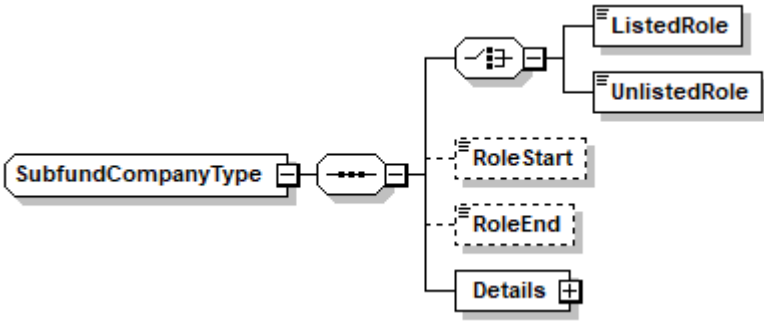
|          |  |
|----------|--|
| diagram  |  The diagram shows a complex type 'SubfundCompanyType' connected to a choice element. This choice element has four branches: 'ListedRole' and 'UnlistedRole' (both solid boxes), 'Role Start' and 'Role End' (both dashed boxes), and 'Details' (solid box). |
| children | <a href="#">ListedRole</a> <a href="#">UnlistedRole</a> <a href="#">RoleStart</a> <a href="#">RoleEnd</a> <a href="#">Details</a>  |
| used by  | element <a href="#">SubfundCompaniesType/Company</a>   |

element **SubfundCompanyType/ListedRole**

|            |   |
|------------|---|
| diagram    |  |
| type       | restriction of <b>xs:string</b>   |
| properties | isRef 0<br>content simple   |

element **SubfundCompanyType/UnlistedRole**

|            |   |
|------------|---|
| diagram    |  |
| type       | <a href="#">Text200Type</a>   |
| properties | isRef 0<br>content simple   |
| facets     | Kind Value annotation<br>maxLength 200  |

element **SubfundCompanyType/RoleStart**

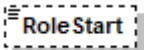
|            |   |
|------------|---|
| diagram    |  |
| type       | <b>xs:date</b>  |
| properties | isRef 0<br>minOcc 0<br>maxOcc 1<br>content simple                                 |

element **SubfundCompanyType/RoleEnd**

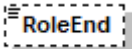
|            |   |
|------------|---|
| diagram    |  |
| type       | <b>xs:date</b>  |
| properties | isRef 0<br>minOcc 0<br>maxOcc 1<br>content simple                                   |



element **SubfundCompanyType/Details**

|                   |   |
|-------------------|---|
| <p>diagram</p>    | <p>The diagram illustrates the structure of the <b>SubfundCompanyType/Details</b> element. It shows a <b>Details</b> container connected to a <b>CompanyType</b> container. The <b>CompanyType</b> container includes the following elements:</p> <ul style="list-style-type: none"> <li><b>Identifiers</b>: Identifiers of company</li> <li><b>Name</b>: Name of company</li> <li><b>LegalName</b>: Legal (full) name of company</li> <li><b>LegalForm</b>: Legal form of company</li> <li><b>Address</b>: Address of company</li> <li><b>BusinessCountry</b>: Country code of main business of company</li> <li><b>ParentCompany</b>: Parent company (if applicable)</li> <li><b>OtherClassification</b>: All other identifiers (with listed or free type) with cardinality 0..∞</li> </ul> |
| <p>type</p>       | <p><a href="#">CompanyType</a></p>  |
| <p>properties</p> | <p>isRef 0<br/>content complex</p>  |
| <p>children</p>   | <p><a href="#">Identifiers</a> <a href="#">Name</a> <a href="#">LegalName</a> <a href="#">LegalForm</a> <a href="#">Address</a> <a href="#">BusinessCountry</a> <a href="#">ParentCompany</a> <a href="#">OtherClassification</a></p>   |

complexType SubfundStaticDataType

diagram

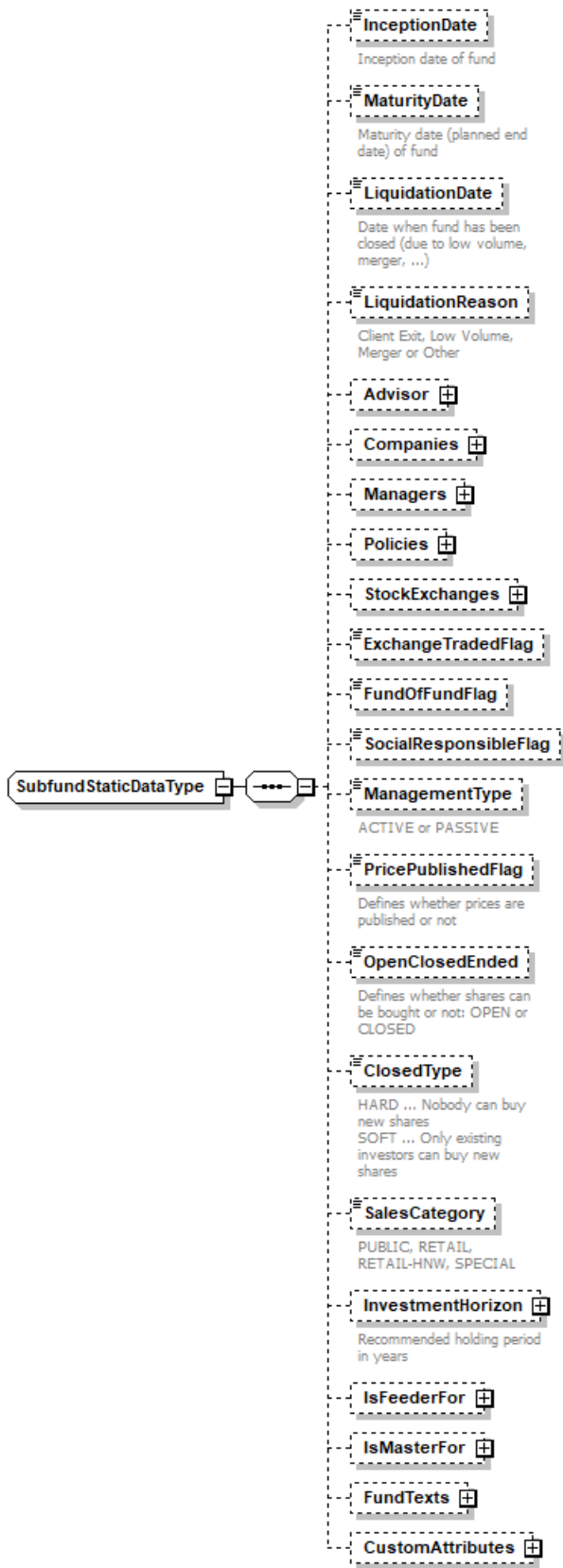

|          |   |
|----------|---|
| children | <a href="#">InceptionDate</a> <a href="#">MaturityDate</a> <a href="#">LiquidationDate</a> <a href="#">LiquidationReason</a> <a href="#">Advisor</a> <a href="#">Companies</a> <a href="#">Managers</a> <a href="#">Policies</a> <a href="#">StockExchanges</a> <a href="#">ExchangeTradedFlag</a> <a href="#">FundOfFundFlag</a> <a href="#">SocialResponsibleFlag</a> <a href="#">ManagementType</a> <a href="#">PricePublishedFlag</a> <a href="#">OpenClosedEnded</a> <a href="#">ClosedType</a> <a href="#">SalesCategory</a> <a href="#">InvestmentHorizon</a> <a href="#">IsFeederFor</a> <a href="#">IsMasterFor</a> <a href="#">FundTexts</a> <a href="#">CustomAttributes</a> |
| used by  | element <a href="#">SubfundType/SubfundStaticData</a>   |

#### element **SubfundStaticDataType/InceptionDate**

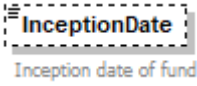
|            |   |
|------------|---|
| diagram    | <br>Inception date of fund |
| type       | <b>xs:date</b>  |
| properties | isRef 0<br>minOcc 0<br>maxOcc 1<br>content simple   |
| annotation | documentation<br>Inception date of fund   |

#### element **SubfundStaticDataType/MaturityDate**

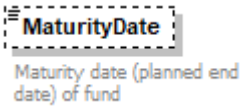
|            |   |
|------------|---|
| diagram    | <br>Maturity date (planned end date) of fund |
| type       | <b>xs:date</b>  |
| properties | isRef 0<br>minOcc 0<br>maxOcc 1<br>content simple   |
| annotation | documentation<br>Maturity date (planned end date) of fund   |

#### element **SubfundStaticDataType/LiquidationDate**

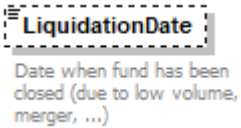
|            |  |
|------------|--|
| diagram    | <br>Date when fund has been closed (due to low volume, merger, ...) |
| type       | <b>xs:date</b>   |
| properties | isRef 0<br>minOcc 0<br>maxOcc 1<br>content simple  |
| annotation | documentation<br>Date when fund has been closed (due to low volume, merger, ...)   |

element **SubfundStaticDataType/LiquidationReason**

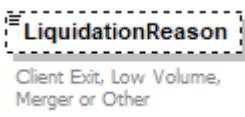
|            |  |
|------------|--|
| diagram    |  <p><b>LiquidationReason</b><br/>Client Exit, Low Volume, Merger or Other</p> |
| type       | restriction of <b>xs:string</b>  |
| properties | isRef 0<br>minOcc 0<br>maxOcc 1<br>content simple  |
| annotation | documentation<br>Client Exit, Low Volume, Merger or Other  |

element **SubfundStaticDataType/Advisor**

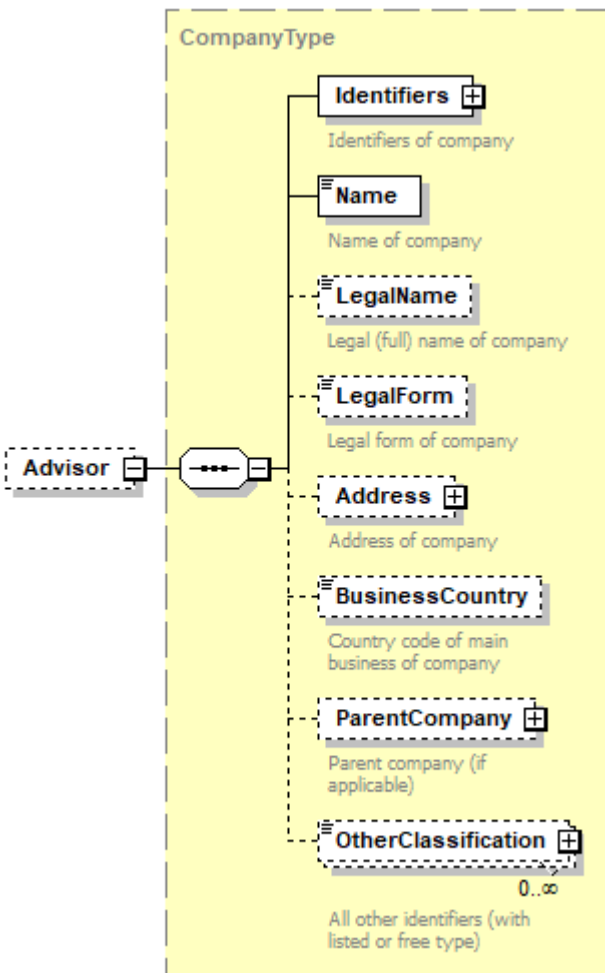
|            |  |
|------------|--|
| diagram    |  <p>The diagram shows an <b>Advisor</b> element (dashed box) containing a <b>CompanyType</b> element (yellow background, dashed border). The <b>CompanyType</b> element contains the following sub-elements:</p> <ul style="list-style-type: none"> <li><b>Identifiers</b> (+): Identifiers of company</li> <li><b>Name</b>: Name of company</li> <li><b>LegalName</b> (dashed): Legal (full) name of company</li> <li><b>LegalForm</b> (dashed): Legal form of company</li> <li><b>Address</b> (+): Address of company</li> <li><b>BusinessCountry</b> (dashed): Country code of main business of company</li> <li><b>ParentCompany</b> (+): Parent company (if applicable)</li> <li><b>OtherClassification</b> (+): All other identifiers (with listed or free type) 0..∞</li> </ul> |
| type       | <a href="#">CompanyType</a>  |
| properties | isRef 0<br>minOcc 0<br>maxOcc 1<br>content complex   |
| children   | <a href="#">Identifiers</a> <a href="#">Name</a> <a href="#">LegalName</a> <a href="#">LegalForm</a> <a href="#">Address</a> <a href="#">BusinessCountry</a> <a href="#">ParentCompany</a> <a href="#">OtherClassification</a>   |

element **SubfundStaticDataType/Companies**

|            |  |
|------------|--|
| diagram    |  |
| type       | <a href="#">SubfundCompaniesType</a>               |
| properties | isRef 0<br>minOcc 0<br>maxOcc 1<br>content complex |
| children   | <a href="#">Company</a>                            |

element **SubfundStaticDataType/Managers**

|            |  |
|------------|--|
| diagram    |  |
| properties | isRef 0<br>minOcc 0<br>maxOcc 1<br>content complex |
| children   | <a href="#">Manager</a>                            |

element **SubfundStaticDataType/Managers/Manager**

|                   |  |
|-------------------|--|
| <p>diagram</p>    | <p>The diagram illustrates the structure of the <b>CompanyType</b> element. It is a complex type containing several child elements:</p> <ul style="list-style-type: none"> <li><b>Identifiers</b>: Identifiers of company (required, 1..∞)</li> <li><b>Name</b>: Name of company (required)</li> <li><b>LegalName</b>: Legal (full) name of company (optional)</li> <li><b>LegalForm</b>: Legal form of company (optional)</li> <li><b>Address</b>: Address of company (required)</li> <li><b>BusinessCountry</b>: Country code of main business of company (optional)</li> <li><b>ParentCompany</b>: Parent company (if applicable) (optional)</li> <li><b>OtherClassification</b>: All other identifiers (with listed or free type) (optional, 0..∞)</li> </ul> <p>A <b>Manager</b> element (required, 1..∞) is shown connected to the <b>CompanyType</b> element.</p> |
| <p>type</p>       | <p><a href="#">CompanyType</a></p>   |
| <p>properties</p> | <p>isRef 0<br/> minOcc 1<br/> maxOcc unbounded<br/> content complex</p>  |
| <p>children</p>   | <p><a href="#">Identifiers</a> <a href="#">Name</a> <a href="#">LegalName</a> <a href="#">LegalForm</a> <a href="#">Address</a> <a href="#">BusinessCountry</a> <a href="#">ParentCompany</a> <a href="#">OtherClassification</a></p>  |

element **SubfundStaticDataType/Policies**

|                   |  |
|-------------------|--|
| <p>diagram</p>    | <p>The diagram illustrates the structure of the <b>Policies</b> element. It is a complex type containing a single child element:</p> <ul style="list-style-type: none"> <li><b>Policy</b>: (required, 1..∞)</li> </ul> |
| <p>properties</p> | <p>isRef 0<br/> minOcc 0<br/> maxOcc 1<br/> content complex</p>  |
| <p>children</p>   | <p><a href="#">Policy</a></p>  |

element **SubfundStaticDataType/Policies/Policy**

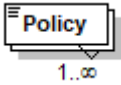
|            |  |       |   |        |   |        |           |         |        |
|------------|--|-------|---|--------|---|--------|-----------|---------|--------|
| diagram    |   |       |   |        |   |        |           |         |        |
| type       | <b>xs:string</b>   |       |   |        |   |        |           |         |        |
| properties | <table border="0"> <tr><td>isRef</td><td>0</td></tr> <tr><td>minOcc</td><td>1</td></tr> <tr><td>maxOcc</td><td>unbounded</td></tr> <tr><td>content</td><td>simple</td></tr> </table> | isRef | 0 | minOcc | 1 | maxOcc | unbounded | content | simple |
| isRef      | 0  |       |   |        |   |        |           |         |        |
| minOcc     | 1  |       |   |        |   |        |           |         |        |
| maxOcc     | unbounded  |       |   |        |   |        |           |         |        |
| content    | simple   |       |   |        |   |        |           |         |        |

element **SubfundStaticDataType/StockExchanges**

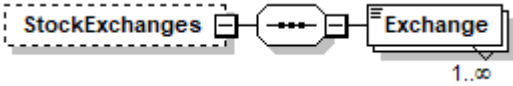
|            |   |       |   |        |   |        |   |         |         |
|------------|---|-------|---|--------|---|--------|---|---------|---------|
| diagram    |    |       |   |        |   |        |   |         |         |
| properties | <table border="0"> <tr><td>isRef</td><td>0</td></tr> <tr><td>minOcc</td><td>0</td></tr> <tr><td>maxOcc</td><td>1</td></tr> <tr><td>content</td><td>complex</td></tr> </table> | isRef | 0 | minOcc | 0 | maxOcc | 1 | content | complex |
| isRef      | 0   |       |   |        |   |        |   |         |         |
| minOcc     | 0   |       |   |        |   |        |   |         |         |
| maxOcc     | 1   |       |   |        |   |        |   |         |         |
| content    | complex   |       |   |        |   |        |   |         |         |
| children   | <a href="#">Exchange</a>  |       |   |        |   |        |   |         |         |

element **SubfundStaticDataType/StockExchanges/Exchange**

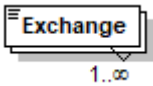
|            |  |            |       |            |        |        |           |         |        |
|------------|--|------------|-------|------------|--------|--------|-----------|---------|--------|
| diagram    |    |            |       |            |        |        |           |         |        |
| type       | restriction of <b>xs:string</b>  |            |       |            |        |        |           |         |        |
| properties | <table border="0"> <tr><td>isRef</td><td>0</td></tr> <tr><td>minOcc</td><td>1</td></tr> <tr><td>maxOcc</td><td>unbounded</td></tr> <tr><td>content</td><td>simple</td></tr> </table> | isRef      | 0     | minOcc     | 1      | maxOcc | unbounded | content | simple |
| isRef      | 0  |            |       |            |        |        |           |         |        |
| minOcc     | 1  |            |       |            |        |        |           |         |        |
| maxOcc     | unbounded  |            |       |            |        |        |           |         |        |
| content    | simple   |            |       |            |        |        |           |         |        |
| facets     | <table border="0"> <tr><td>Kind</td><td>Value</td><td>annotation</td></tr> <tr><td>length</td><td>4</td><td></td></tr> </table>  | Kind       | Value | annotation | length | 4      |           |         |        |
| Kind       | Value  | annotation |       |            |        |        |           |         |        |
| length     | 4  |            |       |            |        |        |           |         |        |

element **SubfundStaticDataType/ExchangeTradedFlag**

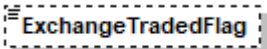
|            |  |       |   |        |   |        |   |         |        |
|------------|--|-------|---|--------|---|--------|---|---------|--------|
| diagram    |   |       |   |        |   |        |   |         |        |
| type       | <b>xs:boolean</b>  |       |   |        |   |        |   |         |        |
| properties | <table border="0"> <tr><td>isRef</td><td>0</td></tr> <tr><td>minOcc</td><td>0</td></tr> <tr><td>maxOcc</td><td>1</td></tr> <tr><td>content</td><td>simple</td></tr> </table> | isRef | 0 | minOcc | 0 | maxOcc | 1 | content | simple |
| isRef      | 0  |       |   |        |   |        |   |         |        |
| minOcc     | 0  |       |   |        |   |        |   |         |        |
| maxOcc     | 1  |       |   |        |   |        |   |         |        |
| content    | simple   |       |   |        |   |        |   |         |        |

element **SubfundStaticDataType/FundOfFundFlag**

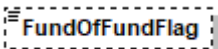
|         |   |
|---------|---|
| diagram |  |
| type    | <b>xs:boolean</b>   |

|            |   |
|------------|---|
| properties | isRef 0<br>minOcc 0<br>maxOcc 1<br>content simple |
|------------|---|

element **SubfundStaticDataType/SocialResponsibleFlag**

|            |   |
|------------|---|
| diagram    |   |
| type       | <b>xs:boolean</b>                                 |
| properties | isRef 0<br>minOcc 0<br>maxOcc 1<br>content simple |

element **SubfundStaticDataType/ManagementType**

|            |   |
|------------|---|
| diagram    |   |
| type       | restriction of <b>xs:string</b>                     |
| properties | isRef 0<br>minOcc 0<br>maxOcc 1<br>content simple   |
| facets     | Kind Value annotation<br>minLength 6<br>maxLength 7 |
| annotation | documentation<br>ACTIVE or PASSIVE                  |

element **SubfundStaticDataType/PricePublishedFlag**

|            |  |
|------------|--|
| diagram    |  |
| type       | <b>xs:boolean</b>  |
| properties | isRef 0<br>minOcc 0<br>maxOcc 1<br>content simple            |
| annotation | documentation<br>Defines whether prices are published or not |

element **SubfundStaticDataType/OpenClosedEnded**

|         |                                 |
|---------|---------------------------------|
| diagram |                                 |
| type    | restriction of <b>xs:string</b> |



|            |  |
|------------|--|
| properties | isRef 0<br>minOcc 0<br>maxOcc 1<br>content simple                            |
| facets     | Kind Value annotation<br>minLength 4<br>maxLength 6                          |
| annotation | documentation<br>Defines whether shares can be bought or not: OPEN or CLOSED |

element **SubfundStaticDataType/ClosedType**

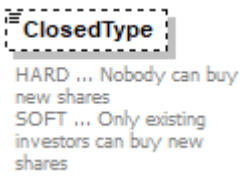
|            |  |
|------------|--|
| diagram    |                           |
| type       | restriction of <b>xs:string</b>  |
| properties | isRef 0<br>minOcc 0<br>maxOcc 1<br>content simple  |
| facets     | Kind Value annotation<br>length 4  |
| annotation | documentation<br>HARD ... Nobody can buy new shares<br>SOFT ... Only existing investors can buy new shares |

element **SubfundStaticDataType/SalesCategory**

|            |   |
|------------|---|
| diagram    |  |
| type       | restriction of <b>xs:string</b>   |
| properties | isRef 0<br>minOcc 0<br>maxOcc 1<br>content simple                                   |
| facets     | Kind Value annotation<br>minLength 6<br>maxLength 11                                |
| annotation | documentation<br>PUBLIC, RETAIL, RETAIL-HNW, SPECIAL                                |

element **SubfundStaticDataType/InvestmentHorizon**

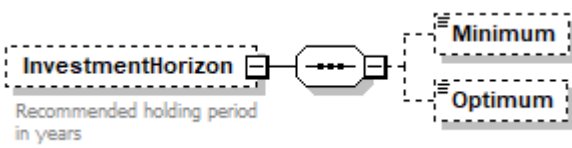
|            |   |
|------------|---|
| diagram    |  |
| properties | isRef 0<br>minOcc 0   |

|            |  |
|------------|--|
|            | maxOcc 1<br>content complex                          |
| children   | <a href="#">Minimum</a> <a href="#">Optimum</a>      |
| annotation | documentation<br>Recommended holding period in years |

element **SubfundStaticDataType/InvestmentHorizon/Minimum**

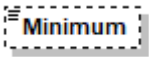
|            |   |
|------------|---|
| diagram    |  |
| type       | <b>xs:decimal</b>   |
| properties | isRef 0<br>minOcc 0<br>maxOcc 1<br>content simple                                 |

element **SubfundStaticDataType/InvestmentHorizon/Optimum**

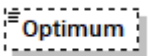
|            |   |
|------------|---|
| diagram    |  |
| type       | <b>xs:decimal</b>   |
| properties | isRef 0<br>minOcc 0<br>maxOcc 1<br>content simple                                 |

element **SubfundStaticDataType/IsFeederFor**

diagram

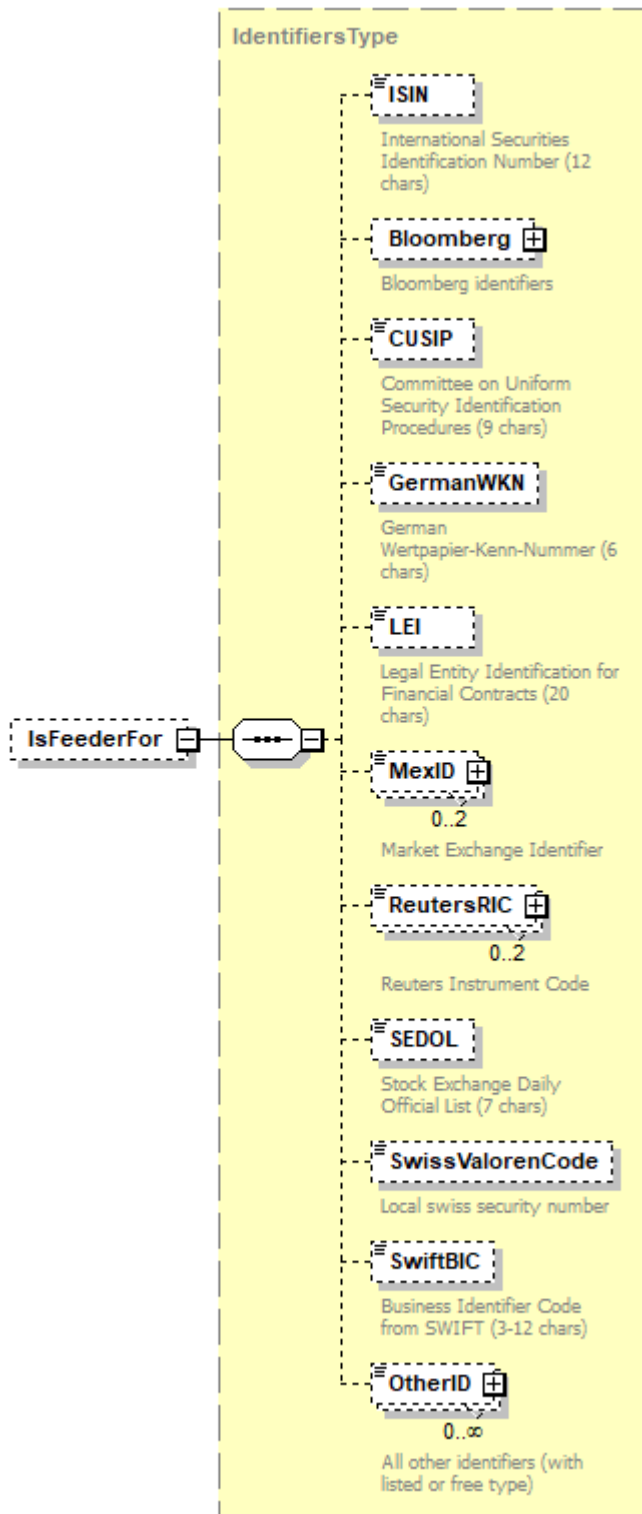

type [IdentifiersType](#)

properties  
 isRef 0  
 minOcc 0  
 maxOcc 1

|          |   |
|----------|---|
|          | content complex   |
| children | <a href="#">ISIN</a> <a href="#">Bloomberg</a> <a href="#">CUSIP</a> <a href="#">GermanWKN</a> <a href="#">LEI</a> <a href="#">MexID</a> <a href="#">ReutersRIC</a> <a href="#">SEDOL</a> <a href="#">SwissValorenCode</a> <a href="#">SwiftBIC</a> <a href="#">OtherID</a> |

element **SubfundStaticDataType/IsMasterFor**

diagram

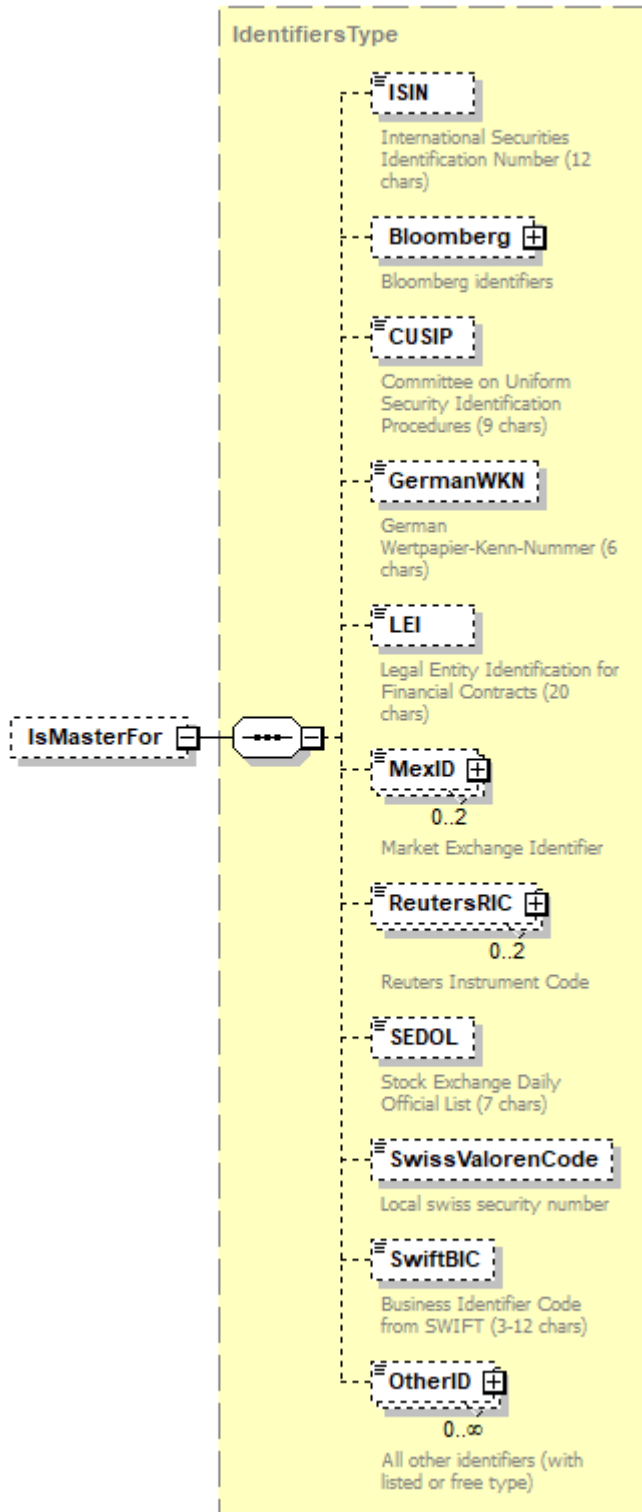

type [IdentifiersType](#)

properties  
 isRef 0  
 minOcc 0  
 maxOcc 1

|          |   |
|----------|---|
|          | content complex   |
| children | <a href="#">ISIN</a> <a href="#">Bloomberg</a> <a href="#">CUSIP</a> <a href="#">GermanWKN</a> <a href="#">LEI</a> <a href="#">MexID</a> <a href="#">ReutersRIC</a> <a href="#">SEDOL</a> <a href="#">SwissValorenCode</a> <a href="#">SwiftBIC</a> <a href="#">OtherID</a> |

element **SubfundStaticDataType/FundTexts**

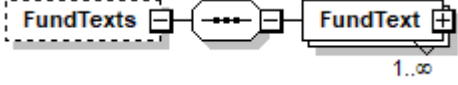
|            |   |
|------------|---|
| diagram    |  |
| properties | isRef 0<br>minOcc 0<br>maxOcc 1<br>content complex                                |
| children   | <a href="#">FundText</a>  |

element **SubfundStaticDataType/FundTexts/FundText**

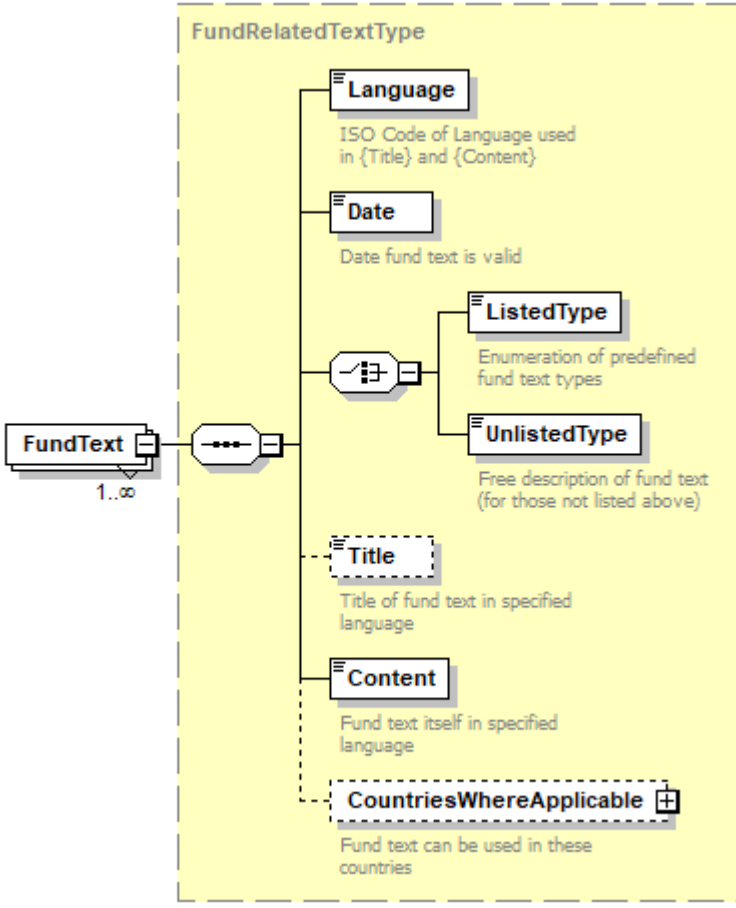
|            |  |
|------------|--|
| diagram    |   |
| type       | <a href="#">FundRelatedTextType</a>  |
| properties | isRef 0<br>minOcc 1<br>maxOcc unbounded<br>content complex   |
| children   | <a href="#">Language</a> <a href="#">Date</a> <a href="#">ListedType</a> <a href="#">UnlistedType</a> <a href="#">Title</a> <a href="#">Content</a> <a href="#">CountriesWhereApplicable</a> |

element **SubfundStaticDataType/CustomAttributes**

|            |  |
|------------|--|
| diagram    |  |
| type       | <a href="#">AttributesType</a>                     |
| properties | isRef 0<br>minOcc 0<br>maxOcc 1<br>content complex |
| children   | <a href="#">Attribute</a>                          |

simpleType **BenchmarkUsageType**

|            |  |
|------------|--|
| type       | restriction of <code>xs:string</code>  |
| properties | base <code>xs:string</code>  |
| used by    | attribute <a href="#">BenchmarkStaticDataType/BenchmarkUsage/@ListedType</a> |

complexType **BenchmarkDynamicDataType**

|          |  |
|----------|--|
| diagram  |  |
| children | <a href="#">BenchmarkID</a> <a href="#">Values</a>               |
| used by  | element <a href="#">FundDynamicDataType/Benchmarks/Benchmark</a> |

element **BenchmarkDynamicDataType/BenchmarkID**

|            |   |
|------------|---|
| diagram    |   |
| type       | restriction of <code>xs:string</code>             |
| properties | isRef 0<br>minOcc 0<br>maxOcc 1<br>content simple |
| facets     | Kind Value annotation<br>maxLength 255            |
| annotation | documentation<br>Link from Benchmark Static Data  |

element **BenchmarkDynamicDataType/Values**

|            |                            |
|------------|----------------------------|
| diagram    |                            |
| properties | isRef 0<br>content complex |
| children   | <a href="#">Value</a>      |

element **BenchmarkDynamicDataType/Values/Value**

|            |   |
|------------|---|
| diagram    |   |
| properties | isRef 0<br>minOcc 1<br>maxOcc unbounded<br>content complex                                      |
| children   | <a href="#">Date</a> <a href="#">ValueType</a> <a href="#">Value</a> <a href="#">Components</a> |

element **BenchmarkDynamicDataType/Values/Value/Date**

|            |                           |
|------------|---------------------------|
| diagram    |                           |
| type       | <b>xs:date</b>            |
| properties | isRef 0<br>content simple |

element **BenchmarkDynamicDataType/Values/Value/ValueType**

|            |                                 |
|------------|---------------------------------|
| diagram    |                                 |
| type       | restriction of <b>xs:string</b> |
| properties | isRef 0<br>content simple       |



element **BenchmarkDynamicDataType/Values/Value/Value**

|            |                            |
|------------|----------------------------|
| diagram    |                            |
| type       | <a href="#">AmountType</a> |
| properties | isRef 0<br>content complex |
| children   | <a href="#">Amount</a>     |

element **BenchmarkDynamicDataType/Values/Value/Components**

|            |  |
|------------|--|
| diagram    |  |
| properties | isRef 0<br>minOcc 0<br>maxOcc 1<br>content complex |
| children   | <a href="#">Component</a>                          |

element **BenchmarkDynamicDataType/Values/Value/Components/Component**

|            |  |
|------------|--|
| diagram    |  |
| properties | isRef 0<br>minOcc 1<br>maxOcc unbounded<br>content complex                           |
| children   | <a href="#">BenchmarkComponentID</a> <a href="#">ValueType</a> <a href="#">Value</a> |

element **BenchmarkDynamicDataType/Values/Value/Components/Component/BenchmarkComponentID**

|            |   |
|------------|---|
| diagram    |   |
| type       | restriction of <b>xs:string</b>                   |
| properties | isRef 0<br>minOcc 0<br>maxOcc 1<br>content simple |
| facets     | Kind Value annotation<br>maxLength 255            |

element **BenchmarkDynamicDataType/Values/Value/Components/Component/ValueType**

|            |   |
|------------|---|
| diagram    |  |
| type       | restriction of <b>xs:string</b>   |
| properties | isRef 0<br>content simple   |

element **BenchmarkDynamicDataType/Values/Value/Components/Component/Value**

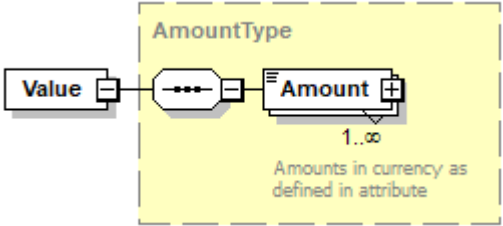
|            |   |
|------------|---|
| diagram    |  |
| type       | <a href="#">AmountType</a>  |
| properties | isRef 0<br>content complex  |
| children   | <a href="#">Amount</a>  |

complexType **FundDynamicDataType**

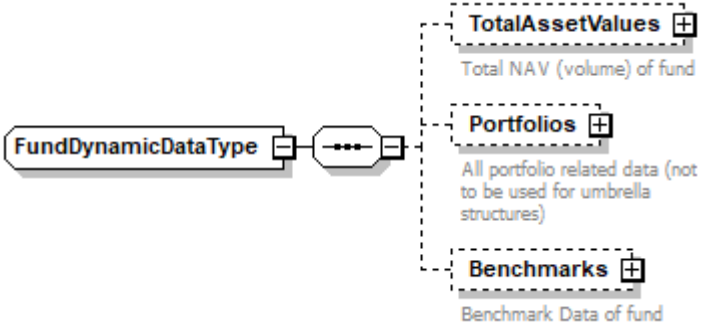
|          |  |
|----------|--|
| diagram  |               |
| children | <a href="#">TotalAssetValues</a> <a href="#">Portfolios</a> <a href="#">Benchmarks</a>           |
| used by  | elements <a href="#">FundType/FundDynamicData</a> <a href="#">SubfundType/SubfundDynamicData</a> |

element **FundDynamicDataType/TotalAssetValues**

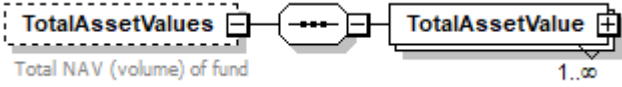
|            |   |
|------------|---|
| diagram    |  |
| properties | isRef 0<br>minOcc 0<br>maxOcc 1<br>content complex                                  |
| children   | <a href="#">TotalAssetValue</a>   |

|            |   |
|------------|---|
| annotation | documentation<br>Total NAV (volume) of fund |
|------------|---|

element **FundDynamicDataType/TotalAssetValues/TotalAssetValue**

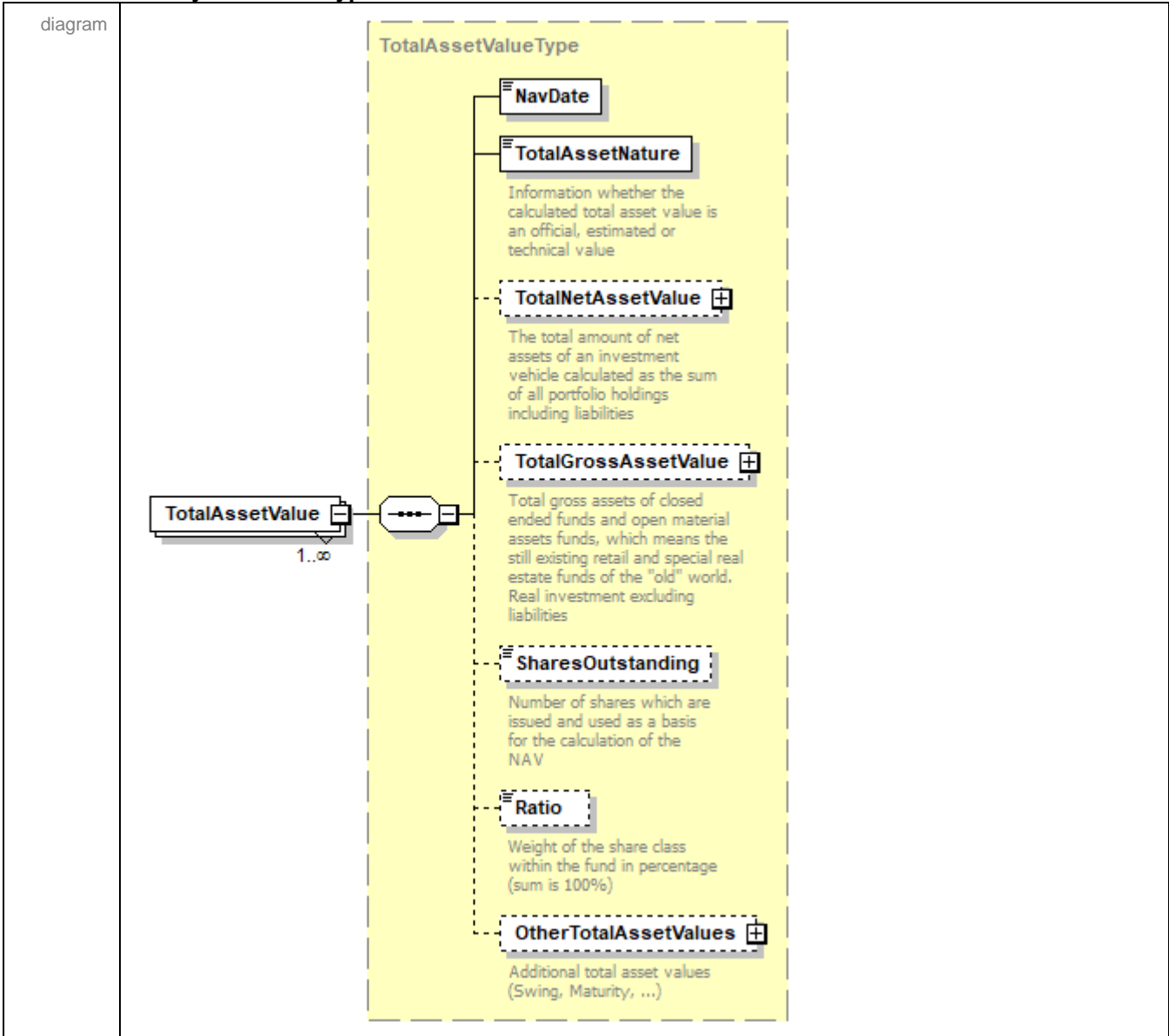

|            |  |
|------------|--|
| type       | <a href="#">TotalAssetValueType</a>  |
| properties | isRef 0<br>minOcc 1<br>maxOcc unbounded<br>content complex   |
| children   | <a href="#">NavDate</a> <a href="#">TotalAssetNature</a> <a href="#">TotalNetAssetValue</a> <a href="#">TotalGrossAssetValue</a> <a href="#">SharesOutstanding</a> <a href="#">Ratio</a> <a href="#">OtherTotalAssetValues</a> |

element **FundDynamicDataType/Portfolios**

|            |   |
|------------|---|
| diagram    | <p>All portfolio related data (not to be used for umbrella structures)</p>                    |
| properties | <p>isRef 0<br/> minOcc 0<br/> maxOcc 1<br/> content complex</p>                               |
| children   | <a href="#">Portfolio</a>   |
| annotation | <p>documentation<br/> All portfolio related data (not to be used for umbrella structures)</p> |

element **FundDynamicDataType/Portfolios/Portfolio**

|            |   |
|------------|---|
| diagram    | <p><b>PortfolioType</b></p> <ul style="list-style-type: none"> <li><b>NavDate</b><br/>NavDate for all data within this section</li> <li><b>Positions</b><br/>All positions/holdings of fund/portfolio (including accounts, earnings and fees)</li> <li><b>Transactions</b><br/>Transactions within the portfolio (securities and other assets bought or sold)</li> <li><b>Earnings</b><br/>Earnings data (coupons, dividends, distributions) resulting from security positions</li> <li><b>PositionsDecomposed</b><br/>Decomposed positions (holdings of share classes are replaced by the scaled down positions of the subfund)</li> <li><b>BreakDowns</b><br/>All kind of break down data (including currency exposure)</li> <li><b>RiskCodes</b><br/>List of risk codes (risk indicators, key risk figures)</li> </ul> |
| type       | <a href="#">PortfolioType</a>   |
| properties | <p>isRef 0<br/> minOcc 1<br/> maxOcc unbounded</p>  |

|          |  |
|----------|--|
|          | content complex  |
| children | <a href="#">NavDate</a> <a href="#">Positions</a> <a href="#">Transactions</a> <a href="#">Earnings</a> <a href="#">PositionsDecomposed</a> <a href="#">BreakDowns</a> <a href="#">RiskCodes</a> |

element **FundDynamicDataType/Benchmarks**

|            |  |
|------------|--|
| diagram    |  |
| properties | isRef 0<br>minOcc 0<br>maxOcc 1<br>content complex |
| children   | <a href="#">Benchmark</a>                          |
| annotation | documentation<br>Benchmark Data of fund            |

element **FundDynamicDataType/Benchmarks/Benchmark**

|            |  |
|------------|--|
| diagram    |  |
| type       | <a href="#">BenchmarkDynamicDataType</a>                   |
| properties | isRef 0<br>minOcc 1<br>maxOcc unbounded<br>content complex |
| children   | <a href="#">BenchmarkID</a> <a href="#">Values</a>         |

complexType **AllocationType**

|          |  |
|----------|--|
| diagram  |  |
| children | <a href="#">NavDate</a> <a href="#">InvestorTypes</a> <a href="#">NumberOfShares</a> |
| used by  | element <a href="#">ShareClassType/InvestorAllocation/Allocation</a>                 |

element **AllocationType/NavDate**

|            |   |
|------------|---|
| diagram    |  |
| type       | <b>xs:date</b>  |
| properties | isRef 0<br>content simple   |

element **AllocationType/InvestorTypes**

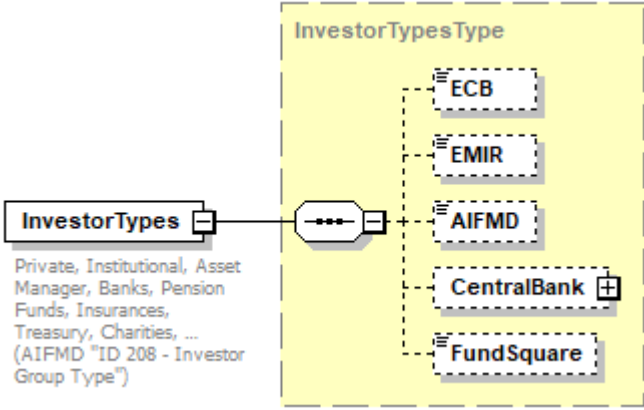
|            |   |
|------------|---|
| diagram    |  <p>The diagram shows the <b>InvestorTypes</b> element (represented by a rectangle with a small square on its right side) connected to a dashed-line container labeled <b>InvestorTypesType</b>. Inside this container, five sub-elements are listed: <b>ECB</b>, <b>EMIR</b>, <b>AIFMD</b>, <b>CentralBank</b> (with a plus sign in a square), and <b>FundSquare</b>. Dashed lines connect the <b>InvestorTypes</b> element to each of these sub-elements. Below the <b>InvestorTypes</b> element, there is descriptive text: "Private, Institutional, Asset Manager, Banks, Pension Funds, Insurances, Treasury, Charities, ... (AIFMD "ID 208 - Investor Group Type")".</p> |
| type       | <a href="#">InvestorTypesType</a>   |
| properties | isRef 0<br>content complex  |
| children   | <a href="#">ECB</a> <a href="#">EMIR</a> <a href="#">AIFMD</a> <a href="#">CentralBank</a> <a href="#">FundSquare</a>   |
| annotation | documentation<br>Private, Institutional, Asset Manager, Banks, Pension Funds, Insurances, Treasury, Charities, ... (AIFMD "ID 208 - Investor Group Type")   |

element **AllocationType/NumberOfShares**

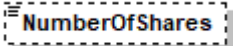
|            |   |
|------------|---|
| diagram    |  |
| type       | <b>xs:decimal</b>   |
| properties | isRef 0<br>minOcc 0<br>maxOcc 1<br>content simple                                   |

### complexType **DataPointType**

|          |  |
|----------|--|
| diagram  |  |
| children | <a href="#">Date</a> <a href="#">Value</a> <a href="#">TimeStamp</a> |
| used by  | element <a href="#">PerformanceType/DataSeries/DataPoint</a>         |

### element **DataPointType/Date**

|            |                           |
|------------|---------------------------|
| diagram    |                           |
| type       | <b>xs:date</b>            |
| properties | isRef 0<br>content simple |

### element **DataPointType/Value**

|            |                           |
|------------|---------------------------|
| diagram    |                           |
| type       | <b>xs:decimal</b>         |
| properties | isRef 0<br>content simple |

### element **DataPointType/TimeStamp**

|            |   |
|------------|---|
| diagram    |   |
| type       | <b>xs:time</b>                                    |
| properties | isRef 0<br>minOcc 0<br>maxOcc 1<br>content simple |

# complexType DistributionType

diagram

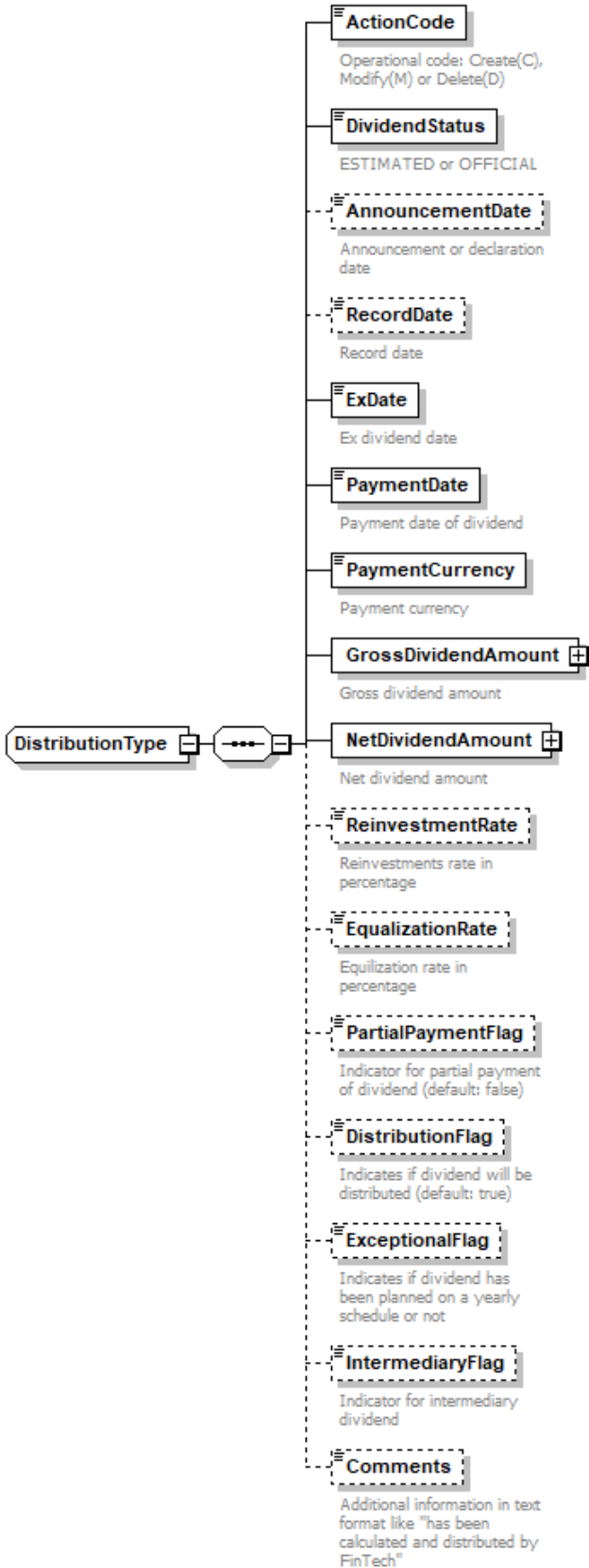



|          |  |
|----------|--|
| children | <a href="#">ActionCode</a> <a href="#">DividendStatus</a> <a href="#">AnnouncementDate</a> <a href="#">RecordDate</a> <a href="#">ExDate</a> <a href="#">PaymentDate</a> <a href="#">PaymentCurrency</a> <a href="#">GrossDividendAmount</a> <a href="#">NetDividendAmount</a> <a href="#">ReinvestmentRate</a> <a href="#">EqualizationRate</a> <a href="#">PartialPaymentFlag</a> <a href="#">DistributionFlag</a> <a href="#">ExceptionalFlag</a> <a href="#">IntermediaryFlag</a> <a href="#">Comments</a> |
| used by  | element <a href="#">ShareClassType/Distributions/Distribution</a>  |

#### element **DistributionType/ActionCode**

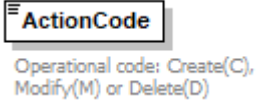
|            |   |
|------------|---|
| diagram    |  |
| type       | restriction of <b>xs:string</b>   |
| properties | isRef 0<br>content simple   |
| facets     | Kind Value annotation<br>length 1   |
| annotation | documentation<br>Operational code: Create(C), Modify(M) or Delete(D)              |

#### element **DistributionType/DividendStatus**

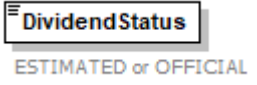
|            |   |
|------------|---|
| diagram    |  |
| type       | restriction of <b>xs:string</b>   |
| properties | isRef 0<br>content simple   |
| facets     | Kind Value annotation<br>minLength 8<br>maxLength 9                               |
| annotation | documentation<br>ESTIMATED or OFFICIAL  |

#### element **DistributionType/AnnouncementDate**

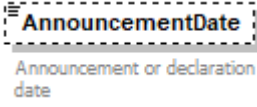
|            |   |
|------------|---|
| diagram    |  |
| type       | <b>xs:date</b>  |
| properties | isRef 0<br>minOcc 0<br>maxOcc 1<br>content simple                                   |
| annotation | documentation<br>Announcement or declaration date                                   |

element **DistributionType/RecordDate**

|            |   |
|------------|---|
| diagram    |  |
| type       | <b>xs:date</b>  |
| properties | isRef 0<br>minOcc 0<br>maxOcc 1<br>content simple                                 |
| annotation | documentation<br>Record date  |

element **DistributionType/ExDate**

|            |   |
|------------|---|
| diagram    |  |
| type       | <b>xs:date</b>  |
| properties | isRef 0<br>content simple   |
| annotation | documentation<br>Ex dividend date   |

element **DistributionType/PaymentDate**

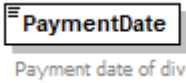
|            |   |
|------------|---|
| diagram    |  |
| type       | <b>xs:date</b>  |
| properties | isRef 0<br>content simple   |
| annotation | documentation<br>Payment date of dividend   |

element **DistributionType/PaymentCurrency**

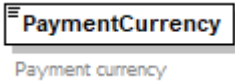
|            |   |
|------------|---|
| diagram    |  |
| type       | <a href="#">ISOCurrencyCodeType</a>   |
| properties | isRef 0<br>content simple   |
| facets     | Kind Value annotation<br>minLength 3<br>maxLength 3<br>pattern [A-Z]{3}             |
| annotation | documentation<br>Payment currency   |

element **DistributionType/GrossDividendAmount**

|            |  |
|------------|--|
| diagram    |  |
| properties | isRef 0<br>content complex                     |
| children   | <a href="#">Total</a> <a href="#">PerShare</a> |
| annotation | documentation<br>Gross dividend amount         |

element **DistributionType/GrossDividendAmount/Total**

|            |  |
|------------|--|
| diagram    |  |
| type       | <a href="#">PositiveAmountType</a>                 |
| properties | isRef 0<br>minOcc 0<br>maxOcc 1<br>content complex |
| children   | <a href="#">Amount</a>                             |
| annotation | documentation<br>Gross dividend amount total value |

element **DistributionType/GrossDividendAmount/PerShare**

|            |  |
|------------|--|
| diagram    |  |
| type       | <a href="#">PositiveAmountType</a>               |
| properties | isRef 0<br>content complex                       |
| children   | <a href="#">Amount</a>                           |
| annotation | documentation<br>Gross dividend amount per share |

element **DistributionType/NetDividendAmount**

|            |   |
|------------|---|
| diagram    | <p>The diagram shows the <b>NetDividendAmount</b> element (Net dividend amount) connected to a container element (represented by a rounded rectangle with three dots). This container is connected to two child elements: <b>Total</b> (Net dividend amount total value) and <b>PerShare</b> (Net dividend amount per share).</p> |
| properties | isRef 0<br>content complex  |
| children   | <a href="#">Total</a> <a href="#">PerShare</a>  |
| annotation | documentation<br>Net dividend amount  |

element **DistributionType/NetDividendAmount/Total**

|            |   |
|------------|---|
| diagram    | <p>The diagram shows the <b>Total</b> element (Net dividend amount total value) connected to a container element (rounded rectangle with three dots). This container is connected to the <b>Amount</b> element (Amounts in currency as defined in attribute - only positive values). The <b>Amount</b> element has a cardinality of 1..∞. The entire structure is enclosed in a dashed box labeled <b>PositiveAmountType</b>.</p> |
| type       | <a href="#">PositiveAmountType</a>  |
| properties | isRef 0<br>minOcc 0<br>maxOcc 1<br>content complex  |
| children   | <a href="#">Amount</a>  |
| annotation | documentation<br>Net dividend amount total value  |

element **DistributionType/NetDividendAmount/PerShare**

|            |  |
|------------|--|
| diagram    | <p>The diagram shows the <b>PerShare</b> element (Net dividend amount per share) connected to a container element (rounded rectangle with three dots). This container is connected to the <b>Amount</b> element (Amounts in currency as defined in attribute - only positive values). The <b>Amount</b> element has a cardinality of 1..∞. The entire structure is enclosed in a dashed box labeled <b>PositiveAmountType</b>.</p> |
| type       | <a href="#">PositiveAmountType</a>   |
| properties | isRef 0<br>content complex   |
| children   | <a href="#">Amount</a>   |
| annotation | documentation<br>Net dividend amount per share   |

element **DistributionType/ReinvestmentRate**

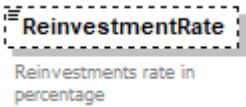
|            |   |
|------------|---|
| diagram    |  |
| type       | <a href="#">PercentageType</a>  |
| properties | isRef 0<br>minOcc 0<br>maxOcc 1<br>content simple                                 |
| annotation | documentation<br>Reinvestments rate in percentage                                 |

element **DistributionType/EqualizationRate**

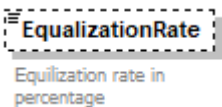
|            |   |
|------------|---|
| diagram    |  |
| type       | <a href="#">PercentageType</a>  |
| properties | isRef 0<br>minOcc 0<br>maxOcc 1<br>content simple                                 |
| annotation | documentation<br>Equalization rate in percentage                                  |

element **DistributionType/PartialPaymentFlag**

|            |   |
|------------|---|
| diagram    |  |
| type       | <b>xs:boolean</b>   |
| properties | isRef 0<br>minOcc 0<br>maxOcc 1<br>content simple                                   |
| annotation | documentation<br>Indicator for partial payment of dividend (default: false)         |

element **DistributionType/DistributionFlag**

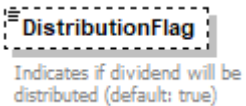
|            |   |
|------------|---|
| diagram    |  |
| type       | <b>xs:boolean</b>   |
| properties | isRef 0<br>minOcc 0<br>maxOcc 1<br>content simple                                   |

|            |  |
|------------|--|
| annotation | documentation<br>Indicates if dividend will be distributed (default: true) |
|------------|--|

element **DistributionType/ExceptionalFlag**

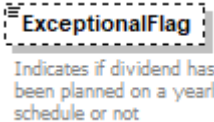
|            |   |
|------------|---|
| diagram    |  <p>Indicates if dividend has been planned on a yearly schedule or not</p> |
| type       | <b>xs:boolean</b>   |
| properties | isRef 0<br>minOcc 0<br>maxOcc 1<br>content simple   |
| annotation | documentation<br>Indicates if dividend has been planned on a yearly schedule or not   |

element **DistributionType/IntermediaryFlag**

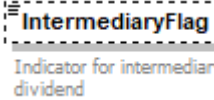
|            |  |
|------------|--|
| diagram    |  <p>Indicator for intermediary dividend</p> |
| type       | <b>xs:boolean</b>  |
| properties | isRef 0<br>minOcc 0<br>maxOcc 1<br>content simple  |
| annotation | documentation<br>Indicator for intermediary dividend   |

element **DistributionType/Comments**

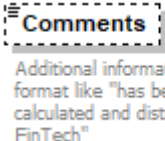
|            |  |
|------------|--|
| diagram    |  <p>Additional information in text format like "has been calculated and distributed by FinTech"</p> |
| type       | <a href="#">Text1000Type</a>   |
| properties | isRef 0<br>minOcc 0<br>maxOcc 1<br>content simple  |
| facets     | Kind Value annotation<br>maxLength 1000  |
| annotation | documentation<br>Additional information in text format like "has been calculated and distributed by FinTech"   |

### complexType **FeePeriodDataType**

|          |  |
|----------|--|
| diagram  |  |
| children | <a href="#">BeginDate</a> <a href="#">EndDate</a> <a href="#">CurrentDate</a> <a href="#">Values</a> <a href="#">CalculationData</a> |
| used by  | element <a href="#">ShareClassFeeType/DataByPeriods/DataByPeriod</a>   |

### element **FeePeriodDataType/BeginDate**

|            |                                       |
|------------|---------------------------------------|
| diagram    |                                       |
| type       | <b>xs:date</b>                        |
| properties | isRef 0<br>content simple             |
| annotation | documentation<br>Begin date of Period |

### element **FeePeriodDataType/EndDate**

|            |                                    |
|------------|------------------------------------|
| diagram    |                                    |
| type       | <b>xs:date</b>                     |
| properties | isRef 0<br>content simple          |
| annotation | documentation<br>EndDate of Period |

### element **FeePeriodDataType/CurrentDate**

|            |                     |
|------------|---------------------|
| diagram    |                     |
| type       | <b>xs:date</b>      |
| properties | isRef 0<br>minOcc 0 |

|            |  |
|------------|--|
|            | maxOcc 1<br>content simple   |
| annotation | documentation<br>For OngoingPeriod only.<br>Current Date (or last calculation date). |

element **FeePeriodDataType/Values**

|            |  |
|------------|--|
| diagram    | <p>The diagram shows a central 'Values' box connected to a dashed box containing four child elements: 'TNA', 'CalculationBasis', 'FeeAsPercentageOfTNA', and 'ActualFeeAmount'. Each child element has a descriptive text box below it:</p> <ul style="list-style-type: none"> <li><b>TNA</b>: Total net assets of Portfolio or Share class used as reference for fee.</li> <li><b>CalculationBasis</b>: Basis of fee calculation if different from TNA</li> <li><b>FeeAsPercentageOfTNA</b>: (No description provided)</li> <li><b>ActualFeeAmount</b>: Actual amount of current fee for Period (with Currency as attribute)</li> </ul> |
| properties | isRef 0<br>content complex   |
| children   | <a href="#">TNA</a> <a href="#">CalculationBasis</a> <a href="#">FeeAsPercentageOfTNA</a> <a href="#">ActualFeeAmount</a>  |

element **FeePeriodDataType/Values/TNA**

|            |  |
|------------|--|
| diagram    | <p>The diagram shows a 'TNA' box connected to a 'FundAmountType' box. The 'FundAmountType' box contains an 'Amount' box. The 'Amount' box has a multiplicity of '1..∞' and a description: 'Amounts in currency as defined in attribute'.</p> |
| type       | <a href="#">FundAmountType</a>   |
| properties | isRef 0<br>minOcc 0<br>maxOcc 1<br>content complex   |
| children   | <a href="#">Amount</a>   |
| annotation | documentation<br>Total net assets of Portfolio or Share class used as reference for fee.   |



element **FeePeriodDataType/Values/CalculationBasis**

|            |   |
|------------|---|
| diagram    | <p>The diagram shows the structure of the <b>CalculationBasis</b> element. It is a dashed box containing a solid box labeled <b>CalculationBasis</b> with the text "Basis of fee calculation if different from TNA". This box is connected to a central circle containing three dots. From this circle, three lines branch out to three separate boxes: <b>BasisType</b> (with text "Definition of the calculation basis (to which PercentageOfBasis applies)"), <b>BasisValue</b> (with text "Actual amount of Basis"), and <b>FeeAsPercentageOfBasis</b>.</p> |
| properties | <p>isRef 0<br/> minOcc 0<br/> maxOcc 1<br/> content complex</p>   |
| children   | <p><a href="#">BasisType</a> <a href="#">BasisValue</a> <a href="#">FeeAsPercentageOfBasis</a></p>  |
| annotation | <p>documentation<br/> Basis of fee calculation<br/> if different from TNA</p>   |

element **FeePeriodDataType/Values/CalculationBasis/BasisType**

|            |  |
|------------|--|
| diagram    | <p>The diagram shows the structure of the <b>BasisType</b> element. It is a solid box labeled <b>BasisType</b> with the text "Definition of the calculation basis (to which PercentageOfBasis applies)".</p> |
| type       | <p><b>xs:string</b></p>  |
| properties | <p>isRef 0<br/> content simple</p>   |
| annotation | <p>documentation<br/> Definition of the calculation basis<br/> (to which PercentageOfBasis applies).</p>   |

element **FeePeriodDataType/Values/CalculationBasis/BasisValue**

|            |  |
|------------|--|
| diagram    | <p>The diagram shows the structure of the <b>BasisValue</b> element. It is a solid box labeled <b>BasisValue</b> with the text "Actual amount of Basis". This box is connected to a central circle containing three dots. From this circle, a line branches out to a solid box labeled <b>Amount</b> with the text "Amounts in currency as defined in attribute" and "1..∞". The <b>Amount</b> box is enclosed in a dashed yellow box labeled <b>FundAmountType</b>.</p> |
| type       | <p><a href="#">FundAmountType</a></p>  |
| properties | <p>isRef 0<br/> content complex</p>  |
| children   | <p><a href="#">Amount</a></p>  |
| annotation | <p>documentation<br/> Actual amount of Basis</p>   |

element **FeePeriodDataType/Values/CalculationBasis/FeeAsPercentageOfBasis**

|            |                                |
|------------|--------------------------------|
| diagram    |                                |
| type       | <a href="#">PercentageType</a> |
| properties | isRef 0<br>content simple      |

element **FeePeriodDataType/Values/FeeAsPercentageOfTNA**

|            |                                |
|------------|--------------------------------|
| diagram    |                                |
| type       | <a href="#">PercentageType</a> |
| properties | isRef 0<br>content simple      |

element **FeePeriodDataType/Values/ActualFeeAmount**

|            |  |
|------------|--|
| diagram    |  |
| type       | <a href="#">FundAmountType</a>   |
| properties | isRef 0<br>minOcc 0<br>maxOcc 1<br>content complex                                       |
| children   | <a href="#">Amount</a>   |
| annotation | documentation<br>Actual amount of current fee for Period<br>(with Currency as attribute) |

element **FeePeriodDataType/CalculationData**

|            |  |
|------------|--|
| diagram    |  |
| properties | isRef 0<br>minOcc 0<br>maxOcc 1<br>content complex |
| children   | <a href="#">Variable</a>                           |

element **FeePeriodDataType/CalculationData/Variable**

|            |  |
|------------|--|
| diagram    | <p>Variable/Parameter used for Fee calculation</p>           |
| properties | isRef 0<br>minOcc 1<br>maxOcc unbounded<br>content complex   |
| children   | <a href="#">Name</a> <a href="#">Value</a>                   |
| annotation | documentation<br>Variable/Parameter used for Fee calculation |

element **FeePeriodDataType/CalculationData/Variable/Name**

|            |   |
|------------|---|
| diagram    | <p>Name of Variable</p>                           |
| type       | <b>xs:string</b>                                  |
| properties | isRef 0<br>minOcc 0<br>maxOcc 1<br>content simple |
| annotation | documentation<br>Name of Variable                 |

element **FeePeriodDataType/CalculationData/Variable/Value**

|            |                                     |
|------------|-------------------------------------|
| diagram    | <p>Value of Indicator</p>           |
| type       | <b>xs:decimal</b>                   |
| properties | isRef 0<br>content simple           |
| annotation | documentation<br>Value of Indicator |

complexType **FeesType**

|          |   |
|----------|---|
| diagram  | <p>Details of fee payed or received of fund</p> |
| children | <a href="#">Fee</a>                             |
| used by  | element <a href="#">ShareClassType/Fees</a>     |

element **FeesType/Fee**

|                   |  |
|-------------------|--|
| <p>diagram</p>    |  |
| <p>type</p>       | <p><a href="#">ShareClassFeeType</a></p>   |
| <p>properties</p> | <p>isRef 0<br/> minOcc 1<br/> maxOcc unbounded<br/> content complex</p>  |
| <p>children</p>   | <p><a href="#">Type</a> <a href="#">PayReceive</a> <a href="#">Minimum</a> <a href="#">Maximum</a> <a href="#">CalculationMethod</a> <a href="#">DataByPeriods</a></p> |
| <p>annotation</p> | <p>documentation<br/> Details of fee payed or received of fund</p>   |

# complexType FlowType

diagram

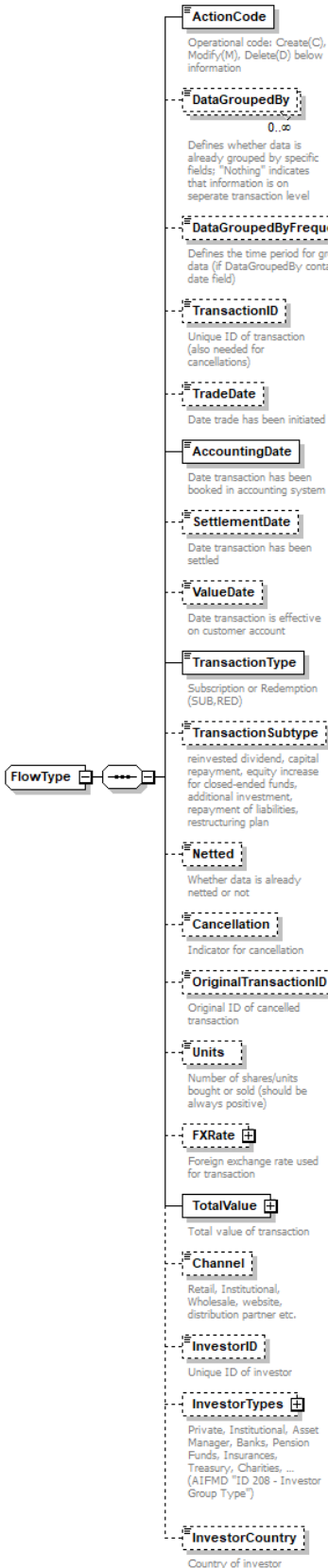

## ActionCode

Operational code: Create(C), Modify(M), Delete(D) below information

## DataGroupedBy

0..∞

Defines whether data is already grouped by specific fields. "Nothing" indicates that information is on separate transaction level

## DataGroupedByFrequency

Defines the time period for grouped data (if DataGroupedBy contains a date field)

## TransactionID

Unique ID of transaction (also needed for cancellations)

## TradeDate

Date trade has been initiated

## AccountingDate

Date transaction has been booked in accounting system

## SettlementDate

Date transaction has been settled

## ValueDate

Date transaction is effective on customer account

## TransactionType

Subscription or Redemption (SUB,RED)

## TransactionSubtype

reinvested dividend, capital repayment, equity increase for closed-ended funds, additional investment, repayment of liabilities, restructuring plan

## Netted

Whether data is already netted or not

## Cancellation

Indicator for cancellation

## OriginalTransactionID

Original ID of cancelled transaction

## Units

Number of shares/units bought or sold (should be always positive)

## FXRate

Foreign exchange rate used for transaction

## TotalValue

Total value of transaction

## Channel

Retail, Institutional, Wholesale, website, distribution partner etc.

## InvestorID

Unique ID of investor

## InvestorTypes

Private, Institutional, Asset Manager, Banks, Pension Funds, Insurances, Treasury, Charities, ... (AIFMD "ID 208 - Investor Group Type")

## InvestorCountry

Country of investor

|          |   |
|----------|---|
| children | <a href="#">ActionCode</a> <a href="#">DataGroupedBy</a> <a href="#">DataGroupedByFrequency</a> <a href="#">TransactionID</a> <a href="#">TradeDate</a> <a href="#">AccountingDate</a> <a href="#">SettlementDate</a> <a href="#">ValueDate</a> <a href="#">TransactionType</a> <a href="#">TransactionSubtype</a> <a href="#">Netted</a> <a href="#">Cancellation</a> <a href="#">OriginalTransactionID</a> <a href="#">Units</a> <a href="#">FXRate</a> <a href="#">TotalValue</a> <a href="#">Channel</a> <a href="#">InvestorID</a> <a href="#">InvestorTypes</a> <a href="#">InvestorCountry</a> |
| used by  | element <a href="#">ShareClassType/Flows/Flow</a>   |

#### element [FlowType/ActionCode](#)

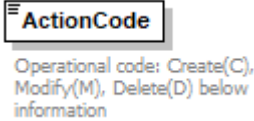
|            |  |
|------------|--|
| diagram    |     |
| type       | restriction of <b>xs:string</b>  |
| properties | isRef 0<br>content simple  |
| facets     | Kind Value annotation<br>length 1  |
| annotation | documentation<br>Operational code: Create(C), Modify(M), Delete(D) below information |

#### element [FlowType/DataGroupedBy](#)

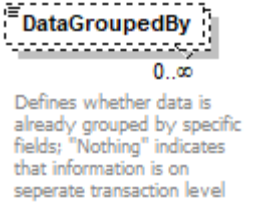
|            |  |
|------------|--|
| diagram    |    |
| type       | restriction of <b>xs:string</b>  |
| properties | isRef 0<br>minOcc 0<br>maxOcc unbounded<br>content simple  |
| annotation | documentation<br>Defines whether data is already grouped by specific fields; "Nothing" indicates that information is on separate transaction level |

#### element [FlowType/DataGroupedByFrequency](#)

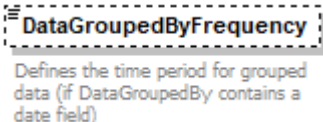
|            |  |
|------------|--|
| diagram    |                 |
| type       | <a href="#">FrequencyType</a>  |
| properties | isRef 0<br>minOcc 0<br>maxOcc 1<br>content simple  |
| annotation | documentation<br>Defines the time period for grouped data (if DataGroupedBy contains a date field) |

element **FlowType/TransactionID**

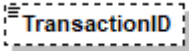
|            |   |
|------------|---|
| diagram    |  <p>Unique ID of transaction<br/>(also needed for cancellations)</p> |
| type       | <a href="#">Text256Type</a>   |
| properties | isRef 0<br>minOcc 0<br>maxOcc 1<br>content simple   |
| facets     | Kind Value annotation<br>maxLength 256  |
| annotation | documentation<br>Unique ID of transaction (also needed for cancellations)   |

element **FlowType/TradeDate**

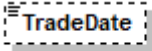
|            |  |
|------------|--|
| diagram    |  <p>Date trade has been initiated</p> |
| type       | <b>xs:date</b>   |
| properties | isRef 0<br>minOcc 0<br>maxOcc 1<br>content simple  |
| annotation | documentation<br>Date trade has been initiated   |

element **FlowType/AccountingDate**

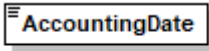
|            |  |
|------------|--|
| diagram    |  <p>Date transaction has been<br/>booked in accounting system</p> |
| type       | <b>xs:date</b>   |
| properties | isRef 0<br>content simple  |
| annotation | documentation<br>Date transaction has been booked in accounting system   |

element **FlowType/SettlementDate**

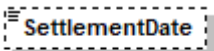
|            |  |
|------------|--|
| diagram    |  <p>Date transaction has been<br/>settled</p> |
| type       | <b>xs:date</b>   |
| properties | isRef 0<br>minOcc 0<br>maxOcc 1<br>content simple  |
| annotation | documentation<br>Date transaction has been settled   |

element **FlowType/ValueDate**

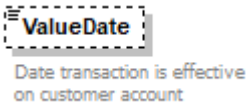
|            |   |
|------------|---|
| diagram    |  |
| type       | <b>xs:date</b>  |
| properties | isRef 0<br>minOcc 0<br>maxOcc 1<br>content simple                                 |
| annotation | documentation<br>Date transaction is effective on customer account                |

element **FlowType/TransactionType**

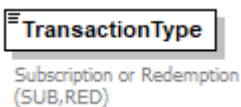
|            |   |
|------------|---|
| diagram    |  |
| type       | restriction of <b>xs:string</b>   |
| properties | isRef 0<br>content simple   |
| facets     | Kind Value annotation<br>length 3<br>pattern SUB<br>pattern RED                   |
| annotation | documentation<br>Subscription or Redemption (SUB,RED)                             |

element **FlowType/TransactionSubtype**

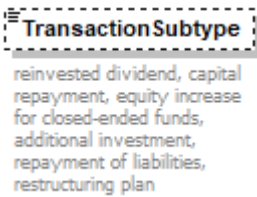
|            |  |
|------------|--|
| diagram    |   |
| type       | <b>xs:string</b>   |
| properties | isRef 0<br>minOcc 0<br>maxOcc 1<br>content simple  |
| annotation | documentation<br>reinvested dividend, capital repayment, equity increase for closed-ended funds, additional investment, repayment of liabilities, restructuring plan |



element **FlowType/Netted**

|            |  |
|------------|--|
| diagram    |  <p>Whether data is already netted or not</p> |
| type       | <b>xs:boolean</b>  |
| properties | isRef 0<br>minOcc 0<br>maxOcc 1<br>content simple  |
| annotation | documentation<br>Whether data is already netted or not   |

element **FlowType/Cancellation**

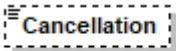
|            |   |
|------------|---|
| diagram    |  <p>Indicator for cancellation</p> |
| type       | <b>xs:boolean</b>   |
| properties | isRef 0<br>minOcc 0<br>maxOcc 1<br>content simple   |
| annotation | documentation<br>Indicator for cancellation   |

element **FlowType/OriginalTransactionID**

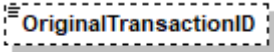
|            |  |            |       |            |           |     |  |
|------------|--|------------|-------|------------|-----------|-----|--|
| diagram    |  <p>Original ID of cancelled transaction</p>              |            |       |            |           |     |  |
| type       | <a href="#">Text256Type</a>  |            |       |            |           |     |  |
| properties | isRef 0<br>minOcc 0<br>maxOcc 1<br>content simple  |            |       |            |           |     |  |
| facets     | <table border="0"> <tr> <td>Kind</td> <td>Value</td> <td>annotation</td> </tr> <tr> <td>maxLength</td> <td>256</td> <td></td> </tr> </table> | Kind       | Value | annotation | maxLength | 256 |  |
| Kind       | Value  | annotation |       |            |           |     |  |
| maxLength  | 256  |            |       |            |           |     |  |
| annotation | documentation<br>Original ID of cancelled transaction  |            |       |            |           |     |  |

element **FlowType/Units**

|            |  |
|------------|--|
| diagram    |  <p>Number of shares/units bought or sold (should be always positive)</p> |
| type       | <b>xs:decimal</b>  |
| properties | isRef 0<br>minOcc 0<br>maxOcc 1<br>content simple  |

|            |  |
|------------|--|
| annotation | documentation<br>Number of shares/units bought or sold (should be always positive) |
|------------|--|

### element FlowType/FXRate

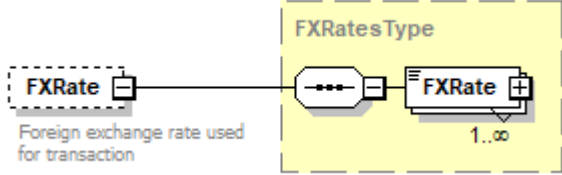
|            |   |
|------------|---|
| diagram    |  |
| type       | <a href="#">FXRatesType</a>   |
| properties | isRef 0<br>minOcc 0<br>maxOcc 1<br>content complex                                |
| children   | <a href="#">FXRate</a>  |
| annotation | documentation<br>Foreign exchange rate used for transaction                       |

### element FlowType/TotalValue

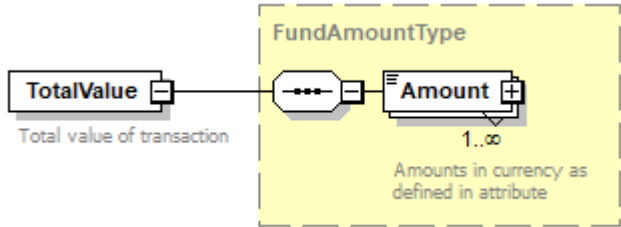
|            |  |
|------------|--|
| diagram    |  |
| type       | <a href="#">FundAmountType</a>   |
| properties | isRef 0<br>content complex   |
| children   | <a href="#">Amount</a>   |
| annotation | documentation<br>Total value of transaction  |

### element FlowType/Channel

|            |   |
|------------|---|
| diagram    |    |
| type       | <a href="#">Text256Type</a>   |
| properties | isRef 0<br>minOcc 0<br>maxOcc 1<br>content simple                                     |
| facets     | Kind Value annotation<br>maxLength 256  |
| annotation | documentation<br>Retail, Institutional, Wholesale, website, distribution partner etc. |

element **FlowType/InvestorID**

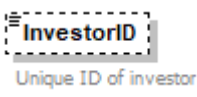
|            |   |
|------------|---|
| diagram    |  |
| type       | <a href="#">Text256Type</a>   |
| properties | isRef 0<br>minOcc 0<br>maxOcc 1<br>content simple                                 |
| facets     | Kind Value annotation<br>maxLength 256  |
| annotation | documentation<br>Unique ID of investor  |

element **FlowType/InvestorTypes**

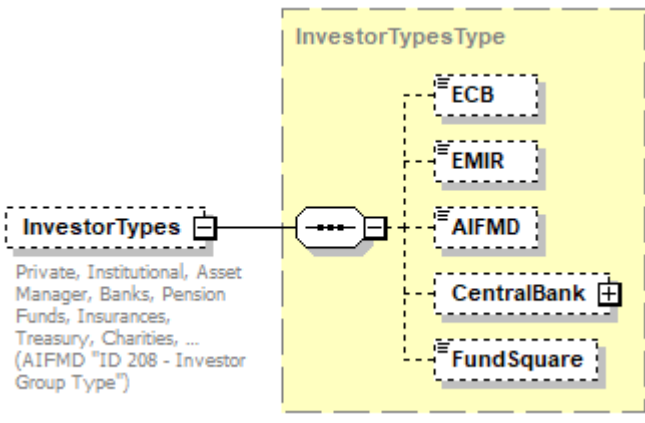
|            |   |
|------------|---|
| diagram    |   |
| type       | <a href="#">InvestorTypesType</a>   |
| properties | isRef 0<br>minOcc 0<br>maxOcc 1<br>content complex  |
| children   | <a href="#">ECB</a> <a href="#">EMIR</a> <a href="#">AIFMD</a> <a href="#">CentralBank</a> <a href="#">FundSquare</a>                                     |
| annotation | documentation<br>Private, Institutional, Asset Manager, Banks, Pension Funds, Insurances, Treasury, Charities, ... (AIFMD "ID 208 - Investor Group Type") |

element **FlowType/InvestorCountry**

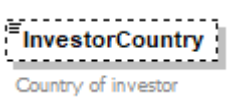
|            |   |
|------------|---|
| diagram    |  |
| type       | <a href="#">ISOCountryCodeType</a>  |
| properties | isRef 0<br>minOcc 0<br>maxOcc 1<br>content simple                                   |

|            |   |
|------------|---|
| facets     | Kind Value annotation<br>minLength 2<br>maxLength 2 |
| annotation | documentation<br>Country of investor                |

### complexType HighWatermarkType

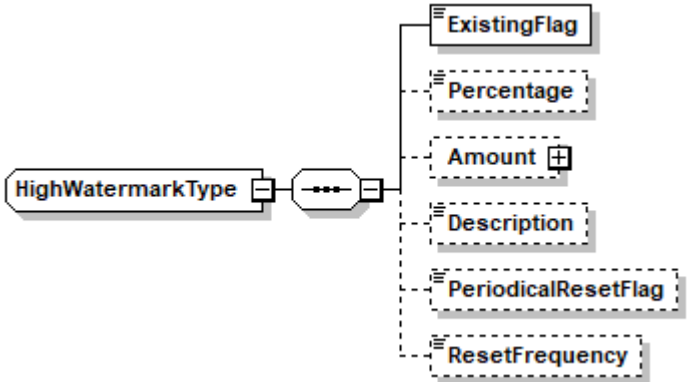
|          |   |
|----------|---|
| diagram  |    |
| children | <a href="#">ExistingFlag</a> <a href="#">Percentage</a> <a href="#">Amount</a> <a href="#">Description</a> <a href="#">PeriodicalResetFlag</a> <a href="#">ResetFrequency</a> |
| used by  | element <a href="#">ShareClassType/HighWatermark</a>  |

### element HighWatermarkType/ExistingFlag

|            |   |
|------------|---|
| diagram    |  |
| type       | xs:boolean  |
| properties | isRef 0<br>content simple   |

### element HighWatermarkType/Percentage

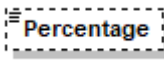
|            |   |
|------------|---|
| diagram    |  |
| type       | <a href="#">PercentageType</a>  |
| properties | isRef 0<br>minOcc 0<br>maxOcc 1<br>content simple                                   |

element **HighWatermarkType/Amount**

|            |  |
|------------|--|
| diagram    |  |
| type       | <a href="#">FundAmountType</a>                     |
| properties | isRef 0<br>minOcc 0<br>maxOcc 1<br>content complex |
| children   | <a href="#">Amount</a>                             |

element **HighWatermarkType/Description**

| diagram    |   |            |       |            |           |      |  |
|------------|---|------------|-------|------------|-----------|------|--|
| type       | <a href="#">Text1000Type</a>  |            |       |            |           |      |  |
| properties | isRef 0<br>minOcc 0<br>maxOcc 1<br>content simple   |            |       |            |           |      |  |
| facets     | <table border="1"> <thead> <tr> <th>Kind</th> <th>Value</th> <th>annotation</th> </tr> </thead> <tbody> <tr> <td>maxLength</td> <td>1000</td> <td></td> </tr> </tbody> </table> | Kind       | Value | annotation | maxLength | 1000 |  |
| Kind       | Value   | annotation |       |            |           |      |  |
| maxLength  | 1000  |            |       |            |           |      |  |

element **HighWatermarkType/PeriodicalResetFlag**

|            |   |
|------------|---|
| diagram    |   |
| type       | <b>xs:boolean</b>                                 |
| properties | isRef 0<br>minOcc 0<br>maxOcc 1<br>content simple |

element **HighWatermarkType/ResetFrequency**

|            |   |
|------------|---|
| diagram    |   |
| type       | <a href="#">FrequencyType</a>                     |
| properties | isRef 0<br>minOcc 0<br>maxOcc 1<br>content simple |

### complexType InvestorType

|          |   |
|----------|---|
| diagram  |   |
| children | <a href="#">Date</a> <a href="#">InvestorID</a> <a href="#">InvestorName</a> <a href="#">InvestorCountry</a> <a href="#">InvestorTypes</a> <a href="#">NumberOfShares</a> |
| used by  | element <a href="#">ShareClassType/Investors/Investor</a>   |

### element InvestorType/Date

|            |   |
|------------|---|
| diagram    |   |
| type       | <b>xs:date</b>                                    |
| properties | isRef 0<br>minOcc 0<br>maxOcc 1<br>content simple |

### element InvestorType/InvestorID

|            |   |
|------------|---|
| diagram    |   |
| type       | <a href="#">Text256Type</a>                       |
| properties | isRef 0<br>minOcc 0<br>maxOcc 1<br>content simple |
| facets     | Kind Value annotation<br>maxLength 256            |

### element InvestorType/InvestorName

|         |                             |
|---------|-----------------------------|
| diagram |                             |
| type    | <a href="#">Text500Type</a> |

|            |   |
|------------|---|
| properties | isRef 0<br>minOcc 0<br>maxOcc 1<br>content simple |
| facets     | Kind Value annotation<br>maxLength 500            |

element **InvestorType/InvestorCountry**

|            |   |
|------------|---|
| diagram    |   |
| type       | <a href="#">ISOCountryCodeType</a>                  |
| properties | isRef 0<br>minOcc 0<br>maxOcc 1<br>content simple   |
| facets     | Kind Value annotation<br>minLength 2<br>maxLength 2 |

element **InvestorType/InvestorTypes**

|            |   |
|------------|---|
| diagram    |   |
| type       | <a href="#">InvestorTypesType</a>   |
| properties | isRef 0<br>minOcc 0<br>maxOcc 1<br>content complex  |
| children   | <a href="#">ECB</a> <a href="#">EMIR</a> <a href="#">AIFMD</a> <a href="#">CentralBank</a> <a href="#">FundSquare</a>                                     |
| annotation | documentation<br>Private, Institutional, Asset Manager, Banks, Pension Funds, Insurances, Treasury, Charities, ... (AIFMD "ID 208 - Investor Group Type") |

element **InvestorType/NumberOfShares**

|         |                   |
|---------|-------------------|
| diagram |                   |
| type    | <b>xs:decimal</b> |

|            |   |
|------------|---|
| properties | isRef 0<br>minOcc 0<br>maxOcc 1<br>content simple |
|------------|---|

### complexType InvestorTypesType

|          |   |
|----------|---|
| diagram  |   |
| children | <a href="#">ECB</a> <a href="#">EMIR</a> <a href="#">AIFMD</a> <a href="#">CentralBank</a> <a href="#">FundSquare</a>                   |
| used by  | elements <a href="#">FlowType/InvestorTypes</a> <a href="#">InvestorType/InvestorTypes</a> <a href="#">AllocationType/InvestorTypes</a> |

### element InvestorTypesType/ECB

|            |   |
|------------|---|
| diagram    |   |
| type       | restriction of <b>xs:string</b>                   |
| properties | isRef 0<br>minOcc 0<br>maxOcc 1<br>content simple |

### element InvestorTypesType/EMIR

|            |   |
|------------|---|
| diagram    |   |
| type       | restriction of <b>xs:string</b>                   |
| properties | isRef 0<br>minOcc 0<br>maxOcc 1<br>content simple |
| facets     | Kind Value annotation<br>length 1                 |

### element InvestorTypesType/AIFMD

|            |                                 |
|------------|---------------------------------|
| diagram    |                                 |
| type       | restriction of <b>xs:string</b> |
| properties | isRef 0<br>minOcc 0<br>maxOcc 1 |



|        |                                   |
|--------|-----------------------------------|
|        | content simple                    |
| facets | Kind Value annotation<br>length 4 |

**element InvestorTypesType/CentralBank**

|            |  |
|------------|--|
| diagram    |  |
| properties | isRef 0<br>minOcc 0<br>maxOcc 1<br>content complex                           |
| children   | <a href="#">Country</a> <a href="#">ForeignFlag</a> <a href="#">Category</a> |

**element InvestorTypesType/CentralBank/Country**

|            |   |
|------------|---|
| diagram    |   |
| type       | <a href="#">ISOCountryCodeType</a>                  |
| properties | isRef 0<br>content simple                           |
| facets     | Kind Value annotation<br>minLength 2<br>maxLength 2 |

**element InvestorTypesType/CentralBank/ForeignFlag**

|            |                           |
|------------|---------------------------|
| diagram    |                           |
| type       | <b>xs:boolean</b>         |
| properties | isRef 0<br>content simple |

**element InvestorTypesType/CentralBank/Category**

|            |   |
|------------|---|
| diagram    |   |
| type       | restriction of <b>xs:string</b>                     |
| properties | isRef 0<br>content simple                           |
| facets     | Kind Value annotation<br>minLength 2<br>maxLength 3 |

element **InvestorTypesType/FundSquare**

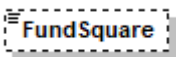
|            |  |       |   |        |   |        |   |         |        |
|------------|--|-------|---|--------|---|--------|---|---------|--------|
| diagram    |   |       |   |        |   |        |   |         |        |
| type       | restriction of <b>xs:string</b>  |       |   |        |   |        |   |         |        |
| properties | <table border="0"> <tr><td>isRef</td><td>0</td></tr> <tr><td>minOcc</td><td>0</td></tr> <tr><td>maxOcc</td><td>1</td></tr> <tr><td>content</td><td>simple</td></tr> </table> | isRef | 0 | minOcc | 0 | maxOcc | 1 | content | simple |
| isRef      | 0  |       |   |        |   |        |   |         |        |
| minOcc     | 0  |       |   |        |   |        |   |         |        |
| maxOcc     | 1  |       |   |        |   |        |   |         |        |
| content    | simple   |       |   |        |   |        |   |         |        |

complexType **PerformanceFiguresType**

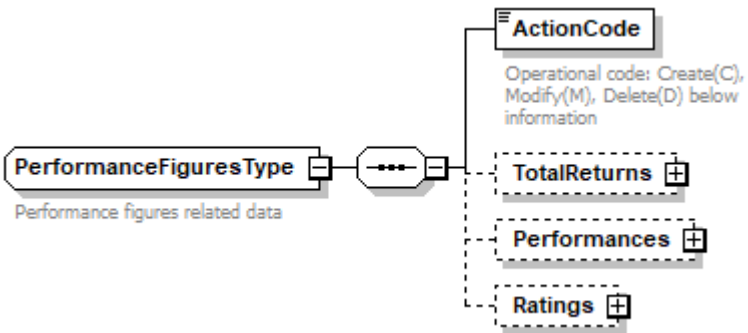
|            |  |
|------------|--|
| diagram    |                            |
| children   | <a href="#">ActionCode</a> <a href="#">TotalReturns</a> <a href="#">Performances</a> <a href="#">Ratings</a> |
| used by    | element <a href="#">ShareClassType/PerformanceFigures</a>  |
| annotation | documentation<br>Performance figures related data  |

element **PerformanceFiguresType/ActionCode**

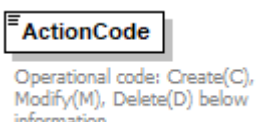
|            |  |       |   |         |        |
|------------|--|-------|---|---------|--------|
| diagram    |                     |       |   |         |        |
| type       | restriction of <b>xs:string</b>  |       |   |         |        |
| properties | <table border="0"> <tr><td>isRef</td><td>0</td></tr> <tr><td>content</td><td>simple</td></tr> </table> | isRef | 0 | content | simple |
| isRef      | 0  |       |   |         |        |
| content    | simple   |       |   |         |        |
| annotation | documentation<br>Operational code: Create(C), Modify(M), Delete(D) below information                   |       |   |         |        |

element **PerformanceFiguresType/TotalReturns**

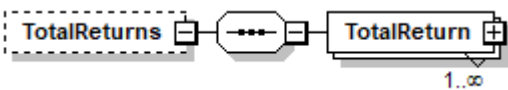
|            |   |       |   |        |   |        |   |         |         |
|------------|---|-------|---|--------|---|--------|---|---------|---------|
| diagram    |    |       |   |        |   |        |   |         |         |
| properties | <table border="0"> <tr><td>isRef</td><td>0</td></tr> <tr><td>minOcc</td><td>0</td></tr> <tr><td>maxOcc</td><td>1</td></tr> <tr><td>content</td><td>complex</td></tr> </table> | isRef | 0 | minOcc | 0 | maxOcc | 1 | content | complex |
| isRef      | 0   |       |   |        |   |        |   |         |         |
| minOcc     | 0   |       |   |        |   |        |   |         |         |
| maxOcc     | 1   |       |   |        |   |        |   |         |         |
| content    | complex   |       |   |        |   |        |   |         |         |
| children   | <a href="#">TotalReturn</a>   |       |   |        |   |        |   |         |         |

element **PerformanceFiguresType/TotalReturns/TotalReturn**

|                   |   |
|-------------------|---|
| <p>diagram</p>    |   |
| <p>type</p>       | <p><a href="#">TotalReturnType</a></p>  |
| <p>properties</p> | <p>isRef 0<br/>minOcc 1<br/>maxOcc unbounded<br/>content complex</p>  |
| <p>children</p>   | <p><a href="#">Currency</a> <a href="#">Value</a> <a href="#">ValidityDate</a> <a href="#">CalculationPeriod</a> <a href="#">AnnualizedFlag</a> <a href="#">CalculationMethod</a> <a href="#">Investment</a> <a href="#">StartCalculationDate</a> <a href="#">CorrectionCoefficient</a> <a href="#">ReinvestmentCoefficient</a></p> |

element **PerformanceFiguresType/Performances**

|                   |  |
|-------------------|--|
| <p>diagram</p>    |  |
| <p>properties</p> | <p>isRef 0<br/>minOcc 0<br/>maxOcc 1<br/>content complex</p> |
| <p>children</p>   | <p><a href="#">Performance</a></p>                           |

element **PerformanceFiguresType/Performances/Performance**

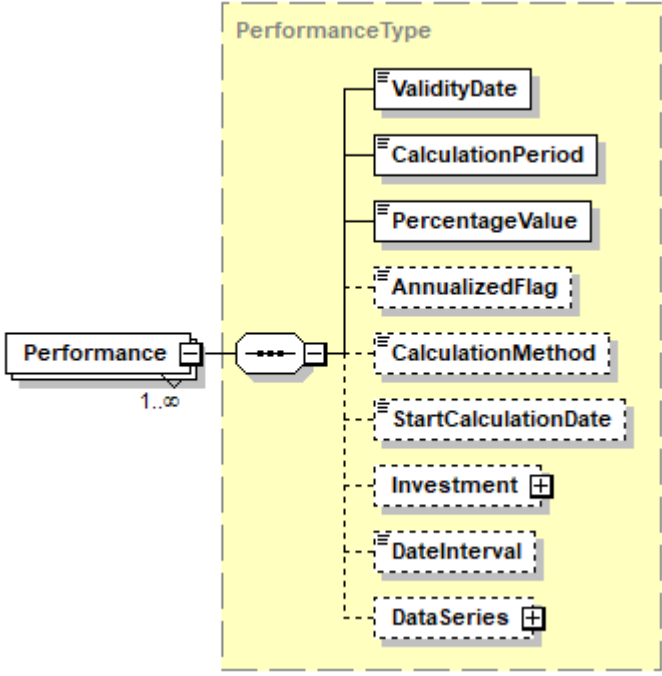
|                   |   |
|-------------------|---|
| <p>diagram</p>    |  <p>The diagram shows a 'Performance' element connected to a 'PerformanceType' container. The 'Performance' element has a cardinality of 1..∞. The 'PerformanceType' container is highlighted in yellow and contains the following elements: 'ValidityDate', 'CalculationPeriod', 'PercentageValue', 'AnnualizedFlag', 'CalculationMethod', 'StartCalculationDate', 'Investment', 'DateInterval', and 'DataSeries'. The elements 'AnnualizedFlag', 'CalculationMethod', 'StartCalculationDate', 'Investment', 'DateInterval', and 'DataSeries' are shown with dashed borders, indicating they are optional or complex content.</p> |
| <p>type</p>       | <p><a href="#">PerformanceType</a></p>  |
| <p>properties</p> | <p>isRef 0<br/> minOcc 1<br/> maxOcc unbounded<br/> content complex</p>   |
| <p>children</p>   | <p><a href="#">ValidityDate</a> <a href="#">CalculationPeriod</a> <a href="#">PercentageValue</a> <a href="#">AnnualizedFlag</a> <a href="#">CalculationMethod</a> <a href="#">StartCalculationDate</a><br/> <a href="#">Investment</a> <a href="#">DateInterval</a> <a href="#">DataSeries</a></p>   |

element **PerformanceFiguresType/Ratings**

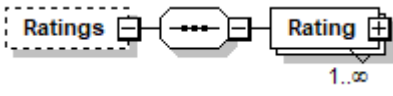
|                   |   |
|-------------------|---|
| <p>diagram</p>    |  <p>The diagram shows a 'Ratings' element connected to a 'Rating' element. The 'Ratings' element is shown with a dashed border, indicating it is optional. The 'Rating' element has a cardinality of 1..∞.</p> |
| <p>properties</p> | <p>isRef 0<br/> minOcc 0<br/> maxOcc 1<br/> content complex</p>   |
| <p>children</p>   | <p><a href="#">Rating</a></p>   |

element **PerformanceFiguresType/Ratings/Rating**

|                   |  |
|-------------------|--|
| <p>diagram</p>    |  |
| <p>type</p>       | <p><a href="#">RatingType</a></p>  |
| <p>properties</p> | <p>isRef 0<br/> minOcc 1<br/> maxOcc unbounded<br/> content complex</p>  |
| <p>children</p>   | <p><a href="#">Note</a> <a href="#">NumericalValue</a> <a href="#">ValidityStartDate</a> <a href="#">ValidityEndDate</a> <a href="#">ValidityEndRationale</a> <a href="#">ListedAgency</a> <a href="#">UnlistedAgency</a> <a href="#">Descriptions</a></p> |

complexType **PerformanceType**

|                 |  |
|-----------------|--|
| <p>diagram</p>  |  |
| <p>children</p> | <p><a href="#">ValidityDate</a> <a href="#">CalculationPeriod</a> <a href="#">PercentageValue</a> <a href="#">AnnualizedFlag</a> <a href="#">CalculationMethod</a> <a href="#">StartCalculationDate</a> <a href="#">Investment</a> <a href="#">DateInterval</a> <a href="#">DataSeries</a></p> |

|         |   |
|---------|---|
| used by | element <a href="#">PerformanceFiguresType/Performances/Performance</a> |
|---------|---|

element **PerformanceType/ValidityDate**

|            |   |
|------------|---|
| diagram    |  |
| type       | <b>xs:date</b>  |
| properties | isRef 0<br>content simple   |

element **PerformanceType/CalculationPeriod**

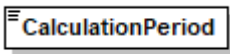
|            |   |
|------------|---|
| diagram    |  |
| type       | <a href="#">CalculationPeriodType</a>   |
| properties | isRef 0<br>content simple   |

element **PerformanceType/PercentageValue**

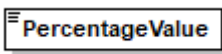
|            |   |
|------------|---|
| diagram    |  |
| type       | <a href="#">PercentageType</a>  |
| properties | isRef 0<br>content simple   |

element **PerformanceType/AnnualizedFlag**

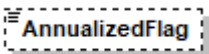
|            |   |
|------------|---|
| diagram    |  |
| type       | <b>xs:boolean</b>   |
| properties | isRef 0<br>minOcc 0<br>maxOcc 1<br>content simple<br>default 0                      |

element **PerformanceType/CalculationMethod**

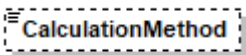
|            |   |
|------------|---|
| diagram    |  |
| type       | <b>xs:string</b>  |
| properties | isRef 0<br>minOcc 0<br>maxOcc 1<br>content simple                                   |

element **PerformanceType/StartCalculationDate**

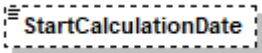
|            |  |       |   |        |   |        |   |         |        |
|------------|--|-------|---|--------|---|--------|---|---------|--------|
| diagram    |   |       |   |        |   |        |   |         |        |
| type       | <b>xs:date</b>   |       |   |        |   |        |   |         |        |
| properties | <table border="0"> <tr><td>isRef</td><td>0</td></tr> <tr><td>minOcc</td><td>0</td></tr> <tr><td>maxOcc</td><td>1</td></tr> <tr><td>content</td><td>simple</td></tr> </table> | isRef | 0 | minOcc | 0 | maxOcc | 1 | content | simple |
| isRef      | 0  |       |   |        |   |        |   |         |        |
| minOcc     | 0  |       |   |        |   |        |   |         |        |
| maxOcc     | 1  |       |   |        |   |        |   |         |        |
| content    | simple   |       |   |        |   |        |   |         |        |

element **PerformanceType/Investment**

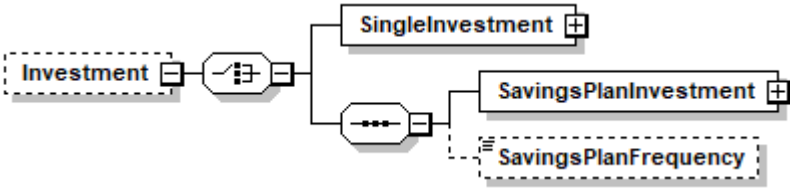
|            |   |       |   |        |   |        |   |         |         |
|------------|---|-------|---|--------|---|--------|---|---------|---------|
| diagram    |   |       |   |        |   |        |   |         |         |
| properties | <table border="0"> <tr><td>isRef</td><td>0</td></tr> <tr><td>minOcc</td><td>0</td></tr> <tr><td>maxOcc</td><td>1</td></tr> <tr><td>content</td><td>complex</td></tr> </table> | isRef | 0 | minOcc | 0 | maxOcc | 1 | content | complex |
| isRef      | 0   |       |   |        |   |        |   |         |         |
| minOcc     | 0   |       |   |        |   |        |   |         |         |
| maxOcc     | 1   |       |   |        |   |        |   |         |         |
| content    | complex   |       |   |        |   |        |   |         |         |
| children   | <a href="#">SingleInvestment</a> <a href="#">SavingsPlanInvestment</a> <a href="#">SavingsPlanFrequency</a>   |       |   |        |   |        |   |         |         |

element **PerformanceType/Investment/SingleInvestment**

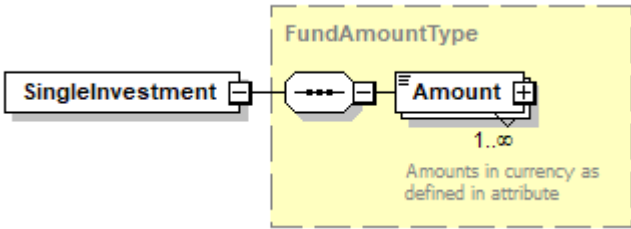
|            |   |       |   |         |         |
|------------|---|-------|---|---------|---------|
| diagram    |                      |       |   |         |         |
| type       | <a href="#">FundAmountType</a>  |       |   |         |         |
| properties | <table border="0"> <tr><td>isRef</td><td>0</td></tr> <tr><td>content</td><td>complex</td></tr> </table> | isRef | 0 | content | complex |
| isRef      | 0   |       |   |         |         |
| content    | complex   |       |   |         |         |
| children   | <a href="#">Amount</a>  |       |   |         |         |

element **PerformanceType/Investment/SavingsPlanInvestment**

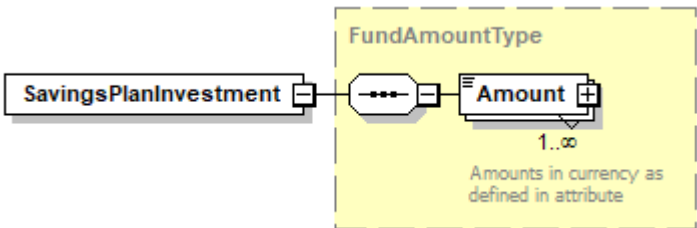
|            |   |       |   |         |         |
|------------|---|-------|---|---------|---------|
| diagram    |                      |       |   |         |         |
| type       | <a href="#">FundAmountType</a>  |       |   |         |         |
| properties | <table border="0"> <tr><td>isRef</td><td>0</td></tr> <tr><td>content</td><td>complex</td></tr> </table> | isRef | 0 | content | complex |
| isRef      | 0   |       |   |         |         |
| content    | complex   |       |   |         |         |

|          |                        |
|----------|------------------------|
| children | <a href="#">Amount</a> |
|----------|------------------------|

element **PerformanceType/Investment/SavingsPlanFrequency**

|            |   |
|------------|---|
| diagram    |  |
| type       | <a href="#">FrequencyType</a>   |
| properties | isRef 0<br>minOcc 0<br>maxOcc 1<br>content simple                                 |

element **PerformanceType/DateInterval**

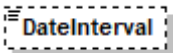
|            |   |
|------------|---|
| diagram    |  |
| type       | <a href="#">DateIntervalType</a>  |
| properties | isRef 0<br>minOcc 0<br>maxOcc 1<br>content simple                                 |

element **PerformanceType/DataSeries**

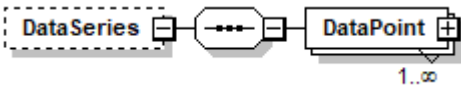
|            |   |
|------------|---|
| diagram    |  |
| properties | isRef 0<br>minOcc 0<br>maxOcc 1<br>content complex                                  |
| children   | <a href="#">DataPoint</a>   |

element **PerformanceType/DataSeries/DataPoint**

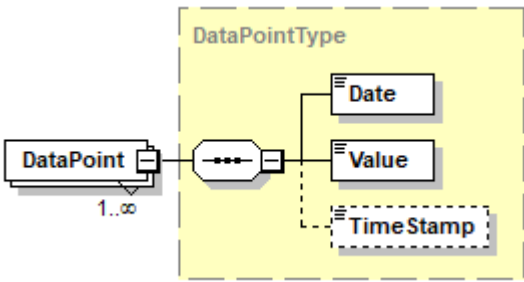
|            |   |
|------------|---|
| diagram    |  |
| type       | <a href="#">DataPointType</a>   |
| properties | isRef 0<br>minOcc 1<br>maxOcc unbounded<br>content complex                          |
| children   | <a href="#">Date</a> <a href="#">Value</a> <a href="#">Time Stamp</a>               |



### complexType RatingType

|          |   |
|----------|---|
| diagram  |   |
| children | <a href="#">Note</a> <a href="#">NumericalValue</a> <a href="#">ValidityStartDate</a> <a href="#">ValidityEndDate</a> <a href="#">ValidityEndRationale</a> <a href="#">ListedAgency</a> <a href="#">UnlistedAgency</a> <a href="#">Descriptions</a> |
| used by  | element <a href="#">PerformanceFiguresType/Ratings/Rating</a>   |

### element RatingType/Note

|            |  |
|------------|--|
| diagram    |  |
| type       | <a href="#">Text256Type</a>            |
| properties | isRef 0<br>content simple              |
| facets     | Kind Value annotation<br>maxLength 256 |

### element RatingType/NumericalValue

|            |   |
|------------|---|
| diagram    |   |
| type       | <b>xs:decimal</b>                                 |
| properties | isRef 0<br>minOcc 0<br>maxOcc 1<br>content simple |

### element RatingType/ValidityStartDate

|         |                |
|---------|----------------|
| diagram |                |
| type    | <b>xs:date</b> |

|            |                           |
|------------|---------------------------|
| properties | isRef 0<br>content simple |
|------------|---------------------------|

element **RatingType/ValidityEndDate**

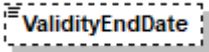
|            |   |
|------------|---|
| diagram    |  |
| type       | <b>xs:date</b>  |
| properties | isRef 0<br>minOcc 0<br>maxOcc 1<br>content simple                                 |

element **RatingType/ValidityEndRationale**

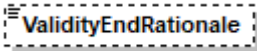
|            |   |
|------------|---|
| diagram    |  |
| type       | <b>xs:string</b>  |
| properties | isRef 0<br>minOcc 0<br>maxOcc 1<br>content simple                                 |

element **RatingType/ListedAgency**

|            |   |
|------------|---|
| diagram    |  |
| type       | restriction of <b>xs:string</b>   |
| properties | isRef 0<br>content simple   |

element **RatingType/UnlistedAgency**

|                   |   |
|-------------------|---|
| <p>diagram</p>    | <p>The diagram illustrates the structure of the <b>UnlistedAgency</b> element. It is connected to a complex content container (represented by a circle with four dots). This container is linked to a <b>CompanyType</b> structure, which is highlighted in a yellow dashed box. The <b>CompanyType</b> structure includes the following elements:</p> <ul style="list-style-type: none"> <li><b>Identifiers</b>: Identifiers of company</li> <li><b>Name</b>: Name of company</li> <li><b>LegalName</b>: Legal (full) name of company</li> <li><b>LegalForm</b>: Legal form of company</li> <li><b>Address</b>: Address of company</li> <li><b>BusinessCountry</b>: Country code of main business of company</li> <li><b>ParentCompany</b>: Parent company (if applicable)</li> <li><b>OtherClassification</b>: All other identifiers (with listed or free type), with a cardinality of 0..∞.</li> </ul> |
| <p>type</p>       | <p><a href="#">CompanyType</a></p>  |
| <p>properties</p> | <p>isRef 0<br/>content complex</p>  |
| <p>children</p>   | <p><a href="#">Identifiers</a> <a href="#">Name</a> <a href="#">LegalName</a> <a href="#">LegalForm</a> <a href="#">Address</a> <a href="#">BusinessCountry</a> <a href="#">ParentCompany</a> <a href="#">OtherClassification</a></p>   |

element **RatingType/Descriptions**

|                   |  |
|-------------------|--|
| <p>diagram</p>    | <p>The diagram illustrates the structure of the <b>Descriptions</b> element. It is connected to a complex content container (represented by a circle with four dots), which is linked to a <b>Description</b> element. The cardinality for the <b>Description</b> element is 1..∞.</p> |
| <p>properties</p> | <p>isRef 0<br/>minOcc 0<br/>maxOcc 1<br/>content complex</p>   |
| <p>children</p>   | <p><a href="#">Description</a></p>   |

element **RatingType/Descriptions/Description**

|            |  |
|------------|--|
| diagram    |  |
| properties | isRef 0<br>minOcc 1<br>maxOcc unbounded<br>content complex                   |
| children   | <a href="#">Language</a> <a href="#">Description</a> <a href="#">Caption</a> |

element **RatingType/Descriptions/Description/Language**

|            |                           |
|------------|---------------------------|
| diagram    |                           |
| type       | <b>xs:language</b>        |
| properties | isRef 0<br>content simple |

element **RatingType/Descriptions/Description/Description**

|            |   |
|------------|---|
| diagram    |   |
| type       | <b>xs:string</b>                                  |
| properties | isRef 0<br>minOcc 0<br>maxOcc 1<br>content simple |

element **RatingType/Descriptions/Description/Caption**

|            |   |
|------------|---|
| diagram    |   |
| type       | <b>xs:string</b>                                  |
| properties | isRef 0<br>minOcc 0<br>maxOcc 1<br>content simple |

complexType **ShareClassFeeType**

|          |   |
|----------|---|
| diagram  |   |
| children | <a href="#">Type</a> <a href="#">PayReceive</a> <a href="#">Minimum</a> <a href="#">Maximum</a> <a href="#">CalculationMethod</a> <a href="#">DataByPeriods</a> |
| used by  | element <a href="#">FeesType/Fee</a>  |

element **ShareClassFeeType/Type**

|            |  |
|------------|--|
| diagram    |  |
| type       | <a href="#">Text256Type</a>            |
| properties | isRef 0<br>content simple              |
| facets     | Kind Value annotation<br>maxLength 256 |
| annotation | documentation<br>Type of fee           |

element **ShareClassFeeType/PayReceive**

|            |                                   |
|------------|-----------------------------------|
| diagram    |                                   |
| type       | restriction of <b>xs:string</b>   |
| properties | isRef 0<br>content simple         |
| facets     | Kind Value annotation<br>length 1 |

|            |  |
|------------|--|
| annotation | documentation<br>Indicator Paid by the fund<br>or Received by the fund |
|------------|--|

element **ShareClassFeeType/Minimum**

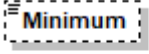
|            |   |
|------------|---|
| diagram    |  <p>Minimum value of Fee as<br/>percentage of<br/>TotalNetAssets</p> |
| type       | <a href="#">PercentageType</a>  |
| properties | isRef 0<br>minOcc 0<br>maxOcc 1<br>content simple   |
| annotation | documentation<br>Minimum value of Fee as percentage of TotalNetAssets   |

element **ShareClassFeeType/Maximum**

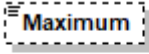
|            |   |
|------------|---|
| diagram    |  <p>Maximum value of Fee as<br/>percentage of<br/>TotalNetAssets</p> |
| type       | <a href="#">PercentageType</a>  |
| properties | isRef 0<br>minOcc 0<br>maxOcc 1<br>content simple   |
| annotation | documentation<br>Maximum value of Fee as percentage of TotalNetAssets   |

element **ShareClassFeeType/CalculationMethod**

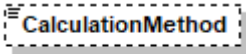
|            |  |
|------------|--|
| diagram    |  <p>Description of calculation<br/>method</p> |
| type       | <a href="#">Text1000Type</a>   |
| properties | isRef 0<br>minOcc 0<br>maxOcc 1<br>content simple  |
| facets     | Kind Value annotation<br>maxLength 1000  |
| annotation | documentation<br>Description of calculation method   |

element **ShareClassFeeType/DataByPeriods**

|            |  |
|------------|--|
| diagram    |  |
| properties | isRef 0<br>minOcc 0<br>maxOcc 1<br>content complex |
| children   | <a href="#">DataByPeriod</a>                       |
| annotation | documentation<br>Dynamic data for the Fee          |

element **ShareClassFeeType/DataByPeriods/DataByPeriod**

|            |  |
|------------|--|
| diagram    |  |
| type       | <a href="#">FeePeriodDataType</a>  |
| properties | isRef 0<br>minOcc 1<br>maxOcc unbounded<br>content complex   |
| children   | <a href="#">BeginDate</a> <a href="#">EndDate</a> <a href="#">CurrentDate</a> <a href="#">Values</a> <a href="#">CalculationData</a>                               |
| annotation | documentation<br>Data of past and ongoing periods<br>Ongoing period for fees with accrual day by day.<br>Only the most recent date is stored<br>(to be confirmed). |

complexType **ShareClassPriceType**

|                 |   |
|-----------------|---|
| <p>diagram</p>  | <p><b>ActionCode</b><br/>Operational code: Create(C), Modify(M) or Delete(D)</p> <p><b>NavDate</b><br/>Date of the calculated price per share if you don't know if it's the valuation price or calculation price</p> <p><b>PriceCalculationDate</b><br/>Date when the price per share is calculated</p> <p><b>PriceValuationDate</b><br/>Valuation date of the price per share. Indicates which valuation date for price calculation is used.</p> <p><b>PriceCurrency</b><br/>Currency of the calculated price. (use the 3 characters ISO code 4217)</p> <p><b>PriceNature</b><br/>Information whether the calculated price is an official, estimated or technical price</p> <p><b>NavPrice</b><br/>Net Asset value calculated per share</p> <p><b>SubscriptionPrice</b><br/>Subscription price per share</p> <p><b>RedemptionPrice</b><br/>Redemption price per share</p> <p><b>OtherPrices</b> </p> <p><b>SplitFactor</b><br/>Split factor in case of NAV split</p> |
| <p>children</p> | <p><a href="#">ActionCode</a> <a href="#">NavDate</a> <a href="#">PriceCalculationDate</a> <a href="#">PriceValuationDate</a> <a href="#">PriceCurrency</a> <a href="#">PriceNature</a> <a href="#">NavPrice</a> <a href="#">SubscriptionPrice</a> <a href="#">RedemptionPrice</a> <a href="#">OtherPrices</a> <a href="#">SplitFactor</a></p>  |
| <p>used by</p>  | <p>element <a href="#">ShareClassType/Prices/Price</a></p>  |

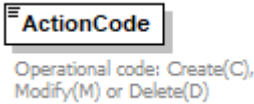

element **ShareClassPriceType/ActionCode**

|            |   |
|------------|---|
| diagram    |  |
| type       | restriction of <b>xs:string</b>   |
| properties | isRef 0<br>content <b>simple</b>  |
| facets     | Kind Value annotation<br>length 1   |
| annotation | documentation<br>Operational code: Create(C), Modify(M) or Delete(D)              |

element **ShareClassPriceType/NavDate**

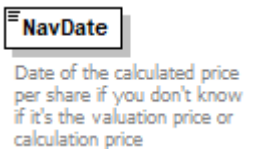
|            |  |
|------------|--|
| diagram    |   |
| type       | <b>xs:date</b>   |
| properties | isRef 0<br>content <b>simple</b>   |
| annotation | documentation<br>Date of the calculated price per share if you don't know if it's the valuation price or calculation price |

element **ShareClassPriceType/PriceCalculationDate**

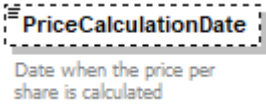
|            |   |
|------------|---|
| diagram    |  |
| type       | <b>xs:date</b>  |
| properties | isRef 0<br>minOcc 0<br>maxOcc 1<br>content <b>simple</b>                            |
| annotation | documentation<br>Date when the price per share is calculated                        |

element **ShareClassPriceType/PriceValuationDate**

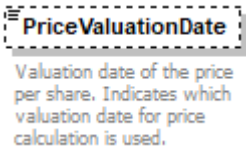
|            |   |
|------------|---|
| diagram    |  |
| type       | <b>xs:date</b>  |
| properties | isRef 0<br>minOcc 0<br>maxOcc 1<br>content <b>simple</b>                            |

|            |   |
|------------|---|
| annotation | documentation<br>Valuation date of the price per share. Indicates which valuation date for price calculation is used. |
|------------|---|

element **ShareClassPriceType/PriceCurrency**

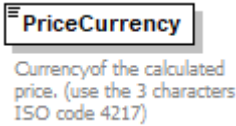
|            |   |
|------------|---|
| diagram    |        |
| type       | <a href="#">ISOCurrencyCodeType</a>   |
| properties | isRef 0<br>content simple   |
| facets     | Kind Value annotation<br>minLength 3<br>maxLength 3<br>pattern [A-Z]{3}                 |
| annotation | documentation<br>Currency of the calculated price. (use the 3 characters ISO code 4217) |

element **ShareClassPriceType/PriceNature**

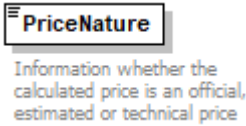
|            |  |
|------------|--|
| diagram    |                      |
| type       | restriction of <b>xs:string</b>  |
| properties | isRef 0<br>content simple  |
| facets     | Kind Value annotation<br>minLength 8<br>maxLength 9  |
| annotation | documentation<br>Information whether the calculated price is an official, estimated or technical price |

element **ShareClassPriceType/NavPrice**

|            |   |
|------------|---|
| diagram    |  |
| type       | restriction of <b>xs:decimal</b>  |
| properties | isRef 0<br>content simple   |
| facets     | Kind Value annotation<br>totalDigits 15<br>fractionDigits 8                         |
| annotation | documentation<br>Net Asset value calculated per share                               |

element **ShareClassPriceType/SubscriptionPrice**

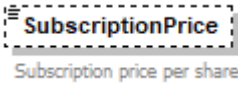
|            |   |
|------------|---|
| diagram    |  |
| type       | <b>xs:decimal</b>   |
| properties | isRef 0<br>minOcc 0<br>maxOcc 1<br>content simple                                 |
| annotation | documentation<br>Subscription price per share                                     |

element **ShareClassPriceType/RedemptionPrice**

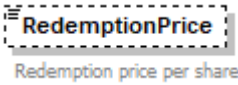
|            |   |
|------------|---|
| diagram    |  |
| type       | <b>xs:decimal</b>   |
| properties | isRef 0<br>minOcc 0<br>maxOcc 1<br>content simple                                 |
| annotation | documentation<br>Redemption price per share                                       |

element **ShareClassPriceType/OtherPrices**

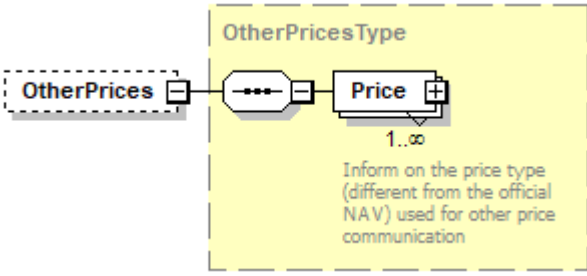
|            |   |
|------------|---|
| diagram    |  |
| type       | <a href="#">OtherPricesType</a>   |
| properties | isRef 0<br>minOcc 0<br>maxOcc 1<br>content complex                                  |
| children   | <a href="#">Price</a>   |

element **ShareClassPriceType/SplitFactor**

|            |   |
|------------|---|
| diagram    |  |
| type       | <b>xs:decimal</b>   |
| properties | isRef 0<br>minOcc 0   |

|            |   |
|------------|---|
|            | maxOcc 1<br>content simple                                |
| annotation | documentation<br><b>Split factor in case of NAV split</b> |

complexType **ShareClassType**

diagram

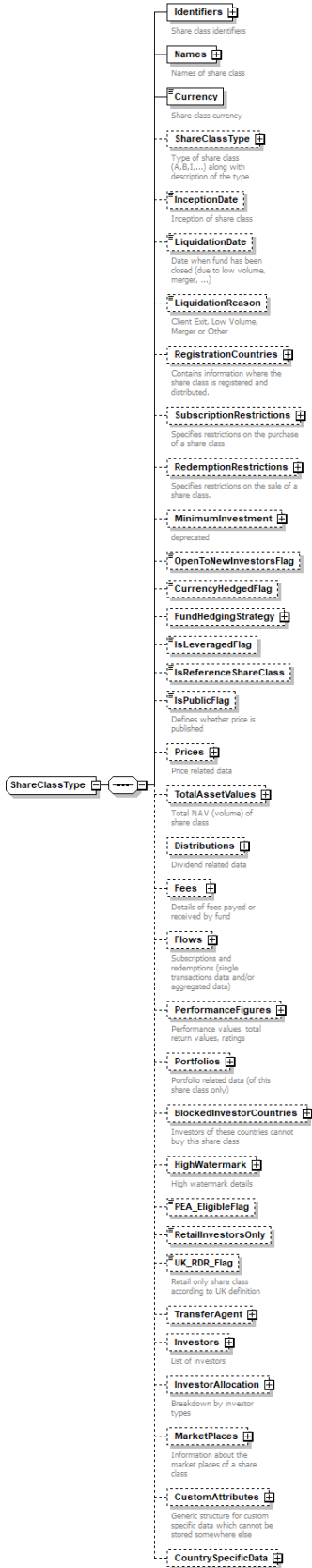

|          |  |
|----------|--|
| children | <a href="#">Identifiers</a> <a href="#">Names</a> <a href="#">Currency</a> <a href="#">ShareClassType</a> <a href="#">InceptionDate</a> <a href="#">LiquidationDate</a> <a href="#">LiquidationReason</a> <a href="#">RegistrationCountries</a> <a href="#">SubscriptionRestrictions</a> <a href="#">RedemptionRestrictions</a> <a href="#">MinimumInvestment</a> <a href="#">OpenToNewInvestorsFlag</a> <a href="#">CurrencyHedgedFlag</a> <a href="#">FundHedgingStrategy</a> <a href="#">IsLeveragedFlag</a> <a href="#">IsReferenceShareClass</a> <a href="#">IsPublicFlag</a> <a href="#">Prices</a> <a href="#">TotalAssetValues</a> <a href="#">Distributions</a> <a href="#">Fees</a> <a href="#">Flows</a> <a href="#">PerformanceFigures</a> <a href="#">Portfolios</a> <a href="#">BlockedInvestorCountries</a> <a href="#">HighWatermark</a> <a href="#">PEA</a> <a href="#">EligibleFlag</a> <a href="#">RetailInvestorsOnly</a> <a href="#">UK</a> <a href="#">RDR</a> <a href="#">Flag</a> <a href="#">TransferAgent</a> <a href="#">Investors</a> <a href="#">InvestorAllocation</a> <a href="#">MarketPlaces</a> <a href="#">CustomAttributes</a> <a href="#">CountrySpecificData</a> |
| used by  | elements <a href="#">SegmentType/ShareClasses/ShareClass</a> <a href="#">SubfundType/ShareClasses/ShareClass</a> <a href="#">SingleFundType/ShareClasses/ShareClass</a>  |

element **ShareClassType/Identifiers**

diagram

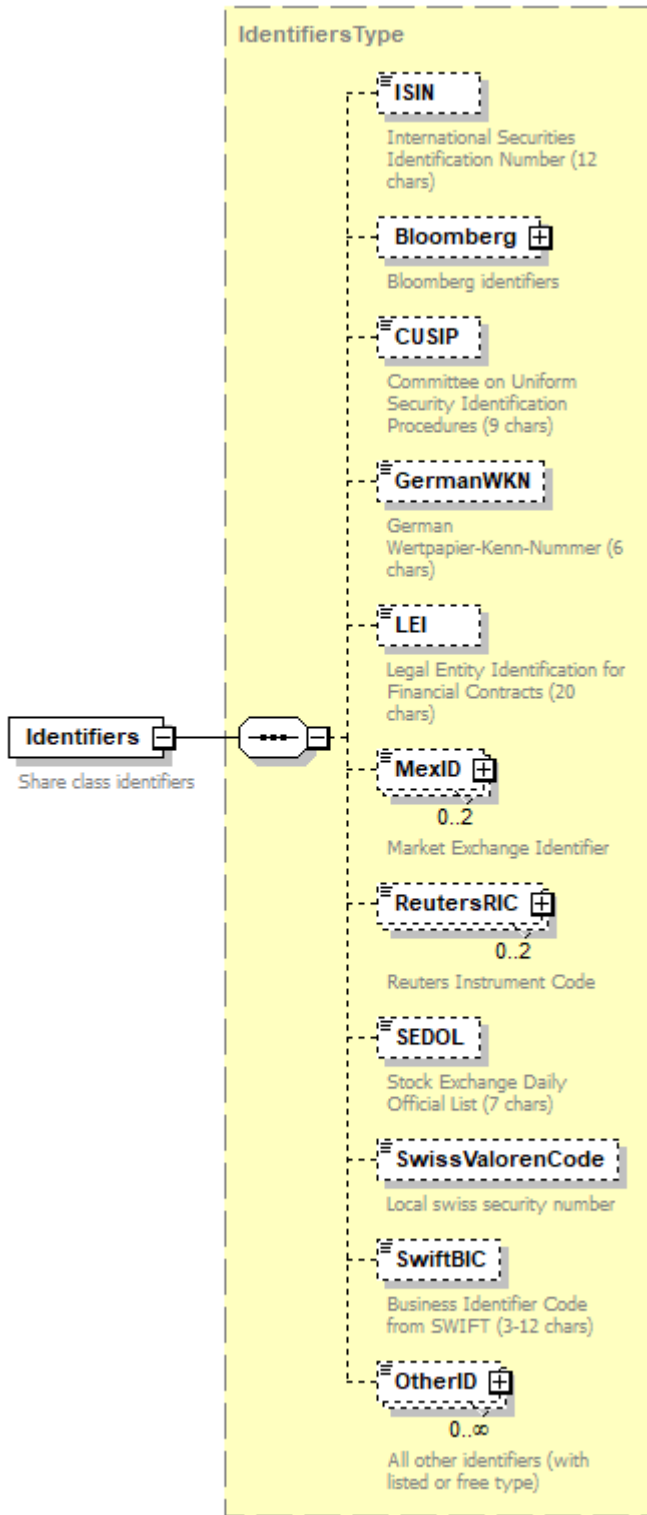

|            |   |
|------------|---|
| type       | <a href="#">IdentifiersType</a>   |
| properties | isRef 0<br>content complex  |
| children   | <a href="#">ISIN</a> <a href="#">Bloomberg</a> <a href="#">CUSIP</a> <a href="#">GermanWKN</a> <a href="#">LEI</a> <a href="#">MexID</a> <a href="#">ReutersRIC</a> <a href="#">SEDOL</a> <a href="#">SwissValorenCode</a> <a href="#">SwiftBIC</a> <a href="#">OtherID</a> |



|            |  |
|------------|--|
| annotation | documentation<br>Share class identifiers |
|------------|--|

element **ShareClassType/Names**

|            |  |
|------------|--|
| diagram    |  |
| type       | <a href="#">NamesType</a>  |
| properties | isRef 0<br>content complex   |
| children   | <a href="#">OfficialName</a> <a href="#">FullName</a> <a href="#">MarketingName</a> <a href="#">ShortName</a> <a href="#">PreviousName</a> <a href="#">DynLenNames</a> <a href="#">LanguageNames</a> |
| annotation | documentation<br>Names of share class  |

element **ShareClassType/Currency**

|            |                                     |
|------------|-------------------------------------|
| diagram    |                                     |
| type       | <a href="#">ISOCurrencyCodeType</a> |
| properties | isRef 0<br>content simple           |

|            |               |                      |            |
|------------|---------------|----------------------|------------|
| facets     | Kind          | Value                | annotation |
|            | minLength     | 3                    |            |
|            | maxLength     | 3                    |            |
|            | pattern       | [A-Z]{3}             |            |
| annotation | documentation | Share class currency |            |

element **ShareClassType/ShareClassType**

|            |  |
|------------|--|
| diagram    |  |
| type       | <a href="#">ShareClassTypeType</a>   |
| properties | isRef 0<br>minOcc 0<br>maxOcc 1<br>content complex   |
| children   | <a href="#">Code</a> <a href="#">EarningUse</a> <a href="#">Name</a> <a href="#">Description</a> |
| annotation | documentation<br>Type of share class (A,B,I,...) along with description of the type              |

element **ShareClassType/InceptionDate**

|            |   |
|------------|---|
| diagram    |   |
| type       | <b>xs:date</b>                                    |
| properties | isRef 0<br>minOcc 0<br>maxOcc 1<br>content simple |
| annotation | documentation<br>Inception of share class         |

element **ShareClassType/LiquidationDate**

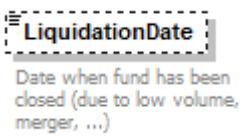
|            |   |
|------------|---|
| diagram    |  <p><b>LiquidationDate</b><br/>Date when fund has been closed (due to low volume, merger, ...)</p> |
| type       | <b>xs:date</b>  |
| properties | isRef 0<br>minOcc 0<br>maxOcc 1<br>content simple   |
| annotation | documentation<br>Date when fund has been closed (due to low volume, merger, ...)  |

element **ShareClassType/LiquidationReason**

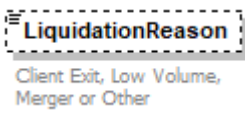
|            |  |
|------------|--|
| diagram    |  <p><b>LiquidationReason</b><br/>Client Exit, Low Volume, Merger or Other</p> |
| type       | restriction of <b>xs:string</b>  |
| properties | isRef 0<br>minOcc 0<br>maxOcc 1<br>content simple  |
| annotation | documentation<br>Client Exit, Low Volume, Merger or Other  |

element **ShareClassType/RegistrationCountries**

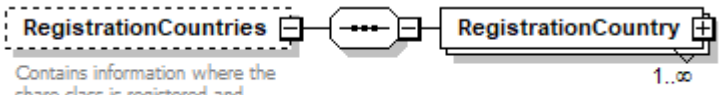
|            |   |
|------------|---|
| diagram    |  <p><b>RegistrationCountries</b> — (---) — <b>RegistrationCountry</b> 1..∞</p> <p>Contains information where the share class is registered and distributed.</p> |
| properties | isRef 0<br>minOcc 0<br>maxOcc 1<br>content complex  |
| children   | <a href="#">RegistrationCountry</a>   |
| annotation | documentation<br>Contains information where the share class is registered and distributed.  |

element **ShareClassType/RegistrationCountries/RegistrationCountry**

|                   |  |
|-------------------|--|
| <p>diagram</p>    | <p>The diagram illustrates the structure of the <b>RegistrationCountry</b> element. It is a container element with a multiplicity of 1..∞. It contains six child elements:</p> <ul style="list-style-type: none"> <li><b>CountryCode</b>: Share-class registration countries (Host countries).</li> <li><b>Status</b>: Give additional information about the registration in a specific country.</li> <li><b>StatusDate</b>: Date, at which the fund or shareclass is registered or de-registered in the country.</li> <li><b>SubStatus</b>: Indicates if an investor limitation exist for related registration country.</li> <li><b>MarketingDistributionStatus</b>: Give additional information about the marketing distribution in a specific country.</li> <li><b>MarketingDistributionStatusDate</b>: Date, at which the distribution of the fund or shareclass started or ended in the country.</li> </ul> |
| <p>properties</p> | <p>isRef 0<br/> minOcc 1<br/> maxOcc unbounded<br/> content complex</p>  |
| <p>children</p>   | <p><a href="#">CountryCode</a> <a href="#">Status</a> <a href="#">StatusDate</a> <a href="#">SubStatus</a> <a href="#">MarketingDistributionStatus</a> <a href="#">MarketingDistributionStatusDate</a></p>   |

element **ShareClassType/RegistrationCountries/RegistrationCountry/CountryCode**

|                   |  |
|-------------------|--|
| <p>diagram</p>    | <p>The diagram shows the <b>CountryCode</b> element, which represents share-class registration countries (Host countries).</p> |
| <p>type</p>       | <p><a href="#">ISOCountryCodeType</a></p>  |
| <p>properties</p> | <p>isRef 0<br/> content simple</p>   |
| <p>facets</p>     | <p>Kind Value annotation<br/> minLength 2<br/> maxLength 2</p>   |
| <p>annotation</p> | <p>documentation<br/> Share-class registration countries (Host countries).</p>   |

element **ShareClassType/RegistrationCountries/RegistrationCountry/Status**

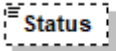
|            |  |
|------------|--|
| diagram    |  <p>Give additional information about the registration in a specific country.</p> |
| type       | restriction of <b>xs:string</b>  |
| properties | isRef 0<br>minOcc 0<br>maxOcc 1<br>content simple  |
| annotation | documentation<br>Give additional information about the registration in a specific country.   |

element **ShareClassType/RegistrationCountries/RegistrationCountry/StatusDate**

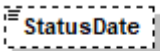
|            |  |
|------------|--|
| diagram    |  <p>Date, at which the fund or shareclass is registered or de-registered in the country</p> |
| type       | <b>xs:date</b>   |
| properties | isRef 0<br>minOcc 0<br>maxOcc 1<br>content simple  |
| annotation | documentation<br>Date, at which the fund or shareclass is registered or de-registered in the country   |

element **ShareClassType/RegistrationCountries/RegistrationCountry/SubStatus**

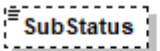
|            |   |
|------------|---|
| diagram    |  <p>Indicates if an investor limitation exist for related registration country</p> |
| type       | restriction of <b>xs:string</b>   |
| properties | isRef 0<br>minOcc 0<br>maxOcc 1<br>content simple   |
| annotation | documentation<br>Indicates if an investor limitation exist for related registration country   |

element **ShareClassType/RegistrationCountries/RegistrationCountry/MarketingDistributionStatus**

|            |  |
|------------|--|
| diagram    |  <p>Give additional information about the marketing distribution in a specific country.</p> |
| type       | restriction of <b>xs:string</b>  |
| properties | isRef 0<br>minOcc 0<br>maxOcc 1<br>content simple  |

|            |  |
|------------|--|
| annotation | documentation<br>Give additional information about the marketing distribution in a specific country. |
|------------|--|

element **ShareClassType/RegistrationCountries/RegistrationCountry/MarketingDistributionStatusDate**

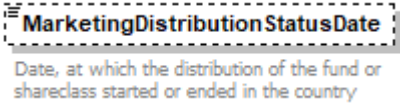
|            |  |
|------------|--|
| diagram    |  <p><b>MarketingDistributionStatusDate</b></p> <p>Date, at which the distribution of the fund or shareclass started or ended in the country</p> |
| type       | <b>xs:date</b>   |
| properties | isRef 0<br>minOcc 0<br>maxOcc 1<br>content simple  |
| annotation | documentation<br>Date, at which the distribution of the fund or shareclass started or ended in the country   |

element **ShareClassType/SubscriptionRestrictions**

|                   |   |
|-------------------|---|
| <p>diagram</p>    | <p>The diagram shows a class <b>SubscriptionRestrictions</b> with a description: "Specifies restrictions on the purchase of a share class". It has seven subclasses, each with a description:</p> <ul style="list-style-type: none"> <li><b>MinSubscriptionAmount</b>: Indicates the minimum initial subscription value in the relevant currency. 0 EUR means that there is no minimum applicable.</li> <li><b>MinSubscriptionShares</b>: Indicates the minimum initial number of units/shares that must be purchased if any. 0 means that there is no minimum applicable.</li> <li><b>MinSubscriptionAmountSubsequent</b>: Indicates the minimum subscription value for existing investors expressed in the relevant currency. 0 EUR means that there is no minimum applicable.</li> <li><b>MinSubscriptionSharesSubsequent</b>: Indicates the minimum number of units/shares that must be purchased by existing investors if any. 0 means that there is no minimum applicable.</li> <li><b>MinRegularInvestmentAmount</b>: Indicates the Minimum Regular Investment amount allowed (e.g. EUR 1000). 0 EUR means that there is no Minimum Regular Investment.</li> <li><b>MinRegularInvestmentShares</b>: Enter the Minimum Regular Investment in units/shares allowed. Format is Numeric Value (e.g. if 1 Share then enter 1). 0 means that there is no Minimum Regular Investment in units/shares applicable.</li> <li><b>OtherSubscriptionRestrictions</b>: Indicate any other restrictions that may limit an investor's ability to subscribe.</li> </ul> |
| <p>properties</p> | <p>isRef 0<br/>minOcc 0<br/>maxOcc 1<br/>content complex</p>  |
| <p>children</p>   | <p><a href="#">MinSubscriptionAmount</a> <a href="#">MinSubscriptionShares</a> <a href="#">MinSubscriptionAmountSubsequent</a> <a href="#">MinSubscriptionSharesSubsequent</a> <a href="#">MinRegularInvestmentAmount</a> <a href="#">MinRegularInvestmentShares</a> <a href="#">OtherSubscriptionRestrictions</a></p>  |
| <p>annotation</p> | <p>documentation<br/>Specifies restrictions on the purchase of a share class</p>  |

element **ShareClassType/SubscriptionRestrictions/MinSubscriptionAmount**

|            |   |
|------------|---|
| diagram    | <p><b>MinSubscriptionAmount</b><br/>Indicates the minimum initial subscription value in the relevant currency. 0 EUR means that there is no minimum applicable.</p> <p><b>AmountType</b><br/>Amounts in currency as defined in attribute<br/>1..∞</p> |
| type       | <a href="#">AmountType</a>  |
| properties | <ul style="list-style-type: none"> <li>isRef 0</li> <li>minOcc 0</li> <li>maxOcc 1</li> <li>content complex</li> </ul>  |
| children   | <a href="#">Amount</a>  |
| annotation | <p>documentation</p> <p>Indicates the minimum initial subscription value in the relevant currency. 0 EUR means that there is no minimum applicable.</p>   |

element **ShareClassType/SubscriptionRestrictions/MinSubscriptionShares**

|            |  |
|------------|--|
| diagram    | <p><b>Min Subscription Shares</b><br/>Indicates the minimum initial number of units/shares that must be purchased if any. 0 means that there is no minimum applicable.</p> |
| type       | <b>xs:decimal</b>  |
| properties | <ul style="list-style-type: none"> <li>isRef 0</li> <li>minOcc 0</li> <li>maxOcc 1</li> <li>content simple</li> </ul>  |
| annotation | <p>documentation</p> <p>Indicates the minimum initial number of units/shares that must be purchased if any. 0 means that there is no minimum applicable.</p>               |

element **ShareClassType/SubscriptionRestrictions/MinSubscriptionAmountSubsequent**

|            |  |
|------------|--|
| diagram    | <p><b>MinSubscriptionAmountSubse...</b><br/>Indicates the minimum subscription value for existing investors expressed in the relevant currency. 0 EUR means that there is no minimum applicable.</p> <p><b>AmountType</b><br/>Amounts in currency as defined in attribute<br/>1..∞</p> |
| type       | <a href="#">AmountType</a>   |
| properties | <ul style="list-style-type: none"> <li>isRef 0</li> <li>minOcc 0</li> <li>maxOcc 1</li> <li>content complex</li> </ul>   |
| children   | <a href="#">Amount</a>   |
| annotation | <p>documentation</p> <p>Indicates the minimum subscription value for existing investors expressed in the relevant currency. 0 EUR means that there is no minimum applicable.</p>   |

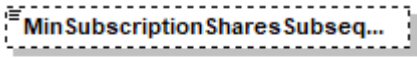

element **ShareClassType/SubscriptionRestrictions/MinSubscriptionSharesSubsequent**

|            |  |
|------------|--|
| diagram    |  <p><b>MinSubscriptionSharesSubseq...</b></p> <p>Indicates the minimum number of units/shares that must be purchased by existing investors if any. 0 means that there is no minimum applicable.</p> |
| type       | <b>xs:decimal</b>  |
| properties | <p>isRef 0</p> <p>minOcc 0</p> <p>maxOcc 1</p> <p>content simple</p>   |
| annotation | <p>documentation</p> <p>Indicates the minimum number of units/shares that must be purchased by existing investors if any. 0 means that there is no minimum applicable.</p>   |

element **ShareClassType/SubscriptionRestrictions/MinRegularInvestmentAmount**

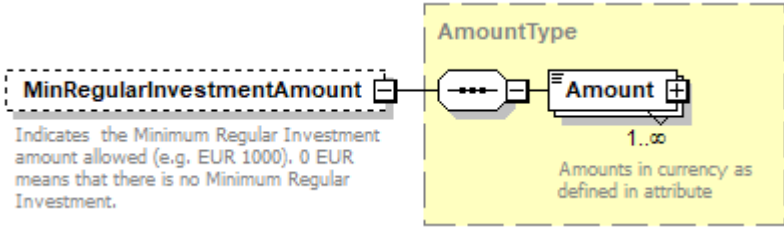
|            |  |
|------------|--|
| diagram    |  <p><b>MinRegularInvestmentAmount</b></p> <p>Indicates the Minimum Regular Investment amount allowed (e.g. EUR 1000). 0 EUR means that there is no Minimum Regular Investment.</p> <p><b>AmountType</b></p> <p><b>Amount</b></p> <p>1..∞</p> <p>Amounts in currency as defined in attribute</p> |
| type       | <a href="#">AmountType</a>   |
| properties | <p>isRef 0</p> <p>minOcc 0</p> <p>maxOcc 1</p> <p>content complex</p>  |
| children   | <a href="#">Amount</a>   |
| annotation | <p>documentation</p> <p>Indicates the Minimum Regular Investment amount allowed (e.g. EUR 1000). 0 EUR means that there is no Minimum Regular Investment.</p>  |

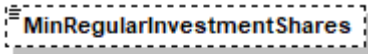

element **ShareClassType/SubscriptionRestrictions/MinRegularInvestmentShares**

|            |  |
|------------|--|
| diagram    |  <p><b>MinRegularInvestmentShares</b></p> <p>Enter the Minimum Regular Investment in units/shares allowed. Format is Numeric Value (e.g. if 1 Share then enter 1).0 means that there is no Minimum Regular Investment in units/shares applicable.</p> |
| type       | <b>xs:decimal</b>  |
| properties | <p>isRef 0</p> <p>minOcc 0</p> <p>maxOcc 1</p> <p>content simple</p>   |
| annotation | <p>documentation</p> <p>Enter the Minimum Regular Investment in units/shares allowed. Format is Numeric Value (e.g. if 1 Share then enter 1).0 means that there is no Minimum Regular Investment in units/shares applicable.</p>   |

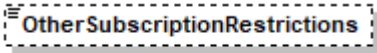
element **ShareClassType/SubscriptionRestrictions/OtherSubscriptionRestrictions**

|            |   |
|------------|---|
| diagram    |  <p><b>OtherSubscriptionRestrictions</b></p> <p>Indicate any other restrictions that may limit an investor's ability to subscribe.</p> |
| type       | <b>xs:string</b>  |
| properties | isRef 0<br>minOcc 0<br>maxOcc 1<br>content simple   |
| annotation | documentation<br>Indicate any other restrictions that may limit an investor's ability to subscribe.   |

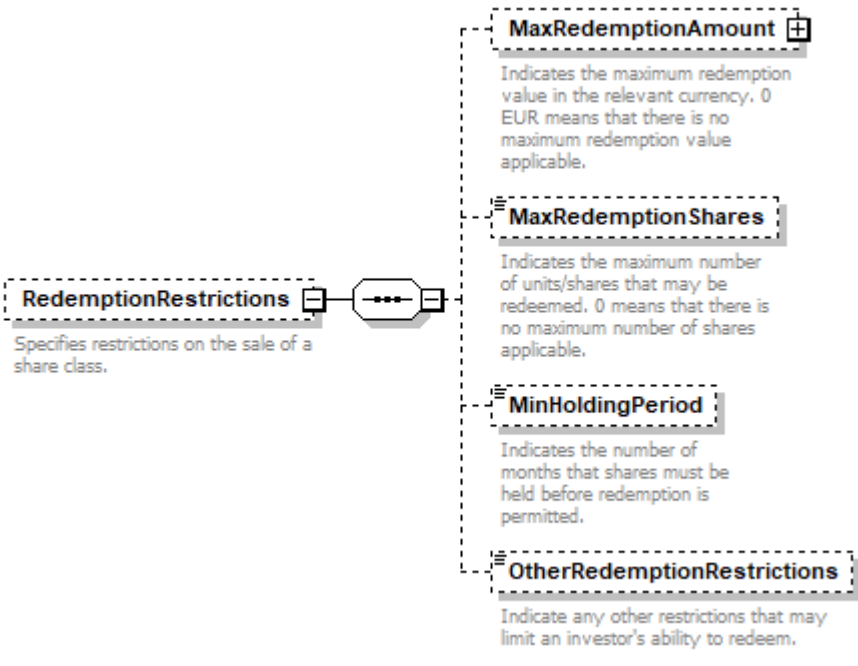
element **ShareClassType/RedemptionRestrictions**

|            |   |
|------------|---|
| diagram    |  <p><b>RedemptionRestrictions</b></p> <p>Specifies restrictions on the sale of a share class.</p> <p><b>MaxRedemptionAmount</b> </p> <p>Indicates the maximum redemption value in the relevant currency. 0 EUR means that there is no maximum redemption value applicable.</p> <p><b>MaxRedemptionShares</b></p> <p>Indicates the maximum number of units/shares that may be redeemed. 0 means that there is no maximum number of shares applicable.</p> <p><b>MinHoldingPeriod</b></p> <p>Indicates the number of months that shares must be held before redemption is permitted.</p> <p><b>OtherRedemptionRestrictions</b></p> <p>Indicate any other restrictions that may limit an investor's ability to redeem.</p> |
| properties | isRef 0<br>minOcc 0<br>maxOcc 1<br>content complex  |
| children   | <a href="#">MaxRedemptionAmount</a> <a href="#">MaxRedemptionShares</a> <a href="#">MinHoldingPeriod</a> <a href="#">OtherRedemptionRestrictions</a>  |
| annotation | documentation<br>Specifies restrictions on the sale of a share class.   |

element **ShareClassType/RedemptionRestrictions/MaxRedemptionAmount**

|            |  |
|------------|--|
| diagram    | <p><b>MaxRedemptionAmount</b><br/>Indicates the maximum redemption value in the relevant currency. 0 EUR means that there is no maximum redemption value applicable.</p> <p><b>AmountType</b><br/>Amounts in currency as defined in attribute<br/>1..∞</p> |
| type       | <a href="#">AmountType</a>   |
| properties | isRef 0<br>minOcc 0<br>maxOcc 1<br>content complex   |
| children   | <a href="#">Amount</a>   |
| annotation | documentation<br>Indicates the maximum redemption value in the relevant currency. 0 EUR means that there is no maximum redemption value applicable.  |

element **ShareClassType/RedemptionRestrictions/MaxRedemptionShares**

|            |  |
|------------|--|
| diagram    | <p><b>MaxRedemptionShares</b><br/>Indicates the maximum number of units/shares that may be redeemed. 0 means that there is no maximum number of shares applicable.</p> |
| type       | <b>xs:decimal</b>  |
| properties | isRef 0<br>minOcc 0<br>maxOcc 1<br>content simple  |
| annotation | documentation<br>Indicates the maximum number of units/shares that may be redeemed. 0 means that there is no maximum number of shares applicable.                      |

element **ShareClassType/RedemptionRestrictions/MinHoldingPeriod**

|            |  |
|------------|--|
| diagram    | <p><b>MinHoldingPeriod</b><br/>Indicates the number of months that shares must be held before redemption is permitted.</p> |
| type       | <b>xs:decimal</b>  |
| properties | isRef 0<br>minOcc 0<br>maxOcc 1<br>content simple  |
| annotation | documentation<br>Indicates the number of months that shares must be held before redemption is permitted.                   |

element **ShareClassType/RedemptionRestrictions/OtherRedemptionRestrictions**

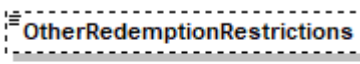
|            |  |
|------------|--|
| diagram    |  <p><b>OtherRedemptionRestrictions</b></p> <p>Indicate any other restrictions that may limit an investor's ability to redeem.</p> |
| type       | <b>xs:string</b>   |
| properties | isRef 0<br>minOcc 0<br>maxOcc 1<br>content simple  |
| annotation | documentation<br>Indicate any other restrictions that may limit an investor's ability to redeem.   |

element **ShareClassType/MinimumInvestment**

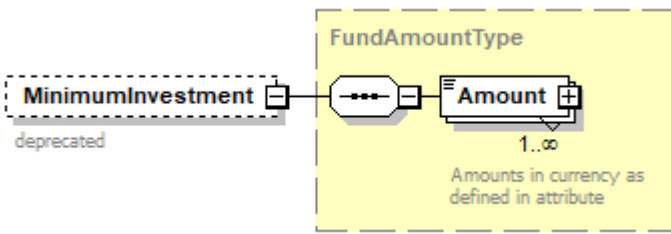
|            |   |
|------------|---|
| diagram    |  <p><b>MinimumInvestment</b><br/>deprecated</p> <p><b>FundAmountType</b></p> <p><b>Amount</b><br/>1..∞<br/>Amounts in currency as defined in attribute</p> |
| type       | <a href="#">FundAmountType</a>  |
| properties | isRef 0<br>minOcc 0<br>maxOcc 1<br>content complex  |
| children   | <a href="#">Amount</a>  |
| annotation | documentation<br>deprecated   |

element **ShareClassType/OpenToNewInvestorsFlag**

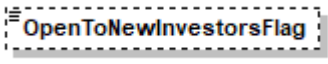
|            |  |
|------------|--|
| diagram    |  <p><b>OpenToNewInvestorsFlag</b></p> |
| type       | <b>xs:boolean</b>  |
| properties | isRef 0<br>minOcc 0<br>maxOcc 1<br>content simple  |

element **ShareClassType/CurrencyHedgedFlag**

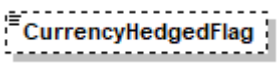
|            |  |
|------------|--|
| diagram    |  <p><b>CurrencyHedgedFlag</b></p> |
| type       | <b>xs:boolean</b>  |
| properties | isRef 0<br>minOcc 0<br>maxOcc 1<br>content simple  |

element **ShareClassType/FundHedgingStrategy**

|            |  |
|------------|--|
| diagram    | <p><b>HedgingStrategyType</b></p> <p>A net asset value (NAV) hedge: This aims to minimise the effect of currency movements between the base currency of a fund and the currency of the relevant hedged share class.<br/>         A portfolio hedge: This aims to minimise the effect of currency movements between the currencies of the assets of the fund and the currency of the relevant hedged share class with the exception of currencies where it is impractical or not cost effective to do so. In other words, it looks through to the underlying currency exposures of the fund.<br/>         Full hedge: Open position that eliminates over 90% or more of the risk arising from another open position.<br/>         Partial hedge: Open position that eliminates below 90% but more than 0% of the risk arising from another open position.</p> |
| type       | <a href="#">HedgingStrategyType</a>  |
| properties | isRef 0<br>minOcc 0<br>maxOcc 1<br>content complex   |
| children   | <a href="#">HedgingStrategy</a>  |

element **ShareClassType/IsLeveragedFlag**

|            |   |
|------------|---|
| diagram    |   |
| type       | <b>xs:boolean</b>                                 |
| properties | isRef 0<br>minOcc 0<br>maxOcc 1<br>content simple |

element **ShareClassType/IsReferenceShareClass**

|         |                   |
|---------|-------------------|
| diagram |                   |
| type    | <b>xs:boolean</b> |

|            |   |
|------------|---|
| properties | isRef 0<br>minOcc 0<br>maxOcc 1<br>content simple |
|------------|---|

element **ShareClassType/IsPublicFlag**

|            |   |
|------------|---|
| diagram    |  |
| type       | <b>xs:boolean</b>   |
| properties | isRef 0<br>minOcc 0<br>maxOcc 1<br>content simple                                 |
| annotation | documentation<br>Defines whether price is published                               |

element **ShareClassType/Prices**

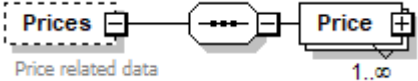
|            |   |
|------------|---|
| diagram    |  |
| properties | isRef 0<br>minOcc 0<br>maxOcc 1<br>content complex                                |
| children   | <a href="#">Price</a>   |
| annotation | documentation<br>Price related data   |

element **ShareClassType/Prices/Price**

diagram

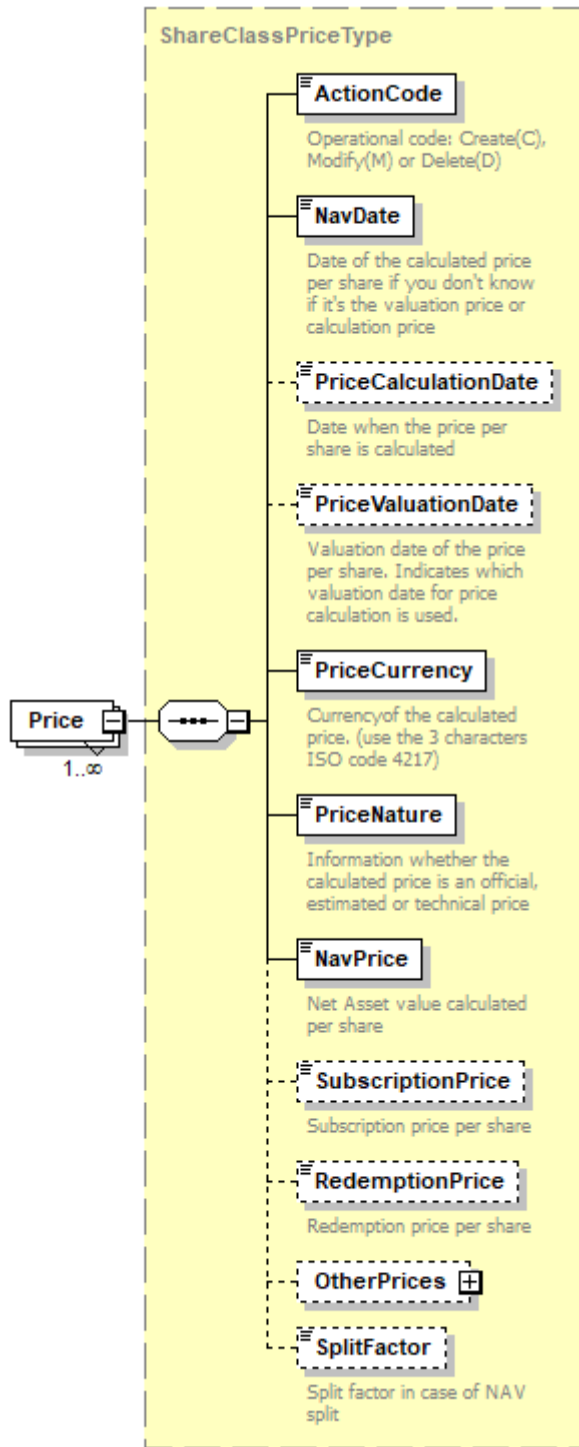

type [ShareClassPriceType](#)

properties  
 isRef 0  
 minOcc 1  
 maxOcc unbounded  
 content complex

children [ActionCode](#) [NavDate](#) [PriceCalculationDate](#) [PriceValuationDate](#) [PriceCurrency](#) [PriceNature](#) [NavPrice](#)

[SubscriptionPrice](#) [RedemptionPrice](#) [OtherPrices](#) [SplitFactor](#)

element **ShareClassType/TotalAssetValues**

|            |   |
|------------|---|
| diagram    | <p>The diagram shows a class <b>TotalAssetValues</b> (indicated by a dashed border) connected to a class <b>TotalAssetValue</b>. The relationship is a composition, shown by a solid line with an open arrowhead pointing to <b>TotalAssetValue</b>. The multiplicity for <b>TotalAssetValue</b> is <math>1..∞</math>. Below the <b>TotalAssetValues</b> class name, the text "Total NAV (volume) of share class" is present.</p> |
| properties | isRef 0<br>minOcc 0<br>maxOcc 1<br>content complex  |
| children   | <a href="#">TotalAssetValue</a>   |
| annotation | documentation<br>Total NAV (volume) of share class  |



element **ShareClassType/TotalAssetValues/TotalAssetValue**

|                   |   |
|-------------------|---|
| <p>diagram</p>    |   |
| <p>type</p>       | <p><a href="#">TotalAssetValueType</a></p>  |
| <p>properties</p> | <p>isRef 0<br/>minOcc 1<br/>maxOcc unbounded<br/>content complex</p>  |
| <p>children</p>   | <p><a href="#">NavDate</a> <a href="#">TotalAssetNature</a> <a href="#">TotalNetAssetValue</a> <a href="#">TotalGrossAssetValue</a> <a href="#">SharesOutstanding</a> <a href="#">Ratio</a> <a href="#">OtherTotalAssetValues</a></p> |

element **ShareClassType/Distributions**

|                   |                             |
|-------------------|-----------------------------|
| <p>diagram</p>    |                             |
| <p>properties</p> | <p>isRef 0<br/>minOcc 0</p> |

|            |  |
|------------|--|
|            | maxOcc 1<br>content complex            |
| children   | <a href="#">Distribution</a>           |
| annotation | documentation<br>Dividend related data |

element **ShareClassType/Distributions/Distribution**

diagram

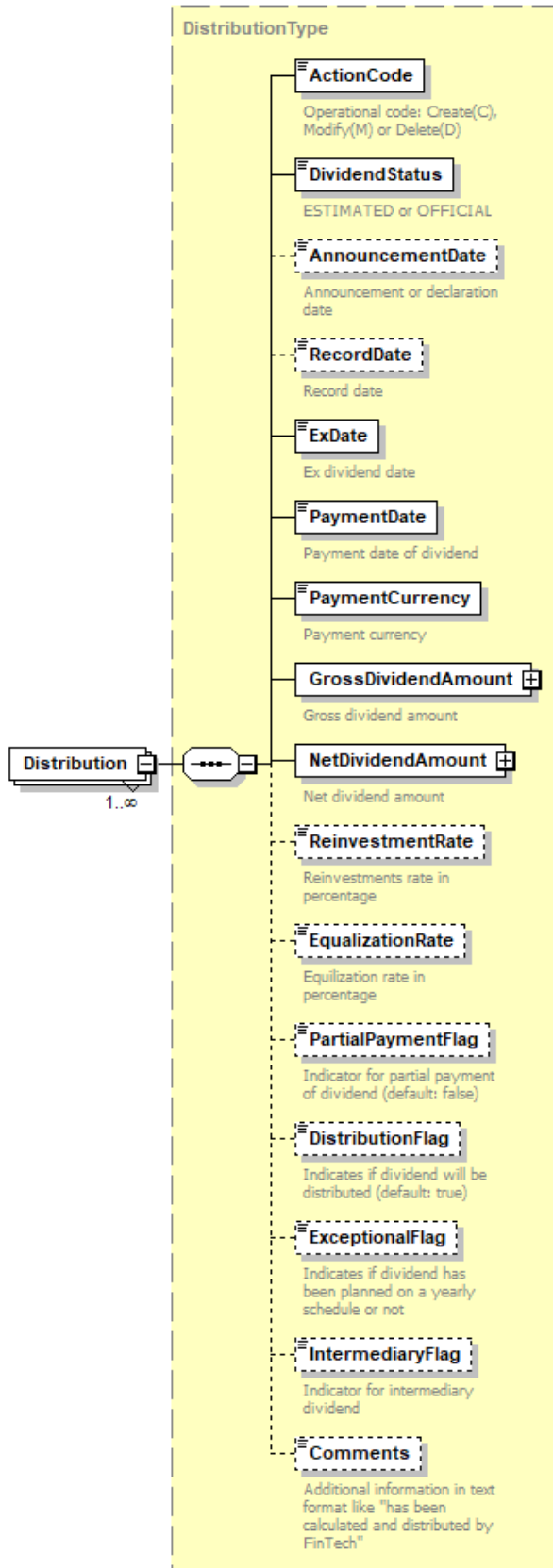

|            |  |
|------------|--|
| type       | <a href="#">DistributionType</a>   |
| properties | isRef 0<br>minOcc 1<br>maxOcc unbounded<br>content complex   |
| children   | <a href="#">ActionCode</a> <a href="#">DividendStatus</a> <a href="#">AnnouncementDate</a> <a href="#">RecordDate</a> <a href="#">ExDate</a> <a href="#">PaymentDate</a> <a href="#">PaymentCurrency</a><br><a href="#">GrossDividendAmount</a> <a href="#">NetDividendAmount</a> <a href="#">ReinvestmentRate</a> <a href="#">EqualizationRate</a> <a href="#">PartialPaymentFlag</a><br><a href="#">DistributionFlag</a> <a href="#">ExceptionalFlag</a> <a href="#">IntermediaryFlag</a> <a href="#">Comments</a> |

element **ShareClassType/Fees**

|            |  |
|------------|--|
| diagram    |  |
| type       | <a href="#">FeesType</a>                                   |
| properties | isRef 0<br>minOcc 0<br>maxOcc 1<br>content complex         |
| children   | <a href="#">Fee</a>  |
| annotation | documentation<br>Details of fees payed or received by fund |

element **ShareClassType/Flows**

|            |  |
|------------|--|
| diagram    |  |
| properties | isRef 0<br>minOcc 0<br>maxOcc 1<br>content complex   |
| children   | <a href="#">Flow</a>   |
| annotation | documentation<br>Subscriptions and redemptions (single transactions data and/or aggregated data) |

attribute **ShareClassType/Flows/@from**

|            |                |
|------------|----------------|
| type       | <b>xs:date</b> |
| properties | isRef 0        |

attribute **ShareClassType/Flows/@to**

|            |                |
|------------|----------------|
| type       | <b>xs:date</b> |
| properties | isRef 0        |

element **ShareClassType/Flows/Flow**

diagram

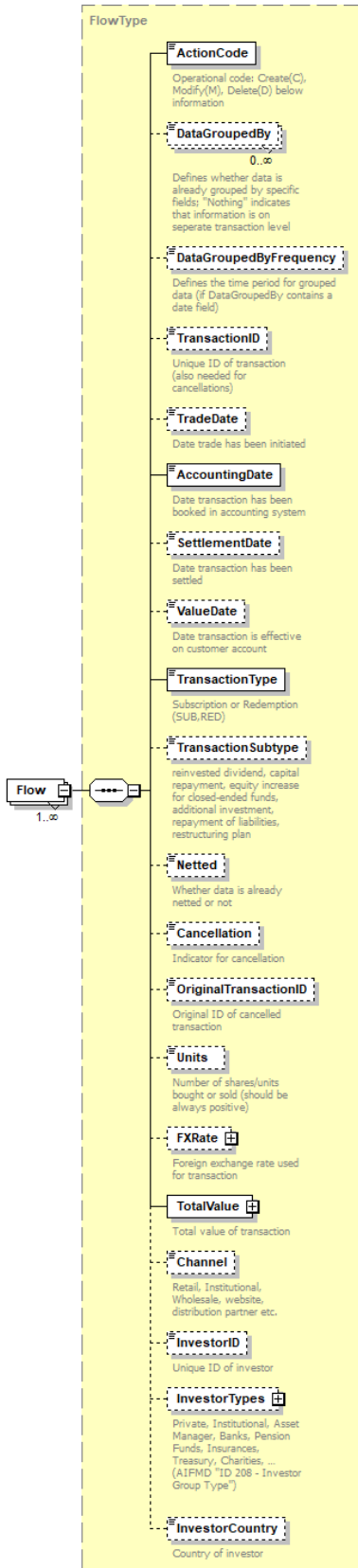

|            |   |
|------------|---|
| type       | <a href="#">FlowType</a>  |
| properties | isRef 0<br>minOcc 1<br>maxOcc unbounded<br>content complex  |
| children   | <a href="#">ActionCode</a> <a href="#">DataGroupedBy</a> <a href="#">DataGroupedByFrequency</a> <a href="#">TransactionID</a> <a href="#">TradeDate</a> <a href="#">AccountingDate</a> <a href="#">SettlementDate</a> <a href="#">ValueDate</a> <a href="#">TransactionType</a> <a href="#">TransactionSubtype</a> <a href="#">Netted</a> <a href="#">Cancellation</a> <a href="#">OriginalTransactionID</a> <a href="#">Units</a> <a href="#">FXRate</a> <a href="#">TotalValue</a> <a href="#">Channel</a> <a href="#">InvestorID</a> <a href="#">InvestorTypes</a> <a href="#">InvestorCountry</a> |

element **ShareClassType/PerformanceFigures**

|            |  |
|------------|--|
| diagram    |  |
| type       | <a href="#">PerformanceFiguresType</a>   |
| properties | isRef 0<br>minOcc 0<br>maxOcc 1<br>content complex   |
| children   | <a href="#">ActionCode</a> <a href="#">TotalReturns</a> <a href="#">Performances</a> <a href="#">Ratings</a> |
| annotation | documentation<br>Performance values, total return values, ratings  |

element **ShareClassType/Portfolios**

|            |  |
|------------|--|
| diagram    |  |
| properties | isRef 0<br>minOcc 0<br>maxOcc 1<br>content complex                 |
| children   | <a href="#">Portfolio</a>  |
| annotation | documentation<br>Portfolio related data (of this share class only) |



element **ShareClassType/Portfolios/Portfolio**

|                   |  |
|-------------------|--|
| <p>diagram</p>    | <p><b>Portfolio</b><br/>1..∞<br/>Portfolio data including total net asset values, positions, transactions, breakdowns, ...</p> <p><b>PortfolioType</b></p> <ul style="list-style-type: none"> <li><b>NavDate</b><br/>NavDate for all data within this section</li> <li><b>Positions</b><br/>All positions/holdings of fund/portfolio (including accounts, earnings and fees)</li> <li><b>Transactions</b><br/>Transactions within the portfolio (securities and other assets bought or sold)</li> <li><b>Earnings</b><br/>Earnings data (coupons, dividends, distributions) resulting from security positions</li> <li><b>PositionsDecomposed</b><br/>Decomposed positions (holdings of share classes are replaced by the scaled down positions of the subfund)</li> <li><b>BreakDowns</b><br/>All kind of break down data (including currency exposure)</li> <li><b>RiskCodes</b><br/>List of risk codes (risk indicators, key risk figures)</li> </ul> |
| <p>type</p>       | <p><a href="#">PortfolioType</a></p>   |
| <p>properties</p> | <p>isRef 0<br/>minOcc 1<br/>maxOcc unbounded<br/>content complex</p>   |
| <p>children</p>   | <p><a href="#">NavDate</a> <a href="#">Positions</a> <a href="#">Transactions</a> <a href="#">Earnings</a> <a href="#">PositionsDecomposed</a> <a href="#">BreakDowns</a> <a href="#">RiskCodes</a></p>  |
| <p>annotation</p> | <p>documentation<br/>Portfolio data including total net asset values, positions, transactions, breakdowns, ...</p>   |

element **ShareClassType/BlockedInvestorCountries**

|                   |  |
|-------------------|--|
| <p>diagram</p>    | <p><b>BlockedInvestorCountries</b><br/>Investors of these countries cannot buy this share class</p> <p><b>Country</b><br/>1..∞</p> |
| <p>properties</p> | <p>isRef 0<br/>minOcc 0<br/>maxOcc 1<br/>content complex</p>   |

|            |   |
|------------|---|
| children   | <a href="#">Country</a>   |
| annotation | documentation<br>Investors of these countries cannot buy this share class |

element **ShareClassType/BlockedInvestorCountries/Country**

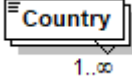
|            |   |
|------------|---|
| diagram    |  A diagram showing a box labeled 'Country' with a small icon to its left. Below the box is the cardinality '1..∞'. |
| type       | <a href="#">ISOCountryCodeType</a>  |
| properties | isRef 0<br>minOcc 1<br>maxOcc unbounded<br>content simple   |
| facets     | Kind Value annotation<br>minLength 2<br>maxLength 2   |

element **ShareClassType/HighWatermark**

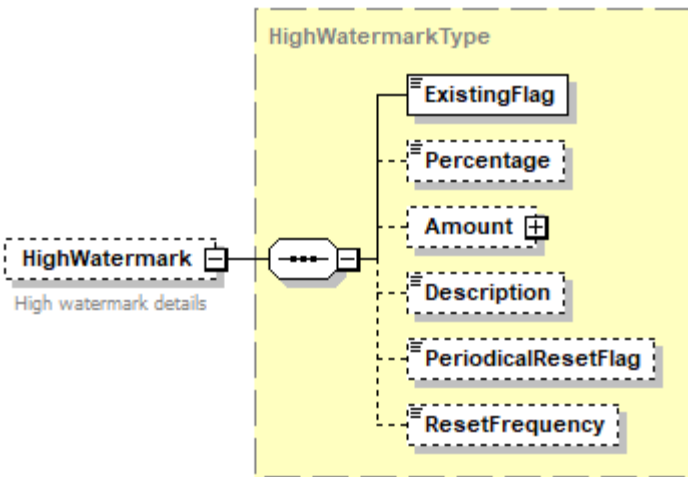
|            |  |
|------------|--|
| diagram    |  A diagram showing a dashed box labeled 'HighWatermark' with the text 'High watermark details' below it. This box is connected to a central circle containing three dots. To the right of this circle is a large yellow dashed box labeled 'HighWatermarkType'. Inside this yellow box are several smaller dashed boxes: 'ExistingFlag', 'Percentage', 'Amount' (with a plus sign icon), 'Description', 'PeriodicalResetFlag', and 'ResetFrequency'. |
| type       | <a href="#">HighWatermarkType</a>  |
| properties | isRef 0<br>minOcc 0<br>maxOcc 1<br>content complex   |
| children   | <a href="#">ExistingFlag</a> <a href="#">Percentage</a> <a href="#">Amount</a> <a href="#">Description</a> <a href="#">PeriodicalResetFlag</a> <a href="#">ResetFrequency</a>  |
| annotation | documentation<br>High watermark details  |

element **ShareClassType/PEA\_EligibleFlag**

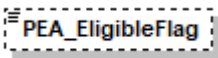
|            |  |
|------------|--|
| diagram    |  A diagram showing a dashed box labeled 'PEA_EligibleFlag' with a small icon to its left. |
| type       | <b>xs:boolean</b>  |
| properties | isRef 0<br>minOcc 0  |

|  |                            |
|--|----------------------------|
|  | maxOcc 1<br>content simple |
|--|----------------------------|

element **ShareClassType/RetailInvestorsOnly**

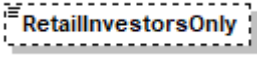
|            |   |
|------------|---|
| diagram    |  |
| type       | <b>xs:boolean</b>   |
| properties | isRef 0<br>minOcc 0<br>maxOcc 1<br>content simple                                 |

element **ShareClassType/UK\_RDR\_Flag**

|            |   |
|------------|---|
| diagram    |  |
| type       | <b>xs:boolean</b>   |
| properties | isRef 0<br>minOcc 0<br>maxOcc 1<br>content simple                                 |
| annotation | documentation<br>Retail only share class according to UK definition               |

element **ShareClassType/TransferAgent**

|            |  |
|------------|--|
| diagram    | <p>The diagram shows the structure of the <b>CompanyType</b> element. It is a complex type containing the following elements:</p> <ul style="list-style-type: none"> <li><b>Identifiers</b>: Identifiers of company</li> <li><b>Name</b>: Name of company</li> <li><b>LegalName</b>: Legal (full) name of company</li> <li><b>LegalForm</b>: Legal form of company</li> <li><b>Address</b>: Address of company</li> <li><b>BusinessCountry</b>: Country code of main business of company</li> <li><b>ParentCompany</b>: Parent company (if applicable)</li> <li><b>OtherClassification</b>: All other identifiers (with listed or free type), with a cardinality of 0..∞.</li> </ul> <p>The <b>TransferAgent</b> element is shown as a dashed box connected to the <b>CompanyType</b> box.</p> |
| type       | <a href="#">CompanyType</a>  |
| properties | <p>isRef 0<br/> minOcc 0<br/> maxOcc 1<br/> content complex</p>  |
| children   | <a href="#">Identifiers</a> <a href="#">Name</a> <a href="#">LegalName</a> <a href="#">LegalForm</a> <a href="#">Address</a> <a href="#">BusinessCountry</a> <a href="#">ParentCompany</a> <a href="#">OtherClassification</a>   |

element **ShareClassType/Investors**

|            |   |
|------------|---|
| diagram    | <p>The diagram shows the structure of the <b>Investors</b> element. It is a complex type containing the following element:</p> <ul style="list-style-type: none"> <li><b>Investor</b>: 1..∞</li> </ul> <p>The <b>Investors</b> element is shown as a dashed box with the text "List of investors" below it, connected to the <b>Investor</b> element.</p> |
| properties | <p>isRef 0<br/> minOcc 0<br/> maxOcc 1<br/> content complex</p>   |
| children   | <a href="#">Investor</a>  |
| annotation | <p>documentation<br/> List of investors</p>   |

element **ShareClassType/Investors/Investor**

|            |   |
|------------|---|
| diagram    |   |
| type       | <a href="#">InvestorType</a>  |
| properties | isRef 0<br>minOcc 1<br>maxOcc unbounded<br>content complex  |
| children   | <a href="#">Date</a> <a href="#">InvestorID</a> <a href="#">InvestorName</a> <a href="#">InvestorCountry</a> <a href="#">InvestorTypes</a> <a href="#">NumberOfShares</a> |

element **ShareClassType/InvestorAllocation**

|            |  |
|------------|--|
| diagram    |  |
| properties | isRef 0<br>minOcc 0<br>maxOcc 1<br>content complex |
| children   | <a href="#">Allocation</a>                         |
| annotation | documentation<br>Breakdown by investor types       |

element **ShareClassType/InvestorAllocation/Allocation**

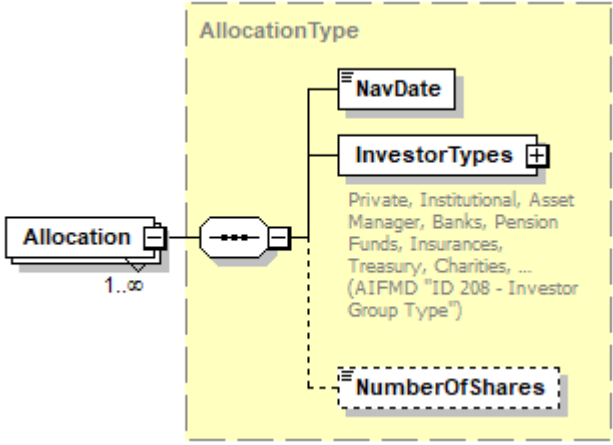
|            |   |
|------------|---|
| diagram    |  <p>The diagram shows the structure of the AllocationType element. An Allocation element (multiplicity 1..∞) is connected to an AllocationType container. Inside AllocationType, there are three child elements: NavDate, InvestorTypes, and NumberOfShares. InvestorTypes is described as 'Private, Institutional, Asset Manager, Banks, Pension Funds, Insurances, Treasury, Charities, ... (AIFMD "ID 208 - Investor Group Type")'. NumberOfShares is shown in a dashed box, indicating it is optional.</p> |
| type       | <a href="#">AllocationType</a>  |
| properties | <p>isRef 0<br/> minOcc 1<br/> maxOcc unbounded<br/> content complex</p>   |
| children   | <a href="#">NavDate</a> <a href="#">InvestorTypes</a> <a href="#">NumberOfShares</a>  |

element **ShareClassType/MarketPlaces**

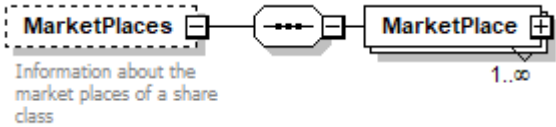
|            |   |
|------------|---|
| diagram    |  <p>The diagram shows the structure of the MarketPlaces element. A MarketPlaces element (multiplicity 1) is connected to a MarketPlace element (multiplicity 1..∞). A note below the diagram states: 'Information about the market places of a share class'.</p> |
| properties | <p>isRef 0<br/> minOcc 0<br/> maxOcc 1<br/> content complex</p>   |
| children   | <a href="#">MarketPlace</a>   |
| annotation | <p>documentation<br/> Information about the market places of a share class</p>  |

element **ShareClassType/MarketPlaces/MarketPlace**

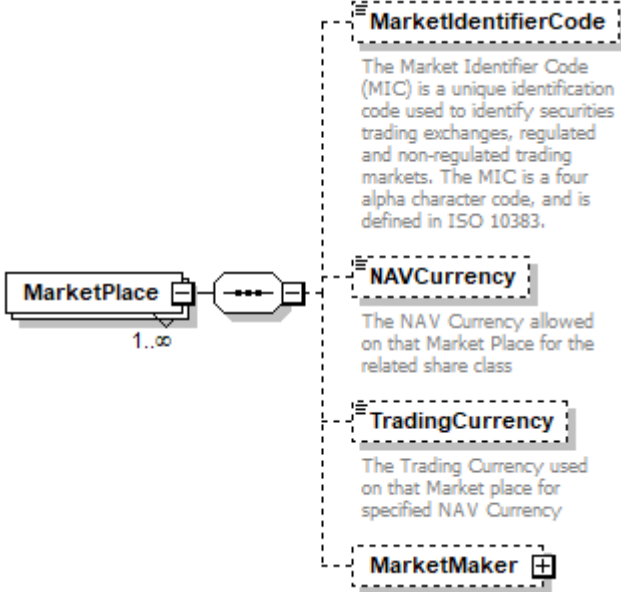
|                   |   |
|-------------------|---|
| <p>diagram</p>    |  <p><b>MarketIdentifierCode</b></p> <p>The Market Identifier Code (MIC) is a unique identification code used to identify securities trading exchanges, regulated and non-regulated trading markets. The MIC is a four alpha character code, and is defined in ISO 10383.</p> <p><b>NAVCurrency</b></p> <p>The NAV Currency allowed on that Market Place for the related share class</p> <p><b>TradingCurrency</b></p> <p>The Trading Currency used on that Market place for specified NAV Currency</p> <p><b>MarketMaker</b> ⊕</p> |
| <p>properties</p> | <p>isRef 0<br/> minOcc 1<br/> maxOcc unbounded<br/> content complex</p>   |
| <p>children</p>   | <p><a href="#">MarketIdentifierCode</a> <a href="#">NAVCurrency</a> <a href="#">TradingCurrency</a> <a href="#">MarketMaker</a></p>   |

element **ShareClassType/MarketPlaces/MarketPlace/MarketIdentifierCode**

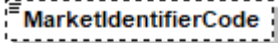
|                   |   |
|-------------------|---|
| <p>diagram</p>    |  <p><b>MarketIdentifierCode</b></p> <p>The Market Identifier Code (MIC) is a unique identification code used to identify securities trading exchanges, regulated and non-regulated trading markets. The MIC is a four alpha character code, and is defined in ISO 10383.</p> |
| <p>type</p>       | <p>restriction of <b>xs:string</b></p>  |
| <p>properties</p> | <p>isRef 0<br/> minOcc 0<br/> maxOcc 1<br/> content simple</p>  |
| <p>facets</p>     | <p>Kind Value annotation<br/> length 4</p>  |
| <p>annotation</p> | <p>documentation<br/> The Market Identifier Code (MIC) is a unique identification code used to identify securities trading exchanges, regulated and non-regulated trading markets. The MIC is a four alpha character code, and is defined in ISO 10383.</p>   |

element **ShareClassType/MarketPlaces/MarketPlace/NAVCurrency**

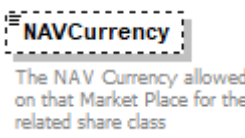
|            |  |
|------------|--|
| diagram    |           |
| type       | <a href="#">ISOCurrencyCodeType</a>  |
| properties | isRef 0<br>minOcc 0<br>maxOcc 1<br>content simple  |
| facets     | Kind Value annotation<br>minLength 3<br>maxLength 3<br>pattern [A-Z]{3}                    |
| annotation | documentation<br>The NAV Currency allowed on that Market Place for the related share class |

element **ShareClassType/MarketPlaces/MarketPlace/TradingCurrency**

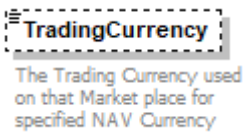
|            |  |
|------------|--|
| diagram    |           |
| type       | <a href="#">ISOCurrencyCodeType</a>  |
| properties | isRef 0<br>minOcc 0<br>maxOcc 1<br>content simple  |
| facets     | Kind Value annotation<br>minLength 3<br>maxLength 3<br>pattern [A-Z]{3}                    |
| annotation | documentation<br>The Trading Currency used on that Market place for specified NAV Currency |

element **ShareClassType/MarketPlaces/MarketPlace/MarketMaker**

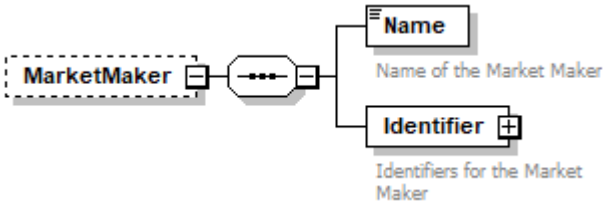
|            |   |
|------------|---|
| diagram    |  |
| properties | isRef 0<br>minOcc 0<br>maxOcc 1<br>content complex                                  |
| children   | <a href="#">Name</a> <a href="#">Identifier</a>                                     |



element **ShareClassType/MarketPlaces/MarketPlace/MarketMaker/Name**

|            |   |
|------------|---|
| diagram    |  |
| type       | <b>xs:string</b>  |
| properties | isRef 0<br>content simple   |
| annotation | documentation<br>Name of the Market Maker   |

element **ShareClassType/MarketPlaces/MarketPlace/MarketMaker/Identifier**

diagram

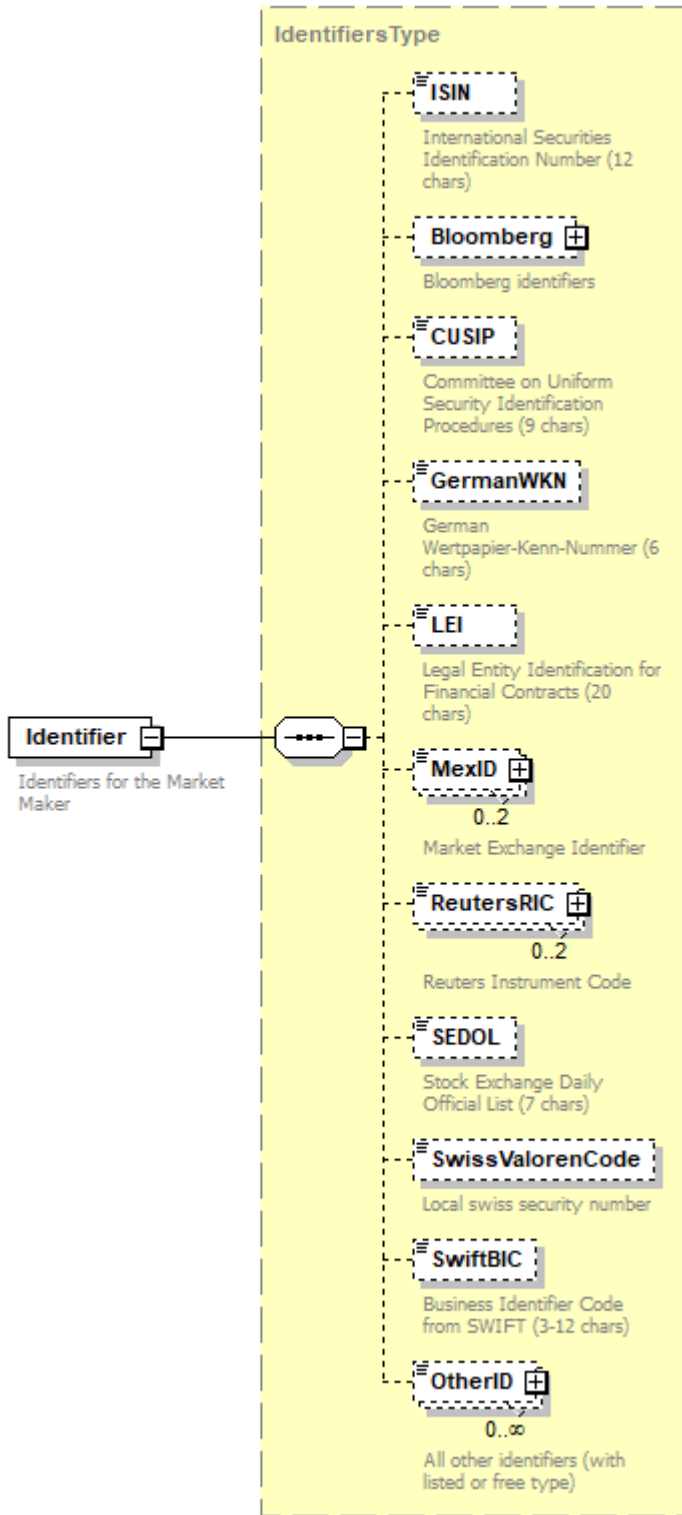

|            |   |
|------------|---|
| type       | <a href="#">IdentifiersType</a>   |
| properties | isRef 0<br>content complex  |
| children   | <a href="#">ISIN</a> <a href="#">Bloomberg</a> <a href="#">CUSIP</a> <a href="#">GermanWKN</a> <a href="#">LEI</a> <a href="#">MexID</a> <a href="#">ReutersRIC</a> <a href="#">SEDOL</a> <a href="#">SwissValorenCode</a> <a href="#">SwiftBIC</a> <a href="#">OtherID</a> |

|            |   |
|------------|---|
| annotation | documentation<br>Identifiers for the Market Maker |
|------------|---|

element **ShareClassType/CustomAttributes**

|            |   |
|------------|---|
| diagram    | <p>Generic structure for custom specific data which cannot be stored somewhere else</p>           |
| type       | <a href="#">AttributesType</a>  |
| properties | isRef 0<br>minOcc 0<br>maxOcc 1<br>content complex  |
| children   | <a href="#">Attribute</a>   |
| annotation | documentation<br>Generic structure for custom specific data which cannot be stored somewhere else |

element **ShareClassType/CountrySpecificData**

|            |  |
|------------|--|
| diagram    |  |
| type       | <a href="#">CountrySpecificShareClassDataType</a>  |
| properties | isRef 0<br>minOcc 0<br>maxOcc 1<br>content complex |

|          |   |
|----------|---|
| children | <a href="#">AT</a> <a href="#">DE</a> <a href="#">DK</a> <a href="#">FR</a> <a href="#">LU</a> <a href="#">NL</a> |
|----------|---|

complexType **TotalReturn**Type

|          |  |
|----------|--|
| diagram  |  |
| children | <a href="#">Currency</a> <a href="#">Value</a> <a href="#">ValidityDate</a> <a href="#">CalculationPeriod</a> <a href="#">AnnualizedFlag</a> <a href="#">CalculationMethod</a> <a href="#">Investment</a> <a href="#">StartCalculationDate</a> <a href="#">CorrectionCoefficient</a> <a href="#">ReinvestmentCoefficient</a> |
| used by  | element <a href="#">PerformanceFiguresType/TotalReturns/TotalReturn</a>  |

element **TotalReturn**Type/Currency

|            |   |
|------------|---|
| diagram    |   |
| type       | <a href="#">ISOCurrencyCodeType</a>                                     |
| properties | isRef 0<br>content simple   |
| facets     | Kind Value annotation<br>minLength 3<br>maxLength 3<br>pattern [A-Z]{3} |

element **TotalReturnType/Value**

|            |   |
|------------|---|
| diagram    |   |
| properties | isRef 0<br>content complex  |
| children   | <a href="#">AbsoluteValue</a> <a href="#">PercentageValue</a> <a href="#">AbsoluteValue</a> |
| annotation | documentation<br>Absolute and/or percentage value   |

element **TotalReturnType/Value/AbsoluteValue**

|            |                           |
|------------|---------------------------|
| diagram    |                           |
| type       | <b>xs:decimal</b>         |
| properties | isRef 0<br>content simple |

element **TotalReturnType/Value/PercentageValue**

|            |                                |
|------------|--------------------------------|
| diagram    |                                |
| type       | <a href="#">PercentageType</a> |
| properties | isRef 0<br>content simple      |

element **TotalReturnType/Value/AbsoluteValue**

|            |   |
|------------|---|
| diagram    |   |
| type       | <b>xs:decimal</b>                                 |
| properties | isRef 0<br>minOcc 0<br>maxOcc 1<br>content simple |

element **TotalReturnType/ValidityDate**

|            |                           |
|------------|---------------------------|
| diagram    |                           |
| type       | <b>xs:date</b>            |
| properties | isRef 0<br>content simple |

element **TotalReturn/CalculationPeriod**

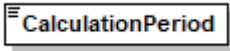
|            |   |
|------------|---|
| diagram    |  |
| type       | <a href="#">CalculationPeriodType</a>   |
| properties | isRef 0<br>content simple   |

element **TotalReturn/AnnualizedFlag**

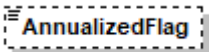
|            |   |
|------------|---|
| diagram    |  |
| type       | xs:boolean  |
| properties | isRef 0<br>minOcc 0<br>maxOcc 1<br>content simple                                 |

element **TotalReturn/CalculationMethod**

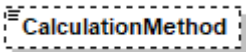
|            |   |
|------------|---|
| diagram    |  |
| type       | <a href="#">Text500Type</a>   |
| properties | isRef 0<br>minOcc 0<br>maxOcc 1<br>content simple                                 |
| facets     | Kind Value annotation<br>maxLength 500  |

element **TotalReturn/Investment**

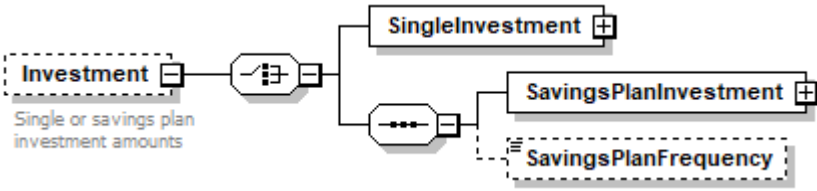
|            |   |
|------------|---|
| diagram    |                         |
| properties | isRef 0<br>minOcc 0<br>maxOcc 1<br>content complex  |
| children   | <a href="#">SingleInvestment</a> <a href="#">SavingsPlanInvestment</a> <a href="#">SavingsPlanFrequency</a> |
| annotation | documentation<br>Single or savings plan investment amounts  |

element **TotalReturnType/Investment/SingleInvestment**

|            |  |
|------------|--|
| diagram    | <p>The diagram shows a box labeled 'SingleInvestment' connected to a dashed box labeled 'FundAmountType'. Inside 'FundAmountType', there is a box labeled 'Amount' with a cardinality of '1..∞'. Below the 'Amount' box, a note reads 'Amounts in currency as defined in attribute'.</p> |
| type       | <a href="#">FundAmountType</a>   |
| properties | isRef 0<br>content complex   |
| children   | <a href="#">Amount</a>   |

element **TotalReturnType/Investment/SavingsPlanInvestment**

|            |   |
|------------|---|
| diagram    | <p>The diagram shows a box labeled 'SavingsPlanInvestment' connected to a dashed box labeled 'FundAmountType'. Inside 'FundAmountType', there is a box labeled 'Amount' with a cardinality of '1..∞'. Below the 'Amount' box, a note reads 'Amounts in currency as defined in attribute'.</p> |
| type       | <a href="#">FundAmountType</a>  |
| properties | isRef 0<br>content complex  |
| children   | <a href="#">Amount</a>  |

element **TotalReturnType/Investment/SavingsPlanFrequency**

|            |   |
|------------|---|
| diagram    | <p>The diagram shows a dashed box containing the text 'SavingsPlanFrequency'.</p> |
| type       | <a href="#">FrequencyType</a>   |
| properties | isRef 0<br>minOcc 0<br>maxOcc 1<br>content simple                                 |

element **TotalReturnType/StartCalculationDate**

|            |   |
|------------|---|
| diagram    | <p>The diagram shows a dashed box containing the text 'StartCalculationDate'.</p> |
| type       | <b>xs:date</b>  |
| properties | isRef 0<br>minOcc 0<br>maxOcc 1<br>content simple                                 |

element **TotalReturn/CorrectionCoefficient**

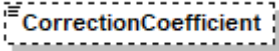
|            |   |
|------------|---|
| diagram    |  |
| type       | <b>xs:decimal</b>   |
| properties | isRef 0<br>minOcc 0<br>maxOcc 1<br>content simple                                 |

element **TotalReturn/ReinvestmentCoefficient**

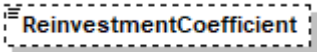
|            |   |
|------------|---|
| diagram    |  |
| type       | <b>xs:decimal</b>   |
| properties | isRef 0<br>minOcc 0<br>maxOcc 1<br>content simple                                 |

simpleType **CalculationPeriodType**

|            |  |
|------------|--|
| type       | restriction of <b>xs:string</b>  |
| properties | base <b>xs:string</b>  |
| used by    | elements <a href="#">TotalReturn/CalculationPeriod</a> <a href="#">PerformanceType/CalculationPeriod</a> |

simpleType **DateIntervalType**

|            |  |
|------------|--|
| type       | restriction of <b>xs:string</b>                      |
| properties | base <b>xs:string</b>                                |
| used by    | element <a href="#">PerformanceType/DateInterval</a> |



## complexType AccountType

|            |  |
|------------|--|
| diagram    |  |
| children   | <a href="#">IndicatorCreditDebit</a> <a href="#">AccountNumber</a> <a href="#">InterestRateDebit</a> <a href="#">InterestRateCredit</a> <a href="#">Counterparty</a> |
| used by    | element <a href="#">AssetDetailsType/Account</a>   |
| annotation | documentation<br>Master data of accounts   |

## element AccountType/IndicatorCreditDebit

|            |  |
|------------|--|
| diagram    |  |
| type       | restriction of <b>xs:string</b>  |
| properties | isRef 0<br>minOcc 0<br>maxOcc 1<br>content simple  |
| annotation | documentation<br>Account balance set as default<br>documentation<br>Gibt an ob das Konto default einen Soll oder Habensaldo aufweist |

## element AccountType/AccountNumber

|            |   |
|------------|---|
| diagram    |   |
| type       | <b>xs:integer</b>   |
| properties | isRef 0<br>minOcc 0<br>maxOcc 1<br>content simple   |
| annotation | documentation<br>Account number used for booking procedure<br>documentation<br>Gibt das bei einer Buchung verwendete Konto an |

element **AccountType/InterestRateDebit**

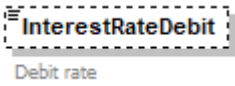
|            |   |
|------------|---|
| diagram    |  |
| type       | <b>xs:decimal</b>   |
| properties | isRef 0<br>minOcc 0<br>maxOcc 1<br>content simple                                 |
| annotation | documentation<br><b>Debit rate</b><br>documentation<br>Zinssatz Soll              |

element **AccountType/InterestRateCredit**

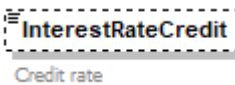
|            |   |
|------------|---|
| diagram    |  |
| type       | <b>xs:decimal</b>   |
| properties | isRef 0<br>minOcc 0<br>maxOcc 1<br>content simple                                 |
| annotation | documentation<br><b>Credit rate</b><br>documentation<br>Zinssatz Haben            |

element **AccountType/Counterparty**

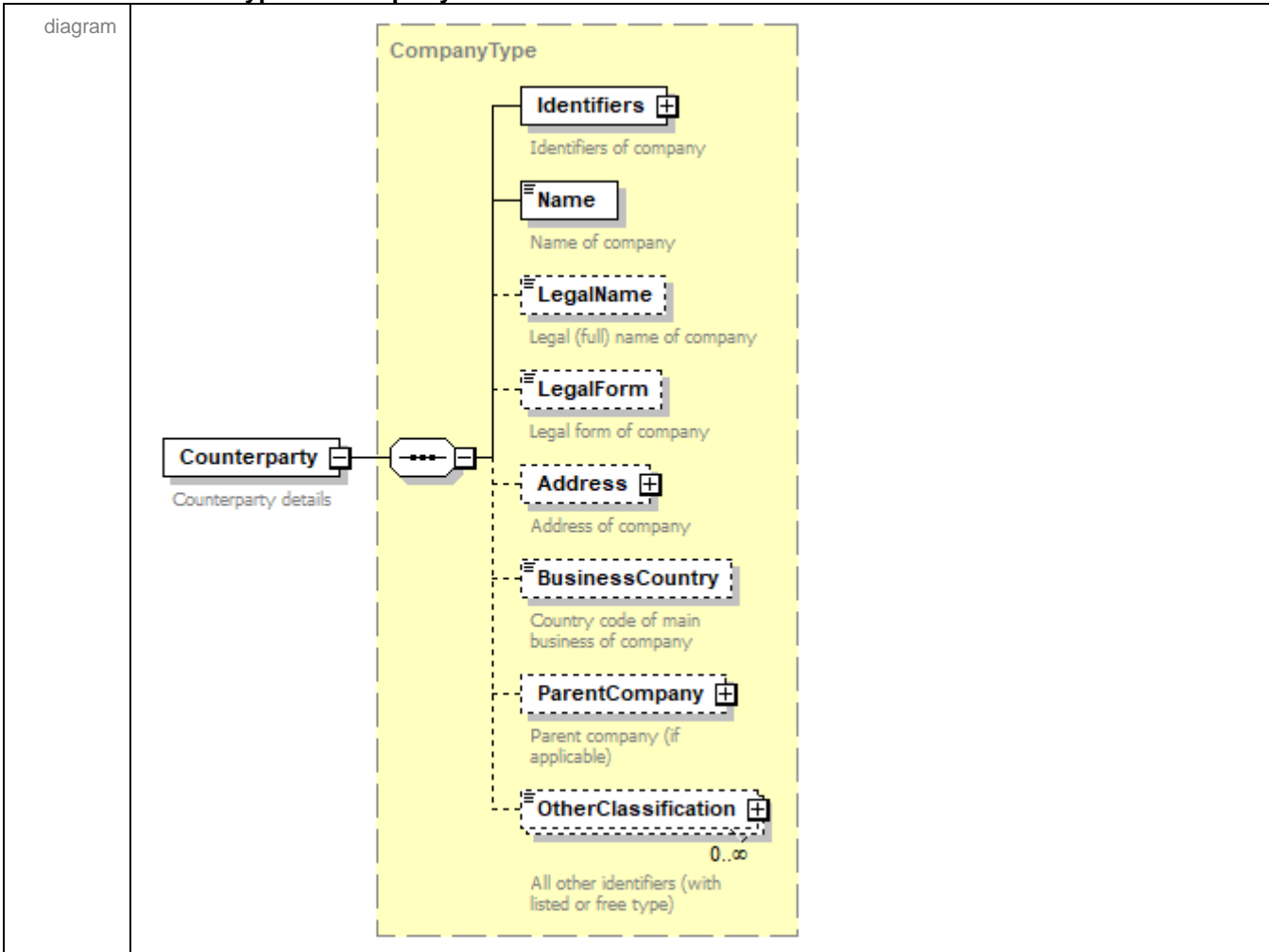

|            |  |
|------------|--|
| type       | <a href="#">CompanyType</a>  |
| properties | isRef 0<br>content complex   |
| children   | <a href="#">Identifiers</a> <a href="#">Name</a> <a href="#">LegalName</a> <a href="#">LegalForm</a> <a href="#">Address</a> <a href="#">BusinessCountry</a> <a href="#">ParentCompany</a> <a href="#">OtherClassification</a> |
| annotation | documentation<br>Counterparty details  |

# complexType AssetDetailsType

diagram

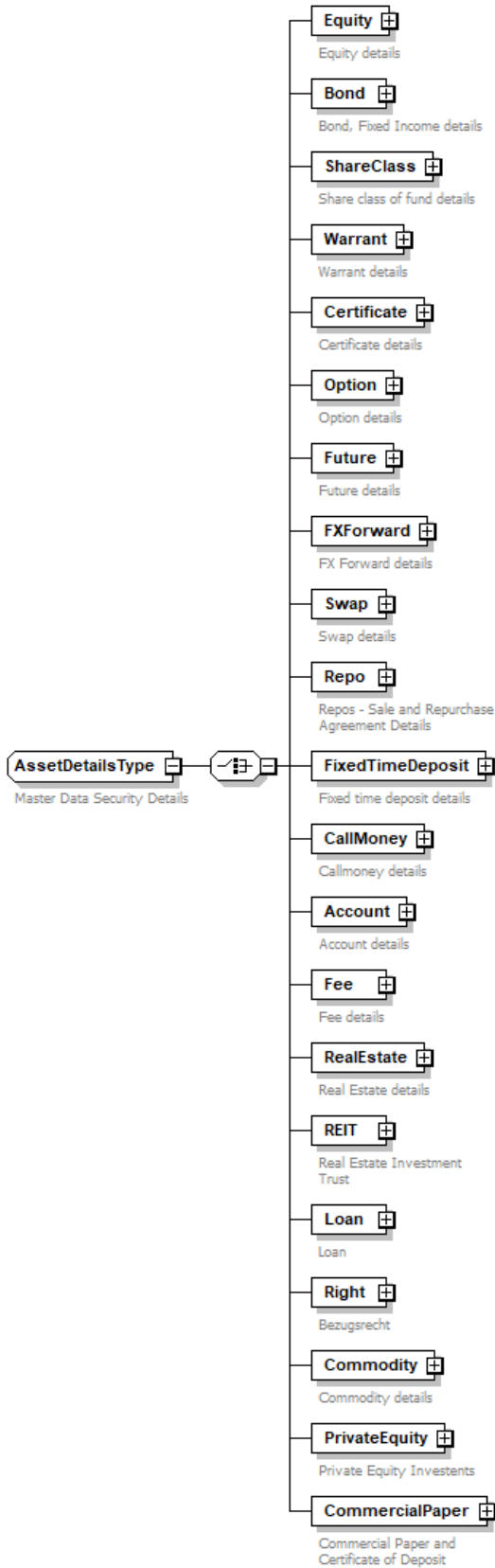

|            |  |
|------------|--|
| children   | <a href="#">Equity</a> <a href="#">Bond</a> <a href="#">ShareClass</a> <a href="#">Warrant</a> <a href="#">Certificate</a> <a href="#">Option</a> <a href="#">Future</a> <a href="#">FXForward</a> <a href="#">Swap</a> <a href="#">Repo</a> <a href="#">FixedTimeDeposit</a> <a href="#">CallMoney</a> <a href="#">Account</a> <a href="#">Fee</a> <a href="#">RealEstate</a> <a href="#">REIT</a> <a href="#">Loan</a> <a href="#">Right</a> <a href="#">Commodity</a> <a href="#">PrivateEquity</a> <a href="#">CommercialPaper</a> |
| used by    | element <a href="#">AssetType/AssetDetails</a>   |
| annotation | documentation<br>Master Data Security Details  |

element **AssetDetailsType/Equity**

diagram

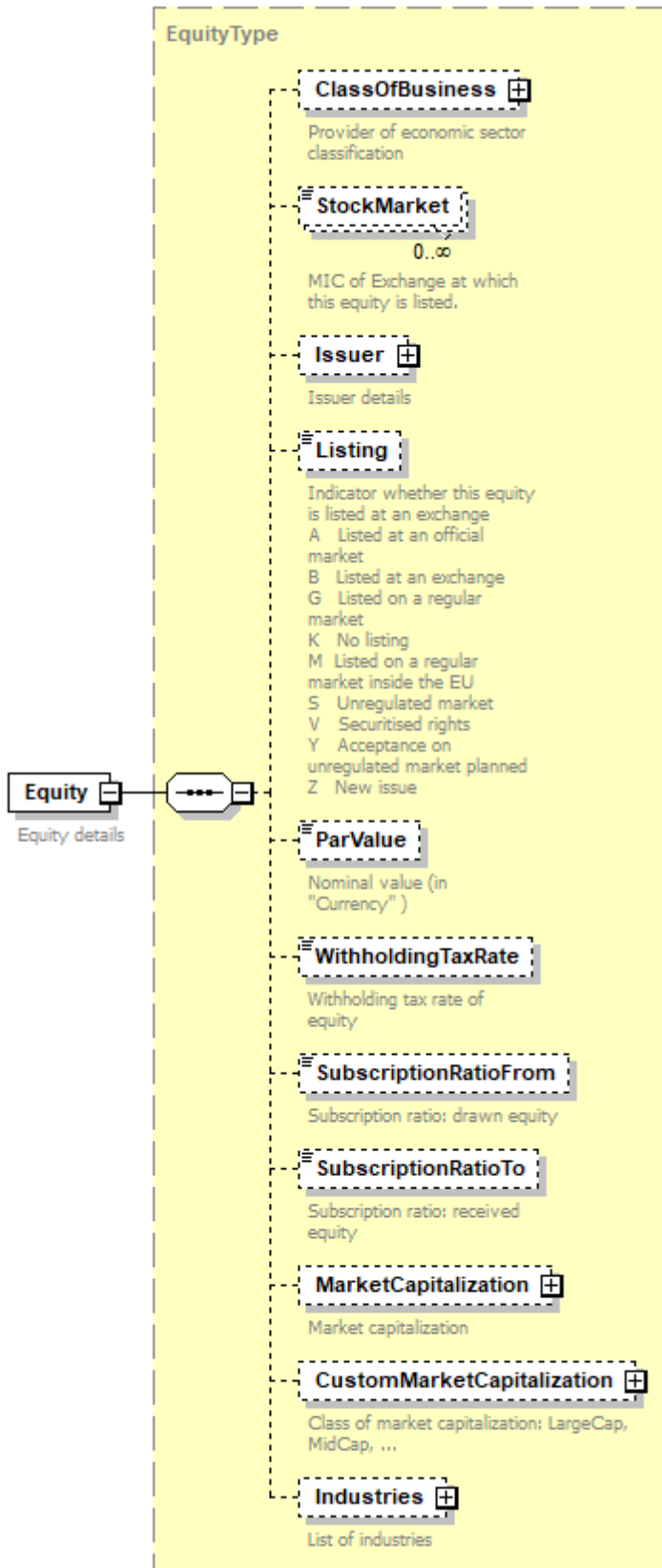

|            |  |
|------------|--|
| type       | <a href="#">EquityType</a>   |
| properties | isRef 0<br>content complex   |
| children   | <a href="#">ClassOfBusiness</a> <a href="#">StockMarket</a> <a href="#">Issuer</a> <a href="#">Listing</a> <a href="#">ParValue</a> <a href="#">WithholdingTaxRate</a> <a href="#">SubscriptionRatioFrom</a><br><a href="#">SubscriptionRatioTo</a> <a href="#">MarketCapitalization</a> <a href="#">CustomMarketCapitalization</a> <a href="#">Industries</a> |
| annotation | documentation<br>Equity details<br>documentation<br>Aktie  |

# element AssetDetailsType/Bond

diagram

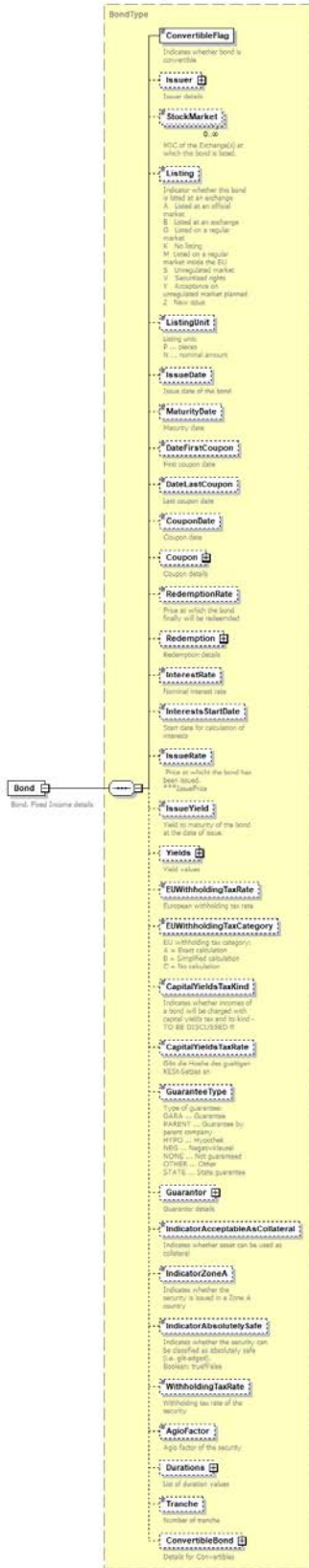



|            |   |
|------------|---|
| type       | <a href="#">BondType</a>  |
| properties | isRef 0<br>content complex  |
| children   | <a href="#">ConvertibleFlag</a> <a href="#">Issuer</a> <a href="#">StockMarket</a> <a href="#">Listing</a> <a href="#">ListingUnit</a> <a href="#">IssueDate</a> <a href="#">MaturityDate</a> <a href="#">DateFirstCoupon</a> <a href="#">DateLastCoupon</a> <a href="#">CouponDate</a> <a href="#">Coupon</a> <a href="#">RedemptionRate</a> <a href="#">Redemption</a> <a href="#">InterestRate</a> <a href="#">InterestsStartDate</a> <a href="#">IssueRate</a> <a href="#">IssueYield</a> <a href="#">Yields</a> <a href="#">EUWithholdingTaxRate</a> <a href="#">EUWithholdingTaxCategory</a> <a href="#">CapitalYieldsTaxKind</a> <a href="#">CapitalYieldsTaxRate</a> <a href="#">GuaranteeType</a> <a href="#">Guarantor</a> <a href="#">IndicatorAcceptableAsCollateral</a> <a href="#">IndicatorZoneA</a> <a href="#">IndicatorAbsolutelySafe</a> <a href="#">WithholdingTaxRate</a> <a href="#">AgioFactor</a> <a href="#">Durations</a> <a href="#">Tranche</a> <a href="#">ConvertibleBond</a> |
| annotation | documentation<br>Bond, Fixed Income details<br>documentation<br>Rente   |

element **AssetDetailsType/ShareClass**

|                   |   |
|-------------------|---|
| <p>diagram</p>    | <p>The diagram illustrates the structure of the <b>ShareClass</b> element. It is a simple type (represented by a rectangle with a small square on the right) that contains a complex type reference (represented by a rectangle with a small square on the right and a dashed line with three dots on the left) to the <b>ShareClassDetailsType</b>. The <b>ShareClassDetailsType</b> is shown as a large dashed yellow box containing several child elements, each in a dashed box:</p> <ul style="list-style-type: none"> <li><b>Issuer</b> (+): Issuer details</li> <li><b>StockMarket</b>: Exchange(s) at which this share class is listed. (0..∞)</li> <li><b>Listing</b>: Indicator whether this share class is listed at an exchange.             <ul style="list-style-type: none"> <li>A Listed at an official market</li> <li>B Listed at an exchange</li> <li>G Listed on a regular market</li> <li>K No listing</li> <li>M Listed on a regular market inside the EU</li> <li>S Unregulated market</li> <li>V Securitised rights</li> <li>Y Acceptance on unregulated market planned</li> <li>Z New issue</li> </ul> </li> <li><b>ListingUnit</b>: U = Unit or N = Nominale</li> <li><b>IssueDate</b>: Issue date of the share class</li> <li><b>MaturityDate</b>: Maturity date</li> <li><b>WithholdingTaxRate</b>: Withholding tax rate of the security</li> <li><b>ShareClassType</b> (+)</li> <li><b>ExchangeTradedFundFlag</b></li> </ul> |
| <p>type</p>       | <p><a href="#">ShareClassDetailsType</a></p>  |
| <p>properties</p> | <p>isRef 0<br/>content complex</p>  |
| <p>children</p>   | <p><a href="#">Issuer</a> <a href="#">StockMarket</a> <a href="#">Listing</a> <a href="#">ListingUnit</a> <a href="#">IssueDate</a> <a href="#">MaturityDate</a> <a href="#">WithholdingTaxRate</a> <a href="#">ShareClassType</a> <a href="#">ExchangeTradedFundFlag</a></p>   |
| <p>annotation</p> | <p>documentation<br/>Share class of fund details<br/>documentation<br/>Anteilschein eines Fonds</p>   |



element **AssetDetailsType/Warrant**

diagram

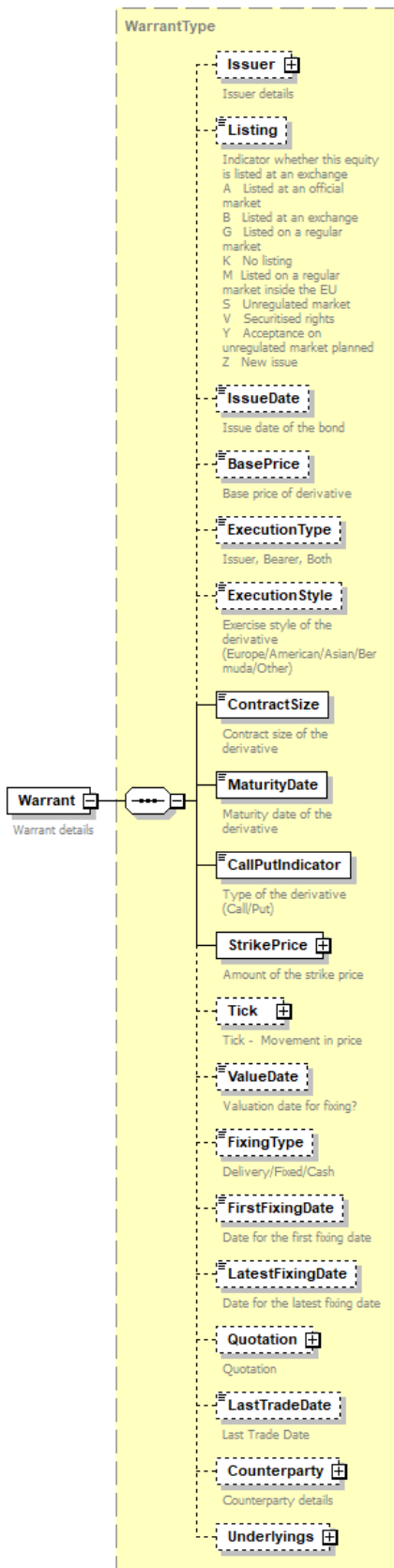

|            |  |
|------------|--|
| type       | <a href="#">WarrantType</a>  |
| properties | isRef 0<br>content complex   |
| children   | <a href="#">Issuer Listing</a> <a href="#">IssueDate</a> <a href="#">BasePrice</a> <a href="#">ExecutionType</a> <a href="#">ExecutionStyle</a> <a href="#">ContractSize</a> <a href="#">MaturityDate</a> <a href="#">CallPutIndicator</a> <a href="#">StrikePrice</a> <a href="#">Tick</a> <a href="#">ValueDate</a> <a href="#">FixingType</a> <a href="#">FirstFixingDate</a> <a href="#">LatestFixingDate</a> <a href="#">Quotation</a> <a href="#">LastTradeDate</a> <a href="#">Counterparty</a> <a href="#">Underlyings</a> |
| annotation | documentation<br>Warrant details   |

element **AssetDetailsType/Certificate**

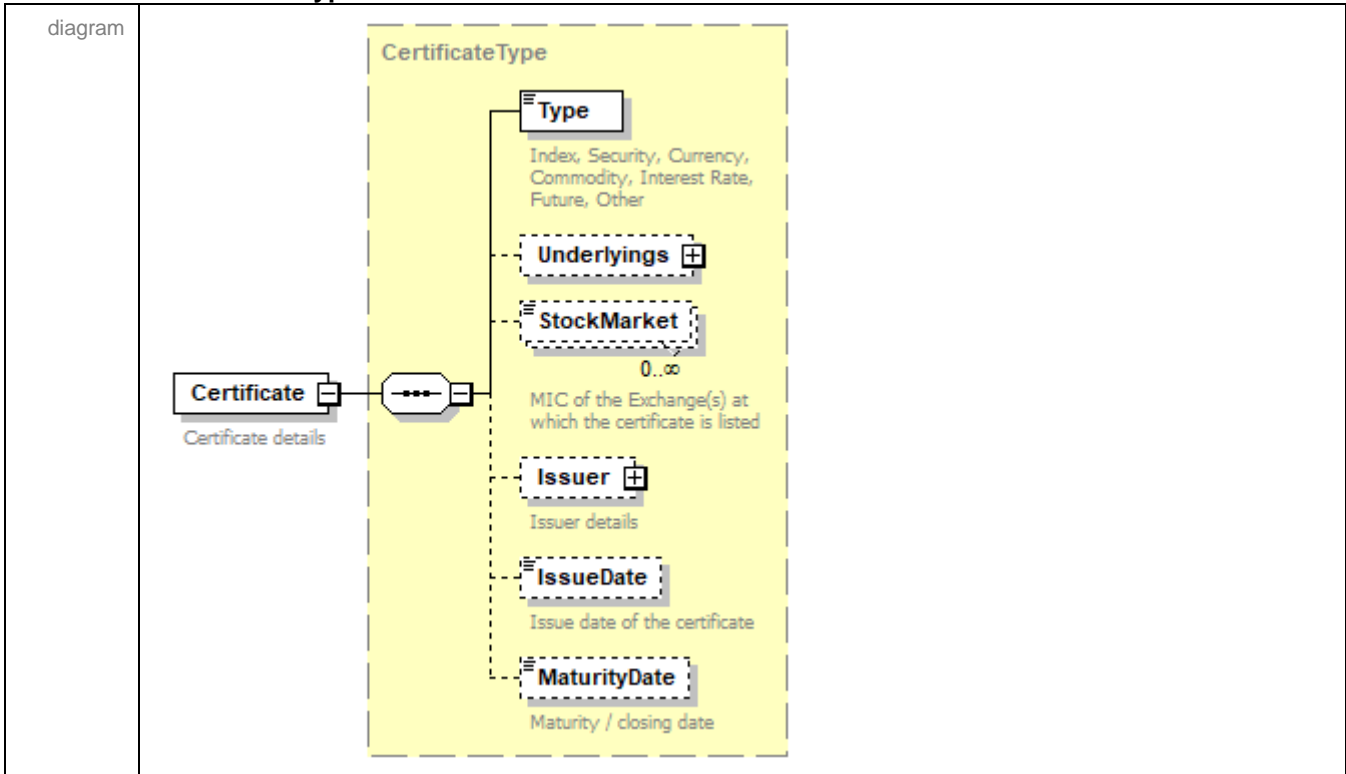

|            |  |
|------------|--|
| type       | <a href="#">CertificateType</a>  |
| properties | isRef 0<br>content complex   |
| children   | <a href="#">Type</a> <a href="#">Underlyings</a> <a href="#">StockMarket</a> <a href="#">Issuer</a> <a href="#">IssueDate</a> <a href="#">MaturityDate</a> |
| annotation | documentation<br>Certificate details<br>documentation<br>Indezertifikat  |

# element AssetDetailsType/Option

diagram

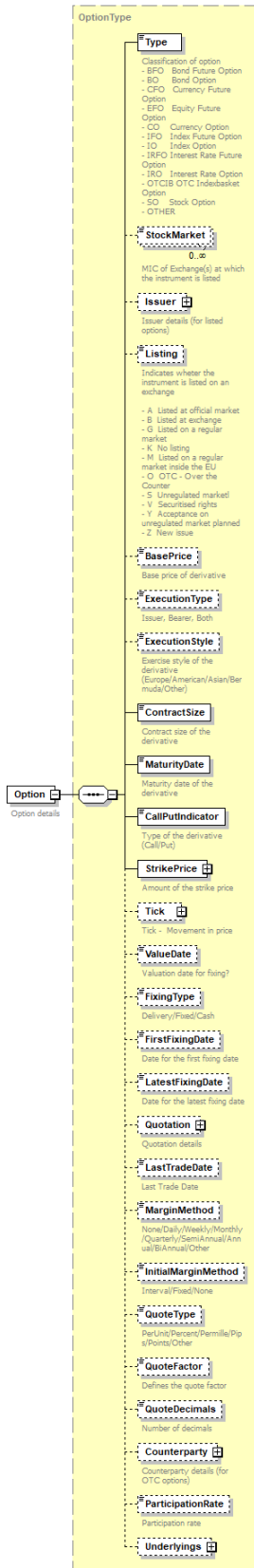

|            |  |
|------------|--|
| type       | <a href="#">OptionType</a>   |
| properties | isRef 0<br>content complex   |
| children   | <a href="#">Type</a> <a href="#">StockMarket</a> <a href="#">Issuer</a> <a href="#">Listing</a> <a href="#">BasePrice</a> <a href="#">ExecutionType</a> <a href="#">ExecutionStyle</a> <a href="#">ContractSize</a> <a href="#">MaturityDate</a> <a href="#">CallPutIndicator</a> <a href="#">StrikePrice</a> <a href="#">Tick</a> <a href="#">ValueDate</a> <a href="#">FixingType</a> <a href="#">FirstFixingDate</a> <a href="#">LatestFixingDate</a> <a href="#">Quotation</a> <a href="#">LastTradeDate</a> <a href="#">MarginMethod</a> <a href="#">InitialMarginMethod</a> <a href="#">QuoteType</a> <a href="#">QuoteFactor</a> <a href="#">QuoteDecimals</a> <a href="#">Counterparty</a> <a href="#">ParticipationRate</a> <a href="#">Underlyings</a> |
| annotation | documentation<br>Option details<br>documentation<br>Option   |



element **AssetDetailsType/Future**

diagram

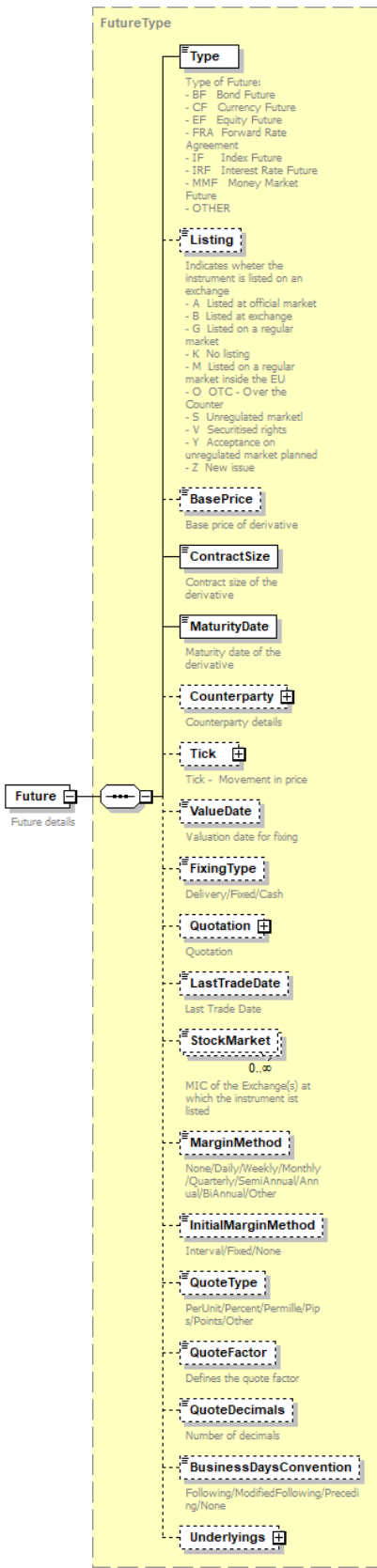

|            |   |
|------------|---|
| type       | <a href="#">FutureType</a>  |
| properties | isRef 0<br>content complex  |
| children   | <a href="#">Type Listing</a> <a href="#">BasePrice</a> <a href="#">ContractSize</a> <a href="#">MaturityDate</a> <a href="#">Counterparty</a> <a href="#">Tick</a> <a href="#">ValueDate</a> <a href="#">FixingType</a> <a href="#">Quotation</a> <a href="#">LastTradeDate</a> <a href="#">StockMarket</a> <a href="#">MarginMethod</a> <a href="#">InitialMarginMethod</a> <a href="#">QuoteType</a> <a href="#">QuoteFactor</a> <a href="#">QuoteDecimals</a> <a href="#">BusinessDaysConvention</a> <a href="#">Underlyings</a> |
| annotation | documentation<br>Future details<br>documentation<br>Unbedingtes Termingeschäft  |

element **AssetDetailsType/FXForward**

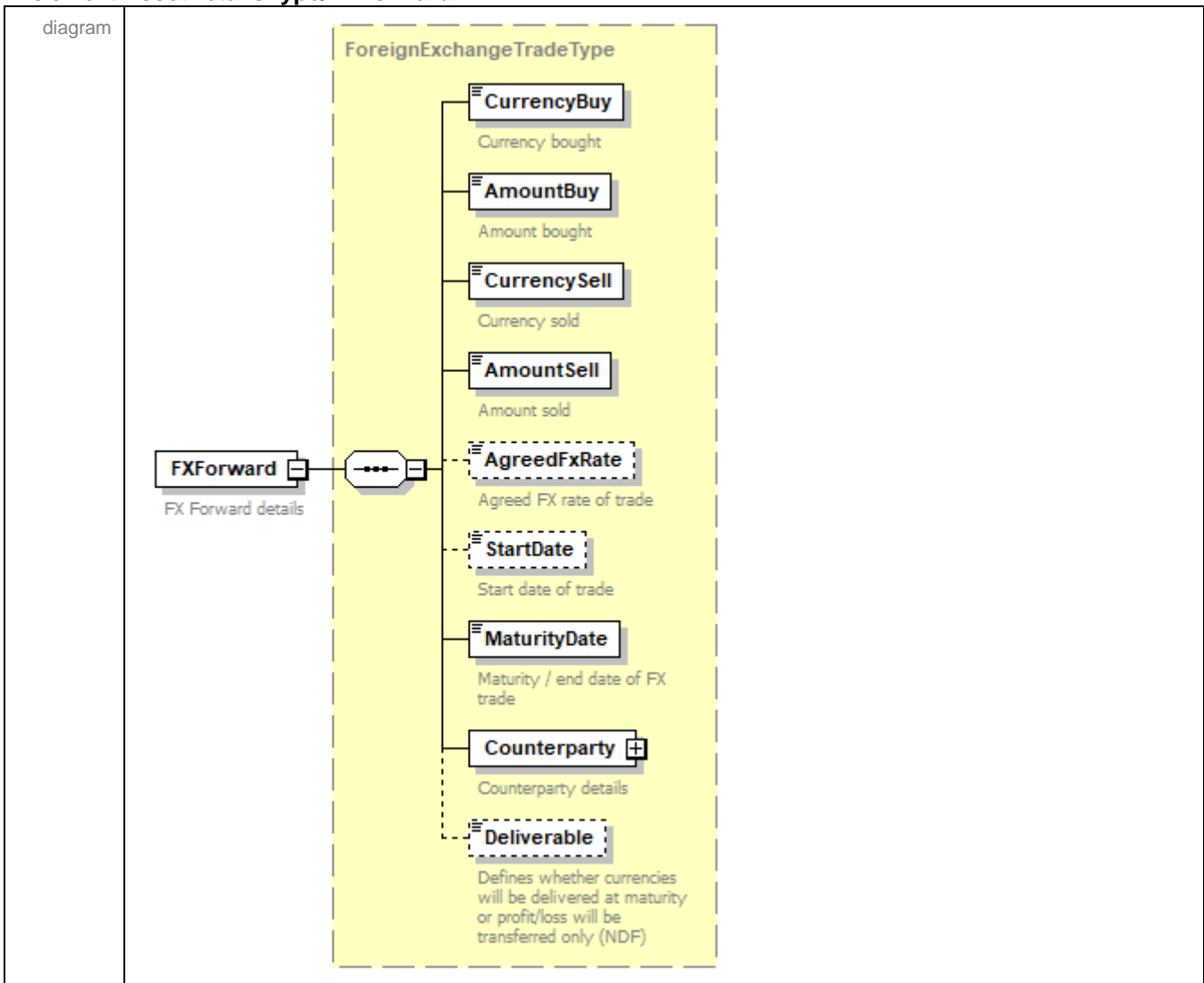

|            |  |
|------------|--|
| type       | <a href="#">ForeignExchangeTradeType</a>   |
| properties | isRef 0<br>content complex   |
| children   | <a href="#">CurrencyBuy</a> <a href="#">AmountBuy</a> <a href="#">CurrencySell</a> <a href="#">AmountSell</a> <a href="#">AgreedFxRate</a> <a href="#">StartDate</a> <a href="#">MaturityDate</a> <a href="#">Counterparty</a> <a href="#">Deliverable</a> |
| annotation | documentation<br>FX Forward details<br>documentation   |

element **AssetDetailsType/Swap**

|                   |  |
|-------------------|--|
| <p>diagram</p>    | <p>The diagram shows a class hierarchy where 'Swap' is a specialization of 'SwapType'. 'SwapType' is a complex type containing several elements: 'Type', 'StartDate', 'MaturityDate', 'SettlementDate', 'Counterparty', and 'Legs'. 'Type' is a simple type, while 'StartDate', 'SettlementDate', and 'Legs' are complex types. 'Counterparty' and 'Legs' are also complex types. 'Swap' is a simple type that inherits from 'SwapType'.</p> |
| <p>type</p>       | <p><a href="#">SwapType</a></p>  |
| <p>properties</p> | <p>isRef 0<br/>content complex</p>   |
| <p>children</p>   | <p><a href="#">Type</a> <a href="#">StartDate</a> <a href="#">MaturityDate</a> <a href="#">SettlementDate</a> <a href="#">Counterparty</a> <a href="#">Legs</a></p>  |
| <p>annotation</p> | <p>documentation<br/>Swap details</p>  |

element **AssetDetailsType/Repo**

diagram

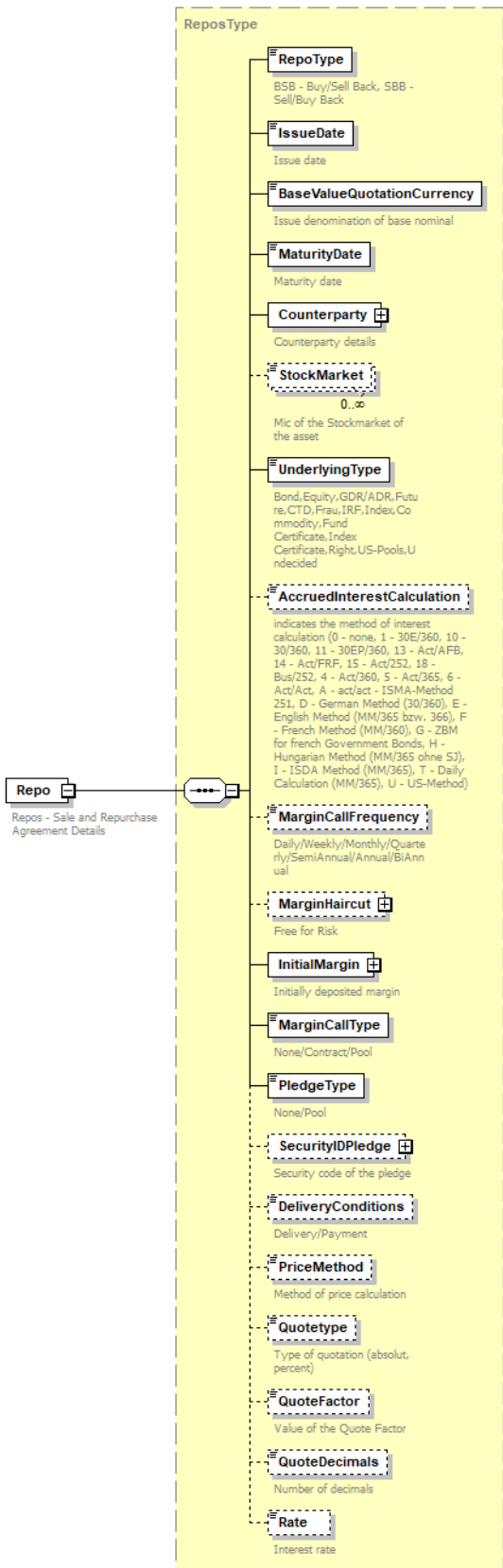

|            |  |
|------------|--|
| type       | <a href="#">ReposType</a>  |
| properties | isRef 0<br>content complex   |
| children   | <a href="#">RepoType</a> <a href="#">IssueDate</a> <a href="#">BaseValueQuotationCurrency</a> <a href="#">MaturityDate</a> <a href="#">Counterparty</a> <a href="#">StockMarket</a> <a href="#">UnderlyingType</a> <a href="#">AccruedInterestCalculation</a> <a href="#">MarginCallFrequency</a> <a href="#">MarginHaircut</a> <a href="#">InitialMargin</a> <a href="#">MarginCallType</a> <a href="#">PledgeType</a> <a href="#">SecurityIDPledge</a> <a href="#">DeliveryConditions</a> <a href="#">PriceMethod</a> <a href="#">Quotetype</a> <a href="#">QuoteFactor</a> <a href="#">QuoteDecimals</a> <a href="#">Rate</a> |
| annotation | documentation<br>Repos - Sale and Repurchase Agreement Details   |

element **AssetDetailsType/FixedTimeDeposit**

|            |  |
|------------|--|
| diagram    | <pre> classDiagram     class FixedTimeDeposit {         Fixed time deposit details     }     class FixedTimeDepositType {         StartDate         MaturityDate         MethodForCalculationOfInterest         InterestRate         InterestRateDebit         InterestRateCredit         IndicatorCreditDebit         Counterparty     }     FixedTimeDeposit &lt; -- FixedTimeDepositType     </pre> <p>The diagram illustrates the relationship between <b>FixedTimeDeposit</b> and <b>FixedTimeDepositType</b>. <b>FixedTimeDeposit</b> is the base class, and <b>FixedTimeDepositType</b> is a specialization. The specialization includes the following attributes:</p> <ul style="list-style-type: none"> <li><b>StartDate</b>: Start date of deposit</li> <li><b>MaturityDate</b>: Maturity date of deposit</li> <li><b>MethodForCalculationOfInterest</b>: Applied interest calculation method</li> <li><b>InterestRate</b>: Interest rate of deposit</li> <li><b>InterestRateDebit</b>: Debit rate</li> <li><b>InterestRateCredit</b>: Credit rate</li> <li><b>IndicatorCreditDebit</b>: Deposit balance set as default (Credit/Debit)</li> <li><b>Counterparty</b>: Counterparty details</li> </ul> |
| type       | <a href="#">FixedTimeDepositType</a>   |
| properties | isRef 0<br>content complex   |
| children   | <a href="#">StartDate</a> <a href="#">MaturityDate</a> <a href="#">MethodForCalculationOfInterest</a> <a href="#">InterestRate</a> <a href="#">InterestRateDebit</a> <a href="#">InterestRateCredit</a> <a href="#">IndicatorCreditDebit</a> <a href="#">Counterparty</a>  |
| annotation | documentation<br>Fixed time deposit details<br>documentation<br>Festgelder Details   |

element **AssetDetailsType/CallMoney**

diagram

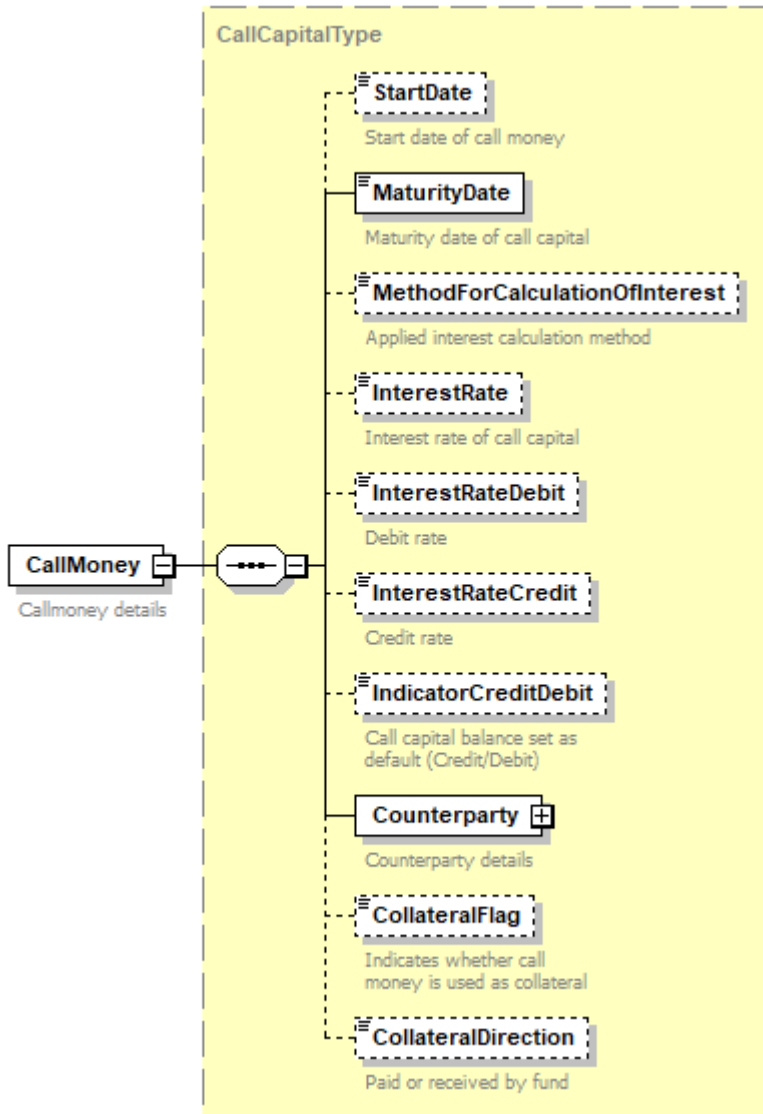

|            |  |
|------------|--|
| type       | <a href="#">CallCapitalType</a>  |
| properties | isRef 0<br>content complex   |
| children   | <a href="#">StartDate</a> <a href="#">MaturityDate</a> <a href="#">MethodForCalculationOfInterest</a> <a href="#">InterestRate</a> <a href="#">InterestRateDebit</a> <a href="#">InterestRateCredit</a> <a href="#">IndicatorCreditDebit</a> <a href="#">Counterparty</a> <a href="#">CollateralFlag</a> <a href="#">CollateralDirection</a> |
| annotation | documentation<br>Callmoney details   |

element **AssetDetailsType/Account**

|                   |   |
|-------------------|---|
| <p>diagram</p>    |   |
| <p>type</p>       | <p><a href="#">AccountType</a></p>  |
| <p>properties</p> | <p>isRef 0<br/>content complex</p>  |
| <p>children</p>   | <p><a href="#">IndicatorCreditDebit</a> <a href="#">AccountNumber</a> <a href="#">InterestRateDebit</a> <a href="#">InterestRateCredit</a> <a href="#">Counterparty</a></p> |
| <p>annotation</p> | <p>documentation<br/>Account details<br/>documentation<br/>Konten aus Fondsbuchhaltung, physische Bank- und Depotkonten</p>   |

element **AssetDetailsType/Fee**

|                   |  |
|-------------------|--|
| <p>diagram</p>    |  |
| <p>type</p>       | <p><a href="#">FeeType</a></p>                           |
| <p>properties</p> | <p>isRef 0<br/>content complex</p>                       |
| <p>children</p>   | <p><a href="#">Type</a> <a href="#">Counterparty</a></p> |
| <p>annotation</p> | <p>documentation<br/>Fee details</p>                     |

element **AssetDetailsType/RealEstate**

diagram

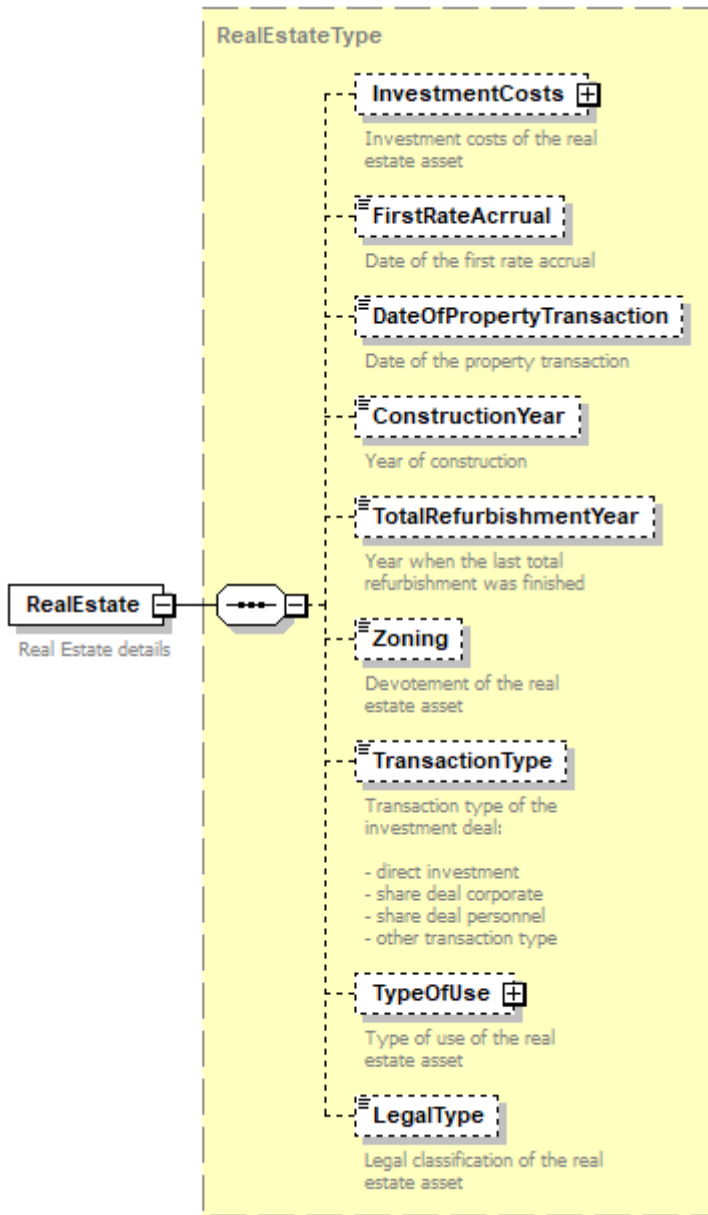

|            |   |
|------------|---|
| type       | <a href="#">RealEstateType</a>  |
| properties | isRef 0<br>content complex  |
| children   | <a href="#">InvestmentCosts</a> <a href="#">FirstRateAccrual</a> <a href="#">DateOfPropertyTransaction</a> <a href="#">ConstructionYear</a> <a href="#">TotalRefurbishmentYear</a> <a href="#">Zoning</a> <a href="#">TransactionType</a> <a href="#">TypeOfUse</a> <a href="#">LegalType</a> |
| annotation | documentation<br>Real Estate details  |

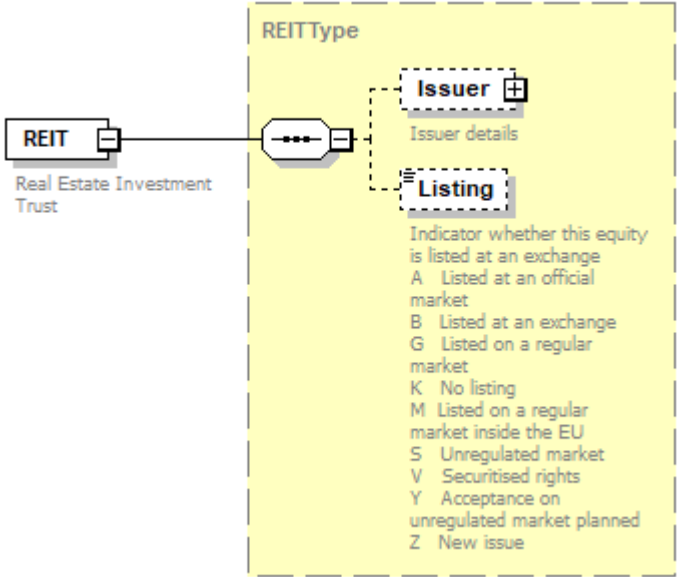

element **AssetDetailsType/REIT**

|                   |   |
|-------------------|---|
| <p>diagram</p>    |  |
| <p>type</p>       | <p><a href="#">REITType</a></p>   |
| <p>properties</p> | <p>isRef 0<br/>content complex</p>  |
| <p>children</p>   | <p><a href="#">Issuer</a> <a href="#">Listing</a></p>                             |
| <p>annotation</p> | <p>documentation<br/>Real Estate Investment Trust</p>                             |

element **AssetDetailsType/Loan**

diagram

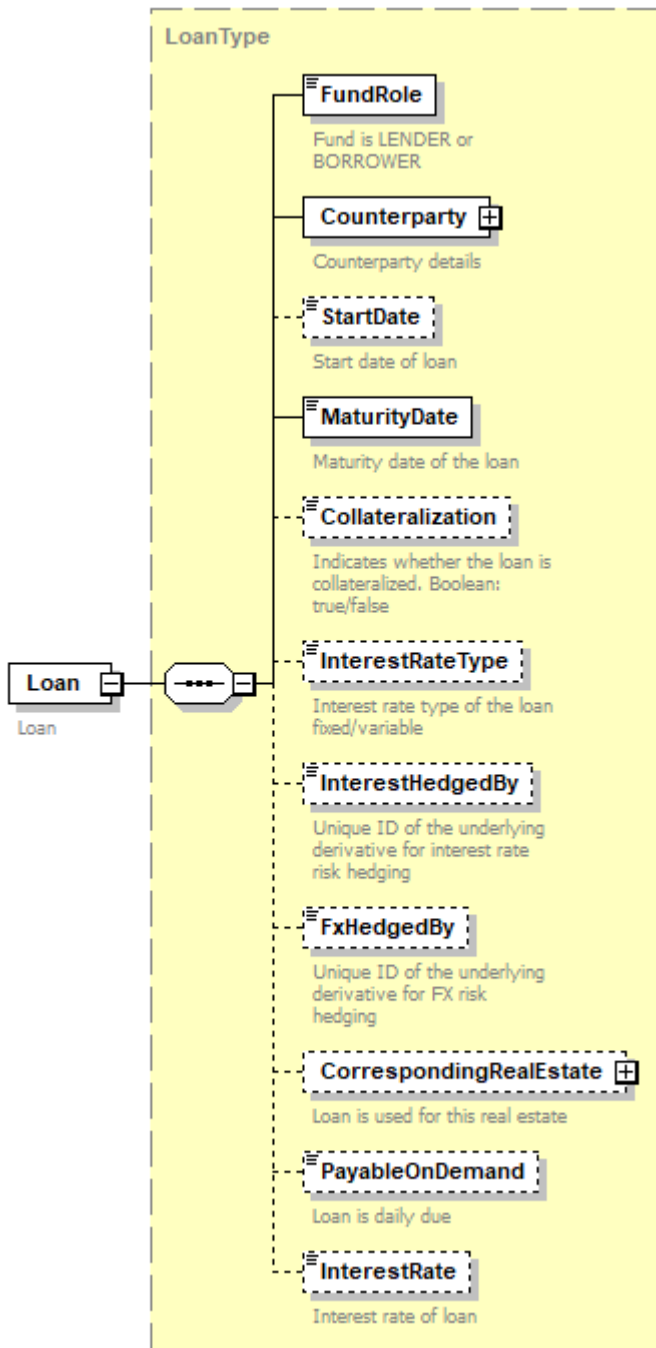

|            |  |
|------------|--|
| type       | <a href="#">LoanType</a>   |
| properties | isRef 0<br>content complex   |
| children   | <a href="#">FundRole</a> <a href="#">Counterparty</a> <a href="#">StartDate</a> <a href="#">MaturityDate</a> <a href="#">Collateralization</a> <a href="#">InterestRateType</a> <a href="#">InterestHedgedBy</a> <a href="#">FxHedgedBy</a> <a href="#">CorrespondingRealEstate</a> <a href="#">PayableOnDemand</a> <a href="#">InterestRate</a> |
| annotation | documentation<br>Loan<br>documentation<br>Kredit   |

element **AssetDetailsType/Right**

|            |  |
|------------|--|
| diagram    |  |
| properties | isRef 0<br>content complex   |
| children   | <a href="#">Type Issuer</a>  |
| annotation | documentation<br><b>Bezugsrecht</b><br>documentation<br><b>Right</b> |

element **AssetDetailsType/Right/Type**

|            |  |
|------------|--|
| diagram    |  |
| properties | isRef 0<br>minOcc 0<br>maxOcc 1<br>default xs:string |

element **AssetDetailsType/Right/Issuer**

|                   |   |
|-------------------|---|
| <p>diagram</p>    |   |
| <p>type</p>       | <p><a href="#">CompanyType</a></p>  |
| <p>properties</p> | <p>isRef 0<br/> minOcc 0<br/> maxOcc 1<br/> content complex</p>   |
| <p>children</p>   | <p><a href="#">Identifiers</a> <a href="#">Name</a> <a href="#">LegalName</a> <a href="#">LegalForm</a> <a href="#">Address</a> <a href="#">BusinessCountry</a> <a href="#">ParentCompany</a> <a href="#">OtherClassification</a></p> |
| <p>annotation</p> | <p>documentation<br/> <b>Issuer details</b><br/> documentation<br/> Enthält den Wertpapieremittenten</p>  |

element **AssetDetailsType/Commodity**

diagram

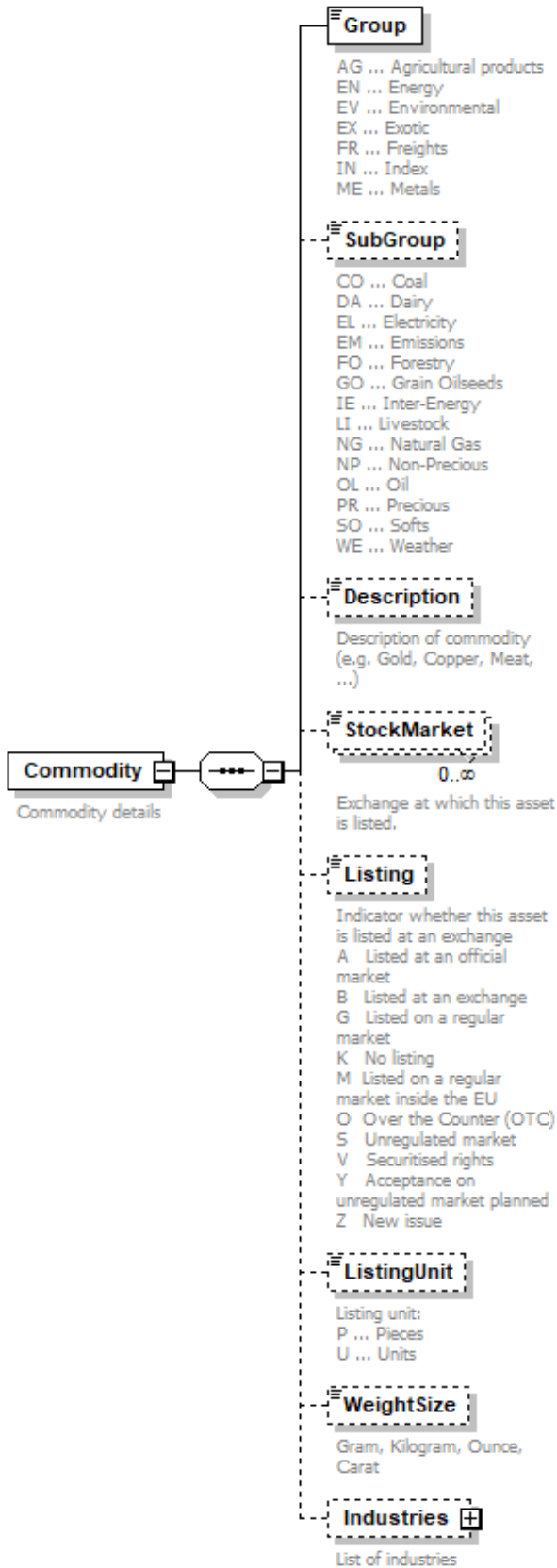

|            |  |
|------------|--|
| properties | isRef 0<br>content complex   |
| children   | <a href="#">Group</a> <a href="#">SubGroup</a> <a href="#">Description</a> <a href="#">StockMarket</a> <a href="#">Listing</a> <a href="#">ListingUnit</a> <a href="#">WeightSize</a> <a href="#">Industries</a> |
| annotation | documentation<br>Commodity details   |

element **AssetDetailsType/Commodity/Group**

|            |   |
|------------|---|
| diagram    |    |
| type       | restriction of <b>xs:string</b>   |
| properties | isRef 0<br>content simple   |
| annotation | documentation<br>AG ... Agricultural products<br>EN ... Energy<br>EV ... Environmental<br>EX ... Exotic<br>FR ... Freights<br>IN ... Index<br>ME ... Metals |

element **AssetDetailsType/Commodity/SubGroup**

|            |  |
|------------|--|
| diagram    |   |
| type       | restriction of <b>xs:string</b>  |
| properties | isRef 0<br>minOcc 0<br>maxOcc 1<br>content simple  |
| annotation | documentation<br>CO ... Coal<br>DA ... Dairy<br>EL ... Electricity<br>EM ... Emissions<br>FO ... Forestry<br>GO ... Grain Oilseeds<br>IE ... Inter-Energy<br>LI ... Livestock<br>NG ... Natural Gas<br>NP ... Non-Precious |

|  |   |
|--|---|
|  | OL ... Oil<br>PR ... Precious<br>SO ... Softs<br>WE ... Weather |
|--|---|

element **AssetDetailsType/Commodity/Description**

|            |  |
|------------|--|
| diagram    |  |
| type       | <a href="#">Text256Type</a>  |
| properties | isRef 0<br>minOcc 0<br>maxOcc 1<br>content simple                        |
| facets     | Kind Value annotation<br>maxLength 256                                   |
| annotation | documentation<br>Description of commodity (e.g. Gold, Copper, Meat, ...) |

element **AssetDetailsType/Commodity/StockMarket**

|            |  |
|------------|--|
| diagram    |  |
| type       | <b>xs:string</b>   |
| properties | isRef 0<br>minOcc 0<br>maxOcc unbounded<br>content simple  |
| annotation | documentation<br>Exchange at which this asset is listed.<br>documentation<br>Gibt den Boerseplatz an an dem das Wertpapier notiert |

element **AssetDetailsType/Commodity/Listing**

|         |   |
|---------|---|
| diagram |   |
|         | Indicator whether this asset is listed at an exchange<br>A Listed at an official market<br>B Listed at an exchange<br>G Listed on a regular market<br>K No listing<br>M Listed on a regular market inside the EU<br>O Over the Counter (OTC)<br>S Unregulated market<br>V Securitised rights<br>Y Acceptance on unregulated market planned<br>Z New issue |



|            |  |
|------------|--|
| type       | restriction of <b>xs:string</b>  |
| properties | isRef 0<br>minOcc 0<br>maxOcc 1<br>content simple  |
| annotation | documentation<br>Indicator whether this asset is listed at an exchange<br>A Listed at an official market<br>B Listed at an exchange<br>G Listed on a regular market<br>K No listing<br>M Listed on a regular market inside the EU<br>O Over the Counter (OTC)<br>S Unregulated market<br>V Securitised rights<br>Y Acceptance on unregulated market planned<br>Z New issue<br>documentation<br>Gibt an ob das Wertpapier an einer Boerse notiert<br><br>- A Amtlicher Handel<br>- B Boersennotierung Ausland<br>- G Geregelter Freiverkehr<br>- K Keine Boersennotierung<br>- M Geregelter Markt id. EU<br>- S Sonstiger Handel<br>- V Verbriefte Rechte<br>- Y Zulassung zum sonst. Handel vorges.<br>- Z Neuemission |

element **AssetDetailsType/Commodity/ListingUnit**

|            |  |
|------------|--|
| diagram    |                                   |
| type       | restriction of <b>xs:string</b>  |
| properties | isRef 0<br>minOcc 0<br>maxOcc 1<br>content simple  |
| annotation | documentation<br>Listing unit:<br>P ... Pieces<br>U ... Units<br>documentation<br>S = Stueck<br>oder<br>N = Nominale |

element **AssetDetailsType/Commodity/WeightSize**

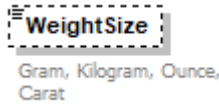
|            |   |
|------------|---|
| diagram    |  |
| type       | restriction of <b>xs:string</b>   |
| properties | isRef 0<br>minOcc 0<br>maxOcc 1   |

|            |   |
|------------|---|
|            | content simple                                |
| annotation | documentation<br>Gram, Kilogram, Ounce, Carat |

element **AssetDetailsType/Commodity/Industries**

|            |   |
|------------|---|
| diagram    | <p>The diagram shows a dashed box labeled 'Industries' with the text 'List of industries' below it. This box is connected via a line with a dashed oval in the middle to a solid box labeled 'IndustryCode' with '1..∞' below it.</p> |
| properties | isRef 0<br>minOcc 0<br>maxOcc 1<br>content complex  |
| children   | <a href="#">IndustryCode</a>  |
| annotation | documentation<br>List of industries   |

element **AssetDetailsType/Commodity/Industries/IndustryCode**

|            |   |
|------------|---|
| diagram    | <p>The diagram shows a solid box labeled 'IndustryCode' with '1..∞' below it. This box is connected via a line with a dashed oval in the middle to a larger dashed box labeled 'IndustryCodeType'. Inside the 'IndustryCodeType' box, there are three sub-elements: 'Name' (with text: 'Sector codification (GICS, ICB, ...) ***"CodificationSystem" would me more relevant than "Name"'), 'Date', and 'Value' (with text: 'Sector value in "Name" codification system').</p> |
| type       | <a href="#">IndustryCodeType</a>  |
| properties | isRef 0<br>minOcc 1<br>maxOcc unbounded<br>content complex  |
| children   | <a href="#">Name</a> <a href="#">Date</a> <a href="#">Value</a>   |

element **AssetDetailsType/PrivateEquity**

|                   |   |
|-------------------|---|
| <p>diagram</p>    | <p>The diagram illustrates the structure of the <b>PrivateEquityType</b> element. It is contained within a larger <b>PrivateEquity</b> element, which is labeled "Private Equity Investents". The <b>PrivateEquityType</b> element (highlighted in yellow) contains two sub-elements: <b>Company</b> and <b>PrivateEquityID</b>. The <b>Company</b> element is associated with the text "Gesellschaftsform (GmbH, SICAV, ...)". The <b>PrivateEquityID</b> element is associated with a detailed description: "Link to new file for lookthrough (Assets owned by SPV). This ID has to be used in //FundsXML4/Funds/Fund/Identifiers/OtherID/[@ListedType='PRIVATE EQUITY ID']".</p> |
| <p>type</p>       | <p><a href="#">PrivateEquityType</a></p>  |
| <p>properties</p> | <p>isRef 0<br/>content complex</p>  |
| <p>children</p>   | <p><a href="#">Company</a> <a href="#">PrivateEquityID</a></p>  |
| <p>annotation</p> | <p>documentation<br/><b>Private Equity Investents</b><br/>documentation<br/><b>Unternehmensbeteiligung</b></p>  |

element **AssetDetailsType/CommercialPaper**

|                   |   |
|-------------------|---|
| <p>diagram</p>    | <p><b>CommercialPaperType</b></p> <ul style="list-style-type: none"> <li><b>Issuer</b> (+)             <ul style="list-style-type: none"> <li>Issuer details</li> </ul> </li> <li><b>StockMarket</b> (dashed)             <ul style="list-style-type: none"> <li>0..∞</li> <li>MIC of the Exchange(s) at which this bond is listed.</li> </ul> </li> <li><b>Listing</b> (dashed)             <ul style="list-style-type: none"> <li>Indicator whether this bond is listed at an exchange</li> <li>A Listed at an official market</li> <li>B Listed at an exchange</li> <li>G Listed on a regular market</li> <li>K No listing</li> <li>M Listed on a regular market inside the EU</li> <li>S Unregulated market</li> <li>V Securitised rights</li> <li>Y Acceptance on unregulated market planned</li> <li>Z New issue</li> </ul> </li> <li><b>ListingUnit</b> (dashed)             <ul style="list-style-type: none"> <li>Listing unit:</li> <li>P ... pieces</li> <li>N ... nominal amount</li> </ul> </li> <li><b>IssueDate</b> (dashed)             <ul style="list-style-type: none"> <li>Issue date of the CP/CD</li> </ul> </li> <li><b>MaturityDate</b> <ul style="list-style-type: none"> <li>Maturity date</li> </ul> </li> <li><b>RedemptionRate</b> (dashed)             <ul style="list-style-type: none"> <li>Price at which the bond finally will be redeemed</li> </ul> </li> <li><b>Coupon</b> (+) (dashed)             <ul style="list-style-type: none"> <li>Coupon details</li> </ul> </li> <li><b>InterestRate</b> (dashed)             <ul style="list-style-type: none"> <li>Nominal interest rate</li> </ul> </li> <li><b>IsAssetBacked</b> (dashed)</li> </ul> <p><b>CommercialPaper</b> (Commercial Paper and Certificate of Deposit)</p> |
| <p>type</p>       | <p><a href="#">CommercialPaperType</a></p>  |
| <p>properties</p> | <p>isRef 0<br/>content complex</p>  |
| <p>children</p>   | <p><a href="#">Issuer</a> <a href="#">StockMarket</a> <a href="#">Listing</a> <a href="#">ListingUnit</a> <a href="#">IssueDate</a> <a href="#">MaturityDate</a> <a href="#">RedemptionRate</a> <a href="#">Coupon</a> <a href="#">InterestRate</a> <a href="#">IsAssetBacked</a></p>   |

|            |  |
|------------|--|
| annotation | documentation<br>Commercial Paper and Certificate of Deposit |
|------------|--|

complexType **AssetMasterDataType**

|          |  |
|----------|--|
| diagram  | <pre> classDiagram     class AssetMasterDataType {         Asset[]     }     class Asset     AssetMasterDataType "1" -- "*" Asset             </pre> <p>The diagram shows a class <b>AssetMasterDataType</b> containing an array of <b>Asset</b> objects. The <b>Asset</b> class is shown with a multiplicity of 1..∞.</p> |
| children | <a href="#">Asset</a>  |
| used by  | element <a href="#">FundsXML4/AssetMasterData</a>  |

element **AssetMasterData/Asset**

diagram

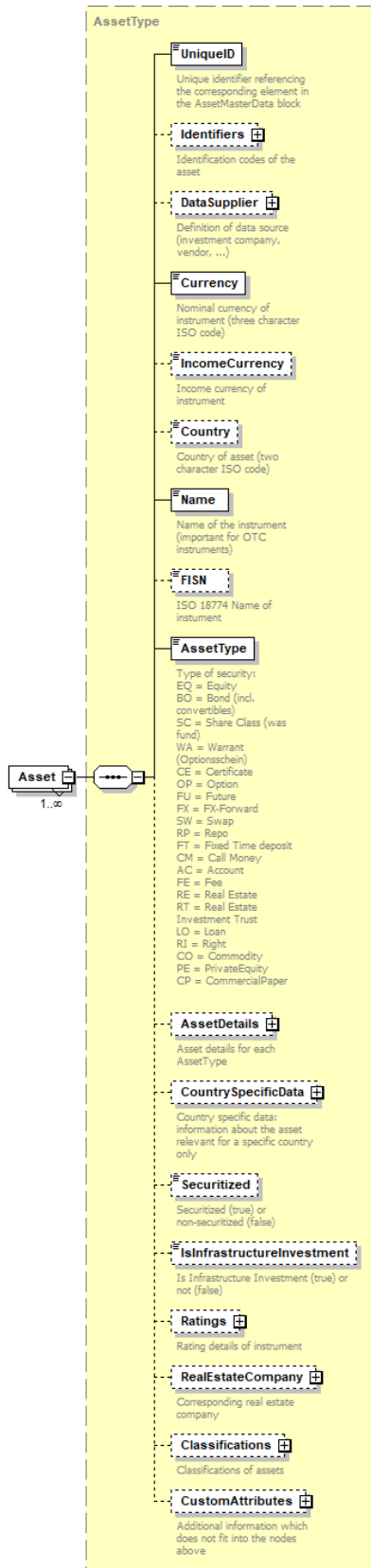

|            |   |
|------------|---|
| type       | <a href="#"><u>AssetType</u></a>  |
| properties | isRef 0<br>minOcc 1<br>maxOcc unbounded<br>content complex  |
| children   | <a href="#"><u>UniqueID</u></a> <a href="#"><u>Identifiers</u></a> <a href="#"><u>DataSupplier</u></a> <a href="#"><u>Currency</u></a> <a href="#"><u>IncomeCurrency</u></a> <a href="#"><u>Country</u></a> <a href="#"><u>Name</u></a> <a href="#"><u>FISN</u></a> <a href="#"><u>AssetType</u></a> <a href="#"><u>AssetDetails</u></a> <a href="#"><u>CountrySpecificData</u></a> <a href="#"><u>Securitized</u></a> <a href="#"><u>IsInfrastructureInvestment</u></a> <a href="#"><u>Ratings</u></a> <a href="#"><u>RealEstateCompany</u></a> <a href="#"><u>Classifications</u></a> <a href="#"><u>CustomAttributes</u></a> |

# complexType AssetType

diagram

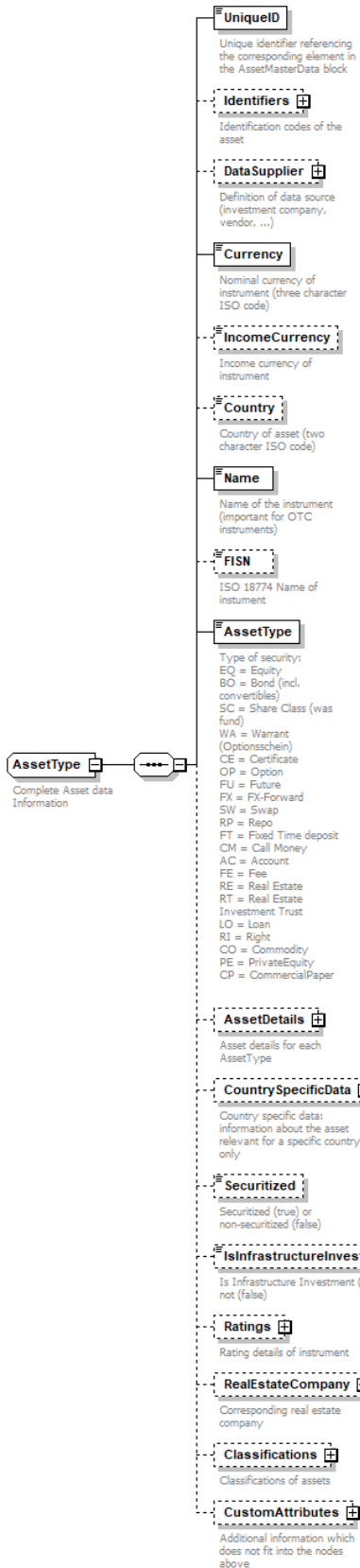



|            |  |
|------------|--|
| children   | <a href="#">UniqueID</a> <a href="#">Identifiers</a> <a href="#">DataSupplier</a> <a href="#">Currency</a> <a href="#">IncomeCurrency</a> <a href="#">Country</a> <a href="#">Name</a> <a href="#">FISN</a> <a href="#">AssetType</a> <a href="#">AssetDetails</a> <a href="#">CountrySpecificData</a> <a href="#">Securitized</a> <a href="#">IsInfrastructureInvestment</a> <a href="#">Ratings</a> <a href="#">RealEstateCompany</a> <a href="#">Classifications</a> <a href="#">CustomAttributes</a> |
| used by    | element <a href="#">AssetMasterDataType/Asset</a>  |
| annotation | documentation<br>Complete Asset data Information   |

element **AssetType/UniqueID**

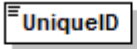
|            |   |
|------------|---|
| diagram    |  <p>Unique identifier referencing the corresponding element in the AssetMasterData block</p>   |
| type       | <b>xs:ID</b>  |
| properties | isRef 0<br>content simple   |
| annotation | documentation<br>Unique identifier referencing the corresponding element in the AssetMasterData block<br>documentation<br>Eindeutige Referenznummer der Stammdaten der Position (muss unter /AssetMasterData/Asset/UniqueID vorhanden sein) |

element **AssetType/Identifiers**

diagram

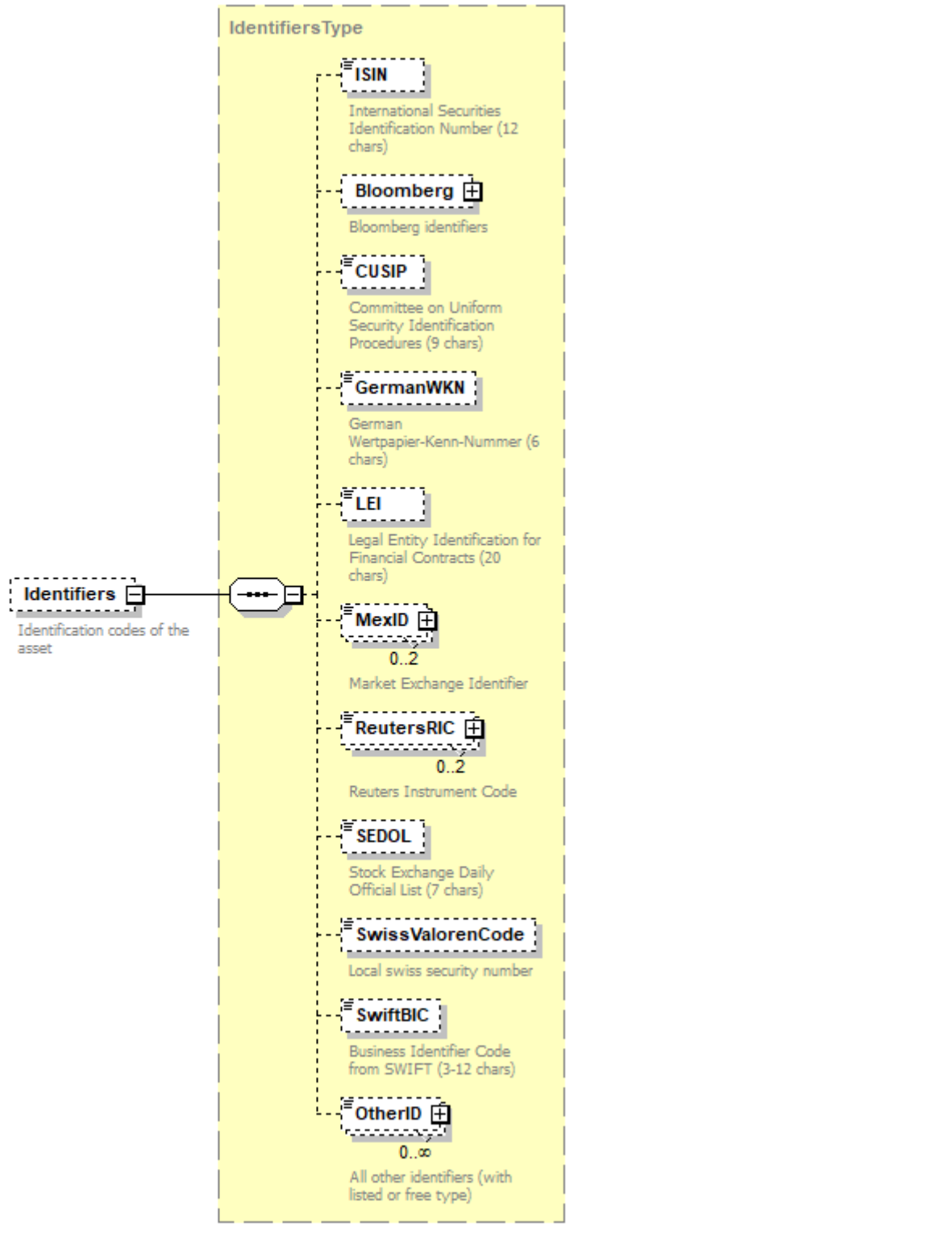

type [IdentifiersType](#)

properties

|        |   |
|--------|---|
| isRef  | 0 |
| minOcc | 0 |
| maxOcc | 1 |

|            |   |
|------------|---|
|            | content complex   |
| children   | <a href="#">ISIN</a> <a href="#">Bloomberg</a> <a href="#">CUSIP</a> <a href="#">GermanWKN</a> <a href="#">LEI</a> <a href="#">MexID</a> <a href="#">ReutersRIC</a> <a href="#">SEDOL</a> <a href="#">SwissValorenCode</a> <a href="#">SwiftBIC</a> <a href="#">OtherID</a> |
| annotation | documentation<br>Identification codes of the asset<br>documentation<br>Kennnummern des Instruments  |

element **AssetType/DataSupplier**

|            |   |
|------------|---|
| diagram    |   |
| type       | <a href="#">DataSupplierType</a>  |
| properties | isRef 0<br>minOcc 0<br>maxOcc 1<br>content complex  |
| children   | <a href="#">SystemCountry</a> <a href="#">Short</a> <a href="#">Name</a> <a href="#">Type</a> <a href="#">Contact</a> |
| annotation | documentation<br>Definition of data source (investment company, vendor, ...)  |

element **AssetType/Currency**

|            |   |
|------------|---|
| diagram    |   |
| type       | <a href="#">ISOCurrencyCodeType</a>                 |
| properties | isRef 0<br>content simple                           |
| facets     | Kind Value annotation<br>minLength 3<br>maxLength 3 |

|            |   |
|------------|---|
|            | pattern [A-Z]{3}  |
| annotation | documentation<br>Nominal currency of instrument (three character ISO code)<br>documentation<br>Notierungswährung des Instruments (dreistelliger ISO-Code) |

element **AssetType/IncomeCurrency**

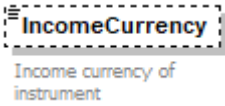
|            |  |
|------------|--|
| diagram    |                       |
| type       | <a href="#">ISOCurrencyCodeType</a>  |
| properties | isRef 0<br>minOcc 0<br>maxOcc 1<br>content simple  |
| facets     | Kind Value annotation<br>minLength 3<br>maxLength 3<br>pattern [A-Z]{3}                                |
| annotation | documentation<br>Income currency of instrument<br>documentation<br>Die Ertraegniswaehrung als ISO-Code |

element **AssetType/Country**

|            |  |
|------------|--|
| diagram    |                                   |
| type       | <a href="#">ISOCountryCodeType</a>   |
| properties | isRef 0<br>minOcc 0<br>maxOcc 1<br>content simple  |
| facets     | Kind Value annotation<br>minLength 2<br>maxLength 2  |
| annotation | documentation<br>Country of asset (two character ISO code)<br>documentation<br>Land des Instrumentes (Emissionsland) |

element **AssetType/Name**

|            |   |
|------------|---|
| diagram    |  |
| type       | <a href="#">Text256Type</a>   |
| properties | isRef 0<br>content simple   |

|            |   |
|------------|---|
| facets     | Kind Value annotation<br><b>maxLength</b> 256   |
| annotation | documentation<br>Name of the instrument (important for OTC instruments)<br>documentation<br>Bezeichnung des Instruments (besonders wichtig für OTC-Instrumente) |

### element **AssetType/FISN**

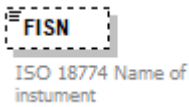
|            |   |
|------------|---|
| diagram    |  |
| type       | restriction of <b>xs:string</b>   |
| properties | isRef 0<br>minOcc 0<br>maxOcc 1<br>content simple                                 |
| facets     | Kind Value annotation<br><b>maxLength</b> 128                                     |
| annotation | documentation<br>ISO 18774 Name of instrument                                     |

### element **AssetType/AssetType**

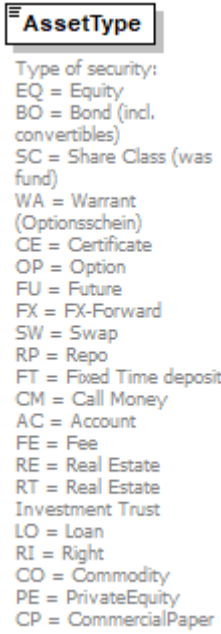
|            |   |
|------------|---|
| diagram    | <br>Type of security:<br>EQ = Equity<br>BO = Bond (incl. convertibles)<br>SC = Share Class (was fund)<br>WA = Warrant (Optionsschein)<br>CE = Certificate<br>OP = Option<br>FU = Future<br>FX = FX-Forward<br>SW = Swap<br>RP = Repo<br>FT = Fixed Time deposit<br>CM = Call Money<br>AC = Account<br>FE = Fee<br>RE = Real Estate<br>RT = Real Estate<br>Investment Trust<br>LO = Loan<br>RI = Right<br>CO = Commodity<br>PE = PrivateEquity<br>CP = CommercialPaper |
| type       | restriction of <a href="#">AssetTypeType</a>  |
| properties | isRef 0<br>content simple   |
| facets     | Kind Value annotation<br><b>length</b> 2  |
| annotation | documentation<br>Type of security:<br>EQ = Equity<br>BO = Bond (incl. convertibles)   |

SC = Share Class (was fund)  
WA = Warrant (Optionsschein)  
CE = Certificate  
OP = Option  
FU = Future  
FX = FX-Forward  
SW = Swap  
RP = Repo  
FT = Fixed Time deposit  
CM = Call Money  
AC = Account  
FE = Fee  
RE = Real Estate  
RT = Real Estate Investment Trust  
LO = Loan  
RI = Right  
CO = Commodity  
PE = PrivateEquity  
CP = CommercialPaper

documentation

Art des Wertpapiers:  
EQ = Aktie  
BO = Rente  
SC = Fonds/Anteilscheinklasse  
WA = Warrants  
CE = Zertifikat  
OP = Option  
FU = Future  
FX = FX-Forward  
SW = Swap  
RP = Repos  
FT = Festgelder  
CM = Callgelder  
AC = Konten  
FE = Gebühren  
RE = Immobilie  
RT = REIT  
LO = Darlehen  
RI = Rechte  
CO = Commodity  
PE = Unternehmensbeteiligung  
CP = Geldmarktpapier

element **AssetType/AssetDetails**

diagram

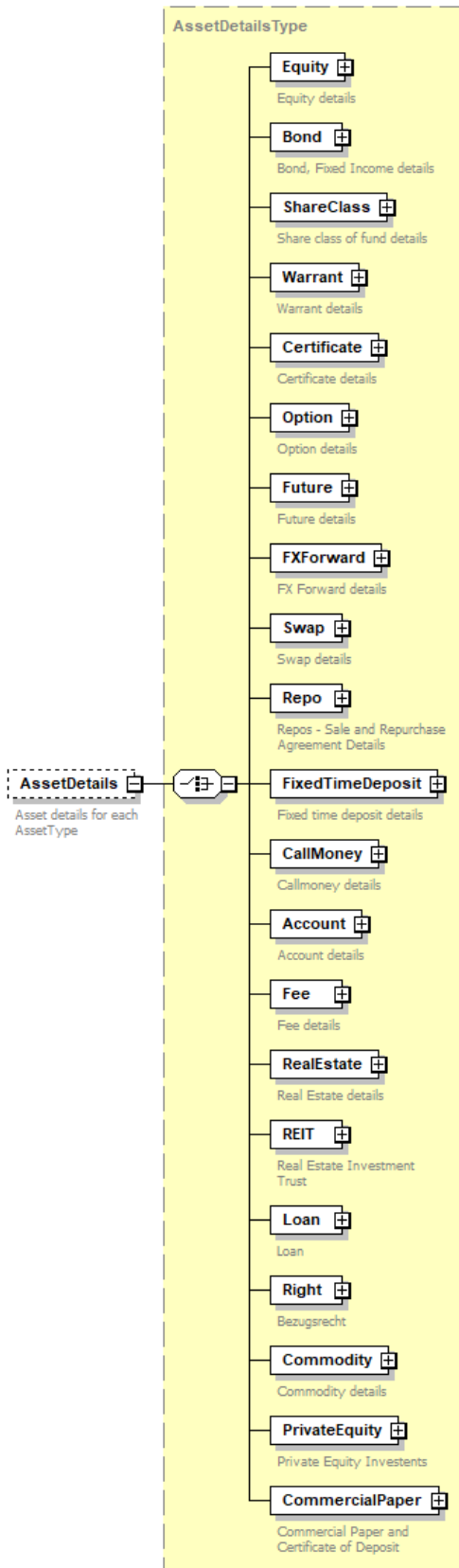

|            |  |
|------------|--|
| type       | <a href="#">AssetDetailsType</a>   |
| properties | isRef 0<br>minOcc 0<br>maxOcc 1<br>content complex   |
| children   | <a href="#">Equity</a> <a href="#">Bond</a> <a href="#">ShareClass</a> <a href="#">Warrant</a> <a href="#">Certificate</a> <a href="#">Option</a> <a href="#">Future</a> <a href="#">FXForward</a> <a href="#">Swap</a> <a href="#">Repo</a> <a href="#">FixedTimeDeposit</a> <a href="#">CallMoney</a> <a href="#">Account</a> <a href="#">Fee</a> <a href="#">RealEstate</a> <a href="#">REIT</a> <a href="#">Loan</a> <a href="#">Right</a> <a href="#">Commodity</a> <a href="#">PrivateEquity</a> <a href="#">CommercialPaper</a> |
| annotation | documentation<br>Asset details for each AssetType<br>documentation<br>Weitere Stammdaten (gegliedert nach AssetType)   |

### element [AssetType/CountrySpecificData](#)

|            |   |
|------------|---|
| diagram    |   |
| properties | isRef 0<br>minOcc 0<br>maxOcc 1<br>content complex  |
| children   | <a href="#">AT</a> <a href="#">DE</a> <a href="#">DK</a> <a href="#">FR</a> <a href="#">LU</a> <a href="#">NL</a>   |
| annotation | documentation<br>Country specific data: information about the asset relevant for a specific country only<br>documentation<br>Landesspezifische Daten eines Asset: Unterhalb der landesspezifischen Daten werden alle Informationen eines Asset abgelegt, die nur fuer ein bestimmtes Land gueltig sind. |

### element [AssetType/CountrySpecificData/AT](#)

|            |  |
|------------|--|
| diagram    |  |
| type       | <a href="#">CountrySpecificAssetMasterDataATType</a> |
| properties | isRef 0<br>minOcc 0<br>maxOcc 1<br>content complex   |
| children   | <a href="#">OeKBStammdatenblatt</a>                  |



element **AssetType/CountrySpecificData/DE**

|            |   |
|------------|---|
| diagram    | <p>The diagram shows a dashed box labeled 'CountrySpecificAssetMasterDataDEType'. Inside, there is a box labeled 'attributes' containing an 'any' element. Below this, there is a sequence of 'any' elements, with the last one having a cardinality of '0..∞'. A dashed box labeled 'DE' is connected to the 'CountrySpecificAssetMasterDataDEType' box.</p> |
| type       | <a href="#">CountrySpecificAssetMasterDataDEType</a>  |
| properties | <ul style="list-style-type: none"> <li>isRef 0</li> <li>minOcc 0</li> <li>maxOcc 1</li> <li>content complex</li> </ul>  |

element **AssetType/CountrySpecificData/DK**

|            |   |
|------------|---|
| diagram    | <p>The diagram shows a dashed box labeled 'CountrySpecificAssetMasterDataDKType'. Inside, there is a box labeled 'attributes' containing an 'any' element. Below this, there is a sequence of 'any' elements, with the last one having a cardinality of '0..∞'. A dashed box labeled 'DK' is connected to the 'CountrySpecificAssetMasterDataDKType' box.</p> |
| type       | <a href="#">CountrySpecificAssetMasterDataDKType</a>  |
| properties | <ul style="list-style-type: none"> <li>isRef 0</li> <li>minOcc 0</li> <li>maxOcc 1</li> <li>content complex</li> </ul>  |

element **AssetType/CountrySpecificData/FR**

|         |   |
|---------|---|
| diagram | <p>The diagram shows a dashed box labeled 'CountrySpecificAssetMasterDataFRType'. Inside, there is a box labeled 'attributes' containing an 'any' element. Below this, there is a sequence of 'any' elements, with the last one having a cardinality of '0..∞'. A dashed box labeled 'FR' is connected to the 'CountrySpecificAssetMasterDataFRType' box.</p> |
| type    | <a href="#">CountrySpecificAssetMasterDataFRType</a>  |

|            |  |
|------------|--|
| properties | isRef 0<br>minOcc 0<br>maxOcc 1<br>content complex |
|------------|--|

element **AssetType/CountrySpecificData/LU**

|            |   |
|------------|---|
| diagram    | <p>The diagram shows a dashed box labeled 'CountrySpecificAssetMasterDataLUType'. On the left, a dashed box labeled 'LU' is connected to the main container. Inside the main container, there is an 'attributes' container with a child 'any' element. Below this, there is a sequence of 'any' elements, with the last one having a cardinality of '0..∞'.</p> |
| type       | <a href="#">CountrySpecificAssetMasterDataLUType</a>  |
| properties | isRef 0<br>minOcc 0<br>maxOcc 1<br>content complex  |

element **AssetType/CountrySpecificData/NL**

|            |   |
|------------|---|
| diagram    | <p>The diagram shows a dashed box labeled 'CountrySpecificAssetMasterDataNLType'. On the left, a dashed box labeled 'NL' is connected to the main container. Inside the main container, there is an 'attributes' container with a child 'any' element. Below this, there is a sequence of 'any' elements, with the last one having a cardinality of '0..∞'.</p> |
| type       | <a href="#">CountrySpecificAssetMasterDataNLType</a>  |
| properties | isRef 0<br>minOcc 0<br>maxOcc 1<br>content complex  |

element **AssetType/Securitized**

|            |   |
|------------|---|
| diagram    | <p>The diagram shows a dashed box labeled 'Securitized' with the text 'Securitized (true) or non-securitized (false)' below it.</p> |
| type       | <b>xs:boolean</b>   |
| properties | isRef 0<br>minOcc 0<br>maxOcc 1<br>content simple   |

|            |  |
|------------|--|
| annotation | documentation<br>Securitized (true) or non-securitized (false) |
|------------|--|

element **AssetType/IsInfrastructureInvestment**

|            |   |
|------------|---|
| diagram    |   |
| type       | <b>xs:boolean</b>   |
| properties | isRef 0<br>minOcc 0<br>maxOcc 1<br>content simple                   |
| annotation | documentation<br>Is Infrastructure Investment (true) or not (false) |

element **AssetType/Ratings**

|            |  |
|------------|--|
| diagram    |  |
| properties | isRef 0<br>minOcc 0<br>maxOcc 1<br>content complex |
| children   | <a href="#">Rating</a>                             |
| annotation | documentation<br>Rating details of instrument      |

element **AssetType/Ratings/Rating**

|            |  |
|------------|--|
| diagram    |  |
| type       | <a href="#">RatingsType</a>                                |
| properties | isRef 0<br>minOcc 1<br>maxOcc unbounded<br>content complex |
| children   | <a href="#">RatingCompany</a> <a href="#">Rating</a>       |
| annotation | documentation<br>Rating-Informationen                      |

element **AssetType/RealEstateCompany**

|                   |   |
|-------------------|---|
| <p>diagram</p>    |   |
| <p>type</p>       | <p><a href="#">CompanyType</a></p>  |
| <p>properties</p> | <p>isRef 0<br/>minOcc 0<br/>maxOcc 1<br/>content complex</p>  |
| <p>children</p>   | <p><a href="#">Identifiers</a> <a href="#">Name</a> <a href="#">LegalName</a> <a href="#">LegalForm</a> <a href="#">Address</a> <a href="#">BusinessCountry</a> <a href="#">ParentCompany</a> <a href="#">OtherClassification</a></p> |
| <p>annotation</p> | <p>documentation<br/>Corresponding real estate company<br/>documentation<br/>zugehörige Grundstücksgesellschaft<br/><br/>CompanyType + Transparenzkennzeichnung</p>   |

element **AssetType/Classifications**

|            |  |
|------------|--|
| diagram    |  |
| type       | <a href="#">ClassificationsType</a>                |
| properties | isRef 0<br>minOcc 0<br>maxOcc 1<br>content complex |
| children   | <a href="#">Classification</a>                     |
| annotation | documentation<br>Classifications of assets         |

element **AssetType/CustomAttributes**

|            |   |
|------------|---|
| diagram    |   |
| type       | <a href="#">AttributesType</a>  |
| properties | isRef 0<br>minOcc 0<br>maxOcc 1<br>content complex                              |
| children   | <a href="#">Attribute</a>   |
| annotation | documentation<br>Additional information which does not fit into the nodes above |

complexType **BenchmarkType**

|            |   |
|------------|---|
| diagram    |   |
| children   | <a href="#">Components</a> <a href="#">Levels</a> |
| annotation | documentation<br>Benchmark information            |

element **BenchmarkType/Components**

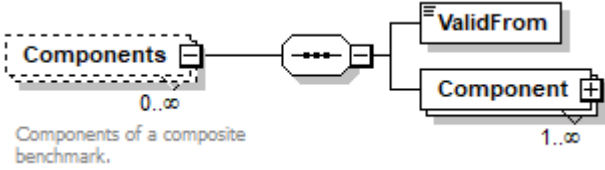
|            |   |
|------------|---|
| diagram    |  <p>Components of a composite benchmark.</p> |
| properties | isRef 0<br>minOcc 0<br>maxOcc unbounded<br>content complex  |
| children   | <a href="#">ValidFrom</a> <a href="#">Component</a>   |
| annotation | documentation<br>Components of a composite benchmark.<br>documentation<br>Komponenten eines Composite Benchmarks.             |

element **BenchmarkType/Components/ValidFrom**

|            |   |
|------------|---|
| diagram    |  |
| type       | <b>xs:date</b>  |
| properties | isRef 0<br>content simple   |

element **BenchmarkType/Components/Component**

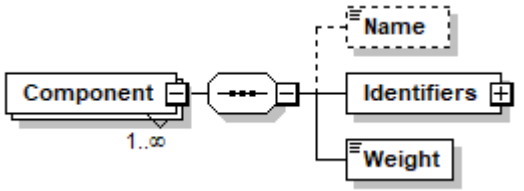
|            |   |
|------------|---|
| diagram    |  |
| properties | isRef 0<br>minOcc 1<br>maxOcc unbounded<br>content complex                          |
| children   | <a href="#">Name</a> <a href="#">Identifiers</a> <a href="#">Weight</a>             |

element **BenchmarkType/Components/Component/Name**

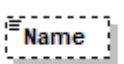
|            |   |
|------------|---|
| diagram    |  |
| type       | <b>xs:string</b>  |
| properties | isRef 0<br>minOcc 0<br>maxOcc 1<br>content simple                                   |

element **BenchmarkType/Components/Component/Identifiers**

diagram

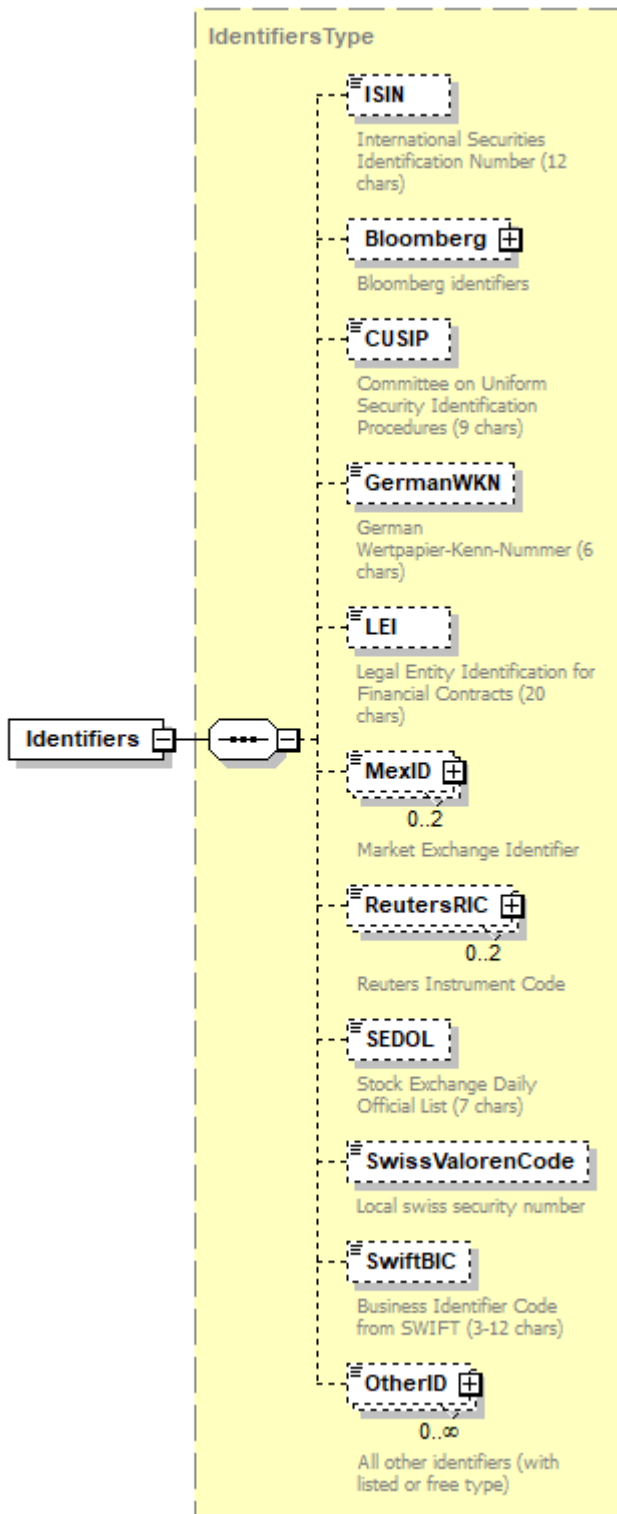

type [IdentifiersType](#)

properties isRef 0  
content complex

children [ISIN](#) [Bloomberg](#) [CUSIP](#) [GermanWKN](#) [LEI](#) [MexID](#) [ReutersRIC](#) [SEDOL](#) [SwissValorenCode](#) [SwiftBIC](#) [OtherID](#)

element **BenchmarkType/Components/Component/Weight**

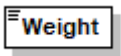
|            |   |
|------------|---|
| diagram    |  |
| type       | <b>xs:decimal</b>   |
| properties | isRef 0<br>content simple   |

element **BenchmarkType/Levels**

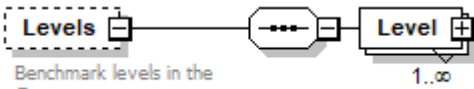
|            |  |
|------------|--|
| diagram    | <br>Benchmark levels in the Currency. |
| properties | isRef 0<br>minOcc 0<br>maxOcc 1<br>content complex   |
| children   | <a href="#">Level</a>  |
| annotation | documentation<br>Benchmark levels in the Currency.<br>documentation<br>Benchmarklevels in der definierten Wahrung     |

element **BenchmarkType/Levels/Level**

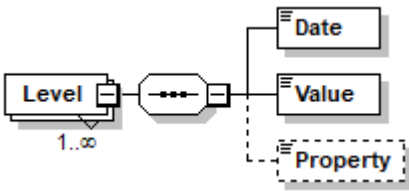
|            |   |
|------------|---|
| diagram    |  |
| properties | isRef 0<br>minOcc 1<br>maxOcc unbounded<br>content complex                          |
| children   | <a href="#">Date</a> <a href="#">Value</a> <a href="#">Property</a>                 |

element **BenchmarkType/Levels/Level/Date**

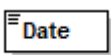
|            |   |
|------------|---|
| diagram    |  |
| type       | <b>xs:date</b>  |
| properties | isRef 0<br>content simple   |

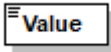

element **BenchmarkType/Levels/Level/Value**

|            |   |
|------------|---|
| diagram    |  |
| type       | <b>xs:decimal</b>   |
| properties | isRef 0<br>content simple   |

element **BenchmarkType/Levels/Level/Property**

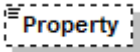
|            |   |
|------------|---|
| diagram    |  |
| type       | <b>xs:string</b>  |
| properties | isRef 0<br>minOcc 0<br>maxOcc 1<br>content simple                                 |

# complexType BondType

diagram



**ConvertibleFlag**  
 Indicates whether bond is convertible

**Issuer**  
 Issuer details

**StockMarket**  
 MTC of the Exchange(s) in which the bond is listed

**Listing**  
 Indicates whether the bond is listed at an exchange  
 A. Listed on an official market  
 E. Listed on an exchange market  
 G. Listed on a regular market  
 K. Not listed  
 M. Listed on a regular market under the EU  
 S. Unregulated market  
 V. Secured rights  
 Y. Acceptance on unregulated market allowed  
 Z. New issue

**ListingUnit**  
 Listing unit  
 P ... PBISB  
 N ... nominal amount

**IssueDate**  
 Issue date of the bond

**MaturityDate**  
 Maturity date

**DateFirstCoupon**  
 First coupon date

**DateLastCoupon**  
 Last coupon date

**CouponDate**  
 Coupon date

**Coupon**  
 Coupon details

**RedemptionDate**  
 Date at which the bond finally will be redeemed

**Redemption**  
 Redemption details

**InterestRate**  
 Nominal interest rate

**InterestStartDate**  
 Start date for calculation of interest

**IssueRate**  
 Price at which the bond has been issued  
 T ... IssuePrice

**IssueYield**  
 Yield to maturity of the bond at the time of issue

**Yield**  
 Yield value

**EUWithholdingTaxRate**  
 European withholding tax rate

**EUWithholdingTaxCategory**  
 EU withholding tax category  
 A = Euro calculation  
 B = Simplified calculation  
 C = No calculation

**CapitalYieldTaxInd**  
 Indicates whether interest of a bond will be charged with capital yield tax (in the kind - TO BE DISCUSSED?)

**CapitalYieldTaxRate**  
 Gilt De Markte Der vierligen KESJ-Sachen in

**GuaranteeType**  
 Type of guarantee  
 GARA ... Guarantee  
 FASENT ... Guarantee by parent company  
 HYPO ... Hypothek  
 NEG ... Negative-faktual  
 NONE ... No guarantee  
 OTHER ... Other  
 STATS ... State guarantee

**Guarantor**  
 Guarantor details

**IndicatorAcceptableCollateral**  
 Indicates whether asset can be used as collateral

**IndicatorZoneA**  
 Indicates whether the security is based in a Zone A country

**IndicatorAbsolutelySafe**  
 Indicates whether the security can be classified as absolutely safe (i.e. off-credit)  
 Boolean true/false

**WithholdingTaxRate**  
 Withholding tax rate of the security

**AgioFactor**  
 Agio factor of the security

**Durations**  
 List of duration values

**Tranche**  
 Number of tranche

**ConvertibleBond**  
 Details for Convertibles

|            |   |
|------------|---|
| children   | <a href="#">ConvertibleFlag</a> <a href="#">Issuer</a> <a href="#">StockMarket</a> <a href="#">Listing</a> <a href="#">ListingUnit</a> <a href="#">IssueDate</a> <a href="#">MaturityDate</a> <a href="#">DateFirstCoupon</a> <a href="#">DateLastCoupon</a> <a href="#">CouponDate</a> <a href="#">Coupon</a> <a href="#">RedemptionRate</a> <a href="#">Redemption</a> <a href="#">InterestRate</a> <a href="#">InterestsStartDate</a> <a href="#">IssueRate</a> <a href="#">IssueYield</a> <a href="#">Yields</a> <a href="#">EUWithholdingTaxRate</a> <a href="#">EUWithholdingTaxCategory</a> <a href="#">CapitalYieldsTaxKind</a> <a href="#">CapitalYieldsTaxRate</a> <a href="#">GuaranteeType</a> <a href="#">Guarantor</a> <a href="#">IndicatorAcceptableAsCollateral</a> <a href="#">IndicatorZoneA</a> <a href="#">IndicatorAbsolutelySafe</a> <a href="#">WithholdingTaxRate</a> <a href="#">AgioFactor</a> <a href="#">Durations</a> <a href="#">Tranche</a> <a href="#">ConvertibleBond</a> |
| used by    | element <a href="#">AssetDetailsType/Bond</a>   |
| annotation | documentation<br>Bond Asset data information  |

element **BondType/ConvertibleFlag**

|            |  |
|------------|--|
| diagram    |  <p>Indicates whether bond is convertible</p> |
| type       | <b>xs:boolean</b>  |
| properties | isRef 0<br>content simple  |
| annotation | documentation<br>Indicates whether bond is convertible   |

element **BondType/Issuer**

|                   |   |
|-------------------|---|
| <p>diagram</p>    |   |
| <p>type</p>       | <p><a href="#">CompanyType</a></p>  |
| <p>properties</p> | <p>isRef 0<br/>minOcc 0<br/>maxOcc 1<br/>content complex</p>  |
| <p>children</p>   | <p><a href="#">Identifiers</a> <a href="#">Name</a> <a href="#">LegalName</a> <a href="#">LegalForm</a> <a href="#">Address</a> <a href="#">BusinessCountry</a> <a href="#">ParentCompany</a> <a href="#">OtherClassification</a></p> |
| <p>annotation</p> | <p>documentation<br/>Issuer details<br/>documentation<br/>Enthaeft den Wertpapieremittenten</p>   |

element **BondType/StockMarket**

|                   |                                    |
|-------------------|------------------------------------|
| <p>diagram</p>    |                                    |
| <p>type</p>       | <p><a href="#">MICCodeType</a></p> |
| <p>properties</p> | <p>isRef 0<br/>minOcc 0</p>        |

|            |   |
|------------|---|
|            | maxOcc unbounded<br>content simple  |
| facets     | Kind Value annotation<br>length 4   |
| annotation | documentation<br>MIC of the Exchange(s) at which this bond is listed.<br>documentation<br>Gibt den MIC des Boerseplatz an an dem das Wertpapier notiert<br>appinfo<br><altova:exampleValues><br><altova:example value="WBAH"/><br></altova:exampleValues> |

### element **BondType/Listing**

|            |  |
|------------|--|
| diagram    |  <p>Indicator whether this bond is listed at an exchange</p> <ul style="list-style-type: none"> <li>A Listed at an official market</li> <li>B Listed at an exchange</li> <li>G Listed on a regular market</li> <li>K No listing</li> <li>M Listed on a regular market inside the EU</li> <li>S Unregulated market</li> <li>V Securitised rights</li> <li>Y Acceptance on unregulated market planned</li> <li>Z New issue</li> </ul>   |
| type       | restriction of <b>xs:string</b>  |
| properties | isRef 0<br>minOcc 0<br>maxOcc 1<br>content simple  |
| annotation | documentation<br>Indicator whether this bond is listed at an exchange<br>A Listed at an official market<br>B Listed at an exchange<br>G Listed on a regular market<br>K No listing<br>M Listed on a regular market inside the EU<br>S Unregulated market<br>V Securitised rights<br>Y Acceptance on unregulated market planned<br>Z New issue<br>documentation<br>Gibt an ob das Wertpapier an einer Boerse notiert<br><br><ul style="list-style-type: none"> <li>- A Amtlicher Handel</li> <li>- B Boersennotierung Ausland</li> <li>- G Geregelter Freiverkehr</li> <li>- K Keine Boersenotierung</li> <li>- M Geregelter Markt id. EU</li> <li>- S Sonstiger Handel</li> <li>- V Verbriefte Rechte</li> <li>- Y Zulassung zum sonst. Handel vorges.</li> <li>- Z Neuemission</li> </ul> |

element **BondType/ListingUnit**

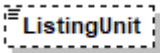
|            |  |
|------------|--|
| diagram    |  <p>Listing unit:<br/>P ... pieces<br/>N ... nominal amount</p> |
| type       | restriction of <b>xs:string</b>  |
| properties | isRef 0<br>minOcc 0<br>maxOcc 1<br>content simple  |
| annotation | documentation<br>Listing unit:<br>P ... pieces<br>N ... nominal amount<br>documentation<br>S = Stueck<br>oder<br>N = Nominale                    |

element **BondType/IssueDate**

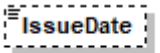
|            |  |
|------------|--|
| diagram    |  <p>Issue date of the bond</p>                          |
| type       | <b>xs:date</b>   |
| properties | isRef 0<br>minOcc 0<br>maxOcc 1<br>content simple  |
| annotation | documentation<br>Issue date of the bond<br>documentation<br>Emissionsdatum bezeichnet jenes Datum, zu dem das Wertpapier aufgelegt wurde |

element **BondType/MaturityDate**

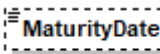
|            |  |
|------------|--|
| diagram    |  <p>Maturity date</p> |
| type       | <b>xs:date</b>   |
| properties | isRef 0<br>minOcc 0<br>maxOcc 1<br>content simple  |
| annotation | documentation<br>Maturity date<br>documentation<br>Ablaufdatum/Faelligkeitsdatum                         |

element **BondType/DateFirstCoupon**

|         |  |
|---------|--|
| diagram |  <p>First coupon date</p> |
|---------|--|

|            |  |
|------------|--|
| type       | <b>xs:date</b>   |
| properties | isRef 0<br>minOcc 0<br>maxOcc 1<br>content simple  |
| annotation | documentation<br><b>First coupon date</b><br>documentation<br>Enthaelt das Datum des ersten Kupons |

element **BondType/DateLastCoupon**

|            |  |
|------------|--|
| diagram    |                                     |
| type       | <b>xs:date</b>   |
| properties | isRef 0<br>minOcc 0<br>maxOcc 1<br>content simple  |
| annotation | documentation<br><b>Last coupon date</b><br>documentation<br>Enthaelt das Datum an dem der letzte Kupon gezahlt wird |

element **BondType/CouponDate**

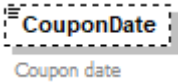
|            |   |
|------------|---|
| diagram    |  |
| type       | <b>xs:date</b>  |
| properties | isRef 0<br>minOcc 0<br>maxOcc 1<br>content simple                                   |
| annotation | documentation<br><b>Coupon date</b><br>documentation<br>Gibt das Kupondatum an      |

element **BondType/Coupon**

|            |   |
|------------|---|
| diagram    | <p>The diagram shows a central 'Coupon' element (labeled 'Coupon details') connected to a complex structure of five sub-elements: <b>Type</b> (fix/float/zero/others), <b>PaymentFrequency</b> (Payment frequency (e.g. yearly)), <b>InterestRate</b>, <b>BaseIndex</b> (e.g. EURIBOR 6 Months), and <b>OffsetBPS</b> (Offset in base points in addition to BaseIndex).</p> |
| properties | isRef 0<br>minOcc 0<br>maxOcc 1<br>content complex  |
| children   | <a href="#">Type</a> <a href="#">PaymentFrequency</a> <a href="#">InterestRate</a> <a href="#">BaseIndex</a> <a href="#">OffsetBPS</a>  |
| annotation | documentation<br>Coupon details   |

element **BondType/Coupon/Type**

|            |   |
|------------|---|
| diagram    | <p>The diagram shows a single 'Type' element (labeled 'fix/float/zero/others').</p> |
| type       | restriction of <b>xs:string</b>   |
| properties | isRef 0<br>minOcc 0<br>maxOcc 1<br>content simple                                   |
| annotation | documentation<br>fix/float/zero/others  |

element **BondType/Coupon/PaymentFrequency**

|            |   |
|------------|---|
| diagram    | <p>The diagram shows a single 'PaymentFrequency' element (labeled 'Payment frequency (e.g. yearly)').</p> |
| type       | <a href="#">FrequencyType</a>   |
| properties | isRef 0<br>minOcc 0<br>maxOcc 1<br>content simple   |
| annotation | documentation<br>Payment frequency (e.g. yearly)  |



element **BondType/Coupon/InterestRate**

|            |   |
|------------|---|
| diagram    |                                      |
| type       | <b>xs:decimal</b>   |
| properties | <ul style="list-style-type: none"> <li>isRef 0</li> <li>minOcc 0</li> <li>maxOcc 1</li> <li>content simple</li> </ul> |

element **BondType/Coupon/BaselIndex**

diagram

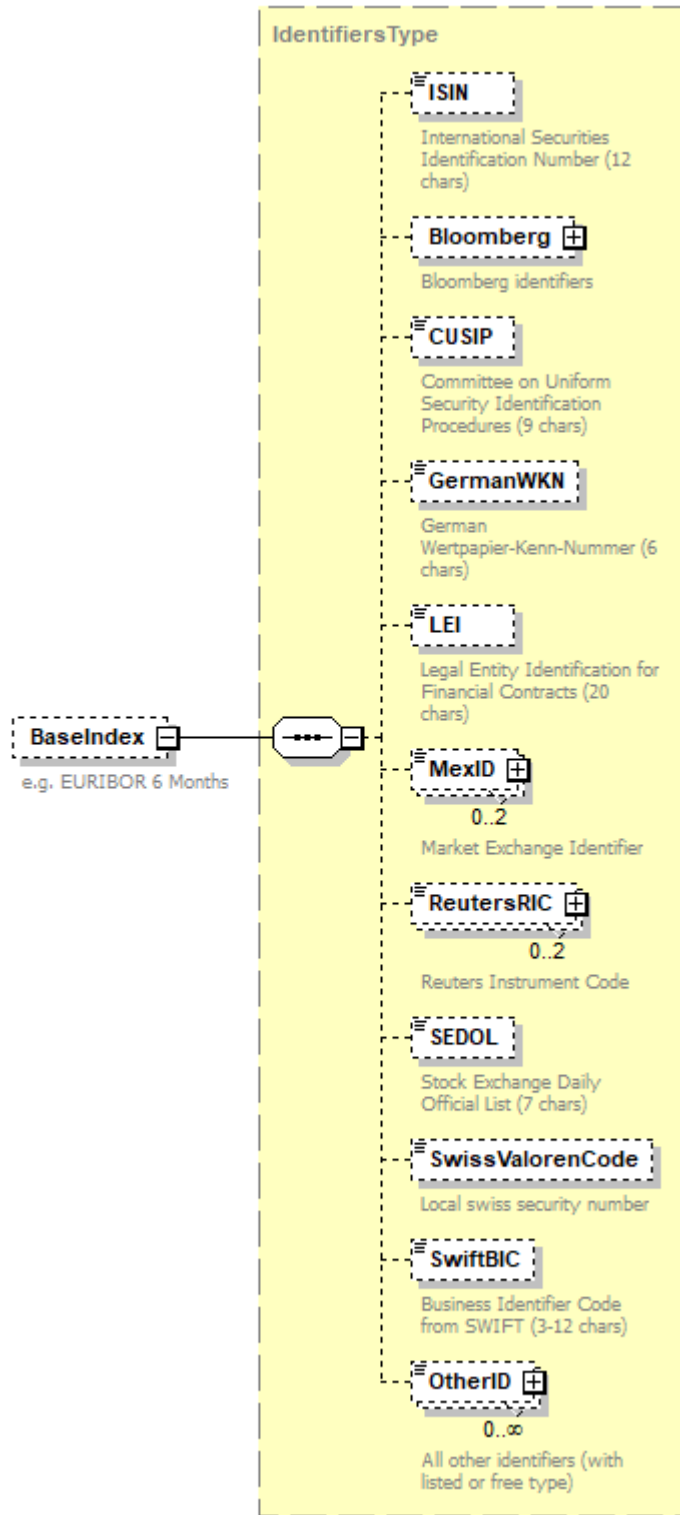

type [IdentifiersType](#)

properties  
 isRef 0  
 minOcc 0  
 maxOcc 1

|            |   |
|------------|---|
|            | content complex   |
| children   | <a href="#">ISIN</a> <a href="#">Bloomberg</a> <a href="#">CUSIP</a> <a href="#">GermanWKN</a> <a href="#">LEI</a> <a href="#">MexID</a> <a href="#">ReutersRIC</a> <a href="#">SEDOL</a> <a href="#">SwissValorenCode</a> <a href="#">SwiftBIC</a> <a href="#">OtherID</a> |
| annotation | documentation<br>e.g. EURIBOR 6 Months  |

element **BondType/Coupon/OffsetBPS**

|            |   |
|------------|---|
| diagram    |  |
| type       | <b>xs:decimal</b>   |
| properties | isRef 0<br>minOcc 0<br>maxOcc 1<br>content simple                                 |
| annotation | documentation<br>Offset in base points in addition to BaseIndex                   |

element **BondType/RedemptionRate**

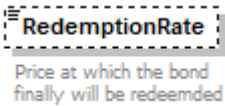
|            |   |
|------------|---|
| diagram    |    |
| type       | <b>xs:decimal</b>   |
| properties | isRef 0<br>minOcc 0<br>maxOcc 1<br>content simple   |
| annotation | documentation<br>Price at which the bond finally will be redeemed<br>documentation<br>Enthält den Kurs zu dem das Wertpapier getilgt wird |

element **BondType/Redemption**

|            |  |
|------------|--|
| diagram    |  |
| properties | isRef 0<br>minOcc 0<br>maxOcc 1<br>content complex   |
| children   | <a href="#">Type</a> <a href="#">Frequency</a> <a href="#">IssuerDate</a> <a href="#">OptionDate</a> <a href="#">OptionDirection</a> <a href="#">OptionStrikePrice</a> |
| annotation | documentation<br>Redemption details  |

element **BondType/Redemption/Type**

|            |   |
|------------|---|
| diagram    |   |
| type       | restriction of <b>xs:string</b>                   |
| properties | isRef 0<br>minOcc 0<br>maxOcc 1<br>content simple |
| annotation | documentation<br>Bullet or Sinkable               |

element **BondType/Redemption/Frequency**

|            |   |
|------------|---|
| diagram    |   |
| type       | <a href="#">FrequencyType</a>                     |
| properties | isRef 0<br>minOcc 0<br>maxOcc 1<br>content simple |

|            |                                       |
|------------|---------------------------------------|
| annotation | documentation<br>Redemption frequency |
|------------|---------------------------------------|

element **BondType/Redemption/IssuerDate**

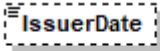
|            |   |
|------------|---|
| diagram    |  <p>Date when issuer could cancel the issue</p>                |
| type       | <b>xs:date</b>  |
| properties | isRef 0<br>minOcc 0<br>maxOcc 1<br>content simple   |
| annotation | documentation<br>Date when issuer could cancel the issue<br>documentation<br>Enthaelt das Datum ab dem der Emittent die Emission kuendigen kann |

element **BondType/Redemption/OptionDate**

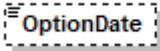
|            |   |
|------------|---|
| diagram    |  <p>Date of next execution possibility</p> |
| type       | <b>xs:date</b>  |
| properties | isRef 0<br>minOcc 0<br>maxOcc 1<br>content simple   |
| annotation | documentation<br>Date of next execution possibility   |

element **BondType/Redemption/OptionDirection**

|            |   |
|------------|---|
| diagram    |  <p>Issuer, Bearer, Both</p> |
| type       | restriction of <b>xs:string</b>   |
| properties | isRef 0<br>minOcc 0<br>maxOcc 1<br>content simple   |
| annotation | documentation<br>Issuer, Bearer, Both   |

element **BondType/Redemption/OptionStrikePrice**

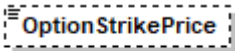
|         |   |
|---------|---|
| diagram |  <p>Strike price for embedded option</p> |
| type    | <b>xs:decimal</b>   |

|            |   |
|------------|---|
| properties | isRef 0<br>minOcc 0<br>maxOcc 1<br>content simple |
| annotation | documentation<br>Strike price for embedded option |

element **BondType/InterestRate**

|            |  |
|------------|--|
| diagram    |   |
| type       | <b>xs:decimal</b>  |
| properties | isRef 0<br>minOcc 0<br>maxOcc 1<br>content simple                                  |
| annotation | documentation<br>Nominal interest rate<br>documentation<br>Enthaelt einen Zinssatz |

element **BondType/InterestsStartDate**

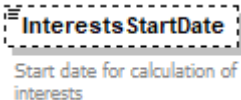
|            |  |
|------------|--|
| diagram    |    |
| type       | <b>xs:date</b>   |
| properties | isRef 0<br>minOcc 0<br>maxOcc 1<br>content simple  |
| annotation | documentation<br>Start date for calculation of interests<br>documentation<br>Enthaelt das Datum ab dem ein Zinsanspruch ermittelt wird |

element **BondType/IssueRate**

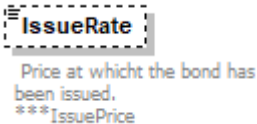
|            |  |
|------------|--|
| diagram    |   |
| type       | <b>xs:decimal</b>  |
| properties | isRef 0<br>minOcc 0<br>maxOcc 1<br>content simple  |
| annotation | documentation<br>Price at which the bond has been issued.<br>***IssuePrice<br>documentation<br>Enthaelt den Emissionskurs des Wertpapier |

element **BondType/IssueYield**

|            |   |
|------------|---|
| diagram    |    |
| type       | <b>xs:decimal</b>   |
| properties | isRef 0<br>minOcc 0<br>maxOcc 1<br>content simple   |
| annotation | documentation<br>Yield to maturity of the bond at the date of issue.<br>documentation<br>Enthaeht die Emissionsrendite des Wertpapier |

element **BondType/Yields**

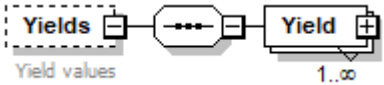
|            |   |
|------------|---|
| diagram    |  |
| properties | isRef 0<br>minOcc 0<br>maxOcc 1<br>content complex                                |
| children   | <a href="#">Yield</a>   |
| annotation | documentation<br>Yield values   |

element **BondType/Yields/Yield**

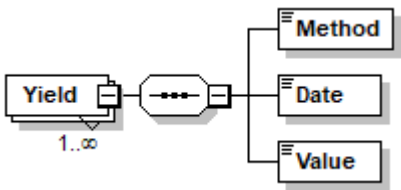
|            |   |
|------------|---|
| diagram    |  |
| properties | isRef 0<br>minOcc 1<br>maxOcc unbounded<br>content complex                          |
| children   | <a href="#">Method</a> <a href="#">Date</a> <a href="#">Value</a>                   |

element **BondType/Yields/Yield/Method**

|            |   |
|------------|---|
| diagram    |  |
| type       | <b>xs:string</b>  |
| properties | isRef 0<br>content simple   |

element **BondType/Yields/Yield/Date**

|            |   |
|------------|---|
| diagram    |  |
| type       | <b>xs:date</b>  |
| properties | isRef 0<br>content simple   |

element **BondType/Yields/Yield/Value**

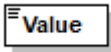
|            |   |
|------------|---|
| diagram    |  |
| type       | <b>xs:decimal</b>   |
| properties | isRef 0<br>content simple   |

element **BondType/EUWithholdingTaxRate**

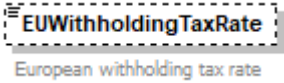
|            |  |
|------------|--|
| diagram    |             |
| type       | <b>xs:decimal</b>  |
| properties | isRef 0<br>minOcc 0<br>maxOcc 1<br>content simple  |
| annotation | documentation<br>European withholding tax rate<br>documentation<br>Gibt den EU Quest Satz an |

element **BondType/EUWithholdingTaxCategory**

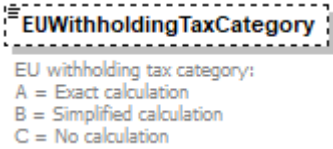
|            |  |
|------------|--|
| diagram    |   |
| type       | restriction of <b>xs:string</b>  |
| properties | isRef 0<br>minOcc 0<br>maxOcc 1<br>content simple  |
| annotation | documentation<br>EU withholding tax category:<br>A = Exact calculation<br>B = Simplified calculation<br>C = No calculation<br>documentation<br>Gibt die EU Quest Kategorie an:<br>A = Genaue Berechnung<br>B = Vereinfachte Berechnung<br>C = Keine Berechnung |

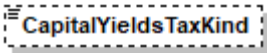

element **BondType/CapitalYieldsTaxKind**

|            |   |
|------------|---|
| diagram    |  <p>Indicates whether incomes of a bond will be charged with capital yields tax and its kind - TO BE DISCUSSED !!!</p> |
| type       | <b>xs:string</b>  |
| properties | isRef 0<br>minOcc 0<br>maxOcc 1<br>content simple   |
| annotation | documentation<br>Indicates whether incomes of a bond will be charged with capital yields tax and its kind - TO BE DISCUSSED !!!<br>documentation<br>Gibt an ob ein Wertpapier KEST-Pflichtig ist        |

element **BondType/CapitalYieldsTaxRate**

|            |  |
|------------|--|
| diagram    |  <p>Gibt die Hoehe des gueltigen KEST-Satzes an</p> |
| type       | <b>xs:decimal</b>  |
| properties | isRef 0<br>minOcc 0<br>maxOcc 1<br>content simple  |
| annotation | documentation<br>Gibt die Hoehe des gueltigen KEST-Satzes an   |

element **BondType/GuaranteeType**

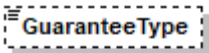
|            |   |
|------------|---|
| diagram    |  <p>Type of guarantee:<br/> GARA ... Guarantee<br/> PARENT ... Guarantee by parent company<br/> HYPO ... Hypothek<br/> NEG ... Negativklausel<br/> NONE ... Not guaranteed<br/> OTHER ... Other<br/> STATE ... State guarantee</p> |
| type       | restriction of <b>xs:string</b>   |
| properties | isRef 0<br>minOcc 0<br>maxOcc 1<br>content simple   |
| annotation | documentation<br>Type of guarantee:<br>GARA ... Guarantee<br>PARENT ... Guarantee by parent company<br>HYPO ... Hypothek<br>NEG ... Negativklausel<br>NONE ... Not guaranteed<br>OTHER ... Other<br>STATE ... State guarantee   |

element **BondType/Guarantor**

|                   |  |
|-------------------|--|
| <p>diagram</p>    | <p>The diagram illustrates the structure of the <b>CompanyType</b> element. It is a complex type containing several child elements:</p> <ul style="list-style-type: none"> <li><b>Identifiers (+)</b>: Identifiers of company</li> <li><b>Name</b>: Name of company</li> <li><b>LegalName</b>: Legal (full) name of company</li> <li><b>LegalForm</b>: Legal form of company</li> <li><b>Address (+)</b>: Address of company</li> <li><b>BusinessCountry</b>: Country code of main business of company</li> <li><b>ParentCompany (+)</b>: Parent company (if applicable)</li> <li><b>OtherClassification (+)</b>: All other identifiers (with listed or free type). Occurrence: 0..∞</li> </ul> <p>A <b>Guarantor</b> element (dashed box) is shown connected to the main structure, representing 'Guarantor details'.</p> |
| <p>type</p>       | <p><a href="#">CompanyType</a></p>   |
| <p>properties</p> | <p>isRef 0<br/>minOcc 0<br/>maxOcc 1<br/>content complex</p>   |
| <p>children</p>   | <p><a href="#">Identifiers</a> <a href="#">Name</a> <a href="#">LegalName</a> <a href="#">LegalForm</a> <a href="#">Address</a> <a href="#">BusinessCountry</a> <a href="#">ParentCompany</a> <a href="#">OtherClassification</a></p>  |
| <p>annotation</p> | <p>documentation<br/>Guarantor details</p>   |

element **BondType/IndicatorAcceptableAsCollateral**

|                   |   |
|-------------------|---|
| <p>diagram</p>    | <p>The diagram shows the <b>IndicatorAcceptableAsCollateral</b> element as a dashed box containing the text: "Indicates whether asset can be used as collateral".</p> |
| <p>type</p>       | <p><b>xs:boolean</b></p>  |
| <p>properties</p> | <p>isRef 0<br/>minOcc 0<br/>maxOcc 1</p>  |

|            |  |
|------------|--|
|            | content simple   |
| annotation | documentation<br>Indicates whether asset can be used as collateral<br>documentation<br>Gibt an, ob es sich um ein Lombardfaehiges Wertpapier handelt |

#### element **BondType/IndicatorZoneA**

|            |   |
|------------|---|
| diagram    |    |
| type       | <b>xs:boolean</b>   |
| properties | isRef 0<br>minOcc 0<br>maxOcc 1<br>content simple   |
| annotation | documentation<br>Indicates whether the security is issued in a Zone A country<br>documentation<br>Enthaelt ein Kennzeichen, ob es sich um ein Wertpapier handelt, welches in einem Zone A Staat begeben wurde |

#### element **BondType/IndicatorAbsolutelySafe**

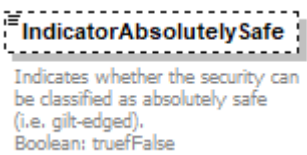
|            |  |
|------------|--|
| diagram    |    |
| type       | <b>xs:boolean</b>  |
| properties | isRef 0<br>minOcc 0<br>maxOcc 1<br>content simple  |
| annotation | documentation<br>Indicates whether the security can be classified as absolutely safe (i.e. gilt-edged).<br>Boolean: trueFalse<br>documentation<br>Enthaelt ein Kennzeichen, ob das Wertpapier muendelsicher ist<br>Boolean: true/false |

#### element **BondType/WithholdingTaxRate**

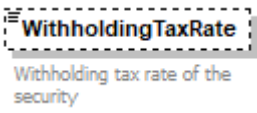
|            |  |
|------------|--|
| diagram    |               |
| type       | <b>xs:decimal</b>  |
| properties | isRef 0<br>minOcc 0<br>maxOcc 1<br>content simple  |
| annotation | documentation<br>Withholding tax rate of the security<br>documentation<br>Gibt den Quest Satz an |

element **BondType/AgioFactor**

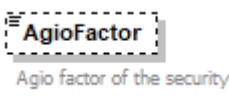
|            |  |
|------------|--|
| diagram    |             |
| type       | <b>xs:decimal</b>  |
| properties | isRef 0<br>minOcc 0<br>maxOcc 1<br>content simple  |
| annotation | documentation<br>Agio factor of the security<br>documentation<br>Gibt den Zuschlagsfaktor an |

element **BondType/Durations**

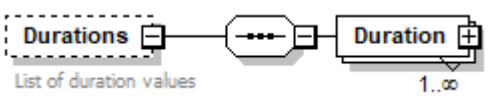
|            |   |
|------------|---|
| diagram    |  |
| properties | isRef 0<br>minOcc 0<br>maxOcc 1<br>content complex                                |
| children   | <a href="#">Duration</a>  |
| annotation | documentation<br>List of duration values  |

element **BondType/Durations/Duration**

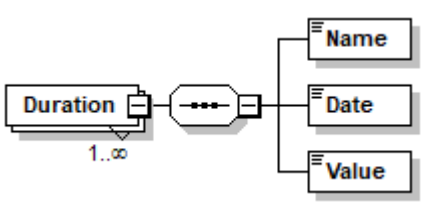
|            |   |
|------------|---|
| diagram    |  |
| properties | isRef 0<br>minOcc 1<br>maxOcc unbounded<br>content complex                          |
| children   | <a href="#">Name</a> <a href="#">Date</a> <a href="#">Value</a>                     |

element **BondType/Durations/Duration/Name**

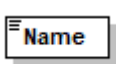
|            |   |
|------------|---|
| diagram    |  |
| type       | <b>xs:string</b>  |
| properties | isRef 0<br>content simple   |

element **BondType/Durations/Duration/Date**

|            |   |
|------------|---|
| diagram    |  |
| type       | <b>xs:date</b>  |
| properties | isRef 0<br>content simple   |

element **BondType/Durations/Duration/Value**

|            |   |
|------------|---|
| diagram    |  |
| type       | <b>xs:decimal</b>   |
| properties | isRef 0<br>content simple   |

element **BondType/Tranche**

|            |   |
|------------|---|
| diagram    |  |
| type       | <b>xs:decimal</b>   |
| properties | isRef 0<br>minOcc 0<br>maxOcc 1<br>content simple                                 |
| annotation | documentation<br>Number of tranche  |

element **BondType/ConvertibleBond**

|                   |   |
|-------------------|---|
| <p>diagram</p>    |   |
| <p>type</p>       | <p><a href="#">ConvertibleBondType</a></p>  |
| <p>properties</p> | <p>isRef 0<br/>minOcc 0<br/>maxOcc 1<br/>content complex</p>  |
| <p>children</p>   | <p><a href="#">Type</a> <a href="#">ConversionStartdate</a> <a href="#">ConversionEnddate</a> <a href="#">Underlying</a> <a href="#">ConversionPrice</a> <a href="#">ConversionRatio</a> <a href="#">ContractSize</a> <a href="#">ExecutionType</a></p> |
| <p>annotation</p> | <p>documentation<br/>Details for Convertibles<br/>documentation<br/>Details für Wandelanleihen</p>  |

## complexType CallCapitalType

|                   |   |
|-------------------|---|
| <p>diagram</p>    |   |
| <p>children</p>   | <p><a href="#">StartDate</a> <a href="#">MaturityDate</a> <a href="#">MethodForCalculationOfInterest</a> <a href="#">InterestRate</a> <a href="#">InterestRateDebit</a> <a href="#">InterestRateCredit</a> <a href="#">IndicatorCreditDebit</a> <a href="#">Counterparty</a> <a href="#">CollateralFlag</a> <a href="#">CollateralDirection</a></p> |
| <p>used by</p>    | <p>element <a href="#">AssetDetailsType/CallMoney</a></p>   |
| <p>annotation</p> | <p>documentation<br/>Call capital Asset data information</p>  |

## element CallCapitalType/StartDate

|                   |   |
|-------------------|---|
| <p>diagram</p>    |   |
| <p>type</p>       | <p><b>xs:date</b></p>                                       |
| <p>properties</p> | <p>isRef 0<br/>minOcc 0<br/>maxOcc 1<br/>content simple</p> |
| <p>annotation</p> | <p>documentation<br/>Start date of call money</p>           |

element **CallCapitalType/MaturityDate**

|            |  |
|------------|--|
| diagram    |             |
| type       | <b>xs:date</b>   |
| properties | isRef 0<br>content simple  |
| annotation | documentation<br>Maturity date of call capital<br>documentation<br>Gibt das Tilgungsdatum an |

element **CallCapitalType/MethodForCalculationOfInterest**

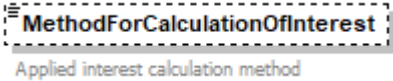
|            |  |
|------------|--|
| diagram    |   |
| type       | <b>xs:string</b>   |
| properties | isRef 0<br>minOcc 0<br>maxOcc 1<br>content simple  |
| annotation | documentation<br>Applied interest calculation method<br>documentation<br>Gibt an, nach welcher Methode die Zinsen berechnet werden |

element **CallCapitalType/InterestRate**

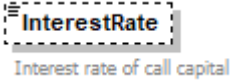
|            |  |
|------------|--|
| diagram    |         |
| type       | <b>xs:decimal</b>  |
| properties | isRef 0<br>minOcc 0<br>maxOcc 1<br>content simple  |
| annotation | documentation<br>Interest rate of call capital<br>documentation<br>Enthaelt einen Zinssatz |

element **CallCapitalType/InterestRateDebit**

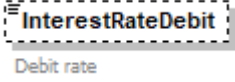
|            |   |
|------------|---|
| diagram    |  |
| type       | <b>xs:decimal</b>   |
| properties | isRef 0<br>minOcc 0<br>maxOcc 1<br>content simple                                   |



|            |  |
|------------|--|
| annotation | documentation<br><b>Debit rate</b><br>documentation<br>Zinssatz Soll |
|------------|--|

element **CallCapitalType/InterestRateCredit**

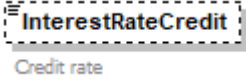
|            |   |
|------------|---|
| diagram    |  |
| type       | <b>xs:decimal</b>   |
| properties | isRef 0<br>minOcc 0<br>maxOcc 1<br>content simple                                 |
| annotation | documentation<br><b>Credit rate</b><br>documentation<br>Zinssatz Haben            |

element **CallCapitalType/IndicatorCreditDebit**

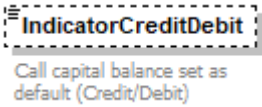
|            |   |
|------------|---|
| diagram    |    |
| type       | restriction of <b>xs:string</b>   |
| properties | isRef 0<br>minOcc 0<br>maxOcc 1<br>content simple   |
| annotation | documentation<br><b>Call capital balance set as default (Credit/Debit)</b><br>documentation<br>Gibt an ob das Konto default einen Soll oder Habensaldo aufweist |

element **CallCapitalType/Counterparty**

|            |  |
|------------|--|
| diagram    | <p>The diagram illustrates the structure of the <b>Counterparty</b> element. On the left, a box labeled <b>Counterparty</b> with the text "Counterparty details" is connected via a dashed line to a central connector. This connector is linked to a large yellow dashed box labeled <b>CompanyType</b>. Inside this box, several elements are listed vertically, each with a description and a small icon indicating its cardinality or type:</p> <ul style="list-style-type: none"> <li><b>Identifiers</b> (+): Identifiers of company</li> <li><b>Name</b>: Name of company</li> <li><b>LegalName</b>: Legal (full) name of company</li> <li><b>LegalForm</b>: Legal form of company</li> <li><b>Address</b> (+): Address of company</li> <li><b>BusinessCountry</b>: Country code of main business of company</li> <li><b>ParentCompany</b> (+): Parent company (if applicable)</li> <li><b>OtherClassification</b> (+): All other identifiers (with listed or free type) 0..∞</li> </ul> |
| type       | <a href="#">CompanyType</a>  |
| properties | isRef 0<br>content complex   |
| children   | <a href="#">Identifiers</a> <a href="#">Name</a> <a href="#">LegalName</a> <a href="#">LegalForm</a> <a href="#">Address</a> <a href="#">BusinessCountry</a> <a href="#">ParentCompany</a> <a href="#">OtherClassification</a>   |
| annotation | documentation<br>Counterparty details  |

element **CallCapitalType/CollateralFlag**

|            |  |
|------------|--|
| diagram    | <p>The diagram shows a single element box labeled <b>CollateralFlag</b> with a dashed border. Below the box is the text: "Indicates whether call money is used as collateral".</p> |
| type       | <b>xs:boolean</b>  |
| properties | isRef 0<br>minOcc 0<br>maxOcc 1<br>content simple  |
| annotation | documentation<br>Indicates whether call money is used as collateral  |

element **CallCapitalType/CollateralDirection**

|            |   |
|------------|---|
| diagram    |   |
| type       | restriction of <b>xs:string</b>                   |
| properties | isRef 0<br>minOcc 0<br>maxOcc 1<br>content simple |
| annotation | documentation<br>Paid or received by fund         |

complexType **CertificateType**

|            |  |
|------------|--|
| diagram    |  |
| children   | <a href="#">Type</a> <a href="#">Underlyings</a> <a href="#">StockMarket</a> <a href="#">Issuer</a> <a href="#">IssueDate</a> <a href="#">MaturityDate</a> |
| used by    | element <a href="#">AssetDetailsType/Certificate</a>   |
| annotation | documentation<br>Index Certificat Asset data information   |

element **CertificateType/Type**

|            |   |
|------------|---|
| diagram    |   |
| type       | restriction of <b>xs:string</b>   |
| properties | isRef 0<br>content simple   |
| annotation | documentation<br>Index, Security, Currency, Commodity, Interest Rate, Future, Other |

element **CertificateType/Underlyings**

|            |   |
|------------|---|
| diagram    | <p>1..∞<br/>Bezeichnet das dem Derivatprodukt unterlegte Wertpapier</p> |
| properties | <p>isRef 0<br/>minOcc 0<br/>maxOcc 1<br/>content complex</p>            |
| children   | <a href="#">Underlying</a>  |

element **CertificateType/Underlyings/Underlying**

|            |   |
|------------|---|
| diagram    | <p>1..∞<br/>Bezeichnet das dem Derivatprodukt unterlegte Wertpapier</p> <p><b>UnderlyingType</b></p> <ul style="list-style-type: none"> <li>Type: Currency, Security, Future, Index</li> <li>UniqueID</li> <li>Name</li> <li>Identifiers</li> <li>Nominale</li> </ul> |
| type       | <a href="#">UnderlyingType</a>  |
| properties | <p>isRef 0<br/>minOcc 1<br/>maxOcc unbounded<br/>content complex</p>  |
| children   | <a href="#">Type</a> <a href="#">UniqueID</a> <a href="#">Name</a> <a href="#">Identifiers</a> <a href="#">Nominale</a>   |
| annotation | <p>documentation<br/>Bezeichnet das dem Derivatprodukt unterlegte Wertpapier</p>  |

element **CertificateType/StockMarket**

|            |   |
|------------|---|
| diagram    | <p>0..∞<br/>MIC of the Exchange(s) at which the certificate is listed</p> |
| type       | <a href="#">MICCodeType</a>   |
| properties | <p>isRef 0<br/>minOcc 0<br/>maxOcc unbounded<br/>content simple</p>       |

|            |  |
|------------|--|
| facets     | Kind Value annotation<br>length 4  |
| annotation | documentation<br>MIC of the Exchange(s) at which the certificate is listed<br>documentation<br>Gibt den MIC des Boerseplatz an an dem das Wertpapier notiert<br>appinfo<br><altova:exampleValues><br><altova:example value="WBAH"/><br></altova:exampleValues> |

element **CertificateType/Issuer**

|            |   |
|------------|---|
| diagram    | <p>The diagram illustrates the structure of the <b>CompanyType</b> element. It is a complex type (indicated by a thick border) containing several child elements:</p> <ul style="list-style-type: none"> <li><b>Identifiers</b>: Identifiers of company (indicated by a plus sign icon).</li> <li><b>Name</b>: Name of company (indicated by a list icon).</li> <li><b>LegalName</b>: Legal (full) name of company (indicated by a list icon).</li> <li><b>LegalForm</b>: Legal form of company (indicated by a list icon).</li> <li><b>Address</b>: Address of company (indicated by a plus sign icon).</li> <li><b>BusinessCountry</b>: Country code of main business of company (indicated by a list icon).</li> <li><b>ParentCompany</b>: Parent company (if applicable) (indicated by a plus sign icon).</li> <li><b>OtherClassification</b>: All other identifiers (with listed or free type) (indicated by a plus sign icon and a cardinality of 0..∞).</li> </ul> <p>The <b>Issuer</b> element (Issuer details) is shown as a separate box connected to the <b>CompanyType</b> element via a dashed line.</p> |
| type       | <a href="#">CompanyType</a>   |
| properties | isRef 0<br>minOcc 0<br>maxOcc 1<br>content complex  |
| children   | <a href="#">Identifiers</a> <a href="#">Name</a> <a href="#">LegalName</a> <a href="#">LegalForm</a> <a href="#">Address</a> <a href="#">BusinessCountry</a> <a href="#">ParentCompany</a> <a href="#">OtherClassification</a>  |
| annotation | documentation<br>Issuer details   |

element **CertificateType/IssueDate**

|            |   |
|------------|---|
| diagram    |    |
| type       | <b>xs:date</b>  |
| properties | isRef 0<br>minOcc 0<br>maxOcc 1<br>content simple   |
| annotation | documentation<br>Issue date of the certificate<br>documentation<br>Emissionsdatum bezeichnet jenes Datum, zu dem das Wertpapier aufgelegt wurde |

element **CertificateType/MaturityDate**

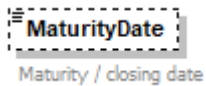
|            |   |
|------------|---|
| diagram    |  |
| type       | <b>xs:date</b>  |
| properties | isRef 0<br>minOcc 0<br>maxOcc 1<br>content simple                                 |
| annotation | documentation<br>Maturity / closing date  |

complexType **CommercialPaperType**

|                   |  |
|-------------------|--|
| <p>diagram</p>    | <p><b>CommercialPaperType</b><br/>Commercial Paper and Certificate of Deposit Master Data</p> <ul style="list-style-type: none"> <li><b>Issuer</b> (+)<br/>Issuer details</li> <li><b>StockMarket</b> (list icon)<br/>0..∞<br/>MIC of the Exchange(s) at which this bond is listed.</li> <li><b>Listing</b> (list icon)<br/>Indicator whether this bond is listed at an exchange<br/>A Listed at an official market<br/>B Listed at an exchange<br/>G Listed on a regular market<br/>K No listing<br/>M Listed on a regular market inside the EU<br/>S Unregulated market<br/>V Securitised rights<br/>Y Acceptance on unregulated market planned<br/>Z New issue</li> <li><b>ListingUnit</b> (list icon)<br/>Listing unit:<br/>P ... pieces<br/>N ... nominal amount</li> <li><b>IssueDate</b> (list icon)<br/>Issue date of the CP/CD</li> <li><b>MaturityDate</b> (list icon)<br/>Maturity date</li> <li><b>RedemptionRate</b> (list icon)<br/>Price at which the bond finally will be redeemed</li> <li><b>Coupon</b> (+)<br/>Coupon details</li> <li><b>InterestRate</b> (list icon)<br/>Nominal interest rate</li> <li><b>IsAssetBacked</b> (list icon)</li> </ul> |
| <p>children</p>   | <p><a href="#">Issuer</a> <a href="#">StockMarket</a> <a href="#">Listing</a> <a href="#">ListingUnit</a> <a href="#">IssueDate</a> <a href="#">MaturityDate</a> <a href="#">RedemptionRate</a> <a href="#">Coupon</a> <a href="#">InterestRate</a> <a href="#">IsAssetBacked</a></p>  |
| <p>used by</p>    | <p>element <a href="#">AssetDetailsType/CommercialPaper</a></p>  |
| <p>annotation</p> | <p>documentation<br/>Commercial Paper and Certificate of Deposit Master Data</p>   |

element **CommercialPaperType/Issuer**

|                   |   |
|-------------------|---|
| <p>diagram</p>    |   |
| <p>type</p>       | <p><a href="#">CompanyType</a></p>  |
| <p>properties</p> | <p>isRef 0<br/>content complex</p>  |
| <p>children</p>   | <p><a href="#">Identifiers</a> <a href="#">Name</a> <a href="#">LegalName</a> <a href="#">LegalForm</a> <a href="#">Address</a> <a href="#">BusinessCountry</a> <a href="#">ParentCompany</a> <a href="#">OtherClassification</a></p> |
| <p>annotation</p> | <p>documentation<br/>Issuer details<br/>documentation<br/>Enthaelt den Wertpapieremittenten</p>   |

element **CommercialPaperType/StockMarket**

|                   |   |
|-------------------|---|
| <p>diagram</p>    |   |
| <p>type</p>       | <p><a href="#">MICCodeType</a></p>                                  |
| <p>properties</p> | <p>isRef 0<br/>minOcc 0<br/>maxOcc unbounded<br/>content simple</p> |



|            |   |
|------------|---|
| facets     | Kind Value annotation<br><b>length</b> 4  |
| annotation | documentation<br>MIC of the Exchange(s) at which this bond is listed.<br>documentation<br>Gibt den MIC des Boerseplatz an an dem das Wertpapier notiert<br>appinfo<br><altova:exampleValues><br><altova:example value="WBAH"/><br></altova:exampleValues> |

element **CommercialPaperType/Listing**

|            |   |
|------------|---|
| diagram    |  <p>Indicator whether this bond is listed at an exchange<br/> A Listed at an official market<br/> B Listed at an exchange<br/> G Listed on a regular market<br/> K No listing<br/> M Listed on a regular market inside the EU<br/> S Unregulated market<br/> V Securitised rights<br/> Y Acceptance on unregulated market planned<br/> Z New issue</p>   |
| type       | restriction of <b>xs:string</b>   |
| properties | isRef 0<br>minOcc 0<br>maxOcc 1<br>content simple   |
| annotation | documentation<br>Indicator whether this bond is listed at an exchange<br>A Listed at an official market<br>B Listed at an exchange<br>G Listed on a regular market<br>K No listing<br>M Listed on a regular market inside the EU<br>S Unregulated market<br>V Securitised rights<br>Y Acceptance on unregulated market planned<br>Z New issue<br>documentation<br>Gibt an ob das Wertpapier an einer Boerse notiert<br><br>- A Amtlicher Handel<br>- B Boersennotierung Ausland<br>- G Geregelter Freiverkehr<br>- K Keine Boersennotierung<br>- M Geregelter Markt id. EU<br>- S Sonstiger Handel<br>- V Verbriefte Rechte<br>- Y Zulassung zum sonst. Handel vorges.<br>- Z Neuemission |

element **CommercialPaperType/ListingUnit**

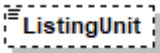
|            |  |
|------------|--|
| diagram    |  <p>Listing unit:<br/>P ... pieces<br/>N ... nominal amount</p> |
| type       | restriction of <b>xs:string</b>  |
| properties | <p>isRef 0<br/>minOcc 0<br/>maxOcc 1<br/>content simple</p>  |
| annotation | <p>documentation<br/>Listing unit:<br/>P ... pieces<br/>N ... nominal amount<br/>documentation<br/>S = Stueck<br/>oder<br/>N = Nominale</p>      |

element **CommercialPaperType/IssueDate**

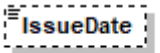
|            |   |
|------------|---|
| diagram    |  <p>Issue date of the CP/CD</p>                                    |
| type       | <b>xs:date</b>  |
| properties | <p>isRef 0<br/>minOcc 0<br/>maxOcc 1<br/>content simple</p>   |
| annotation | <p>documentation<br/>Issue date of the CP/CD<br/>documentation<br/>Emissionsdatum bezeichnet jenes Datum, zu dem das Wertpapier aufgelegt wurde</p> |

element **CommercialPaperType/MaturityDate**

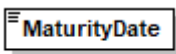
|            |  |
|------------|--|
| diagram    |  <p>Maturity date</p> |
| type       | <b>xs:date</b>   |
| properties | <p>isRef 0<br/>content simple</p>  |
| annotation | <p>documentation<br/>Maturity date<br/>documentation<br/>Ablaufdatum/Faelligkeitsdatum</p>               |

element **CommercialPaperType/RedemptionRate**

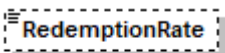
|         |   |
|---------|---|
| diagram |  <p>Price at which the bond<br/>finally will be redeemed</p> |
| type    | <b>xs:decimal</b>   |

|            |   |
|------------|---|
| properties | isRef 0<br>minOcc 0<br>maxOcc 1<br>content simple   |
| annotation | documentation<br>Price at which the bond finally will be redeemed<br>documentation<br>Enthält den Kurs zu dem das Wertpapier getilgt wird |

### element CommercialPaperType/Coupon

|            |   |
|------------|---|
| diagram    | <p>The diagram illustrates the structure of the <b>Coupon</b> element. It is a complex element containing five child elements:</p> <ul style="list-style-type: none"> <li><b>Type</b>: fix/float/zero/others</li> <li><b>PaymentFrequency</b>: Payment frequency (e.g. yearly)</li> <li><b>InterestRate</b></li> <li><b>BaseIndex</b>: e.g. EURIBOR 6 Months</li> <li><b>OffsetBPS</b>: Offset in base points in addition to BaseIndex</li> </ul> |
| properties | isRef 0<br>minOcc 0<br>maxOcc 1<br>content complex  |
| children   | <a href="#">Type</a> <a href="#">PaymentFrequency</a> <a href="#">InterestRate</a> <a href="#">BaseIndex</a> <a href="#">OffsetBPS</a>  |
| annotation | documentation<br>Coupon details   |

### element CommercialPaperType/Coupon/Type

|            |   |
|------------|---|
| diagram    |   |
| type       | restriction of <b>xs:string</b>                   |
| properties | isRef 0<br>minOcc 0<br>maxOcc 1<br>content simple |
| annotation | documentation<br>fix/float/zero/others            |

### element CommercialPaperType/Coupon/PaymentFrequency

|         |  |
|---------|--|
| diagram |  |
|---------|--|

|            |   |
|------------|---|
| type       | <a href="#">FrequencyType</a>                     |
| properties | isRef 0<br>minOcc 0<br>maxOcc 1<br>content simple |
| annotation | documentation<br>Payment frequency (e.g. yearly)  |

element **CommercialPaperType/Coupon/InterestRate**

|            |   |
|------------|---|
| diagram    |  |
| type       | <b>xs:decimal</b>   |
| properties | isRef 0<br>minOcc 0<br>maxOcc 1<br>content simple                                 |

element **CommercialPaperType/Coupon/BaseIndex**

diagram

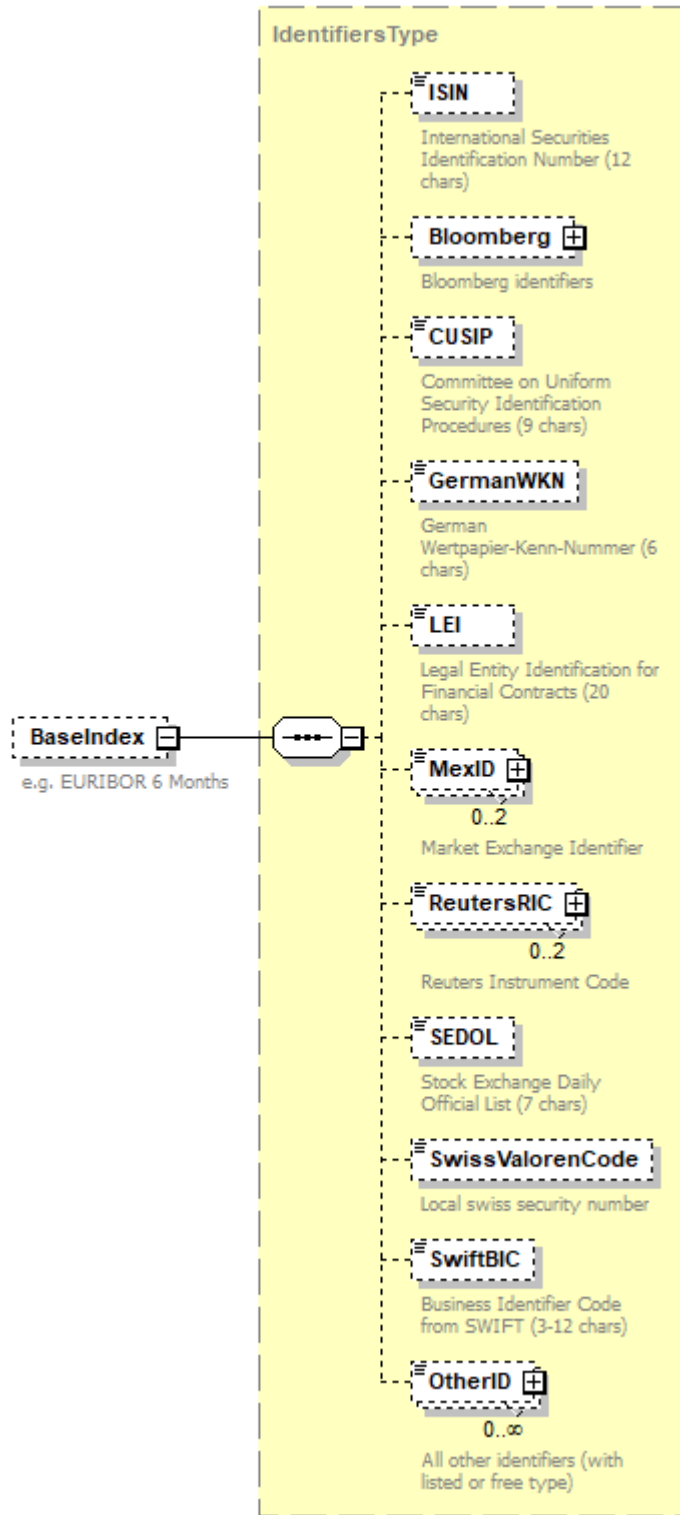

type [IdentifiersType](#)

properties  
 isRef 0  
 minOcc 0  
 maxOcc 1

|            |   |
|------------|---|
|            | content complex   |
| children   | <a href="#">ISIN</a> <a href="#">Bloomberg</a> <a href="#">CUSIP</a> <a href="#">GermanWKN</a> <a href="#">LEI</a> <a href="#">MexID</a> <a href="#">ReutersRIC</a> <a href="#">SEDOL</a> <a href="#">SwissValorenCode</a> <a href="#">SwiftBIC</a> <a href="#">OtherID</a> |
| annotation | documentation<br>e.g. EURIBOR 6 Months  |

#### element **CommercialPaperType/Coupon/OffsetBPS**

|            |   |
|------------|---|
| diagram    |  |
| type       | <b>xs:decimal</b>   |
| properties | isRef 0<br>minOcc 0<br>maxOcc 1<br>content simple                                 |
| annotation | documentation<br>Offset in base points in addition to BaseIndex                   |

#### element **CommercialPaperType/InterestRate**

|            |  |
|------------|--|
| diagram    |   |
| type       | <b>xs:decimal</b>  |
| properties | isRef 0<br>minOcc 0<br>maxOcc 1<br>content simple                                  |
| annotation | documentation<br>Nominal interest rate<br>documentation<br>Enthaelt einen Zinssatz |

#### element **CommercialPaperType/IsAssetBacked**

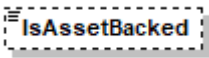
|            |   |
|------------|---|
| diagram    |  |
| type       | <a href="#">YesNoType</a>   |
| properties | isRef 0<br>minOcc 0<br>maxOcc 1<br>content simple                                   |

### complexType ConvertibleBondType

|                   |  |
|-------------------|--|
| <p>diagram</p>    | <p><b>ConvertibleBondType</b><br/>Convertible Bond Asset data information</p> <ul style="list-style-type: none"> <li><b>Type</b><br/>MCS ... Mandatory convertible security<br/>COCO ... Contingent convertible bond<br/>EXCH ... Exchangables</li> <li><b>ConversionStartdate</b><br/>Startdatum der Wandlung</li> <li><b>ConversionEnddate</b><br/>Enddatum der Wandlung</li> <li><b>Underlying</b> <math>\oplus</math><br/>Identifiers of underlying security</li> <li><b>ConversionPrice</b><br/>Preis der Wandlung</li> <li><b>ConversionRatio</b><br/>Conversion ratio (Wandlungsfaktor)</li> <li><b>ContractSize</b><br/>Kontraktgrösse</li> <li><b>ExecutionType</b><br/>Issuer, Bearer, Both</li> </ul> |
| <p>children</p>   | <p><a href="#">Type</a> <a href="#">ConversionStartdate</a> <a href="#">ConversionEnddate</a> <a href="#">Underlying</a> <a href="#">ConversionPrice</a> <a href="#">ConversionRatio</a> <a href="#">ContractSize</a> <a href="#">ExecutionType</a></p>  |
| <p>used by</p>    | <p>element <a href="#">BondType/ConvertibleBond</a></p>  |
| <p>annotation</p> | <p>documentation<br/>Convertible Bond Asset data information</p>   |

### element ConvertibleBondType/Type

|                   |  |
|-------------------|--|
| <p>diagram</p>    | <p><b>Type</b><br/>MCS ... Mandatory convertible security<br/>COCO ... Contingent convertible bond<br/>EXCH ... Exchangables</p>   |
| <p>type</p>       | <p>restriction of <b>xs:string</b></p>   |
| <p>properties</p> | <p>isRef 0<br/>minOcc 0<br/>maxOcc 1<br/>content simple</p>  |
| <p>annotation</p> | <p>documentation<br/>MCS ... Mandatory convertible security<br/>COCO ... Contingent convertible bond<br/>EXCH ... Exchangables</p> |

element **ConvertibleBondType/ConversionStartdate**

|            |   |
|------------|---|
| diagram    |  |
| type       | <b>xs:date</b>  |
| properties | isRef 0<br>minOcc 0<br>maxOcc 1<br>content simple                                 |
| annotation | documentation<br>Startdatum der Wandlung  |

element **ConvertibleBondType/ConversionEnddate**

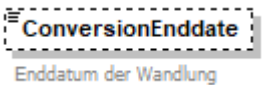
|            |   |
|------------|---|
| diagram    |  |
| type       | <b>xs:date</b>  |
| properties | isRef 0<br>minOcc 0<br>maxOcc 1<br>content simple                                 |
| annotation | documentation<br>Enddatum der Wandlung  |



element **ConvertibleBondType/Underlying**

diagram

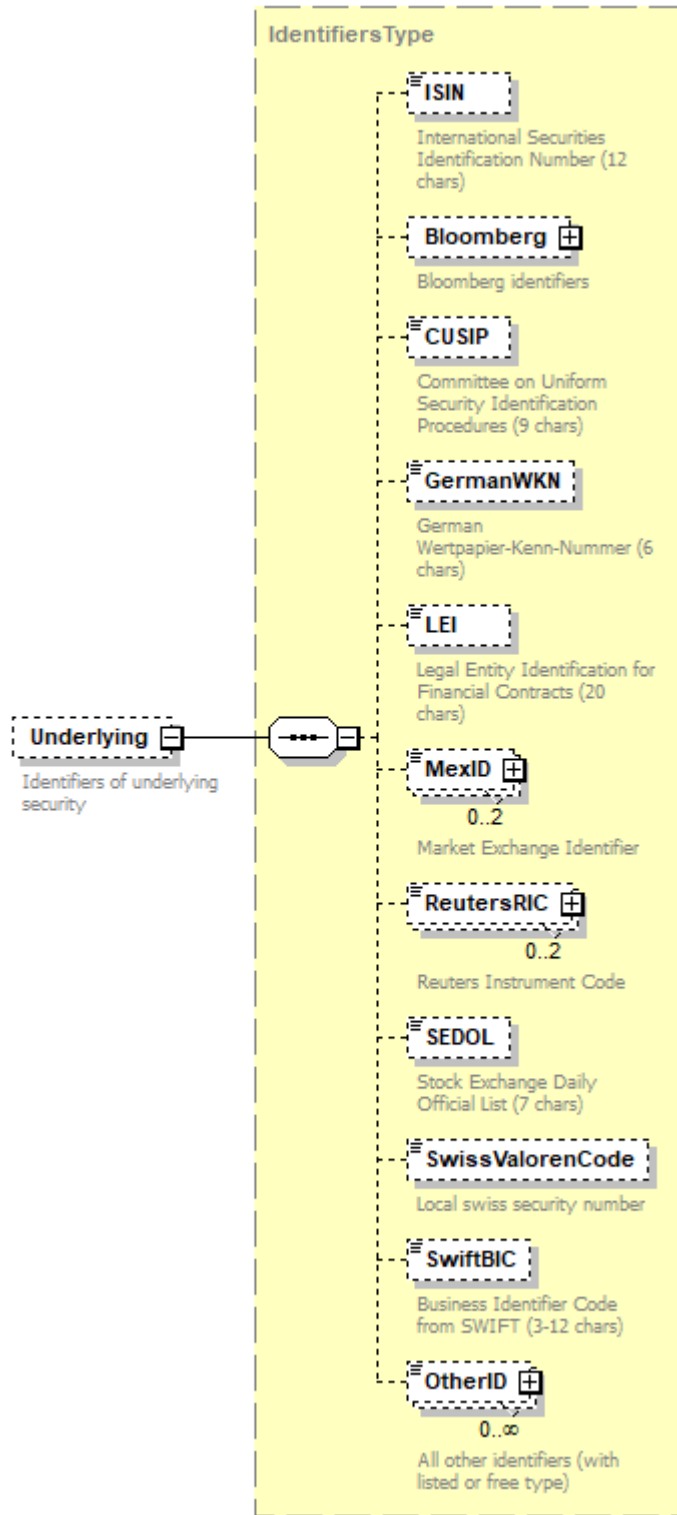

type [IdentifiersType](#)

properties  
 isRef 0  
 minOcc 0  
 maxOcc 1

|            |   |
|------------|---|
|            | content complex   |
| children   | <a href="#">ISIN</a> <a href="#">Bloomberg</a> <a href="#">CUSIP</a> <a href="#">GermanWKN</a> <a href="#">LEI</a> <a href="#">MexID</a> <a href="#">ReutersRIC</a> <a href="#">SEDOL</a> <a href="#">SwissValorenCode</a> <a href="#">SwiftBIC</a> <a href="#">OtherID</a> |
| annotation | documentation<br>Identifiers of underlying security   |

#### element **ConvertibleBondType/ConversionPrice**

|            |   |
|------------|---|
| diagram    |  |
| type       | <b>xs:decimal</b>   |
| properties | isRef 0<br>minOcc 0<br>maxOcc 1<br>content simple                                 |
| annotation | documentation<br>Preis der Wandlung   |

#### element **ConvertibleBondType/ConversionRatio**

|            |   |
|------------|---|
| diagram    |  |
| type       | <b>xs:decimal</b>   |
| properties | isRef 0<br>minOcc 0<br>maxOcc 1<br>content simple                                 |
| annotation | documentation<br>Conversion ratio (Wandlungsfaktor)                               |

#### element **ConvertibleBondType/ContractSize**

|            |   |
|------------|---|
| diagram    |  |
| type       | <b>xs:decimal</b>   |
| properties | isRef 0<br>minOcc 0<br>maxOcc 1<br>content simple                                   |
| annotation | documentation<br>Kontraktgrosse   |

#### element **ConvertibleBondType/ExecutionType**

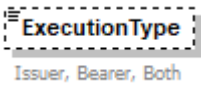
|            |   |
|------------|---|
| diagram    |  |
| type       | restriction of <b>xs:string</b>   |
| properties | isRef 0<br>minOcc 0   |

|            |                                       |
|------------|---------------------------------------|
|            | maxOcc 1<br>content simple            |
| annotation | documentation<br>Issuer, Bearer, Both |

### complexType CounterpartyType

|            |  |
|------------|--|
| diagram    |  |
| children   | <a href="#">BIC</a> <a href="#">Name</a> <a href="#">LEI</a> <a href="#">Country</a> |
| annotation | documentation<br>Defines the counterparty  |

### element CounterpartyType/BIC

|            |  |
|------------|--|
| diagram    |  |
| type       | <a href="#">BicCodeType</a>                          |
| properties | isRef 0<br>minOcc 0<br>maxOcc 1<br>content simple    |
| facets     | Kind Value annotation<br>minLength 3<br>maxLength 12 |
| annotation | documentation<br>BIC code of the counterparty        |

### element CounterpartyType/Name

|            |   |
|------------|---|
| diagram    |   |
| type       | <b>xs:string</b>                                  |
| properties | isRef 0<br>minOcc 0<br>maxOcc 1<br>content simple |

|            |   |
|------------|---|
| annotation | documentation<br>Name of the counterparty |
|------------|---|

### element CounterpartyType/LEI

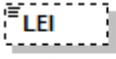
|            |  |
|------------|--|
| diagram    |  <p>Legal Entity Identifier (LEI)<br/>(ISO 17442 standard) of the<br/>Entity.</p> |
| type       | <a href="#">LEICodeType</a>  |
| properties | isRef 0<br>minOcc 0<br>maxOcc 1<br>content simple  |
| facets     | Kind Value annotation<br>minLength 20<br>maxLength 20<br>pattern ([0-9a-zA-Z]{18}[0-9]{2})   |
| annotation | documentation<br>Legal Entity Identifier (LEI) (ISO 17442 standard) of the Entity.   |

### element CounterpartyType/Country

|            |   |
|------------|---|
| diagram    |  <p>Country of asset (two<br/>character ISO code)</p> |
| type       | <a href="#">ISOCountryCodeType</a>  |
| properties | isRef 0<br>minOcc 0<br>maxOcc 1<br>content simple   |
| facets     | Kind Value annotation<br>minLength 2<br>maxLength 2   |
| annotation | documentation<br>Country of asset (two character ISO code)  |

complexType **EquityType**

diagram

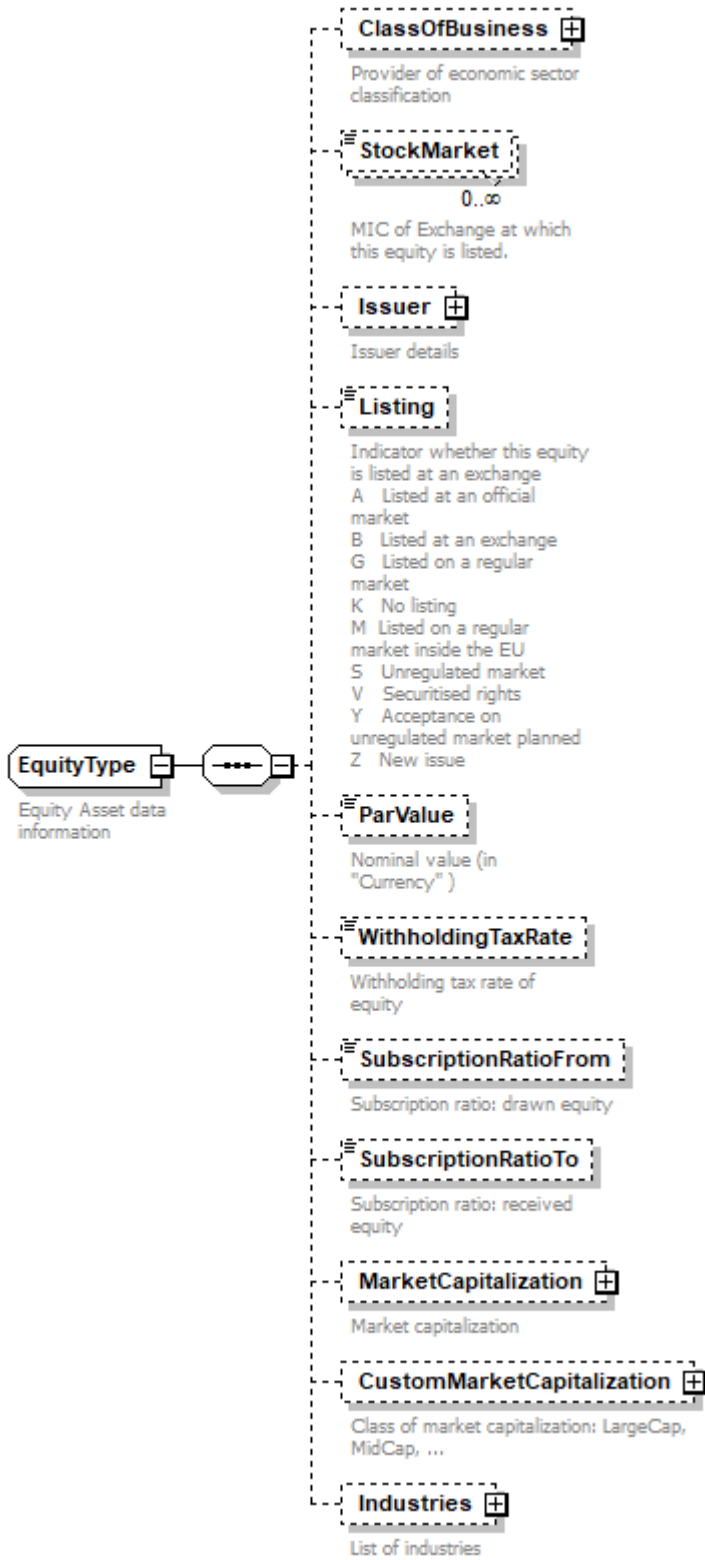

children

[ClassOfBusiness](#) [StockMarket](#) [Issuer](#) [Listing](#) [ParValue](#) [WithholdingTaxRate](#) [SubscriptionRatioFrom](#) [SubscriptionRatioTo](#) [MarketCapitalization](#) [CustomMarketCapitalization](#) [Industries](#)

|            |   |
|------------|---|
| used by    | element <a href="#">AssetDetailsType/Equity</a> |
| annotation | documentation<br>Equity Asset data information  |

element **EquityType/ClassOfBusiness**

|            |  |
|------------|--|
| diagram    |  |
| type       | <a href="#">IndustryProviderType</a>   |
| properties | isRef 0<br>minOcc 0<br>maxOcc 1<br>content complex   |
| children   | <a href="#">Offeror</a> <a href="#">Date</a> <a href="#">Value</a> <a href="#">Text</a>              |
| annotation | documentation<br>Provider of economic sector classification<br>documentation<br>Enhaelt den Anbieter |

element **EquityType/StockMarket**

|            |  |
|------------|--|
| diagram    |  |
| type       | <a href="#">MICCodeType</a>  |
| properties | isRef 0<br>minOcc 0<br>maxOcc unbounded<br>content simple  |
| facets     | Kind Value annotation<br>length 4  |
| annotation | documentation<br>MIC of Exchange at which this equity is listed.<br>documentation<br>Gibt den Boerseplatz an an dem das Wertpapier notiert<br>appinfo<br><altova:exampleValues><br><altova:example value="WBAH"/><br><altova:example value="EGSI"/><br></altova:exampleValues> |

element **EquityType/Issuer**

|                   |  |
|-------------------|--|
| <p>diagram</p>    | <p><b>CompanyType</b></p> <ul style="list-style-type: none"> <li><b>Identifiers</b> (+) Identifiers of company</li> <li><b>Name</b> Name of company</li> <li><b>LegalName</b> Legal (full) name of company</li> <li><b>LegalForm</b> Legal form of company</li> <li><b>Address</b> (+) Address of company</li> <li><b>BusinessCountry</b> Country code of main business of company</li> <li><b>ParentCompany</b> (+) Parent company (if applicable)</li> <li><b>OtherClassification</b> (+) All other identifiers (with listed or free type) <br/> 0..∞</li> </ul> <p><b>Issuer</b> (-) Issuer details</p> |
| <p>type</p>       | <p><a href="#">CompanyType</a></p>   |
| <p>properties</p> | <p>isRef 0<br/> minOcc 0<br/> maxOcc 1<br/> content complex</p>  |
| <p>children</p>   | <p><a href="#">Identifiers</a> <a href="#">Name</a> <a href="#">LegalName</a> <a href="#">LegalForm</a> <a href="#">Address</a> <a href="#">BusinessCountry</a> <a href="#">ParentCompany</a> <a href="#">OtherClassification</a></p>  |
| <p>annotation</p> | <p>documentation<br/> <b>Issuer details</b><br/> documentation<br/> Enthält den Wertpapieremittenten</p>   |

element **EquityType/Listing**

|            |  |
|------------|--|
| diagram    |  <p>Indicator whether this equity is listed at an exchange</p> <p>A Listed at an official market</p> <p>B Listed at an exchange</p> <p>G Listed on a regular market</p> <p>K No listing</p> <p>M Listed on a regular market inside the EU</p> <p>S Unregulated market</p> <p>V Securitised rights</p> <p>Y Acceptance on unregulated market planned</p> <p>Z New issue</p>  |
| type       | restriction of <b>xs:string</b>  |
| properties | <p>isRef 0</p> <p>minOcc 0</p> <p>maxOcc 1</p> <p>content simple</p>   |
| annotation | <p>documentation</p> <p>Indicator whether this equity is listed at an exchange</p> <p>A Listed at an official market</p> <p>B Listed at an exchange</p> <p>G Listed on a regular market</p> <p>K No listing</p> <p>M Listed on a regular market inside the EU</p> <p>S Unregulated market</p> <p>V Securitised rights</p> <p>Y Acceptance on unregulated market planned</p> <p>Z New issue</p> <p>documentation</p> <p>Gibt an ob das Wertpapier an einer Boerse notiert</p> <ul style="list-style-type: none"> <li>- A Amtlicher Handel</li> <li>- B Boersennotierung Ausland</li> <li>- G Geregelter Freiverkehr</li> <li>- K Keine Boersenotierung</li> <li>- M Geregelter Markt id. EU</li> <li>- S Sonstiger Handel</li> <li>- V Verbriefte Rechte</li> <li>- Y Zulassung zum sonst. Handel vorges.</li> <li>- Z Neuemission</li> </ul> |

element **EquityType/ParValue**

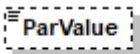
|            |   |
|------------|---|
| diagram    |  <p>Nominal value (in "Currency" )</p> |
| type       | <b>xs:decimal</b>   |
| properties | <p>isRef 0</p> <p>minOcc 0</p> <p>maxOcc 1</p> <p>content simple</p>  |
| annotation | <p>documentation</p> <p>Nominal value (in "Currency" )</p> <p>documentation</p> <p>Gibt den Nennwert der Aktie an</p>     |

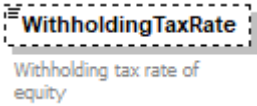

element **EquityType/WithholdingTaxRate**

|            |   |
|------------|---|
| diagram    |                |
| type       | <b>xs:decimal</b>   |
| properties | isRef 0<br>minOcc 0<br>maxOcc 1<br>content simple   |
| annotation | documentation<br><b>Withholding tax rate of equity</b><br>documentation<br>Quest Satz der Aktie |

element **EquityType/SubscriptionRatioFrom**

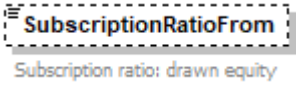
|            |   |
|------------|---|
| diagram    |    |
| type       | <b>xs:decimal</b>   |
| properties | isRef 0<br>minOcc 0<br>maxOcc 1<br>content simple   |
| annotation | documentation<br><b>Subscription ratio: drawn equity</b><br>documentation<br>Gibt das Bezugsverhaeltnis "von" an<br><br>- X:1 |

element **EquityType/SubscriptionRatioTo**

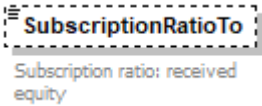
|            |   |
|------------|---|
| diagram    |    |
| type       | <b>xs:decimal</b>   |
| properties | isRef 0<br>minOcc 0<br>maxOcc 1<br>content simple   |
| annotation | documentation<br><b>Subscription ratio: received equity</b><br>documentation<br>Gibt das Bezugsverhaeltnis "zu" an<br><br>- 1:X |

element **EquityType/MarketCapitalization**

|            |  |
|------------|--|
| diagram    | <p>The diagram shows a dashed box labeled <b>MarketCapitalization</b> with the text "Market capitalization" below it. This box is connected to a central circle containing three dots. From this circle, two lines branch out to two separate boxes: <b>Date</b> and <b>Value</b>. Below the <b>Value</b> box is the text "In Currency".</p> |
| properties | <p>isRef 0<br/> minOcc 0<br/> maxOcc 1<br/> content complex</p>  |
| children   | <p><a href="#">Date</a> <a href="#">Value</a></p>  |
| annotation | <p>documentation<br/> Market capitalization</p>  |

element **EquityType/MarketCapitalization/Date**

|            |  |
|------------|--|
| diagram    | <p>The diagram shows a single box labeled <b>Date</b>.</p> |
| type       | <p><b>xs:date</b></p>                                      |
| properties | <p>isRef 0<br/> content simple</p>                         |

element **EquityType/MarketCapitalization/Value**

|            |  |
|------------|--|
| diagram    | <p>The diagram shows a single box labeled <b>Value</b> with the text "In Currency" below it.</p> |
| type       | <p><b>xs:decimal</b></p>   |
| properties | <p>isRef 0<br/> content simple</p>   |
| annotation | <p>documentation<br/> In Currency</p>  |

element **EquityType/CustomMarketCapitalization**

|            |  |
|------------|--|
| diagram    | <p>The diagram shows a dashed box labeled <b>CustomMarketCapitalization</b> with the text "Class of market capitalization: LargeCap, MidCap, ..." below it. This box is connected to a central circle containing three dots. From this circle, three lines branch out to three separate boxes: <b>Name</b>, <b>Date</b>, and <b>Value</b>. Below the <b>Name</b> box is the text "Name of capitalization class".</p> |
| properties | <p>isRef 0<br/> minOcc 0<br/> maxOcc 1<br/> content complex</p>  |
| children   | <p><a href="#">Name</a> <a href="#">Date</a> <a href="#">Value</a></p>   |
| annotation | <p>documentation<br/> Class of market capitalization: LargeCap, MidCap, ...</p>  |

element **EquityType/CustomMarketCapitalization/Name**

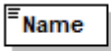
|            |   |
|------------|---|
| diagram    |  <p>Name of capitalization class</p> |
| type       | restriction of <b>xs:string</b>   |
| properties | isRef 0<br>content simple   |
| annotation | documentation<br>Name of capitalization class   |

element **EquityType/CustomMarketCapitalization/Date**

|            |   |
|------------|---|
| diagram    |  |
| type       | <b>xs:date</b>  |
| properties | isRef 0<br>content simple   |

element **EquityType/CustomMarketCapitalization/Value**

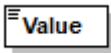
|            |   |
|------------|---|
| diagram    |  |
| type       | <b>xs:decimal</b>   |
| properties | isRef 0<br>content simple   |

element **EquityType/Industries**

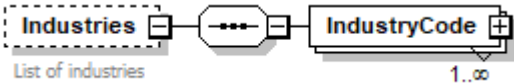
|            |   |
|------------|---|
| diagram    |  |
| properties | isRef 0<br>minOcc 0<br>maxOcc 1<br>content complex                                  |
| children   | <a href="#">IndustryCode</a>  |
| annotation | documentation<br>List of industries   |

element **EquityType/Industries/IndustryCode**

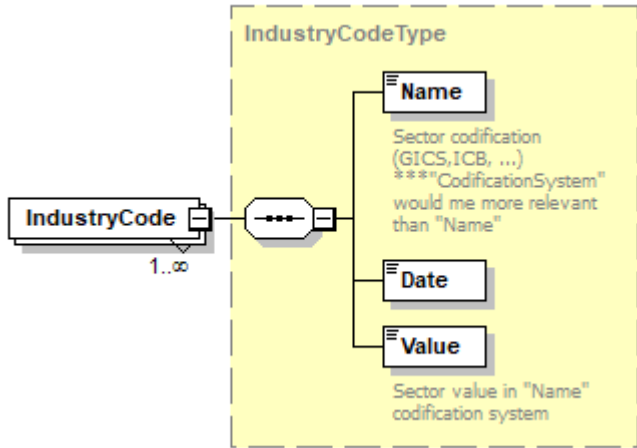
|            |   |
|------------|---|
| diagram    |  |
| type       | <a href="#">IndustryCodeType</a>  |
| properties | isRef 0<br>minOcc 1<br>maxOcc unbounded<br>content complex  |
| children   | <a href="#">Name</a> <a href="#">Date</a> <a href="#">Value</a>   |

complexType **FeeType**

|          |   |
|----------|---|
| diagram  |  |
| children | <a href="#">Type</a> <a href="#">Counterparty</a>                                   |
| used by  | element <a href="#">AssetDetailsType/Fee</a>  |

element **FeeType/Type**

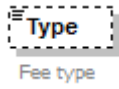
|            |   |
|------------|---|
| diagram    |  |
| type       | <b>xs:string</b>  |
| properties | isRef 0<br>minOcc 0<br>maxOcc 1<br>content simple                                   |
| annotation | documentation<br><b>Fee type</b>  |

element **FeeType/Counterparty**

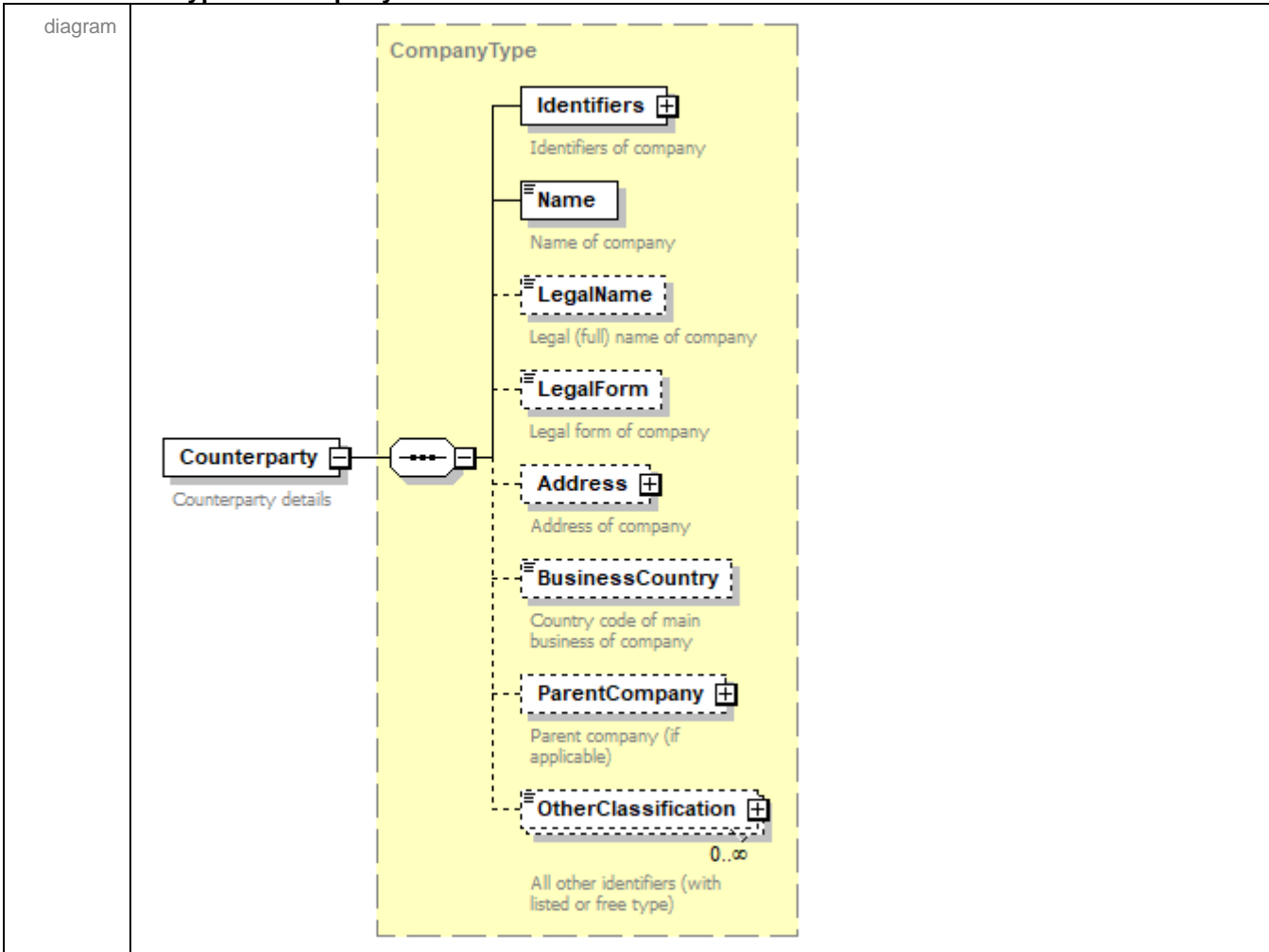

|            |  |
|------------|--|
| type       | <a href="#">CompanyType</a>  |
| properties | isRef 0<br>content complex   |
| children   | <a href="#">Identifiers</a> <a href="#">Name</a> <a href="#">LegalName</a> <a href="#">LegalForm</a> <a href="#">Address</a> <a href="#">BusinessCountry</a> <a href="#">ParentCompany</a> <a href="#">OtherClassification</a> |
| annotation | documentation<br>Counterparty details  |

### complexType FixedTimeDepositType

|            |   |
|------------|---|
| diagram    |   |
| children   | <a href="#">StartDate</a> <a href="#">MaturityDate</a> <a href="#">MethodForCalculationOfInterest</a> <a href="#">InterestRate</a> <a href="#">InterestRateDebit</a> <a href="#">InterestRateCredit</a> <a href="#">IndicatorCreditDebit</a> <a href="#">Counterparty</a> |
| used by    | element <a href="#">AssetDetailsType/FixedTimeDeposit</a>   |
| annotation | documentation<br>Fixed Time Asset data information  |

### element FixedTimeDepositType/StartDate

|            |   |
|------------|---|
| diagram    |   |
| type       | xs:date   |
| properties | isRef 0<br>minOcc 0<br>maxOcc 1<br>content simple |
| annotation | documentation<br>Start date of deposit            |

### element FixedTimeDepositType/MaturityDate

|         |         |
|---------|---------|
| diagram |         |
| type    | xs:date |

|            |   |
|------------|---|
| properties | isRef 0<br>content simple   |
| annotation | documentation<br>Maturity date of deposit<br>documentation<br>Gibt das Tilgungsdatum an |

element **FixedTimeDepositType/MethodForCalculationOfInterest**

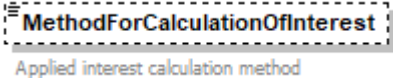
|            |   |
|------------|---|
| diagram    |  The diagram shows a rectangular box with a dashed border and a small icon in the top-left corner. Inside the box, the text "MethodForCalculationOfInterest" is written in bold. Below the box, the text "Applied interest calculation method" is written in a smaller font. |
| type       | <b>xs:string</b>  |
| properties | isRef 0<br>minOcc 0<br>maxOcc 1<br>content simple   |
| annotation | documentation<br>Applied interest calculation method<br>documentation<br>Gibt an, nach welcher Methode die Zinsen berechnet werden  |

element **FixedTimeDepositType/InterestRate**

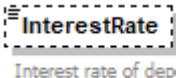
|            |   |
|------------|---|
| diagram    |  The diagram shows a rectangular box with a dashed border and a small icon in the top-left corner. Inside the box, the text "InterestRate" is written in bold. Below the box, the text "Interest rate of deposit" is written in a smaller font. |
| type       | <b>xs:decimal</b>   |
| properties | isRef 0<br>minOcc 0<br>maxOcc 1<br>content simple   |
| annotation | documentation<br>Interest rate of deposit<br>documentation<br>Enthaelt einen Zinssatz   |

element **FixedTimeDepositType/InterestRateDebit**

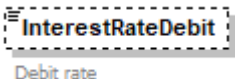
|            |   |
|------------|---|
| diagram    |  The diagram shows a rectangular box with a dashed border and a small icon in the top-left corner. Inside the box, the text "InterestRateDebit" is written in bold. Below the box, the text "Debit rate" is written in a smaller font. |
| type       | <b>xs:decimal</b>   |
| properties | isRef 0<br>minOcc 0<br>maxOcc 1<br>content simple   |
| annotation | documentation<br>Debit rate<br>documentation<br>Zinssatz Soll   |

element **FixedTimeDepositType/InterestRateCredit**

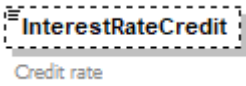
|            |   |
|------------|---|
| diagram    |  |
| type       | <b>xs:decimal</b>   |
| properties | isRef 0<br>minOcc 0<br>maxOcc 1<br>content simple                                 |
| annotation | documentation<br><b>Credit rate</b><br>documentation<br>Zinssatz Haben            |

element **FixedTimeDepositType/IndicatorCreditDebit**

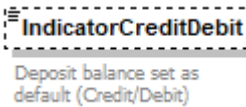
|            |  |
|------------|--|
| diagram    |   |
| type       | restriction of <b>xs:string</b>  |
| properties | isRef 0<br>minOcc 0<br>maxOcc 1<br>content simple  |
| annotation | documentation<br><b>Deposit balance set as default (Credit/Debit)</b><br>documentation<br>Gibt an ob das Konto default einen Soll oder Habensaldo aufweist |



element **FixedTimeDepositType/Counterparty**

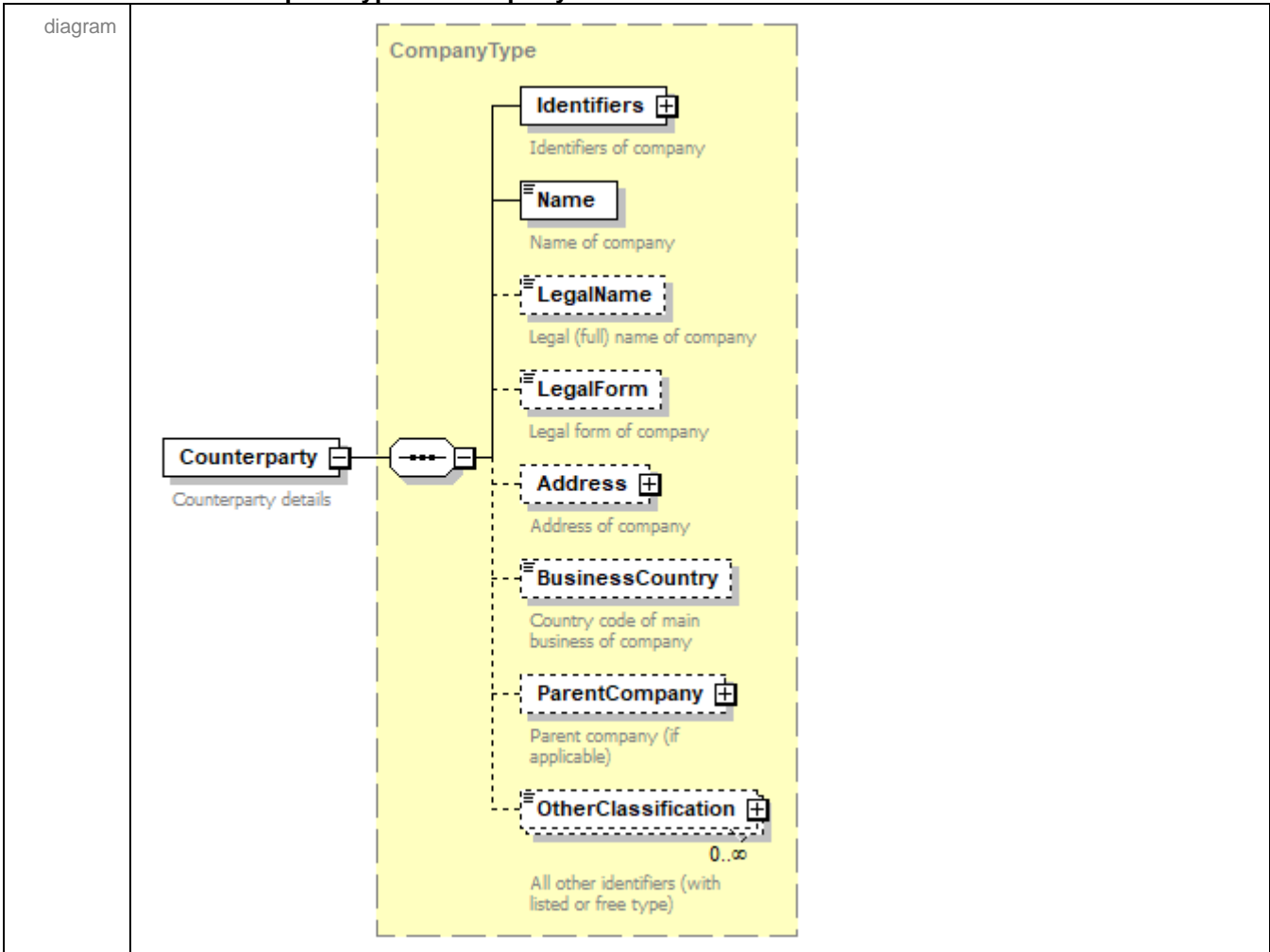

|            |  |
|------------|--|
| type       | <a href="#">CompanyType</a>  |
| properties | isRef 0<br>content complex   |
| children   | <a href="#">Identifiers</a> <a href="#">Name</a> <a href="#">LegalName</a> <a href="#">LegalForm</a> <a href="#">Address</a> <a href="#">BusinessCountry</a> <a href="#">ParentCompany</a> <a href="#">OtherClassification</a> |
| annotation | documentation<br>Counterparty details  |

complexType **ForeignExchangeTradeType**

|            |  |
|------------|--|
| diagram    |  |
| children   | <a href="#">CurrencyBuy</a> <a href="#">AmountBuy</a> <a href="#">CurrencySell</a> <a href="#">AmountSell</a> <a href="#">AgreedFxRate</a> <a href="#">StartDate</a> <a href="#">MaturityDate</a> <a href="#">Counterparty</a> <a href="#">Deliverable</a> |
| used by    | element <a href="#">AssetDetailsType/FXForward</a>   |
| annotation | documentation<br>Foreign Exchange Asset data information   |

element **ForeignExchangeTradeType/CurrencyBuy**

| diagram    |   |            |       |            |           |   |  |           |   |  |         |          |  |
|------------|---|------------|-------|------------|-----------|---|--|-----------|---|--|---------|----------|--|
| type       | <a href="#">ISOCurrencyCodeType</a>   |            |       |            |           |   |  |           |   |  |         |          |  |
| properties | isRef 0<br>content simple   |            |       |            |           |   |  |           |   |  |         |          |  |
| facets     | <table border="1"> <thead> <tr> <th>Kind</th> <th>Value</th> <th>annotation</th> </tr> </thead> <tbody> <tr> <td>minLength</td> <td>3</td> <td></td> </tr> <tr> <td>maxLength</td> <td>3</td> <td></td> </tr> <tr> <td>pattern</td> <td>[A-Z]{3}</td> <td></td> </tr> </tbody> </table> | Kind       | Value | annotation | minLength | 3 |  | maxLength | 3 |  | pattern | [A-Z]{3} |  |
| Kind       | Value   | annotation |       |            |           |   |  |           |   |  |         |          |  |
| minLength  | 3   |            |       |            |           |   |  |           |   |  |         |          |  |
| maxLength  | 3   |            |       |            |           |   |  |           |   |  |         |          |  |
| pattern    | [A-Z]{3}  |            |       |            |           |   |  |           |   |  |         |          |  |
| annotation | documentation<br>Currency bought  |            |       |            |           |   |  |           |   |  |         |          |  |

element **ForeignExchangeTradeType/AmountBuy**

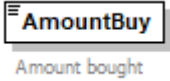
|            |   |
|------------|---|
| diagram    |  |
| type       | <b>xs:decimal</b>   |
| properties | isRef 0<br>content simple   |
| annotation | documentation<br>Amount bought  |

element **ForeignExchangeTradeType/CurrencySell**

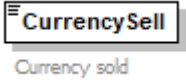
|            |   |
|------------|---|
| diagram    |  |
| type       | <a href="#">ISOCurrencyCodeType</a>   |
| properties | isRef 0<br>content simple   |
| facets     | Kind Value annotation<br>minLength 3<br>maxLength 3<br>pattern [A-Z]{3}           |
| annotation | documentation<br>Currency sold  |

element **ForeignExchangeTradeType/AmountSell**

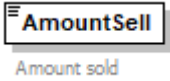
|            |   |
|------------|---|
| diagram    |  |
| type       | <b>xs:decimal</b>   |
| properties | isRef 0<br>content simple   |
| annotation | documentation<br>Amount sold  |

element **ForeignExchangeTradeType/AgreedFxRate**

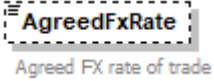
|            |   |
|------------|---|
| diagram    |  |
| type       | <b>xs:decimal</b>   |
| properties | isRef 0<br>minOcc 0<br>maxOcc 1<br>content simple                                   |
| annotation | documentation<br>Agreed FX rate of trade  |

element **ForeignExchangeTradeType/StartDate**

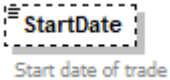
|            |   |
|------------|---|
| diagram    |  |
| type       | <b>xs:date</b>  |
| properties | isRef 0<br>minOcc 0<br>maxOcc 1<br>content simple                                 |
| annotation | documentation<br><b>Start date of trade</b>                                       |

element **ForeignExchangeTradeType/MaturityDate**

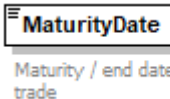
|            |   |
|------------|---|
| diagram    |  |
| type       | <b>xs:date</b>  |
| properties | isRef 0<br>content simple   |
| annotation | documentation<br><b>Maturity / end date of FX trade</b>                           |

element **ForeignExchangeTradeType/Counterparty**

|            |   |
|------------|---|
| diagram    | <p>The diagram illustrates the structure of the <b>Counterparty</b> element. It is composed of a <b>Counterparty</b> container (Counterparty details) which contains a <b>CompanyType</b> container. The <b>CompanyType</b> container includes the following elements:</p> <ul style="list-style-type: none"> <li><b>Identifiers</b>: Identifiers of company</li> <li><b>Name</b>: Name of company</li> <li><b>LegalName</b>: Legal (full) name of company</li> <li><b>LegalForm</b>: Legal form of company</li> <li><b>Address</b>: Address of company</li> <li><b>BusinessCountry</b>: Country code of main business of company</li> <li><b>ParentCompany</b>: Parent company (if applicable)</li> <li><b>OtherClassification</b>: All other identifiers (with listed or free type) 0..∞</li> </ul> |
| type       | <a href="#">CompanyType</a>   |
| properties | isRef 0<br>content complex  |
| children   | <a href="#">Identifiers</a> <a href="#">Name</a> <a href="#">LegalName</a> <a href="#">LegalForm</a> <a href="#">Address</a> <a href="#">BusinessCountry</a> <a href="#">ParentCompany</a> <a href="#">OtherClassification</a>  |
| annotation | documentation<br>Counterparty details   |

element **ForeignExchangeTradeType/Deliverable**

|            |  |
|------------|--|
| diagram    | <p>The diagram shows the <b>Deliverable</b> element, which is a simple content type. Its description is: "Defines whether currencies will be delivered at maturity or profit/loss will be transferred only (NDF)".</p> |
| type       | <b>xs:boolean</b>  |
| properties | isRef 0<br>minOcc 0<br>maxOcc 1<br>content simple  |
| annotation | documentation<br>Defines whether currencies will be delivered at maturity or profit/loss will be transferred only (NDF)  |



# complexType FutureType

diagram

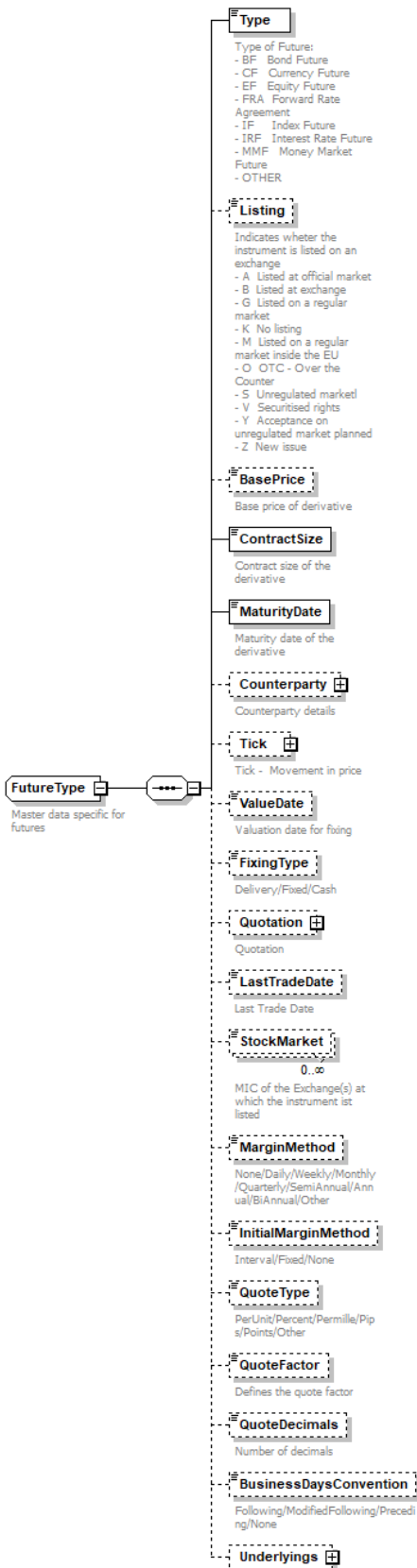

|            |   |
|------------|---|
| children   | <a href="#">Type</a> <a href="#">Listing</a> <a href="#">BasePrice</a> <a href="#">ContractSize</a> <a href="#">MaturityDate</a> <a href="#">Counterparty</a> <a href="#">Tick</a> <a href="#">ValueDate</a> <a href="#">FixingType</a> <a href="#">Quotation</a> <a href="#">LastTradeDate</a> <a href="#">StockMarket</a> <a href="#">MarginMethod</a> <a href="#">InitialMarginMethod</a> <a href="#">QuoteType</a> <a href="#">QuoteFactor</a> <a href="#">QuoteDecimals</a> <a href="#">BusinessDaysConvention</a> <a href="#">Underlyings</a> |
| used by    | element <a href="#">AssetDetailsType/Future</a>   |
| annotation | documentation<br>Master data specific for futures   |

### element [FutureType/Type](#)

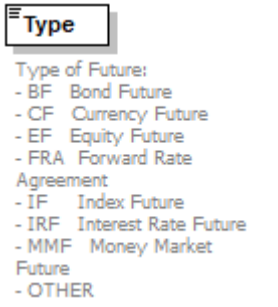
|            |   |
|------------|---|
| diagram    |  <p><b>Type</b></p> <p>Type of Future:</p> <ul style="list-style-type: none"> <li>- BF Bond Future</li> <li>- CF Currency Future</li> <li>- EF Equity Future</li> <li>- FRA Forward Rate Agreement</li> <li>- IF Index Future</li> <li>- IRF Interest Rate Future</li> <li>- MMF Money Market Future</li> <li>- OTHER</li> </ul> |
| type       | restriction of <b>xs:string</b>   |
| properties | isRef 0<br>content simple   |
| annotation | documentation<br>Type of Future:  |
|            | <ul style="list-style-type: none"> <li>- BF Bond Future</li> <li>- CF Currency Future</li> <li>- EF Equity Future</li> <li>- FRA Forward Rate Agreement</li> <li>- IF Index Future</li> <li>- IRF Interest Rate Future</li> <li>- MMF Money Market Future</li> <li>- OTHER</li> </ul>   |

### element [FutureType/Listing](#)

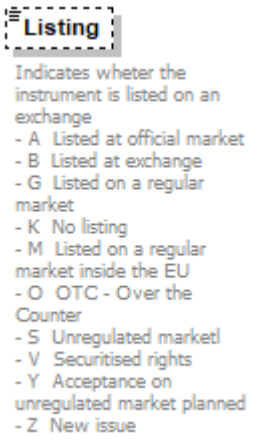
|            |  |
|------------|--|
| diagram    |  <p><b>Listing</b></p> <p>Indicates wheter the instrument is listed on an exchange</p> <ul style="list-style-type: none"> <li>- A Listed at official market</li> <li>- B Listed at exchange</li> <li>- G Listed on a regular market</li> <li>- K No listing</li> <li>- M Listed on a regular market inside the EU</li> <li>- O OTC - Over the Counter</li> <li>- S Unregulated market</li> <li>- V Securitised rights</li> <li>- Y Acceptance on unregulated market planned</li> <li>- Z New issue</li> </ul> |
| type       | restriction of <b>xs:string</b>  |
| properties | isRef 0<br>minOcc 0<br>maxOcc 1<br>content simple  |



|            |   |
|------------|---|
| annotation | <p>documentation</p> <p>Indicates wheter the instrument is listed on an exchange</p> <ul style="list-style-type: none"> <li>- A Listed at official market</li> <li>- B Listed at exchange</li> <li>- G Listed on a regular market</li> <li>- K No listing</li> <li>- M Listed on a regular market inside the EU</li> <li>- O OTC - Over the Counter</li> <li>- S Unregulated marketl</li> <li>- V Securitised rights</li> <li>- Y Acceptance on unregulated market planned</li> <li>- Z New issue</li> </ul> <p>documentation</p> <p>Gibt an ob das Wertpapier an einer Boerse notiert</p> <ul style="list-style-type: none"> <li>- A Amtlicher Handel</li> <li>- B Boersennotierung Ausland</li> <li>- G Geregelter Freiverkehr</li> <li>- K Keine Boersennotierung</li> <li>- M Geregelter Markt id. EU</li> <li>- O OTC - Over the Counter</li> <li>- S Sonstiger Handel</li> <li>- V Verbriefte Rechte</li> <li>- Y Zulassung zum sonst. Handel vorges.</li> <li>- Z Neuemission</li> </ul> |
|------------|---|

element **FutureType/BasePrice**

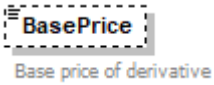
|            |   |
|------------|---|
| diagram    |    |
| type       | <b>xs:decimal</b>   |
| properties | <p>isRef 0</p> <p>minOcc 0</p> <p>maxOcc 1</p> <p>content simple</p>  |
| annotation | <p>documentation</p> <p>Base price of derivative</p> <p>documentation</p> <p>Gibt den Basispreis des Derivativenprodukts an</p> |

element **FutureType/ContractSize**

|            |  |
|------------|--|
| diagram    |   |
| type       | <b>xs:decimal</b>  |
| properties | <p>isRef 0</p> <p>content simple</p>   |
| annotation | <p>documentation</p> <p>Contract size of the derivative</p> <p>documentation</p> <p>Gibt die Kontraktgroesze des Derivativprodukt an</p> |

element **FutureType/MaturityDate**

|            |   |
|------------|---|
| diagram    |                                    |
| type       | <b>xs:date</b>  |
| properties | isRef 0<br>content simple   |
| annotation | documentation<br>Maturity date of the derivative<br>documentation<br>Bezeichnet das Ablaufdatum des Derivatprodukts |

element **FutureType/Counterparty**

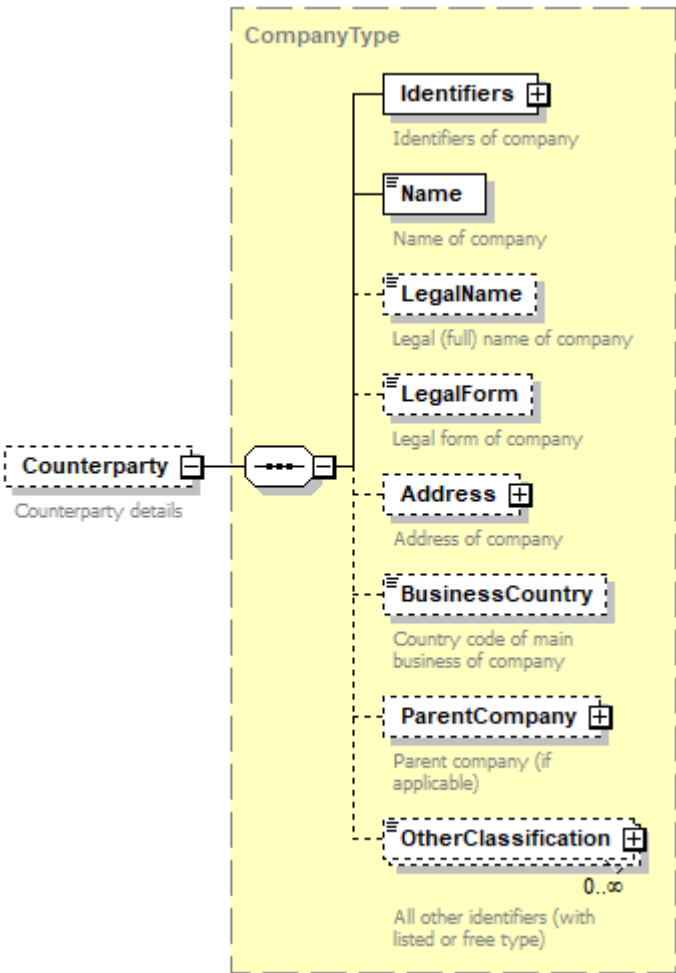
|            |  |
|------------|--|
| diagram    |    |
| type       | <a href="#">CompanyType</a>  |
| properties | isRef 0<br>minOcc 0<br>maxOcc 1<br>content complex   |
| children   | <a href="#">Identifiers</a> <a href="#">Name</a> <a href="#">LegalName</a> <a href="#">LegalForm</a> <a href="#">Address</a> <a href="#">BusinessCountry</a> <a href="#">ParentCompany</a> <a href="#">OtherClassification</a> |
| annotation | documentation<br>Counterparty details  |

element **FutureType/Tick**

|            |  |
|------------|--|
| diagram    |  |
| properties | isRef 0<br>minOcc 0<br>maxOcc 1<br>content complex |
| children   | <a href="#">TickSize</a> <a href="#">TickValue</a> |
| annotation | documentation<br>Tick - Movement in price          |

element **FutureType/Tick/TickSize**

|            |   |
|------------|---|
| diagram    |   |
| type       | <b>xs:decimal</b>   |
| properties | isRef 0<br>content simple                                     |
| annotation | documentation<br>Minimum downward or upward movement in price |

element **FutureType/Tick/TickValue**

|            |                                    |
|------------|------------------------------------|
| diagram    |                                    |
| type       | <a href="#">AmountType</a>         |
| properties | isRef 0<br>content complex         |
| children   | <a href="#">Amount</a>             |
| annotation | documentation<br>Value of the tick |

element **FutureType/ValueDate**

|         |  |
|---------|--|
| diagram |  |
|---------|--|

|            |   |
|------------|---|
| type       | <b>xs:date</b>                                    |
| properties | isRef 0<br>minOcc 0<br>maxOcc 1<br>content simple |
| annotation | documentation<br>Valuation date for fixing        |

**element FutureType/FixingType**

|            |   |
|------------|---|
| diagram    |   |
| type       | restriction of <b>xs:string</b>                   |
| properties | isRef 0<br>minOcc 0<br>maxOcc 1<br>content simple |
| annotation | documentation<br>Delivery/Fixed/Cash              |

**element FutureType/Quotation**

|            |  |
|------------|--|
| diagram    |  |
| properties | isRef 0<br>minOcc 0<br>maxOcc 1<br>content complex   |
| children   | <a href="#">QuotationType</a> <a href="#">QuotationPercent</a> <a href="#">QuotationAmount</a> |
| annotation | documentation<br>Quotation   |

**element FutureType/Quotation/QuotationType**

|            |   |
|------------|---|
| diagram    |   |
| type       | restriction of <b>xs:string</b>                   |
| properties | isRef 0<br>minOcc 0<br>maxOcc 1<br>content simple |
| annotation | documentation<br>Price/Yield/Other                |

element **FutureType/Quotation/QuotationPercent**

|            |   |
|------------|---|
| diagram    |  <p>The diagram shows a dashed box containing the text <b>QuotationPercent</b> and the description "Quotation in percent".</p> |
| type       | <b>xs:float</b>   |
| properties | isRef 0<br>minOcc 0<br>maxOcc 1<br>content simple   |
| annotation | documentation<br>Quotation in percent   |

element **FutureType/Quotation/QuotationAmount**

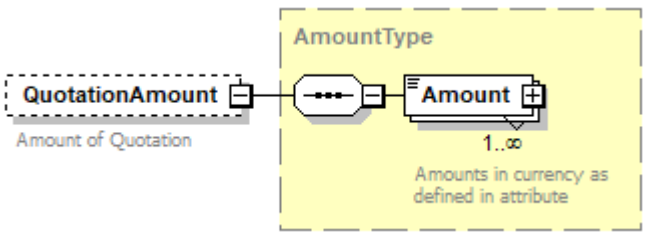
|            |   |
|------------|---|
| diagram    |  <p>The diagram shows a dashed box containing the text <b>QuotationAmount</b> and the description "Amount of Quotation". To the right, a yellow box labeled <b>AmountType</b> contains a diagram of the <b>Amount</b> element with the description "Amounts in currency as defined in attribute" and the cardinality "1..∞".</p> |
| type       | <a href="#">AmountType</a>  |
| properties | isRef 0<br>minOcc 0<br>maxOcc 1<br>content complex  |
| children   | <a href="#">Amount</a>  |
| annotation | documentation<br>Amount of Quotation  |

element **FutureType/LastTradeDate**

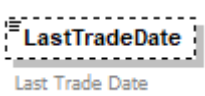
|            |   |
|------------|---|
| diagram    |  <p>The diagram shows a dashed box containing the text <b>LastTradeDate</b> and the description "Last Trade Date".</p> |
| type       | <b>xs:date</b>  |
| properties | isRef 0<br>minOcc 0<br>maxOcc 1<br>content simple   |
| annotation | documentation<br>Last Trade Date  |

element **FutureType/StockMarket**

|         |  |
|---------|--|
| diagram |  <p>The diagram shows a dashed box containing the text <b>StockMarket</b> and the cardinality "0..∞". Below this, the text reads: "MIC of the Exchange(s) at which the instrument is listed".</p> |
| type    | <a href="#">MICCodeType</a>  |

|            |  |
|------------|--|
| properties | isRef 0<br>minOcc 0<br>maxOcc unbounded<br>content simple  |
| facets     | Kind Value annotation<br>length 4  |
| annotation | documentation<br>MIC of the Exchange(s) at which the instrument ist listed<br>documentation<br>Gibt den MIC des Boerseplatz an an dem der Future notiert<br>appinfo<br><altova:exampleValues><br><altova:example value="WBAH"/><br></altova:exampleValues> |

#### element FutureType/MarginMethod

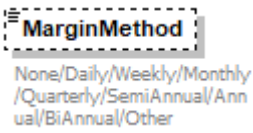
|            |   |
|------------|---|
| diagram    |      |
| type       | restriction of <b>xs:string</b>   |
| properties | isRef 0<br>minOcc 0<br>maxOcc 1<br>content simple                                     |
| annotation | documentation<br>None/Daily/Weekly/Monthly/Quarterly/SemiAnnual/Annual/BiAnnual/Other |

#### element FutureType/InitialMarginMethod

|            |   |
|------------|---|
| diagram    |  |
| type       | restriction of <b>xs:string</b>   |
| properties | isRef 0<br>minOcc 0<br>maxOcc 1<br>content simple                                   |
| annotation | documentation<br>Interval/Fixed/None  |

#### element FutureType/QuoteType

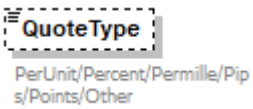
|            |   |
|------------|---|
| diagram    |  |
| type       | restriction of <b>xs:string</b>   |
| properties | isRef 0<br>minOcc 0<br>maxOcc 1<br>content simple                                   |
| annotation | documentation<br>PerUnit/Percent/Per mille/Pips/Points/Other                        |

element **FutureType/QuoteFactor**

|            |   |
|------------|---|
| diagram    |  |
| type       | <b>xs:decimal</b>   |
| properties | isRef 0<br>minOcc 0<br>maxOcc 1<br>content simple                                 |
| annotation | documentation<br>Defines the quote factor   |

element **FutureType/QuoteDecimals**

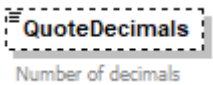
|            |   |
|------------|---|
| diagram    |  |
| type       | <b>xs:decimal</b>   |
| properties | isRef 0<br>minOcc 0<br>maxOcc 1<br>content simple                                 |
| annotation | documentation<br>Number of decimals   |

element **FutureType/BusinessDaysConvention**

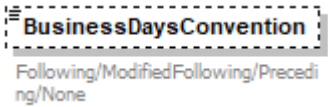
|            |   |
|------------|---|
| diagram    |  |
| type       | restriction of <b>xs:string</b>   |
| properties | isRef 0<br>minOcc 0<br>maxOcc 1<br>content simple                                   |
| annotation | documentation<br>Following/ModifiedFollowing/Preceding/None                         |

element **FutureType/Underlyings**

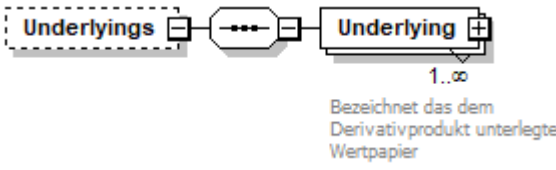
|            |   |
|------------|---|
| diagram    |  |
| properties | isRef 0<br>minOcc 0<br>maxOcc 1<br>content complex                                  |
| children   | <a href="#">Underlying</a>  |

element **FutureType/Underlyings/Underlying**

|            |   |
|------------|---|
| diagram    | <p>The diagram shows a class <b>Underlying</b> with a cardinality of <b>1..∞</b> and the description "Bezeichnet das dem Derivatvprodukt unterlegte Wertpapier". It is connected to a complex type <b>UnderlyingType</b> (highlighted in yellow). <b>UnderlyingType</b> contains the following elements: <b>Type</b> (with values Currency, Security, Future, Index), <b>UniqueID</b>, <b>Name</b>, <b>Identifiers</b> (with a plus sign), and <b>Nominale</b>.</p> |
| type       | <a href="#">UnderlyingType</a>  |
| properties | isRef 0<br>minOcc 1<br>maxOcc unbounded<br>content complex  |
| children   | <a href="#">Type</a> <a href="#">UniqueID</a> <a href="#">Name</a> <a href="#">Identifiers</a> <a href="#">Nominale</a>   |
| annotation | documentation<br>Bezeichnet das dem Derivatvprodukt unterlegte Wertpapier   |

complexType **IndexType**

|            |  |
|------------|--|
| diagram    | <p>The diagram shows a class <b>IndexType</b> with the description "Index Asset data information". It is connected to a complex type <b>IndexType</b> (highlighted in yellow) which contains the following elements: <b>SourceCompany</b> (with a plus sign), <b>Market</b>, and <b>RiskIndicator</b>.</p> |
| children   | <a href="#">SourceCompany</a> <a href="#">Market</a> <a href="#">RiskIndicator</a>   |
| annotation | documentation<br>Index Asset data information  |

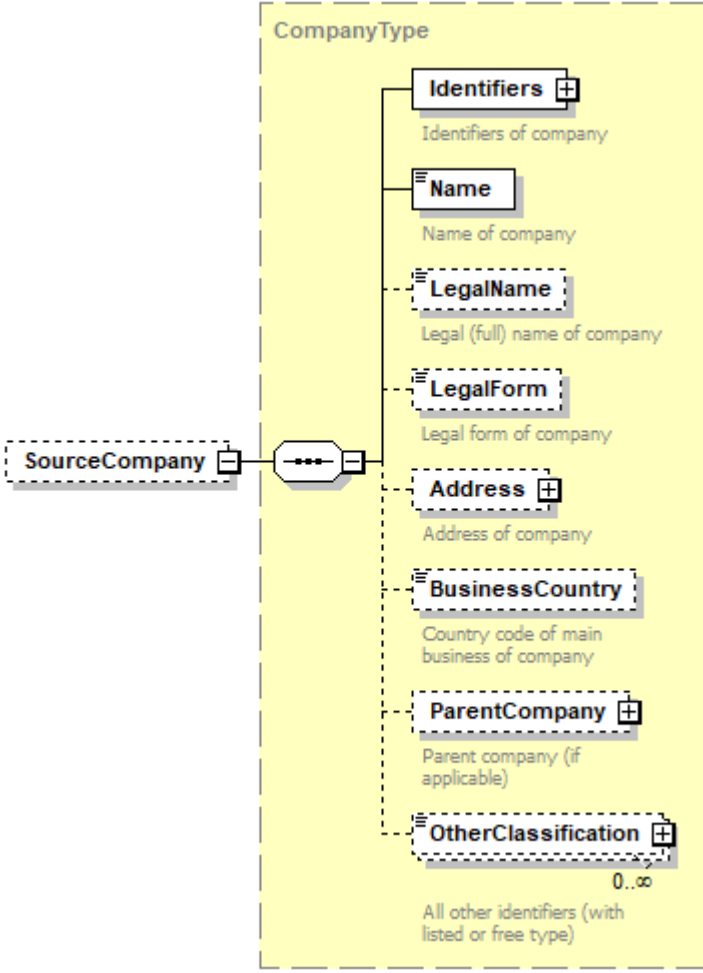

element **IndexType/SourceCompany**

|                   |   |
|-------------------|---|
| <p>diagram</p>    |   |
| <p>type</p>       | <p><a href="#">CompanyType</a></p>  |
| <p>properties</p> | <p>isRef 0<br/>minOcc 0<br/>maxOcc 1<br/>content complex</p>  |
| <p>children</p>   | <p><a href="#">Identifiers</a> <a href="#">Name</a> <a href="#">LegalName</a> <a href="#">LegalForm</a> <a href="#">Address</a> <a href="#">BusinessCountry</a> <a href="#">ParentCompany</a> <a href="#">OtherClassification</a></p> |

element **IndexType/Market**

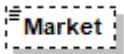
|                   |   |
|-------------------|---|
| <p>diagram</p>    |  |
| <p>properties</p> | <p>isRef 0<br/>minOcc 0<br/>maxOcc 1</p>  |

element **IndexType/RiskIndicator**

|                |   |
|----------------|---|
| <p>diagram</p> |  |
|----------------|---|

|            |   |
|------------|---|
| type       | restriction of <b>xs:string</b>                   |
| properties | isRef 0<br>minOcc 0<br>maxOcc 1<br>content simple |

**complexType IndustryCodeType**

|          |  |
|----------|--|
| diagram  |  |
| children | <a href="#">Name</a> <a href="#">Date</a> <a href="#">Value</a>  |
| used by  | elements <a href="#">AssetDetailsType/Commodity/Industries/IndustryCode</a> <a href="#">EquityType/Industries/IndustryCode</a> |

**element IndustryCodeType/Name**

|            |   |
|------------|---|
| diagram    |   |
| type       | <b>xs:string</b>  |
| properties | isRef 0<br>content simple   |
| annotation | documentation<br>Sector codification (GICS, ICB, ...)<br>***CodificationSystem*** would me more relevant than "Name"<br>documentation<br>GICS,lehman,ICB. |

**element IndustryCodeType/Date**

|            |                           |
|------------|---------------------------|
| diagram    |                           |
| type       | <b>xs:date</b>            |
| properties | isRef 0<br>content simple |

element **IndustryCodeType/Value**

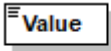
|            |   |
|------------|---|
| diagram    |  <p>Sector value in "Name" codification system</p> |
| type       | <b>xs:decimal</b>   |
| properties | isRef 0<br>content simple   |
| annotation | documentation<br>Sector value in "Name" codification system   |

complexType **IndustryProviderType**

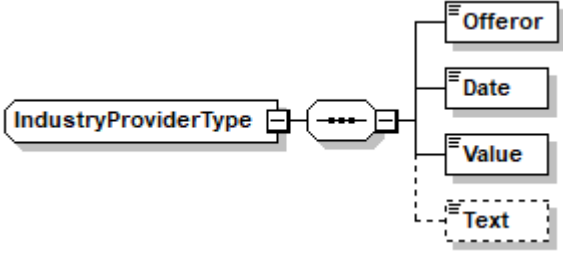
|          |   |
|----------|---|
| diagram  |        |
| children | <a href="#">Offeror</a> <a href="#">Date</a> <a href="#">Value</a> <a href="#">Text</a> |
| used by  | element <a href="#">EquityType/ClassOfBusiness</a>                                      |

element **IndustryProviderType/Offeror**

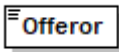
|            |   |
|------------|---|
| diagram    |  |
| type       | <b>xs:string</b>  |
| properties | isRef 0<br>content simple   |

element **IndustryProviderType/Date**

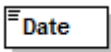
|            |   |
|------------|---|
| diagram    |  |
| type       | <b>xs:date</b>  |
| properties | isRef 0<br>content simple   |

element **IndustryProviderType/Value**

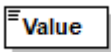
|            |   |
|------------|---|
| diagram    |  |
| type       | <b>xs:string</b>  |
| properties | isRef 0<br>content simple   |

element **IndustryProviderType/Text**

|            |   |
|------------|---|
| diagram    |  |
| type       | restriction of <b>xs:string</b>   |
| properties | isRef 0<br>minOcc 0<br>maxOcc 1<br>content simple                                 |
| facets     | Kind Value annotation<br>maxLength 128  |

complexType **LegType**

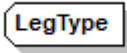
|         |   |
|---------|---|
| diagram |  |
| used by | element <a href="#">SwapType/Legs/Leg</a>   |

## complexType LoanType

|                 |   |
|-----------------|---|
| <p>diagram</p>  | <p><b>FundRole</b><br/>Fund is LENDER or BORROWER</p> <p><b>Counterparty</b> <br/>Counterparty details</p> <p><b>StartDate</b> <br/>Start date of loan</p> <p><b>MaturityDate</b><br/>Maturity date of the loan</p> <p><b>Collateralization</b> <br/>Indicates whether the loan is collateralized. Boolean: true/false</p> <p><b>InterestRateType</b> <br/>Interest rate type of the loan fixed/variable</p> <p><b>InterestHedgedBy</b> <br/>Unique ID of the underlying derivative for interest rate risk hedging</p> <p><b>FxHedgedBy</b> <br/>Unique ID of the underlying derivative for FX risk hedging</p> <p><b>CorrespondingRealEstate</b> <br/>Loan is used for this real estate</p> <p><b>PayableOnDemand</b> <br/>Loan is daily due</p> <p><b>InterestRate</b> <br/>Interest rate of loan</p> |
| <p>children</p> | <p><a href="#">FundRole</a> <a href="#">Counterparty</a> <a href="#">StartDate</a> <a href="#">MaturityDate</a> <a href="#">Collateralization</a> <a href="#">InterestRateType</a> <a href="#">InterestHedgedBy</a> <a href="#">FxHedgedBy</a> <a href="#">CorrespondingRealEstate</a> <a href="#">PayableOnDemand</a> <a href="#">InterestRate</a></p>   |
| <p>used by</p>  | <p>element <a href="#">AssetDetailsType/Loan</a></p>  |

## element LoanType/FundRole

|                |   |
|----------------|---|
| <p>diagram</p> | <p><b>FundRole</b><br/>Fund is LENDER or BORROWER</p> |
|----------------|---|

|            |   |
|------------|---|
| type       | restriction of <b>xs:string</b>             |
| properties | isRef 0<br>content simple                   |
| annotation | documentation<br>Fund is LENDER or BORROWER |

element **LoanType/Counterparty**

|            |  |
|------------|--|
| diagram    | <p>The diagram illustrates the structure of the <b>Counterparty</b> element. It is composed of a <b>Counterparty</b> container and a <b>CompanyType</b> container. The <b>Counterparty</b> container is connected to the <b>CompanyType</b> container. The <b>CompanyType</b> container contains the following elements:</p> <ul style="list-style-type: none"> <li><b>Identifiers</b>: Identifiers of company (cardinality: 1..∞)</li> <li><b>Name</b>: Name of company (cardinality: 1)</li> <li><b>LegalName</b>: Legal (full) name of company (cardinality: 1)</li> <li><b>LegalForm</b>: Legal form of company (cardinality: 1)</li> <li><b>Address</b>: Address of company (cardinality: 1)</li> <li><b>BusinessCountry</b>: Country code of main business of company (cardinality: 1)</li> <li><b>ParentCompany</b>: Parent company (if applicable) (cardinality: 1)</li> <li><b>OtherClassification</b>: All other identifiers (with listed or free type) (cardinality: 0..∞)</li> </ul> |
| type       | <a href="#">CompanyType</a>  |
| properties | isRef 0<br>content complex   |
| children   | <a href="#">Identifiers</a> <a href="#">Name</a> <a href="#">LegalName</a> <a href="#">LegalForm</a> <a href="#">Address</a> <a href="#">BusinessCountry</a> <a href="#">ParentCompany</a> <a href="#">OtherClassification</a>   |
| annotation | documentation<br>Counterparty details  |

element **LoanType/StartDate**

|         |   |
|---------|---|
| diagram | <p>The diagram shows the <b>StartDate</b> element, represented by a dashed box with the text "StartDate" and "Start date of loan" below it.</p> |
| type    | <b>xs:date</b>  |

|            |   |
|------------|---|
| properties | isRef 0<br>minOcc 0<br>maxOcc 1<br>content simple |
| annotation | documentation<br>Start date of loan               |

### element **LoanType/MaturityDate**

|            |  |
|------------|--|
| diagram    |         |
| type       | <b>xs:date</b>   |
| properties | isRef 0<br>content simple  |
| annotation | documentation<br>Maturity date of the loan<br>documentation<br>Gibt das Tilgungsdatum an |

### element **LoanType/Collateralization**

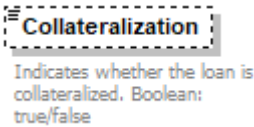
|            |  |
|------------|--|
| diagram    |    |
| type       | <b>xs:boolean</b>  |
| properties | isRef 0<br>minOcc 0<br>maxOcc 1<br>content simple  |
| annotation | documentation<br>Indicates whether the loan is collateralized. Boolean: true/false<br>documentation<br>Besicherung ja/nein;<br>True = Ja<br>False = Nein |

### element **LoanType/InterestRateType**

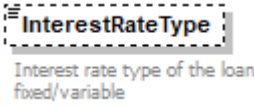
|            |   |
|------------|---|
| diagram    |                          |
| type       | restriction of <b>xs:string</b>   |
| properties | isRef 0<br>minOcc 0<br>maxOcc 1<br>content simple   |
| annotation | documentation<br>Interest rate type of the loan<br>fixed/variable<br>documentation<br>Zinssatz fix/variabel |

element **LoanType/InterestHedgedBy**

|            |   |
|------------|---|
| diagram    |    |
| type       | <b>xs:IDREF</b>   |
| properties | isRef 0<br>minOcc 0<br>maxOcc 1<br>content simple   |
| annotation | documentation<br><b>Unique ID of the underlying derivative for interest rate risk hedging</b><br>documentation<br><b>Unique ID des zuordenbaren Derivates zur Zinsabsicherung</b> |

element **LoanType/FxHedgedBy**

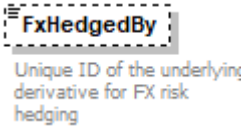
|            |  |
|------------|--|
| diagram    |   |
| type       | <b>xs:IDREF</b>  |
| properties | isRef 0<br>minOcc 0<br>maxOcc 1<br>content simple  |
| annotation | documentation<br><b>Unique ID of the underlying derivative for FX risk hedging</b><br>documentation<br><b>Unique ID des zuordenbaren Derivates zur Währungsabsicherung</b> |



element **LoanType/CorrespondingRealEstate**

diagram

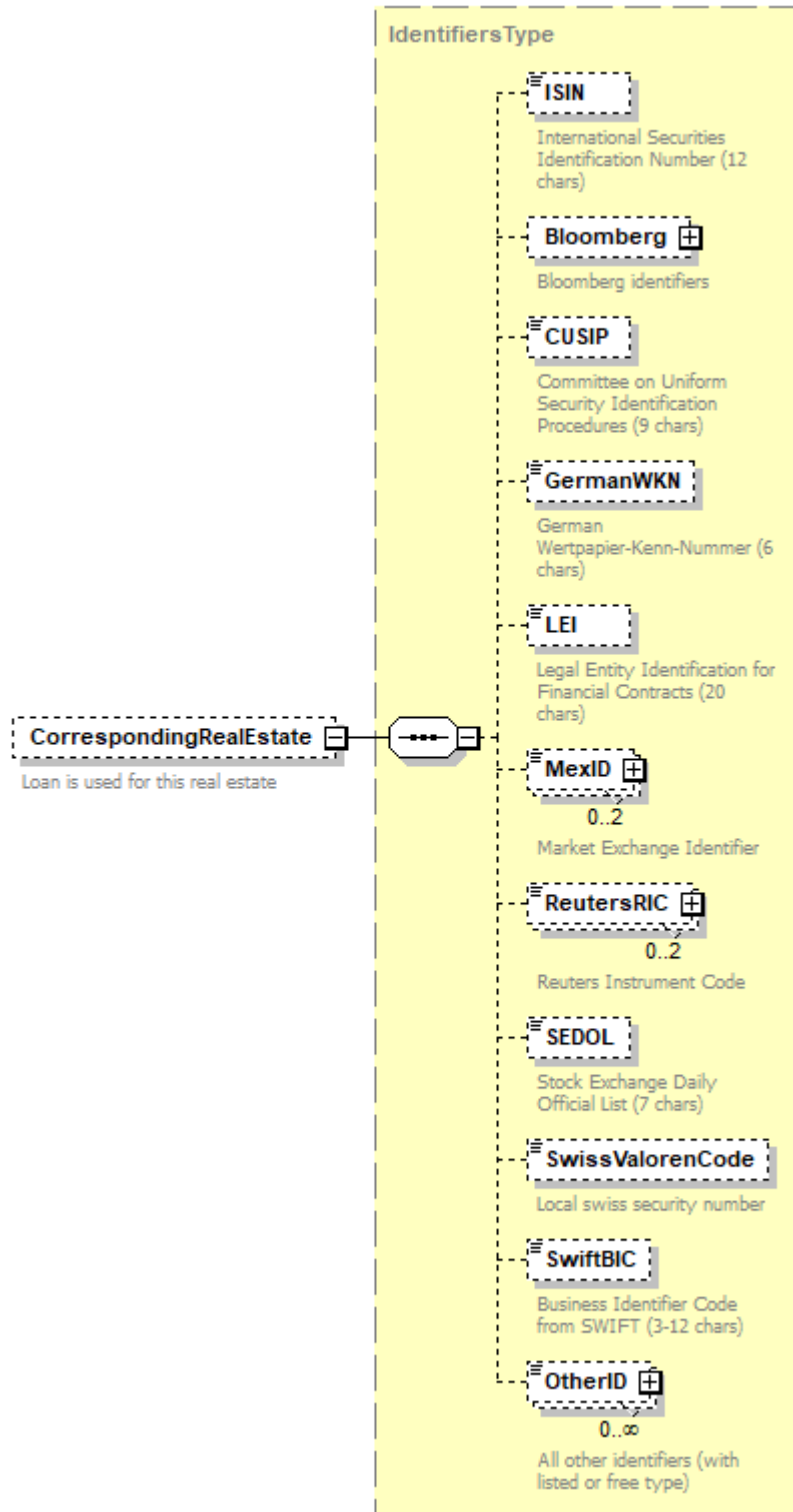

type [IdentifiersType](#)

properties  
 isRef 0  
 minOcc 0  
 maxOcc 1

|            |   |
|------------|---|
|            | content complex   |
| children   | <a href="#">ISIN</a> <a href="#">Bloomberg</a> <a href="#">CUSIP</a> <a href="#">GermanWKN</a> <a href="#">LEI</a> <a href="#">MexID</a> <a href="#">ReutersRIC</a> <a href="#">SEDOL</a> <a href="#">SwissValorenCode</a> <a href="#">SwiftBIC</a> <a href="#">OtherID</a> |
| annotation | documentation<br>Loan is used for this real estate  |

#### element **LoanType/PayableOnDemand**

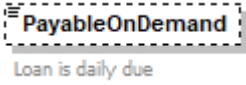
|            |   |
|------------|---|
| diagram    |  |
| type       | <b>xs:boolean</b>   |
| properties | isRef 0<br>minOcc 0<br>maxOcc 1<br>content simple                                 |
| annotation | documentation<br>Loan is daily due  |

#### element **LoanType/InterestRate**

|            |  |
|------------|--|
| diagram    |               |
| type       | <b>xs:decimal</b>  |
| properties | isRef 0<br>minOcc 0<br>maxOcc 1<br>content simple  |
| annotation | documentation<br>Interest rate of loan<br>documentation<br>Enthaelt einen Zinssatz des Kredits |

# complexType OptionType

diagram

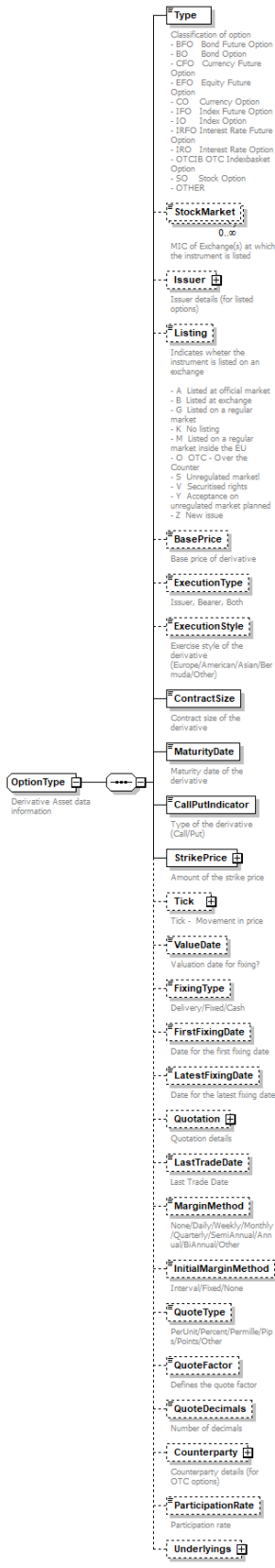

|            |  |
|------------|--|
| children   | <a href="#">Type</a> <a href="#">StockMarket</a> <a href="#">Issuer</a> <a href="#">Listing</a> <a href="#">BasePrice</a> <a href="#">ExecutionType</a> <a href="#">ExecutionStyle</a> <a href="#">ContractSize</a> <a href="#">MaturityDate</a> <a href="#">CallPutIndicator</a> <a href="#">StrikePrice</a> <a href="#">Tick</a> <a href="#">ValueDate</a> <a href="#">FixingType</a> <a href="#">FirstFixingDate</a> <a href="#">LatestFixingDate</a> <a href="#">Quotation</a> <a href="#">LastTradeDate</a> <a href="#">MarginMethod</a> <a href="#">InitialMarginMethod</a> <a href="#">QuoteType</a> <a href="#">QuoteFactor</a> <a href="#">QuoteDecimals</a> <a href="#">Counterparty</a> <a href="#">ParticipationRate</a> <a href="#">Underlyings</a> |
| used by    | element <a href="#">AssetDetailsType/Option</a>  |
| annotation | documentation<br>Derivative Asset data information   |

### element [OptionType/Type](#)

|            |  |
|------------|--|
| diagram    | <pre> Type Classification of option - BFO Bond Future Option - BO Bond Option - CFO Currency Future Option - EFO Equity Future Option - CO Currency Option - IFO Index Future Option - IO Index Option - IRFO Interest Rate Future Option - IRO Interest Rate Option - OTCIB OTC Indexbasket Option - SO Stock Option - OTHER </pre>   |
| type       | restriction of <b>xs:string</b>  |
| properties | isRef 0<br>content simple  |
| annotation | documentation<br>Classification of option<br>- BFO Bond Future Option<br>- BO Bond Option<br>- CFO Currency Future Option<br>- EFO Equity Future Option<br>- CO Currency Option<br>- IFO Index Future Option<br>- IO Index Option<br>- IRFO Interest Rate Future Option<br>- IRO Interest Rate Option<br>- OTCIB OTC Indexbasket Option<br>- SO Stock Option<br>- OTHER<br>documentation<br>Art der Option<br>- BFO Bond Future Option<br>- BO Bond Option<br>- CFO Currency Future Option<br>- EFO Equity Future Option<br>- CO Currency Option<br>- IFO Index Future Option<br>- IO Index Option<br>- IRFO Interest Rate Future Option<br>- IRO Interest Rate Option<br>- OTCIB OTC Indexbasket Option<br>- SO Stock Option<br>- OTHER |

element **OptionType/StockMarket**

|            |   |
|------------|---|
| diagram    |   |
| type       | <a href="#">MICCodeType</a>   |
| properties | isRef 0<br>minOcc 0<br>maxOcc unbounded<br>content simple   |
| facets     | Kind Value annotation<br>length 4   |
| annotation | documentation<br>MIC of Exchange(s) at which the instrument is listed<br>documentation<br>Gibt den MIC des Boerseplatz an an dem das Wertpapier notiert<br>appinfo<br><altova:exampleValues><br><altova:example value="WBAH"/><br></altova:exampleValues> |

element **OptionType/Issuer**

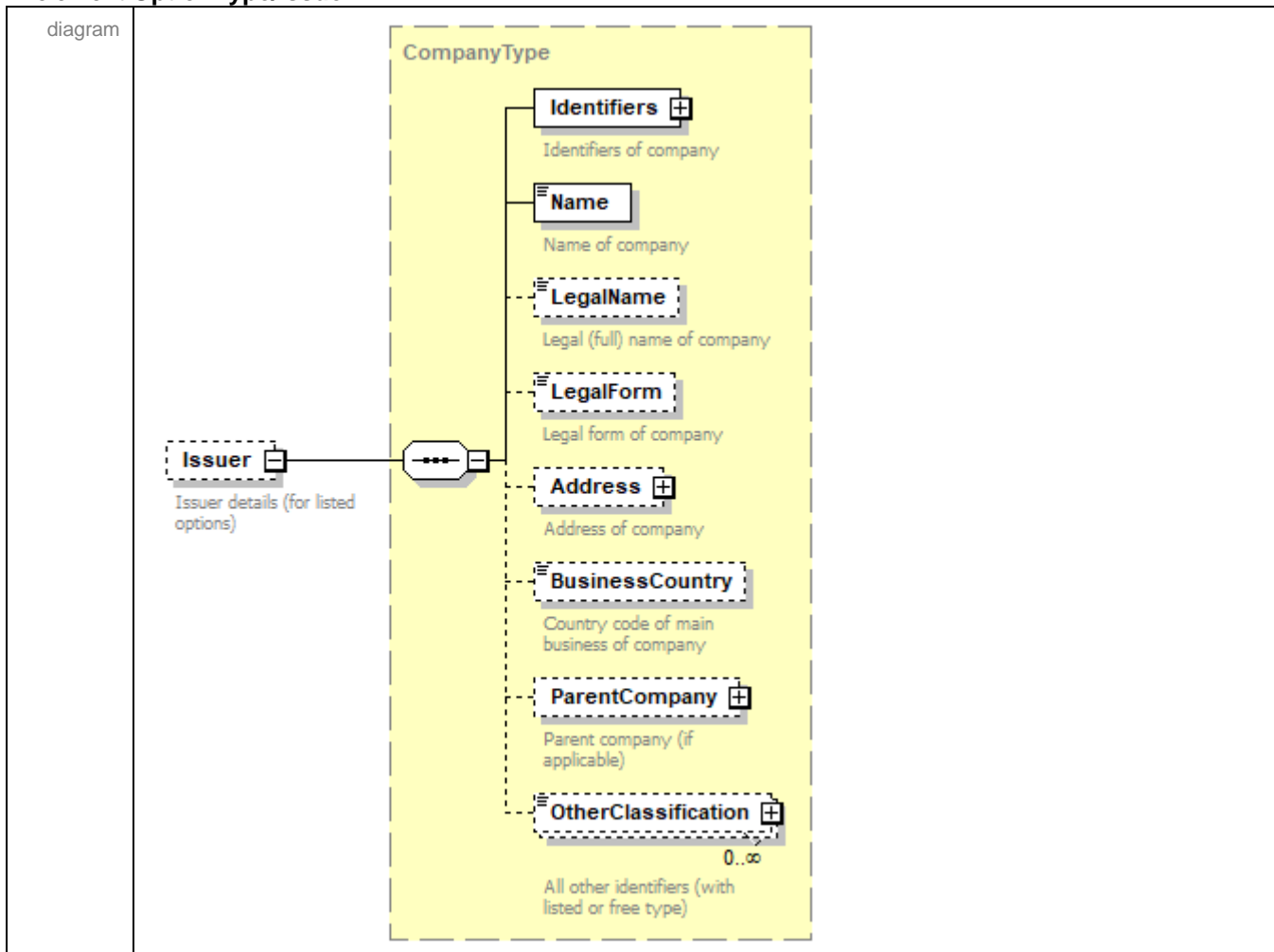

|            |  |
|------------|--|
| type       | <a href="#">CompanyType</a>  |
| properties | isRef 0<br>minOcc 0<br>maxOcc 1<br>content complex   |
| children   | <a href="#">Identifiers</a> <a href="#">Name</a> <a href="#">LegalName</a> <a href="#">LegalForm</a> <a href="#">Address</a> <a href="#">BusinessCountry</a> <a href="#">ParentCompany</a> <a href="#">OtherClassification</a> |
| annotation | documentation<br>Issuer details (for listed options)   |

### element **OptionType/Listing**

|            |  |
|------------|--|
| diagram    |  <p>Indicates wheter the instrument is listed on an exchange</p> <ul style="list-style-type: none"> <li>- A Listed at official market</li> <li>- B Listed at exchange</li> <li>- G Listed on a regular market</li> <li>- K No listing</li> <li>- M Listed on a regular market inside the EU</li> <li>- O OTC - Over the Counter</li> <li>- S Unregulated marketl</li> <li>- V Securitised rights</li> <li>- Y Acceptance on unregulated market planned</li> <li>- Z New issue</li> </ul>  |
| type       | restriction of <b>xs:string</b>  |
| properties | isRef 0<br>minOcc 0<br>maxOcc 1<br>content simple  |
| annotation | documentation<br>Indicates wheter the instrument is listed on an exchange <ul style="list-style-type: none"> <li>- A Listed at official market</li> <li>- B Listed at exchange</li> <li>- G Listed on a regular market</li> <li>- K No listing</li> <li>- M Listed on a regular market inside the EU</li> <li>- O OTC - Over the Counter</li> <li>- S Unregulated marketl</li> <li>- V Securitised rights</li> <li>- Y Acceptance on unregulated market planned</li> <li>- Z New issue</li> </ul> documentation<br>Gibt an ob das Wertpapier an einer Boerse notiert <ul style="list-style-type: none"> <li>- A Amtlicher Handel</li> <li>- B Boersennotierung Ausland</li> <li>- G Geregelter Freiverkehr</li> <li>- K Keine Boersenotierung</li> <li>- M Geregelter Markt id. EU</li> <li>- O OTC - Over the Counter</li> <li>- S Sonstiger Handel</li> <li>- V Verbriefte Rechte</li> <li>- Y Zulassung zum sonst. Handel vorges.</li> <li>- Z Neuemission</li> </ul> |

element **OptionType/BasePrice**

|            |   |
|------------|---|
| diagram    |  <p>Base price of derivative</p> |
| type       | <b>xs:decimal</b>   |
| properties | isRef 0<br>minOcc 0<br>maxOcc 1<br>content simple   |
| annotation | documentation<br>Base price of derivative<br>documentation<br>Gibt den Basispreis des Derivatenprodukts an        |

element **OptionType/ExecutionType**

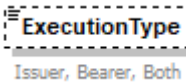
|            |   |
|------------|---|
| diagram    |  <p>Issuer, Bearer, Both</p> |
| type       | restriction of <b>xs:string</b>   |
| properties | isRef 0<br>minOcc 0<br>maxOcc 1<br>content simple   |
| annotation | documentation<br>Issuer, Bearer, Both   |

element **OptionType/ExecutionStyle**

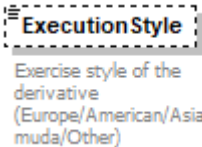
|            |  |
|------------|--|
| diagram    |  <p>Exercise style of the derivative<br/>(Europe/American/Asian/Bermuda/Other)</p>            |
| type       | restriction of <b>xs:string</b>  |
| properties | isRef 0<br>minOcc 0<br>maxOcc 1<br>content simple  |
| annotation | documentation<br>Exercise style of the derivative (Europe/American/Asian/Bermuda/Other)<br>documentation<br>Gibt an den Ausuebungsstyle an (Europe/American/Asian/Bermuda/Other) |

element **OptionType/ContractSize**

|            |  |
|------------|--|
| diagram    |  <p>Contract size of the derivative</p> |
| type       | <b>xs:decimal</b>  |
| properties | isRef 0<br>content simple  |

|            |   |
|------------|---|
| annotation | documentation<br>Contract size of the derivative<br>documentation<br>Gibt die Kontraktgroesze des Derivativprodukt an |
|------------|---|

### element **OptionType/MaturityDate**

|            |   |
|------------|---|
| diagram    |                                      |
| type       | <b>xs:date</b>  |
| properties | isRef 0<br>content simple   |
| annotation | documentation<br>Maturity date of the derivative<br>documentation<br>Bezeichnet das Ablaufdatum des Derivativprodukts |

### element **OptionType/CallPutIndicator**

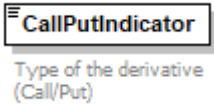
|            |   |
|------------|---|
| diagram    |                                    |
| type       | restriction of <b>xs:string</b>   |
| properties | isRef 0<br>content simple   |
| annotation | documentation<br>Type of the derivative (Call/Put)<br>documentation<br>Kennzeichnet die Art des Derivats (Call/Put) |

### element **OptionType/StrikePrice**

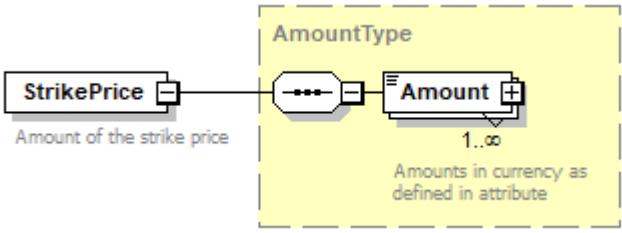
|            |   |
|------------|---|
| diagram    |  |
| type       | <a href="#">AmountType</a>  |
| properties | isRef 0<br>content complex  |
| children   | <a href="#">Amount</a>  |
| annotation | documentation<br>Amount of the strike price   |



element **OptionType/Tick**

|            |  |
|------------|--|
| diagram    |  |
| properties | isRef 0<br>minOcc 0<br>maxOcc 1<br>content complex |
| children   | <a href="#">TickSize</a> <a href="#">TickValue</a> |
| annotation | documentation<br>Tick - Movement in price          |

element **OptionType/Tick/TickSize**

|            |   |
|------------|---|
| diagram    |   |
| type       | <b>xs:decimal</b>   |
| properties | isRef 0<br>minOcc 0<br>maxOcc 1<br>content simple             |
| annotation | documentation<br>Minimum downward or upward movement in price |

element **OptionType/Tick/TickValue**

|            |  |
|------------|--|
| diagram    |  |
| type       | <a href="#">AmountType</a>                         |
| properties | isRef 0<br>minOcc 0<br>maxOcc 1<br>content complex |
| children   | <a href="#">Amount</a>                             |
| annotation | documentation<br>Value of the tick                 |

element **OptionType/ValueDate**

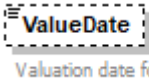
|            |   |
|------------|---|
| diagram    |  |
| type       | <b>xs:date</b>  |
| properties | isRef 0<br>minOcc 0<br>maxOcc 1<br>content simple                                 |
| annotation | documentation<br>Valuation date for fixing?                                       |

element **OptionType/FixingType**

|            |   |
|------------|---|
| diagram    |  |
| type       | restriction of <b>xs:string</b>   |
| properties | isRef 0<br>minOcc 0<br>maxOcc 1<br>content simple                                 |
| annotation | documentation<br>Delivery/Fixed/Cash  |

element **OptionType/FirstFixingDate**

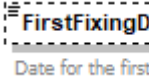
|            |   |
|------------|---|
| diagram    |  |
| type       | <b>xs:date</b>  |
| properties | isRef 0<br>minOcc 0<br>maxOcc 1<br>content simple                                   |
| annotation | documentation<br>Date for the first fixing date                                     |

element **OptionType/LatestFixingDate**

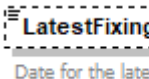
|            |   |
|------------|---|
| diagram    |  |
| type       | <b>xs:date</b>  |
| properties | isRef 0<br>minOcc 0<br>maxOcc 1<br>content simple                                   |
| annotation | documentation<br>Date for the latest fixing date                                    |

element **OptionType/Quotation**

|            |   |
|------------|---|
| diagram    | <p>The diagram illustrates the structure of the <b>Quotation</b> element. It is represented as a dashed box containing the text "Quotation details". To its right is a sequence container (a rounded rectangle with three dots) which contains three elements: <b>QuotationType</b> (Price/Yield/Other), <b>QuotationPercent</b> (Quotation in percent), and <b>QuotationAmount</b> (Amount of Quotation). Each of these three elements is also shown as a dashed box with its respective description below it.</p> |
| properties | isRef 0<br>minOcc 0<br>maxOcc 1<br>content complex  |
| children   | <a href="#">QuotationType</a> <a href="#">QuotationPercent</a> <a href="#">QuotationAmount</a>  |
| annotation | documentation<br>Quotation details  |

element **OptionType/Quotation/QuotationType**

|            |   |
|------------|---|
| diagram    | <p>The diagram shows the <b>QuotationType</b> element as a dashed box with the text "Price/Yield/Other" below it.</p> |
| type       | restriction of <b>xs:string</b>   |
| properties | isRef 0<br>minOcc 0<br>maxOcc 1<br>content simple   |
| annotation | documentation<br>Price/Yield/Other  |

element **OptionType/Quotation/QuotationPercent**

|            |   |
|------------|---|
| diagram    | <p>The diagram shows the <b>QuotationPercent</b> element as a dashed box with the text "Quotation in percent" below it.</p> |
| type       | <b>xs:float</b>   |
| properties | isRef 0<br>minOcc 0<br>maxOcc 1<br>content simple   |
| annotation | documentation<br>Quotation in percent   |

element **OptionType/Quotation/QuotationAmount**

|            |  |
|------------|--|
| diagram    | <p>The diagram illustrates the structure of the QuotationAmount element. It is represented as a dashed box containing a solid box labeled 'AmountType'. Inside the AmountType box, there is a solid box labeled 'Amount' with a multiplicity of '1..∞'. Below the Amount box, it says 'Amounts in currency as defined in attribute'. Below the QuotationAmount box, it says 'Amount of Quotation'.</p> |
| type       | <a href="#">AmountType</a>   |
| properties | isRef 0<br>minOcc 0<br>maxOcc 1<br>content complex   |
| children   | <a href="#">Amount</a>   |
| annotation | documentation<br>Amount of Quotation   |

element **OptionType/LastTradeDate**

|            |  |
|------------|--|
| diagram    | <p>The diagram shows the LastTradeDate element as a dashed box containing a solid box labeled 'LastTradeDate'. Below the box, it says 'Last Trade Date'.</p> |
| type       | <b>xs:date</b>   |
| properties | isRef 0<br>minOcc 0<br>maxOcc 1<br>content simple  |
| annotation | documentation<br>Last Trade Date   |

element **OptionType/MarginMethod**

|            |  |
|------------|--|
| diagram    | <p>The diagram shows the MarginMethod element as a dashed box containing a solid box labeled 'MarginMethod'. Below the box, it lists the allowed values: 'None/Daily/Weekly/Monthly/Quarterly/SemiAnnual/Annual/BiAnnual/Other'.</p> |
| type       | restriction of <b>xs:string</b>  |
| properties | isRef 0<br>minOcc 0<br>maxOcc 1<br>content simple  |
| annotation | documentation<br>None/Daily/Weekly/Monthly/Quarterly/SemiAnnual/Annual/BiAnnual/Other  |

element **OptionType/InitialMarginMethod**

|         |   |
|---------|---|
| diagram | <p>The diagram shows the InitialMarginMethod element as a dashed box containing a solid box labeled 'InitialMarginMethod'. Below the box, it lists the allowed values: 'Interval/Fixed/None'.</p> |
| type    | restriction of <b>xs:string</b>   |

|            |   |
|------------|---|
| properties | isRef 0<br>minOcc 0<br>maxOcc 1<br>content simple |
| annotation | documentation<br>Interval/Fixed/None              |

### element **OptionType/QuoteType**

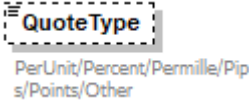
|            |   |
|------------|---|
| diagram    |  |
| type       | restriction of <b>xs:string</b>   |
| properties | isRef 0<br>minOcc 0<br>maxOcc 1<br>content simple                                 |
| annotation | documentation<br>PerUnit/Percent/Per mille/Pips/Points/Other                      |

### element **OptionType/QuoteFactor**

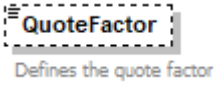
|            |   |
|------------|---|
| diagram    |  |
| type       | <b>xs:decimal</b>   |
| properties | isRef 0<br>minOcc 0<br>maxOcc 1<br>content simple                                 |
| annotation | documentation<br>Defines the quote factor   |

### element **OptionType/QuoteDecimals**

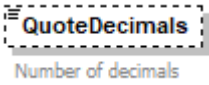
|            |   |
|------------|---|
| diagram    |  |
| type       | <b>xs:decimal</b>   |
| properties | isRef 0<br>minOcc 0<br>maxOcc 1<br>content simple                                   |
| annotation | documentation<br>Number of decimals   |

element **OptionType/Counterparty**

|                   |  |
|-------------------|--|
| <p>diagram</p>    | <p>The diagram shows the structure of the Counterparty element. It is represented by a dashed box containing a box with a dashed border and a plus sign. This box is connected to a larger dashed box labeled 'CompanyType'. Inside 'CompanyType', there are several elements: 'Identifiers' (with a plus sign), 'Name', 'LegalName', 'LegalForm', 'Address' (with a plus sign), 'BusinessCountry', 'ParentCompany' (with a plus sign), and 'OtherClassification' (with a plus sign and '0..∞' below it). Each element has a brief description below it.</p> |
| <p>type</p>       | <p><a href="#">CompanyType</a></p>   |
| <p>properties</p> | <p>isRef 0<br/>minOcc 0<br/>maxOcc 1<br/>content complex</p>   |
| <p>children</p>   | <p><a href="#">Identifiers</a> <a href="#">Name</a> <a href="#">LegalName</a> <a href="#">LegalForm</a> <a href="#">Address</a> <a href="#">BusinessCountry</a> <a href="#">ParentCompany</a> <a href="#">OtherClassification</a></p>  |
| <p>annotation</p> | <p>documentation<br/>Counterparty details (for OTC options)</p>  |

element **OptionType/ParticipationRate**

|                   |  |
|-------------------|--|
| <p>diagram</p>    | <p>The diagram shows the structure of the ParticipationRate element. It is represented by a dashed box containing the text 'Participation rate'.</p> |
| <p>type</p>       | <p><b>xs:decimal</b></p>   |
| <p>properties</p> | <p>isRef 0<br/>minOcc 0<br/>maxOcc 1<br/>content simple</p>  |
| <p>annotation</p> | <p>documentation<br/>Participation rate</p>  |

element **OptionType/Underlyings**

|            |   |
|------------|---|
| diagram    |   |
| properties | <p>isRef 0<br/> minOcc 0<br/> maxOcc 1<br/> content complex</p> |
| children   | <a href="#">Underlying</a>                                      |

element **OptionType/Underlyings/Underlying**

|            |   |
|------------|---|
| diagram    |   |
| type       | <a href="#">UnderlyingType</a>  |
| properties | <p>isRef 0<br/> minOcc 1<br/> maxOcc unbounded<br/> content complex</p>   |
| children   | <a href="#">Type</a> <a href="#">UniqueID</a> <a href="#">Name</a> <a href="#">Identifiers</a> <a href="#">Nominale</a> |
| annotation | <p>documentation<br/> Bezeichnet das dem Derivativprodukt unterlegte Wertpapier</p>                                     |

### complexType PrivateEquityType

|          |  |
|----------|--|
| diagram  | <p><b>Company</b> +<br/>Gesellschaftsform (GmbH, SICAV, ...)</p> <p><b>PrivateEquityID</b><br/>Link to new file for lookthrough (Assets owned by SPV). This ID has to be used in //FundsXML4/Funds/Fund/Identifiers/OtherID[@ListedType="PRIVATE EQUITY ID"]</p> |
| children | <a href="#">Company</a> <a href="#">PrivateEquityID</a>  |
| used by  | element <a href="#">AssetDetailsType/PrivateEquity</a>   |

### element PrivateEquityType/Company

|            |  |
|------------|--|
| diagram    | <p><b>CompanyType</b></p> <p><b>Identifiers</b> +<br/>Identifiers of company</p> <p><b>Name</b><br/>Name of company</p> <p><b>LegalName</b><br/>Legal (full) name of company</p> <p><b>LegalForm</b><br/>Legal form of company</p> <p><b>Address</b> +<br/>Address of company</p> <p><b>BusinessCountry</b><br/>Country code of main business of company</p> <p><b>ParentCompany</b> +<br/>Parent company (if applicable)</p> <p><b>OtherClassification</b> +<br/>0..∞<br/>All other identifiers (with listed or free type)</p> <p><b>Company</b><br/>Gesellschaftsform (GmbH, SICAV, ...)</p> |
| type       | <a href="#">CompanyType</a>  |
| properties | isRef 0<br>content complex   |



|            |  |
|------------|--|
| children   | <a href="#">Identifiers</a> <a href="#">Name</a> <a href="#">LegalName</a> <a href="#">LegalForm</a> <a href="#">Address</a> <a href="#">BusinessCountry</a> <a href="#">ParentCompany</a> <a href="#">OtherClassification</a> |
| annotation | documentation<br>Gesellschaftsform (GmbH, SICAV, ...)  |

element **PrivateEquityType/PrivateEquityID**

|            |  |
|------------|--|
| diagram    | <p>Link to new file for lookthrough (Assets owned by SPV). This ID has to be used in //FundsXML4/Funds/Fund/Identifiers/OtherID/[@ListedType="PRIVATE EQUITY ID"]</p>  |
| type       | restriction of <b>xs:string</b>  |
| properties | isRef 0<br>minOcc 0<br>maxOcc 1<br>content simple  |
| facets     | Kind Value annotation<br>maxLength 255   |
| annotation | documentation<br>Link to new file for lookthrough (Assets owned by SPV). This ID has to be used in //FundsXML4/Funds/Fund/Identifiers/OtherID/[@ListedType="PRIVATE EQUITY ID"]<br>documentation<br>Verlinkung mit neuem File für Durchrechnung (welche Assets gehören dieser Firma). Diese ID muss im neuen File unter //FundsXML4/Funds/Fund/Identifiers/OtherID/[@ListedType="PRIVATE EQUITY ID"] angegeben werden. |

complexType **RatingsType**

|            |   |
|------------|---|
| diagram    |   |
| children   | <a href="#">RatingCompany</a> <a href="#">Rating</a>              |
| used by    | element <a href="#">AssetType/Ratings/Rating</a>                  |
| annotation | documentation<br>Fund rating<br>documentation<br>Fondsbewertungen |

element **RatingsType/RatingCompany**

|         |   |
|---------|---|
| diagram | <p>Rating Company (e.g. FERI, SP, Moodys)</p> |
| type    | <b>xs:string</b>                              |

|            |   |
|------------|---|
| properties | isRef 0<br>content simple   |
| annotation | documentation<br>Rating Company (e.g. FERI, SP, Moodys)<br>documentation<br>Bewertungsgesellschaft (z.B. FERI, SP, Moody) |

### element RatingsType/Rating

|            |  |
|------------|--|
| diagram    |  |
| properties | isRef 0<br>minOcc 1<br>maxOcc unbounded<br>content complex             |
| children   | <a href="#">Date</a> <a href="#">Value</a> <a href="#">Description</a> |
| annotation | documentation<br>Investment rating<br>documentation<br>Fondsbewertung  |

### element RatingsType/Rating/Date

|            |   |
|------------|---|
| diagram    |   |
| type       | <b>xs:date</b>  |
| properties | isRef 0<br>content simple   |
| annotation | documentation<br>Date of the investment rating<br>documentation<br>Datum der Fondsbewertung |

### element RatingsType/Rating/Value

|            |   |
|------------|---|
| diagram    |   |
| type       | <b>xs:string</b>                                |
| properties | isRef 0<br>content simple                       |
| annotation | documentation<br>Value of the investment rating |

|  |  |
|--|--|
|  | documentation<br>Wert der Fondsbewertung |
|--|--|

element **RatingsType/Rating/Description**

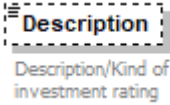
|            |  |
|------------|--|
| diagram    |                                   |
| type       | <b>xs:string</b>   |
| properties | isRef 0<br>minOcc 0<br>maxOcc 1<br>content simple  |
| annotation | documentation<br>Description/Kind of the investment rating<br>documentation<br>Beschreibung/Art der Fondsbewertung |

complexType **RealEstateType**

|                   |  |
|-------------------|--|
| <p>diagram</p>    | <p><b>RealEstateType</b><br/>Real Estate Asset data information</p> <ul style="list-style-type: none"> <li><b>InvestmentCosts</b><br/>Investment costs of the real estate asset</li> <li><b>FirstRateAccrual</b><br/>Date of the first rate accrual</li> <li><b>DateOfPropertyTransaction</b><br/>Date of the property transaction</li> <li><b>ConstructionYear</b><br/>Year of construction</li> <li><b>TotalRefurbishmentYear</b><br/>Year when the last total refurbishment was finished</li> <li><b>Zoning</b><br/>Devotement of the real estate asset</li> <li><b>TransactionType</b><br/>Transaction type of the investment deal:<br/>- direct investment<br/>- share deal corporate<br/>- share deal personnel<br/>- other transaction type</li> <li><b>TypeOfUse</b><br/>Type of use of the real estate asset</li> <li><b>LegalType</b><br/>Legal classification of the real estate asset</li> </ul> |
| <p>children</p>   | <p><a href="#">InvestmentCosts</a> <a href="#">FirstRateAccrual</a> <a href="#">DateOfPropertyTransaction</a> <a href="#">ConstructionYear</a> <a href="#">TotalRefurbishmentYear</a> <a href="#">Zoning</a> <a href="#">TransactionType</a> <a href="#">TypeOfUse</a> <a href="#">LegalType</a></p>   |
| <p>used by</p>    | <p>element <a href="#">AssetDetailsType/RealEstate</a></p>   |
| <p>annotation</p> | <p>documentation<br/>Real Estate Asset data information</p>  |

element **RealEstateType/InvestmentCosts**

|            |   |
|------------|---|
| diagram    |   |
| properties | isRef 0<br>minOcc 0<br>maxOcc 1<br>content complex  |
| children   | <a href="#">PurchasePrice</a> <a href="#">ConstructionCosts</a>                                   |
| annotation | documentation<br>Investment costs of the real estate asset<br>documentation<br>Investitionskosten |

element **RealEstateType/InvestmentCosts/PurchasePrice**

|            |   |
|------------|---|
| diagram    |   |
| properties | isRef 0<br>content complex  |
| children   | <a href="#">Value</a> <a href="#">Currency</a> <a href="#">FXRate</a>   |
| annotation | documentation<br>Purchase price of the real estate asset according to contract of purchase; including forward purchase contracts<br>documentation<br>Kaufpreis der Immobilie oder Grundstück laut Vertrag inkl. Forward purchase Vertragen |

element **RealEstateType/InvestmentCosts/PurchasePrice/Value**

|            |                           |
|------------|---------------------------|
| diagram    |                           |
| type       | <b>xs:decimal</b>         |
| properties | isRef 0<br>content simple |
| annotation | documentation<br>Wert     |

element **RealEstateType/InvestmentCosts/PurchasePrice/Currency**

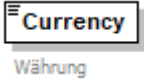
|            |   |
|------------|---|
| diagram    |  |
| type       | <a href="#">ISOCurrencyCodeType</a>   |
| properties | isRef 0<br>content simple   |
| facets     | Kind Value annotation<br>minLength 3<br>maxLength 3<br>pattern [A-Z]{3}           |
| annotation | documentation<br>Währung  |

element **RealEstateType/InvestmentCosts/PurchasePrice/FXRate**

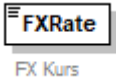
|            |   |
|------------|---|
| diagram    |  |
| type       | <b>xs:decimal</b>   |
| properties | isRef 0<br>content simple   |
| annotation | documentation<br>FX Kurs  |

element **RealEstateType/InvestmentCosts/ConstructionCosts**

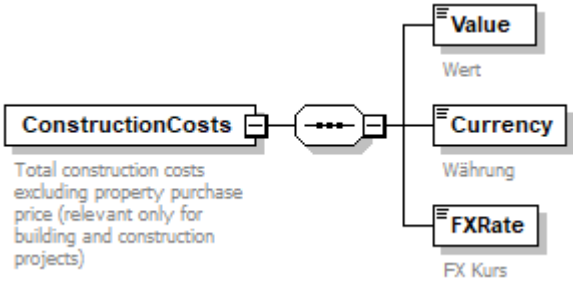
|            |  |
|------------|--|
| diagram    |   |
| properties | isRef 0<br>content complex   |
| children   | <a href="#">Value</a> <a href="#">Currency</a> <a href="#">FXRate</a>  |
| annotation | documentation<br>Total construction costs excluding property purchase price (relevant only for building and construction projects)<br>documentation<br>Gesamtinvestitionskosten exkl. Grundstückskaufpreis (nur relevant bei Bauprojekten mit laufender Zahlung) |

element **RealEstateType/InvestmentCosts/ConstructionCosts/Value**

|         |   |
|---------|---|
| diagram |  |
| type    | <b>xs:decimal</b>   |

|            |                           |
|------------|---------------------------|
| properties | isRef 0<br>content simple |
| annotation | documentation<br>Wert     |

element **RealEstateType/InvestmentCosts/ConstructionCosts/Currency**

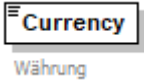
|            |   |
|------------|---|
| diagram    |  |
| type       | <a href="#">ISOCurrencyCodeType</a>   |
| properties | isRef 0<br>content simple   |
| facets     | Kind Value annotation<br>minLength 3<br>maxLength 3<br>pattern [A-Z]{3}           |
| annotation | documentation<br>Währung  |

element **RealEstateType/InvestmentCosts/ConstructionCosts/FXRate**

|            |   |
|------------|---|
| diagram    |  |
| type       | <b>xs:decimal</b>   |
| properties | isRef 0<br>content simple   |
| annotation | documentation<br>FX Kurs  |

element **RealEstateType/FirstRateAccrual**

|            |  |
|------------|--|
| diagram    |                               |
| type       | <b>xs:date</b>   |
| properties | isRef 0<br>minOcc 0<br>maxOcc 1<br>content simple  |
| annotation | documentation<br>Date of the first rate accrual<br>documentation<br>Enthaelt das Datum der ersten Mietabgrenzung |

element **RealEstateType/DateOfPropertyTransaction**

|         |   |
|---------|---|
| diagram |  |
| type    | <b>xs:date</b>  |

|            |   |
|------------|---|
| properties | isRef 0<br>minOcc 0<br>maxOcc 1<br>content simple   |
| annotation | documentation<br>Date of the property transaction<br>documentation<br>Enthaeft das Datum des Eigentumuebergangs |

element **RealEstateType/ConstructionYear**

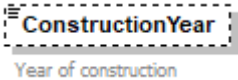
|            |   |
|------------|---|
| diagram    |                        |
| type       | <b>xs:positiveInteger</b>   |
| properties | isRef 0<br>minOcc 0<br>maxOcc 1<br>content simple   |
| annotation | documentation<br>Year of construction<br>documentation<br>Enthaeft das Errichtungsjahr (Fertigstellung) |

element **RealEstateType/TotalRefurbishmentYear**

|            |  |
|------------|--|
| diagram    |    |
| type       | <b>xs:positiveInteger</b>  |
| properties | isRef 0<br>minOcc 0<br>maxOcc 1<br>content simple  |
| annotation | documentation<br>Year when the last total refurbishment was finished<br>documentation<br>Enthaeft Jahr der letzten Generalsanierung (Fertigstellung) |

element **RealEstateType/Zoning**

|            |   |
|------------|---|
| diagram    |            |
| type       | <b>xs:string</b>  |
| properties | isRef 0<br>minOcc 0<br>maxOcc 1<br>content simple   |
| annotation | documentation<br>Devotement of the real estate asset<br>documentation<br>Enthaeft die Widmung |



element **RealEstateType/TransactionType**

|            |   |
|------------|---|
| diagram    | <p><b>TransactionType</b><br/>Transaction type of the investment deal:</p> <ul style="list-style-type: none"> <li>- direct investment</li> <li>- share deal corporate</li> <li>- share deal personnel</li> <li>- other transaction type</li> </ul>  |
| type       | restriction of <b>xs:string</b>   |
| properties | <p>isRef 0<br/>minOcc 0<br/>maxOcc 1<br/>content <b>simple</b></p>  |
| annotation | <p>documentation<br/>Transaction type of the investment deal:</p> <ul style="list-style-type: none"> <li>- direct investment</li> <li>- share deal corporate</li> <li>- share deal personnel</li> <li>- other transaction type</li> </ul> <p>documentation<br/>Art des Immobilienerwerbs:</p> <ul style="list-style-type: none"> <li>- direct investment</li> <li>- share deal corporate</li> <li>- share deal personnel</li> <li>- other transaction type</li> </ul> |

element **RealEstateType/TypeOfUse**

|            |  |
|------------|--|
| diagram    | <p><b>TypeOfUse</b><br/>Type of use of the real estate asset</p> <p><b>ECB</b><br/>Type of use according to ECB Investment Funds Statistics classifications</p> <p><b>AIFMD</b><br/>Type of use according to AIFMD Reporting classifications</p> <p><b>Internal</b><br/>Internal type of use</p> |
| properties | <p>isRef 0<br/>minOcc 0<br/>maxOcc 1<br/>content <b>complex</b></p>  |
| children   | <a href="#">ECB</a> <a href="#">AIFMD</a> <a href="#">Internal</a>   |
| annotation | <p>documentation<br/>Type of use of the real estate asset</p> <p>documentation<br/>Nutzungsart</p>   |

element **RealEstateType/TypeOfUse/ECB**

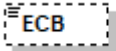
|            |   |
|------------|---|
| diagram    |  <p>Type of use according to<br/>ECB Investment Funds<br/>Statistics classifications</p> |
| type       | restriction of <b>xs:string</b>   |
| properties | <p>isRef 0<br/>minOcc 0<br/>maxOcc 1<br/>content simple</p>   |
| annotation | <p>documentation<br/>Type of use according to ECB Investment Funds Statistics classifications<br/>documentation<br/>Nutzungsart gem. EZB-IF Statistik</p>                 |

element **RealEstateType/TypeOfUse/AIFMD**

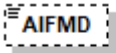
|            |   |
|------------|---|
| diagram    |  <p>Type of use according to<br/>AIFMD Reporting<br/>classifications</p> |
| type       | restriction of <b>xs:string</b>   |
| properties | <p>isRef 0<br/>minOcc 0<br/>maxOcc 1<br/>content simple</p>   |
| annotation | <p>documentation<br/>Type of use according to AIFMD Reporting classifications<br/>documentation<br/>Nutzungsart gem. AIFMD Reporting</p>                  |

element **RealEstateType/TypeOfUse/Internal**

|            |   |
|------------|---|
| diagram    |  <p>Internal type of use</p> |
| type       | <b>xs:string</b>  |
| properties | <p>isRef 0<br/>minOcc 0<br/>maxOcc 1<br/>content simple</p>   |
| annotation | <p>documentation<br/>Internal type of use<br/>documentation<br/>Nutzungsart intern</p>                          |

element **RealEstateType/LegalType**

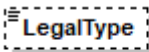
|         |  |
|---------|--|
| diagram |  <p>Legal classification of the real<br/>estate asset</p> |
| type    | <b>xs:string</b>   |

|            |   |
|------------|---|
| properties | isRef 0<br>minOcc 0<br>maxOcc 1<br>content simple   |
| annotation | documentation<br><b>Legal classification of the real estate asset</b><br>documentation<br>Juristische Klassifizierung des Assets gem. ImmoInvFG (AT):<br><br>- bebaute Grundstücke<br>- Grundstücke im Zustand der Bebauung<br>- unbebaute Grundstücke<br>- Baurechte, Superädifikate<br>- sonstige |

### complexType REITType

|          |   |
|----------|---|
| diagram  | <pre> graph LR     REITType[REITType] --- Choice[...]     Choice --- Issuer[Issuer]     Choice --- Listing[Listing]     Issuer --- IssuerDetails[Issuer details]     Listing --- ListingValues["A Listed at an official market<br/>B Listed at an exchange<br/>G Listed on a regular market<br/>K No listing<br/>M Listed on a regular market inside the EU<br/>S Unregulated market<br/>V Securitised rights<br/>Y Acceptance on unregulated market planned<br/>Z New issue"] </pre> |
| children | <a href="#">Issuer Listing</a>  |
| used by  | element <a href="#">AssetDetailsType/REIT</a>   |

element **REITType/Issuer**

|                   |   |
|-------------------|---|
| <p>diagram</p>    |   |
| <p>type</p>       | <p><a href="#">CompanyType</a></p>  |
| <p>properties</p> | <p>isRef 0<br/> minOcc 0<br/> maxOcc 1<br/> content complex</p>   |
| <p>children</p>   | <p><a href="#">Identifiers</a> <a href="#">Name</a> <a href="#">LegalName</a> <a href="#">LegalForm</a> <a href="#">Address</a> <a href="#">BusinessCountry</a> <a href="#">ParentCompany</a> <a href="#">OtherClassification</a></p> |
| <p>annotation</p> | <p>documentation<br/> <b>Issuer details</b><br/> documentation<br/> Enthält den Wertpapieremittenten</p>  |

element **REITType/Listing**

|                   |   |
|-------------------|---|
| <p>diagram</p>    |  <p>Indicator whether this equity is listed at an exchange</p> <ul style="list-style-type: none"> <li>A Listed at an official market</li> <li>B Listed at an exchange</li> <li>G Listed on a regular market</li> <li>K No listing</li> <li>M Listed on a regular market inside the EU</li> <li>S Unregulated market</li> <li>V Securitised rights</li> <li>Y Acceptance on unregulated market planned</li> <li>Z New issue</li> </ul>  |
| <p>type</p>       | <p>restriction of <b>xs:string</b></p>  |
| <p>properties</p> | <p>isRef 0<br/> minOcc 0<br/> maxOcc 1<br/> content simple</p>  |
| <p>annotation</p> | <p>documentation<br/> Indicator whether this equity is listed at an exchange</p> <ul style="list-style-type: none"> <li>A Listed at an official market</li> <li>B Listed at an exchange</li> <li>G Listed on a regular market</li> <li>K No listing</li> <li>M Listed on a regular market inside the EU</li> <li>S Unregulated market</li> <li>V Securitised rights</li> <li>Y Acceptance on unregulated market planned</li> <li>Z New issue</li> </ul> <p>documentation<br/> Gibt an ob das Wertpapier an einer Boerse notiert</p> <ul style="list-style-type: none"> <li>- A Amtlicher Handel</li> <li>- B Boersennotierung Ausland</li> <li>- G Geregelter Freiverkehr</li> <li>- K Keine Boersenotierung</li> <li>- M Geregelter Markt id. EU</li> <li>- S Sonstiger Handel</li> <li>- V Verbriefte Rechte</li> <li>- Y Zulassung zum sonst. Handel vorges.</li> <li>- Z Neuemission</li> </ul> |

# complexType RepoType

diagram

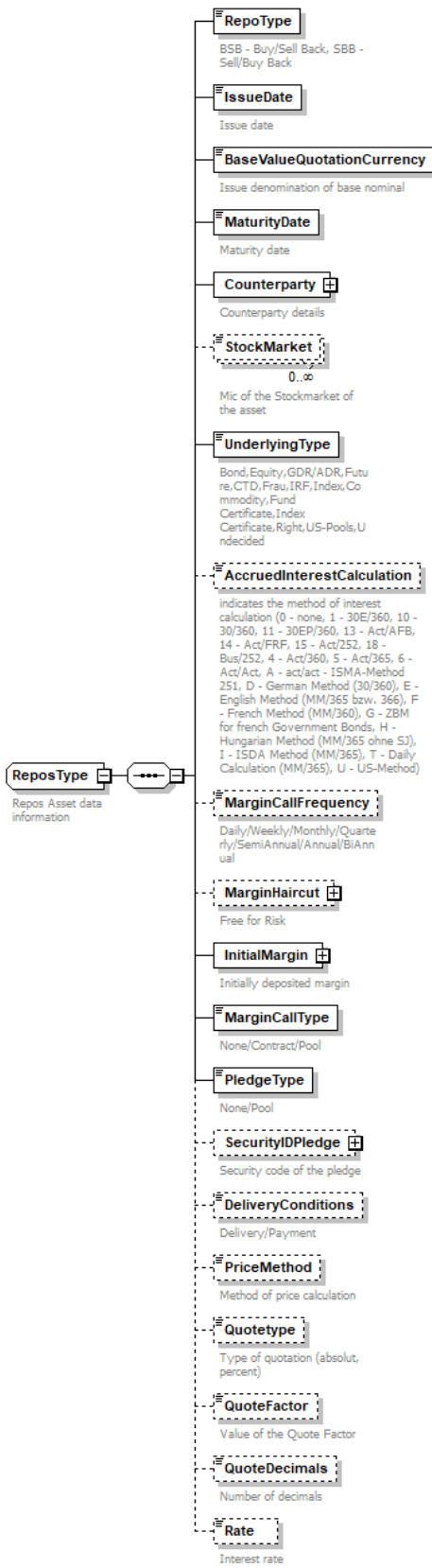

|            |  |
|------------|--|
| children   | <a href="#">RepoType</a> <a href="#">IssueDate</a> <a href="#">BaseValueQuotationCurrency</a> <a href="#">MaturityDate</a> <a href="#">Counterparty</a> <a href="#">StockMarket</a> <a href="#">UnderlyingType</a> <a href="#">AccruedInterestCalculation</a> <a href="#">MarginCallFrequency</a> <a href="#">MarginHaircut</a> <a href="#">InitialMargin</a> <a href="#">MarginCallType</a> <a href="#">PledgeType</a> <a href="#">SecurityIDPledge</a> <a href="#">DeliveryConditions</a> <a href="#">PriceMethod</a> <a href="#">Quotetype</a> <a href="#">QuoteFactor</a> <a href="#">QuoteDecimals</a> <a href="#">Rate</a> |
| used by    | element <a href="#">AssetDetailsType/Repo</a>  |
| annotation | documentation<br>Repos Asset data information  |

#### element **RepoType/RepoType**

|            |   |
|------------|---|
| diagram    |  |
| type       | restriction of <b>xs:string</b>   |
| properties | isRef 0<br>content simple   |
| annotation | documentation<br>BSB - Buy/Sell Back, SBB - Sell/Buy Back                         |

#### element **RepoType/IssueDate**

|            |   |
|------------|---|
| diagram    |  |
| type       | <b>xs:date</b>  |
| properties | isRef 0<br>content simple   |
| annotation | documentation<br>Issue date   |

#### element **RepoType/BaseValueQuotationCurrency**

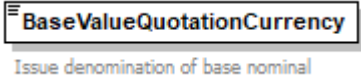
|            |   |
|------------|---|
| diagram    |  |
| type       | <b>xs:decimal</b>   |
| properties | isRef 0<br>content simple   |
| annotation | documentation<br>Issue denomination of base nominal                                 |

#### element **RepoType/MaturityDate**

|            |   |
|------------|---|
| diagram    |  |
| type       | <b>xs:date</b>  |
| properties | isRef 0<br>content simple   |
| annotation | documentation<br>Maturity date  |

element **RepoType/Counterparty**

|                   |  |
|-------------------|--|
| <p>diagram</p>    | <p>The diagram shows a 'Counterparty' element (represented by a box with a small square on the left) connected to a 'CompanyType' element (represented by a larger box with a dashed border and a small square on the left). The 'CompanyType' box contains several sub-elements, each with a description:</p> <ul style="list-style-type: none"> <li><b>Identifiers</b> (+): Identifiers of company</li> <li><b>Name</b> (=): Name of company</li> <li><b>LegalName</b> (=): Legal (full) name of company</li> <li><b>LegalForm</b> (=): Legal form of company</li> <li><b>Address</b> (+): Address of company</li> <li><b>BusinessCountry</b> (=): Country code of main business of company</li> <li><b>ParentCompany</b> (+): Parent company (if applicable)</li> <li><b>OtherClassification</b> (+): All other identifiers (with listed or free type)</li> </ul> <p>Each sub-element box has a small square on the left and a plus sign (+) or equals sign (=) on the right. The 'OtherClassification' box also has '0..∞' written below it.</p> |
| <p>type</p>       | <p><a href="#">CompanyType</a></p>   |
| <p>properties</p> | <p>isRef 0<br/>content complex</p>   |
| <p>children</p>   | <p><a href="#">Identifiers</a> <a href="#">Name</a> <a href="#">LegalName</a> <a href="#">LegalForm</a> <a href="#">Address</a> <a href="#">BusinessCountry</a> <a href="#">ParentCompany</a> <a href="#">OtherClassification</a></p>  |
| <p>annotation</p> | <p>documentation<br/>Counterparty details</p>  |

element **RepoType/StockMarket**

|                   |  |
|-------------------|--|
| <p>diagram</p>    | <p>The diagram shows a 'StockMarket' element (represented by a dashed box with a small square on the left) with '0..∞' written below it. Below the box is the text: 'Mic of the Stockmarket of the asset'.</p> |
| <p>type</p>       | <p><a href="#">MICCodeType</a></p>   |
| <p>properties</p> | <p>isRef 0<br/>minOcc 0<br/>maxOcc unbounded</p>   |



|            |  |
|------------|--|
|            | content simple   |
| facets     | Kind Value annotation<br>length 4  |
| annotation | documentation<br>Mic of the Stockmarket of the asset<br>appinfo<br><altova:exampleValues><br><altova:example value="WBAH"/><br></altova:exampleValues> |

#### element **RepoType/UnderlyingType**

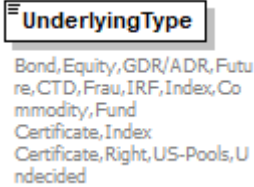
|            |  |
|------------|--|
| diagram    |   |
| type       | restriction of <b>xs:string</b>  |
| properties | isRef 0<br>content simple  |
| annotation | documentation<br>Bond,Equity,GDR/ADR,Future,CTD,Frau,IRF,Index,Commodity,Fund Certificate,Index Certificate,Right,US-Pools,Undecided |

#### element **RepoType/AccruedInterestCalculation**

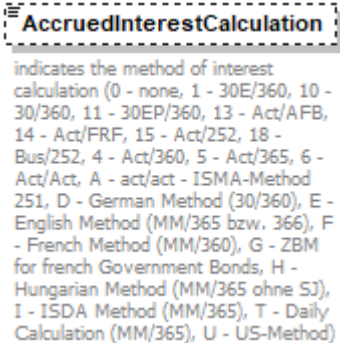
|            |  |
|------------|--|
| diagram    |   |
| type       | restriction of <b>xs:string</b>  |
| properties | isRef 0<br>minOcc 0<br>maxOcc 1<br>content simple  |
| annotation | documentation<br>indicates the method of interest calculation (0 - none, 1 - 30E/360, 10 - 30/360, 11 - 30EP/360, 13 - Act/AFB, 14 - Act/FRF, 15 - Act/252, 18 - Bus/252, 4 - Act/360, 5 - Act/365, 6 - Act/Act, A - act/act - ISMA-Method 251, D - German Method (30/360), E - English Method (MM/365 bzw. 366), F - French Method (MM/360), G - ZBM for french Government Bonds, H - Hungarian Method (MM/365 ohne SJ), I - ISDA Method (MM/365), T - Daily Calculation (MM/365), U - US-Method) |

element **RepoType/MarginCallFrequency**

|            |  |
|------------|--|
| diagram    |  |
| type       | restriction of <b>xs:string</b>  |
| properties | isRef 0<br>minOcc 0<br>maxOcc 1<br>content simple                          |
| annotation | documentation<br>Daily/Weekly/Monthly/Quarterly/SemiAnnual/Annual/BiAnnual |

element **RepoType/MarginHaircut**

|            |   |
|------------|---|
| diagram    |   |
| properties | isRef 0<br>minOcc 0<br>maxOcc 1<br>content complex  |
| children   | <a href="#">MinimumPercent</a> <a href="#">MinimumAbsolut</a> <a href="#">MaximumPercent</a> <a href="#">MaximumAbsolut</a> |
| annotation | documentation<br>Free for Risk  |

element **RepoType/MarginHaircut/MinimumPercent**

|            |   |
|------------|---|
| diagram    |   |
| type       | <b>xs:decimal</b>                                 |
| properties | isRef 0<br>minOcc 0<br>maxOcc 1<br>content simple |
| annotation | documentation<br>Percentage of the minimum risk   |

element **RepoType/MarginHaircut/MinimumAbsolut**

|            |   |
|------------|---|
| diagram    |  |
| type       | <b>xs:decimal</b>   |
| properties | isRef 0<br>minOcc 0<br>maxOcc 1<br>content simple                                 |
| annotation | documentation<br>Value of the minimum risk  |

element **RepoType/MarginHaircut/MaximumPercent**

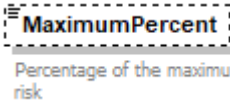
|            |   |
|------------|---|
| diagram    |  |
| type       | <b>xs:decimal</b>   |
| properties | isRef 0<br>minOcc 0<br>maxOcc 1<br>content simple                                 |
| annotation | documentation<br>Percentage of the maximum risk                                   |

element **RepoType/MarginHaircut/MaximumAbsolut**

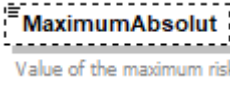
|            |   |
|------------|---|
| diagram    |  |
| type       | <b>xs:decimal</b>   |
| properties | isRef 0<br>minOcc 0<br>maxOcc 1<br>content simple                                   |
| annotation | documentation<br>Value of the maximum risk  |

element **RepoType/InitialMargin**

|            |   |
|------------|---|
| diagram    |   |
| properties | isRef 0<br>content complex  |
| children   | <a href="#">MinimumPercent</a> <a href="#">MinimumAbsolut</a> <a href="#">MaximumPercent</a> <a href="#">MaximumAbsolut</a> |
| annotation | documentation<br>Initially deposited margin   |

element **RepoType/InitialMargin/MinimumPercent**

|            |   |
|------------|---|
| diagram    |   |
| type       | <b>xs:decimal</b>   |
| properties | isRef 0<br>minOcc 0<br>maxOcc 1<br>content simple         |
| annotation | documentation<br>Percentage of the minimum initial margin |

element **RepoType/InitialMargin/MinimumAbsolut**

|            |  |
|------------|--|
| diagram    |  |
| type       | <b>xs:decimal</b>                                    |
| properties | isRef 0<br>minOcc 0<br>maxOcc 1<br>content simple    |
| annotation | documentation<br>Value of the minimum initial margin |

element **RepoType/InitialMargin/MaximumPercent**

|            |   |
|------------|---|
| diagram    |  |
| type       | <b>xs:decimal</b>   |
| properties | isRef 0<br>minOcc 0<br>maxOcc 1<br>content simple                                 |
| annotation | documentation<br>Percentage of the maximum initial margin                         |

element **RepoType/InitialMargin/MaximumAbsolut**

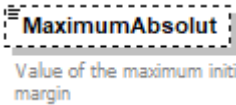
|            |   |
|------------|---|
| diagram    |  |
| type       | <b>xs:decimal</b>   |
| properties | isRef 0<br>minOcc 0<br>maxOcc 1<br>content simple                                 |
| annotation | documentation<br>Value of the maximum initial margin                              |

element **RepoType/MarginCallType**

|            |   |
|------------|---|
| diagram    |  |
| type       | restriction of <b>xs:string</b>   |
| properties | isRef 0<br>content simple   |
| annotation | documentation<br>None/Contract/Pool   |

element **RepoType/PledgeType**

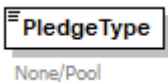
|            |   |
|------------|---|
| diagram    |  |
| type       | restriction of <b>xs:string</b>   |
| properties | isRef 0<br>content simple   |
| annotation | documentation<br>None/Pool  |

element **ReposType/SecurityIDPledge**

diagram

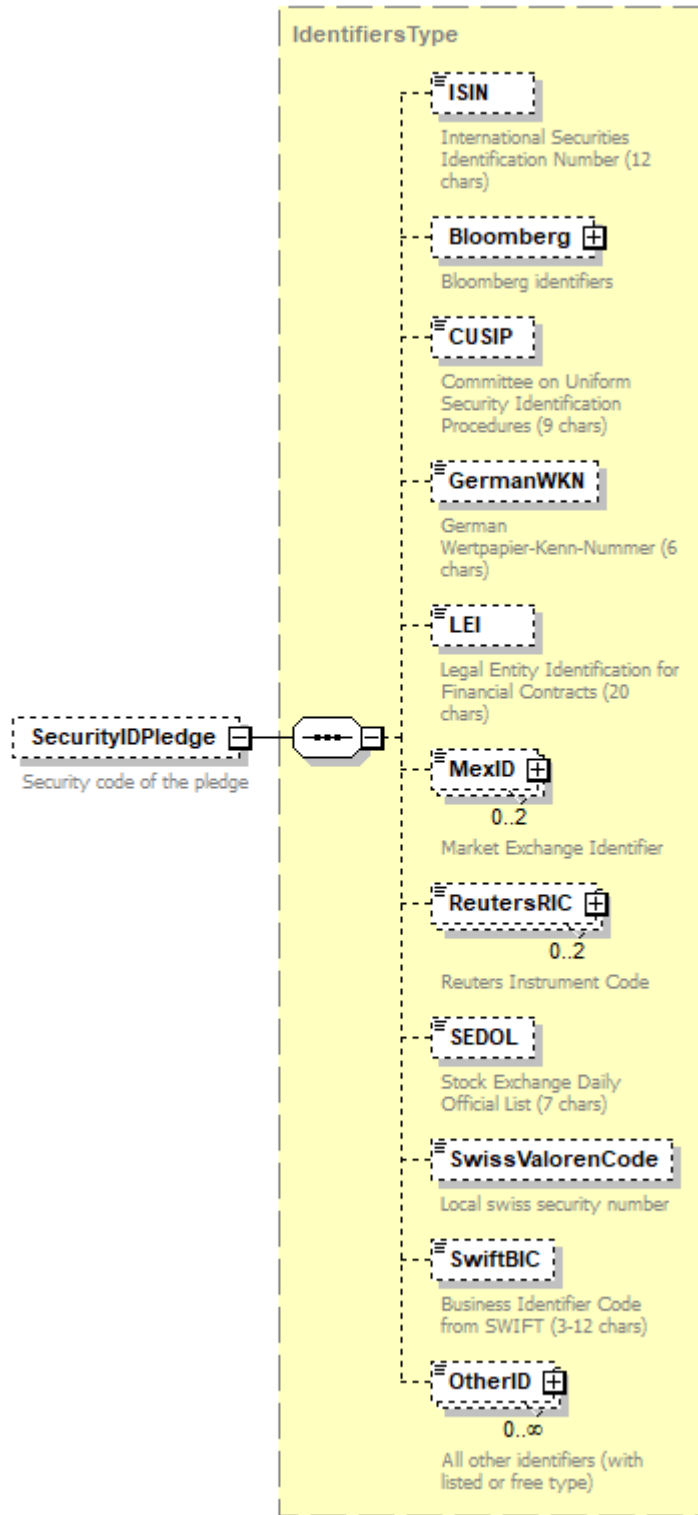

type [IdentifiersType](#)

properties  
 isRef 0  
 minOcc 0  
 maxOcc 1

|            |   |
|------------|---|
|            | content complex   |
| children   | <a href="#">ISIN</a> <a href="#">Bloomberg</a> <a href="#">CUSIP</a> <a href="#">GermanWKN</a> <a href="#">LEI</a> <a href="#">MexID</a> <a href="#">ReutersRIC</a> <a href="#">SEDOL</a> <a href="#">SwissValorenCode</a> <a href="#">SwiftBIC</a> <a href="#">OtherID</a> |
| annotation | documentation<br>Security code of the pledge  |

#### element **RepoType/DeliveryConditions**

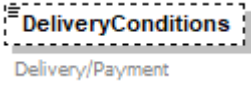
|            |   |
|------------|---|
| diagram    |  |
| type       | restriction of <b>xs:string</b>   |
| properties | isRef 0<br>minOcc 0<br>maxOcc 1<br>content simple                                 |
| annotation | documentation<br>Delivery/Payment   |

#### element **RepoType/PriceMethod**

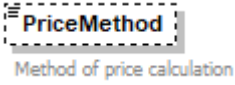
|            |   |
|------------|---|
| diagram    |  |
| type       | <b>xs:string</b>  |
| properties | isRef 0<br>minOcc 0<br>maxOcc 1<br>content simple                                 |
| annotation | documentation<br>Method of price calculation                                      |

#### element **RepoType/Quotetype**

|            |   |
|------------|---|
| diagram    |  |
| type       | restriction of <b>xs:string</b>   |
| properties | isRef 0<br>minOcc 0<br>maxOcc 1<br>content simple                                   |
| annotation | documentation<br>Type of quotation (absolut, percent)                               |

#### element **RepoType/QuoteFactor**

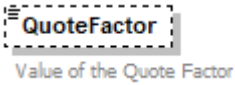
|            |   |
|------------|---|
| diagram    |  |
| type       | <b>xs:decimal</b>   |
| properties | isRef 0<br>minOcc 0   |

|            |  |
|------------|--|
|            | maxOcc 1<br>content simple                 |
| annotation | documentation<br>Value of the Quote Factor |

element **RepoType/QuoteDecimals**

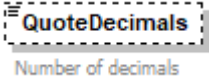
|            |   |
|------------|---|
| diagram    |  |
| type       | <b>xs:decimal</b>   |
| properties | isRef 0<br>minOcc 0<br>maxOcc 1<br>content simple                                 |
| annotation | documentation<br>Number of decimals   |

element **RepoType/Rate**

|            |   |
|------------|---|
| diagram    |  |
| type       | <b>xs:decimal</b>   |
| properties | isRef 0<br>minOcc 0<br>maxOcc 1<br>content simple                                 |
| annotation | documentation<br>Interest rate  |



complexType **ShareClassDetailsType**

diagram

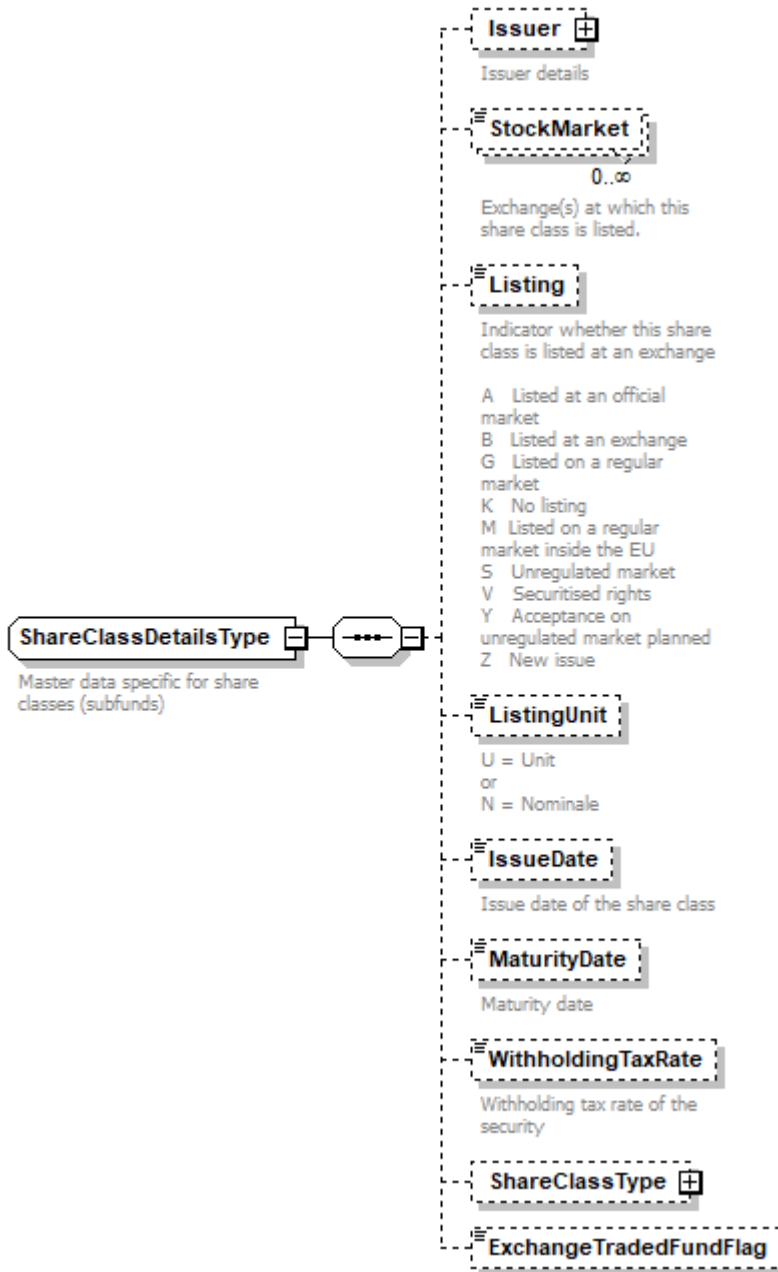

children

[Issuer](#) [StockMarket](#) [Listing](#) [ListingUnit](#) [IssueDate](#) [MaturityDate](#) [WithholdingTaxRate](#) [ShareClassType](#) [ExchangeTradedFundFlag](#)

used by

element [AssetDetailsType/ShareClass](#)

annotation

documentation  
Master data specific for share classes (subfunds)

element **ShareClassDetailsType/Issuer**

|                   |   |
|-------------------|---|
| <p>diagram</p>    |   |
| <p>type</p>       | <p><a href="#">CompanyType</a></p>  |
| <p>properties</p> | <p>isRef 0<br/>minOcc 0<br/>maxOcc 1<br/>content complex</p>  |
| <p>children</p>   | <p><a href="#">Identifiers</a> <a href="#">Name</a> <a href="#">LegalName</a> <a href="#">LegalForm</a> <a href="#">Address</a> <a href="#">BusinessCountry</a> <a href="#">ParentCompany</a> <a href="#">OtherClassification</a></p> |
| <p>annotation</p> | <p>documentation<br/>Issuer details</p>   |

element **ShareClassDetailsType/StockMarket**

|                   |   |
|-------------------|---|
| <p>diagram</p>    |   |
| <p>type</p>       | <p><a href="#">MICCodeType</a></p>                                  |
| <p>properties</p> | <p>isRef 0<br/>minOcc 0<br/>maxOcc unbounded<br/>content simple</p> |

|            |   |
|------------|---|
| facets     | Kind Value annotation<br>length 4   |
| annotation | documentation<br>Exchange(s) at which this share class is listed.<br>documentation<br>Gibt den Boerseplatz an an dem das Wertpapier notiert |

element **ShareClassDetailsType/Listing**

|            |   |
|------------|---|
| diagram    |  <p>Indicator whether this share class is listed at an exchange</p> <p>A Listed at an official market<br/>B Listed at an exchange<br/>G Listed on a regular market<br/>K No listing<br/>M Listed on a regular market inside the EU<br/>S Unregulated market<br/>V Securitised rights<br/>Y Acceptance on unregulated market planned<br/>Z New issue</p>  |
| type       | restriction of <b>xs:string</b>   |
| properties | isRef 0<br>minOcc 0<br>maxOcc 1<br>content simple   |
| annotation | <p>documentation<br/>Indicator whether this share class is listed at an exchange</p> <p>A Listed at an official market<br/>B Listed at an exchange<br/>G Listed on a regular market<br/>K No listing<br/>M Listed on a regular market inside the EU<br/>S Unregulated market<br/>V Securitised rights<br/>Y Acceptance on unregulated market planned<br/>Z New issue</p> <p>documentation<br/>Gibt an ob das Wertpapier an einer Boerse notiert</p> <ul style="list-style-type: none"> <li>- A Amtlicher Handel</li> <li>- B Boersennotierung Ausland</li> <li>- G Geregelter Freiverkehr</li> <li>- K Keine Boersenotierung</li> <li>- M Geregelter Markt id. EU</li> <li>- S Sonstiger Handel</li> <li>- V Verbriefte Rechte</li> <li>- Y Zulassung zum sonst. Handel vorges.</li> <li>- Z Neuemission</li> </ul> |

element **ShareClassDetailsType/ListingUnit**

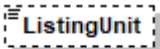
|         |   |
|---------|---|
| diagram |  <p>U = Unit<br/>or<br/>N = Nominale</p> |
|---------|---|

|            |   |
|------------|---|
| type       | restriction of <b>xs:string</b>                               |
| properties | isRef 0<br>minOcc 0<br>maxOcc 1<br>content simple             |
| annotation | documentation<br><b>U = Unit</b><br>or<br><b>N = Nominale</b> |

element **ShareClassDetailsType/IssueDate**

|            |  |
|------------|--|
| diagram    |   |
| type       | <b>xs:date</b>   |
| properties | isRef 0<br>minOcc 0<br>maxOcc 1<br>content simple  |
| annotation | documentation<br><b>Issue date of the share class</b><br>documentation<br>Emissionsdatum bezeichnet jenes Datum, zu dem das Wertpapier aufgelegt wurde |

element **ShareClassDetailsType/MaturityDate**

|            |   |
|------------|---|
| diagram    |  |
| type       | <b>xs:date</b>  |
| properties | isRef 0<br>minOcc 0<br>maxOcc 1<br>content simple                                   |
| annotation | documentation<br><b>Maturity date</b><br>documentation<br>Gibt das Tilgungsdatum an |

element **ShareClassDetailsType/WithholdingTaxRate**

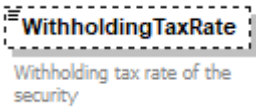
|            |   |
|------------|---|
| diagram    |    |
| type       | <b>xs:decimal</b>   |
| properties | isRef 0<br>minOcc 0<br>maxOcc 1<br>content simple   |
| annotation | documentation<br><b>Withholding tax rate of the security</b><br>documentation<br>Enthaelt den Quellensteuersatz dem das Wertpapier unterliegt |

element **ShareClassDetailsType/ShareClassType**

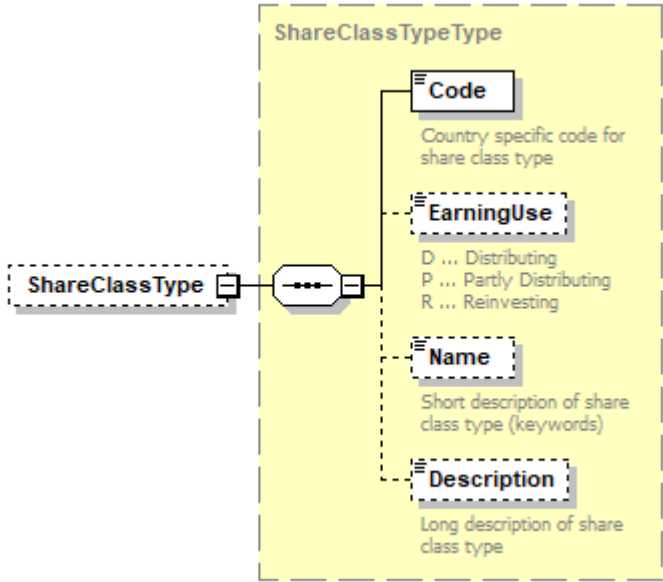
|            |  |
|------------|--|
| diagram    |                 |
| type       | <a href="#">ShareClassTypeType</a>   |
| properties | isRef 0<br>minOcc 0<br>maxOcc 1<br>content complex   |
| children   | <a href="#">Code</a> <a href="#">EarningUse</a> <a href="#">Name</a> <a href="#">Description</a> |

element **ShareClassDetailsType/ExchangeTradedFundFlag**

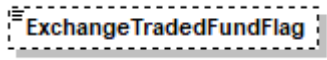
|            |   |
|------------|---|
| diagram    |  |
| type       | <b>xs:boolean</b>   |
| properties | isRef 0<br>minOcc 0<br>maxOcc 1<br>content simple                                   |

## complexType SwapType

|            |  |
|------------|--|
| diagram    | <p>The diagram shows the structure of the <b>SwapType</b> complex type. It is represented as a container labeled "SwapType" with the description "SWAP Asset data information". This container holds several child elements:</p> <ul style="list-style-type: none"> <li><b>Type</b>: Swap type (Currency-, Crosscurrency-, Index-, Totalreturn-, Asset-, Commodity-, Interest Rate-, Inflation-, Other)</li> <li><b>StartDate</b>: Start date</li> <li><b>MaturityDate</b>: Maturity date (Ablaufdatum)</li> <li><b>SettlementDate</b>: Settlement date</li> <li><b>Counterparty</b>: Counterparty details</li> <li><b>Legs</b>: Swap leg details</li> </ul> |
| children   | <a href="#">Type</a> <a href="#">StartDate</a> <a href="#">MaturityDate</a> <a href="#">SettlementDate</a> <a href="#">Counterparty</a> <a href="#">Legs</a>   |
| used by    | element <a href="#">AssetDetailsType/Swap</a>  |
| annotation | documentation<br>SWAP Asset data information   |

## element SwapType/Type

|            |   |
|------------|---|
| diagram    | <p>The diagram shows the <b>Type</b> element, which is a restriction of <b>xs:string</b>. Its description is: Swap type (Currency-, Crosscurrency-, Index-, Totalreturn-, Asset-, Commodity-, Interest Rate-, Inflation-, Other).</p> |
| type       | restriction of <b>xs:string</b>   |
| properties | isRef 0<br>content simple   |
| annotation | documentation<br>Swap type (Currency-, Crosscurrency-, Index-, Totalreturn-, Asset-, Commodity-, Interest Rate-, Inflation-, Other)   |

## element SwapType/StartDate

|            |   |
|------------|---|
| diagram    | <p>The diagram shows the <b>StartDate</b> element, which is of type <b>xs:date</b>. Its description is: Start date.</p> |
| type       | <b>xs:date</b>  |
| properties | isRef 0<br>minOcc 0<br>maxOcc 1<br>content simple   |
| annotation | documentation<br>Start date   |

element **SwapType/MaturityDate**

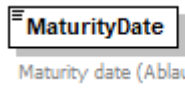
|            |   |
|------------|---|
| diagram    |  |
| type       | <b>xs:date</b>  |
| properties | isRef 0<br>content simple   |
| annotation | documentation<br>Maturity date (Ablaufdatum)                                      |

element **SwapType/SettlementDate**

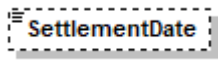
|            |   |
|------------|---|
| diagram    |  |
| type       | <b>xs:date</b>  |
| properties | isRef 0<br>minOcc 0<br>maxOcc 1<br>content simple                                 |

element **SwapType/Counterparty**

|                   |   |
|-------------------|---|
| <p>diagram</p>    |   |
| <p>type</p>       | <p><a href="#">CompanyType</a></p>  |
| <p>properties</p> | <p>isRef 0<br/>content complex</p>  |
| <p>children</p>   | <p><a href="#">Identifiers</a> <a href="#">Name</a> <a href="#">LegalName</a> <a href="#">LegalForm</a> <a href="#">Address</a> <a href="#">BusinessCountry</a> <a href="#">ParentCompany</a> <a href="#">OtherClassification</a></p> |
| <p>annotation</p> | <p>documentation<br/>Counterparty details</p>   |

element **SwapType/Legs**

|                   |  |
|-------------------|--|
| <p>diagram</p>    |  |
| <p>properties</p> | <p>isRef 0<br/>minOcc 0<br/>maxOcc 1<br/>content complex</p> |
| <p>children</p>   | <p><a href="#">Leg</a></p>                                   |
| <p>annotation</p> | <p>documentation<br/>Swap leg details</p>                    |





# element SwapType/Legs/Leg

diagram

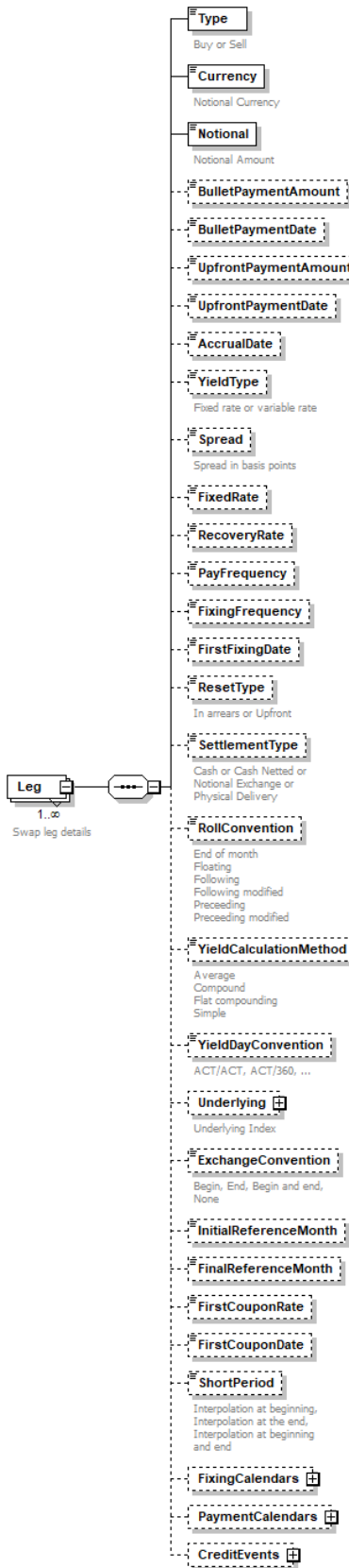

|            |   |
|------------|---|
| type       | extension of <a href="#">LegType</a>  |
| properties | isRef 0<br>minOcc 1<br>maxOcc unbounded<br>content complex  |
| children   | <a href="#">Type</a> <a href="#">Currency</a> <a href="#">Notional</a> <a href="#">BulletPaymentAmount</a> <a href="#">BulletPaymentDate</a> <a href="#">UpfrontPaymentAmount</a> <a href="#">UpfrontPaymentDate</a> <a href="#">AccrualDate</a> <a href="#">YieldType</a> <a href="#">Spread</a> <a href="#">FixedRate</a> <a href="#">RecoveryRate</a> <a href="#">PayFrequency</a> <a href="#">FixingFrequency</a> <a href="#">FirstFixingDate</a> <a href="#">ResetType</a> <a href="#">SettlementType</a> <a href="#">RollConvention</a> <a href="#">YieldCalculationMethod</a> <a href="#">YieldDayConvention</a> <a href="#">Underlying</a> <a href="#">ExchangeConvention</a> <a href="#">InitialReferenceMonth</a> <a href="#">FinalReferenceMonth</a> <a href="#">FirstCouponRate</a> <a href="#">FirstCouponDate</a> <a href="#">ShortPeriod</a> <a href="#">FixingCalendars</a> <a href="#">PaymentCalendars</a> <a href="#">CreditEvents</a> |
| annotation | documentation<br>Swap leg details   |

#### element **SwapType/Legs/Leg/Type**

|            |   |
|------------|---|
| diagram    |  |
| type       | restriction of <b>xs:string</b>   |
| properties | isRef 0<br>content simple   |
| annotation | documentation<br>Buy or Sell  |

#### element **SwapType/Legs/Leg/Currency**

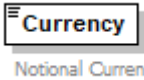
|            |   |
|------------|---|
| diagram    |  |
| type       | <a href="#">ISOCurrencyCodeType</a>   |
| properties | isRef 0<br>content simple   |
| facets     | Kind Value annotation<br>minLength 3<br>maxLength 3<br>pattern [A-Z]{3}             |
| annotation | documentation<br>Notional Currency  |

#### element **SwapType/Legs/Leg/Notional**

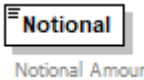
|            |   |
|------------|---|
| diagram    |  |
| type       | <b>xs:decimal</b>   |
| properties | isRef 0<br>content simple   |
| annotation | documentation<br>Notional Amount  |

element **SwapType/Legs/Leg/BulletPaymentAmount**

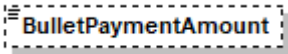
|            |   |
|------------|---|
| diagram    |  |
| type       | <b>xs:decimal</b>   |
| properties | isRef 0<br>minOcc 0<br>maxOcc 1<br>content simple                                 |

element **SwapType/Legs/Leg/BulletPaymentDate**

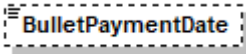
|            |   |
|------------|---|
| diagram    |  |
| type       | <b>xs:date</b>  |
| properties | isRef 0<br>minOcc 0<br>maxOcc 1<br>content simple                                 |

element **SwapType/Legs/Leg/UpfrontPaymentAmount**

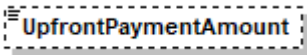
|            |   |
|------------|---|
| diagram    |  |
| type       | <b>xs:decimal</b>   |
| properties | isRef 0<br>minOcc 0<br>maxOcc 1<br>content simple                                 |

element **SwapType/Legs/Leg/UpfrontPaymentDate**

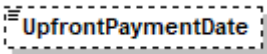
|            |   |
|------------|---|
| diagram    |  |
| type       | <b>xs:date</b>  |
| properties | isRef 0<br>minOcc 0<br>maxOcc 1<br>content simple                                   |

element **SwapType/Legs/Leg/AccrualDate**

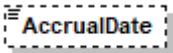
|            |   |
|------------|---|
| diagram    |  |
| type       | <b>xs:date</b>  |
| properties | isRef 0<br>minOcc 0<br>maxOcc 1<br>content simple                                   |

element **SwapType/Legs/Leg/YieldType**

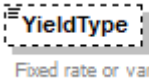
|            |   |
|------------|---|
| diagram    |  |
| type       | restriction of <b>xs:string</b>   |
| properties | isRef 0<br>minOcc 0<br>maxOcc 1<br>content simple                                 |
| annotation | documentation<br>Fixed rate or variable rate                                      |

element **SwapType/Legs/Leg/Spread**

|            |   |
|------------|---|
| diagram    |  |
| type       | <b>xs:decimal</b>   |
| properties | isRef 0<br>minOcc 0<br>maxOcc 1<br>content simple                                 |
| annotation | documentation<br>Spread in basis points   |

element **SwapType/Legs/Leg/FixedRate**

|            |   |
|------------|---|
| diagram    |  |
| type       | <b>xs:decimal</b>   |
| properties | isRef 0<br>minOcc 0<br>maxOcc 1<br>content simple                                   |

element **SwapType/Legs/Leg/RecoveryRate**

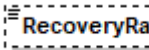
|            |   |
|------------|---|
| diagram    |  |
| type       | <b>xs:decimal</b>   |
| properties | isRef 0<br>minOcc 0<br>maxOcc 1<br>content simple                                   |

element **SwapType/Legs/Leg/PayFrequency**

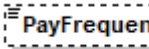
|         |   |
|---------|---|
| diagram |  |
| type    | <a href="#">FrequencyType</a>   |

|            |   |
|------------|---|
| properties | isRef 0<br>minOcc 0<br>maxOcc 1<br>content simple |
|------------|---|

element **SwapType/Legs/Leg/FixingFrequency**

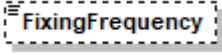
|            |   |
|------------|---|
| diagram    |  |
| type       | <a href="#">FrequencyType</a>   |
| properties | isRef 0<br>minOcc 0<br>maxOcc 1<br>content simple                                 |

element **SwapType/Legs/Leg/FirstFixingDate**

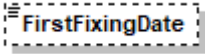
|            |   |
|------------|---|
| diagram    |  |
| type       | <b>xs:date</b>  |
| properties | isRef 0<br>minOcc 0<br>maxOcc 1<br>content simple                                 |

element **SwapType/Legs/Leg/ResetType**

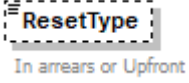
|            |   |
|------------|---|
| diagram    |  |
| type       | restriction of <b>xs:string</b>   |
| properties | isRef 0<br>minOcc 0<br>maxOcc 1<br>content simple                                   |
| annotation | documentation<br>In arrears or Upfront  |

element **SwapType/Legs/Leg/SettlementType**

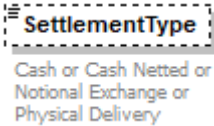
|            |   |
|------------|---|
| diagram    |  |
| type       | restriction of <b>xs:string</b>   |
| properties | isRef 0<br>minOcc 0<br>maxOcc 1<br>content simple                                   |
| annotation | documentation<br>Cash or Cash Netted or Notional Exchange or Physical Delivery      |

element **SwapType/Legs/Leg/RollConvention**

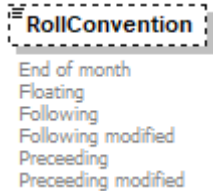
|            |   |
|------------|---|
| diagram    |  <p><b>RollConvention</b></p> <ul style="list-style-type: none"> <li>End of month</li> <li>Floating</li> <li>Following</li> <li>Following modified</li> <li>Preceding</li> <li>Preceding modified</li> </ul> |
| type       | restriction of <b>xs:string</b>   |
| properties | <ul style="list-style-type: none"> <li>isRef 0</li> <li>minOcc 0</li> <li>maxOcc 1</li> <li>content simple</li> </ul>   |
| annotation | <ul style="list-style-type: none"> <li>documentation</li> <li>End of month</li> <li>Floating</li> <li>Following</li> <li>Following modified</li> <li>Preceding</li> <li>Preceding modified</li> </ul>   |

element **SwapType/Legs/Leg/YieldCalculationMethod**

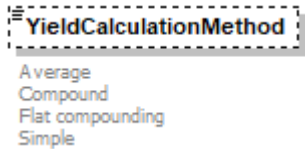
|            |   |
|------------|---|
| diagram    |  <p><b>YieldCalculationMethod</b></p> <ul style="list-style-type: none"> <li>Average</li> <li>Compound</li> <li>Flat compounding</li> <li>Simple</li> </ul> |
| type       | restriction of <b>xs:string</b>   |
| properties | <ul style="list-style-type: none"> <li>isRef 0</li> <li>minOcc 0</li> <li>maxOcc 1</li> <li>content simple</li> </ul>   |
| annotation | <ul style="list-style-type: none"> <li>documentation</li> <li>Average</li> <li>Compound</li> <li>Flat compounding</li> <li>Simple</li> </ul>  |

element **SwapType/Legs/Leg/YieldDayConvention**

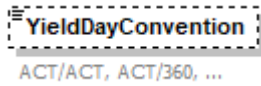
|            |  |
|------------|--|
| diagram    |  <p><b>YieldDayConvention</b></p> <ul style="list-style-type: none"> <li>ACT/ACT, ACT/360, ...</li> </ul> |
| type       | restriction of <b>xs:string</b>  |
| properties | <ul style="list-style-type: none"> <li>isRef 0</li> <li>minOcc 0</li> <li>maxOcc 1</li> <li>content simple</li> </ul>  |
| annotation | <ul style="list-style-type: none"> <li>documentation</li> <li>ACT/ACT, ACT/360, ...</li> </ul>   |

element **SwapType/Legs/Leg/Underlying**

diagram

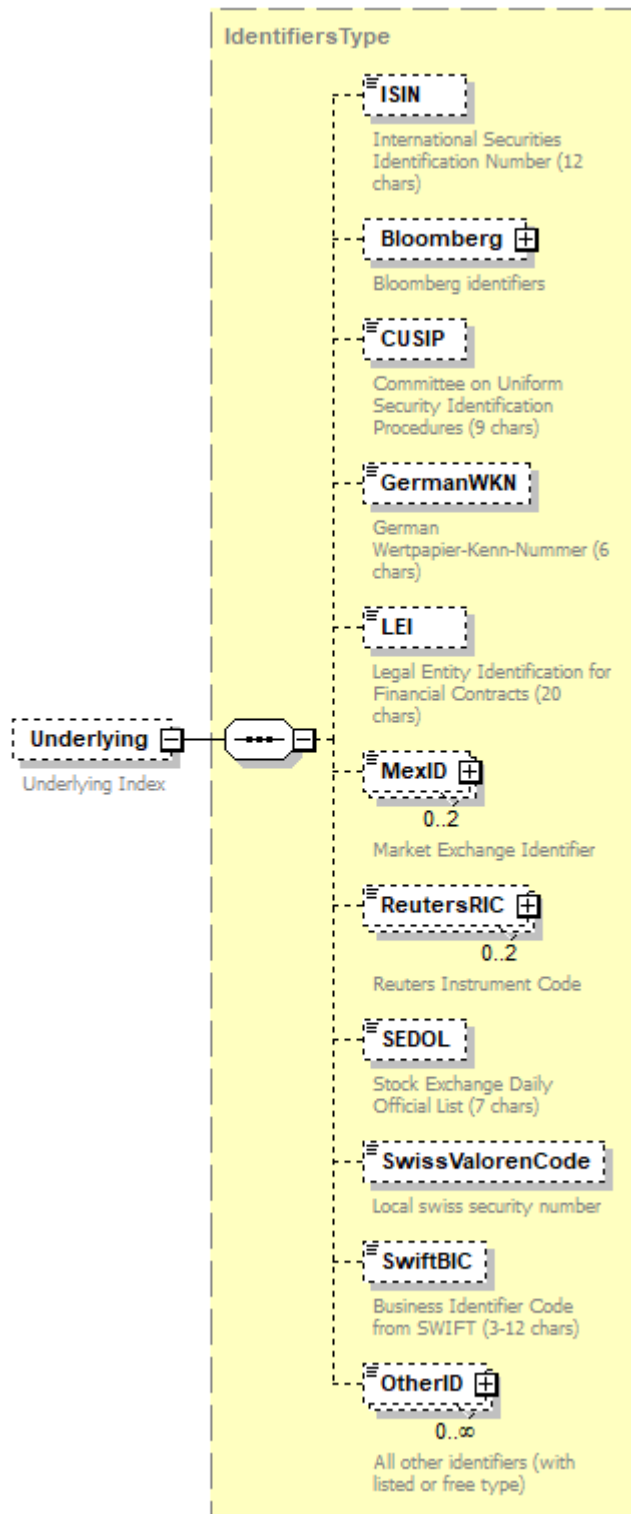

type [IdentifiersType](#)

properties  
 isRef 0  
 minOcc 0  
 maxOcc 1



|            |   |
|------------|---|
|            | content complex   |
| children   | <a href="#">ISIN</a> <a href="#">Bloomberg</a> <a href="#">CUSIP</a> <a href="#">GermanWKN</a> <a href="#">LEI</a> <a href="#">MexID</a> <a href="#">ReutersRIC</a> <a href="#">SEDOL</a> <a href="#">SwissValorenCode</a> <a href="#">SwiftBIC</a> <a href="#">OtherID</a> |
| annotation | documentation<br>Underlying Index   |

element **SwapType/Legs/Leg/ExchangeConvention**

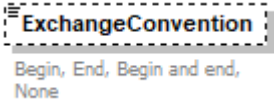
|            |   |
|------------|---|
| diagram    |  The diagram shows a dashed box containing the text "ExchangeConvention". Below the box, the text "Begin, End, Begin and end, None" is listed. |
| type       | restriction of <b>xs:string</b>   |
| properties | isRef 0<br>minOcc 0<br>maxOcc 1<br>content simple   |
| annotation | documentation<br>Begin, End, Begin and end, None  |

element **SwapType/Legs/Leg/InitialReferenceMonth**

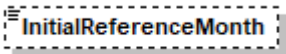
|            |   |
|------------|---|
| diagram    |  The diagram shows a dashed box containing the text "InitialReferenceMonth". |
| type       | restriction of <b>xs:int</b>  |
| properties | isRef 0<br>minOcc 0<br>maxOcc 1<br>content simple   |
| facets     | Kind Value annotation<br>minInclusive 1<br>maxInclusive 12  |

element **SwapType/Legs/Leg/FinalReferenceMonth**

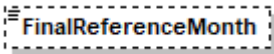
|            |   |
|------------|---|
| diagram    |  The diagram shows a dashed box containing the text "FinalReferenceMonth". |
| type       | restriction of <b>xs:int</b>  |
| properties | isRef 0<br>minOcc 0<br>maxOcc 1<br>content simple   |
| facets     | Kind Value annotation<br>minInclusive 1<br>maxInclusive 12  |

element **SwapType/Legs/Leg/FirstCouponRate**

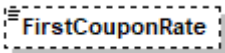
|         |   |
|---------|---|
| diagram |  The diagram shows a dashed box containing the text "FirstCouponRate". |
| type    | <b>xs:decimal</b>   |

|            |   |
|------------|---|
| properties | isRef 0<br>minOcc 0<br>maxOcc 1<br>content simple |
|------------|---|

element **SwapType/Legs/Leg/FirstCouponDate**

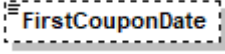
|            |   |
|------------|---|
| diagram    |  |
| type       | <b>xs:date</b>  |
| properties | isRef 0<br>minOcc 0<br>maxOcc 1<br>content simple                                 |

element **SwapType/Legs/Leg/ShortPeriod**

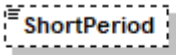
|            |  |
|------------|--|
| diagram    | <br>Interpolation at beginning,<br>Interpolation at the end,<br>Interpolation at beginning<br>and end |
| type       | restriction of <b>xs:string</b>  |
| properties | isRef 0<br>minOcc 0<br>maxOcc 1<br>content simple  |
| annotation | documentation<br>Interpolation at beginning, Interpolation at the end, Interpolation at beginning and end  |

element **SwapType/Legs/Leg/FixingCalendars**

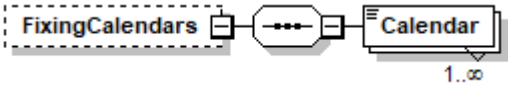
|            |   |
|------------|---|
| diagram    |  |
| properties | isRef 0<br>minOcc 0<br>maxOcc 1<br>content complex                                  |
| children   | <a href="#">Calendar</a>  |

element **SwapType/Legs/Leg/FixingCalendars/Calendar**

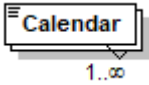
|            |   |
|------------|---|
| diagram    |  |
| type       | restriction of <b>xs:string</b>   |
| properties | isRef 0<br>minOcc 1<br>maxOcc unbounded<br>content simple                           |
| facets     | Kind Value annotation   |

|  |          |
|--|----------|
|  | length 3 |
|--|----------|

element **SwapType/Legs/Leg/PaymentCalendars**

|            |  |
|------------|--|
| diagram    |  |
| properties | isRef 0<br>minOcc 0<br>maxOcc 1<br>content complex |
| children   | <a href="#">Calendar</a>                           |

element **SwapType/Legs/Leg/PaymentCalendars/Calendar**

|            |   |
|------------|---|
| diagram    |   |
| type       | restriction of <b>xs:string</b>                           |
| properties | isRef 0<br>minOcc 1<br>maxOcc unbounded<br>content simple |
| facets     | Kind Value annotation<br>length 3                         |

element **SwapType/Legs/Leg/CreditEvents**

|            |  |
|------------|--|
| diagram    | <p>Bankruptcy, Cross acceleration, Cross Default, Downgrade, Failure to pay principal, Merger, Moratorium, Obligation acceleration, Obligation default, Other, Reputation Moratorium, Restructuring, Withholding Tax</p> |
| properties | isRef 0<br>minOcc 0<br>maxOcc 1<br>content complex   |
| children   | <a href="#">Event</a>  |

element **SwapType/Legs/Leg/CreditEvents/Event**

|            |  |
|------------|--|
| diagram    |  |
| type       | restriction of <b>xs:string</b>  |
| properties | isRef 0<br>minOcc 1<br>maxOcc unbounded<br>content simple  |
| annotation | documentation<br>Bankruptcy, Cross acceleration, Cross Default, Downgrade, Failure to pay principal, Merger, Moratorium, Obligation acceleration, Obligation default, Other, Reputation Moratorium, Restructuring, Withholding Tax |

complexType **UnderlyingType**

|          |  |
|----------|--|
| diagram  |  |
| children | <a href="#">Type</a> <a href="#">UniqueID</a> <a href="#">Name</a> <a href="#">Identifiers</a> <a href="#">Nominale</a>  |
| used by  | elements <a href="#">OptionType/Underlyings/Underlying</a> <a href="#">FutureType/Underlyings/Underlying</a> <a href="#">CertificateType/Underlyings/Underlying</a> <a href="#">WarrantType/Underlyings/Underlying</a> |

element **UnderlyingType/Type**

|            |  |
|------------|--|
| diagram    |  |
| type       | restriction of <b>xs:string</b>                    |
| properties | isRef 0<br>content simple                          |
| annotation | documentation<br>Currency, Security, Future, Index |

element **UnderlyingType/UniqueID**

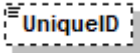
|            |   |
|------------|---|
| diagram    |  |
| type       | <b>xs:IDREF</b>   |
| properties | isRef 0<br>minOcc 0<br>maxOcc 1<br>content simple                                 |

element **UnderlyingType/Name**

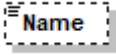
|            |   |
|------------|---|
| diagram    |  |
| type       | <a href="#">Text256Type</a>   |
| properties | isRef 0<br>minOcc 0<br>maxOcc 1<br>content simple                                 |
| facets     | Kind Value annotation<br>maxLength 256  |

element **UnderlyingType/Identifiers**

|                   |  |
|-------------------|--|
| <p>diagram</p>    |  |
| <p>type</p>       | <p><a href="#">IdentifiersType</a></p>   |
| <p>properties</p> | <p>isRef 0<br/>content complex</p>   |
| <p>children</p>   | <p><a href="#">ISIN</a> <a href="#">Bloomberg</a> <a href="#">CUSIP</a> <a href="#">GermanWKN</a> <a href="#">LEI</a> <a href="#">MexID</a> <a href="#">ReutersRIC</a> <a href="#">SEDOL</a> <a href="#">SwissValorenCode</a> <a href="#">SwiftBIC</a> <a href="#">OtherID</a></p> |

element **UnderlyingType/Nominale**

|            |   |
|------------|---|
| diagram    |  |
| type       | <b>xs:decimal</b>   |
| properties | isRef 0<br>minOcc 0<br>maxOcc 1<br>content simple                                 |

# complexType WarrantType

diagram

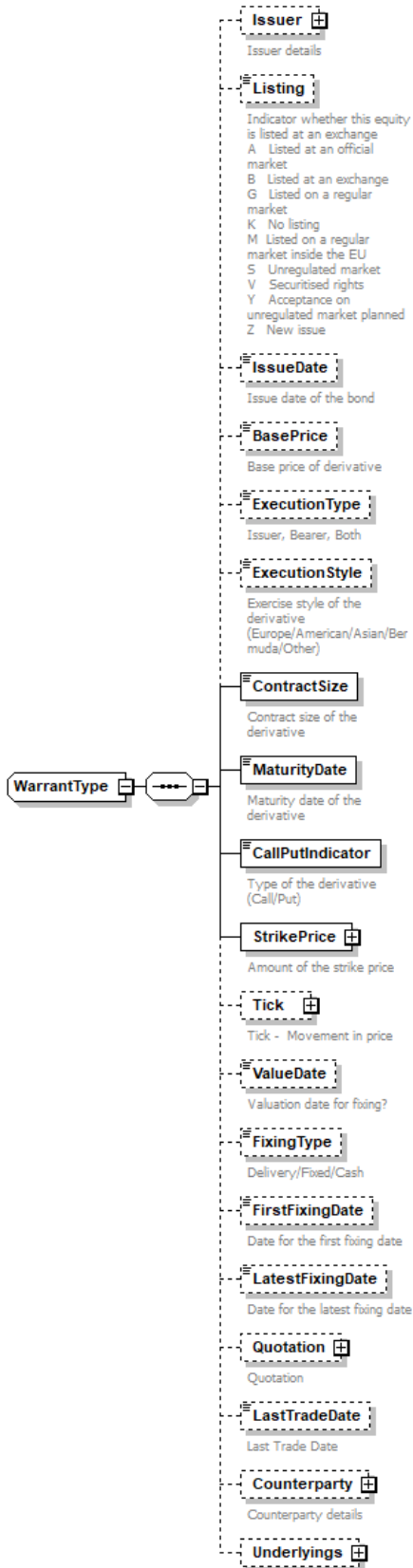



|          |  |
|----------|--|
| children | <a href="#">Issuer</a> <a href="#">Listing</a> <a href="#">IssueDate</a> <a href="#">BasePrice</a> <a href="#">ExecutionType</a> <a href="#">ExecutionStyle</a> <a href="#">ContractSize</a> <a href="#">MaturityDate</a> <a href="#">CallPutIndicator</a> <a href="#">StrikePrice</a> <a href="#">Tick</a> <a href="#">ValueDate</a> <a href="#">FixingType</a> <a href="#">FirstFixingDate</a> <a href="#">LatestFixingDate</a> <a href="#">Quotation</a> <a href="#">LastTradeDate</a> <a href="#">Counterparty</a> <a href="#">Underlyings</a> |
| used by  | element <a href="#">AssetDetailsType/Warrant</a>   |

element **WarrantType/Issuer**

|            |  |
|------------|--|
| diagram    | <p>The diagram illustrates the structure of the <b>WarrantType/Issuer</b> element. It is a complex type containing several child elements:</p> <ul style="list-style-type: none"> <li><b>Identifiers</b>: Identifiers of company</li> <li><b>Name</b>: Name of company</li> <li><b>LegalName</b>: Legal (full) name of company</li> <li><b>LegalForm</b>: Legal form of company</li> <li><b>Address</b>: Address of company</li> <li><b>BusinessCountry</b>: Country code of main business of company</li> <li><b>ParentCompany</b>: Parent company (if applicable)</li> <li><b>OtherClassification</b>: All other identifiers (with listed or free type). Multiplicity: 0..∞</li> </ul> <p>The <b>Issuer</b> element is shown as a separate box connected to the main structure, representing issuer details.</p> |
| type       | <a href="#">CompanyType</a>  |
| properties | isRef 0<br>minOcc 0<br>maxOcc 1<br>content complex   |
| children   | <a href="#">Identifiers</a> <a href="#">Name</a> <a href="#">LegalName</a> <a href="#">LegalForm</a> <a href="#">Address</a> <a href="#">BusinessCountry</a> <a href="#">ParentCompany</a> <a href="#">OtherClassification</a>   |
| annotation | documentation<br>Issuer details<br>documentation<br>Enthaelt den Wertpapieremittenten  |

element **WarrantType/Listing**

|            |  |
|------------|--|
| diagram    |  <p>Indicator whether this equity is listed at an exchange</p> <p>A Listed at an official market</p> <p>B Listed at an exchange</p> <p>G Listed on a regular market</p> <p>K No listing</p> <p>M Listed on a regular market inside the EU</p> <p>S Unregulated market</p> <p>V Securitised rights</p> <p>Y Acceptance on unregulated market planned</p> <p>Z New issue</p>  |
| type       | restriction of <b>xs:string</b>  |
| properties | <p>isRef 0</p> <p>minOcc 0</p> <p>maxOcc 1</p> <p>content simple</p>   |
| annotation | <p>documentation</p> <p>Indicator whether this equity is listed at an exchange</p> <p>A Listed at an official market</p> <p>B Listed at an exchange</p> <p>G Listed on a regular market</p> <p>K No listing</p> <p>M Listed on a regular market inside the EU</p> <p>S Unregulated market</p> <p>V Securitised rights</p> <p>Y Acceptance on unregulated market planned</p> <p>Z New issue</p> <p>documentation</p> <p>Gibt an ob das Wertpapier an einer Boerse notiert</p> <ul style="list-style-type: none"> <li>- A Amtlicher Handel</li> <li>- B Boersennotierung Ausland</li> <li>- G Geregelter Freiverkehr</li> <li>- K Keine Boersenotierung</li> <li>- M Geregelter Markt id. EU</li> <li>- S Sonstiger Handel</li> <li>- V Verbriefte Rechte</li> <li>- Y Zulassung zum sonst. Handel vorges.</li> <li>- Z Neuemission</li> </ul> |

element **WarrantType/IssueDate**

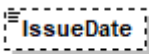
|            |   |
|------------|---|
| diagram    |  <p>Issue date of the bond</p>   |
| type       | <b>xs:date</b>  |
| properties | <p>isRef 0</p> <p>minOcc 0</p> <p>maxOcc 1</p> <p>content simple</p>  |
| annotation | <p>documentation</p> <p>Issue date of the bond</p> <p>documentation</p> <p>Emissionsdatum bezeichnet jenes Datum, zu dem das Wertpapier aufgelegt wurde</p> |

element **WarrantType/BasePrice**

|            |  |
|------------|--|
| diagram    |                           |
| type       | <b>xs:decimal</b>  |
| properties | isRef 0<br>minOcc 0<br>maxOcc 1<br>content simple  |
| annotation | documentation<br>Base price of derivative<br>documentation<br>Gibt den Basispreis des Derivatenprodukts an |

element **WarrantType/ExecutionType**

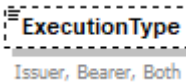
|            |   |
|------------|---|
| diagram    |  |
| type       | restriction of <b>xs:string</b>   |
| properties | isRef 0<br>minOcc 0<br>maxOcc 1<br>content simple                                 |
| annotation | documentation<br>Issuer, Bearer, Both   |

element **WarrantType/ExecutionStyle**

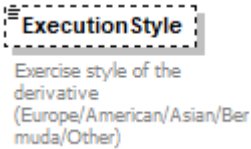
|            |   |
|------------|---|
| diagram    |    |
| type       | restriction of <b>xs:string</b>   |
| properties | isRef 0<br>minOcc 0<br>maxOcc 1<br>content simple   |
| annotation | documentation<br>Exercise style of the derivative (Europe/American/Asian/Bermuda/Other)<br>documentation<br>Gibt an den Ausuebsungsstyle an (Europe/American/Asian/Bermuda/Other) |

element **WarrantType/ContractSize**

|            |   |
|------------|---|
| diagram    |  |
| type       | <b>xs:decimal</b>   |
| properties | isRef 0<br>content simple   |

|            |  |
|------------|--|
| annotation | documentation<br>Contract size of the derivative<br>documentation<br>Gibt die Kontraktgrosze des Derivatprodukt an |
|------------|--|

### element **WarrantType/MaturityDate**

|            |   |
|------------|---|
| diagram    |                                    |
| type       | <b>xs:date</b>  |
| properties | isRef 0<br>content simple   |
| annotation | documentation<br>Maturity date of the derivative<br>documentation<br>Bezeichnet das Ablaufdatum des Derivatprodukts |

### element **WarrantType/CallPutIndicator**

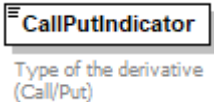
|            |   |
|------------|---|
| diagram    |                                    |
| type       | restriction of <b>xs:string</b>   |
| properties | isRef 0<br>content simple   |
| annotation | documentation<br>Type of the derivative (Call/Put)<br>documentation<br>Kennzeichnet die Art des Derivats (Call/Put) |

### element **WarrantType/StrikePrice**

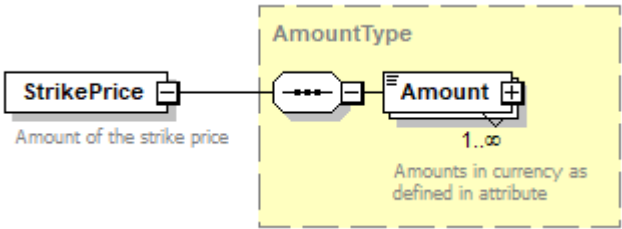
|            |   |
|------------|---|
| diagram    |  |
| type       | <a href="#">AmountType</a>  |
| properties | isRef 0<br>content complex  |
| children   | <a href="#">Amount</a>  |
| annotation | documentation<br>Amount of the strike price   |

element **WarrantType/Tick**

|            |  |
|------------|--|
| diagram    |  |
| properties | isRef 0<br>minOcc 0<br>maxOcc 1<br>content complex |
| children   | <a href="#">TickSize</a> <a href="#">TickValue</a> |
| annotation | documentation<br>Tick - Movement in price          |

element **WarrantType/Tick/TickSize**

|            |   |
|------------|---|
| diagram    |   |
| type       | <b>xs:decimal</b>   |
| properties | isRef 0<br>minOcc 0<br>maxOcc 1<br>content simple             |
| annotation | documentation<br>Minimum downward or upward movement in price |

element **WarrantType/Tick/TickValue**

|            |  |
|------------|--|
| diagram    |  |
| type       | <a href="#">AmountType</a>                         |
| properties | isRef 0<br>minOcc 0<br>maxOcc 1<br>content complex |
| children   | <a href="#">Amount</a>                             |
| annotation | documentation<br>Value of the tick                 |

element **WarrantType/ValueDate**

|            |   |
|------------|---|
| diagram    |  |
| type       | <b>xs:date</b>  |
| properties | isRef 0<br>minOcc 0<br>maxOcc 1<br>content simple                                 |
| annotation | documentation<br>Valuation date for fixing?                                       |

element **WarrantType/FixingType**

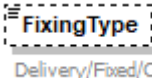
|            |   |
|------------|---|
| diagram    |  |
| type       | restriction of <b>xs:string</b>   |
| properties | isRef 0<br>minOcc 0<br>maxOcc 1<br>content simple                                 |
| annotation | documentation<br>Delivery/Fixed/Cash  |

element **WarrantType/FirstFixingDate**

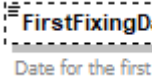
|            |   |
|------------|---|
| diagram    |  |
| type       | <b>xs:date</b>  |
| properties | isRef 0<br>minOcc 0<br>maxOcc 1<br>content simple                                   |
| annotation | documentation<br>Date for the first fixing date                                     |

element **WarrantType/LatestFixingDate**

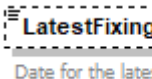
|            |   |
|------------|---|
| diagram    |  |
| type       | <b>xs:date</b>  |
| properties | isRef 0<br>minOcc 0<br>maxOcc 1<br>content simple                                   |
| annotation | documentation<br>Date for the latest fixing date                                    |

### element WarrantType/Quotation

|            |  |
|------------|--|
| diagram    |  |
| properties | isRef 0<br>minOcc 0<br>maxOcc 1<br>content complex   |
| children   | <a href="#">QuotationType</a> <a href="#">QuotationPercent</a> <a href="#">QuotationAmount</a> |
| annotation | documentation<br>Quotation   |

### element WarrantType/Quotation/QuotationType

|            |   |
|------------|---|
| diagram    |   |
| type       | restriction of <b>xs:string</b>                   |
| properties | isRef 0<br>minOcc 0<br>maxOcc 1<br>content simple |
| annotation | documentation<br>Price/Yield/Other                |

### element WarrantType/Quotation/QuotationPercent

|            |   |
|------------|---|
| diagram    |   |
| type       | <b>xs:float</b>                                   |
| properties | isRef 0<br>minOcc 0<br>maxOcc 1<br>content simple |
| annotation | documentation<br>Quotation in percent             |

element **WarrantType/Quotation/QuotationAmount**

|            |  |
|------------|--|
| diagram    |  |
| type       | <a href="#">AmountType</a>                         |
| properties | isRef 0<br>minOcc 0<br>maxOcc 1<br>content complex |
| children   | <a href="#">Amount</a>                             |
| annotation | documentation<br>Amount of Quotation               |

element **WarrantType/LastTradeDate**

|            |   |
|------------|---|
| diagram    |   |
| type       | <b>xs:date</b>                                    |
| properties | isRef 0<br>minOcc 0<br>maxOcc 1<br>content simple |
| annotation | documentation<br>Last Trade Date                  |



element **WarrantType/Counterparty**

|                   |   |
|-------------------|---|
| <p>diagram</p>    |   |
| <p>type</p>       | <p><a href="#">CompanyType</a></p>  |
| <p>properties</p> | <p>isRef 0<br/>minOcc 0<br/>maxOcc 1<br/>content complex</p>  |
| <p>children</p>   | <p><a href="#">Identifiers</a> <a href="#">Name</a> <a href="#">LegalName</a> <a href="#">LegalForm</a> <a href="#">Address</a> <a href="#">BusinessCountry</a> <a href="#">ParentCompany</a> <a href="#">OtherClassification</a></p> |
| <p>annotation</p> | <p>documentation<br/>Counterparty details</p>   |

element **WarrantType/Underlyings**

|                   |  |
|-------------------|--|
| <p>diagram</p>    |  |
| <p>properties</p> | <p>isRef 0<br/>minOcc 0<br/>maxOcc 1<br/>content complex</p> |
| <p>children</p>   | <p><a href="#">Underlying</a></p>                            |

element **WarrantType/Underlyings/Underlying**

|            |   |
|------------|---|
| diagram    | <p>The diagram shows an <b>Underlying</b> element (multiplicity 1..∞) with the description "Bezeichnet das dem Derivatvprodukt unterlegte Wertpapier". It is connected to a container <b>UnderlyingType</b>. Inside <b>UnderlyingType</b>, there are five sub-elements: <b>Type</b> (with values Currency, Security, Future, Index), <b>UniqueID</b>, <b>Name</b>, <b>Identifiers</b>, and <b>Nominale</b>.</p> |
| type       | <a href="#">UnderlyingType</a>  |
| properties | isRef 0<br>minOcc 1<br>maxOcc unbounded<br>content complex  |
| children   | <a href="#">Type</a> <a href="#">UniqueID</a> <a href="#">Name</a> <a href="#">Identifiers</a> <a href="#">Nominale</a>   |
| annotation | documentation<br>Bezeichnet das dem Derivatvprodukt unterlegte Wertpapier   |

simpleType **AssetTypeType**

|            |   |
|------------|---|
| type       | restriction of <b>xs:string</b>             |
| properties | base <b>xs:string</b>                       |
| used by    | element <a href="#">AssetType/AssetType</a> |

complexType **AssetManagementClosedDataType**

|            |  |
|------------|--|
| diagram    | <p>The diagram shows an <b>AssetManagementClosedDataT...</b> element with the description "Data of the investment or asset management company for closed-ended funds". It is connected to two sub-elements: <b>OwnFunds</b> and <b>ThirdPartyFunds</b>.</p>  |
| children   | <a href="#">OwnFunds</a> <a href="#">ThirdPartyFunds</a>   |
| used by    | element <a href="#">AssetManagementCompanyAggregatedType/ClosedEndedFunds/RetailFunds/RealAssets</a><br>s <a href="#">AssetManagementCompanyAggregatedType/ClosedEndedFunds/InstitutionalFunds/RealAssets</a><br><a href="#">AssetManagementCompanyAggregatedType/ClosedEndedFunds/RetailFunds/Securities Holdings</a><br><a href="#">AssetManagementCompanyAggregatedType/ClosedEndedFunds/InstitutionalFunds/Securities Holdings</a> |
| annotation | documentation<br>Data of the investment or asset management company for closed-ended funds   |

element **AssetManagementClosedDataType/OwnFunds**

|            |   |
|------------|---|
| diagram    | <p>The diagram shows the structure of the <b>OwnFunds</b> element. It is a complex type containing the following elements:</p> <ul style="list-style-type: none"> <li><b>Number</b>: Number of funds</li> <li><b>AssetInformation</b></li> <li><b>NetSalesInformation</b></li> <li><b>Segmentation</b>: Information about the segmentation of funds</li> <li><b>PortfoliomanagementByThirdP...</b>: Information about the structure of the respective investment or asset management company with regard to portfoliomanagement or advise by third parties</li> </ul> |
| properties | <p>isRef 0<br/> minOcc 0<br/> maxOcc 1<br/> content complex</p>   |
| children   | <p><a href="#">Number</a> <a href="#">AssetInformation</a> <a href="#">NetSalesInformation</a> <a href="#">Segmentation</a> <a href="#">PortfoliomanagementByThirdParties</a></p>   |

element **AssetManagementClosedDataType/OwnFunds/Number**

|            |   |
|------------|---|
| diagram    | <p>The diagram shows the structure of the <b>Number</b> element, which is a simple integer type representing the number of funds.</p> |
| type       | <p><b>xs:int</b></p>  |
| properties | <p>isRef 0<br/> content simple</p>  |
| annotation | <p>documentation<br/> Number of funds</p>   |

element **AssetManagementClosedDataType/OwnFunds/AssetInformation**

|                   |  |
|-------------------|--|
| <p>diagram</p>    | <p>The diagram illustrates the structure of the <b>AssetInformation</b> element. It is connected to a dashed box representing the <b>AssetManagementCompanyFundAssetsType</b>. Inside this box, there are two sub-elements: <b>NetAssets</b> and <b>GrossAssets</b>. <b>NetAssets</b> is described as "Net assets in total, calculated on an overall basis including outstanding debts, bank loans, and other liabilities (Net Asset Value approach). In thousands of currency." <b>GrossAssets</b> is described as "Assets in total, calculated on a basis excluding outstanding debts, bank loans, and other liabilities (Gross Asset Value approach). 'Aktivvermoegeen' in German. In thousands of currency."</p> |
| <p>type</p>       | <p><a href="#">AssetManagementCompanyFundAssetsType</a></p>  |
| <p>properties</p> | <p>isRef 0<br/>content complex</p>   |
| <p>children</p>   | <p><a href="#">NetAssets</a> <a href="#">GrossAssets</a></p>   |

element **AssetManagementClosedDataType/OwnFunds/NetSalesInformation**

|                   |   |
|-------------------|---|
| <p>diagram</p>    | <p>The diagram illustrates the structure of the <b>NetSalesInformation</b> element. It is connected to a dashed box representing the <b>AssetManagementCompanySalesType</b>. Inside this box, there are two sub-elements: <b>NetSales</b> and <b>EquityPlaced</b>. <b>NetSales</b> is described as "Net Sales in the Reporting Period (in most cases on a monthly basis) in thousands of currency". <b>EquityPlaced</b> is described as "Equity placed; equivalent to gross sales in open-ended funds. Refers to the month reported, given in thousands of currency."</p> |
| <p>type</p>       | <p><a href="#">AssetManagementCompanySalesType</a></p>  |
| <p>properties</p> | <p>isRef 0<br/>content complex</p>  |
| <p>children</p>   | <p><a href="#">NetSales</a> <a href="#">EquityPlaced</a></p>  |

element **AssetManagementClosedDataType/OwnFunds/Segmentation**

|            |  |
|------------|--|
| diagram    | <p>The diagram shows the 'Segmentation' element (represented by a box with a small square icon) connected to a central connector box containing three dots. From this connector, three lines branch out to three child elements: 'FundsWithoutSegments', 'FundsWithSegments', and 'NumberOfAdministrativeUnits'. Each child element is shown in a box with its own icon (square, plus, and square respectively).</p> <p><b>Segmentation</b><br/>Information about the segmentation of funds</p> <p><b>FundsWithoutSegments</b><br/>Number of funds without segments or comparable subunits</p> <p><b>FundsWithSegments</b><br/>Data about the funds with segments of an investment or asset management company</p> <p><b>NumberOfAdministrativeUnits</b><br/>Total number of administrative units, which is the sum of the number of funds without segments and comparable subunits and the number of segments or comparable subunits.</p> |
| properties | isRef 0<br>content complex   |
| children   | <a href="#">FundsWithoutSegments</a> <a href="#">FundsWithSegments</a> <a href="#">NumberOfAdministrativeUnits</a>   |
| annotation | documentation<br>Information about the segmentation of funds   |

element **AssetManagementClosedDataType/OwnFunds/Segmentation/FundsWithoutSegments**

|            |  |
|------------|--|
| diagram    | <p>The diagram shows the 'FundsWithoutSegments' element in a box with a square icon. Below the box is the text: 'Number of funds without segments or comparable subunits'.</p> |
| type       | <b>xs:int</b>  |
| properties | isRef 0<br>content simple  |
| annotation | documentation<br>Number of funds without segments or comparable subunits   |

element **AssetManagementClosedDataType/OwnFunds/Segmentation/FundsWithSegments**

|            |  |
|------------|--|
| diagram    | <p>The diagram shows the 'FundsWithSegments' element (represented by a box with a small square icon) connected to a central connector box containing three dots. From this connector, three lines branch out to three child elements: 'Number', 'NumberOfSegments', and 'NetAssetsSegments'. Each child element is shown in a box with its own icon (square, square, and plus respectively).</p> <p><b>FundsWithSegments</b><br/>Data about the funds with segments of an investment or asset management company</p> <p><b>Number</b><br/>Number of funds with segments or comparable subunits</p> <p><b>NumberOfSegments</b><br/>Number of segments or comparable subunits</p> <p><b>NetAssetsSegments</b><br/>Net asstes of funds with segments or comparable subunits</p> |
| properties | isRef 0<br>content complex   |
| children   | <a href="#">Number</a> <a href="#">NumberOfSegments</a> <a href="#">NetAssetsSegments</a>  |
| annotation | documentation<br>Data about the funds with segments of an investment or asset management company   |

element **AssetManagementClosedDataType/OwnFunds/Segmentation/FundsWithSegments/Number**

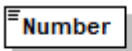
|            |   |
|------------|---|
| diagram    |  <p>Number of funds with segments or comparable subunits</p> |
| type       | <b>xs:int</b>   |
| properties | isRef 0<br>content simple   |
| annotation | documentation<br>Number of funds with segments or comparable subunits   |

element **AssetManagementClosedDataType/OwnFunds/Segmentation/FundsWithSegments/NumberOfSegments**

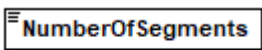
|            |  |
|------------|--|
| diagram    |  <p>Number of segments or comparable subunits</p> |
| type       | <b>xs:int</b>  |
| properties | isRef 0<br>content simple  |
| annotation | documentation<br>Number of segments or comparable subunits   |

element **AssetManagementClosedDataType/OwnFunds/Segmentation/FundsWithSegments/NetAssetsSegments**

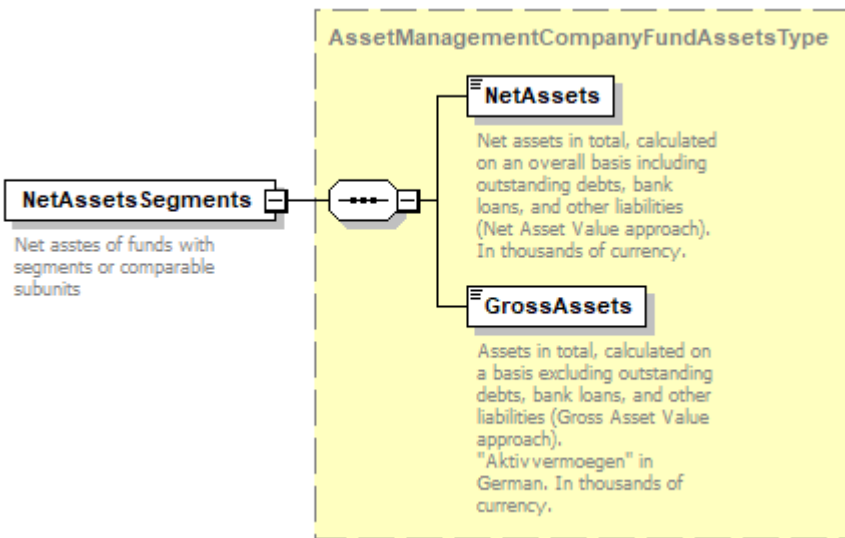
|            |   |
|------------|---|
| diagram    |  <p>Net asstes of funds with segments or comparable subunits</p> <p><b>AssetManagementCompanyFundAssetsType</b></p> <p><b>NetAssets</b><br/>Net assets in total, calculated on an overall basis including outstanding debts, bank loans, and other liabilities (Net Asset Value approach). In thousands of currency.</p> <p><b>GrossAssets</b><br/>Assets in total, calculated on a basis excluding outstanding debts, bank loans, and other liabilities (Gross Asset Value approach). "Aktiv vermoegen" in German. In thousands of currency.</p> |
| type       | <a href="#">AssetManagementCompanyFundAssetsType</a>  |
| properties | isRef 0<br>content complex  |
| children   | <a href="#">NetAssets</a> <a href="#">GrossAssets</a>   |

|            |   |
|------------|---|
| annotation | documentation<br>Net asstes of funds with segments or comparable subunits |
|------------|---|

element **AssetManagementClosedDataType/OwnFunds/Segmentation/NumberOfAdministrativeUnits**

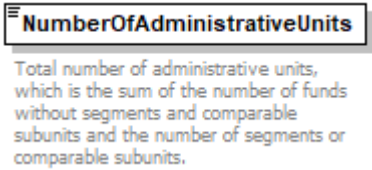
|            |  |
|------------|--|
| diagram    |   |
| type       | <b>xs:int</b>  |
| properties | isRef 0<br>content simple  |
| annotation | documentation<br>Total number of administrative units, which is the sum of the number of funds without segments and comparable subunits and the number of segments or comparable subunits. |

element **AssetManagementClosedDataType/OwnFunds/PortfoliomanagementByThirdParties**

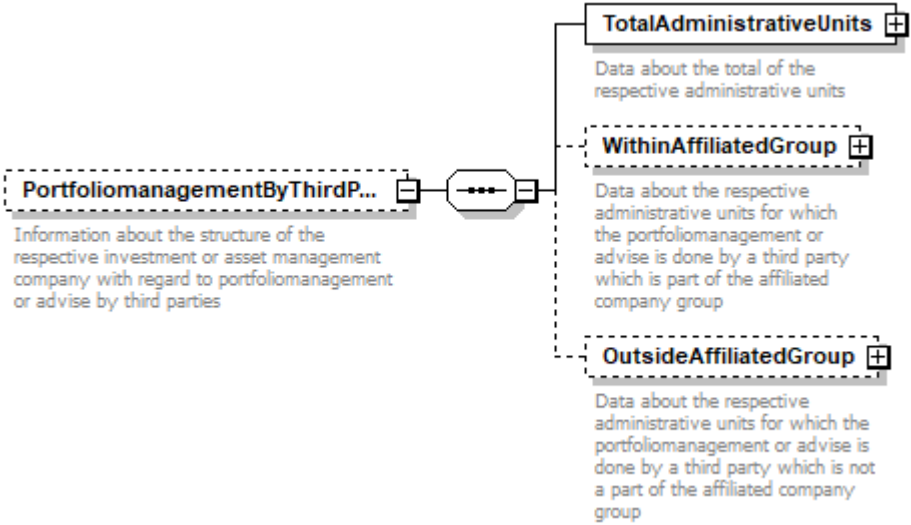
|            |   |
|------------|---|
| diagram    |    |
| properties | isRef 0<br>minOcc 0<br>maxOcc 1<br>content complex  |
| children   | <a href="#">TotalAdministrativeUnits</a> <a href="#">WithinAffiliatedGroup</a> <a href="#">OutsideAffiliatedGroup</a>   |
| annotation | documentation<br>Information about the structure of the respective investment or asset management company with regard to portfoliomanagement or advise by third parties |

element

**AssetManagementClosedDataType/OwnFunds/PortfoliomangementByThirdParties/TotalAdministrativeUnits**

|                   |   |
|-------------------|---|
| <p>diagram</p>    |   |
| <p>type</p>       | <p><a href="#">FundStatisticClosedFundType</a></p>  |
| <p>properties</p> | <p>isRef 0<br/>content complex</p>  |
| <p>children</p>   | <p><a href="#">Number</a> <a href="#">AssetsClosedFunds</a> <a href="#">NetSalesClosedFunds</a></p> |
| <p>annotation</p> | <p>documentation<br/>Data about the total of the respective administrative units</p>                |

element

**AssetManagementClosedDataType/OwnFunds/PortfoliomangementByThirdParties/WithinAffiliatedGroup**

|                   |   |
|-------------------|---|
| <p>diagram</p>    |   |
| <p>properties</p> | <p>isRef 0<br/>minOcc 0<br/>maxOcc 1<br/>content complex</p>  |
| <p>children</p>   | <p><a href="#">TotalAdministrativeUnits</a> <a href="#">CompaniesInCountry</a></p>  |
| <p>annotation</p> | <p>documentation<br/>Data about the respective administrative units for which the portfoliomangement or advise is done by a third party which is part of the affiliated company group</p> |



element

**AssetManagementClosedDataType/OwnFunds/PortfoliomanagementByThirdParties/WithinAffiliatedGroup/TotalAdministrativeUnits**

|                   |   |
|-------------------|---|
| <p>diagram</p>    | <p>The diagram illustrates the structure of the <b>TotalAdministrativeUnits</b> element. It is a complex type (indicated by a dashed box) that contains three child elements: <b>Number</b>, <b>AssetsClosedFunds</b>, and <b>NetSalesClosedFunds</b>. The <b>Number</b> element is described as 'Number of fundrelated administrative units'. The <b>AssetsClosedFunds</b> and <b>NetSalesClosedFunds</b> elements are also shown as complex types. The <b>TotalAdministrativeUnits</b> element is described as 'Data about the total of the respective administrative units'.</p> |
| <p>type</p>       | <p><a href="#">FundStatisticClosedFundType</a></p>  |
| <p>properties</p> | <p>isRef 0<br/>content complex</p>  |
| <p>children</p>   | <p><a href="#">Number</a> <a href="#">AssetsClosedFunds</a> <a href="#">NetSalesClosedFunds</a></p>   |
| <p>annotation</p> | <p>documentation<br/>Data about the total of the respective administrative units</p>  |

element

**AssetManagementClosedDataType/OwnFunds/PortfoliomanagementByThirdParties/WithinAffiliatedGroup/CompaniesInCountry**

|                   |  |
|-------------------|--|
| <p>diagram</p>    | <p>The diagram illustrates the structure of the <b>CompaniesInCountry</b> element. It is a complex type (indicated by a dashed box) that contains three child elements: <b>Number</b>, <b>AssetsClosedFunds</b>, and <b>NetSalesClosedFunds</b>. The <b>Number</b> element is described as 'Number of fundrelated administrative units'. The <b>AssetsClosedFunds</b> and <b>NetSalesClosedFunds</b> elements are also shown as complex types. The <b>CompaniesInCountry</b> element is described as 'Data about the part of the total which is related to the companies within the respective country'.</p> |
| <p>type</p>       | <p><a href="#">FundStatisticClosedFundType</a></p>   |
| <p>properties</p> | <p>isRef 0<br/>minOcc 0<br/>maxOcc 1<br/>content complex</p>   |
| <p>children</p>   | <p><a href="#">Number</a> <a href="#">AssetsClosedFunds</a> <a href="#">NetSalesClosedFunds</a></p>  |
| <p>annotation</p> | <p>documentation<br/>Data about the part of the total which is related to the companies within the respective country</p>  |

element

**AssetManagementClosedDataType/OwnFunds/PortfoliomanagementByThirdParties/OutsideAffiliatedGroup**

|            |   |
|------------|---|
| diagram    |   |
| properties | <p>isRef 0<br/> minOcc 0<br/> maxOcc 1<br/> content complex</p>   |
| children   | <p><a href="#">TotalAdministrativeUnits</a> <a href="#">CompaniesInCountry</a></p>  |
| annotation | <p>documentation<br/> Data about the respective administrative units for which the portfoliomanagement or advise is done by a third party which is not a part of the affiliated company group</p> |

element

**AssetManagementClosedDataType/OwnFunds/PortfoliomanagementByThirdParties/OutsideAffiliatedGroup/TotalAdministrativeUnits**

|            |   |
|------------|---|
| diagram    |   |
| type       | <p><a href="#">FundStatisticClosedFundType</a></p>  |
| properties | <p>isRef 0<br/> content complex</p>   |
| children   | <p><a href="#">Number</a> <a href="#">AssetsClosedFunds</a> <a href="#">NetSalesClosedFunds</a></p> |
| annotation | <p>documentation<br/> Data about the total of the respective administrative units</p>               |

element

**AssetManagementClosedDataType/OwnFunds/PortfoliomangementByThirdParties/OutsideAffiliatedGroup/CompaniesInCountry**

|            |  |
|------------|--|
| diagram    | <p><b>CompaniesInCountry</b><br/>Data about the part of the total which is related to the companies within the respective country</p> <p><b>FundStatisticClosedFundType</b></p> <ul style="list-style-type: none"> <li><b>Number</b><br/>Number of fundrelated administrative units</li> <li><b>AssetsClosedFunds</b></li> <li><b>NetSalesClosedFunds</b></li> </ul> |
| type       | <a href="#">FundStatisticClosedFundType</a>  |
| properties | isRef 0<br>minOcc 0<br>maxOcc 1<br>content complex   |
| children   | <a href="#">Number</a> <a href="#">AssetsClosedFunds</a> <a href="#">NetSalesClosedFunds</a>   |
| annotation | documentation<br>Data about the part of the total which is related to the companies within the respective country  |

element **AssetManagementClosedDataType/ThirdPartyFunds**

|            |   |
|------------|---|
| diagram    | <p><b>ThirdPartyFunds</b></p> <p><b>PortfoliomangementForThirdParty</b><br/>Information about the structure of the portfolio Management or the advise for third parties</p> |
| properties | isRef 0<br>minOcc 0<br>maxOcc 1<br>content complex  |
| children   | <a href="#">PortfoliomangementForThirdParty</a>   |

element **AssetManagementClosedDataType/ThirdPartyFunds/PortfoliomangementForThirdParty**

|            |   |
|------------|---|
| diagram    | <p><b>PortfoliomangementForThirdParty</b><br/>Information about the structure of the portfolio Management or the advise for third parties</p> <ul style="list-style-type: none"> <li><b>TotalAdministrativeUnits</b><br/>Total figures for the respective administrative units</li> <li><b>WithinAffiliatedGroup</b><br/>Assets for third parties within the affiliated group</li> <li><b>OutsideAffiliatedGroup</b><br/>Assets for third parties which are not part of the affiliated group</li> </ul> |
| properties | isRef 0<br>content complex  |
| children   | <a href="#">TotalAdministrativeUnits</a> <a href="#">WithinAffiliatedGroup</a> <a href="#">OutsideAffiliatedGroup</a>   |
| annotation | documentation   |

Information about the structure of the portfolio Management or the advise for third parties

element  
**AssetManagementClosedDataType/ThirdPartyFunds/PortfoliomanagementForThirdParty/TotalAdministrativeUnits**

|            |  |
|------------|--|
| diagram    | <p>The diagram illustrates the structure of the <b>TotalAdministrativeUnits</b> element. It is connected to a dashed box labeled <b>FundStatisticClosedFundType</b>. Inside this box, there are three sub-elements: <b>Number</b> (Number of fundrelated administrative units), <b>AssetsClosedFunds</b>, and <b>NetSalesClosedFunds</b>. The <b>TotalAdministrativeUnits</b> element is described as "Total figures for the respective administrative units".</p> |
| type       | <a href="#">FundStatisticClosedFundType</a>  |
| properties | isRef 0<br>content complex   |
| children   | <a href="#">Number</a> <a href="#">AssetsClosedFunds</a> <a href="#">NetSalesClosedFunds</a>   |
| annotation | documentation<br>Total figures for the respective administrative units   |

element  
**AssetManagementClosedDataType/ThirdPartyFunds/PortfoliomanagementForThirdParty/WithinAffiliatedGroup**

|            |   |
|------------|---|
| diagram    | <p>The diagram illustrates the structure of the <b>WithinAffiliatedGroup</b> element. It is connected to <b>TotalAdministrativeUnits</b> and <b>CompaniesInCountry</b>. The <b>WithinAffiliatedGroup</b> element is described as "Assets for third parties within the affiliated group". The <b>TotalAdministrativeUnits</b> element is described as "Total figures for the respective administrative units". The <b>CompaniesInCountry</b> element is described as "Data about the part of the total which is related to the companies within the respective country".</p> |
| properties | isRef 0<br>minOcc 0<br>maxOcc 1<br>content complex  |
| children   | <a href="#">TotalAdministrativeUnits</a> <a href="#">CompaniesInCountry</a>   |
| annotation | documentation<br>Assets for third parties within the affiliated group   |

element

**AssetManagementClosedDataType/ThirdPartyFunds/PortfoliomanagementForThirdParty/WithinAffiliate  
dGroup/TotalAdministrativeUnits**

|                   |  |
|-------------------|--|
| <p>diagram</p>    | <p>The diagram illustrates the structure of the <b>TotalAdministrativeUnits</b> element. It is a complex type that contains three child elements: <b>Number</b> (representing the number of fundrelated administrative units), <b>AssetsClosedFunds</b>, and <b>NetSalesClosedFunds</b>. The <b>Number</b> element is shown with a value of 0. The <b>AssetsClosedFunds</b> and <b>NetSalesClosedFunds</b> elements are shown with plus signs, indicating they are optional or have a default value. The entire structure is contained within a dashed box labeled <b>FundStatisticClosedFundType</b>.</p> |
| <p>type</p>       | <p><a href="#">FundStatisticClosedFundType</a></p>   |
| <p>properties</p> | <p>isRef 0<br/>content complex</p>   |
| <p>children</p>   | <p><a href="#">Number</a> <a href="#">AssetsClosedFunds</a> <a href="#">NetSalesClosedFunds</a></p>  |
| <p>annotation</p> | <p>documentation<br/>Total figures for the respective administrative units</p>   |

element

**AssetManagementClosedDataType/ThirdPartyFunds/PortfoliomanagementForThirdParty/WithinAffiliate  
dGroup/CompaniesInCountry**

|                   |  |
|-------------------|--|
| <p>diagram</p>    | <p>The diagram illustrates the structure of the <b>CompaniesInCountry</b> element. It is a complex type that contains three child elements: <b>Number</b> (representing the number of fundrelated administrative units), <b>AssetsClosedFunds</b>, and <b>NetSalesClosedFunds</b>. The <b>Number</b> element is shown with a value of 0. The <b>AssetsClosedFunds</b> and <b>NetSalesClosedFunds</b> elements are shown with plus signs, indicating they are optional or have a default value. The entire structure is contained within a dashed box labeled <b>FundStatisticClosedFundType</b>.</p> |
| <p>type</p>       | <p><a href="#">FundStatisticClosedFundType</a></p>   |
| <p>properties</p> | <p>isRef 0<br/>minOcc 0<br/>maxOcc 1<br/>content complex</p>   |
| <p>children</p>   | <p><a href="#">Number</a> <a href="#">AssetsClosedFunds</a> <a href="#">NetSalesClosedFunds</a></p>  |
| <p>annotation</p> | <p>documentation<br/>Data about the part of the total which is related to the companies within the respective country</p>  |

element

**AssetManagementClosedDataType/ThirdPartyFunds/PortfoliomangementForThirdParty/OutsideAffiliatedGroup**

|            |   |
|------------|---|
| diagram    |   |
| properties | <p>isRef 0<br/> minOcc 0<br/> maxOcc 1<br/> content complex</p>                               |
| children   | <p><a href="#">TotalAdministrativeUnits</a> <a href="#">CompaniesInCountry</a></p>            |
| annotation | <p>documentation<br/> Assets for third parties which are not part of the affiliated group</p> |

element

**AssetManagementClosedDataType/ThirdPartyFunds/PortfoliomangementForThirdParty/OutsideAffiliatedGroup/TotalAdministrativeUnits**

|            |   |
|------------|---|
| diagram    |   |
| type       | <p><a href="#">FundStatisticClosedFundType</a></p>  |
| properties | <p>isRef 0<br/> content complex</p>   |
| children   | <p><a href="#">Number</a> <a href="#">AssetsClosedFunds</a> <a href="#">NetSalesClosedFunds</a></p> |
| annotation | <p>documentation<br/> Total figures for the respective administrative units</p>                     |

element

**AssetManagementClosedDataType/ThirdPartyFunds/PortfoliomangementForThirdParty/OutsideAffiliatedGroup/CompaniesInCountry**

|            |   |
|------------|---|
| diagram    |   |
| type       | <a href="#">FundStatisticClosedFundType</a>   |
| properties | isRef 0<br>minOcc 0<br>maxOcc 1<br>content complex  |
| children   | <a href="#">Number</a> <a href="#">AssetsClosedFunds</a> <a href="#">NetSalesClosedFunds</a>                      |
| annotation | documentation<br>Data about the part of the total which is related to the companies within the respective country |

complexType **AssetManagementCompanyAggregatedType**

|            |   |
|------------|---|
| diagram    |   |
| children   | <a href="#">Date</a> <a href="#">Country</a> <a href="#">Currency</a> <a href="#">OpenEndedFunds</a> <a href="#">ClosedEndedFunds</a> <a href="#">DiscretionaryMandates</a> |
| used by    | element <a href="#">AssetMgmtCompanyDynDataType/AssetMgmtCompanyDynDataSet/Statistics</a>   |
| annotation | documentation<br>Company sales and assets   |

element **AssetManagementCompanyAggregatedType/Date**

|            |  |
|------------|--|
| diagram    |   |
| type       | <b>xs:date</b>   |
| properties | isRef 0<br>content simple  |
| annotation | documentation<br>Date for which the information is valid<br>documentation<br>The date to which the following elements are valid. |

element **AssetManagementCompanyAggregatedType/Country**

|            |   |
|------------|---|
| diagram    |    |
| type       | <a href="#">ISOCountryCodeType</a>  |
| properties | isRef 0<br>content simple<br>nillable true  |
| facets     | Kind Value annotation<br>minLength 2<br>maxLength 2   |
| annotation | documentation<br>Country in which the asset management company is located<br>documentation<br>Die Landeskennzahl einer Adresse, dargestellt als ISO-Landescode. |

element **AssetManagementCompanyAggregatedType/Currency**

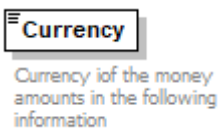
|            |   |
|------------|---|
| diagram    |    |
| type       | <a href="#">ISOCurrencyCodeType</a>   |
| properties | isRef 0<br>content simple   |
| facets     | Kind Value annotation<br>minLength 3<br>maxLength 3<br>pattern [A-Z]{3}   |
| annotation | documentation<br>Currency of the money amounts in the following information<br>documentation<br>Waehrung der Preisinformationen |



element **AssetManagementCompanyAggregatedType/OpenEndedFunds**

|            |  |
|------------|--|
| diagram    |  |
| properties | isRef 0<br>minOcc 0<br>maxOcc 1<br>content complex             |
| children   | <a href="#">RetailFunds</a> <a href="#">InstitutionalFunds</a> |
| annotation | documentation<br>Open-ended funds                              |

element **AssetManagementCompanyAggregatedType/OpenEndedFunds/RetailFunds**

|            |  |
|------------|--|
| diagram    |  |
| properties | isRef 0<br>minOcc 0<br>maxOcc 1<br>content complex                     |
| children   | <a href="#">Securities_Holdings</a> <a href="#">RealAssets</a>         |
| annotation | documentation<br>Funds which are retail funds from a legal perspective |

element **AssetManagementCompanyAggregatedType/OpenEndedFunds/RetailFunds/Securities\_Holdings**

|            |  |
|------------|--|
| diagram    |  |
| type       | <a href="#">AssetManagementCompanyDataType</a>           |
| properties | isRef 0<br>minOcc 0<br>maxOcc 1<br>content complex       |
| children   | <a href="#">OwnFunds</a> <a href="#">ThirdPartyFunds</a> |
| annotation | documentation<br>Securities and Holdings                 |

element **AssetManagementCompanyAggregatedType/OpenEndedFunds/RetailFunds/RealAssets**

|            |  |
|------------|--|
| diagram    |  |
| type       | <a href="#">AssetManagementCompanyDataType</a>           |
| properties | isRef 0<br>minOcc 0<br>maxOcc 1<br>content complex       |
| children   | <a href="#">OwnFunds</a> <a href="#">ThirdPartyFunds</a> |

element **AssetManagementCompanyAggregatedType/OpenEndedFunds/InstitutionalFunds**

|            |  |
|------------|--|
| diagram    |  |
| properties | isRef 0<br>minOcc 0<br>maxOcc 1<br>content complex   |
| children   | <a href="#">Securities_Holdings</a> <a href="#">RealAssets</a>                             |
| annotation | documentation<br>Funds which are from a legal perspective only for institutional investors |

element **AssetManagementCompanyAggregatedType/OpenEndedFunds/InstitutionalFunds/Securities\_Holdings**

|            |  |
|------------|--|
| diagram    |  |
| type       | <a href="#">AssetManagementCompanyDataType</a>           |
| properties | isRef 0<br>minOcc 0<br>maxOcc 1<br>content complex       |
| children   | <a href="#">OwnFunds</a> <a href="#">ThirdPartyFunds</a> |
| annotation | documentation<br>Securities and Holdings                 |

element **AssetManagementCompanyAggregatedType/OpenEndedFunds/InstitutionalFunds/RealAssets**

|            |   |
|------------|---|
| diagram    | <p>The diagram shows a dashed box labeled 'RealAssets' connected to a central octagonal connector. This connector is linked to a larger dashed box labeled 'AssetManagementCompanyDataType'. Inside this larger box, there are two sub-elements: 'OwnFunds' and 'ThirdPartyFunds', both indicated by dashed boxes and a plus sign icon.</p> |
| type       | <a href="#">AssetManagementCompanyDataType</a>  |
| properties | isRef 0<br>minOcc 0<br>maxOcc 1<br>content complex  |
| children   | <a href="#">OwnFunds</a> <a href="#">ThirdPartyFunds</a>  |

element **AssetManagementCompanyAggregatedType/ClosedEndedFunds**

|            |   |
|------------|---|
| diagram    | <p>The diagram shows a dashed box labeled 'ClosedEndedFunds' with the text 'Closed-ended funds' below it. It is connected to a central octagonal connector. This connector is linked to two sub-elements: 'RetailFunds' and 'InstitutionalFunds', both in dashed boxes with plus sign icons. Below 'RetailFunds' is the text 'Funds which are retail funds from a legal perspective'. Below 'InstitutionalFunds' is the text 'Funds which are from a legal perspective only for institutional investors'.</p> |
| properties | isRef 0<br>minOcc 0<br>maxOcc 1<br>content complex  |
| children   | <a href="#">RetailFunds</a> <a href="#">InstitutionalFunds</a>  |
| annotation | documentation<br>Closed-ended funds   |

element **AssetManagementCompanyAggregatedType/ClosedEndedFunds/RetailFunds**

|            |   |
|------------|---|
| diagram    | <p>The diagram shows a dashed box labeled 'RetailFunds' with the text 'Funds which are retail funds from a legal perspective' below it. It is connected to a central octagonal connector. This connector is linked to two sub-elements: 'Securities_Holdings' and 'RealAssets', both in dashed boxes with plus sign icons. Below 'Securities_Holdings' is the text 'Securities and Holdings'.</p> |
| properties | isRef 0<br>minOcc 0<br>maxOcc 1<br>content complex  |
| children   | <a href="#">Securities_Holdings</a> <a href="#">RealAssets</a>  |
| annotation | documentation<br>Funds which are retail funds from a legal perspective  |

element

**AssetManagementCompanyAggregatedType/ClosedEndedFunds/RetailFunds/Securities\_Holdings**

|            |   |
|------------|---|
| diagram    | <p>The diagram illustrates the structure of the <b>AssetManagementClosedDataType</b>. It features a central container labeled <b>AssetManagementClosedDataType</b> with a dashed border. To the left, a dashed box labeled <b>Securities_Holdings</b> (with the note "Securities and Holdings" below it) is connected to the central container. Inside the central container, there are two sub-elements: <b>OwnFunds</b> and <b>ThirdPartyFunds</b>, both shown in dashed boxes with a plus sign icon.</p> |
| type       | <a href="#">AssetManagementClosedDataType</a>   |
| properties | isRef 0<br>minOcc 0<br>maxOcc 1<br>content complex  |
| children   | <a href="#">OwnFunds</a> <a href="#">ThirdPartyFunds</a>  |
| annotation | documentation<br>Securities and Holdings  |

element **AssetManagementCompanyAggregatedType/ClosedEndedFunds/RetailFunds/RealAssets**

|            |   |
|------------|---|
| diagram    | <p>The diagram illustrates the structure of the <b>AssetManagementClosedDataType</b>. It features a central container labeled <b>AssetManagementClosedDataType</b> with a dashed border. To the left, a dashed box labeled <b>RealAssets</b> is connected to the central container. Inside the central container, there are two sub-elements: <b>OwnFunds</b> and <b>ThirdPartyFunds</b>, both shown in dashed boxes with a plus sign icon.</p> |
| type       | <a href="#">AssetManagementClosedDataType</a>   |
| properties | isRef 0<br>minOcc 0<br>maxOcc 1<br>content complex  |
| children   | <a href="#">OwnFunds</a> <a href="#">ThirdPartyFunds</a>  |

element **AssetManagementCompanyAggregatedType/ClosedEndedFunds/InstitutionalFunds**

|            |  |
|------------|--|
| diagram    | <p>The diagram illustrates the structure of the <b>AssetManagementClosedDataType</b>. It features a central container labeled <b>AssetManagementClosedDataType</b> with a dashed border. To the left, a dashed box labeled <b>InstitutionalFunds</b> (with the note "Funds which are from a legal perspective only for institutional investors" below it) is connected to the central container. Inside the central container, there are two sub-elements: <b>Securities_Holdings</b> and <b>RealAssets</b>, both shown in dashed boxes with a plus sign icon.</p> |
| properties | isRef 0<br>minOcc 0<br>maxOcc 1<br>content complex   |
| children   | <a href="#">Securities_Holdings</a> <a href="#">RealAssets</a>   |
| annotation | documentation<br>Funds which are from a legal perspective only for institutional investors   |

element

**AssetManagementCompanyAggregatedType/ClosedEndedFunds/InstitutionalFunds/Securities\_Holdin**

gs

|            |  |
|------------|--|
| diagram    |  |
| type       | <a href="#">AssetManagementClosedDataType</a>            |
| properties | isRef 0<br>minOcc 0<br>maxOcc 1<br>content complex       |
| children   | <a href="#">OwnFunds</a> <a href="#">ThirdPartyFunds</a> |

element

**AssetManagementCompanyAggregatedType/ClosedEndedFunds/InstitutionalFunds/RealAssets**

|            |  |
|------------|--|
| diagram    |  |
| type       | <a href="#">AssetManagementClosedDataType</a>            |
| properties | isRef 0<br>minOcc 0<br>maxOcc 1<br>content complex       |
| children   | <a href="#">OwnFunds</a> <a href="#">ThirdPartyFunds</a> |

element **AssetManagementCompanyAggregatedType/DiscretionaryMandates**

|            |  |
|------------|--|
| diagram    |  |
| properties | isRef 0<br>minOcc 0<br>maxOcc 1<br>content complex                             |
| children   | <a href="#">Securities</a> <a href="#">Holdings</a> <a href="#">RealAssets</a> |
| annotation | documentation<br>Discretionary Mandates  |

element **AssetManagementCompanyAggregatedType/DiscretionaryMandates/Securities\_Holdings**

|            |  |
|------------|--|
| diagram    | <p>The diagram shows a central element 'Securities_Holdings' (with a note 'Securities and Holdings' below it) connected via a line with three dots to a container. This container holds two sub-elements: 'OwnDiscretionaryMandates' and 'ThirdPartyDiscretionaryMandates'. Both sub-elements have a plus sign icon in a box next to them, indicating they are optional or expandable.</p> |
| properties | <p>isRef 0<br/> minOcc 0<br/> maxOcc 1<br/> content complex</p>  |
| children   | <p><a href="#">OwnDiscretionaryMandates</a> <a href="#">ThirdPartyDiscretionaryMandates</a></p>  |
| annotation | <p>documentation<br/> Securities and Holdings</p>  |

element **AssetManagementCompanyAggregatedType/DiscretionaryMandates/Securities\_Holdings/OwnDiscretionaryMandates**

|            |   |
|------------|---|
| diagram    | <p>The diagram shows a central element 'OwnDiscretionaryMandates' connected via a line with three dots to a container. This container lists several asset classes, each with a plus sign icon in a box next to it: 'Clients', 'PortfoliomanagementByThirdP...' (with a note: 'Information about the structure of the respective investment or asset management company with regard to portfoliomanagement or advise by third parties'), 'Equity', 'Bonds', 'Cash_MoneyMarket', 'PrivateEquity_VentureCapital', 'HedgeFunds', 'StructuredProducts', and 'Other'.</p> |
| properties | <p>isRef 0<br/> minOcc 0<br/> maxOcc 1<br/> content complex</p>   |
| children   | <p><a href="#">Clients</a> <a href="#">PortfoliomanagementByThirdParties</a> <a href="#">Equity</a> <a href="#">Bonds</a> <a href="#">Cash_MoneyMarket</a> <a href="#">PrivateEquity_VentureCapital</a> <a href="#">HedgeFunds</a> <a href="#">StructuredProducts</a> <a href="#">Other</a></p>   |

element

**AssetManagementCompanyAggregatedType/DiscretionaryMandates/Securities\_Holdings/OwnDiscretionaryMandates/Clients**

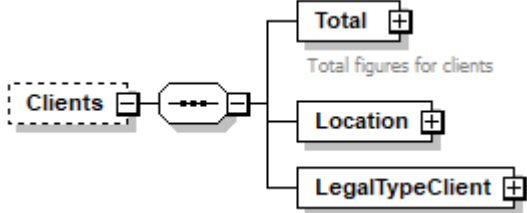
|            |   |
|------------|---|
| diagram    |  |
| properties | isRef 0<br>minOcc 0<br>maxOcc 1<br>content complex                                |
| children   | <a href="#">Total</a> <a href="#">Location</a> <a href="#">LegalTypeClient</a>    |

element

**AssetManagementCompanyAggregatedType/DiscretionaryMandates/Securities\_Holdings/OwnDiscretionaryMandates/Clients/Total**

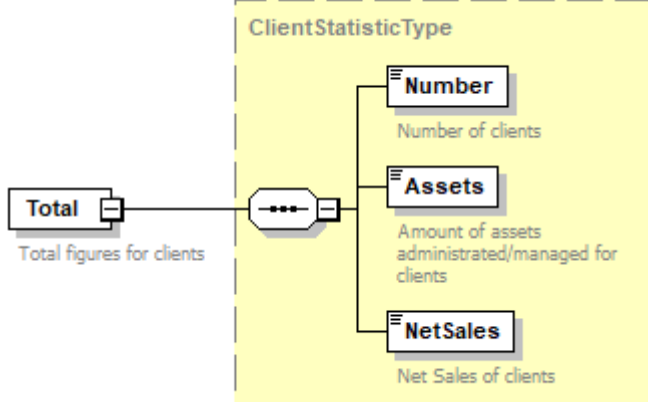
|            |  |
|------------|--|
| diagram    |  |
| type       | <a href="#">ClientStatisticType</a>  |
| properties | isRef 0<br>content complex   |
| children   | <a href="#">Number</a> <a href="#">Assets</a> <a href="#">NetSales</a>             |
| annotation | documentation<br>Total figures for clients   |

element

**AssetManagementCompanyAggregatedType/DiscretionaryMandates/Securities\_Holdings/OwnDiscretionaryMandates/Clients/Location**

|            |   |
|------------|---|
| diagram    | <p>The diagram shows a box labeled 'Location' connected to a central node with three dots. This node branches into two boxes: 'InCountry' and 'OutsideCountry'. Below 'InCountry' is the text 'Information about clients in the respective country'. Below 'OutsideCountry' is the text 'Information about clients outside the respective country'.</p> |
| properties | <p>isRef 0<br/>content complex</p>  |
| children   | <p><a href="#">InCountry</a> <a href="#">OutsideCountry</a></p>   |

element

**AssetManagementCompanyAggregatedType/DiscretionaryMandates/Securities\_Holdings/OwnDiscretionaryMandates/Clients/Location/InCountry**

|            |  |
|------------|--|
| diagram    | <p>The diagram shows a box labeled 'InCountry' connected to a central node with three dots. This node branches into three boxes: 'Number', 'Assets', and 'NetSales'. These three boxes are enclosed in a dashed yellow box labeled 'ClientStatisticType'. Below 'Number' is the text 'Number of clients'. Below 'Assets' is the text 'Amount of assets administrated/managed for clients'. Below 'NetSales' is the text 'Net Sales of clients'. The 'InCountry' box has the text 'Information about clients in the respective country' below it.</p> |
| type       | <p><a href="#">ClientStatisticType</a></p>   |
| properties | <p>isRef 0<br/>content complex</p>   |
| children   | <p><a href="#">Number</a> <a href="#">Assets</a> <a href="#">NetSales</a></p>  |
| annotation | <p>documentation<br/>Information about clients in the respective country</p>   |



element

**AssetManagementCompanyAggregatedType/DiscretionaryMandates/Securities\_Holdings/OwnDiscretionaryMandates/Clients/Location/OutsideCountry**

|            |  |
|------------|--|
| diagram    | <p>The diagram shows a box labeled 'OutsideCountry' with the text 'Information about clients outside the respective country'. A line connects it to a central octagonal connector with three dots. From this connector, three lines branch out to three separate boxes: 'Number' (Number of clients), 'Assets' (Amount of assets administrated/managed for clients), and 'NetSales' (Net Sales of clients). These three boxes are enclosed in a dashed yellow rectangle labeled 'ClientStatisticType'.</p> |
| type       | <a href="#">ClientStatisticType</a>  |
| properties | isRef 0<br>content complex   |
| children   | <a href="#">Number</a> <a href="#">Assets</a> <a href="#">NetSales</a>   |
| annotation | documentation<br>Information about clients outside the respective country  |

element

**AssetManagementCompanyAggregatedType/DiscretionaryMandates/Securities\_Holdings/OwnDiscretionaryMandates/Clients/LegalTypeClient**

|            |  |
|------------|--|
| diagram    | <p>The diagram shows a box labeled 'LegalTypeClient'. A line connects it to a central octagonal connector with three dots. From this connector, two lines branch out to two separate boxes: 'Private' and 'Institutional'. Both boxes have a small '+' symbol in the top right corner.</p> |
| properties | isRef 0<br>content complex   |
| children   | <a href="#">Private</a> <a href="#">Institutional</a>  |

element

**AssetManagementCompanyAggregatedType/DiscretionaryMandates/Securities\_Holdings/OwnDiscretionaryMandates/Clients/LegalTypeClient/Private**

|            |   |
|------------|---|
| diagram    | <p>The diagram shows a class <b>Private</b> connected to a class <b>ClientStatisticType</b>. <b>ClientStatisticType</b> is highlighted in a yellow dashed box and contains three attributes: <b>Number</b> (Number of clients), <b>Assets</b> (Amount of assets administrated/managed for clients), and <b>NetSales</b> (Net Sales of clients). The <b>Private</b> class is connected to <b>ClientStatisticType</b> via a line with a solid square on the <b>Private</b> side and a solid square with a dashed line on the <b>ClientStatisticType</b> side.</p> |
| type       | <a href="#">ClientStatisticType</a>   |
| properties | isRef 0<br>content complex  |
| children   | <a href="#">Number</a> <a href="#">Assets</a> <a href="#">NetSales</a>  |

element

**AssetManagementCompanyAggregatedType/DiscretionaryMandates/Securities\_Holdings/OwnDiscretionaryMandates/Clients/LegalTypeClient/Institutional**

|            |   |
|------------|---|
| diagram    | <p>The diagram shows a class <b>Institutional</b> connected to a class <b>ClientStatisticType</b>. <b>ClientStatisticType</b> is highlighted in a yellow dashed box and contains three attributes: <b>Number</b> (Number of clients), <b>Assets</b> (Amount of assets administrated/managed for clients), and <b>NetSales</b> (Net Sales of clients). The <b>Institutional</b> class is connected to <b>ClientStatisticType</b> via a line with a solid square on the <b>Institutional</b> side and a solid square with a dashed line on the <b>ClientStatisticType</b> side.</p> |
| type       | <a href="#">ClientStatisticType</a>   |
| properties | isRef 0<br>content complex  |
| children   | <a href="#">Number</a> <a href="#">Assets</a> <a href="#">NetSales</a>  |

element

**AssetManagementCompanyAggregatedType/DiscretionaryMandates/Securities\_Holdings/OwnDiscretionaryMandates/PortfoliomanagementByThirdParties**

|                   |   |
|-------------------|---|
| <p>diagram</p>    | <p><b>PortfoliomanagementByThirdP...</b><br/>Information about the structure of the respective investment or asset management company with regard to portfoliomanagement or advise by third parties</p> <p><b>Total</b><br/>Total figures for clients</p> <p><b>WithinAffiliatedGroup</b><br/>Data about the respective administrative units for which the portfoliomanagement or advice is done by a third party which is part of the affiliated company group</p> <p><b>OutsideAffiliatedGroup</b><br/>Data about the respective administrative units for which the portfoliomanagement or advice is done by a third party which is notpart of the affiliated company group</p> |
| <p>properties</p> | <p>isRef 0<br/>minOcc 0<br/>maxOcc 1<br/>content complex</p>  |
| <p>children</p>   | <p><a href="#">Total</a> <a href="#">WithinAffiliatedGroup</a> <a href="#">OutsideAffiliatedGroup</a></p>   |
| <p>annotation</p> | <p>documentation<br/>Information about the structure of the respective investment or asset management company with regard to portfoliomanagement or advise by third parties</p>   |

element

**AssetManagementCompanyAggregatedType/DiscretionaryMandates/Securities\_Holdings/OwnDiscretionaryMandates/PortfoliomanagementByThirdParties/Total**

|                   |  |
|-------------------|--|
| <p>diagram</p>    | <p><b>Total</b><br/>Total figures for clients</p> <p><b>ClientStatisticType</b></p> <p><b>Number</b><br/>Number of clients</p> <p><b>Assets</b><br/>Amount of assets administrated/managed for clients</p> <p><b>NetSales</b><br/>Net Sales of clients</p> |
| <p>type</p>       | <p><a href="#">ClientStatisticType</a></p>   |
| <p>properties</p> | <p>isRef 0<br/>content complex</p>   |
| <p>children</p>   | <p><a href="#">Number</a> <a href="#">Assets</a> <a href="#">NetSales</a></p>  |
| <p>annotation</p> | <p>documentation<br/>Total figures for clients</p>   |

element

**AssetManagementCompanyAggregatedType/DiscretionaryMandates/Securities\_Holdings/OwnDiscretionaryMandates/PortfoliomanagementByThirdParties/WithinAffiliatedGroup**

|                   |  |
|-------------------|--|
| <p>diagram</p>    | <p><b>WithinAffiliatedGroup</b><br/>Data about the respective administrative units for which the portfoliomanagement or advice is done by a third party which is part of the affiliated company group</p> <p><b>Total</b><br/>Total of third parties within the affiliated company group</p> <p><b>CompaniesInCountry</b><br/>Data about the part of the total which is related to the companies within the respective country</p> |
| <p>properties</p> | <p>isRef 0<br/>content complex</p>   |
| <p>children</p>   | <p><a href="#">Total</a> <a href="#">CompaniesInCountry</a></p>  |
| <p>annotation</p> | <p>documentation<br/>Data about the respective administrative units for which the portfoliomanagement or advice is done by a third party which is part of the affiliated company group</p>   |

element

**AssetManagementCompanyAggregatedType/DiscretionaryMandates/Securities\_Holdings/OwnDiscretionaryMandates/PortfoliomanagementByThirdParties/WithinAffiliatedGroup/Total**

|                   |  |
|-------------------|--|
| <p>diagram</p>    | <p><b>Total</b><br/>Total of third parties within the affiliated company group</p> <p><b>ClientStatisticType</b></p> <ul style="list-style-type: none"> <li><b>Number</b><br/>Number of clients</li> <li><b>Assets</b><br/>Amount of assets administrated/managed for clients</li> <li><b>NetSales</b><br/>Net Sales of clients</li> </ul> |
| <p>type</p>       | <p><a href="#">ClientStatisticType</a></p>   |
| <p>properties</p> | <p>isRef 0<br/>content complex</p>   |
| <p>children</p>   | <p><a href="#">Number</a> <a href="#">Assets</a> <a href="#">NetSales</a></p>  |
| <p>annotation</p> | <p>documentation<br/>Total of third parties within the affiliated company group</p>  |

element

**AssetManagementCompanyAggregatedType/DiscretionaryMandates/Securities\_Holdings/OwnDiscretionaryMandates/PortfoliomanagementByThirdParties/WithinAffiliatedGroup/CompaniesInCountry**

|                   |   |
|-------------------|---|
| <p>diagram</p>    |   |
| <p>type</p>       | <p><a href="#">ClientStatisticType</a></p>  |
| <p>properties</p> | <p>isRef 0<br/>content complex</p>  |
| <p>children</p>   | <p><a href="#">Number</a> <a href="#">Assets</a> <a href="#">NetSales</a></p>   |
| <p>annotation</p> | <p>documentation<br/>Data about the part of the total which is related to the companies within the respective country</p> |

element

**AssetManagementCompanyAggregatedType/DiscretionaryMandates/Securities\_Holdings/OwnDiscretionaryMandates/PortfoliomanagementByThirdParties/OutsideAffiliatedGroup**

|                   |   |
|-------------------|---|
| <p>diagram</p>    |   |
| <p>properties</p> | <p>isRef 0<br/>content complex</p>  |
| <p>children</p>   | <p><a href="#">Total</a> <a href="#">CompaniesInCountry</a></p>   |
| <p>annotation</p> | <p>documentation<br/>Data about the respective administrative units for which the portfoliomanagement or advice is done by a third party which is notpart of the affiliated company group</p> |

element

**AssetManagementCompanyAggregatedType/DiscretionaryMandates/Securities\_Holdings/OwnDiscretionaryMandates/PortfoliomanagementByThirdParties/OutsideAffiliatedGroup/Total**

|            |   |
|------------|---|
| diagram    | <p>The diagram shows a 'Total' element on the left, connected to a 'ClientStatisticType' container on the right. The 'ClientStatisticType' container is highlighted with a yellow dashed border and contains three sub-elements: 'Number' (Number of clients), 'Assets' (Amount of assets administrated/managed for clients), and 'NetSales' (Net Sales of clients). The 'Total' element is described as 'Total of third parties without the affiliated company group'.</p> |
| type       | <a href="#">ClientStatisticType</a>   |
| properties | isRef 0<br>content complex  |
| children   | <a href="#">Number</a> <a href="#">Assets</a> <a href="#">NetSales</a>  |
| annotation | documentation<br>Total of third parties without the affiliated company group  |

element

**AssetManagementCompanyAggregatedType/DiscretionaryMandates/Securities\_Holdings/OwnDiscretionaryMandates/PortfoliomanagementByThirdParties/OutsideAffiliatedGroup/CompaniesInCountry**

|            |  |
|------------|--|
| diagram    | <p>The diagram shows a 'CompaniesInCountry' element on the left, connected to a 'ClientStatisticType' container on the right. The 'ClientStatisticType' container is highlighted with a yellow dashed border and contains three sub-elements: 'Number' (Number of clients), 'Assets' (Amount of assets administrated/managed for clients), and 'NetSales' (Net Sales of clients). The 'CompaniesInCountry' element is described as 'Data about the part of the total which is related to the companies within the respective country'.</p> |
| type       | <a href="#">ClientStatisticType</a>  |
| properties | isRef 0<br>content complex   |
| children   | <a href="#">Number</a> <a href="#">Assets</a> <a href="#">NetSales</a>   |
| annotation | documentation<br>Data about the part of the total which is related to the companies within the respective country  |

element

**AssetManagementCompanyAggregatedType/DiscretionaryMandates/Securities\_Holdings/OwnDiscretionaryMandates/Equity**

|            |  |
|------------|--|
| diagram    | <pre>classDiagram     class Equity     class TotalAmount     class AmountDomestic     Equity &lt; -- TotalAmount     Equity &lt; -- AmountDomestic     class Equity {         ..     }     class TotalAmount {         ..     }     class AmountDomestic {         ..     }     class Equity {         ..     }     class TotalAmount {         ..     }     class AmountDomestic {         ..     }</pre> |
| properties | isRef 0<br>minOcc 0<br>maxOcc 1<br>content complex   |
| children   | <a href="#">TotalAmount</a> <a href="#">AmountDomestic</a>   |
| annotation | documentation  |

element

**AssetManagementCompanyAggregatedType/DiscretionaryMandates/Securities\_Holdings/OwnDiscretionaryMandates/Equity/TotalAmount**

|            |  |
|------------|--|
| diagram    | <pre>classDiagram     class TotalAmount     class TotalAmount {         ..     }</pre> |
| type       | <b>xs:decimal</b>  |
| properties | isRef 0<br>content simple  |
| annotation | documentation<br>In Euro   |

element

**AssetManagementCompanyAggregatedType/DiscretionaryMandates/Securities\_Holdings/OwnDiscretionaryMandates/Equity/AmountDomestic**

|            |  |
|------------|--|
| diagram    | <pre>classDiagram     class AmountDomestic     class AmountDomestic {         ..     }</pre> |
| type       | <b>xs:decimal</b>  |
| properties | isRef 0<br>content simple  |
| annotation | documentation<br>In Euro Equity of domestic companies  |

|  |  |
|--|--|
|  |  |
|--|--|

element

**AssetManagementCompanyAggregatedType/DiscretionaryMandates/Securities\_Holdings/OwnDiscretionaryMandates/Bonds**

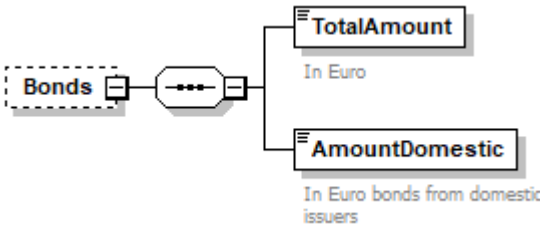
|            |   |
|------------|---|
| diagram    |  |
| properties | isRef 0<br>minOcc 0<br>maxOcc 1<br>content complex                                |
| children   | <a href="#">TotalAmount</a> <a href="#">AmountDomestic</a>                        |
| annotation | documentation   |

element

**AssetManagementCompanyAggregatedType/DiscretionaryMandates/Securities\_Holdings/OwnDiscretionaryMandates/Bonds/TotalAmount**

|            |   |
|------------|---|
| diagram    |  |
| type       | <b>xs:decimal</b>   |
| properties | isRef 0<br>content simple   |
| annotation | documentation<br>In Euro  |

element

**AssetManagementCompanyAggregatedType/DiscretionaryMandates/Securities\_Holdings/OwnDiscretionaryMandates/Bonds/AmountDomestic**

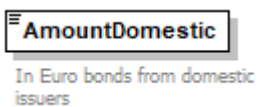
|            |   |
|------------|---|
| diagram    |  |
| type       | <b>xs:decimal</b>   |
| properties | isRef 0<br>content simple   |
| annotation | documentation<br>In Euro bonds from domestic issuers                                |



element

**AssetManagementCompanyAggregatedType/DiscretionaryMandates/Securities\_Holdings/OwnDiscretionaryMandates/Cash\_MoneyMarket**

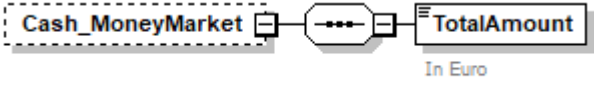
|            |   |
|------------|---|
| diagram    |  |
| properties | isRef 0<br>minOcc 0<br>maxOcc 1<br>content complex                                |
| children   | <a href="#">TotalAmount</a>   |
| annotation | documentation   |

element

**AssetManagementCompanyAggregatedType/DiscretionaryMandates/Securities\_Holdings/OwnDiscretionaryMandates/Cash\_MoneyMarket/TotalAmount**

|            |   |
|------------|---|
| diagram    |  |
| type       | <b>xs:decimal</b>   |
| properties | isRef 0<br>content simple   |
| annotation | documentation<br>In Euro  |

element

**AssetManagementCompanyAggregatedType/DiscretionaryMandates/Securities\_Holdings/OwnDiscretionaryMandates/PrivateEquity\_VentureCapital**

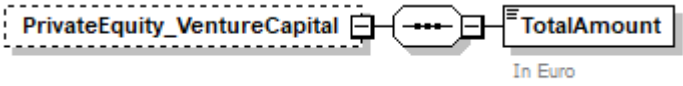
|            |   |
|------------|---|
| diagram    |  |
| properties | isRef 0<br>minOcc 0<br>maxOcc 1<br>content complex                                  |
| children   | <a href="#">TotalAmount</a>   |

element

**AssetManagementCompanyAggregatedType/DiscretionaryMandates/Securities\_Holdings/OwnDiscretionaryMandates/PrivateEquity\_VentureCapital/TotalAmount**

|            |   |
|------------|---|
| diagram    |  <p>The diagram shows a rectangular box labeled 'TotalAmount' with a small icon to its left. Below the box, the text 'In Euro' is displayed.</p> |
| type       | <b>xs:decimal</b>   |
| properties | isRef 0<br>content simple   |
| annotation | documentation<br>In Euro  |

element

**AssetManagementCompanyAggregatedType/DiscretionaryMandates/Securities\_Holdings/OwnDiscretionaryMandates/HedgeFunds**

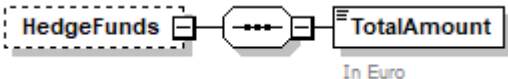
|            |  |
|------------|--|
| diagram    |  <p>The diagram shows a dashed rectangular box labeled 'HedgeFunds' connected by a line to a hexagonal box containing three dots, which is then connected to a rectangular box labeled 'TotalAmount'. Below the 'TotalAmount' box, the text 'In Euro' is displayed.</p> |
| properties | isRef 0<br>minOcc 0<br>maxOcc 1<br>content complex   |
| children   | <a href="#">TotalAmount</a>  |
| annotation | documentation  |

element

**AssetManagementCompanyAggregatedType/DiscretionaryMandates/Securities\_Holdings/OwnDiscretionaryMandates/HedgeFunds/TotalAmount**

|            |   |
|------------|---|
| diagram    |  <p>The diagram shows a rectangular box labeled 'TotalAmount' with a small icon to its left. Below the box, the text 'In Euro' is displayed.</p> |
| type       | <b>xs:decimal</b>   |
| properties | isRef 0<br>content simple   |
| annotation | documentation<br>In Euro  |

element

**AssetManagementCompanyAggregatedType/DiscretionaryMandates/Securities\_Holdings/OwnDiscretionaryMandates/StructuredProducts**

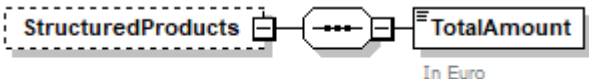
|         |  |
|---------|--|
| diagram |  <p>The diagram shows a dashed rectangular box labeled 'StructuredProducts' connected by a line to a hexagonal box containing three dots, which is then connected to a rectangular box labeled 'TotalAmount'. Below the 'TotalAmount' box, the text 'In Euro' is displayed.</p> |
|---------|--|

|            |  |
|------------|--|
| properties | isRef 0<br>minOcc 0<br>maxOcc 1<br>content complex |
| children   | <a href="#">TotalAmount</a>                        |
| annotation | documentation                                      |

element

**AssetManagementCompanyAggregatedType/DiscretionaryMandates/Securities\_Holdings/OwnDiscretionaryMandates/StructuredProducts/TotalAmount**

|            |   |
|------------|---|
| diagram    |  |
| type       | <b>xs:decimal</b>   |
| properties | isRef 0<br>content simple   |
| annotation | documentation<br>In Euro  |

element

**AssetManagementCompanyAggregatedType/DiscretionaryMandates/Securities\_Holdings/OwnDiscretionaryMandates/Other**

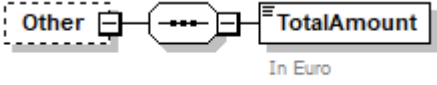
|            |   |
|------------|---|
| diagram    |  |
| properties | isRef 0<br>minOcc 0<br>maxOcc 1<br>content complex                                  |
| children   | <a href="#">TotalAmount</a>   |
| annotation | documentation   |

element

**AssetManagementCompanyAggregatedType/DiscretionaryMandates/Securities\_Holdings/OwnDiscretionaryMandates/Other/TotalAmount**

|            |   |
|------------|---|
| diagram    |  |
| type       | <b>xs:decimal</b>   |
| properties | isRef 0<br>content simple   |
| annotation | documentation<br>In Euro  |

|  |  |
|--|--|
|  |  |
|--|--|

element

**AssetManagementCompanyAggregatedType/DiscretionaryMandates/Securities\_Holdings/ThirdPartyDiscretionaryMandates**

|            |  |
|------------|--|
| diagram    |  |
| properties | isRef 0<br>minOcc 0<br>maxOcc 1<br>content complex |
| children   | <a href="#">PortfoliomanagementForThirdParties</a> |

element

**AssetManagementCompanyAggregatedType/DiscretionaryMandates/Securities\_Holdings/ThirdPartyDiscretionaryMandates/PortfoliomanagementForThirdParties**

|            |  |
|------------|--|
| diagram    |  |
| properties | isRef 0<br>content complex   |
| children   | <a href="#">Total</a> <a href="#">WithinAffiliatedGroup</a> <a href="#">OutsideAffiliatedGroup</a>           |
| annotation | documentation<br>Information about the structure of the portfolio Management or the advise for third parties |

element

**AssetManagementCompanyAggregatedType/DiscretionaryMandates/Securities\_Holdings/ThirdPartyDiscretionaryMandates/PortfoliomanagementForThirdParties/Total**

|            |  |
|------------|--|
| diagram    |  |
| type       | <a href="#">ClientStatisticType</a>                                    |
| properties | isRef 0<br>content complex   |
| children   | <a href="#">Number</a> <a href="#">Assets</a> <a href="#">NetSales</a> |
| annotation | documentation<br>Total figures   |

element

**AssetManagementCompanyAggregatedType/DiscretionaryMandates/Securities\_Holdings/ThirdPartyDiscretionaryMandates/PortfoliomanagementForThirdParties/WithinAffiliatedGroup**

|            |  |
|------------|--|
| diagram    |  |
| properties | isRef 0<br>content complex   |
| children   | <a href="#">Total</a> <a href="#">CompaniesInCountry</a>   |
| annotation | documentation<br>Data about the respective administrative units for which the portfoliomanagement or advice is done by a third party which is part of the affiliated company group |

element

**AssetManagementCompanyAggregatedType/DiscretionaryMandates/Securities\_Holdings/ThirdPartyDiscretionaryMandates/PortfoliomanagementForThirdParties/WithinAffiliatedGroup/Total**

|            |  |
|------------|--|
| diagram    | <p>The diagram illustrates the structure of the <b>ClientStatisticType</b> element. It is a complex type (indicated by a dashed box) that contains three child elements: <b>Number</b> (Number of clients), <b>Assets</b> (Amount of assets administrated/managed for clients), and <b>NetSales</b> (Net Sales of clients). This entire structure is contained within a larger container labeled <b>Total</b> (Total figures).</p> |
| type       | <a href="#">ClientStatisticType</a>  |
| properties | isRef 0<br>content complex   |
| children   | <a href="#">Number</a> <a href="#">Assets</a> <a href="#">NetSales</a>   |
| annotation | documentation<br>Total figures   |

element

**AssetManagementCompanyAggregatedType/DiscretionaryMandates/Securities\_Holdings/ThirdPartyDiscretionaryMandates/PortfoliomanagementForThirdParties/WithinAffiliatedGroup/CompaniesInCountry**

|            |  |
|------------|--|
| diagram    | <p>The diagram illustrates the structure of the <b>ClientStatisticType</b> element. It is a complex type (indicated by a dashed box) that contains three child elements: <b>Number</b> (Number of clients), <b>Assets</b> (Amount of assets administrated/managed for clients), and <b>NetSales</b> (Net Sales of clients). This entire structure is contained within a larger container labeled <b>CompaniesInCountry</b> (Data about the part of the total which is related to the companies within the respective country).</p> |
| type       | <a href="#">ClientStatisticType</a>  |
| properties | isRef 0<br>content complex   |
| children   | <a href="#">Number</a> <a href="#">Assets</a> <a href="#">NetSales</a>   |
| annotation | documentation<br>Data about the part of the total which is related to the companies within the respective country  |

element

**AssetManagementCompanyAggregatedType/DiscretionaryMandates/Securities\_Holdings/ThirdPartyDiscretionaryMandates/PortfoliomanagementForThirdParties/OutsideAffiliatedGroup**

|            |  |
|------------|--|
| diagram    | <p>Data about the respective administrative units for which the portfoliomanagement or advice is done by a third party which is not part of the affiliated company group</p>           |
| properties | isRef 0<br>content complex   |
| children   | <a href="#">Total</a> <a href="#">CompaniesInCountry</a>   |
| annotation | documentation<br>Data about the respective administrative units for which the portfoliomanagement or advice is done by a third party which is not part of the affiliated company group |

element

**AssetManagementCompanyAggregatedType/DiscretionaryMandates/Securities\_Holdings/ThirdPartyDiscretionaryMandates/PortfoliomanagementForThirdParties/OutsideAffiliatedGroup/Total**

|            |  |
|------------|--|
| diagram    |  |
| type       | <a href="#">ClientStatisticType</a>                                    |
| properties | isRef 0<br>content complex   |
| children   | <a href="#">Number</a> <a href="#">Assets</a> <a href="#">NetSales</a> |
| annotation | documentation<br>Total figures   |

element

**AssetManagementCompanyAggregatedType/DiscretionaryMandates/Securities\_Holdings/ThirdPartyDiscretionaryMandates/PortfoliomanagementForThirdParties/OutsideAffiliatedGroup/CompaniesInCountry**

|            |   |
|------------|---|
| diagram    |   |
| type       | <a href="#">ClientStatisticType</a>   |
| properties | isRef 0<br>content complex  |
| children   | <a href="#">Number</a> <a href="#">Assets</a> <a href="#">NetSales</a>  |
| annotation | documentation<br>Data about the part of the total which is related to the companies within the respective country |

element **AssetManagementCompanyAggregatedType/DiscretionaryMandates/RealAssets**

|            |  |
|------------|--|
| diagram    |  |
| properties | isRef 0<br>minOcc 0<br>maxOcc 1<br>content complex                                       |
| children   | <a href="#">OwnDiscretionaryMandates</a> <a href="#">ThirdPartyDiscretionaryMandates</a> |

element

**AssetManagementCompanyAggregatedType/DiscretionaryMandates/RealAssets/OwnDiscretionaryMandates**

|            |                     |
|------------|---------------------|
| diagram    |                     |
| properties | isRef 0<br>minOcc 0 |



|          |  |
|----------|--|
|          | maxOcc 1<br>content complex  |
| children | <a href="#">Clients</a> <a href="#">PortfoliomanagementByThirdParties</a> <a href="#">Property</a> |

element

**AssetManagementCompanyAggregatedType/DiscretionaryMandates/RealAssets/OwnDiscretionaryMandates/Clients**

|            |  |
|------------|--|
| diagram    |  |
| properties | isRef 0<br>minOcc 0<br>maxOcc 1<br>content complex                             |
| children   | <a href="#">Total</a> <a href="#">Location</a> <a href="#">LegalTypeClient</a> |

element

**AssetManagementCompanyAggregatedType/DiscretionaryMandates/RealAssets/OwnDiscretionaryMandates/Clients/Total**

|            |  |
|------------|--|
| diagram    |  |
| type       | <a href="#">ClientStatisticType</a>                                    |
| properties | isRef 0<br>content complex   |
| children   | <a href="#">Number</a> <a href="#">Assets</a> <a href="#">NetSales</a> |

element

**AssetManagementCompanyAggregatedType/DiscretionaryMandates/RealAssets/OwnDiscretionaryMandates/Clients/Location**

|         |  |
|---------|--|
| diagram |  |
|---------|--|

|            |  |
|------------|--|
| properties | isRef 0<br>content complex                               |
| children   | <a href="#">InCountry</a> <a href="#">OutsideCountry</a> |

element

**AssetManagementCompanyAggregatedType/DiscretionaryMandates/RealAssets/OwnDiscretionaryMandates/Clients/Location/InCountry**

|            |  |
|------------|--|
| diagram    | <p>The diagram illustrates the structure of the <b>InCountry</b> element. It is connected to a <b>ClientStatisticType</b> container (indicated by a dashed yellow box). Inside this container, there are three sub-elements: <b>Number</b> (representing the number of clients), <b>Assets</b> (representing the amount of assets administrated/managed for clients), and <b>NetSales</b> (representing the net sales of clients). The <b>InCountry</b> element is shown as a box with a connector to a central node, which then branches out to the three sub-elements.</p> |
| type       | <a href="#">ClientStatisticType</a>  |
| properties | isRef 0<br>content complex   |
| children   | <a href="#">Number</a> <a href="#">Assets</a> <a href="#">NetSales</a>   |

element

**AssetManagementCompanyAggregatedType/DiscretionaryMandates/RealAssets/OwnDiscretionaryMandates/Clients/Location/OutsideCountry**

|            |  |
|------------|--|
| diagram    | <p>The diagram illustrates the structure of the <b>OutsideCountry</b> element. It is connected to a <b>ClientStatisticType</b> container (indicated by a dashed yellow box). Inside this container, there are three sub-elements: <b>Number</b> (representing the number of clients), <b>Assets</b> (representing the amount of assets administrated/managed for clients), and <b>NetSales</b> (representing the net sales of clients). The <b>OutsideCountry</b> element is shown as a box with a connector to a central node, which then branches out to the three sub-elements.</p> |
| type       | <a href="#">ClientStatisticType</a>  |
| properties | isRef 0<br>content complex   |
| children   | <a href="#">Number</a> <a href="#">Assets</a> <a href="#">NetSales</a>   |

element

**AssetManagementCompanyAggregatedType/DiscretionaryMandates/RealAssets/OwnDiscretionaryMandates/Clients/LegalTypeClient**

|            |   |
|------------|---|
| diagram    |   |
| properties | isRef 0<br>content complex                            |
| children   | <a href="#">Private</a> <a href="#">Institutional</a> |

element

**AssetManagementCompanyAggregatedType/DiscretionaryMandates/RealAssets/OwnDiscretionaryMandates/Clients/LegalTypeClient/Private**

|            |  |
|------------|--|
| diagram    |  |
| type       | <a href="#">ClientStatisticType</a>                                    |
| properties | isRef 0<br>content complex   |
| children   | <a href="#">Number</a> <a href="#">Assets</a> <a href="#">NetSales</a> |

element

**AssetManagementCompanyAggregatedType/DiscretionaryMandates/RealAssets/OwnDiscretionaryMandates/Clients/LegalTypeClient/Institutional**

|         |  |
|---------|--|
| diagram |  |
|---------|--|

|            |  |
|------------|--|
| type       | <a href="#">ClientStatisticType</a>                                    |
| properties | isRef 0<br>content complex   |
| children   | <a href="#">Number</a> <a href="#">Assets</a> <a href="#">NetSales</a> |

element

**AssetManagementCompanyAggregatedType/DiscretionaryMandates/RealAssets/OwnDiscretionaryMandates/PortfoliomanagementByThirdParties**

|            |   |
|------------|---|
| diagram    | <p>Information about the structure of the respective investment or asset management company with regard to portfoliomanagement or advise by third parties</p>           |
| properties | isRef 0<br>minOcc 0<br>maxOcc 1<br>content complex  |
| children   | <a href="#">Total</a> <a href="#">WithinAffiliatedGroup</a> <a href="#">OutsideAffiliatedGroup</a>  |
| annotation | documentation<br>Information about the structure of the respective investment or asset management company with regard to portfoliomanagement or advise by third parties |

element

**AssetManagementCompanyAggregatedType/DiscretionaryMandates/RealAssets/OwnDiscretionaryMandates/PortfoliomanagementByThirdParties/Total**

|            |  |
|------------|--|
| diagram    |  |
| type       | extension of <a href="#">ClientStatisticType</a>                       |
| properties | isRef 0<br>content complex   |
| children   | <a href="#">Number</a> <a href="#">Assets</a> <a href="#">NetSales</a> |
| annotation | documentation<br>insgesamt   |

element

**AssetManagementCompanyAggregatedType/DiscretionaryMandates/RealAssets/OwnDiscretionaryMandates/PortfoliomanagementByThirdParties/WithinAffiliatedGroup**

|            |  |
|------------|--|
| diagram    |  |
| properties | isRef 0<br>content complex                                   |
| children   | <a href="#">Total</a> <a href="#">CompaniesInCountry</a>     |
| annotation | documentation<br>durch Dritte innerhalb des Konzernverbundes |

element

**AssetManagementCompanyAggregatedType/DiscretionaryMandates/RealAssets/OwnDiscretionaryMandates/PortfoliomanagementByThirdParties/WithinAffiliatedGroup/Total**

|            |  |
|------------|--|
| diagram    |  |
| type       | <a href="#">ClientStatisticType</a>                                    |
| properties | isRef 0<br>content complex   |
| children   | <a href="#">Number</a> <a href="#">Assets</a> <a href="#">NetSales</a> |
| annotation | documentation<br>durch Dritte innerhalb des Konzernverbundes gesamt    |

element

**AssetManagementCompanyAggregatedType/DiscretionaryMandates/RealAssets/OwnDiscretionaryMandates/PortfoliomanagementByThirdParties/WithinAffiliatedGroup/CompaniesInCountry**

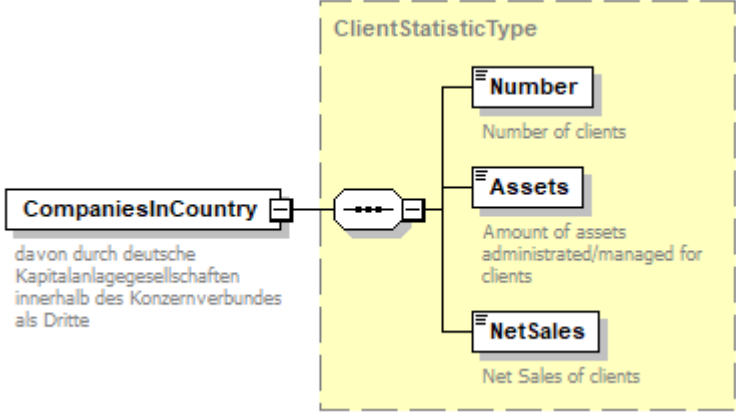
|                   |   |
|-------------------|---|
| <p>diagram</p>    |                                   |
| <p>type</p>       | <p><a href="#">ClientStatisticType</a></p>  |
| <p>properties</p> | <p>isRef 0<br/>content complex</p>  |
| <p>children</p>   | <p><a href="#">Number</a> <a href="#">Assets</a> <a href="#">NetSales</a></p>                                       |
| <p>annotation</p> | <p>documentation<br/>davon durch deutsche Kapitalanlagegesellschaften innerhalb des Konzernverbundes als Dritte</p> |

element

**AssetManagementCompanyAggregatedType/DiscretionaryMandates/RealAssets/OwnDiscretionaryMandates/PortfoliomanagementByThirdParties/OutsideAffiliatedGroup**

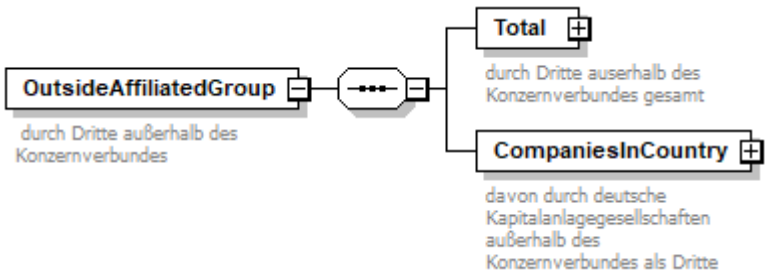
|                   |  |
|-------------------|--|
| <p>diagram</p>    |  |
| <p>properties</p> | <p>isRef 0<br/>content complex</p>   |
| <p>children</p>   | <p><a href="#">Total</a> <a href="#">CompaniesInCountry</a></p>                      |
| <p>annotation</p> | <p>documentation<br/>durch Dritte außerhalb des Konzernverbundes</p>                 |

element

**AssetManagementCompanyAggregatedType/DiscretionaryMandates/RealAssets/OwnDiscretionaryMandates/PortfoliomanagementByThirdParties/OutsideAffiliatedGroup/Total**

|            |   |
|------------|---|
| diagram    | <p>The diagram shows a class <b>ClientStatisticType</b> (highlighted in a yellow dashed box) with three children: <b>Number</b> (Number of clients), <b>Assets</b> (Amount of assets administrated/managed for clients), and <b>NetSales</b> (Net Sales of clients). A <b>Total</b> element is connected to the <b>ClientStatisticType</b> via a line with a small square at the end. The <b>Total</b> element has the text "durch Dritte ausserhalb des Konzernverbundes gesamt" below it.</p> |
| type       | <a href="#">ClientStatisticType</a>   |
| properties | isRef 0<br>content complex  |
| children   | <a href="#">Number</a> <a href="#">Assets</a> <a href="#">NetSales</a>  |
| annotation | documentation<br>durch Dritte ausserhalb des Konzernverbundes gesamt  |

element

**AssetManagementCompanyAggregatedType/DiscretionaryMandates/RealAssets/OwnDiscretionaryMandates/PortfoliomanagementByThirdParties/OutsideAffiliatedGroup/CompaniesInCountry**

|            |  |
|------------|--|
| diagram    | <p>The diagram shows a class <b>ClientStatisticType</b> (highlighted in a yellow dashed box) with three children: <b>Number</b> (Number of clients), <b>Assets</b> (Amount of assets administrated/managed for clients), and <b>NetSales</b> (Net Sales of clients). A <b>CompaniesInCountry</b> element is connected to the <b>ClientStatisticType</b> via a line with a small square at the end. The <b>CompaniesInCountry</b> element has the text "davon durch deutsche Kapitalanlagegesellschaften auferhalb des Konzernverbundes als Dritte" below it.</p> |
| type       | <a href="#">ClientStatisticType</a>  |
| properties | isRef 0<br>content complex   |
| children   | <a href="#">Number</a> <a href="#">Assets</a> <a href="#">NetSales</a>   |
| annotation | documentation<br>davon durch deutsche Kapitalanlagegesellschaften auferhalb des Konzernverbundes als Dritte  |

element

**AssetManagementCompanyAggregatedType/DiscretionaryMandates/RealAssets/OwnDiscretionaryMandates/Property**

|            |  |
|------------|--|
| diagram    |  |
| properties | isRef 0<br>minOcc 0<br>maxOcc 1<br>content complex |
| children   | <a href="#">TotalAmount</a>                        |
| annotation | documentation                                      |

element

**AssetManagementCompanyAggregatedType/DiscretionaryMandates/RealAssets/OwnDiscretionaryMandates/Property/TotalAmount**

|            |                           |
|------------|---------------------------|
| diagram    |                           |
| type       | <b>xs:decimal</b>         |
| properties | isRef 0<br>content simple |
| annotation | documentation<br>In Euro  |

element

**AssetManagementCompanyAggregatedType/DiscretionaryMandates/RealAssets/ThirdPartyDiscretionaryMandates**

|            |  |
|------------|--|
| diagram    |  |
| properties | isRef 0<br>minOcc 0<br>maxOcc 1<br>content complex |
| children   | <a href="#">PortfoliomanagementForThirdParties</a> |



element

**AssetManagementCompanyAggregatedType/DiscretionaryMandates/RealAssets/ThirdPartyDiscretionaryMandates/PortfoliomanagementForThirdParties**

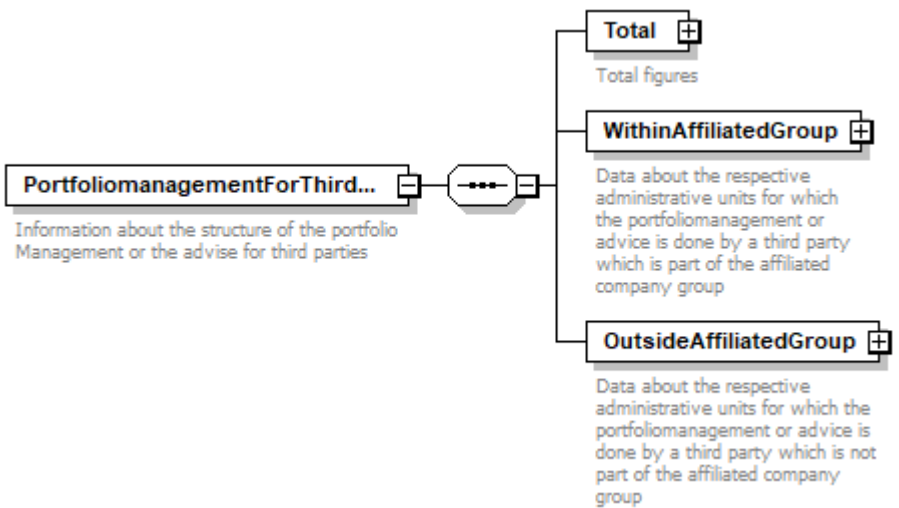
|                   |  |
|-------------------|--|
| <p>diagram</p>    |  <p><b>PortfoliomanagementForThird...</b><br/>Information about the structure of the portfolio Management or the advise for third parties</p> <p><b>Total</b> (+)<br/>Total figures</p> <p><b>WithinAffiliatedGroup</b> (+)<br/>Data about the respective administrative units for which the portfoliomanagement or advice is done by a third party which is part of the affiliated company group</p> <p><b>OutsideAffiliatedGroup</b> (+)<br/>Data about the respective administrative units for which the portfoliomanagement or advice is done by a third party which is not part of the affiliated company group</p> |
| <p>properties</p> | <p>isRef 0<br/>content complex</p>   |
| <p>children</p>   | <p><a href="#">Total</a> <a href="#">WithinAffiliatedGroup</a> <a href="#">OutsideAffiliatedGroup</a></p>  |
| <p>annotation</p> | <p>documentation<br/>Information about the structure of the portfolio Management or the advise for third parties</p>   |

element

**AssetManagementCompanyAggregatedType/DiscretionaryMandates/RealAssets/ThirdPartyDiscretionaryMandates/PortfoliomanagementForThirdParties/Total**

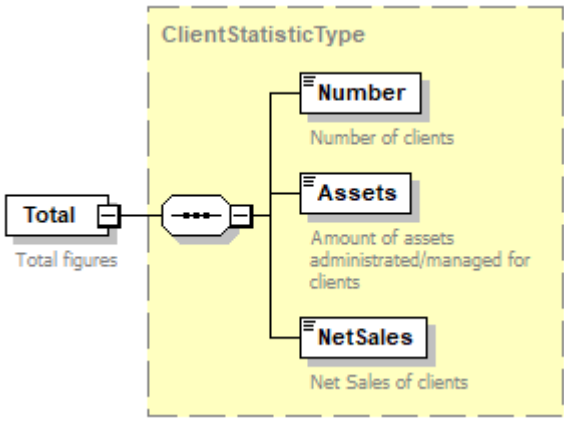
|                   |  |
|-------------------|--|
| <p>diagram</p>    |  <p><b>Total</b><br/>Total figures</p> <p><b>ClientStatisticType</b></p> <p><b>Number</b><br/>Number of clients</p> <p><b>Assets</b><br/>Amount of assets administrated/managed for clients</p> <p><b>NetSales</b><br/>Net Sales of clients</p> |
| <p>type</p>       | <p><a href="#">ClientStatisticType</a></p>   |
| <p>properties</p> | <p>isRef 0<br/>content complex</p>   |
| <p>children</p>   | <p><a href="#">Number</a> <a href="#">Assets</a> <a href="#">NetSales</a></p>  |
| <p>annotation</p> | <p>documentation<br/>Total figures</p>   |

element

**AssetManagementCompanyAggregatedType/DiscretionaryMandates/RealAssets/ThirdPartyDiscretionaryMandates/PortfoliomanagementForThirdParties/Total**

**ryMandates/PortfoliomanagementForThirdParties/WithinAffiliatedGroup**

|            |   |
|------------|---|
| diagram    | <p><b>WithinAffiliatedGroup</b><br/>Data about the respective administrative units for which the portfoliomanagement or advice is done by a third party which is part of the affiliated company group</p> <p><b>Total</b> +<br/>Total figures</p> <p><b>CompaniesInCountry</b> +<br/>Data about the part of the total which is related to the companies within the respective country</p> |
| properties | isRef 0<br>content complex  |
| children   | <a href="#">Total</a> <a href="#">CompaniesInCountry</a>  |
| annotation | documentation<br>Data about the respective administrative units for which the portfoliomanagement or advice is done by a third party which is part of the affiliated company group  |

element

**AssetManagementCompanyAggregatedType/DiscretionaryMandates/RealAssets/ThirdPartyDiscretionaryMandates/PortfoliomanagementForThirdParties/WithinAffiliatedGroup/Total**

|            |  |
|------------|--|
| diagram    | <p><b>Total</b><br/>Total figures</p> <p><b>ClientStatisticType</b></p> <p><b>Number</b><br/>Number of clients</p> <p><b>Assets</b><br/>Amount of assets administrated/managed for clients</p> <p><b>NetSales</b><br/>Net Sales of clients</p> |
| type       | <a href="#">ClientStatisticType</a>  |
| properties | isRef 0<br>content complex   |
| children   | <a href="#">Number</a> <a href="#">Assets</a> <a href="#">NetSales</a>   |
| annotation | documentation<br>Total figures   |

element

**AssetManagementCompanyAggregatedType/DiscretionaryMandates/RealAssets/ThirdPartyDiscretionaryMandates/PortfoliomanagementForThirdParties/WithinAffiliatedGroup/CompaniesInCountry**

|            |   |
|------------|---|
| diagram    | <p>The diagram shows a box labeled <b>CompaniesInCountry</b> with the description: "Data about the part of the total which is related to the companies within the respective country". This box is connected to a central node (a circle with three dots) which is further connected to a larger box labeled <b>ClientStatisticType</b>. Inside <b>ClientStatisticType</b>, there are three sub-items: <b>Number</b> (Number of clients), <b>Assets</b> (Amount of assets administrated/managed for clients), and <b>NetSales</b> (Net Sales of clients).</p> |
| type       | <a href="#">ClientStatisticType</a>   |
| properties | isRef 0<br>content complex  |
| children   | <a href="#">Number</a> <a href="#">Assets</a> <a href="#">NetSales</a>  |
| annotation | documentation<br>Data about the part of the total which is related to the companies within the respective country   |

element

**AssetManagementCompanyAggregatedType/DiscretionaryMandates/RealAssets/ThirdPartyDiscretionaryMandates/PortfoliomanagementForThirdParties/OutsideAffiliatedGroup**

|            |  |
|------------|--|
| diagram    | <p>The diagram shows a box labeled <b>OutsideAffiliatedGroup</b> with the description: "Data about the respective administrative units for which the portfoliomanagement or advice is done by a third party which is not part of the affiliated company group". This box is connected to a central node (a circle with three dots) which is further connected to two other boxes: <b>Total</b> (Total figures) and <b>CompaniesInCountry</b> (Data about the part of the total which is related to the companies within the respective country).</p> |
| properties | isRef 0<br>content complex   |
| children   | <a href="#">Total</a> <a href="#">CompaniesInCountry</a>   |
| annotation | documentation<br>Data about the respective administrative units for which the portfoliomanagement or advice is done by a third party which is not part of the affiliated company group   |

element

**AssetManagementCompanyAggregatedType/DiscretionaryMandates/RealAssets/ThirdPartyDiscretionaryMandates/PortfoliomanagementForThirdParties/OutsideAffiliatedGroup/Total**

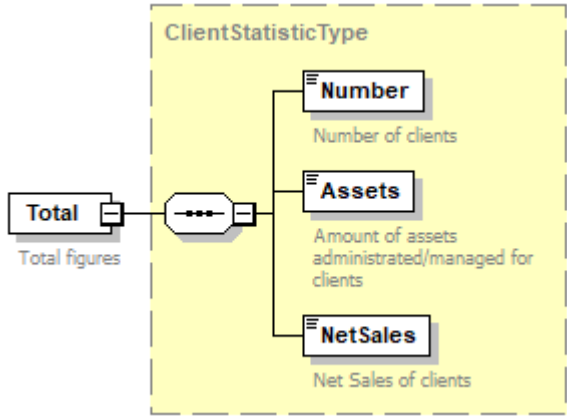
|            |   |
|------------|---|
| diagram    |  |
| type       | <a href="#">ClientStatisticType</a>   |
| properties | isRef 0<br>content complex  |
| children   | <a href="#">Number</a> <a href="#">Assets</a> <a href="#">NetSales</a>            |
| annotation | documentation<br>Total figures  |

element

**AssetManagementCompanyAggregatedType/DiscretionaryMandates/RealAssets/ThirdPartyDiscretionaryMandates/PortfoliomanagementForThirdParties/OutsideAffiliatedGroup/CompaniesInCountry**

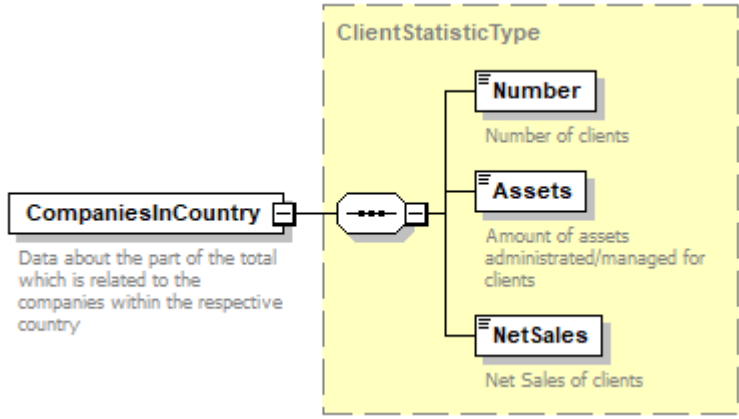
|            |   |
|------------|---|
| diagram    |                               |
| type       | <a href="#">ClientStatisticType</a>   |
| properties | isRef 0<br>content complex  |
| children   | <a href="#">Number</a> <a href="#">Assets</a> <a href="#">NetSales</a>  |
| annotation | documentation<br>Data about the part of the total which is related to the companies within the respective country |

complexType **AssetManagementCompanyDataType**

|          |   |
|----------|---|
| diagram  |   |
| children | <a href="#">OwnFunds</a> <a href="#">ThirdPartyFunds</a>  |
| used by  | elements <a href="#">AssetManagementCompanyAggregatedType/OpenEndedFunds/RetailFunds/RealAssets</a><br><a href="#">AssetManagementCompanyAggregatedType/OpenEndedFunds/InstitutionalFunds/RealAssets</a><br><a href="#">AssetManagementCompanyAggregatedType/OpenEndedFunds/RetailFunds/Securities Holdings</a><br><a href="#">AssetManagementCompanyAggregatedType/OpenEndedFunds/InstitutionalFunds/Securities Holdings</a> |

element **AssetManagementCompanyDataType/OwnFunds**

|            |  |
|------------|--|
| diagram    |  |
| properties | isRef 0<br>minOcc 0<br>maxOcc 1<br>content complex   |
| children   | <a href="#">Number</a> <a href="#">NetAssets</a> <a href="#">NetSales</a> <a href="#">Segmentation</a> <a href="#">PortfoliomanagementByThirdParties</a> |

element **AssetManagementCompanyDataType/OwnFunds/Number**

|            |                                  |
|------------|----------------------------------|
| diagram    |                                  |
| type       | <b>xs:int</b>                    |
| properties | isRef 0<br>content simple        |
| annotation | documentation<br>Number of funds |

element **AssetManagementCompanyDataType/OwnFunds/NetAssets**

|            |                             |
|------------|-----------------------------|
| diagram    |                             |
| type       | <b>xs:decimal</b>           |
| properties | isRef 0<br>content simple   |
| annotation | documentation<br>Net Assets |

element **AssetManagementCompanyDataType/OwnFunds/NetSales**

|            |   |
|------------|---|
| diagram    |   |
| type       | <b>xs:decimal</b>                               |
| properties | isRef 0<br>content simple                       |
| annotation | documentation<br>Net sales for a certain period |

element **AssetManagementCompanyDataType/OwnFunds/Segmentation**

|            |  |
|------------|--|
| diagram    |  |
| properties | isRef 0<br>content complex   |
| children   | <a href="#">FundsWithoutSegments</a> <a href="#">FundsWithSegments</a> <a href="#">NumberOfAdministrativeUnits</a> |
| annotation | documentation<br>Information about the segmentation of funds   |

element **AssetManagementCompanyDataType/OwnFunds/Segmentation/FundsWithoutSegments**

|            |               |
|------------|---------------|
| diagram    |               |
| type       | <b>xs:int</b> |
| properties | isRef 0       |

|            |  |
|------------|--|
|            | content simple   |
| annotation | documentation<br>Number of funds without segments or comparable subunits |

element **AssetManagementCompanyDataType/OwnFunds/Segmentation/FundsWithSegments**

|            |  |
|------------|--|
| diagram    | <p>The diagram shows the structure of the <b>FundsWithSegments</b> element. It is a complex type containing three child elements: <b>Number</b>, <b>NumberOfSegments</b>, and <b>NetAssets</b>. The <b>FundsWithSegments</b> element is represented by a box with a small square icon on its right side. A line connects it to a circle containing three dots, which then branches into three lines leading to the child elements. Each child element is also represented by a box with a small square icon on its right side. Below each child element box is its description: <b>Number</b> (Number of funds with segments or comparable subunits), <b>NumberOfSegments</b> (Number of segments or comparable units), and <b>NetAssets</b> (Net assets of funds with segments or comparable subunits).</p> |
| properties | isRef 0<br>content complex   |
| children   | <a href="#">Number</a> <a href="#">NumberOfSegments</a> <a href="#">NetAssets</a>  |
| annotation | documentation<br>Data about the fund with segments of an investment or asset management company  |

element **AssetManagementCompanyDataType/OwnFunds/Segmentation/FundsWithSegments/Number**

|            |   |
|------------|---|
| diagram    | <p>The diagram shows the structure of the <b>Number</b> element. It is a simple type containing one child element: <b>Number</b>. The <b>Number</b> element is represented by a box with a small square icon on its right side. Below the box is its description: <b>Number</b> (Number of funds with segments or comparable subunits).</p> |
| type       | <b>xs:int</b>   |
| properties | isRef 0<br>content simple   |
| annotation | documentation<br>Number of funds with segments or comparable subunits   |

element **AssetManagementCompanyDataType/OwnFunds/Segmentation/FundsWithSegments/NumberOfSegments**

|            |   |
|------------|---|
| diagram    | <p>The diagram shows the structure of the <b>NumberOfSegments</b> element. It is a simple type containing one child element: <b>NumberOfSegments</b>. The <b>NumberOfSegments</b> element is represented by a box with a small square icon on its right side. Below the box is its description: <b>NumberOfSegments</b> (Number of segments or comparable units).</p> |
| type       | <b>xs:int</b>   |
| properties | isRef 0<br>content simple   |
| annotation | documentation<br>Number of segments or comparable units   |

element

**AssetManagementCompanyDataType/OwnFunds/Segmentation/FundsWithSegments/NetAssets**

|            |   |
|------------|---|
| diagram    | <p><b>NetAssets</b><br/>Net assets of funds with with segments or comparable subunits</p> |
| type       | <b>xs:decimal</b>   |
| properties | isRef 0<br>content simple   |
| annotation | documentation<br>Net assets of funds with with segments or comparable subunits            |

**element AssetManagementCompanyDataType/OwnFunds/Segmentation/NumberOfAdministrativeUnits**

|            |  |
|------------|--|
| diagram    | <p><b>NumberOfAdministrativeUnits</b><br/>Total number of administrative units, which is the sum of the number of funds without segments and comparable units and the number of segments or comparable units</p> |
| type       | <b>xs:int</b>  |
| properties | isRef 0<br>content simple  |
| annotation | documentation<br>Total number of administrative units, which is the sum of the number of funds without segments and comparable units and the number of segments or comparable units                              |

**element AssetManagementCompanyDataType/OwnFunds/PortfoliomanagementByThirdParties**

|            |  |
|------------|--|
| diagram    | <p><b>PortfoliomanagementByThirdP...</b><br/>Information about the structure of the respective investment or asset management company with regard to portfoliomanagement by third parties</p> <p><b>TotalAdministrativeUnits</b><br/>Data about the total of the respective administrative units</p> <p><b>WithinAffiliatedGroup</b><br/>Data about the respective administrative units for which the portfoliomanagement or advice is done by a third party which is part of the affiliated company group</p> <p><b>OutsideAffiliatedGroup</b><br/>Data about the respective administrative units for which the portfoliomanagement or advice is done by a third party which is notpart of the affiliated company group</p> |
| properties | isRef 0<br>minOcc 0<br>maxOcc 1<br>content complex   |
| children   | <a href="#">TotalAdministrativeUnits</a> <a href="#">WithinAffiliatedGroup</a> <a href="#">OutsideAffiliatedGroup</a>  |
| annotation | documentation<br>Information about the structure of the respective investment or asset management company with regard to portfoliomanagement by third parties  |



element

**AssetManagementCompanyDataType/OwnFunds/PortfoliomanagementByThirdParties/TotalAdministrativeUnits**

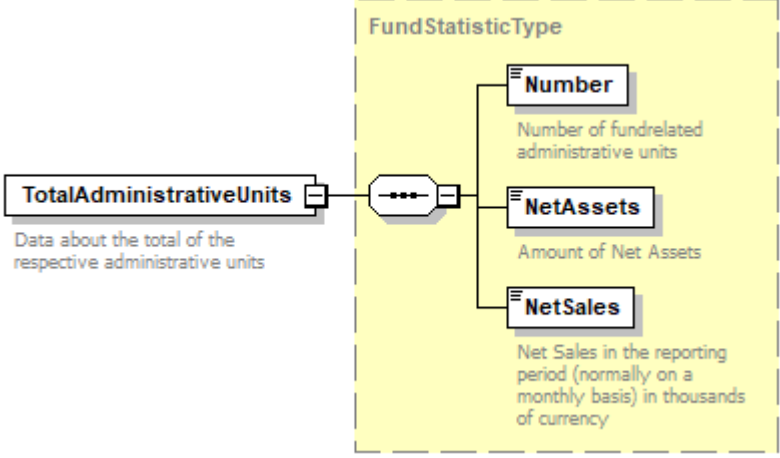
|                   |  |
|-------------------|--|
| <p>diagram</p>    |    |
| <p>type</p>       | <p><a href="#">FundStatisticType</a></p>   |
| <p>properties</p> | <p>isRef 0<br/>content complex</p>   |
| <p>children</p>   | <p><a href="#">Number</a> <a href="#">NetAssets</a> <a href="#">NetSales</a></p>     |
| <p>annotation</p> | <p>documentation<br/>Data about the total of the respective administrative units</p> |

element

**AssetManagementCompanyDataType/OwnFunds/PortfoliomanagementByThirdParties/WithinAffiliatedGroup**

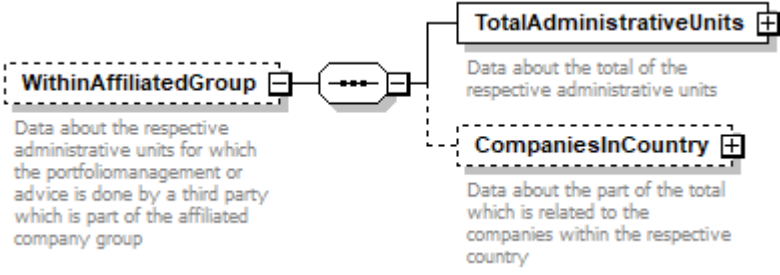
|                   |  |
|-------------------|--|
| <p>diagram</p>    |    |
| <p>properties</p> | <p>isRef 0<br/>minOcc 0<br/>maxOcc 1<br/>content complex</p>   |
| <p>children</p>   | <p><a href="#">TotalAdministrativeUnits</a> <a href="#">CompaniesInCountry</a></p>   |
| <p>annotation</p> | <p>documentation<br/>Data about the respective administrative units for which the portfoliomanagement or advice is done by a third party which is part of the affiliated company group</p> |

element

**AssetManagementCompanyDataType/OwnFunds/PortfoliomanagementByThirdParties/WithinAffiliated Group/TotalAdministrativeUnits**

|            |  |
|------------|--|
| diagram    | <p>The diagram illustrates the structure of the <b>TotalAdministrativeUnits</b> element. It is connected to a <b>FundStatisticType</b> container, which is highlighted in yellow. Inside this container, three data elements are listed: <b>Number</b> (Number of fundrelated administrative units), <b>NetAssets</b> (Amount of Net Assets), and <b>NetSales</b> (Net Sales in the reporting period (normally on a monthly basis) in thousands of currency). The <b>TotalAdministrativeUnits</b> element is described as 'Data about the total of the respective administrative units'.</p> |
| type       | <a href="#">FundStatisticType</a>  |
| properties | isRef 0<br>content complex   |
| children   | <a href="#">Number</a> <a href="#">NetAssets</a> <a href="#">NetSales</a>  |
| annotation | documentation<br>Data about the total of the respective administrative units   |

element

**AssetManagementCompanyDataType/OwnFunds/PortfoliomanagementByThirdParties/WithinAffiliated Group/CompaniesInCountry**

|            |   |
|------------|---|
| diagram    | <p>The diagram illustrates the structure of the <b>CompaniesInCountry</b> element. It is connected to a <b>FundStatisticType</b> container, which is highlighted in yellow. Inside this container, three data elements are listed: <b>Number</b> (Number of fundrelated administrative units), <b>NetAssets</b> (Amount of Net Assets), and <b>NetSales</b> (Net Sales in the reporting period (normally on a monthly basis) in thousands of currency). The <b>CompaniesInCountry</b> element is described as 'Data about the part of the total which is related to the companies within the respective country'.</p> |
| type       | <a href="#">FundStatisticType</a>   |
| properties | isRef 0<br>minOcc 0<br>maxOcc 1<br>content complex  |
| children   | <a href="#">Number</a> <a href="#">NetAssets</a> <a href="#">NetSales</a>   |
| annotation | documentation<br>Data about the part of the total which is related to the companies within the respective country   |

element

**AssetManagementCompanyDataType/OwnFunds/PortfoliomanagementByThirdParties/OutsideAffiliatedGroup**

|            |  |
|------------|--|
| diagram    |  |
| properties | <p>isRef 0<br/> minOcc 0<br/> maxOcc 1<br/> content complex</p>  |
| children   | <p><a href="#">TotalAdministrativeUnits</a> <a href="#">CompaniesInCountry</a></p>   |
| annotation | <p>documentation<br/> Data about the respective administrative units for which the portfoliomanagement or advice is done by a third party which is notpart of the affiliated company group</p> |

element

**AssetManagementCompanyDataType/OwnFunds/PortfoliomanagementByThirdParties/OutsideAffiliatedGroup/TotalAdministrativeUnits**

|            |   |
|------------|---|
| diagram    |   |
| type       | <p><a href="#">FundStatisticType</a></p>  |
| properties | <p>isRef 0<br/> content complex</p>   |
| children   | <p><a href="#">Number</a> <a href="#">NetAssets</a> <a href="#">NetSales</a></p>      |
| annotation | <p>documentation<br/> Data about the total of the respective administrative units</p> |

element

**AssetManagementCompanyDataType/OwnFunds/PortfoliomanagementByThirdParties/OutsideAffiliate  
dGroup/CompaniesInCountry**

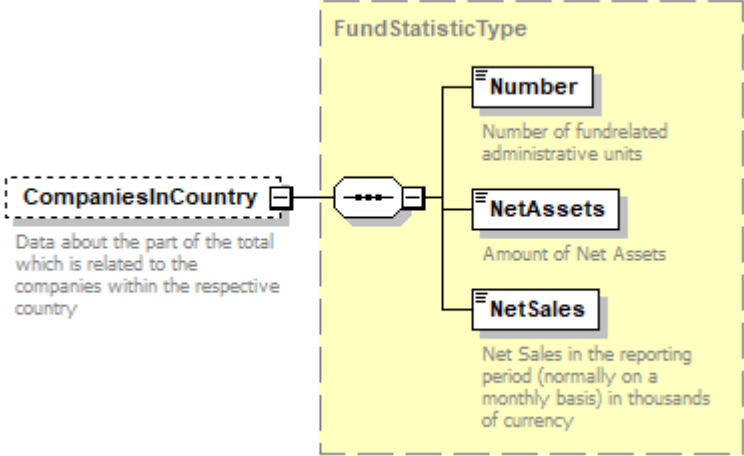
|                   |   |
|-------------------|---|
| <p>diagram</p>    |   |
| <p>type</p>       | <p><a href="#">FundStatisticType</a></p>  |
| <p>properties</p> | <p>isRef 0<br/>minOcc 0<br/>maxOcc 1<br/>content complex</p>  |
| <p>children</p>   | <p><a href="#">Number</a> <a href="#">NetAssets</a> <a href="#">NetSales</a></p>  |
| <p>annotation</p> | <p>documentation<br/>Data about the part of the total which is related to the companies within the respective country</p> |

element **AssetManagementCompanyDataType/ThirdPartyFunds**

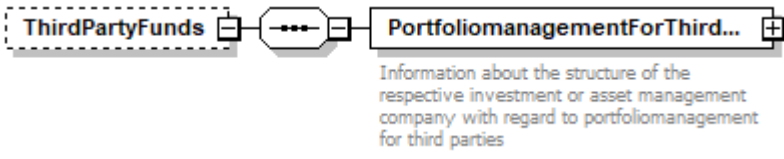
|                   |  |
|-------------------|--|
| <p>diagram</p>    |  |
| <p>properties</p> | <p>isRef 0<br/>minOcc 0<br/>maxOcc 1<br/>content complex</p>                         |
| <p>children</p>   | <p><a href="#">PortfoliomanagementForThirdParties</a></p>                            |

element **AssetManagementCompanyDataType/ThirdPartyFunds/PortfoliomangementForThirdParties**

|                   |  |
|-------------------|--|
| <p>diagram</p>    | <p><b>PortfoliomangementForThird...</b><br/>Information about the structure of the respective investment or asset management company with regard to portfoliomangement for third parties</p> <p><b>TotalAdministrativeUnits</b> +<br/>Data about the total of the respective administrative units</p> <p><b>WithinAffiliatedGroup</b> +<br/>Data about the respective administrative units for which the portfoliomangement or advice is done by a third party which is part of the affiliated company group</p> <p><b>OutsideAffiliatedGroup</b> +<br/>Data about the respective administrative units for which the portfoliomangement or advice is done by a third party which is not part of the affiliated company group</p> |
| <p>properties</p> | <p>isRef 0<br/>content complex</p>   |
| <p>children</p>   | <p><a href="#">TotalAdministrativeUnits</a> <a href="#">WithinAffiliatedGroup</a> <a href="#">OutsideAffiliatedGroup</a></p>   |
| <p>annotation</p> | <p>documentation<br/>Information about the structure of the respective investment or asset management company with regard to portfoliomangement for third parties</p>  |

element **AssetManagementCompanyDataType/ThirdPartyFunds/PortfoliomangementForThirdParties/TotalAdministrativeUnits**

|                   |  |
|-------------------|--|
| <p>diagram</p>    | <p><b>TotalAdministrativeUnits</b><br/>Data about the total of the respective administrative units</p> <p><b>FundStatisticType</b></p> <ul style="list-style-type: none"> <li><b>Number</b><br/>Number of fundrelated administrative units</li> <li><b>NetAssets</b><br/>Amount of Net Assets</li> <li><b>NetSales</b><br/>Net Sales in the reporting period (normally on a monthly basis) in thousands of currency</li> </ul> |
| <p>type</p>       | <p><a href="#">FundStatisticType</a></p>   |
| <p>properties</p> | <p>isRef 0<br/>content complex</p>   |
| <p>children</p>   | <p><a href="#">Number</a> <a href="#">NetAssets</a> <a href="#">NetSales</a></p>   |
| <p>annotation</p> | <p>documentation<br/>Data about the total of the respective administrative units</p>   |

element

### AssetManagementCompanyDataType/ThirdPartyFunds/PortfoliomangementForThirdParties/WithinAffiliatedGroup

|            |   |
|------------|---|
| diagram    |   |
| properties | isRef 0<br>minOcc 0<br>maxOcc 1<br>content complex  |
| children   | <a href="#">TotalAdministrativeUnits</a> <a href="#">CompaniesInCountry</a>   |
| annotation | documentation<br>Data about the respective administrative units for which the portfoliomangement or advice is done by a third party which is part of the affiliated company group |

### element

### AssetManagementCompanyDataType/ThirdPartyFunds/PortfoliomangementForThirdParties/WithinAffiliatedGroup/TotalAdministrativeUnits

|            |  |
|------------|--|
| diagram    |  |
| type       | <a href="#">FundStatisticType</a>  |
| properties | isRef 0<br>content complex   |
| children   | <a href="#">Number</a> <a href="#">NetAssets</a> <a href="#">NetSales</a>    |
| annotation | documentation<br>Data about the total of the respective administrative units |

element

**AssetManagementCompanyDataType/ThirdPartyFunds/PortfoliomanagementForThirdParties/WithinAffiliatedGroup/CompaniesInCountry**

|            |  |
|------------|--|
| diagram    | <p>The diagram illustrates the structure of the <b>CompaniesInCountry</b> element. It is a complex type (indicated by a dashed border) that contains three child elements: <b>Number</b> (Number of fundrelated administrative units), <b>NetAssets</b> (Amount of Net Assets), and <b>NetSales</b> (Net Sales in the reporting period (normally on a monthly basis) in thousands of currency). The <b>CompaniesInCountry</b> element is also described as "Data about the part of the total which is related to the companies within the respective country".</p> |
| type       | <a href="#">FundStatisticType</a>  |
| properties | <p>isRef 0<br/> minOcc 0<br/> maxOcc 1<br/> content complex</p>  |
| children   | <a href="#">Number</a> <a href="#">NetAssets</a> <a href="#">NetSales</a>  |
| annotation | <p>documentation<br/> Data about the part of the total which is related to the companies within the respective country</p>   |

element

**AssetManagementCompanyDataType/ThirdPartyFunds/PortfoliomanagementForThirdParties/OutsideAffiliatedGroup**

|            |  |
|------------|--|
| diagram    | <p>The diagram illustrates the structure of the <b>OutsideAffiliatedGroup</b> element. It is a complex type (indicated by a dashed border) that contains two child elements: <b>TotalAdministrativeUnits</b> (Data about the total of the respective administrative units) and <b>CompaniesInCountry</b> (Data about the part of the total which is related to the companies within the respective country). The <b>OutsideAffiliatedGroup</b> element is also described as "Data about the respective administrative units for which the portfoliomanagement or advice is done by a third party which is not part of the affiliated company group".</p> |
| properties | <p>isRef 0<br/> minOcc 0<br/> maxOcc 1<br/> content complex</p>  |
| children   | <a href="#">TotalAdministrativeUnits</a> <a href="#">CompaniesInCountry</a>  |
| annotation | <p>documentation<br/> Data about the respective administrative units for which the portfoliomanagement or advice is done by a third party which is not part of the affiliated company group</p>  |

element

**AssetManagementCompanyDataType/ThirdPartyFunds/PortfoliomangementForThirdParties/OutsideAffiliatedGroup/TotalAdministrativeUnits**

|            |   |
|------------|---|
| diagram    | <p>The diagram shows a class <b>TotalAdministrativeUnits</b> with the description "Data about the total of the respective administrative units". This class is connected to a container labeled <b>FundStatisticType</b> (indicated by a dashed box). Inside this container, there are three elements: <b>Number</b> (Number of fundrelated administrative units), <b>NetAssets</b> (Amount of Net Assets), and <b>NetSales</b> (Net Sales in the reporting period (normally on a monthly basis) in thousands of currency).</p> |
| type       | <a href="#">FundStatisticType</a>   |
| properties | isRef 0<br>content complex  |
| children   | <a href="#">Number</a> <a href="#">NetAssets</a> <a href="#">NetSales</a>   |
| annotation | documentation<br>Data about the total of the respective administrative units  |

element

**AssetManagementCompanyDataType/ThirdPartyFunds/PortfoliomangementForThirdParties/OutsideAffiliatedGroup/CompaniesInCountry**

|            |  |
|------------|--|
| diagram    | <p>The diagram shows a class <b>CompaniesInCountry</b> with the description "Data about the part of the total which is related to the companies within the respective country". This class is connected to a container labeled <b>FundStatisticType</b> (indicated by a dashed box). Inside this container, there are three elements: <b>Number</b> (Number of fundrelated administrative units), <b>NetAssets</b> (Amount of Net Assets), and <b>NetSales</b> (Net Sales in the reporting period (normally on a monthly basis) in thousands of currency).</p> |
| type       | <a href="#">FundStatisticType</a>  |
| properties | isRef 0<br>minOcc 0<br>maxOcc 1<br>content complex   |
| children   | <a href="#">Number</a> <a href="#">NetAssets</a> <a href="#">NetSales</a>  |
| annotation | documentation<br>Data about the part of the total which is related to the companies within the respective country  |



complexType **AssetManagementCompanyFundAssetsType**

|            |  |
|------------|--|
| diagram    | <p>The diagram shows a container element labeled "AssetManagementCompanyFundAssetsType" with the text "Company assets data" below it. This container is connected to two child elements: "NetAssets" and "GrossAssets".</p> <p><b>NetAssets</b><br/>Net assets in total, calculated on an overall basis including outstanding debts, bank loans, and other liabilities (Net Asset Value approach). In thousands of currency.</p> <p><b>GrossAssets</b><br/>Assets in total, calculated on a basis excluding outstanding debts, bank loans, and other liabilities (Gross Asset Value approach). "Aktiv vermoegeen" in German. In thousands of currency.</p> |
| children   | <a href="#">NetAssets</a> <a href="#">GrossAssets</a>  |
| used by    | elements <a href="#">AssetManagementClosedDataType/OwnFunds/AssetInformation</a><br><a href="#">FundStatisticClosedFundType/AssetsClosedFunds</a><br><a href="#">AssetManagementClosedDataType/OwnFunds/Segmentation/FundsWithSegments/NetAssetsSegments</a>   |
| annotation | documentation<br>Company assets data   |

element **AssetManagementCompanyFundAssetsType/NetAssets**

|            |   |
|------------|---|
| diagram    | <p>The diagram shows the "NetAssets" element with the following description:<br/>Net assets in total, calculated on an overall basis including outstanding debts, bank loans, and other liabilities (Net Asset Value approach). In thousands of currency.</p> |
| type       | <b>xs:decimal</b>   |
| properties | isRef 0<br>content simple   |
| annotation | documentation<br>Net assets in total, calculated on an overall basis including outstanding debts, bank loans, and other liabilities (Net Asset Value approach). In thousands of currency.   |

element **AssetManagementCompanyFundAssetsType/GrossAssets**

|            |  |
|------------|--|
| diagram    | <p>The diagram shows the "GrossAssets" element with the following description:<br/>Assets in total, calculated on a basis excluding outstanding debts, bank loans, and other liabilities (Gross Asset Value approach). "Aktiv vermoegeen" in German. In thousands of currency.</p> |
| type       | <b>xs:decimal</b>  |
| properties | isRef 0<br>content simple  |

|            |  |
|------------|--|
| annotation | documentation<br>Assets in total, calculated on a basis excluding outstanding debts, bank loans, and other liabilities (Gross Asset Value approach). "Aktivvermoegen" in German. In thousands of currency. |
|------------|--|

### complexType **AssetManagementCompanySalesType**

|            |  |
|------------|--|
| diagram    |  |
| children   | <a href="#">NetSales</a> <a href="#">EquityPlaced</a>  |
| used by    | elements <a href="#">FundStatisticClosedFundType/NetSalesClosedFunds</a><br><a href="#">AssetManagementClosedDataType/OwnFunds/NetSalesInformation</a> |
| annotation | documentation<br>Company sales data  |

### element **AssetManagementCompanySalesType/NetSales**

|            |  |
|------------|--|
| diagram    |  |
| type       | <b>xs:decimal</b>  |
| properties | isRef 0<br>content simple  |
| annotation | documentation<br>Net Sales in the Reporting Period (in most cases on a monthly basis) in thousands of currency |

### element **AssetManagementCompanySalesType/EquityPlaced**

|            |  |
|------------|--|
| diagram    |  |
| type       | <b>xs:decimal</b>  |
| properties | isRef 0<br>content simple  |
| annotation | documentation<br>Equity placed; equivalent to gross sales in open-ended funds. Refers to the month reported, given in thousands of currency. |

complexType **AssetMgmtCompanyDynDataType**

|          |  |
|----------|--|
| diagram  | <p>The diagram shows a box labeled 'AssetMgmtCompanyDynDataTy...' connected to a box labeled 'AssetMgmtCompanyDynDataSet'. A multiplicity of '1..∞' is indicated below the 'AssetMgmtCompanyDynDataSet' box.</p> |
| children | <a href="#">AssetMgmtCompanyDynDataSet</a>   |
| used by  | element <a href="#">FundsXML4/AssetMgmtCompanyDynData</a>  |

element **AssetMgmtCompanyDynDataType/AssetMgmtCompanyDynDataSet**

|            |  |
|------------|--|
| diagram    | <p>The diagram shows a box labeled 'AssetMgmtCompanyDynDataSet' connected to two boxes labeled 'Company' and 'Statistics'. A multiplicity of '1..∞' is indicated below the 'AssetMgmtCompanyDynDataSet' box, and another '1..∞' is indicated below the 'Statistics' box.</p> |
| properties | <p>isRef 0<br/> minOcc 1<br/> maxOcc unbounded<br/> content complex</p>  |
| children   | <a href="#">Company</a> <a href="#">Statistics</a>   |

element **AssetMgmtCompanyDynDataType/AssetMgmtCompanyDynDataSet/Company**

|                   |  |
|-------------------|--|
| <p>diagram</p>    | <p>The diagram shows a class <b>Company</b> connected to a class <b>CompanyType</b>. The <b>CompanyType</b> class is highlighted in yellow and contains the following attributes:</p> <ul style="list-style-type: none"> <li><b>Identifiers</b>: Identifiers of company</li> <li><b>Name</b>: Name of company</li> <li><b>LegalName</b>: Legal (full) name of company</li> <li><b>LegalForm</b>: Legal form of company</li> <li><b>Address</b>: Address of company</li> <li><b>BusinessCountry</b>: Country code of main business of company</li> <li><b>ParentCompany</b>: Parent company (if applicable)</li> <li><b>OtherClassification</b>: All other identifiers (with listed or free type), with a cardinality of 0..∞.</li> </ul> |
| <p>type</p>       | <p><a href="#">CompanyType</a></p>   |
| <p>properties</p> | <p>isRef 0<br/>content complex</p>   |
| <p>children</p>   | <p><a href="#">Identifiers</a> <a href="#">Name</a> <a href="#">LegalName</a> <a href="#">LegalForm</a> <a href="#">Address</a> <a href="#">BusinessCountry</a> <a href="#">ParentCompany</a> <a href="#">OtherClassification</a></p>  |

element **AssetMgmtCompanyDynDataSet/AssetMgmtCompanyDynDataSet/Statistics**

|            |   |
|------------|---|
| diagram    |   |
| type       | <a href="#">AssetManagementCompanyAggregatedType</a>  |
| properties | isRef 0<br>minOcc 1<br>maxOcc unbounded<br>content complex  |
| children   | <a href="#">Date</a> <a href="#">Country</a> <a href="#">Currency</a> <a href="#">OpenEndedFunds</a> <a href="#">ClosedEndedFunds</a> <a href="#">DiscretionaryMandates</a> |

complexType **ClientStatisticType**

|          |  |
|----------|--|
| diagram  |  |
| children | <a href="#">Number</a> <a href="#">Assets</a> <a href="#">NetSales</a>   |
| used by  | elements <a href="#">AssetManagementCompanyAggregatedType/DiscretionaryMandates/Securities Holdings/OwnDiscretionaryMandates/PortfoliomanagementByThirdParties/WithinAffiliatedGroup/CompaniesInCountry</a><br><a href="#">AssetManagementCompanyAggregatedType/DiscretionaryMandates/Securities Holdings/OwnDiscretionaryMandates/PortfoliomanagementByThirdParties/OutsideAffiliatedGroup/CompaniesInCountry</a><br><a href="#">AssetManagementCompanyAggregatedType/DiscretionaryMandates/Securities Holdings/ThirdPartyDiscretionaryMandates/PortfoliomanagementForThirdParties/WithinAffiliatedGroup/CompaniesInCountry</a> |

|            |  |
|------------|--|
|            | <a href="#">AssetManagementCompanyAggregatedType/DiscretionaryMandates/Securities Holdings/ThirdPartyDiscretionaryMandates/PortfoliomanagementForThirdParties/OutsideAffiliatedGroup/CompaniesInCountry</a><br><a href="#">AssetManagementCompanyAggregatedType/DiscretionaryMandates/RealAssets/OwnDiscretionaryMandates/PortfoliomanagementByThirdParties/WithinAffiliatedGroup/CompaniesInCountry</a><br><a href="#">AssetManagementCompanyAggregatedType/DiscretionaryMandates/RealAssets/OwnDiscretionaryMandates/PortfoliomanagementByThirdParties/OutsideAffiliatedGroup/CompaniesInCountry</a><br><a href="#">AssetManagementCompanyAggregatedType/DiscretionaryMandates/RealAssets/ThirdPartyDiscretionaryMandates/PortfoliomanagementForThirdParties/WithinAffiliatedGroup/CompaniesInCountry</a><br><a href="#">AssetManagementCompanyAggregatedType/DiscretionaryMandates/RealAssets/ThirdPartyDiscretionaryMandates/PortfoliomanagementForThirdParties/OutsideAffiliatedGroup/CompaniesInCountry</a><br><a href="#">AssetManagementCompanyAggregatedType/DiscretionaryMandates/Securities Holdings/OwnDiscretionaryMandates/Clients/Location/InCountry</a><br><a href="#">AssetManagementCompanyAggregatedType/DiscretionaryMandates/RealAssets/OwnDiscretionaryMandates/Clients/Location/InCountry</a><br><a href="#">AssetManagementCompanyAggregatedType/DiscretionaryMandates/Securities Holdings/OwnDiscretionaryMandates/Clients/LegalTypeClient/Institutional</a><br><a href="#">AssetManagementCompanyAggregatedType/DiscretionaryMandates/RealAssets/OwnDiscretionaryMandates/Clients/LegalTypeClient/Institutional</a><br><a href="#">AssetManagementCompanyAggregatedType/DiscretionaryMandates/Securities Holdings/OwnDiscretionaryMandates/Clients/Location/OutsideCountry</a><br><a href="#">AssetManagementCompanyAggregatedType/DiscretionaryMandates/RealAssets/OwnDiscretionaryMandates/Clients/Location/OutsideCountry</a><br><a href="#">AssetManagementCompanyAggregatedType/DiscretionaryMandates/Securities Holdings/OwnDiscretionaryMandates/Clients/LegalTypeClient/Private</a><br><a href="#">AssetManagementCompanyAggregatedType/DiscretionaryMandates/RealAssets/OwnDiscretionaryMandates/Clients/LegalTypeClient/Private</a><br><a href="#">AssetManagementCompanyAggregatedType/DiscretionaryMandates/Securities Holdings/OwnDiscretionaryMandates/Clients/Total</a><br><a href="#">AssetManagementCompanyAggregatedType/DiscretionaryMandates/Securities Holdings/OwnDiscretionaryMandates/PortfoliomanagementByThirdParties/Total</a><br><a href="#">AssetManagementCompanyAggregatedType/DiscretionaryMandates/Securities Holdings/OwnDiscretionaryMandates/PortfoliomanagementByThirdParties/WithinAffiliatedGroup/Total</a><br><a href="#">AssetManagementCompanyAggregatedType/DiscretionaryMandates/Securities Holdings/OwnDiscretionaryMandates/PortfoliomanagementByThirdParties/OutsideAffiliatedGroup/Total</a><br><a href="#">AssetManagementCompanyAggregatedType/DiscretionaryMandates/Securities Holdings/ThirdPartyDiscretionaryMandates/PortfoliomanagementForThirdParties/Total</a><br><a href="#">AssetManagementCompanyAggregatedType/DiscretionaryMandates/Securities Holdings/ThirdPartyDiscretionaryMandates/PortfoliomanagementForThirdParties/WithinAffiliatedGroup/Total</a><br><a href="#">AssetManagementCompanyAggregatedType/DiscretionaryMandates/Securities Holdings/ThirdPartyDiscretionaryMandates/PortfoliomanagementForThirdParties/OutsideAffiliatedGroup/Total</a><br><a href="#">AssetManagementCompanyAggregatedType/DiscretionaryMandates/RealAssets/OwnDiscretionaryMandates/Clients/Total</a><br><a href="#">AssetManagementCompanyAggregatedType/DiscretionaryMandates/RealAssets/OwnDiscretionaryMandates/PortfoliomanagementByThirdParties/Total</a><br><a href="#">AssetManagementCompanyAggregatedType/DiscretionaryMandates/RealAssets/OwnDiscretionaryMandates/PortfoliomanagementByThirdParties/WithinAffiliatedGroup/Total</a><br><a href="#">AssetManagementCompanyAggregatedType/DiscretionaryMandates/RealAssets/OwnDiscretionaryMandates/PortfoliomanagementByThirdParties/OutsideAffiliatedGroup/Total</a><br><a href="#">AssetManagementCompanyAggregatedType/DiscretionaryMandates/RealAssets/ThirdPartyDiscretionaryMandates/PortfoliomanagementForThirdParties/Total</a><br><a href="#">AssetManagementCompanyAggregatedType/DiscretionaryMandates/RealAssets/ThirdPartyDiscretionaryMandates/PortfoliomanagementForThirdParties/WithinAffiliatedGroup/Total</a><br><a href="#">AssetManagementCompanyAggregatedType/DiscretionaryMandates/RealAssets/ThirdPartyDiscretionaryMandates/PortfoliomanagementForThirdParties/OutsideAffiliatedGroup/Total</a> |
| annotation | documentation<br>Data about the clients of an investment or asset management company   |

element **ClientStatisticType/Number**

|            |   |
|------------|---|
| diagram    |  |
| type       | <b>xs:int</b>   |
| properties | isRef 0<br>content simple   |

|            |                                    |
|------------|------------------------------------|
| annotation | documentation<br>Number of clients |
|------------|------------------------------------|

### element **ClientStatisticType/Assets**

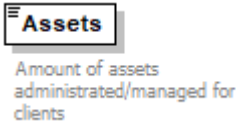
|            |   |
|------------|---|
| diagram    |  |
| type       | <b>xs:decimal</b>   |
| properties | isRef 0<br>content simple   |
| annotation | documentation<br>Amount of assets administrated/managed for clients               |

### element **ClientStatisticType/NetSales**

|            |   |
|------------|---|
| diagram    |  |
| type       | <b>xs:decimal</b>   |
| properties | isRef 0<br>content simple   |
| annotation | documentation<br>Net Sales of clients   |

### complexType **FundStatisticClosedFundType**

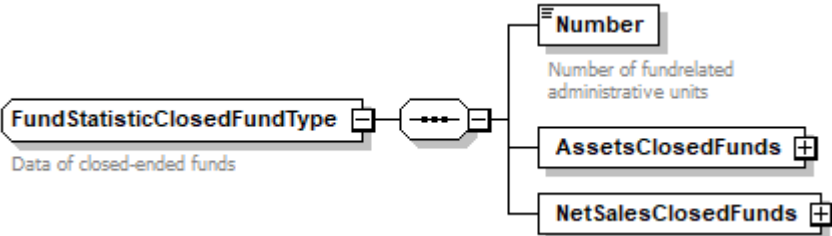
|          |  |
|----------|--|
| diagram  |    |
| children | <a href="#">Number</a> <a href="#">AssetsClosedFunds</a> <a href="#">NetSalesClosedFunds</a>   |
| used by  | <p>elements</p> <ul style="list-style-type: none"> <li><a href="#">AssetManagementClosedDataType/OwnFunds/PortfoliomanagementByThirdParties/WithinAffiliatedGroup/CompaniesInCountry</a></li> <li><a href="#">AssetManagementClosedDataType/OwnFunds/PortfoliomanagementByThirdParties/OutsideAffiliatedGroup/CompaniesInCountry</a></li> <li><a href="#">AssetManagementClosedDataType/ThirdPartyFunds/PortfoliomanagementForThirdParty/WithinAffiliatedGroup/CompaniesInCountry</a></li> <li><a href="#">AssetManagementClosedDataType/ThirdPartyFunds/PortfoliomanagementForThirdParty/OutsideAffiliatedGroup/CompaniesInCountry</a></li> <li><a href="#">AssetManagementClosedDataType/OwnFunds/PortfoliomanagementByThirdParties/TotalAdministrativeUnits</a></li> <li><a href="#">AssetManagementClosedDataType/OwnFunds/PortfoliomanagementByThirdParties/WithinAffiliatedGroup/TotalAdministrativeUnits</a></li> <li><a href="#">AssetManagementClosedDataType/OwnFunds/PortfoliomanagementByThirdParties/OutsideAffiliatedGroup/TotalAdministrativeUnits</a></li> <li><a href="#">AssetManagementClosedDataType/ThirdPartyFunds/PortfoliomanagementForThirdParty/TotalAdministrativeUnits</a></li> <li><a href="#">AssetManagementClosedDataType/ThirdPartyFunds/PortfoliomanagementForThirdParty/WithinAffiliatedGroup/TotalAdministrativeUnits</a></li> </ul> |

|            |  |
|------------|--|
|            | <a href="#">AssetManagementClosedDataType/ThirdPartyFunds/PortfoliomanagementForThirdParty/OutsideAffiliatedGroup/TotalAdministrativeUnits</a> |
| annotation | documentation<br>Data of closed-ended funds  |

element **FundStatisticClosedFundType/Number**

|            |   |
|------------|---|
| diagram    |  |
| type       | <b>xs:int</b>   |
| properties | isRef 0<br>content simple   |
| annotation | documentation<br>Number of fundrelated administrative units                       |

element **FundStatisticClosedFundType/AssetsClosedFunds**

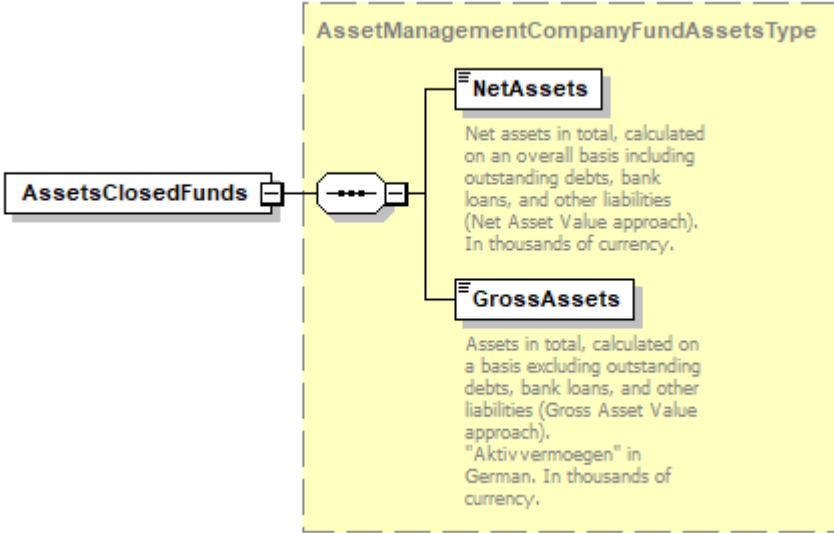
|            |   |
|------------|---|
| diagram    |  |
| type       | <a href="#">AssetManagementCompanyFundAssetsType</a>                                |
| properties | isRef 0<br>content complex  |
| children   | <a href="#">NetAssets</a> <a href="#">GrossAssets</a>                               |



element **FundStatisticClosedFundType/NetSalesClosedFunds**

|            |  |
|------------|--|
| diagram    | <p>The diagram shows a box labeled <b>NetSalesClosedFunds</b> connected to a dashed box labeled <b>AssetManagementCompanySales Type</b>. Inside this dashed box, there are two sub-elements: <b>NetSales</b> and <b>EquityPlaced</b>. The <b>NetSales</b> element is described as "Net Sales in the Reporting Period (in most cases on a monthly basis) in thousands of currency". The <b>EquityPlaced</b> element is described as "Equity placed; equivalent to gross sales in open-ended funds. Refers to the month reported, given in thousands of currency."</p> |
| type       | <a href="#">AssetManagementCompanySalesType</a>  |
| properties | isRef 0<br>content complex   |
| children   | <a href="#">NetSales</a> <a href="#">EquityPlaced</a>  |

complexType **FundStatisticType**

|          |  |
|----------|--|
| diagram  | <p>The diagram shows a box labeled <b>FundStatisticType</b> (with the description "Data of open-ended funds") connected to three sub-elements: <b>Number</b>, <b>NetAssets</b>, and <b>NetSales</b>. The <b>Number</b> element is described as "Number of fundrelated administrative units". The <b>NetAssets</b> element is described as "Amount of Net Assets". The <b>NetSales</b> element is described as "Net Sales in the reporting period (normally on a monthly basis) in thousands of currency".</p>  |
| children | <a href="#">Number</a> <a href="#">NetAssets</a> <a href="#">NetSales</a>  |
| used by  | <p>elements</p> <ul style="list-style-type: none"> <li><a href="#">AssetManagementCompanyDataType/OwnFunds/PortfoliomanagementByThirdParties/WithinAffiliatedGroup/CompaniesInCountry</a></li> <li><a href="#">AssetManagementCompanyDataType/OwnFunds/PortfoliomanagementByThirdParties/OutsideAffiliatedGroup/CompaniesInCountry</a></li> <li><a href="#">AssetManagementCompanyDataType/ThirdPartyFunds/PortfoliomanagementForThirdParties/WithinAffiliatedGroup/CompaniesInCountry</a></li> <li><a href="#">AssetManagementCompanyDataType/ThirdPartyFunds/PortfoliomanagementForThirdParties/OutsideAffiliatedGroup/CompaniesInCountry</a></li> <li><a href="#">AssetManagementCompanyDataType/OwnFunds/PortfoliomanagementByThirdParties/TotalAdministrativeUnits</a></li> <li><a href="#">AssetManagementCompanyDataType/OwnFunds/PortfoliomanagementByThirdParties/WithinAffiliatedGroup/TotalAdministrativeUnits</a></li> <li><a href="#">AssetManagementCompanyDataType/OwnFunds/PortfoliomanagementByThirdParties/OutsideAffiliatedGroup/TotalAdministrativeUnits</a></li> <li><a href="#">AssetManagementCompanyDataType/ThirdPartyFunds/PortfoliomanagementForThirdParties/TotalAdministrativeUnits</a></li> <li><a href="#">AssetManagementCompanyDataType/ThirdPartyFunds/PortfoliomanagementForThirdParties/WithinAffiliatedGroup/TotalAdministrativeUnits</a></li> <li><a href="#">AssetManagementCompanyDataType/ThirdPartyFunds/PortfoliomanagementForThirdParties/OutsideAffiliatedGroup/TotalAdministrativeUnits</a></li> </ul> |
| annotati | documentation  |

|    |                          |
|----|--------------------------|
| on | Data of open-ended funds |
|----|--------------------------|

element **FundStatisticType/Number**

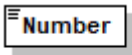
|            |   |
|------------|---|
| diagram    |  <p>Number of fundrelated administrative units</p> |
| type       | <b>xs:int</b>   |
| properties | isRef 0<br>content simple   |
| annotation | documentation<br>Number of fundrelated administrative units   |

element **FundStatisticType/NetAssets**

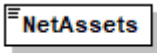
|            |   |
|------------|---|
| diagram    |  <p>Amount of Net Assets</p> |
| type       | <b>xs:decimal</b>   |
| properties | isRef 0<br>content simple   |
| annotation | documentation<br>Amount of Net Assets   |

element **FundStatisticType/NetSales**

|            |   |
|------------|---|
| diagram    |  <p>Net Sales in the reporting period (normally on a monthly basis) in thousands of currency</p> |
| type       | <b>xs:decimal</b>   |
| properties | isRef 0<br>content simple   |
| annotation | documentation<br>Net Sales in the reporting period (normally on a monthly basis) in thousands of currency   |

### complexType EMIR\_ReportType

|          |  |
|----------|--|
| diagram  | <p><b>FundOrShareClassIdentifiers</b> </p> <p>Fund or share class identifiers for easy connection to other fund or share class data</p> <p><b>DataSupplier</b> </p> <p>Definition of data source (investment company, vendor, ...)</p> <p><b>CounterpartyData</b> </p> <p>Section 1</p> <p><b>CommonData</b> </p> <p>Section 2</p> |
| children | <a href="#">FundOrShareClassIdentifiers</a> <a href="#">DataSupplier</a> <a href="#">CounterpartyData</a> <a href="#">CommonData</a>   |
| used by  | element <a href="#">EMIRType/EMIR_Report</a>   |

### element EMIR\_ReportType/FundOrShareClassIdentifiers

|            |  |
|------------|--|
| diagram    | <p><b>FundOrShareClassIdentifiers</b> </p> <p>Fund or share class identifiers for easy connection to other fund or share class data</p> <p><b>LEI</b> </p> <p>Legal Entity Identifier of fund</p> <p><b>ISINs</b> </p> <p>List of ISINs for share classes</p> <p><b>FundOrShareClassIdentifiers Type</b></p> |
| type       | <a href="#">FundOrShareClassIdentifiersType</a>  |
| properties | <p>isRef 0</p> <p>minOcc 0</p> <p>maxOcc 1</p> <p>content complex</p>  |
| children   | <a href="#">LEI</a> <a href="#">ISINs</a>  |
| annotation | <p>documentation</p> <p>Fund or share class identifiers for easy connection to other fund or share class data</p>  |

element **EMIR\_ReportType/DataSupplier**

|                   |  |
|-------------------|--|
| <p>diagram</p>    |  |
| <p>type</p>       | <p><a href="#">DataSupplierType</a></p>  |
| <p>properties</p> | <p>isRef 0<br/> minOcc 0<br/> maxOcc 1<br/> content complex</p>  |
| <p>children</p>   | <p><a href="#">SystemCountry</a> <a href="#">Short</a> <a href="#">Name</a> <a href="#">Type</a> <a href="#">Contact</a></p> |
| <p>annotation</p> | <p>documentation<br/> Definition of data source (investment company, vendor, ...)</p>  |

element **EMIR\_ReportType/CounterpartyData**

diagram

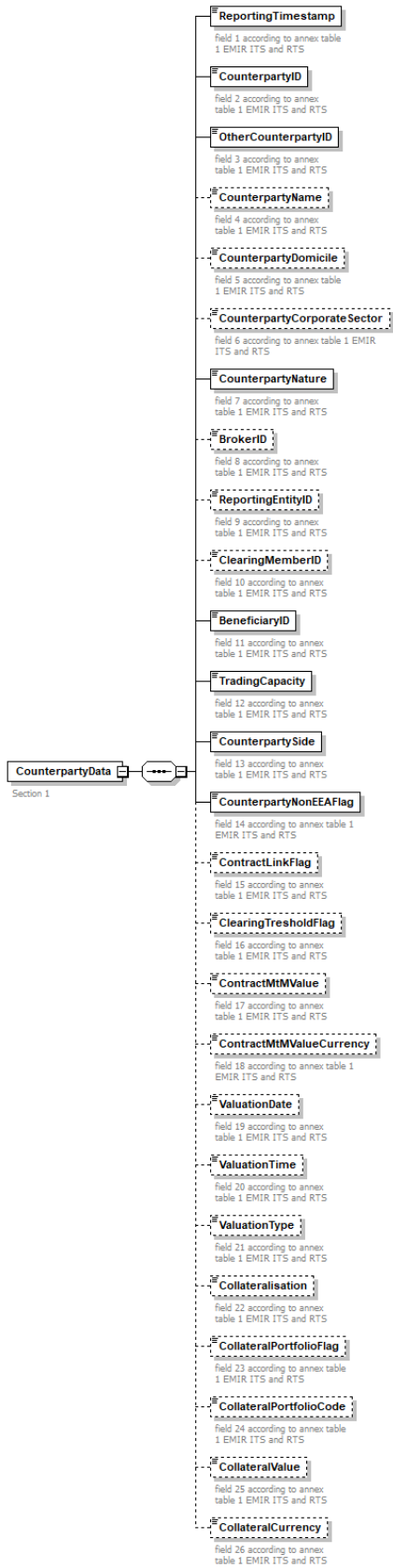

|            |   |
|------------|---|
| properties | isRef 0<br>content complex  |
| children   | <a href="#">ReportingTimestamp</a> <a href="#">CounterpartyID</a> <a href="#">OtherCounterpartyID</a> <a href="#">CounterpartyName</a> <a href="#">CounterpartyDomicile</a> <a href="#">CounterpartyCorporateSector</a> <a href="#">CounterpartyNature</a> <a href="#">BrokerID</a> <a href="#">ReportingEntityID</a> <a href="#">ClearingMemberID</a> <a href="#">BeneficiaryID</a> <a href="#">TradingCapacity</a> <a href="#">CounterpartySide</a> <a href="#">CounterpartyNonEEAFlag</a> <a href="#">ContractLinkFlag</a> <a href="#">ClearingTresholdFlag</a> <a href="#">ContractMtMValue</a> <a href="#">ContractMtMValueCurrency</a> <a href="#">ValuationDate</a> <a href="#">ValuationTime</a> <a href="#">ValuationType</a> <a href="#">Collateralisation</a> <a href="#">CollateralPortfolioFlag</a> <a href="#">CollateralPortfolioCode</a> <a href="#">CollateralValue</a> <a href="#">CollateralCurrency</a> |
| annotation | documentation<br>Section 1  |

element **EMIR\_ReportType/CounterpartyData/ReportingTimestamp**

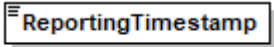
|            |  |
|------------|--|
| diagram    | <br>field 1 according to annex table 1 EMIR ITS and RTS |
| type       | <b>xs:dateTime</b>   |
| properties | isRef 0<br>content simple  |
| annotation | documentation<br>field 1 according to annex table 1 EMIR ITS and RTS   |

element **EMIR\_ReportType/CounterpartyData/CounterpartyID**

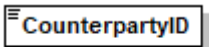
|            |  |
|------------|--|
| diagram    | <br>field 2 according to annex table 1 EMIR ITS and RTS |
| type       | <a href="#">EMIRIDType</a>   |
| properties | isRef 0<br>content simple  |
| facets     | Kind Value annotation<br>minLength 11<br>maxLength 50  |
| annotation | documentation<br>field 2 according to annex table 1 EMIR ITS and RTS   |

element **EMIR\_ReportType/CounterpartyData/OtherCounterpartyID**

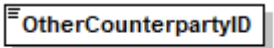
|            |  |
|------------|--|
| diagram    | <br>field 3 according to annex table 1 EMIR ITS and RTS |
| type       | <a href="#">EMIRIDType</a>   |
| properties | isRef 0<br>content simple  |
| facets     | Kind Value annotation<br>minLength 11<br>maxLength 50  |
| annotation | documentation<br>field 3 according to annex table 1 EMIR ITS and RTS   |

element **EMIR\_ReportType/CounterpartyData/CounterpartyName**

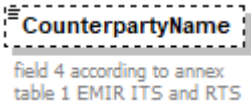
|            |   |
|------------|---|
| diagram    |  |
| type       | restriction of <b>xs:string</b>   |
| properties | isRef 0<br>minOcc 0<br>maxOcc 1<br>content simple                                 |
| facets     | Kind Value annotation<br>maxLength 100  |
| annotation | documentation<br>field 4 according to annex table 1 EMIR ITS and RTS              |

element **EMIR\_ReportType/CounterpartyData/CounterpartyDomicile**

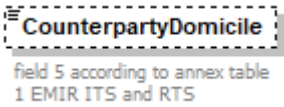
|            |   |
|------------|---|
| diagram    |  |
| type       | restriction of <b>xs:string</b>   |
| properties | isRef 0<br>minOcc 0<br>maxOcc 1<br>content simple                                 |
| facets     | Kind Value annotation<br>maxLength 500  |
| annotation | documentation<br>field 5 according to annex table 1 EMIR ITS and RTS              |

element **EMIR\_ReportType/CounterpartyData/CounterpartyCorporateSector**

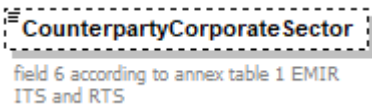
|            |   |
|------------|---|
| diagram    |  |
| type       | restriction of <b>xs:string</b>   |
| properties | isRef 0<br>minOcc 0<br>maxOcc 1<br>content simple                                   |
| facets     | Kind Value annotation<br>maxLength 1  |
| annotation | documentation<br>field 6 according to annex table 1 EMIR ITS and RTS                |

element **EMIR\_ReportType/CounterpartyData/CounterpartyNature**

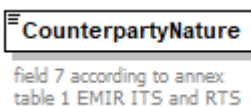
|         |   |
|---------|---|
| diagram |  |
| type    | restriction of <b>xs:string</b>   |



|            |  |
|------------|--|
| properties | isRef 0<br>content simple  |
| facets     | Kind Value annotation<br>maxLength 1                                 |
| annotation | documentation<br>field 7 according to annex table 1 EMIR ITS and RTS |

element **EMIR\_ReportType/CounterpartyData/BrokerID**

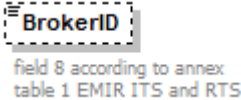
|            |   |
|------------|---|
| diagram    |  |
| type       | <a href="#">EMIRIDType</a>  |
| properties | isRef 0<br>minOcc 0<br>maxOcc 1<br>content simple                                 |
| facets     | Kind Value annotation<br>minLength 11<br>maxLength 50                             |
| annotation | documentation<br>field 8 according to annex table 1 EMIR ITS and RTS              |

element **EMIR\_ReportType/CounterpartyData/ReportingEntityID**

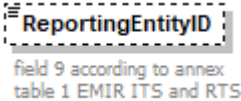
|            |   |
|------------|---|
| diagram    |  |
| type       | <a href="#">EMIRIDType</a>  |
| properties | isRef 0<br>minOcc 0<br>maxOcc 1<br>content simple                                   |
| facets     | Kind Value annotation<br>minLength 11<br>maxLength 50                               |
| annotation | documentation<br>field 9 according to annex table 1 EMIR ITS and RTS                |

element **EMIR\_ReportType/CounterpartyData/ClearingMemberID**

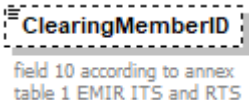
|            |   |
|------------|---|
| diagram    |  |
| type       | <a href="#">EMIRIDType</a>  |
| properties | isRef 0<br>minOcc 0<br>maxOcc 1<br>content simple                                   |
| facets     | Kind Value annotation<br>minLength 11   |

|            |   |
|------------|---|
|            | maxLength 50  |
| annotation | documentation<br>field 10 according to annex table 1 EMIR ITS and RTS |

element **EMIR\_ReportType/CounterpartyData/BeneficiaryID**

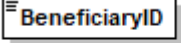
|            |   |
|------------|---|
| diagram    |  <p>field 11 according to annex table 1 EMIR ITS and RTS</p> |
| type       | <a href="#">EMIRIDType</a>  |
| properties | isRef 0<br>content simple   |
| facets     | Kind Value annotation<br>minLength 11<br>maxLength 50   |
| annotation | documentation<br>field 11 according to annex table 1 EMIR ITS and RTS   |

element **EMIR\_ReportType/CounterpartyData/TradingCapacity**

|            |   |
|------------|---|
| diagram    |  <p>field 12 according to annex table 1 EMIR ITS and RTS</p> |
| type       | restriction of <b>xs:string</b>   |
| properties | isRef 0<br>content simple   |
| facets     | Kind Value annotation<br>maxLength 1  |
| annotation | documentation<br>field 12 according to annex table 1 EMIR ITS and RTS   |

element **EMIR\_ReportType/CounterpartyData/CounterpartySide**

|            |  |
|------------|--|
| diagram    |  <p>field 13 according to annex table 1 EMIR ITS and RTS</p> |
| type       | restriction of <b>xs:string</b>  |
| properties | isRef 0<br>content simple  |
| facets     | Kind Value annotation<br>maxLength 1   |
| annotation | documentation<br>field 13 according to annex table 1 EMIR ITS and RTS  |

element **EMIR\_ReportType/CounterpartyData/CounterpartyNonEEAFlag**

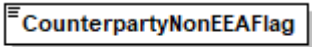
|            |   |
|------------|---|
| diagram    |  <p>field 14 according to annex table 1 EMIR ITS and RTS</p> |
| type       | <b>xs:boolean</b>   |
| properties | isRef 0<br>content simple   |
| annotation | documentation<br>field 14 according to annex table 1 EMIR ITS and RTS   |

element **EMIR\_ReportType/CounterpartyData/ContractLinkFlag**

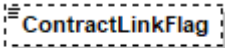
|            |   |
|------------|---|
| diagram    |  <p>field 15 according to annex table 1 EMIR ITS and RTS</p> |
| type       | <b>xs:boolean</b>   |
| properties | isRef 0<br>minOcc 0<br>maxOcc 1<br>content simple   |
| annotation | documentation<br>field 15 according to annex table 1 EMIR ITS and RTS   |

element **EMIR\_ReportType/CounterpartyData/ClearingTresholdFlag**

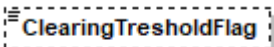
|            |   |
|------------|---|
| diagram    |  <p>field 16 according to annex table 1 EMIR ITS and RTS</p> |
| type       | <b>xs:boolean</b>   |
| properties | isRef 0<br>minOcc 0<br>maxOcc 1<br>content simple   |
| annotation | documentation<br>field 16 according to annex table 1 EMIR ITS and RTS   |

element **EMIR\_ReportType/CounterpartyData/ContractMtMValue**

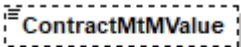
|            |   |
|------------|---|
| diagram    |  <p>field 17 according to annex table 1 EMIR ITS and RTS</p> |
| type       | <b>xs:decimal</b>   |
| properties | isRef 0<br>minOcc 0<br>maxOcc 1<br>content simple   |
| annotation | documentation<br>field 17 according to annex table 1 EMIR ITS and RTS   |

element **EMIR\_ReportType/CounterpartyData/ContractMtMValueCurrency**

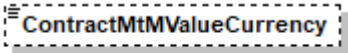
|            |   |
|------------|---|
| diagram    |  <p>field 18 according to annex table 1 EMIR ITS and RTS</p> |
| type       | <a href="#">ISOCurrencyCodeType</a>   |
| properties | isRef 0<br>minOcc 0<br>maxOcc 1<br>content simple   |
| facets     | Kind Value annotation<br>minLength 3<br>maxLength 3<br>pattern [A-Z]{3}   |
| annotation | documentation<br>field 18 according to annex table 1 EMIR ITS and RTS   |

element **EMIR\_ReportType/CounterpartyData/ValuationDate**

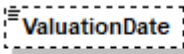
|            |   |
|------------|---|
| diagram    |  <p>field 19 according to annex table 1 EMIR ITS and RTS</p> |
| type       | <b>xs:date</b>  |
| properties | isRef 0<br>minOcc 0<br>maxOcc 1<br>content simple   |
| annotation | documentation<br>field 19 according to annex table 1 EMIR ITS and RTS   |

element **EMIR\_ReportType/CounterpartyData/ValuationTime**

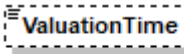
|            |   |
|------------|---|
| diagram    |  <p>field 20 according to annex table 1 EMIR ITS and RTS</p> |
| type       | <b>xs:time</b>  |
| properties | isRef 0<br>minOcc 0<br>maxOcc 1<br>content simple   |
| annotation | documentation<br>field 20 according to annex table 1 EMIR ITS and RTS   |

element **EMIR\_ReportType/CounterpartyData/ValuationType**

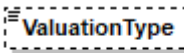
|            |   |
|------------|---|
| diagram    |  <p>field 21 according to annex table 1 EMIR ITS and RTS</p> |
| type       | restriction of <b>xs:string</b>   |
| properties | isRef 0<br>minOcc 0   |

|            |   |
|------------|---|
|            | maxOcc 1<br>content simple  |
| facets     | Kind Value annotation<br>maxLength 1                                  |
| annotation | documentation<br>field 21 according to annex table 1 EMIR ITS and RTS |

element **EMIR\_ReportType/CounterpartyData/Collateralisation**

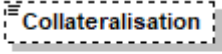
|            |   |
|------------|---|
| diagram    | <br>field 22 according to annex table 1 EMIR ITS and RTS |
| type       | restriction of <b>xs:string</b>   |
| properties | isRef 0<br>minOcc 0<br>maxOcc 1<br>content simple   |
| facets     | Kind Value annotation<br>maxLength 2  |
| annotation | documentation<br>field 22 according to annex table 1 EMIR ITS and RTS   |

element **EMIR\_ReportType/CounterpartyData/CollateralPortfolioFlag**

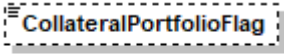
|            |  |
|------------|--|
| diagram    | <br>field 23 according to annex table 1 EMIR ITS and RTS |
| type       | <b>xs:boolean</b>  |
| properties | isRef 0<br>minOcc 0<br>maxOcc 1<br>content simple  |
| annotation | documentation<br>field 23 according to annex table 1 EMIR ITS and RTS  |

element **EMIR\_ReportType/CounterpartyData/CollateralPortfolioCode**

|            |   |
|------------|---|
| diagram    | <br>field 24 according to annex table 1 EMIR ITS and RTS |
| type       | restriction of <b>xs:nonNegativeInteger</b>   |
| properties | isRef 0<br>minOcc 0<br>maxOcc 1<br>content simple   |
| facets     | Kind Value annotation<br>totalDigits 10   |
| annotation | documentation<br>field 24 according to annex table 1 EMIR ITS and RTS   |

element **EMIR\_ReportType/CounterpartyData/CollateralValue**

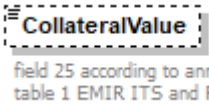
|            |   |
|------------|---|
| diagram    |  |
| type       | <b>xs:decimal</b>   |
| properties | isRef 0<br>minOcc 0<br>maxOcc 1<br>content simple                                 |
| annotation | documentation<br>field 25 according to annex table 1 EMIR ITS and RTS             |

element **EMIR\_ReportType/CounterpartyData/CollateralCurrency**

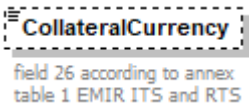
|            |   |            |       |            |           |   |  |           |   |  |         |          |  |
|------------|---|------------|-------|------------|-----------|---|--|-----------|---|--|---------|----------|--|
| diagram    |    |            |       |            |           |   |  |           |   |  |         |          |  |
| type       | <a href="#"><b>ISOCurrencyCodeType</b></a>  |            |       |            |           |   |  |           |   |  |         |          |  |
| properties | isRef 0<br>minOcc 0<br>maxOcc 1<br>content simple   |            |       |            |           |   |  |           |   |  |         |          |  |
| facets     | <table border="0"> <tr> <td>Kind</td> <td>Value</td> <td>annotation</td> </tr> <tr> <td>minLength</td> <td>3</td> <td></td> </tr> <tr> <td>maxLength</td> <td>3</td> <td></td> </tr> <tr> <td>pattern</td> <td>[A-Z]{3}</td> <td></td> </tr> </table> | Kind       | Value | annotation | minLength | 3 |  | maxLength | 3 |  | pattern | [A-Z]{3} |  |
| Kind       | Value   | annotation |       |            |           |   |  |           |   |  |         |          |  |
| minLength  | 3   |            |       |            |           |   |  |           |   |  |         |          |  |
| maxLength  | 3   |            |       |            |           |   |  |           |   |  |         |          |  |
| pattern    | [A-Z]{3}  |            |       |            |           |   |  |           |   |  |         |          |  |
| annotation | documentation<br>field 26 according to annex table 1 EMIR ITS and RTS   |            |       |            |           |   |  |           |   |  |         |          |  |

element **EMIR\_ReportType/CommonData**

|                   |   |
|-------------------|---|
| <p>diagram</p>    |   |
| <p>properties</p> | <p>isRef 0<br/>content complex</p>  |
| <p>children</p>   | <p><a href="#">ContractType</a> <a href="#">TransactionDetails</a> <a href="#">RiskMitigationReporting</a> <a href="#">Clearing</a> <a href="#">InterestRates</a> <a href="#">ForeignExchange</a> <a href="#">Commodities</a> <a href="#">Options</a> <a href="#">ReportModifications</a></p> |
| <p>annotation</p> | <p>documentation<br/>Section 2</p>  |

element **EMIR\_ReportType/CommonData/ContractType**

|            |  |
|------------|--|
| diagram    | <p><b>ContractType</b><br/>Section 2a</p> <ul style="list-style-type: none"> <li><b>TaxonomyUsed</b><br/>field 1 according to annex table 2 EMIR ITS and RTS</li> <li><b>ProductID1</b><br/>field 2 according to annex table 2 EMIR ITS and RTS</li> <li><b>ProductID2</b><br/>field 3 according to annex table 2 EMIR ITS and RTS</li> <li><b>Underlying</b><br/>field 4 according to annex table 2 EMIR ITS and RTS</li> <li><b>NotionalCurrency1</b><br/>field 5 according to annex table 2 EMIR ITS and RTS</li> <li><b>NotionalCurrency2</b><br/>field 6 according to annex table 2 EMIR ITS and RTS</li> <li><b>DeliverableCurrency</b><br/>field 7 according to annex table 2 EMIR ITS and RTS</li> </ul> |
| properties | isRef 0<br>content complex   |
| children   | <a href="#">TaxonomyUsed</a> <a href="#">ProductID1</a> <a href="#">ProductID2</a> <a href="#">Underlying</a> <a href="#">NotionalCurrency1</a> <a href="#">NotionalCurrency2</a> <a href="#">DeliverableCurrency</a>  |
| annotation | documentation<br>Section 2a  |

element **EMIR\_ReportType/CommonData/ContractType/TaxonomyUsed**

|            |  |
|------------|--|
| diagram    | <p><b>TaxonomyUsed</b><br/>field 1 according to annex table 2 EMIR ITS and RTS</p> |
| type       | restriction of <b>xs:string</b>  |
| properties | isRef 0<br>content simple  |
| facets     | Kind Value annotation<br>maxLength 1   |
| annotation | documentation<br>field 1 according to annex table 2 EMIR ITS and RTS               |

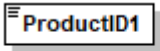

element **EMIR\_ReportType/CommonData/ContractType/ProductID1**

|            |  |
|------------|--|
| diagram    |  <p>field 2 according to annex<br/>table 2 EMIR ITS and RTS</p> |
| type       | restriction of <b>xs:string</b>  |
| properties | isRef 0<br>content simple  |
| facets     | Kind Value annotation<br>maxLength 2   |
| annotation | documentation<br>field 2 according to annex table 2 EMIR ITS and RTS   |

element **EMIR\_ReportType/CommonData/ContractType/ProductID2**

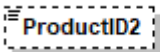
|            |  |
|------------|--|
| diagram    |  <p>field 3 according to annex<br/>table 2 EMIR ITS and RTS</p> |
| type       | restriction of <b>xs:string</b>  |
| properties | isRef 0<br>minOcc 0<br>maxOcc 1<br>content simple  |
| facets     | Kind Value annotation<br>maxLength 2   |
| annotation | documentation<br>field 3 according to annex table 2 EMIR ITS and RTS   |

element **EMIR\_ReportType/CommonData/ContractType/Underlying**

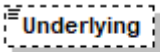
|            |  |
|------------|--|
| diagram    |  <p>field 4 according to annex<br/>table 2 EMIR ITS and RTS</p> |
| type       | restriction of <b>xs:string</b>  |
| properties | isRef 0<br>minOcc 0<br>maxOcc 1<br>content simple  |
| facets     | Kind Value annotation<br>maxLength 20  |
| annotation | documentation<br>field 4 according to annex table 2 EMIR ITS and RTS   |

element **EMIR\_ReportType/CommonData/ContractType/NotionalCurrency1**

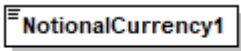
|            |  |
|------------|--|
| diagram    |  <p>field 5 according to annex<br/>table 2 EMIR ITS and RTS</p> |
| type       | <a href="#">ISOCurrencyCodeType</a>  |
| properties | isRef 0  |

|            |   |
|------------|---|
|            | content simple  |
| facets     | Kind Value annotation<br>minLength 3<br>maxLength 3<br>pattern [A-Z]{3} |
| annotation | documentation<br>field 5 according to annex table 2 EMIR ITS and RTS    |

element **EMIR\_ReportType/CommonData/ContractType/NotionalCurrency2**

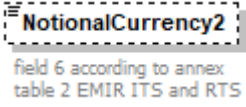
|            |   |
|------------|---|
| diagram    |  |
| type       | <a href="#">ISOCurrencyCodeType</a>   |
| properties | isRef 0<br>minOcc 0<br>maxOcc 1<br>content simple                                 |
| facets     | Kind Value annotation<br>minLength 3<br>maxLength 3<br>pattern [A-Z]{3}           |
| annotation | documentation<br>field 6 according to annex table 2 EMIR ITS and RTS              |

element **EMIR\_ReportType/CommonData/ContractType/DeliverableCurrency**

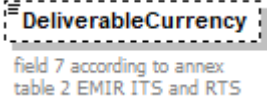
|            |   |
|------------|---|
| diagram    |  |
| type       | <a href="#">ISOCurrencyCodeType</a>   |
| properties | isRef 0<br>minOcc 0<br>maxOcc 1<br>content simple                                   |
| facets     | Kind Value annotation<br>minLength 3<br>maxLength 3<br>pattern [A-Z]{3}             |
| annotation | documentation<br>field 7 according to annex table 2 EMIR ITS and RTS                |

element **EMIR\_ReportType/CommonData/TransactionDetails**

diagram

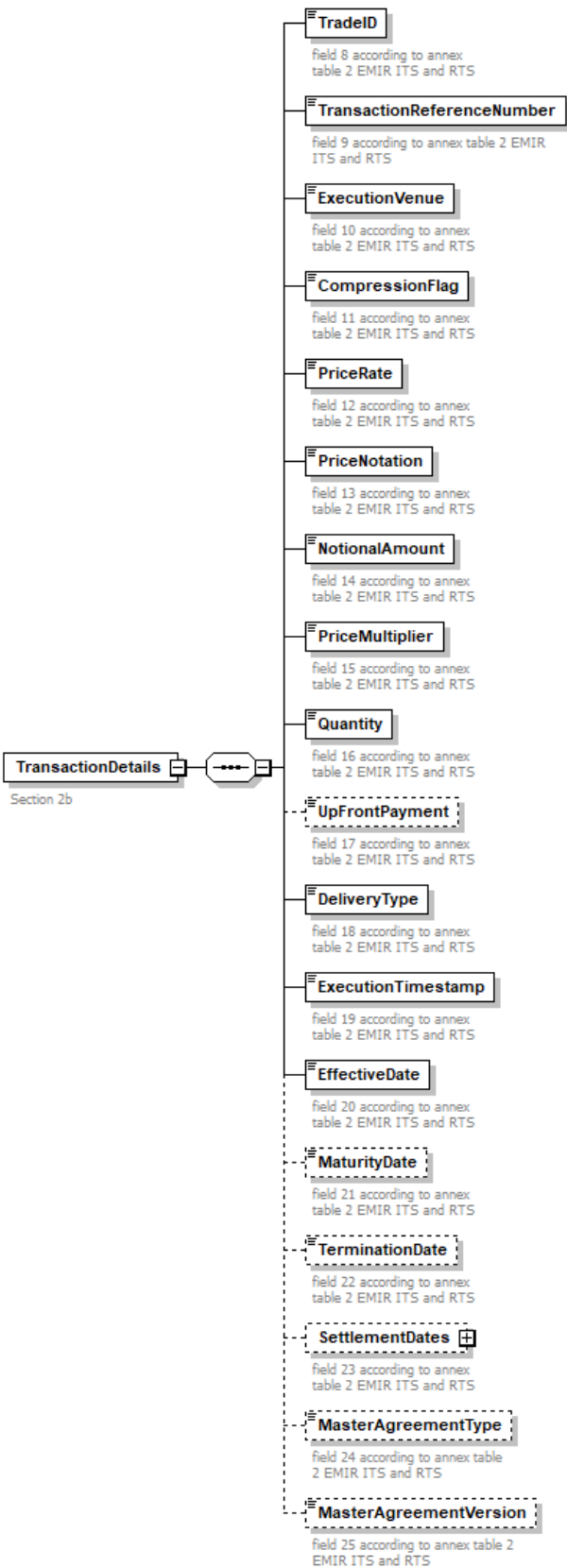

|            |  |
|------------|--|
| properties | isRef 0<br>content complex   |
| children   | <a href="#">TradeID</a> <a href="#">TransactionReferenceNumber</a> <a href="#">ExecutionVenue</a> <a href="#">CompressionFlag</a> <a href="#">PriceRate</a> <a href="#">PriceNotation</a> <a href="#">NotionalAmount</a> <a href="#">PriceMultiplier</a> <a href="#">Quantity</a> <a href="#">UpFrontPayment</a> <a href="#">DeliveryType</a> <a href="#">ExecutionTimestamp</a> <a href="#">EffectiveDate</a> <a href="#">MaturityDate</a> <a href="#">TerminationDate</a> <a href="#">SettlementDates</a> <a href="#">MasterAgreementType</a> <a href="#">MasterAgreementVersion</a> |
| annotation | documentation<br>Section 2b  |

element **EMIR\_ReportType/CommonData/TransactionDetails/TradeID**

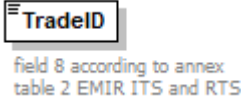
|            |   |
|------------|---|
| diagram    |  |
| type       | restriction of <b>xs:string</b>   |
| properties | isRef 0<br>content simple   |
| facets     | Kind Value annotation<br>maxLength 52   |
| annotation | documentation<br>field 8 according to annex table 2 EMIR ITS and RTS              |

element **EMIR\_ReportType/CommonData/TransactionDetails/TransactionReferenceNumber**

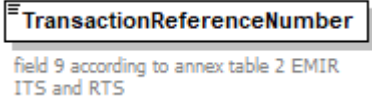
|            |  |
|------------|--|
| diagram    |  |
| type       | restriction of <b>xs:string</b>  |
| properties | isRef 0<br>content simple  |
| facets     | Kind Value annotation<br>maxLength 40  |
| annotation | documentation<br>field 9 according to annex table 2 EMIR ITS and RTS               |

element **EMIR\_ReportType/CommonData/TransactionDetails/ExecutionVenue**

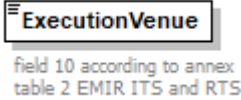
|            |   |
|------------|---|
| diagram    |  |
| type       | restriction of <b>xs:string</b>   |
| properties | isRef 0<br>content simple   |
| facets     | Kind Value annotation<br>maxLength 4  |
| annotation | documentation<br>field 10 according to annex table 2 EMIR ITS and RTS               |

element **EMIR\_ReportType/CommonData/TransactionDetails/CompressionFlag**

|            |   |
|------------|---|
| diagram    |  <p>field 11 according to annex table 2 EMIR ITS and RTS</p> |
| type       | <b>xs:boolean</b>   |
| properties | isRef 0<br>content simple   |
| annotation | documentation<br>field 11 according to annex table 2 EMIR ITS and RTS   |

element **EMIR\_ReportType/CommonData/TransactionDetails/PriceRate**

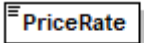
|            |   |
|------------|---|
| diagram    |  <p>field 12 according to annex table 2 EMIR ITS and RTS</p> |
| type       | <b>xs:decimal</b>   |
| properties | isRef 0<br>content simple   |
| annotation | documentation<br>field 12 according to annex table 2 EMIR ITS and RTS   |

element **EMIR\_ReportType/CommonData/TransactionDetails/PriceNotation**

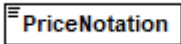
|            |   |            |       |            |           |   |  |           |   |  |         |          |  |
|------------|---|------------|-------|------------|-----------|---|--|-----------|---|--|---------|----------|--|
| diagram    |  <p>field 13 according to annex table 2 EMIR ITS and RTS</p>   |            |       |            |           |   |  |           |   |  |         |          |  |
| type       | <a href="#">ISOCurrencyCodeType</a>   |            |       |            |           |   |  |           |   |  |         |          |  |
| properties | isRef 0<br>content simple   |            |       |            |           |   |  |           |   |  |         |          |  |
| facets     | <table border="0"> <tr> <td>Kind</td> <td>Value</td> <td>annotation</td> </tr> <tr> <td>minLength</td> <td>3</td> <td></td> </tr> <tr> <td>maxLength</td> <td>3</td> <td></td> </tr> <tr> <td>pattern</td> <td>[A-Z]{3}</td> <td></td> </tr> </table> | Kind       | Value | annotation | minLength | 3 |  | maxLength | 3 |  | pattern | [A-Z]{3} |  |
| Kind       | Value   | annotation |       |            |           |   |  |           |   |  |         |          |  |
| minLength  | 3   |            |       |            |           |   |  |           |   |  |         |          |  |
| maxLength  | 3   |            |       |            |           |   |  |           |   |  |         |          |  |
| pattern    | [A-Z]{3}  |            |       |            |           |   |  |           |   |  |         |          |  |
| annotation | documentation<br>field 13 according to annex table 2 EMIR ITS and RTS   |            |       |            |           |   |  |           |   |  |         |          |  |

element **EMIR\_ReportType/CommonData/TransactionDetails/NotionalAmount**

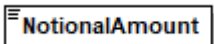
|            |   |
|------------|---|
| diagram    |  <p>field 14 according to annex table 2 EMIR ITS and RTS</p> |
| type       | <b>xs:decimal</b>   |
| properties | isRef 0<br>content simple   |
| annotation | documentation<br>field 14 according to annex table 2 EMIR ITS and RTS   |

element **EMIR\_ReportType/CommonData/TransactionDetails/PriceMultiplier**

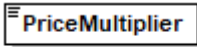
|            |   |
|------------|---|
| diagram    |  <p>field 15 according to annex table 2 EMIR ITS and RTS</p> |
| type       | <b>xs:decimal</b>   |
| properties | isRef 0<br>content simple   |
| annotation | documentation<br>field 15 according to annex table 2 EMIR ITS and RTS   |

element **EMIR\_ReportType/CommonData/TransactionDetails/Quantity**

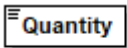
|            |   |
|------------|---|
| diagram    |  <p>field 16 according to annex table 2 EMIR ITS and RTS</p> |
| type       | <b>xs:decimal</b>   |
| properties | isRef 0<br>content simple   |
| annotation | documentation<br>field 16 according to annex table 2 EMIR ITS and RTS   |

element **EMIR\_ReportType/CommonData/TransactionDetails/UpFrontPayment**

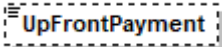
|            |   |
|------------|---|
| diagram    |  <p>field 17 according to annex table 2 EMIR ITS and RTS</p> |
| type       | <b>xs:decimal</b>   |
| properties | isRef 0<br>minOcc 0<br>maxOcc 1<br>content simple   |
| annotation | documentation<br>field 17 according to annex table 2 EMIR ITS and RTS   |

element **EMIR\_ReportType/CommonData/TransactionDetails/DeliveryType**

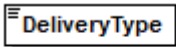
|            |   |
|------------|---|
| diagram    |  <p>field 18 according to annex table 2 EMIR ITS and RTS</p> |
| type       | restriction of <b>xs:string</b>   |
| properties | isRef 0<br>content simple   |
| facets     | Kind Value annotation<br>maxLength 1  |
| annotation | documentation<br>field 18 according to annex table 2 EMIR ITS and RTS   |

element **EMIR\_ReportType/CommonData/TransactionDetails/ExecutionTimestamp**

|            |   |
|------------|---|
| diagram    |  <p>field 19 according to annex<br/>table 2 EMIR ITS and RTS</p> |
| type       | <b>xs:dateTime</b>  |
| properties | isRef 0<br>content simple   |
| annotation | documentation<br>field 19 according to annex table 2 EMIR ITS and RTS   |

element **EMIR\_ReportType/CommonData/TransactionDetails/EffectiveDate**

|            |   |
|------------|---|
| diagram    |  <p>field 20 according to annex<br/>table 2 EMIR ITS and RTS</p> |
| type       | <b>xs:date</b>  |
| properties | isRef 0<br>content simple   |
| annotation | documentation<br>field 20 according to annex table 2 EMIR ITS and RTS   |

element **EMIR\_ReportType/CommonData/TransactionDetails/MaturityDate**

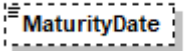
|            |   |
|------------|---|
| diagram    |  <p>field 21 according to annex<br/>table 2 EMIR ITS and RTS</p> |
| type       | <b>xs:date</b>  |
| properties | isRef 0<br>minOcc 0<br>maxOcc 1<br>content simple   |
| annotation | documentation<br>field 21 according to annex table 2 EMIR ITS and RTS   |

element **EMIR\_ReportType/CommonData/TransactionDetails/TerminationDate**

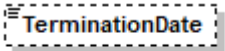
|            |   |
|------------|---|
| diagram    |  <p>field 22 according to annex<br/>table 2 EMIR ITS and RTS</p> |
| type       | <b>xs:date</b>  |
| properties | isRef 0<br>minOcc 0<br>maxOcc 1<br>content simple   |
| annotation | documentation<br>field 22 according to annex table 2 EMIR ITS and RTS   |

element **EMIR\_ReportType/CommonData/TransactionDetails/SettlementDates**

|            |  |
|------------|--|
| diagram    | <p>field 23 according to annex table 2 EMIR ITS and RTS</p> <p>ISO 8601 date format.</p> |
| properties | isRef 0<br>minOcc 0<br>maxOcc 1<br>content complex                                       |
| children   | <a href="#">SettlementDate</a>   |
| annotation | documentation<br>field 23 according to annex table 2 EMIR ITS and RTS                    |

element **EMIR\_ReportType/CommonData/TransactionDetails/SettlementDates/SettlementDate**

|            |   |
|------------|---|
| diagram    | <p>ISO 8601 date format.</p>                              |
| type       | <b>xs:date</b>  |
| properties | isRef 0<br>minOcc 1<br>maxOcc unbounded<br>content simple |
| annotation | documentation<br>ISO 8601 date format.                    |

element **EMIR\_ReportType/CommonData/TransactionDetails/MasterAgreementType**

|            |   |            |       |            |           |    |  |
|------------|---|------------|-------|------------|-----------|----|--|
| diagram    | <p>field 24 according to annex table 2 EMIR ITS and RTS</p>   |            |       |            |           |    |  |
| type       | restriction of <b>xs:string</b>   |            |       |            |           |    |  |
| properties | isRef 0<br>minOcc 0<br>maxOcc 1<br>content simple   |            |       |            |           |    |  |
| facets     | <table border="0"> <tr> <td>Kind</td> <td>Value</td> <td>annotation</td> </tr> <tr> <td>maxLength</td> <td>50</td> <td></td> </tr> </table> | Kind       | Value | annotation | maxLength | 50 |  |
| Kind       | Value   | annotation |       |            |           |    |  |
| maxLength  | 50  |            |       |            |           |    |  |
| annotation | documentation<br>field 24 according to annex table 2 EMIR ITS and RTS   |            |       |            |           |    |  |

element **EMIR\_ReportType/CommonData/TransactionDetails/MasterAgreementVersion**

|            |   |
|------------|---|
| diagram    | <p>field 25 according to annex table 2 EMIR ITS and RTS</p> |
| type       | restriction of <b>xs:positiveInteger</b>                    |
| properties | isRef 0<br>minOcc 0<br>maxOcc 1<br>content simple           |



|            |   |
|------------|---|
| facets     | Kind Value annotation<br>totalDigits 4                                |
| annotation | documentation<br>field 25 according to annex table 2 EMIR ITS and RTS |

element **EMIR\_ReportType/CommonData/RiskMitigationReporting**

|            |   |
|------------|---|
| diagram    |   |
| properties | isRef 0<br>content complex  |
| children   | <a href="#">ConfirmationTimestamp</a> <a href="#">ConfirmationMeans</a> |
| annotation | documentation<br>Section 2c   |

element **EMIR\_ReportType/CommonData/RiskMitigationReporting/ConfirmationTimestamp**

|            |   |
|------------|---|
| diagram    |   |
| type       | <b>xs:dateTime</b>  |
| properties | isRef 0<br>minOcc 0<br>maxOcc 1<br>content simple                     |
| annotation | documentation<br>field 26 according to annex table 2 EMIR ITS and RTS |

element **EMIR\_ReportType/CommonData/RiskMitigationReporting/ConfirmationMeans**

|            |                                 |
|------------|---------------------------------|
| diagram    |                                 |
| type       | restriction of <b>xs:string</b> |
| properties | isRef 0<br>content simple       |

|            |  |
|------------|--|
| facets     | Kind Value annotation<br>maxLength 1   |
| annotation | documentation<br>27 Whether the contract was electronically confirmed, non-electronically confirmed or remains unconfirmed.<br><br>Y=Non-electronically confirmed, N=Non-confirmed,<br>E=Electronically confirmed. |

element **EMIR\_ReportType/CommonData/Clearing**

|            |  |
|------------|--|
| diagram    | <p>The diagram shows a 'Clearing' element (Section 2d) containing five sub-elements: ClearingObligationFlag (field 28), ClearedFlag (field 29), ClearingTimestamp (field 30), CcpID (field 31), and IntragroupFlag (field 32).</p> |
| properties | isRef 0<br>content complex   |
| children   | <a href="#">ClearingObligationFlag</a> <a href="#">ClearedFlag</a> <a href="#">ClearingTimestamp</a> <a href="#">CcpID</a> <a href="#">IntragroupFlag</a>  |
| annotation | documentation<br>Section 2d  |

element **EMIR\_ReportType/CommonData/Clearing/ClearingObligationFlag**

|            |   |
|------------|---|
| diagram    | <p>The diagram shows a 'ClearingObligationFlag' element (field 28).</p> |
| type       | <b>xs:boolean</b>   |
| properties | isRef 0<br>content simple   |
| annotation | documentation<br>field 28 according to annex table 2 EMIR ITS and RTS   |

element **EMIR\_ReportType/CommonData/Clearing/ClearedFlag**

|         |  |
|---------|--|
| diagram | <p>The diagram shows a 'ClearedFlag' element (field 29).</p> |
|---------|--|

|            |   |
|------------|---|
| type       | <b>xs:boolean</b>   |
| properties | isRef 0<br>content simple   |
| annotation | documentation<br>field 29 according to annex table 2 EMIR ITS and RTS |

element **EMIR\_ReportType/CommonData/Clearing/ClearingTimestamp**

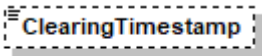
|            |   |
|------------|---|
| diagram    |  <p>field 30 according to annex table 2 EMIR ITS and RTS</p> |
| type       | <b>xs:dateTime</b>  |
| properties | isRef 0<br>minOcc 0<br>maxOcc 1<br>content simple   |
| annotation | documentation<br>field 30 according to annex table 2 EMIR ITS and RTS   |

element **EMIR\_ReportType/CommonData/Clearing/CcpID**

|            |   |
|------------|---|
| diagram    |  <p>field 31 according to annex table 2 EMIR ITS and RTS</p> |
| type       | restriction of <b>xs:string</b>   |
| properties | isRef 0<br>minOcc 0<br>maxOcc 1<br>content simple   |
| facets     | Kind Value annotation<br>maxLength 20   |
| annotation | documentation<br>field 31 according to annex table 2 EMIR ITS and RTS   |

element **EMIR\_ReportType/CommonData/Clearing/IntragroupFlag**

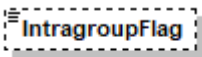
|            |   |
|------------|---|
| diagram    |  <p>field 32 according to annex table 2 EMIR ITS and RTS</p> |
| type       | <b>xs:boolean</b>   |
| properties | isRef 0<br>minOcc 0<br>maxOcc 1<br>content simple   |
| annotation | documentation<br>field 32 according to annex table 2 EMIR ITS and RTS   |

element **EMIR\_ReportType/CommonData/InterestRates**

|                   |  |
|-------------------|--|
| <p>diagram</p>    | <p><b>InterestRates</b><br/>Section 2e</p> <ul style="list-style-type: none"> <li><b>FixedRateLeg1</b><br/>field 33 according to annex table 2 EMIR ITS and RTS</li> <li><b>FixedRateLeg2</b><br/>field 34 according to annex table 2 EMIR ITS and RTS</li> <li><b>FixedRateDayCount</b><br/>field 35 according to annex table 2 EMIR ITS and RTS</li> <li><b>FixedLegPaymentFrequency</b><br/>field 36 according to annex table 2 EMIR ITS and RTS</li> <li><b>FloatingRatePaymentFrequency</b><br/>field 37 according to annex table 2 EMIR ITS and RTS</li> <li><b>FloatingRateResetFrequency</b><br/>field 38 according to annex table 2 EMIR ITS and RTS</li> <li><b>FloatingRateLeg1</b><br/>field 39 according to annex table 2 EMIR ITS and RTS</li> <li><b>FloatingRateLeg2</b><br/>field 40 according to annex table 2 EMIR ITS and RTS</li> </ul> |
| <p>properties</p> | <p>isRef 0<br/>minOcc 0<br/>maxOcc 1<br/>content complex</p>   |
| <p>children</p>   | <p><a href="#">FixedRateLeg1</a> <a href="#">FixedRateLeg2</a> <a href="#">FixedRateDayCount</a> <a href="#">FixedLegPaymentFrequency</a> <a href="#">FloatingRatePaymentFrequency</a> <a href="#">FloatingRateResetFrequency</a> <a href="#">FloatingRateLeg1</a> <a href="#">FloatingRateLeg2</a></p>  |
| <p>annotation</p> | <p>documentation<br/>Section 2e</p>  |

element **EMIR\_ReportType/CommonData/InterestRates/FixedRateLeg1**

|                   |  |
|-------------------|--|
| <p>diagram</p>    | <p><b>FixedRateLeg1</b><br/>field 33 according to annex table 2 EMIR ITS and RTS</p> |
| <p>type</p>       | <p><b>xs:decimal</b></p>   |
| <p>properties</p> | <p>isRef 0<br/>minOcc 0<br/>maxOcc 1<br/>content simple</p>                          |
| <p>annotation</p> | <p>documentation<br/>field 33 according to annex table 2 EMIR ITS and RTS</p>        |

element **EMIR\_ReportType/CommonData/InterestRates/FixedRateLeg2**

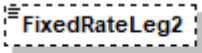
|            |   |
|------------|---|
| diagram    |  <p>field 34 according to annex table 2 EMIR ITS and RTS</p> |
| type       | <b>xs:decimal</b>   |
| properties | isRef 0<br>minOcc 0<br>maxOcc 1<br>content simple   |
| annotation | documentation<br>field 34 according to annex table 2 EMIR ITS and RTS   |

element **EMIR\_ReportType/CommonData/InterestRates/FixedRateDayCount**

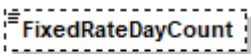
|            |   |
|------------|---|
| diagram    |  <p>field 35 according to annex table 2 EMIR ITS and RTS</p> |
| type       | <b>xs:string</b>  |
| properties | isRef 0<br>minOcc 0<br>maxOcc 1<br>content simple   |
| annotation | documentation<br>field 35 according to annex table 2 EMIR ITS and RTS   |

element **EMIR\_ReportType/CommonData/InterestRates/FixedLegPaymentFrequency**

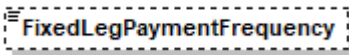
|            |   |
|------------|---|
| diagram    |  <p>field 36 according to annex table 2 EMIR ITS and RTS</p> |
| type       | <b>xs:string</b>  |
| properties | isRef 0<br>minOcc 0<br>maxOcc 1<br>content simple   |
| annotation | documentation<br>field 36 according to annex table 2 EMIR ITS and RTS   |

element **EMIR\_ReportType/CommonData/InterestRates/FloatingRatePaymentFrequency**

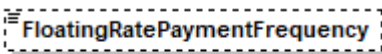
|            |   |
|------------|---|
| diagram    |  <p>field 37 according to annex table 2 EMIR ITS and RTS</p> |
| type       | <b>xs:string</b>  |
| properties | isRef 0<br>minOcc 0<br>maxOcc 1<br>content simple   |
| annotation | documentation<br>field 37 according to annex table 2 EMIR ITS and RTS   |

element **EMIR\_ReportType/CommonData/InterestRates/FloatingRateResetFrequency**

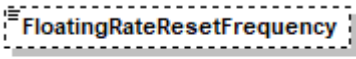
|            |   |
|------------|---|
| diagram    |  <p>field 38 according to annex table 2 EMIR ITS and RTS</p> |
| type       | <b>xs:string</b>  |
| properties | isRef 0<br>minOcc 0<br>maxOcc 1<br>content simple   |
| annotation | documentation<br>field 38 according to annex table 2 EMIR ITS and RTS   |

element **EMIR\_ReportType/CommonData/InterestRates/FloatingRateLeg1**

|            |   |
|------------|---|
| diagram    |  <p>field 39 according to annex table 2 EMIR ITS and RTS</p> |
| type       | <b>xs:string</b>  |
| properties | isRef 0<br>minOcc 0<br>maxOcc 1<br>content simple   |
| annotation | documentation<br>field 39 according to annex table 2 EMIR ITS and RTS   |

element **EMIR\_ReportType/CommonData/InterestRates/FloatingRateLeg2**

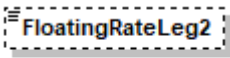
|            |   |
|------------|---|
| diagram    |  <p>field 40 according to annex table 2 EMIR ITS and RTS</p> |
| type       | <b>xs:string</b>  |
| properties | isRef 0<br>minOcc 0<br>maxOcc 1<br>content simple   |
| annotation | documentation<br>field 40 according to annex table 2 EMIR ITS and RTS   |

element **EMIR\_ReportType/CommonData/ForeignExchange**

|            |  |
|------------|--|
| diagram    | <p><b>ForeignExchange</b><br/>Section 2f</p> <p><b>Currency2</b><br/>field 41 according to annex table 2 EMIR ITS and RTS</p> <p><b>ExchangeRate1</b><br/>field 42 according to annex table 2 EMIR ITS and RTS</p> <p><b>ForwardExchangeRate</b><br/>field 43 according to annex table 2 EMIR ITS and RTS</p> <p><b>ExchangeRateBasis</b><br/>field 44 according to annex table 2 EMIR ITS and RTS</p> |
| properties | <p>isRef 0</p> <p>minOcc 0</p> <p>maxOcc 1</p> <p>content complex</p>  |
| children   | <p><a href="#">Currency2</a> <a href="#">ExchangeRate1</a> <a href="#">ForwardExchangeRate</a> <a href="#">ExchangeRateBasis</a></p>   |
| annotation | <p>documentation<br/>Section 2f</p>  |

element **EMIR\_ReportType/CommonData/ForeignExchange/Currency2**

|            |   |            |       |            |           |   |  |           |   |  |         |          |  |
|------------|---|------------|-------|------------|-----------|---|--|-----------|---|--|---------|----------|--|
| diagram    | <p><b>Currency2</b><br/>field 41 according to annex table 2 EMIR ITS and RTS</p>  |            |       |            |           |   |  |           |   |  |         |          |  |
| type       | <p><a href="#">ISOCurrencyCodeType</a></p>  |            |       |            |           |   |  |           |   |  |         |          |  |
| properties | <p>isRef 0</p> <p>minOcc 0</p> <p>maxOcc 1</p> <p>content simple</p>  |            |       |            |           |   |  |           |   |  |         |          |  |
| facets     | <table border="0"> <tr> <td>Kind</td> <td>Value</td> <td>annotation</td> </tr> <tr> <td>minLength</td> <td>3</td> <td></td> </tr> <tr> <td>maxLength</td> <td>3</td> <td></td> </tr> <tr> <td>pattern</td> <td>[A-Z]{3}</td> <td></td> </tr> </table> | Kind       | Value | annotation | minLength | 3 |  | maxLength | 3 |  | pattern | [A-Z]{3} |  |
| Kind       | Value   | annotation |       |            |           |   |  |           |   |  |         |          |  |
| minLength  | 3   |            |       |            |           |   |  |           |   |  |         |          |  |
| maxLength  | 3   |            |       |            |           |   |  |           |   |  |         |          |  |
| pattern    | [A-Z]{3}  |            |       |            |           |   |  |           |   |  |         |          |  |
| annotation | <p>documentation<br/>field 41 according to annex table 2 EMIR ITS and RTS</p>   |            |       |            |           |   |  |           |   |  |         |          |  |

element **EMIR\_ReportType/CommonData/ForeignExchange/ExchangeRate1**

|            |  |
|------------|--|
| diagram    | <p><b>ExchangeRate1</b><br/>field 42 according to annex table 2 EMIR ITS and RTS</p> |
| type       | <p><b>xs:decimal</b></p>   |
| properties | <p>isRef 0</p> <p>minOcc 0</p> <p>maxOcc 1</p> <p>content simple</p>                 |

|            |   |
|------------|---|
| annotation | documentation<br>field 42 according to annex table 2 EMIR ITS and RTS |
|------------|---|

element **EMIR\_ReportType/CommonData/ForeignExchange/ForwardExchangeRate**

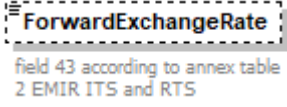
|            |   |
|------------|---|
| diagram    |  |
| type       | <b>xs:decimal</b>   |
| properties | isRef 0<br>minOcc 0<br>maxOcc 1<br>content simple                                 |
| annotation | documentation<br>field 43 according to annex table 2 EMIR ITS and RTS             |

element **EMIR\_ReportType/CommonData/ForeignExchange/ExchangeRateBasis**

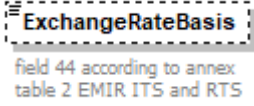
|            |   |
|------------|---|
| diagram    |  |
| type       | restriction of <b>xs:string</b>   |
| properties | isRef 0<br>minOcc 0<br>maxOcc 1<br>content simple                                 |
| facets     | Kind Value annotation<br>maxLength 7  |
| annotation | documentation<br>field 44 according to annex table 2 EMIR ITS and RTS             |

element **EMIR\_ReportType/CommonData/Commodities**

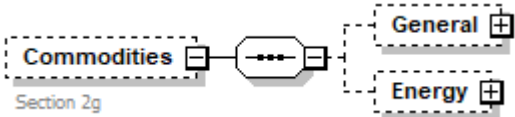
|            |   |
|------------|---|
| diagram    |  |
| properties | isRef 0<br>minOcc 0<br>maxOcc 1<br>content complex                                  |
| children   | <a href="#">General</a> <a href="#">Energy</a>                                      |
| annotation | documentation<br>Section 2g   |



element **EMIR\_ReportType/CommonData/Commodities/General**

|            |  |
|------------|--|
| diagram    |  |
| properties | isRef 0<br>minOcc 0<br>maxOcc 1<br>content complex             |
| children   | <a href="#">CommodityBase</a> <a href="#">CommodityDetails</a> |

element **EMIR\_ReportType/CommonData/Commodities/General/CommodityBase**

|            |   |
|------------|---|
| diagram    |   |
| type       | restriction of <b>xs:string</b>                                       |
| properties | isRef 0<br>minOcc 0<br>maxOcc 1<br>content simple                     |
| facets     | Kind Value annotation<br>maxLength 2                                  |
| annotation | documentation<br>field 45 according to annex table 2 EMIR ITS and RTS |

element **EMIR\_ReportType/CommonData/Commodities/General/CommodityDetails**

|            |   |
|------------|---|
| diagram    |   |
| type       | restriction of <b>xs:string</b>                                       |
| properties | isRef 0<br>minOcc 0<br>maxOcc 1<br>content simple                     |
| facets     | Kind Value annotation<br>maxLength 2                                  |
| annotation | documentation<br>field 46 according to annex table 2 EMIR ITS and RTS |

element **EMIR\_ReportType/CommonData/Commodities/Energy**

|            |   |
|------------|---|
| diagram    | <p>The diagram shows the 'Energy' element connected to three other elements: 'DeliveryPoint', 'InterconnectionPoint', and 'LoadTypes'. 'DeliveryPoint' is associated with field 47, 'InterconnectionPoint' with field 48, and 'LoadTypes' with field 49. The cardinality for 'LoadTypes' is 0..∞.</p> |
| properties | <p>isRef 0<br/> minOcc 0<br/> maxOcc 1<br/> content complex</p>   |
| children   | <p><a href="#">DeliveryPoint</a> <a href="#">InterconnectionPoint</a> <a href="#">LoadTypes</a></p>   |

element **EMIR\_ReportType/CommonData/Commodities/Energy/DeliveryPoint**

| diagram    | <p>The diagram shows the 'DeliveryPoint' element associated with field 47.</p>  |            |       |            |           |    |  |
|------------|---|------------|-------|------------|-----------|----|--|
| type       | <p>restriction of <b>xs:string</b></p>  |            |       |            |           |    |  |
| properties | <p>isRef 0<br/> minOcc 0<br/> maxOcc 1<br/> content simple</p>  |            |       |            |           |    |  |
| facets     | <table border="1"> <thead> <tr> <th>Kind</th> <th>Value</th> <th>annotation</th> </tr> </thead> <tbody> <tr> <td>maxLength</td> <td>16</td> <td></td> </tr> </tbody> </table> | Kind       | Value | annotation | maxLength | 16 |  |
| Kind       | Value   | annotation |       |            |           |    |  |
| maxLength  | 16  |            |       |            |           |    |  |
| annotation | <p>documentation<br/> field 47 according to annex table 2 EMIR ITS and RTS</p>  |            |       |            |           |    |  |

element **EMIR\_ReportType/CommonData/Commodities/Energy/InterconnectionPoint**

| diagram    | <p>The diagram shows the 'InterconnectionPoint' element associated with field 48.</p>   |            |       |            |           |    |  |
|------------|---|------------|-------|------------|-----------|----|--|
| type       | <p>restriction of <b>xs:string</b></p>  |            |       |            |           |    |  |
| properties | <p>isRef 0<br/> minOcc 0<br/> maxOcc 1<br/> content simple</p>  |            |       |            |           |    |  |
| facets     | <table border="1"> <thead> <tr> <th>Kind</th> <th>Value</th> <th>annotation</th> </tr> </thead> <tbody> <tr> <td>maxLength</td> <td>50</td> <td></td> </tr> </tbody> </table> | Kind       | Value | annotation | maxLength | 50 |  |
| Kind       | Value   | annotation |       |            |           |    |  |
| maxLength  | 50  |            |       |            |           |    |  |
| annotation | <p>documentation<br/> field 48 according to annex table 2 EMIR ITS and RTS</p>  |            |       |            |           |    |  |

element **EMIR\_ReportType/CommonData/Commodities/Energy/LoadTypes**

|            |  |
|------------|--|
| diagram    |  |
| properties | isRef 0<br>minOcc 0<br>maxOcc unbounded<br>content complex   |
| children   | <a href="#">LoadType</a> <a href="#">DeliveryStart</a> <a href="#">DeliveryEnd</a> <a href="#">ContractCapacity</a> <a href="#">QuantityUnit</a> <a href="#">PriceTimeIntervalQuantities</a> |
| annotation | documentation<br>field 49 according to annex table 2 EMIR ITS and RTS  |

element **EMIR\_ReportType/CommonData/Commodities/Energy/LoadTypes/LoadType**

|            |   |
|------------|---|
| diagram    |   |
| type       | restriction of <b>xs:string</b>                                       |
| properties | isRef 0<br>minOcc 0<br>maxOcc 1<br>content simple                     |
| facets     | Kind Value annotation<br>maxLength 2                                  |
| annotation | documentation<br>field 49 according to annex table 2 EMIR ITS and RTS |

element **EMIR\_ReportType/CommonData/Commodities/Energy/LoadTypes/DeliveryStart**

|         |  |
|---------|--|
| diagram |  |
|---------|--|

|            |   |
|------------|---|
| type       | <b>xs:dateTime</b>  |
| properties | isRef 0<br>minOcc 0<br>maxOcc 1<br>content simple                     |
| annotation | documentation<br>field 50 according to annex table 2 EMIR ITS and RTS |

element **EMIR\_ReportType/CommonData/Commodities/Energy/LoadTypes/DeliveryEnd**

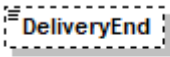
|            |   |
|------------|---|
| diagram    | <br>field 51 according to annex table 2 EMIR ITS and RTS |
| type       | <b>xs:dateTime</b>  |
| properties | isRef 0<br>minOcc 0<br>maxOcc 1<br>content simple   |
| annotation | documentation<br>field 51 according to annex table 2 EMIR ITS and RTS   |

element **EMIR\_ReportType/CommonData/Commodities/Energy/LoadTypes/ContractCapacity**

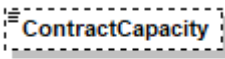
|            |   |
|------------|---|
| diagram    | <br>field 52 according to annex table 2 EMIR ITS and RTS |
| type       | restriction of <b>xs:string</b>   |
| properties | isRef 0<br>minOcc 0<br>maxOcc 1<br>content simple   |
| facets     | Kind Value annotation<br>maxLength 50   |
| annotation | documentation<br>field 52 according to annex table 2 EMIR ITS and RTS   |

element **EMIR\_ReportType/CommonData/Commodities/Energy/LoadTypes/QuantityUnit**

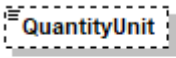
|            |   |
|------------|---|
| diagram    | <br>field 53 according to annex table 2 EMIR ITS and RTS |
| type       | <b>xs:decimal</b>   |
| properties | isRef 0<br>minOcc 0<br>maxOcc 1<br>content simple   |
| annotation | documentation<br>field 53 according to annex table 2 EMIR ITS and RTS   |

element **EMIR\_ReportType/CommonData/Commodities/Energy/LoadTypes/PriceTimeIntervalQuantities**

|            |  |
|------------|--|
| diagram    |  <p><b>PriceTimeIntervalQuantities</b><br/>field 54 according to annex table 2 EMIR ITS and RTS</p> |
| type       | <b>xs:decimal</b>  |
| properties | isRef 0<br>minOcc 0<br>maxOcc 1<br>content simple  |
| annotation | documentation<br>field 54 according to annex table 2 EMIR ITS and RTS  |

element **EMIR\_ReportType/CommonData/Options**

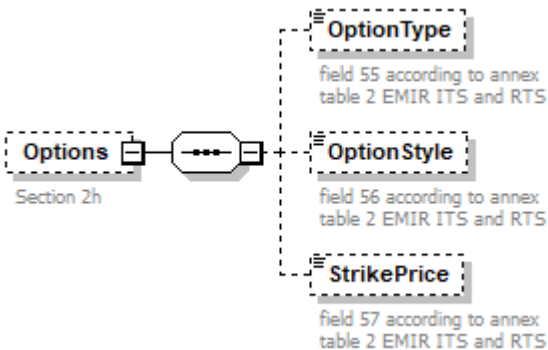
|            |   |
|------------|---|
| diagram    |  <p><b>Options</b> Section 2h</p> <p><b>OptionType</b><br/>field 55 according to annex table 2 EMIR ITS and RTS</p> <p><b>OptionStyle</b><br/>field 56 according to annex table 2 EMIR ITS and RTS</p> <p><b>StrikePrice</b><br/>field 57 according to annex table 2 EMIR ITS and RTS</p> |
| properties | isRef 0<br>minOcc 0<br>maxOcc 1<br>content complex  |
| children   | <a href="#">OptionType</a> <a href="#">OptionStyle</a> <a href="#">StrikePrice</a>  |
| annotation | documentation<br>Section 2h   |

element **EMIR\_ReportType/CommonData/Options/OptionType**

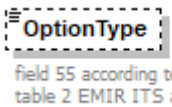
|            |   |
|------------|---|
| diagram    |  <p><b>OptionType</b><br/>field 55 according to annex table 2 EMIR ITS and RTS</p> |
| type       | restriction of <b>xs:string</b>   |
| properties | isRef 0<br>minOcc 0<br>maxOcc 1<br>content simple   |
| annotation | documentation<br>field 55 according to annex table 2 EMIR ITS and RTS   |

element **EMIR\_ReportType/CommonData/Options/OptionStyle**

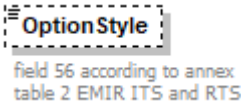
|            |   |
|------------|---|
| diagram    |  |
| type       | restriction of <b>xs:string</b>   |
| properties | isRef 0<br>minOcc 0<br>maxOcc 1<br>content simple                                 |
| facets     | Kind Value annotation<br>maxLength 1  |
| annotation | documentation<br>field 56 according to annex table 2 EMIR ITS and RTS             |

element **EMIR\_ReportType/CommonData/Options/StrikePrice**

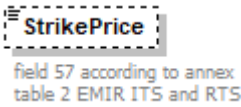
|            |   |
|------------|---|
| diagram    |  |
| type       | <b>xs:decimal</b>   |
| properties | isRef 0<br>minOcc 0<br>maxOcc 1<br>content simple                                 |
| annotation | documentation<br>field 57 according to annex table 2 EMIR ITS and RTS             |

element **EMIR\_ReportType/CommonData/ReportModifications**

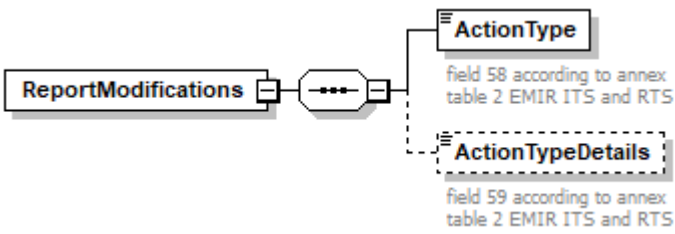
|            |   |
|------------|---|
| diagram    |  |
| properties | isRef 0<br>content complex  |
| children   | <a href="#">ActionType</a> <a href="#">ActionTypeDetails</a>                        |

element **EMIR\_ReportType/CommonData/ReportModifications/ActionType**

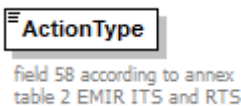
|            |   |
|------------|---|
| diagram    |  |
| type       | restriction of <b>xs:string</b>   |
| properties | isRef 0<br>content simple   |
| facets     | Kind Value annotation   |

|            |   |
|------------|---|
|            | maxLength 1   |
| annotation | documentation<br>field 58 according to annex table 2 EMIR ITS and RTS |

element **EMIR\_ReportType/CommonData/ReportModifications/ActionTypeDetails**

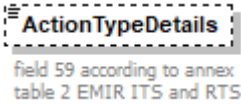
|            |   |
|------------|---|
| diagram    |  |
| type       | restriction of <b>xs:string</b>   |
| properties | isRef 0<br>minOcc 0<br>maxOcc 1<br>content simple                                 |
| facets     | Kind Value annotation<br>maxLength 50   |
| annotation | documentation<br>field 59 according to annex table 2 EMIR ITS and RTS             |

complexType **EMIRType**

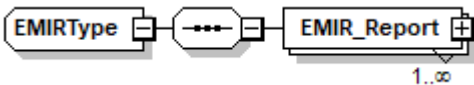
|          |   |
|----------|---|
| diagram  |  |
| children | <a href="#">EMIR_Report</a>   |
| used by  | element <a href="#">DirectReportingType/EMIR</a>                                  |

element **EMIRType/EMIR\_Report**

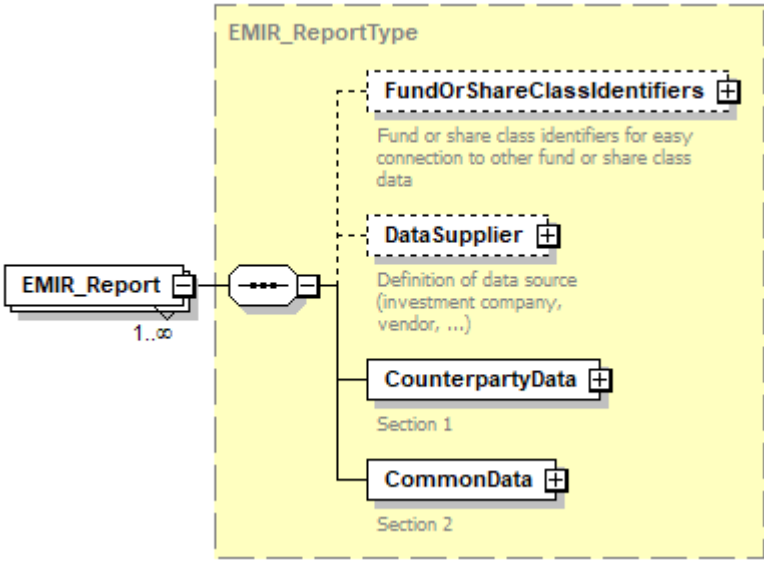
|            |  |
|------------|--|
| diagram    |  |
| type       | <a href="#">EMIR_ReportType</a>  |
| properties | isRef 0<br>minOcc 1  |

|          |  |
|----------|--|
|          | maxOcc unbounded<br>content complex  |
| children | <a href="#">FundOrShareClassIdentifiers</a> <a href="#">DataSupplier</a> <a href="#">CounterpartyData</a> <a href="#">CommonData</a> |

simpleType **EMIRIDType**

|            |   |
|------------|---|
| type       | restriction of <b>xs:string</b>   |
| properties | base <b>xs:string</b>   |
| used by    | elements <a href="#">EMIR_ReportType/CounterpartyData/BeneficiaryID</a> <a href="#">EMIR_ReportType/CounterpartyData/BrokerID</a><br><a href="#">EMIR_ReportType/CounterpartyData/ClearingMemberID</a><br><a href="#">EMIR_ReportType/CounterpartyData/CounterpartyID</a><br><a href="#">EMIR_ReportType/CounterpartyData/OtherCounterpartyID</a><br><a href="#">EMIR_ReportType/CounterpartyData/ReportingEntityID</a> |
| facets     | Kind Value annotation<br>minLength 11<br>maxLength 50   |

complexType **EMT\_V3\_FinancialInstrumentType**

|          |  |
|----------|--|
| diagram  | <pre> classDiagram     class EMT_V3_FinancialInstrumentType     class FundOrShareClassIdentifiers     class DataSupplier     class DataSetInformation     class GeneralInformation     class TargetMarket     class CostsAndChargesExAnte     class CostsAndChargesExPost     class CountrySpecificData      EMT_V3_FinancialInstrumentType -- FundOrShareClassIdentifiers     EMT_V3_FinancialInstrumentType -- DataSupplier     EMT_V3_FinancialInstrumentType -- DataSetInformation     EMT_V3_FinancialInstrumentType -- GeneralInformation     EMT_V3_FinancialInstrumentType -- TargetMarket     EMT_V3_FinancialInstrumentType -- CostsAndChargesExAnte     EMT_V3_FinancialInstrumentType -- CostsAndChargesExPost     EMT_V3_FinancialInstrumentType -- CountrySpecificData     </pre> <p><b>FundOrShareClassIdentifiers</b> +<br/>Fund or share class identifiers for easy connection to other fund or share class data</p> <p><b>DataSupplier</b> +<br/>Definition of data source (investment company, vendor, ...)</p> <p><b>DataSetInformation</b> +</p> <p><b>GeneralInformation</b> +<br/>General Financial Instrument Information</p> <p><b>TargetMarket</b> +</p> <p><b>CostsAndChargesExAnte</b> +<br/>Costs and Charges ex ante</p> <p><b>CostsAndChargesExPost</b> +<br/>Costs and Charges ex post</p> <p><b>CountrySpecificData</b> +</p> |
| children | <a href="#">FundOrShareClassIdentifiers</a> <a href="#">DataSupplier</a> <a href="#">DataSetInformation</a> <a href="#">GeneralInformation</a> <a href="#">TargetMarket</a> <a href="#">CostsAndChargesExAnte</a> <a href="#">CostsAndChargesExPost</a> <a href="#">CountrySpecificData</a>  |
| used by  | element <a href="#">EMTType V3/FinancialInstrument</a>   |



element **EMT\_V3\_FinancialInstrumentType/FundOrShareClassIdentifiers**

|            |  |
|------------|--|
| diagram    |  |
| type       | <a href="#">FundOrShareClassIdentifiersType</a>  |
| properties | isRef 0<br>minOcc 0<br>maxOcc 1<br>content complex   |
| children   | <a href="#">LEI</a> <a href="#">ISINs</a>  |
| annotation | documentation<br>Fund or share class identifiers for easy connection to other fund or share class data |

element **EMT\_V3\_FinancialInstrumentType/DataSupplier**

|            |   |
|------------|---|
| diagram    |   |
| type       | <a href="#">DataSupplierType</a>  |
| properties | isRef 0<br>minOcc 0<br>maxOcc 1<br>content complex  |
| children   | <a href="#">SystemCountry</a> <a href="#">Short</a> <a href="#">Name</a> <a href="#">Type</a> <a href="#">Contact</a> |
| annotation | documentation<br>Definition of data source (investment company, vendor, ...)  |

element **EMT\_V3\_FinancialInstrumentType/DataSetInformation**

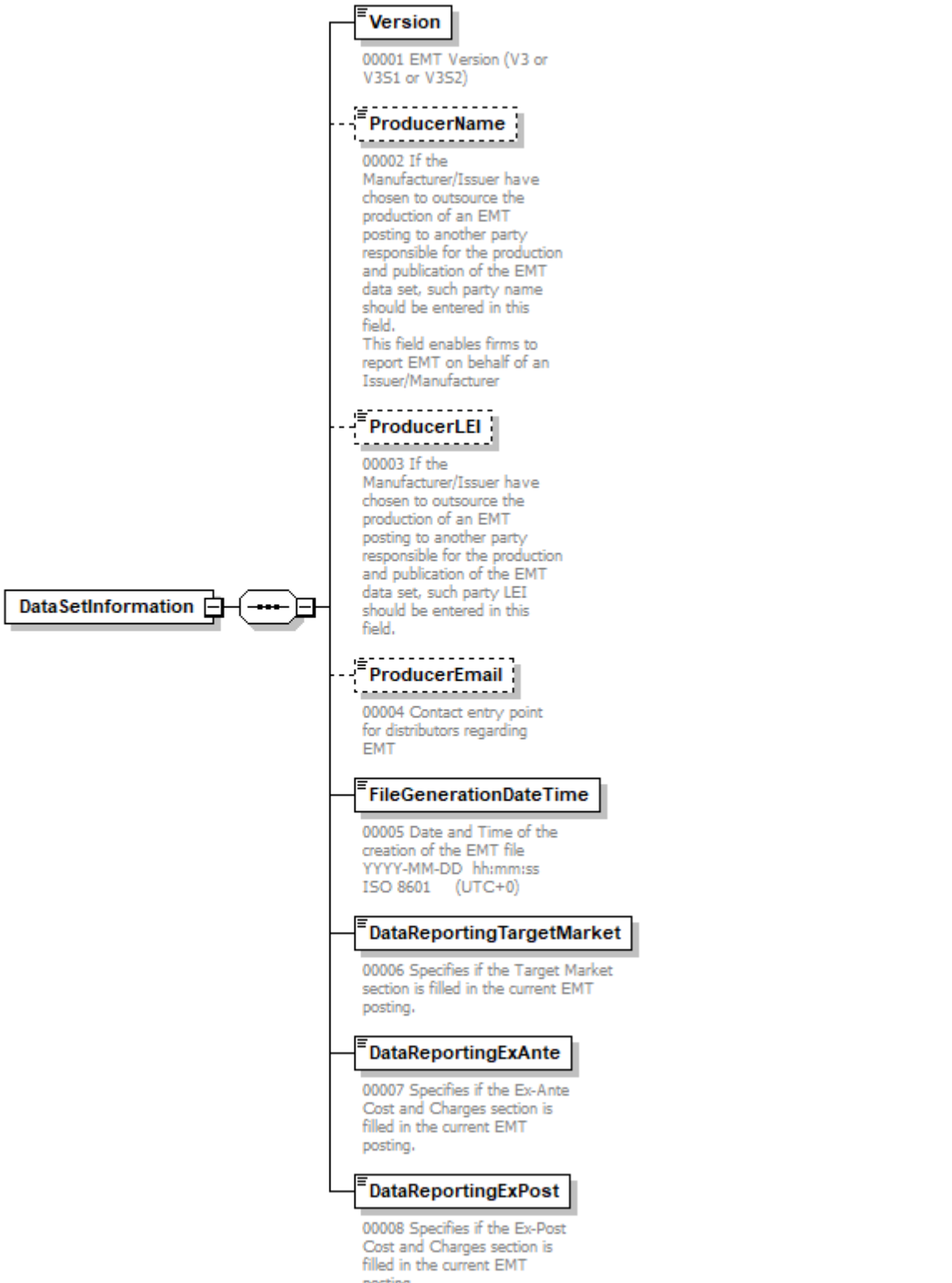
|   |   |
|---|---|
| <p>diagram</p>  <p>The diagram illustrates the structure of the <b>DataSetInformation</b> element. It is represented as a rectangular box on the left, connected by a line to a central connector symbol (a circle with three dots). From this connector, lines branch out to eight sub-elements, each in its own box:</p> <ul style="list-style-type: none"> <li><b>Version</b>: A solid box containing the text "00001 EMT Version (V3 or V351 or V352)".</li> <li><b>ProducerName</b>: A dashed box containing the text "00002 If the Manufacturer/Issuer have chosen to outsource the production of an EMT posting to another party responsible for the production and publication of the EMT data set, such party name should be entered in this field. This field enables firms to report EMT on behalf of an Issuer/Manufacturer".</li> <li><b>ProducerLEI</b>: A dashed box containing the text "00003 If the Manufacturer/Issuer have chosen to outsource the production of an EMT posting to another party responsible for the production and publication of the EMT data set, such party LEI should be entered in this field.".</li> <li><b>ProducerEmail</b>: A dashed box containing the text "00004 Contact entry point for distributors regarding EMT".</li> <li><b>FileGenerationDateTime</b>: A solid box containing the text "00005 Date and Time of the creation of the EMT file YYYY-MM-DD hh:mm:ss ISO 8601 (UTC+0)".</li> <li><b>DataReportingTargetMarket</b>: A solid box containing the text "00006 Specifies if the Target Market section is filled in the current EMT posting.".</li> <li><b>DataReportingExAnte</b>: A solid box containing the text "00007 Specifies if the Ex-Ante Cost and Charges section is filled in the current EMT posting.".</li> <li><b>DataReportingExPost</b>: A solid box containing the text "00008 Specifies if the Ex-Post Cost and Charges section is filled in the current EMT posting.".</li> </ul> | <p><b>Version</b></p> <p>00001 EMT Version (V3 or V351 or V352)</p> <p><b>ProducerName</b></p> <p>00002 If the Manufacturer/Issuer have chosen to outsource the production of an EMT posting to another party responsible for the production and publication of the EMT data set, such party name should be entered in this field.<br/>This field enables firms to report EMT on behalf of an Issuer/Manufacturer</p> <p><b>ProducerLEI</b></p> <p>00003 If the Manufacturer/Issuer have chosen to outsource the production of an EMT posting to another party responsible for the production and publication of the EMT data set, such party LEI should be entered in this field.</p> <p><b>ProducerEmail</b></p> <p>00004 Contact entry point for distributors regarding EMT</p> <p><b>FileGenerationDateTime</b></p> <p>00005 Date and Time of the creation of the EMT file<br/>YYYY-MM-DD hh:mm:ss<br/>ISO 8601 (UTC+0)</p> <p><b>DataReportingTargetMarket</b></p> <p>00006 Specifies if the Target Market section is filled in the current EMT posting.</p> <p><b>DataReportingExAnte</b></p> <p>00007 Specifies if the Ex-Ante Cost and Charges section is filled in the current EMT posting.</p> <p><b>DataReportingExPost</b></p> <p>00008 Specifies if the Ex-Post Cost and Charges section is filled in the current EMT posting.</p> |
| <p>properties</p>   | <p>isRef 0<br/>content complex</p>  |

|          |   |
|----------|---|
| children | <a href="#">Version</a> <a href="#">ProducerName</a> <a href="#">ProducerLEI</a> <a href="#">ProducerEmail</a> <a href="#">FileGenerationDateTime</a> <a href="#">DataReportingTargetMarket</a> <a href="#">DataReportingExAnte</a> <a href="#">DataReportingExPost</a> |
|----------|---|

element **EMT\_V3\_FinancialInstrumentType/DataSetInformation/Version**

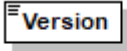
|            |   |
|------------|---|
| diagram    |  <p>00001 EMT Version (V3 or V3S1 or V3S2)</p> |
| type       | restriction of <b>xs:string</b>   |
| properties | isRef 0<br>content simple   |
| facets     | Kind Value annotation<br>minLength 2<br>maxLength 4   |
| annotation | documentation<br>00001 EMT Version (V3 or V3S1 or V3S2)   |

element **EMT\_V3\_FinancialInstrumentType/DataSetInformation/ProducerName**

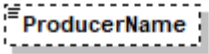
|            |  |
|------------|--|
| diagram    |  <p>00002 If the Manufacturer/Issuer have chosen to outsource the production of an EMT posting to another party responsible for the production and publication of the EMT data set, such party name should be entered in this field.<br/>This field enables firms to report EMT on behalf of an Issuer/Manufacturer</p> |
| type       | restriction of <b>xs:string</b>  |
| properties | isRef 0<br>minOcc 0<br>maxOcc 1<br>content simple  |
| facets     | Kind Value annotation<br>maxLength 255   |
| annotation | documentation<br>00002 If the Manufacturer/Issuer have chosen to outsource the production of an EMT posting to another party responsible for the production and publication of the EMT data set, such party name should be entered in this field.<br>This field enables firms to report EMT on behalf of an Issuer/Manufacturer  |

element **EMT\_V3\_FinancialInstrumentType/DataSetInformation/ProducerLEI**

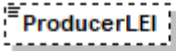
|            |  |
|------------|--|
| diagram    |  <p>00003 If the Manufacturer/Issuer have chosen to outsource the production of an EMT posting to another party responsible for the production and publication of the EMT data set, such party LEI should be entered in this field.</p> |
| type       | <a href="#">LEICodeType</a>  |
| properties | <p>isRef 0<br/> minOcc 0<br/> maxOcc 1<br/> content simple</p>   |
| facets     | <p>Kind Value annotation<br/> minLength 20<br/> maxLength 20<br/> pattern ([0-9a-zA-Z]{18}[0-9]{2})</p>  |
| annotation | <p>documentation<br/> 00003 If the Manufacturer/Issuer have chosen to outsource the production of an EMT posting to another party responsible for the production and publication of the EMT data set, such party LEI should be entered in this field.</p>  |

element **EMT\_V3\_FinancialInstrumentType/DataSetInformation/ProducerEmail**

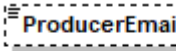
|            |   |
|------------|---|
| diagram    |  <p>00004 Contact entry point for distributors regarding EMT</p> |
| type       | <a href="#">EmailAddressType</a>  |
| properties | <p>isRef 0<br/> minOcc 0<br/> maxOcc 1<br/> content simple</p>  |
| facets     | <p>Kind Value annotation<br/> pattern [_\a-zA-Z0-9\.\+]+\@[a-zA-Z0-9](\.[\a-zA-Z0-9]*[a-zA-Z0-9])*</p>  |
| annotation | <p>documentation<br/> 00004 Contact entry point for distributors regarding EMT</p>  |

element **EMT\_V3\_FinancialInstrumentType/DataSetInformation/FileGenerationDateTime**

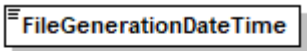
|            |   |
|------------|---|
| diagram    |  <p>00005 Date and Time of the creation of the EMT file<br/> YYYY-MM-DD hh:mm:ss<br/> ISO 8601 (UTC+0)</p> |
| type       | <b>xs:dateTime</b>  |
| properties | <p>isRef 0<br/> content simple</p>  |
| annotation | <p>documentation<br/> 00005 Date and Time of the creation of the EMT file<br/> YYYY-MM-DD hh:mm:ss ISO 8601 (UTC+0)</p>   |

element **EMT\_V3\_FinancialInstrumentType/DataSetInformation/DataReportingTargetMarket**

|            |  |
|------------|--|
| diagram    |  <b>DataReportingTargetMarket</b><br>00006 Specifies if the Target Market section is filled in the current EMT posting. |
| type       | <a href="#">EMTYesNoType</a>   |
| properties | isRef 0<br>content simple  |
| facets     | Kind Value annotation<br>length 1  |
| annotation | documentation<br>00006 Specifies if the Target Market section is filled in the current EMT posting.  |

element **EMT\_V3\_FinancialInstrumentType/DataSetInformation/DataReportingExAnte**

|            |   |
|------------|---|
| diagram    |  <b>DataReportingExAnte</b><br>00007 Specifies if the Ex-Ante Cost and Charges section is filled in the current EMT posting. |
| type       | <a href="#">EMTYesNoType</a>  |
| properties | isRef 0<br>content simple   |
| facets     | Kind Value annotation<br>length 1   |
| annotation | documentation<br>00007 Specifies if the Ex-Ante Cost and Charges section is filled in the current EMT posting.  |

element **EMT\_V3\_FinancialInstrumentType/DataSetInformation/DataReportingExPost**

|            |   |
|------------|---|
| diagram    |  <b>DataReportingExPost</b><br>00008 Specifies if the Ex-Post Cost and Charges section is filled in the current EMT posting. |
| type       | <a href="#">EMTYesNoType</a>  |
| properties | isRef 0<br>content simple   |
| facets     | Kind Value annotation<br>length 1   |
| annotation | documentation<br>00008 Specifies if the Ex-Post Cost and Charges section is filled in the current EMT posting.  |

# element EMT\_V3\_FinancialInstrumentType/GeneralInformation

diagram

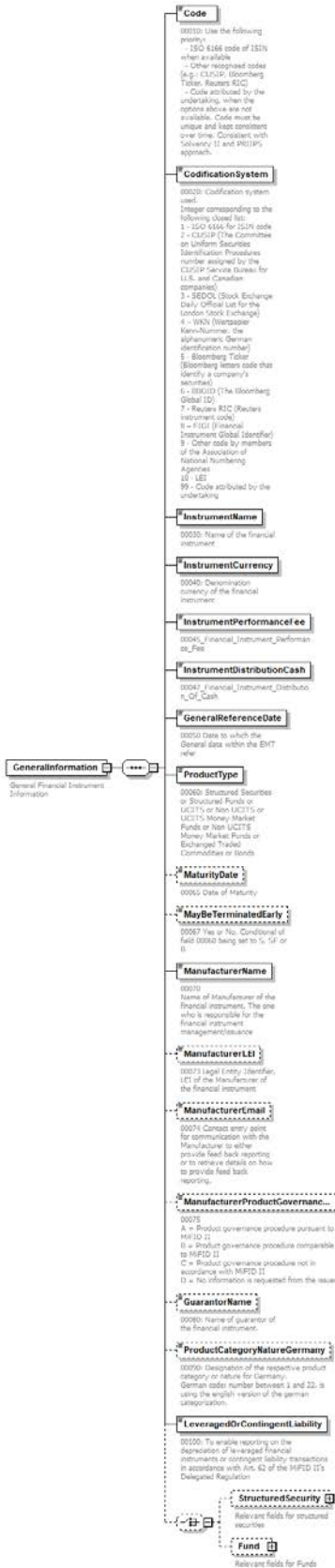

|            |   |
|------------|---|
| properties | isRef 0<br>content complex  |
| children   | <a href="#">Code</a> <a href="#">CodificationSystem</a> <a href="#">InstrumentName</a> <a href="#">InstrumentCurrency</a> <a href="#">InstrumentPerformanceFee</a> <a href="#">InstrumentDistributionCash</a> <a href="#">GeneralReferenceDate</a> <a href="#">ProductType</a> <a href="#">MaturityDate</a> <a href="#">MayBeTerminatedEarly</a> <a href="#">ManufacturerName</a> <a href="#">ManufacturerLEI</a> <a href="#">ManufacturerEmail</a> <a href="#">ManufacturerProductGovernanceProces</a> <a href="#">GuarantorName</a> <a href="#">ProductCategoryNatureGermany</a> <a href="#">LeveragedOrContingentLiability</a> <a href="#">StructuredSecurity</a> <a href="#">Fund</a> |
| annotation | documentation<br>General Financial Instrument Information   |

element **EMT\_V3\_FinancialInstrumentType/GeneralInformation/Code**

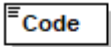
|            |  |
|------------|--|
| diagram    |  <p>00010: Use the following priority:</p> <ul style="list-style-type: none"> <li>- ISO 6166 code of ISIN when available</li> <li>- Other recognised codes (e.g.: CUSIP, Bloomberg Ticker, Reuters RIC)</li> <li>- Code attributed by the undertaking, when the options above are not available. Code must be unique and kept consistent over time. Consistent with Solvency II and PRIIPS approach.</li> </ul> |
| type       | restriction of <b>xs:string</b>  |
| properties | isRef 0<br>content simple  |
| facets     | Kind Value annotation<br>maxLength 255   |
| annotation | documentation<br>00010: Use the following priority:  |

- ISO 6166 code of ISIN when available
- Other recognised codes (e.g.: CUSIP, Bloomberg Ticker, Reuters RIC)
- Code attributed by the undertaking, when the options above are not available. Code must be unique and kept consistent over time. Consistent with Solvency II and PRIIPS approach.

element **EMT\_V3\_FinancialInstrumentType/GeneralInformation/CodificationSystem**

|              |   |            |       |            |              |   |  |              |    |  |
|--------------|---|------------|-------|------------|--------------|---|--|--------------|----|--|
| diagram      | <div data-bbox="297 241 548 289" style="border: 1px solid black; padding: 2px;"> <b>CodificationSystem</b> </div> <p>00020: Codification system used.<br/>           Integer corresponding to the following closed list:<br/>           1 - ISO 6166 for ISIN code<br/>           2 - CUSIP (The Committee on Uniform Securities Identification Procedures number assigned by the CUSIP Service Bureau for U.S. and Canadian companies)<br/>           3 - SEDOL (Stock Exchange Daily Official List for the London Stock Exchange)<br/>           4 - WKN (Wertpapier Kenn-Nummer, the alphanumeric German identification number)<br/>           5 - Bloomberg Ticker (Bloomberg letters code that identify a company's securities)<br/>           6 - BBGID (The Bloomberg Global ID)<br/>           7 - Reuters RIC (Reuters instrument code)<br/>           8 - FIGI (Financial Instrument Global Identifier)<br/>           9 - Other code by members of the Association of National Numbering Agencies<br/>           10 - LEI<br/>           99 - Code attributed by the undertaking</p> |            |       |            |              |   |  |              |    |  |
| type         | restriction of <b>xs:short</b>  |            |       |            |              |   |  |              |    |  |
| properties   | isRef 0<br>content simple   |            |       |            |              |   |  |              |    |  |
| facets       | <table border="0"> <tr> <td>Kind</td> <td>Value</td> <td>annotation</td> </tr> <tr> <td>minInclusive</td> <td>1</td> <td></td> </tr> <tr> <td>maxInclusive</td> <td>99</td> <td></td> </tr> </table>  | Kind       | Value | annotation | minInclusive | 1 |  | maxInclusive | 99 |  |
| Kind         | Value   | annotation |       |            |              |   |  |              |    |  |
| minInclusive | 1   |            |       |            |              |   |  |              |    |  |
| maxInclusive | 99  |            |       |            |              |   |  |              |    |  |
| annotation   | documentation<br>00020: Codification system used.<br>Integer corresponding to the following closed list:<br>1 - ISO 6166 for ISIN code<br>2 - CUSIP (The Committee on Uniform Securities Identification Procedures number assigned by the CUSIP Service Bureau for U.S. and Canadian companies)<br>3 - SEDOL (Stock Exchange Daily Official List for the London Stock Exchange)<br>4 - WKN (Wertpapier Kenn-Nummer, the alphanumeric German identification number)<br>5 - Bloomberg Ticker (Bloomberg letters code that identify a company's securities)<br>6 - BBGID (The Bloomberg Global ID)<br>7 - Reuters RIC (Reuters instrument code)<br>8 - FIGI (Financial Instrument Global Identifier)<br>9 - Other code by members of the Association of National Numbering Agencies<br>10 - LEI<br>99 - Code attributed by the undertaking   |            |       |            |              |   |  |              |    |  |



element **EMT\_V3\_FinancialInstrumentType/GeneralInformation/InstrumentName**

|            |  |
|------------|--|
| diagram    |  <p>00030: Name of the financial instrument</p> |
| type       | restriction of <b>xs:string</b>  |
| properties | isRef 0<br>content simple  |
| facets     | Kind Value annotation<br>maxLength 255   |
| annotation | documentation<br>00030: Name of the financial instrument   |

element **EMT\_V3\_FinancialInstrumentType/GeneralInformation/InstrumentCurrency**

|            |   |
|------------|---|
| diagram    |  <p>00040: Denomination currency of the financial instrument</p> |
| type       | <a href="#">ISOCurrencyCodeType</a>   |
| properties | isRef 0<br>content simple   |
| facets     | Kind Value annotation<br>minLength 3<br>maxLength 3<br>pattern [A-Z]{3}   |
| annotation | documentation<br>00040: Denomination currency of the financial instrument   |

element **EMT\_V3\_FinancialInstrumentType/GeneralInformation/InstrumentPerformanceFee**

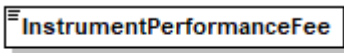
|            |   |
|------------|---|
| diagram    |  <p>00045_Financial_Instrument_Performance_Fee</p> |
| type       | <a href="#">EMTYesNoType</a>  |
| properties | isRef 0<br>content simple   |
| facets     | Kind Value annotation<br>length 1   |
| annotation | documentation<br>00045_Financial_Instrument_Performance_Fee   |

element **EMT\_V3\_FinancialInstrumentType/GeneralInformation/InstrumentDistributionCash**

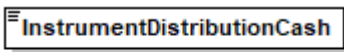
|            |  |
|------------|--|
| diagram    |  <p>00047_Financial_Instrument_Distribution_Of_Cash</p> |
| type       | <a href="#">EMTYesNoType</a>   |
| properties | isRef 0<br>content simple  |

|            |  |
|------------|--|
| facets     | Kind Value annotation<br>length 1                                |
| annotation | documentation<br>00047_Financial_Instrument_Distribution_Of_Cash |

element **EMT\_V3\_FinancialInstrumentType/GeneralInformation/GeneralReferenceDate**

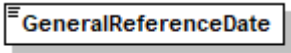
|            |  |
|------------|--|
| diagram    |  <p>00050 Date to which the General data within the EMT refer</p> |
| type       | <b>xs:date</b>   |
| properties | isRef 0<br>content simple  |
| annotation | documentation<br>00050 Date to which the General data within the EMT refer   |

element **EMT\_V3\_FinancialInstrumentType/GeneralInformation/ProductType**

|            |  |
|------------|--|
| diagram    |  <p>00060: Structured Securities or Structured Funds or UCITS or Non UCITS or UCITS Money Market Funds or Non UCITS Money Market Funds or Exchanged Traded Commodities or Bonds</p> |
| type       | restriction of <b>xs:string</b>  |
| properties | isRef 0<br>content simple  |
| facets     | Kind Value annotation<br>minLength 1<br>maxLength 2  |
| annotation | documentation<br>00060: Structured Securities or Structured Funds or UCITS or Non UCITS or UCITS Money Market Funds or Non UCITS Money Market Funds or Exchanged Traded Commodities or Bonds   |

element **EMT\_V3\_FinancialInstrumentType/GeneralInformation/MaturityDate**

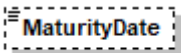
|            |   |
|------------|---|
| diagram    |  <p>00065 Date of Maturity</p> |
| type       | <b>xs:date</b>  |
| properties | isRef 0<br>minOcc 0<br>maxOcc 1<br>content simple   |
| annotation | documentation<br>00065 Date of Maturity   |

element **EMT\_V3\_FinancialInstrumentType/GeneralInformation/MayBeTerminatedEarly**

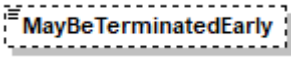
|            |  |
|------------|--|
| diagram    |  <p>00067 Yes or No. Conditional of field 00060 being set to S, SF or B</p> |
| type       | <a href="#">EMTYesNoType</a>   |
| properties | <p>isRef 0</p> <p>minOcc 0</p> <p>maxOcc 1</p> <p>content simple</p>   |
| facets     | <p>Kind Value annotation</p> <p>length 1</p>   |
| annotation | <p>documentation</p> <p>00067 Yes or No. Conditional of field 00060 being set to S, SF or B</p>  |

element **EMT\_V3\_FinancialInstrumentType/GeneralInformation/ManufacturerName**

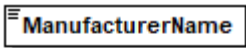
|            |  |
|------------|--|
| diagram    |  <p>00070<br/>Name of Manufacturer of the financial instrument. The one who is responsible for the financial instrument management/issuance</p> |
| type       | restriction of <b>xs:string</b>  |
| properties | <p>isRef 0</p> <p>content simple</p>   |
| facets     | <p>Kind Value annotation</p> <p>maxLength 255</p>  |
| annotation | <p>documentation</p> <p>00070<br/>Name of Manufacturer of the financial instrument. The one who is responsible for the financial instrument management/issuance</p>  |

element **EMT\_V3\_FinancialInstrumentType/GeneralInformation/ManufacturerLEI**

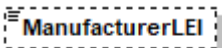
|            |   |
|------------|---|
| diagram    |  <p>00073 Legal Entity Identifier, LEI of the Manufacturer of the financial instrument</p> |
| type       | <a href="#">LEICodeType</a>   |
| properties | <p>isRef 0</p> <p>minOcc 0</p> <p>maxOcc 1</p> <p>content simple</p>  |
| facets     | <p>Kind Value annotation</p> <p>minLength 20</p> <p>maxLength 20</p> <p>pattern ([0-9a-zA-Z]{18}[0-9]{2})</p>   |
| annotation | <p>documentation</p> <p>00073 Legal Entity Identifier, LEI of the Manufacturer of the financial instrument</p>  |

element **EMT\_V3\_FinancialInstrumentType/GeneralInformation/ManufacturerEmail**

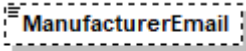
|            |  |
|------------|--|
| diagram    |  <p>00074 Contact entry point for communication with the Manufacturer to either provide feed back reporting or to retrieve details on how to provide feed back reporting.</p> |
| type       | <a href="#">EmailAddressType</a>   |
| properties | isRef 0<br>minOcc 0<br>maxOcc 1<br>content simple  |
| facets     | Kind Value annotation<br>pattern <code>[_\a-zA-Z0-9\.\+]+\@[a-zA-Z0-9](\.[\a-zA-Z0-9]*[a-zA-Z0-9])*</code>   |
| annotation | documentation<br>00074 Contact entry point for communication with the Manufacturer to either provide feed back reporting or to retrieve details on how to provide feed back reporting.   |

element **EMT\_V3\_FinancialInstrumentType/GeneralInformation/ManufacturerProductGovernanceProces**

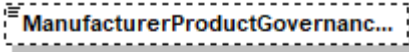
|            |   |
|------------|---|
| diagram    |  <p>00075<br/>         A = Product governance procedure pursuant to MiFID II<br/>         B = Product governance procedure comparable to MiFID II<br/>         C = Product governance procedure not in accordance with MiFID II<br/>         D = No information is requested from the issuer</p> |
| type       | restriction of <b>xs:string</b>   |
| properties | isRef 0<br>minOcc 0<br>maxOcc 1<br>content simple   |
| facets     | Kind Value annotation<br>minLength 1<br>maxLength 1   |
| annotation | documentation<br>00075<br>A = Product governance procedure pursuant to MiFID II<br>B = Product governance procedure comparable to MiFID II<br>C = Product governance procedure not in accordance with MiFID II<br>D = No information is requested from the issuer   |

element **EMT\_V3\_FinancialInstrumentType/GeneralInformation/GuarantorName**

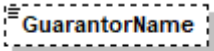
|            |  |
|------------|--|
| diagram    |  <p>00080: Name of guarantor of the financial instrument.</p> |
| type       | restriction of <b>xs:string</b>  |
| properties | isRef 0<br>minOcc 0<br>maxOcc 1<br>content simple  |

|            |  |
|------------|--|
| facets     | Kind Value annotation<br>maxLength 255                                 |
| annotation | documentation<br>00080: Name of guarantor of the financial instrument. |

element **EMT\_V3\_FinancialInstrumentType/GeneralInformation/ProductCategoryNatureGermany**

|            |  |
|------------|--|
| diagram    |  <p>00090: Designation of the respective product category or nature for Germany.<br/>German code: number between 1 and 22, is using the english version of the german categorization.</p> |
| type       | restriction of <b>xs:positiveInteger</b>   |
| properties | isRef 0<br>minOcc 0<br>maxOcc 1<br>content simple  |
| facets     | Kind Value annotation<br>minInclusive 1<br>maxInclusive 22   |
| annotation | documentation<br>00090: Designation of the respective product category or nature for Germany.<br>German code: number between 1 and 22, is using the english version of the german categorization.  |

element **EMT\_V3\_FinancialInstrumentType/GeneralInformation/LeveragedOrContingentLiability**

|            |   |
|------------|---|
| diagram    |  <p>00100: To enable reporting on the depreciation of leveraged financial instruments or contingent liability transactions in accordance with Art. 62 of the MiFID II's Delegated Regulation</p> |
| type       | <a href="#">EMTYesNoType</a>  |
| properties | isRef 0<br>content simple   |
| facets     | Kind Value annotation<br>length 1   |
| annotation | documentation<br>00100: To enable reporting on the depreciation of leveraged financial instruments or contingent liability transactions in accordance with Art. 62 of the MiFID II's Delegated Regulation   |

element **EMT\_V3\_FinancialInstrumentType/GeneralInformation/StructuredSecurity**

|            |   |
|------------|---|
| diagram    | <p>The diagram shows a central box labeled <b>StructuredSecurity</b> with the text "Relevant fields for structured securities" below it. To its right, three dashed boxes represent child elements: <b>TypeNotionalOrItemBased</b>, <b>ProductCategoryNature</b>, and <b>Quotation</b>. Dashed lines connect the central box to each of these child boxes, indicating a containment relationship.</p> <p><b>TypeNotionalOrItemBased</b><br/>00085: Enables interpretation of Cost and Charges data when used together with fields 00096, 08110 and 08120.<br/>N for Notional based instrument, I for Item based instrument</p> <p><b>ProductCategoryNature</b><br/>00095: If the financial instrument is a structured security complete with the EUSIPA code</p> <p><b>Quotation</b><br/>00096: If 00060 is set to S or ETC.<br/>U for Units, or P for Percentage.<br/>Defines if the quotation type in the Ex-Ante and Ex-Post section of the EMT file is in UNITS or in PERCENTAGE related to the specific Reference as presented in field 07150,07155, 08110 and 08120 respectively.</p> |
| properties | <p>isRef 0<br/>minOcc 0<br/>maxOcc 1<br/>content complex</p>  |
| children   | <p><a href="#">TypeNotionalOrItemBased</a> <a href="#">ProductCategoryNature</a> <a href="#">Quotation</a></p>  |
| annotation | <p>documentation<br/>Relevant fields for structured securities</p>  |

element **EMT\_V3\_FinancialInstrumentType/GeneralInformation/StructuredSecurity/TypeNotionalOrItemBased**

|            |  |
|------------|--|
| diagram    | <p>The diagram shows a dashed box labeled <b>TypeNotionalOrItemBased</b> with the text "restriction of xs:string" below it. This indicates that the element is a restriction of the XML Schema primitive type xs:string.</p> <p>00085: Enables interpretation of Cost and Charges data when used together with fields 00096, 08110 and 08120.<br/>N for Notional based instrument, I for Item based instrument</p> |
| type       | <p>restriction of <b>xs:string</b></p>   |
| properties | <p>isRef 0<br/>minOcc 0<br/>maxOcc 1<br/>content simple</p>  |
| facets     | <p>Kind Value annotation<br/>minLength 1<br/>maxLength 1</p>   |
| annotation | <p>documentation<br/>00085: Enables interpretation of Cost and Charges data when used together with fields 00096, 08110 and 08120.<br/>N for Notional based instrument, I for Item based instrument</p>  |

element

**EMT\_V3 FinancialInstrumentType/GeneralInformation/StructuredSecurity/ProductCategoryNature**

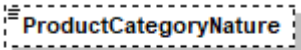
|            |  |
|------------|--|
| diagram    |  <p>00095: If the financial instrument is a structured security complete with the EUSIPA code</p> |
| type       | restriction of <a href="#">Text4Type</a>   |
| properties | isRef 0<br>minOcc 0<br>maxOcc 1<br>content simple  |
| facets     | Kind Value annotation<br>maxLength 4   |
| annotation | documentation<br>00095: If the financial instrument is a structured security complete with the EUSIPA code   |

element **EMT\_V3 FinancialInstrumentType/GeneralInformation/StructuredSecurity/Quotation**

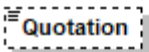
|            |   |
|------------|---|
| diagram    |  <p>00096: If 00060 is set to S or ETC.<br/>U for Units, or P for Percentage.<br/>Defines if the quotation type in the Ex-Ante and Ex-Post section of the EMT file is in UNITS or in PERCENTAGE related to the specific Reference as presented in field 07150,07155, 08110 and 08120 respectively.</p> |
| type       | restriction of <b>xs:string</b>   |
| properties | isRef 0<br>minOcc 0<br>maxOcc 1<br>content simple   |
| facets     | Kind Value annotation<br>minLength 1<br>maxLength 1   |
| annotation | documentation<br>00096: If 00060 is set to S or ETC.<br>U for Units, or P for Percentage.<br>Defines if the quotation type in the Ex-Ante and Ex-Post section of the EMT file is in UNITS or in PERCENTAGE related to the specific Reference as presented in field 07150,07155, 08110 and 08120 respectively.   |

element **EMT\_V3 FinancialInstrumentType/GeneralInformation/Fund**

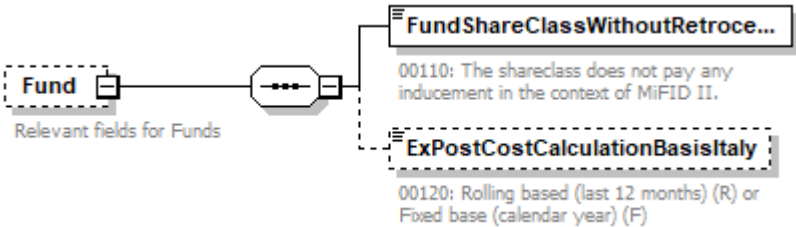
|         |   |
|---------|---|
| diagram |  <p>Relevant fields for Funds</p> <p><b>FundShareClassWithoutRetroce...</b><br/>00110: The shareclass does not pay any inducement in the context of MiFID II.</p> <p><b>ExPostCostCalculationBasisItaly</b><br/>00120: Rolling based (last 12 months) (R) or Fixed base (calendar year) (F)</p> |
|---------|---|

|            |   |
|------------|---|
| properties | isRef 0<br>minOcc 0<br>maxOcc 1<br>content complex                                |
| children   | <a href="#">FundShareClassWithoutRetrocession ExPostCostCalculationBasisItaly</a> |
| annotation | documentation<br>Relevant fields for Funds  |

element

**EMT\_V3 FinancialInstrumentType/GeneralInformation/Fund/FundShareClassWithoutRetrocession**

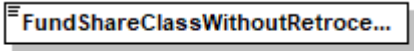
|            |  |
|------------|--|
| diagram    |  <p>00110: The shareclass does not pay any inducement in the context of MiFID II.</p> |
| type       | <a href="#">EMTYesNoType</a>   |
| properties | isRef 0<br>content simple  |
| facets     | Kind Value annotation<br>length 1  |
| annotation | documentation<br>00110: The shareclass does not pay any inducement in the context of MiFID II.   |

element **EMT\_V3 FinancialInstrumentType/GeneralInformation/Fund/ExPostCostCalculationBasisItaly**

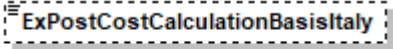
|            |   |
|------------|---|
| diagram    |  <p>00120: Rolling based (last 12 months) (R) or Fixed base (calendar year) (F)</p> |
| type       | restriction of <a href="#">Text1Type</a>  |
| properties | isRef 0<br>minOcc 0<br>maxOcc 1<br>content simple   |
| facets     | Kind Value annotation<br>maxLength 1  |
| annotation | documentation<br>00120: Rolling based (last 12 months) (R) or Fixed base (calendar year) (F)  |



element **EMT\_V3\_FinancialInstrumentType/TargetMarket**

|                   |   |
|-------------------|---|
| <p>diagram</p>    |   |
| <p>properties</p> | <p>isRef 0<br/>content complex</p>  |
| <p>children</p>   | <p><a href="#">GeneralReferenceDate</a> <a href="#">InvestorType</a> <a href="#">KnowledgeAndExperience</a> <a href="#">AbilityToBearLosses</a> <a href="#">RiskTolerance</a> <a href="#">ClientObjectives</a> <a href="#">DistributionStrategy</a></p> |

element **EMT\_V3\_FinancialInstrumentType/TargetMarket/GeneralReferenceDate**

|                   |  |
|-------------------|--|
| <p>diagram</p>    |  |
| <p>type</p>       | <p><b>xs:date</b></p>  |
| <p>properties</p> | <p>isRef 0<br/>content simple</p>  |
| <p>annotation</p> | <p>documentation<br/>01000 Date to which the Target Market data within the EMT refer</p> |

element **EMT\_V3\_FinancialInstrumentType/TargetMarket/InvestorType**

|            |   |
|------------|---|
| diagram    | <p><b>InvestorType</b><br/>Target markets - Investor Type</p> <p><b>Retail</b><br/>01010: Neutral means usage by Retail clients are available under certain conditions.</p> <p><b>Professional</b><br/>01020: Y means both Professional Per Se and Elective Professionals are compatible.<br/>N means that neither Professional Per Se nor Elective Professionals are compatible.<br/>P means that Professional Per Se is compatible but Elective Professionals are not.<br/>E means that Elective Professional is compatible but Professionals Per Se are not.<br/>P is only used if the distinction Per Se is done in the Prospectus.</p> <p><b>EligibleCounterparty</b><br/>01030: Investor Type Eligible Counterparty</p> |
| properties | isRef 0<br>content complex  |
| children   | <a href="#">Retail</a> <a href="#">Professional</a> <a href="#">EligibleCounterparty</a>  |
| annotation | documentation<br>Target markets - Investor Type   |

element **EMT\_V3\_FinancialInstrumentType/TargetMarket/InvestorType/Retail**

|            |   |
|------------|---|
| diagram    | <p><b>Retail</b><br/>01010: Neutral means usage by Retail clients are available under certain conditions.</p> |
| type       | <a href="#">EMTYesNoNeutralType</a>   |
| properties | isRef 0<br>content simple   |
| facets     | Kind Value annotation<br>minLength 1<br>maxLength 7   |
| annotation | documentation<br>01010: Neutral means usage by Retail clients are available under certain conditions.         |

element **EMT\_V3\_FinancialInstrumentType/TargetMarket/InvestorType/Professional**

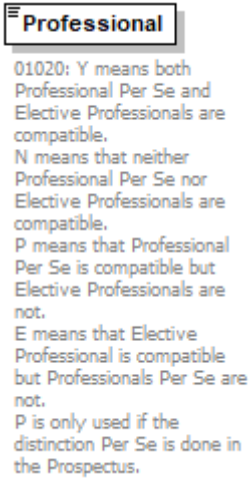
|            |   |
|------------|---|
| diagram    |  <p>01020: Y means both Professional Per Se and Elective Professionals are compatible.<br/> N means that neither Professional Per Se nor Elective Professionals are compatible.<br/> P means that Professional Per Se is compatible but Elective Professionals are not.<br/> E means that Elective Professional is compatible but Professionals Per Se are not.<br/> P is only used if the distinction Per Se is done in the Prospectus.</p> |
| type       | restriction of <b>xs:string</b>   |
| properties | isRef 0<br>content simple   |
| annotation | documentation<br>01020: Y means both Professional Per Se and Elective Professionals are compatible.<br>N means that neither Professional Per Se nor Elective Professionals are compatible.<br>P means that Professional Per Se is compatible but Elective Professionals are not.<br>E means that Elective Professional is compatible but Professionals Per Se are not.<br>P is only used if the distinction Per Se is done in the Prospectus.   |

element **EMT\_V3\_FinancialInstrumentType/TargetMarket/InvestorType/EligibleCounterparty**

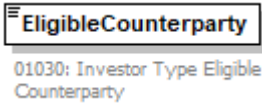
|            |   |
|------------|---|
| diagram    |  <p>01030: Investor Type Eligible Counterparty</p> |
| type       | <a href="#">EMTYesNoType</a>  |
| properties | isRef 0<br>content simple   |
| facets     | Kind Value annotation<br>length 1   |
| annotation | documentation<br>01030: Investor Type Eligible Counterparty   |

element **EMT\_V3\_FinancialInstrumentType/TargetMarket/KnowledgeAndExperience**

|                   |  |
|-------------------|--|
| <p>diagram</p>    | <p><b>KnowledgeAndExperience</b><br/>Target markets - Knowledge and/or Experience</p> <p><b>BasicInvestor</b><br/>02010: Investors having the following characteristics:<br/> <ul style="list-style-type: none"> <li>• basic knowledge of relevant financial instruments (a basic investor can make an informed investment decision based on the regulated and authorised offering documentation or with the help of basic information provided by point of sale);</li> <li>• no financial industry experience, i.e. suited to a first time investor</li> </ul> </p> <p><b>InformedInvestor</b><br/>02020: Having one, or more, of the following characteristics:<br/> <ul style="list-style-type: none"> <li>• average knowledge of relevant financial products (an informed investor can make an informed investment decision based on the regulated and authorised offering documentation, together with knowledge and understanding of the specific factors/risks highlighted within them only)</li> <li>• some financial industry experience</li> </ul> </p> <p><b>AdvancedInvestor</b><br/>02030: Investors having one, or more, of the following characteristics:<br/> <ul style="list-style-type: none"> <li>• good knowledge of relevant financial products and transactions</li> <li>• financial industry experience or accompanied by professional investment advice or included in a discretionary portfolio service</li> </ul> </p> <p><b>ExpertInvestorGermany</b><br/>02040: Expert knowledge of and / or experience with highly specialised financial products (Regulatory requirement in Germany/ example: CFD/ the updated list will be provided by the DSGVO)</p> |
| <p>properties</p> | <p>isRef 0<br/>content complex</p>   |
| <p>children</p>   | <p><a href="#">BasicInvestor</a> <a href="#">InformedInvestor</a> <a href="#">AdvancedInvestor</a> <a href="#">ExpertInvestorGermany</a></p>   |
| <p>annotation</p> | <p>documentation<br/>Target markets - Knowledge and/or Experience</p>  |

element **EMT\_V3\_FinancialInstrumentType/TargetMarket/KnowledgeAndExperience/BasicInvestor**

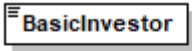
|            |   |
|------------|---|
| diagram    |  <p>02010: Investors having the following characteristics:</p> <ul style="list-style-type: none"> <li>• basic knowledge of relevant financial instruments (a basic investor can make an informed investment decision based on the regulated and authorised offering documentation or with the help of basic information provided by point of sale);</li> <li>• no financial industry experience, i.e. suited to a first time investor</li> </ul> |
| type       | <a href="#">EMTYesNoNeutralType</a>   |
| properties | isRef 0<br>content simple   |
| facets     | Kind Value annotation<br>minLength 1<br>maxLength 7   |
| annotation | documentation<br>02010: Investors having the following characteristics:<br><ul style="list-style-type: none"> <li>• basic knowledge of relevant financial instruments (a basic investor can make an informed investment decision based on the regulated and authorised offering documentation or with the help of basic information provided by point of sale);</li> <li>• no financial industry experience, i.e. suited to a first time investor</li> </ul>  |

element **EMT\_V3\_FinancialInstrumentType/TargetMarket/KnowledgeAndExperience/InformedInvestor**

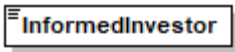
|            |  |
|------------|--|
| diagram    |  <p>02020: Having one, or more, of the following characteristics:</p> <ul style="list-style-type: none"> <li>• average knowledge of relevant financial products (an informed investor can make an informed investment decision based on the regulated and authorised offering documentation, together with knowledge and understanding of the specific factors/risks highlighted within them only)</li> <li>• some financial industry experience</li> </ul> |
| type       | <a href="#">EMTYesNoNeutralType</a>  |
| properties | isRef 0<br>content simple  |
| facets     | Kind Value annotation<br>minLength 1<br>maxLength 7  |
| annotation | documentation<br>02020: Having one, or more, of the following characteristics:<br><ul style="list-style-type: none"> <li>• average knowledge of relevant financial products (an informed investor can make an informed investment decision based on the regulated and authorised offering documentation, together with knowledge and understanding of the specific factors/risks highlighted within them only)</li> <li>• some financial industry experience</li> </ul>  |

element **EMT\_V3\_FinancialInstrumentType/TargetMarket/KnowledgeAndExperience/AdvancedInvestor**

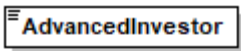
|            |  |
|------------|--|
| diagram    |  <p>02030: Investors having one, or more, of the following characteristics:</p> <ul style="list-style-type: none"> <li>• good knowledge of relevant financial products and transactions</li> <li>• financial industry experience or accompanied by professional investment advice or included in a discretionary portfolio service</li> </ul> |
| type       | <a href="#">EMTYesNoNeutralType</a>  |
| properties | isRef 0<br>content simple  |
| facets     | Kind Value annotation<br>minLength 1<br>maxLength 7  |
| annotation | documentation<br>02030: Investors having one, or more, of the following characteristics:<br><ul style="list-style-type: none"> <li>• good knowledge of relevant financial products and transactions</li> <li>• financial industry experience or accompanied by professional investment advice or included in a discretionary portfolio service</li> </ul>  |

element **EMT\_V3\_FinancialInstrumentType/TargetMarket/KnowledgeAndExperience/ExpertInvestorGermany**

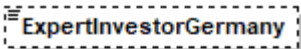
|            |  |
|------------|--|
| diagram    |  <p>02040: Expert knowledge of and / or experience with highly specialised financial products (Regulatory requirement in Germany/ example: CFD/ the updated list will be provided by the DSGVO)</p> |
| type       | <a href="#">EMTYesNoNeutralType</a>  |
| properties | isRef 0<br>minOcc 0<br>maxOcc 1<br>content simple  |
| facets     | Kind Value annotation<br>minLength 1<br>maxLength 7  |
| annotation | documentation<br>02040: Expert knowledge of and / or experience with highly specialised financial products (Regulatory requirement in Germany/ example: CFD/ the updated list will be provided by the DSGVO)   |

element **EMT\_V3\_FinancialInstrumentType/TargetMarket/AbilityToBearLosses**

|                   |  |
|-------------------|--|
| <p>diagram</p>    | <p><b>AbilityToBearLosses</b><br/>Target markets - Ability To Bear Losses</p> <p><b>CompatibleWithClientsWhoCan...</b><br/>03010: Investor can bear no loss of capital. Minor losses especially due to costs possible. Yes or No or Neutral. N for negative target: product should not be sold to investors that cannot bear losses</p> <p><b>CompatibleWithClientsWhoCan...</b><br/>03020: Investor seeking to preserve capital or can bear losses limited to a level specified by the product. Assessment of loss level is based on investments in the same currency as the instrument denomination and do not take into consideration potential adverse FX market performance. To be filled only for structured securities and funds with an explicit capital protection or for Money Market funds. Yes or No or Neutral</p> <p><b>LimitedCapitalLossLevel</b><br/>03030: To be completed for products that have a clearly stated full or partial capital guarantee, provided on the primary market. This field represents the maximum loss a client could incur when investing in this product – it is not the level of capital protection offered</p> <p><b>CompatibleWithClientsWhoDoN...</b><br/>03040: No Capital Guarantee nor protection. 100% capital at risk. Yes or No or Neutral</p> <p><b>CompatibleWithClientsWhoCan...</b><br/>03050: Loss Beyond the Capital. Yes or No or Neutral</p> |
| <p>properties</p> | <p>isRef 0<br/>content complex</p>   |
| <p>children</p>   | <p><a href="#">CompatibleWithClientsWhoCanNotBearCapitalLoss</a> <a href="#">CompatibleWithClientsWhoCanBearLimitedCapitalLoss</a> <a href="#">LimitedCapitalLossLevel</a> <a href="#">CompatibleWithClientsWhoDoNotNeedCapitalGuarantee</a> <a href="#">CompatibleWithClientsWhoCanBearLossBeyondCapital</a></p>  |
| <p>annotation</p> | <p>documentation<br/>Target markets - Ability To Bear Losses</p>   |

element **EMT\_V3\_FinancialInstrumentType/TargetMarket/AbilityToBearLosses/CompatibleWithClientsWhoCanNotBearCapitalLoss**

|                |   |
|----------------|---|
| <p>diagram</p> | <p><b>CompatibleWithClientsWhoCan...</b><br/>03010: Investor can bear no loss of capital. Minor losses especially due to costs possible. Yes or No or Neutral. N for negative target: product should not be sold to investors that cannot bear losses</p> |
| <p>type</p>    | <p><a href="#">EMTYesNoNeutralType</a></p>  |

|            |  |
|------------|--|
| properties | isRef 0<br>content simple  |
| facets     | Kind Value annotation<br>minLength 1<br>maxLength 7  |
| annotation | documentation<br>03010: Investor can bear no loss of capital. Minor losses especially due to costs possible. Yes or No or Neutral.<br>N for negative target: product should not be sold to investors that cannot bear losses |

element

**EMT\_V3\_FinancialInstrumentType/TargetMarket/AbilityToBearLosses/CompatibleWithClientsWhoCanBearLimitedCapitalLoss**

|            |   |
|------------|---|
| diagram    | <p>03020: Investor seeking to preserve capital or can bear losses limited to a level specified by the product. Assessment of loss level is based on investments in the same currency as the instrument denomination and do not take into consideration potential adverse FX market performance.<br/>To be filled only for structured securities and funds with an explicit capital protection or for Money Market funds.<br/>Yes or No or Neutral</p>         |
| type       | <a href="#">EMTYesNoNeutralType</a>   |
| properties | isRef 0<br>minOcc 0<br>maxOcc 1<br>content simple   |
| facets     | Kind Value annotation<br>minLength 1<br>maxLength 7   |
| annotation | documentation<br>03020: Investor seeking to preserve capital or can bear losses limited to a level specified by the product. Assessment of loss level is based on investments in the same currency as the instrument denomination and do not take into consideration potential adverse FX market performance.<br>To be filled only for structured securities and funds with an explicit capital protection or for Money Market funds.<br>Yes or No or Neutral |

element **EMT\_V3\_FinancialInstrumentType/TargetMarket/AbilityToBearLosses/LimitedCapitalLossLevel**

|            |   |
|------------|---|
| diagram    | <p>03030: To be completed for products that have a clearly stated full or partial capital guarantee, provided on the primary market.<br/>This field represents the maximum loss a client could incur when investing in this product – it is not the level of capital protection offered</p> |
| type       | <a href="#">PercentageType</a>  |
| properties | isRef 0<br>minOcc 0<br>maxOcc 1<br>content simple   |
| annotation | documentation<br>03030: To be completed for products that have a clearly stated full or partial capital guarantee, provided on the primary  |



|  |  |
|--|--|
|  | market. This field represents the maximum loss a client could incur when investing in this product – it is not the level of capital protection offered |
|--|--|

element

**EMT\_V3\_FinancialInstrumentType/TargetMarket/AbilityToBearLosses/CompatibleWithClientsWhoDoNotNeedCapitalGuarantee**

|            |   |
|------------|---|
| diagram    |   |
| type       | <a href="#">EMTYesNoNeutralType</a>   |
| properties | isRef 0<br>content simple   |
| facets     | Kind Value annotation<br>minLength 1<br>maxLength 7   |
| annotation | documentation<br>03040: No Capital Guarantee nor protection. 100% capital at risk. Yes or No or Neutral |

element

**EMT\_V3\_FinancialInstrumentType/TargetMarket/AbilityToBearLosses/CompatibleWithClientsWhoCanBearLossBeyondCapital**

|            |  |
|------------|--|
| diagram    |  |
| type       | <a href="#">EMTYesNoNeutralType</a>                                      |
| properties | isRef 0<br>content simple  |
| facets     | Kind Value annotation<br>minLength 1<br>maxLength 7                      |
| annotation | documentation<br>03050: Loss Beyond the Capital.<br>Yes or No or Neutral |

element **EMT\_V3\_FinancialInstrumentType/TargetMarket/RiskTolerance**

|                   |  |
|-------------------|--|
| <p>diagram</p>    | <p><b>RiskTolerance</b><br/>Target markets - Risk Tolerance</p> <ul style="list-style-type: none"> <li><b>PRIIPSMethodology</b><br/>04010: SRI (1-7), if PRIIPS KID is available. German distributors will use only this Risk Tolerance item</li> <li><b>UCITSMethodology</b><br/>04020: SRRI (1-7; for funds)</li> <li><b>InternalMethodology</b><br/>04030: For Non PRIIPS and Non UCITS:<br/>L ... Low<br/>M ... Medium<br/>H ... High</li> <li><b>MethodologySpain</b><br/>04040: Spanish SRI (1-6) for Non PRIIPS and Non UCITS<br/>For Spanish local NON PRIIPS and NON UCITS products.<br/>Orden ECC/2316/2015, de 4 de noviembre, relativa a las obligaciones de información y clasificación de productos financieros</li> <li><b>NotForInvestorsWithLowestRis...</b><br/>04050: For all products distributed in Germany (Yes or Neutral)</li> </ul> |
| <p>properties</p> | <p>isRef 0<br/>content complex</p>   |
| <p>children</p>   | <p><a href="#">PRIIPSMethodology</a> <a href="#">UCITSMethodology</a> <a href="#">InternalMethodology</a> <a href="#">MethodologySpain</a><br/><a href="#">NotForInvestorsWithLowestRiskToleranceGermany</a></p>   |
| <p>annotation</p> | <p>documentation<br/>Target markets - Risk Tolerance</p>   |

element **EMT\_V3\_FinancialInstrumentType/TargetMarket/RiskTolerance/PRIIPSMethodology**

|                   |  |
|-------------------|--|
| <p>diagram</p>    | <p><b>PRIIPSMethodology</b><br/>04010: SRI (1-7), if PRIIPS KID is available. German distributors will use only this Risk Tolerance item</p> |
| <p>type</p>       | <p>restriction of <b>xs:positiveInteger</b></p>  |
| <p>properties</p> | <p>isRef 0<br/>minOcc 0<br/>maxOcc 1<br/>content simple</p>  |
| <p>facets</p>     | <p>Kind Value annotation<br/>minInclusive 1<br/>maxInclusive 7</p>   |
| <p>annotation</p> | <p>documentation<br/>04010: SRI (1-7), if PRIIPS KID is available. German distributors will use only this Risk Tolerance item</p>            |

element **EMT\_V3\_FinancialInstrumentType/TargetMarket/RiskTolerance/UCITSMethodology**

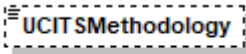
|            |   |
|------------|---|
| diagram    |  <p>04020: SRRI (1-7; for funds)</p> |
| type       | restriction of <b>xs:positiveInteger</b>  |
| properties | isRef 0<br>minOcc 0<br>maxOcc 1<br>content simple   |
| facets     | Kind Value annotation<br>minInclusive 1<br>maxInclusive 7   |
| annotation | documentation<br>04020: SRRI (1-7; for funds)   |

element **EMT\_V3\_FinancialInstrumentType/TargetMarket/RiskTolerance/InternalMethodology**

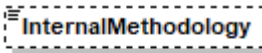
|            |  |
|------------|--|
| diagram    |  <p>04030: For Non PRIIPS and Non UCITS:<br/> L ... Low<br/> M ... Medium<br/> H ... High</p> |
| type       | restriction of <b>xs:string</b>  |
| properties | isRef 0<br>minOcc 0<br>maxOcc 1<br>content simple  |
| annotation | documentation<br>04030: For Non PRIIPS and Non UCITS:<br>L ... Low<br>M ... Medium<br>H ... High   |

element **EMT\_V3\_FinancialInstrumentType/TargetMarket/RiskTolerance/MethodologySpain**

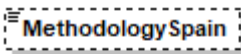
|            |   |
|------------|---|
| diagram    |  <p>04040: Spanish SRI (1-6) for Non PRIIPS and Non UCITS<br/> For Spanish local NON PRIIPS and NON UCITS products.<br/> Orden ECC/2316/2015, de 4 de noviembre, relativa a las obligaciones de información y clasificación de productos financieros</p> |
| type       | restriction of <b>xs:positiveInteger</b>  |
| properties | isRef 0<br>minOcc 0<br>maxOcc 1<br>content simple   |

|            |   |
|------------|---|
| facets     | Kind Value annotation<br>minInclusive 1<br>maxInclusive 6   |
| annotation | documentation<br>04040: Spanish SRI (1-6) for Non PRIIPS and Non UCITS<br>For Spanish local NON PRIIPS and NON UCITS products.<br>Orden ECC/2316/2015, de 4 de noviembre, relativa a las obligaciones de información y clasificación de productos financieros |

element

**EMT\_V3\_FinancialInstrumentType/TargetMarket/RiskTolerance/NotForInvestorsWithLowestRiskToleranceGermany**

|            |  |
|------------|--|
| diagram    |  |
| type       | restriction of xs:string   |
| properties | isRef 0<br>minOcc 0<br>maxOcc 1<br>content simple                                |
| annotation | documentation<br>04050: For all products distributed in Germany (Yes or Neutral) |

element **EMT\_V3\_FinancialInstrumentType/TargetMarket/ClientObjectives**

|            |   |
|------------|---|
| diagram    |   |
| properties | isRef 0<br>content complex  |
| children   | <a href="#">ReturnProfile</a> <a href="#">MinimumRecommendedHoldingPeriod</a> <a href="#">IntendedCompatibleWithClientsHavingESGPreferences</a> <a href="#">OtherSpecificInvestmentNeed</a> |
| annotation | documentation<br>Target markets - Client Objectives and Needs   |

element **EMT\_V3\_FinancialInstrumentType/TargetMarket/ClientObjectives/ReturnProfile**

|                   |   |
|-------------------|---|
| <p>diagram</p>    | <pre> classDiagram     class ReturnProfile     class ClientLookingForPreservation     class ClientLookingForCapitalGrowth     class ClientLookingForIncome     class OptionOrLeveraged     class PensionSchemeGermany     class StructuredSecurity      ReturnProfile -- ClientLookingForPreservation     ReturnProfile -- ClientLookingForCapitalGrowth     ReturnProfile -- ClientLookingForIncome     ReturnProfile -.- OptionOrLeveraged     ReturnProfile -.- PensionSchemeGermany     ReturnProfile -.- StructuredSecurity     </pre> <p><b>ClientLookingForPreservation</b><br/>05010: Indicates if the product is compatible with clients looking for preserving their capital. Products stipulating a capital preservation objective should be YES. For other products, the answer should be NO or NEUTRAL based on a case-by-case analysis. In Germany fields 05010, 05020 and 05030 are merged and regarded "General Capital Formation". A YES in any of these fields will be regarded a YES in the German combined field.</p> <p><b>ClientLookingForCapitalGrowth</b><br/>05020: Indicates if the product is compatible with clients looking for growing their capital. In Germany fields 05010, 05020 and 05030 are merged and regarded "General Capital Formation". A YES in any of these fields will be regarded a YES in the German combined field.</p> <p><b>ClientLookingForIncome</b><br/>05030: Indicates if the product is compatible with clients looking for Income. In Germany fields 05010, 05020 and 05030 are merged and regarded "General Capital Formation". A YES in any of these fields will be regarded a YES in the German combined field.</p> <p><b>OptionOrLeveraged</b><br/>05050: Yes or No or Neutral</p> <p><b>PensionSchemeGermany</b><br/>05070: Yes or No or Neutral</p> <p><b>StructuredSecurity</b> ⊕</p> |
| <p>properties</p> | <p>isRef 0<br/>content complex</p>  |
| <p>children</p>   | <p><a href="#">ClientLookingForPreservation</a> <a href="#">ClientLookingForCapitalGrowth</a> <a href="#">ClientLookingForIncome</a> <a href="#">OptionOrLeveraged</a> <a href="#">PensionSchemeGermany</a> <a href="#">StructuredSecurity</a></p>  |

element

**EMT\_V3\_FinancialInstrumentType/TargetMarket/ClientObjectives/ReturnProfile/ClientLookingForPreservation**

|            |   |
|------------|---|
| diagram    | <div style="border: 1px solid black; padding: 2px;"><b>ClientLookingForPreservation</b></div> <p>05010: Indicates if the product is compatible with clients looking for preserving their capital. Products stipulating a capital preservation objective should be YES. For other products, the answer should be NO or NEUTRAL based on a case-by-case analysis. In Germany fields 05010, 05020 and 05030 are merged and regarded "General Capital Formation". A YES in any of these fields will be regarded a YES in the German combined field.</p> |
| type       | <a href="#">EMTYesNoNeutralType</a>   |
| properties | isRef 0<br>content simple   |
| facets     | Kind Value annotation<br>minLength 1<br>maxLength 7   |
| annotation | documentation<br>05010: Indicates if the product is compatible with clients looking for preserving their capital. Products stipulating a capital preservation objective should be YES. For other products, the answer should be NO or NEUTRAL based on a case-by-case analysis. In Germany fields 05010, 05020 and 05030 are merged and regarded "General Capital Formation". A YES in any of these fields will be regarded a YES in the German combined field.   |

element

**EMT\_V3\_FinancialInstrumentType/TargetMarket/ClientObjectives/ReturnProfile/ClientLookingForCapitalGrowth**

|            |   |
|------------|---|
| diagram    | <div style="border: 1px solid black; padding: 2px;"><b>ClientLookingForCapitalGrowth</b></div> <p>05020: Indicates if the product is compatible with clients looking for growing their capital. In Germany fields 05010, 05020 and 05030 are merged and regarded "General Capital Formation". A YES in any of these fields will be regarded a YES in the German combined field.</p> |
| type       | <a href="#">EMTYesNoNeutralType</a>   |
| properties | isRef 0<br>content simple   |
| facets     | Kind Value annotation<br>minLength 1<br>maxLength 7   |
| annotation | documentation<br>05020: Indicates if the product is compatible with clients looking for growing their capital. In Germany fields 05010, 05020 and 05030 are merged and regarded "General Capital Formation". A YES in any of these fields will be regarded a YES in the German combined field.  |

element

**EMT\_V3\_FinancialInstrumentType/TargetMarket/ClientObjectives/ReturnProfile/ClientLookingForIncome**

|            |   |
|------------|---|
| diagram    | <br><b>ClientLookingForIncome</b><br>05030: Indicates if the product is compatible with clients looking for Income.<br>In Germany fields 05010, 05020 and 05030 are merged and regarded "General Capital Formation". A YES in any of these fields will be regarded a YES in the German combined field. |
| type       | <a href="#">EMTYesNoNeutralType</a>   |
| properties | isRef 0<br>content simple   |
| facets     | Kind Value annotation<br>minLength 1<br>maxLength 7   |
| annotation | documentation<br>05030: Indicates if the product is compatible with clients looking for Income.<br>In Germany fields 05010, 05020 and 05030 are merged and regarded "General Capital Formation". A YES in any of these fields will be regarded a YES in the German combined field.  |

element

**EMT\_V3\_FinancialInstrumentType/TargetMarket/ClientObjectives/ReturnProfile/OptionOrLeveraged**

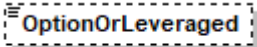
|            |  |
|------------|--|
| diagram    | <br><b>OptionOrLeveraged</b><br>05050: Yes or No or Neutral |
| type       | <a href="#">EMTYesNoNeutralType</a>  |
| properties | isRef 0<br>minOcc 0<br>maxOcc 1<br>content simple  |
| facets     | Kind Value annotation<br>minLength 1<br>maxLength 7  |
| annotation | documentation<br>05050: Yes or No or Neutral   |

element

**EMT\_V3\_FinancialInstrumentType/TargetMarket/ClientObjectives/ReturnProfile/PensionSchemeGermany**

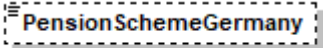
|            |   |
|------------|---|
| diagram    | <br><b>PensionSchemeGermany</b><br>05070: Yes or No or Neutral |
| type       | <a href="#">EMTYesNoNeutralType</a>   |
| properties | isRef 0<br>minOcc 0<br>maxOcc 1<br>content simple   |
| facets     | Kind Value annotation<br>minLength 1  |

|            |  |
|------------|--|
|            | maxLength 7                                  |
| annotation | documentation<br>05070: Yes or No or Neutral |

element

**EMT\_V3\_FinancialInstrumentType/TargetMarket/ClientObjectives/ReturnProfile/StructuredSecurity**

|            |   |
|------------|---|
| diagram    | <p>05040: Yes or No or Neutral<br/>Only for structured Securities</p> |
| properties | isRef 0<br>minOcc 0<br>maxOcc 1<br>content complex                    |
| children   | <a href="#">Hedging</a>   |

element

**EMT\_V3\_FinancialInstrumentType/TargetMarket/ClientObjectives/ReturnProfile/StructuredSecurity/Hedging**

|            |  |
|------------|--|
| diagram    | <p>05040: Yes or No or Neutral<br/>Only for structured Securities</p>          |
| type       | <a href="#">EMTYesNoNeutralType</a>  |
| properties | isRef 0<br>content simple  |
| facets     | Kind Value annotation<br>minLength 1<br>maxLength 7                            |
| annotation | documentation<br>05040: Yes or No or Neutral<br>Only for structured Securities |

element

**EMT\_V3\_FinancialInstrumentType/TargetMarket/ClientObjectives/MinimumRecommendedHoldingPeriod**

|            |   |
|------------|---|
| diagram    | <p>05080: Minimum recommended holding period<br/>RHP: Recommended Holding Period</p> <p><b>Years</b><br/>Minimum recommended holding period in years</p> <p><b>Category</b><br/>V ... Very short term (max 1Y)<br/>S ... Short term (max 3Y)<br/>M ... Medium term (max 5Y)<br/>L ... Long term (min 5Y)<br/>H ... Hold to Maturity</p> |
| properties | isRef 0<br>content complex  |
| children   | <a href="#">Years</a> <a href="#">Category</a>  |



|            |   |
|------------|---|
| annotation | documentation<br>05080: Minimum recommended holding period<br>RHP: Recommended Holding Period |
|------------|---|

element

**EMT\_V3\_FinancialInstrumentType/TargetMarket/ClientObjectives/MinimumRecommendedHoldingPeriod/Years**

|            |  |
|------------|--|
| diagram    |  <p>Minimum recommended holding period in years</p> |
| type       | <b>xs:decimal</b>  |
| properties | isRef 0<br>content simple  |
| annotation | documentation<br>Minimum recommended holding period in years   |

element

**EMT\_V3\_FinancialInstrumentType/TargetMarket/ClientObjectives/MinimumRecommendedHoldingPeriod/Category**

|            |  |
|------------|--|
| diagram    |  <p>V ... Very short term (max 1Y)<br/>S ... Short term (max 3Y)<br/>M ... Medium term (max 5Y)<br/>L ... Long term (min 5Y)<br/>H ... Hold to Maturity</p> |
| type       | restriction of <b>xs:string</b>  |
| properties | isRef 0<br>content simple  |
| annotation | documentation<br>V ... Very short term (max 1Y)<br>S ... Short term (max 3Y)<br>M ... Medium term (max 5Y)<br>L ... Long term (min 5Y)<br>H ... Hold to Maturity   |

element

**EMT\_V3\_FinancialInstrumentType/TargetMarket/ClientObjectives/IntendedCompatibleWithClientsHavingESGPreferences**

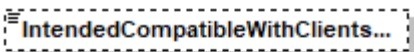
|            |  |
|------------|--|
| diagram    |  <p>05105: Discloses if the product is developed with the aim of being compatible with clients having ESG preferences. (Yes or Neutral).<br/>There is no Negative Target Market</p> |
| type       | <b>EMTYesNeutralType</b>   |
| properties | isRef 0<br>minOcc 0<br>maxOcc 1<br>content simple  |

|            |   |
|------------|---|
| facets     | Kind Value annotation<br>minLength 1<br>maxLength 7   |
| annotation | documentation<br>05105: Discloses if the product is developed with the aim of being compatible with clients having ESG preferences. (Yes or Neutral).<br>There is no Negative Target Market |

element

**EMT\_V3\_FinancialInstrumentType/TargetMarket/ClientObjectives/OtherSpecificInvestmentNeed**

|            |  |
|------------|--|
| diagram    |  |
| type       | restriction of <b>xs:string</b>  |
| properties | isRef 0<br>content simple  |
| facets     | Kind Value annotation<br>length 1  |
| annotation | documentation<br>05115: No, Islamic banking or Other<br>N...No,<br>I... Islamic banking<br>or O... Other |

element **EMT\_V3\_FinancialInstrumentType/TargetMarket/DistributionStrategy**

|            |   |
|------------|---|
| diagram    |   |
| properties | isRef 0<br>content complex  |
| children   | <a href="#">ExecutionOnly</a> <a href="#">ExecutionWithCheckOrNonAdvisedServices</a> <a href="#">InvestmentAdvice</a> <a href="#">PortfolioManagement</a> |
| annotation | documentation<br>Target markets - Distribution Strategy   |

element **EMT\_V3\_FinancialInstrumentType/TargetMarket/DistributionStrategy/ExecutionOnly**

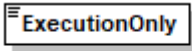
|            |   |
|------------|---|
| diagram    |  <p>06010: Retail or Professional or Both or Neither</p> |
| type       | <a href="#">RetailProfessionalBothNeitherType</a>   |
| properties | isRef 0<br>content simple   |
| facets     | Kind Value annotation<br>length 1   |
| annotation | documentation<br>06010: Retail or Professional or Both or Neither   |

element **EMT\_V3\_FinancialInstrumentType/TargetMarket/DistributionStrategy/ExecutionWithCheckOrNonAdvisedServices**

|            |   |
|------------|---|
| diagram    |  <p>06020: Retail or Professional or Both or Neither</p> |
| type       | <a href="#">RetailProfessionalBothNeitherType</a>   |
| properties | isRef 0<br>content simple   |
| facets     | Kind Value annotation<br>length 1   |
| annotation | documentation<br>06020: Retail or Professional or Both or Neither   |

element **EMT\_V3\_FinancialInstrumentType/TargetMarket/DistributionStrategy/InvestmentAdvice**

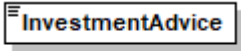
|            |   |
|------------|---|
| diagram    |  <p>06030: Retail or Professional or Both or Neither</p> |
| type       | <a href="#">RetailProfessionalBothNeitherType</a>   |
| properties | isRef 0<br>content simple   |
| facets     | Kind Value annotation<br>length 1   |
| annotation | documentation<br>06030: Retail or Professional or Both or Neither   |

element **EMT\_V3\_FinancialInstrumentType/TargetMarket/DistributionStrategy/PortfolioManagement**

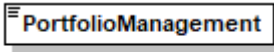
|            |   |
|------------|---|
| diagram    |  <p>06040: Retail or Professional or Both or Neither</p> |
| type       | <a href="#">RetailProfessionalBothNeitherType</a>   |
| properties | isRef 0<br>content simple   |
| facets     | Kind Value annotation   |

|            |   |
|------------|---|
|            | length 1  |
| annotation | documentation<br>06040: Retail or Professional or Both or Neither |

element **EMT\_V3\_FinancialInstrumentType/CostsAndChargesExAnte**

|            |   |
|------------|---|
| diagram    | <p><b>CostsAndChargesExAnte</b><br/>Costs and Charges ex ante</p> <p><b>Fund</b><br/>Relevant fields for funds</p> <p><b>StructuredSecurity</b><br/>Relevant fields for structured securities</p> <p><b>CostsReferenceDate</b><br/>07160 : The Reference Date to which all Ex-Ante Cost disclosures refer (i.e NOT to be mistaken for General Reference Date, field 00050 or Generation Date and Time, field 00005)</p> |
| properties | isRef 0<br>content complex  |
| children   | <a href="#">Fund</a> <a href="#">StructuredSecurity</a> <a href="#">CostsReferenceDate</a>  |
| annotation | documentation<br>Costs and Charges ex ante  |

element EMT\_V3 FinancialInstrumentType/CostsAndChargesExAnte/Fund

diagram



**GrossMaxEntryCostNonAcquired**  
 07020 Maximum not acquired to the fund. Expressed as a % of the amount to be invested. This data is a maximum cost not required to the fund. It is indicative and should be adapted by the distributor reserving the file to take into account the commercial agreement with the asset manager. Conditional to the existence of the feature.

**NetEntryCostNonAcquired**  
 07021 Expressed as a % of the amount to be invested. Subscription NAV - Par Value. Applicable for Structured Fund.

**MaxEntryCostDaily**  
 07020 Maximum fixed amount per subscription, not incorporated. Flat fee defined by the manufacturer (linked to Paying Agent). Only for the Italian Market. Conditional to the existence of the feature. It is subscription related but decided by the manufacturer. In all cases it must be adapted to the specific relationship between the manufacturer and the distributor. This cost is not taken in account in the entry cost item 07020.

**MaxEntryCostAcquired**  
 07040 Subscription fees acquired to the fund. Expressed as a % of the amount to be invested. Not included in the entry cost 07020. Conditional to the fact that the fund has this feature.

**MaxExitCost**  
 07030 Maximum cost acquired to the fund. Expressed as a % of the NAV. Maximum fees not acquired to the funds that could happen at a certain time during the life of the product. Conditional to the existence of this feature.

**MaxExitCostDaily**  
 07060 Maximum fixed amount per redemption, not incorporated. Flat fee defined by the manufacturer. Only for the Italian Market. Conditional to the existence of the feature. It is redemption related but decided by the manufacturer. In all cases it must be adapted to the specific relationship between the manufacturer and the distributor. This cost is not taken in account in the exit cost item 07030.

**MaxExitCostAcquired**  
 07070 Maximum Exit fees acquired to the fund. Expressed as a % of the NAV. Not included in the exit cost item 07030. Conditional to the existence of the feature.

**TypicalExitCost**  
 07080 Current exit cost linked to the RSP or Time to Maturity or 3Y (V) or 3Y(S) or 5Y (M U) (the value of 0000). Minimum, Assumed, and Holding Period.

**ExitCostPriorRSP**  
 07090 Expressed as a % of the amount to be Divested (Flat Value - Exit Value (eg bid price). For Structured Fund only.

**OngoingCosts**  
 07100 % of NAV of the Financial Product expressed in annualized terms (rate of cost deduction to be applied). Ongoing costs include management fees and distribution fees and exclude all transaction costs, incidental costs and performance fees. Costs reported should reflect current running ongoing costs.

**BorrowingCosts**  
 07120 Financing costs related to borrowing for the purpose of paying, expressed as a % of NAV of the Financial Product expressed in annualized terms (rate of cost deduction to be applied). Only applicable if the product is borrowing. Borrowing costs are included in Ongoing costs.

**ManagementFee**  
 07110 % of NAV of the Financial Product expressed in annualized terms (rate of cost deduction to be applied). These fees are included in total on-going costs. These fees are used by distributors to calculate their gross spread fees. Costs reported should reflect current running management costs.

**DistributionFee**  
 07120 % of NAV of the Financial Product expressed in annualized terms (rate of cost deduction to be applied).

**TransactionCosts**  
 07130 % of NAV of the Financial Product expressed in annualized terms (rate of cost deduction to be applied). 0 for reinvested premium. Costs within the products.

**IncidentalCosts**  
 07140 % of NAV of the Financial Product expressed in annualized terms (rate of cost deduction to be applied). Includes Performance Fees and other costs.

|            |  |
|------------|--|
| properties | isRef 0<br>content complex   |
| children   | <a href="#">GrossMaxEntryCostNonAcquired</a> <a href="#">NetEntryCostNonAcquired</a> <a href="#">MaxEntryCostItaly</a> <a href="#">MaxEntryCostAcquired</a> <a href="#">MaxExitCost</a> <a href="#">MaxExitCostItaly</a> <a href="#">MaxExitCostAcquired</a> <a href="#">TypicalExitCost</a> <a href="#">ExitCostPriorRHP</a> <a href="#">OngoingCosts</a> <a href="#">BorrowingCostsUK</a> <a href="#">ManagementFee</a> <a href="#">DistributionFee</a> <a href="#">TransactionCosts</a> <a href="#">IncidentalCosts</a> |
| annotation | documentation<br>Relevant fields for funds   |

element

**EMT\_V3\_FinancialInstrumentType/CostsAndChargesExAnte/Fund/GrossMaxEntryCostNonAcquired**

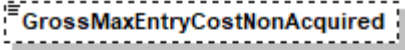
|            |   |
|------------|---|
| diagram    |  <p>07020: Maximum not acquired to the fund. Expressed as a % of the amount to be invested. This data is a maximum cost not acquired to the fund.. It is indicative and should be adapted by the distributor receiving the file to take into account the commercial agreement with the asset manager. Conditional to the existence of this feature</p> |
| type       | <b>xs:decimal</b>   |
| properties | isRef 0<br>minOcc 0<br>maxOcc 1<br>content simple   |
| annotation | documentation<br>07020: Maximum not acquired to the fund. Expressed as a % of the amount to be invested. This data is a maximum cost not acquired to the fund.. It is indicative and should be adapted by the distributor receiving the file to take into account the commercial agreement with the asset manager. Conditional to the existence of this feature   |

element **EMT\_V3\_FinancialInstrumentType/CostsAndChargesExAnte/Fund/NetEntryCostNonAcquired**

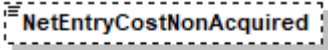
|            |  |
|------------|--|
| diagram    |  <p>07025: Expressed as a % of the amount to be invested. Subscription NAV - Fair Value. Applicable for Structured Fund</p> |
| type       | <b>xs:decimal</b>  |
| properties | isRef 0<br>minOcc 0<br>maxOcc 1<br>content simple  |
| annotation | documentation<br>07025: Expressed as a % of the amount to be invested. Subscription NAV - Fair Value. Applicable for Structured Fund   |

element **EMT\_V3\_FinancialInstrumentType/CostsAndChargesExAnte/Fund/MaxEntryCostItaly**

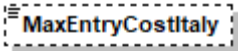
|            |   |
|------------|---|
| diagram    |  <p>07030: Maximum fixed amount per subscription, not incorporated. Flat fixed fee defined by the manufacturer (Linked to Paying Agent) Only for the Italian Market. Conditionnal to the existence of the feature<br/>It is subscription related but decided by the manufacturers. In all cases it must be adapted to the specific relationship between the manufacturers and the distribution. This cost is not taken in account in the entry cost item 07020</p> |
| type       | restriction of <b>xs:decimal</b>  |
| properties | isRef 0<br>minOcc 0<br>maxOcc 1<br>content simple   |
| facets     | Kind Value annotation<br>minInclusive 0   |
| annotation | documentation<br>07030: Maximum fixed amount per subscription, not incorporated. Flat fixed fee defined by the manufacturer (Linked to Paying Agent)<br>Only for the Italian Market. Conditionnal to the existence of the feature<br>It is subscription related but decided by the manufacturers. In all cases it must be adapted to the specific relationship between the manufacturers and the distribution. This cost is not taken in account in the entry cost item 07020   |

element **EMT\_V3\_FinancialInstrumentType/CostsAndChargesExAnte/Fund/MaxEntryCostAcquired**

|            |  |
|------------|--|
| diagram    |  <p>07040: Subscription fees acquired to the fund<br/>Expressed as a % of the amount to be invested.<br/>Not included in the entry cost 07020. Conditionnal to the fact that the fund has this feature.</p> |
| type       | restriction of <b>xs:decimal</b>   |
| properties | isRef 0<br>minOcc 0<br>maxOcc 1<br>content simple  |
| facets     | Kind Value annotation<br>minInclusive 0  |
| annotation | documentation<br>07040: Subscription fees acquired to the fund<br>Expressed as a % of the amount to be invested.<br>Not included in the entry cost 07020. Conditionnal to the fact that the fund has this feature.   |

element **EMT\_V3\_FinancialInstrumentType/CostsAndChargesExAnte/Fund/MaxExitCost**

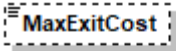
|            |   |
|------------|---|
| diagram    |  <p>07050: Maximum not acquired to the fund Expressed as a % of the NAV.<br/>Maximum fees not acquired to the funds that could happen at a certain time during the life of the product. Conditional to the existence of this feature</p> |
| type       | restriction of <b>xs:decimal</b>  |
| properties | <p>isRef 0<br/>minOcc 0<br/>maxOcc 1<br/>content simple</p>   |
| facets     | <p>Kind Value annotation<br/>minInclusive 0</p>   |
| annotation | <p>documentation<br/>07050: Maximum not acquired to the fund Expressed as a % of the NAV.<br/>Maximum fees not acquired to the funds that could happen at a certain time during the life of the product. Conditional to the existence of this feature</p>   |

element **EMT\_V3\_FinancialInstrumentType/CostsAndChargesExAnte/Fund/MaxExitCostItaly**

|            |   |
|------------|---|
| diagram    |  <p>07060: Maximum fixed amount per redemption, not incorporated. Flat fee defined by the manufacturer. Only for the Italian Market. Conditionnal to the existence of the feature.<br/>It is redemption related but decided by the manufacturers.In all cases it must be adapted to the specific relationship between the manufacturers and the distribution. This cost is not taken in account in the exit cost item 07050</p> |
| type       | restriction of <b>xs:decimal</b>  |
| properties | <p>isRef 0<br/>minOcc 0<br/>maxOcc 1<br/>content simple</p>   |
| facets     | <p>Kind Value annotation<br/>minInclusive 0</p>   |
| annotation | <p>documentation<br/>07060: Maximum fixed amount per redemption, not incorporated. Flat fee defined by the manufacturer. Only for the Italian Market. Conditionnal to the existence of the feature.<br/>It is redemption related but decided by the manufacturers.In all cases it must be adapted to the specific relationship between the manufacturers and the distribution. This cost is not taken in account in the exit cost item 07050</p>  |

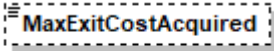

element **EMT\_V3\_FinancialInstrumentType/CostsAndChargesExAnte/Fund/MaxExitCostAcquired**

|            |  |
|------------|--|
| diagram    |  <p><b>MaxExitCostAcquired</b></p> <p>07070: Maximum Exit fees acquired to the fund Expressed as a % of the NAV. Not included in the exit cost item 07050 . Conditional to the existence of this feature.</p> |
| type       | restriction of <b>xs:decimal</b>   |
| properties | isRef 0<br>minOcc 0<br>maxOcc 1<br>content simple  |
| facets     | Kind Value annotation<br>minInclusive 0  |
| annotation | documentation<br>07070: Maximum Exit fees acquired to the fund Expressed as a % of the NAV. Not included in the exit cost item 07050 . Conditional to the existence of this feature.   |

element **EMT\_V3\_FinancialInstrumentType/CostsAndChargesExAnte/Fund/TypicalExitCost**

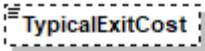
|            |  |
|------------|--|
| diagram    |  <p><b>TypicalExitCost</b></p> <p>07080: Current exit cost linked to the RHP or Time to Maturity or 1Y (V) or 3Y(S) or 5Y (M L) (the value of 05080_Minimum_Recommended_Holding_Period)</p> |
| type       | restriction of <b>xs:decimal</b>   |
| properties | isRef 0<br>minOcc 0<br>maxOcc 1<br>content simple  |
| facets     | Kind Value annotation<br>minInclusive 0  |
| annotation | documentation<br>07080: Current exit cost linked to the RHP or Time to Maturity or 1Y (V) or 3Y(S) or 5Y (M L) (the value of 05080_Minimum_Recommended_Holding_Period)   |

element **EMT\_V3\_FinancialInstrumentType/CostsAndChargesExAnte/Fund/ExitCostPriorRHP**

|            |  |
|------------|--|
| diagram    |  <p><b>ExitCostPriorRHP</b></p> <p>07090: Expressed as a % of the amount to be divested. Fair Value - Exit Value (eg Bid Price). For Structured Fund only</p> |
| type       | restriction of <b>xs:decimal</b>   |
| properties | isRef 0<br>minOcc 0<br>maxOcc 1<br>content simple  |
| facets     | Kind Value annotation  |

|            |   |
|------------|---|
|            | minInclusive 0  |
| annotation | documentation<br>07090: Expressed as a % of the amount to be divested. Fair Value - Exit Value (eg Bid Price). For Structured Fund only |

element **EMT\_V3\_FinancialInstrumentType/CostsAndChargesExAnte/Fund/OngoingCosts**

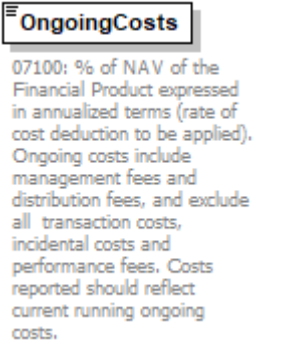
|            |   |
|------------|---|
| diagram    |    |
| type       | restriction of <b>xs:decimal</b>  |
| properties | isRef 0<br>content simple   |
| facets     | Kind Value annotation<br>minInclusive 0   |
| annotation | documentation<br>07100: % of NAV of the Financial Product expressed in annualized terms (rate of cost deduction to be applied). Ongoing costs include management fees and distribution fees, and exclude all transaction costs, incidental costs and performance fees. Costs reported should reflect current running ongoing costs. |

element **EMT\_V3\_FinancialInstrumentType/CostsAndChargesExAnte/Fund/BorrowingCostsUK**

|            |   |
|------------|---|
| diagram    |   |
| type       | <b>xs:decimal</b>   |
| properties | isRef 0<br>minOcc 0<br>maxOcc 1<br>content simple   |
| annotation | documentation<br>07105: Financing costs related to borrowing for the purposes of gearing expressed as a % of NAV of the Financial Product expressed in annualized terms (rate of cost deduction to be applied). Only applicable if the product is borrowing. Borrowing costs are included in Ongoing costs. |

element **EMT\_V3\_FinancialInstrumentType/CostsAndChargesExAnte/Fund/ManagementFee**

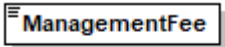
|            |  |
|------------|--|
| diagram    |  <p>07110: % of NAV of the Financial Product expressed in annualized terms (rate of cost deduction to be applied). These fees are included in total on going costs. These fees are used by distributors to calculate their retrocession fees. Costs reported should reflect current running management costs.</p> |
| type       | restriction of <b>xs:decimal</b>   |
| properties | isRef 0<br>content simple  |
| facets     | Kind Value annotation<br>minInclusive 0  |
| annotation | documentation<br>07110: % of NAV of the Financial Product expressed in annualized terms (rate of cost deduction to be applied). These fees are included in total on going costs. These fees are used by distributors to calculate their retrocession fees. Costs reported should reflect current running management costs.   |

element **EMT\_V3\_FinancialInstrumentType/CostsAndChargesExAnte/Fund/DistributionFee**

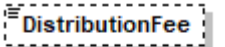
|            |  |
|------------|--|
| diagram    |  <p>07120: % of NAV of the Financial Product expressed in annualized terms (rate of cost deduction to be applied)</p> |
| type       | restriction of <b>xs:decimal</b>   |
| properties | isRef 0<br>minOcc 0<br>maxOcc 1<br>content simple  |
| facets     | Kind Value annotation<br>minInclusive 0  |
| annotation | documentation<br>07120: % of NAV of the Financial Product expressed in annualized terms (rate of cost deduction to be applied)   |

element **EMT\_V3\_FinancialInstrumentType/CostsAndChargesExAnte/Fund/TransactionCosts**

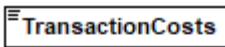
|            |  |
|------------|--|
| diagram    |  <p>07130: % of NAV of the Financial Product expressed in annualized terms (rate of cost deduction to be applied). 0 for structured products. Costs within the products</p> |
| type       | restriction of <b>xs:decimal</b>   |
| properties | isRef 0<br>content simple  |
| facets     | Kind Value annotation<br>minInclusive 0  |
| annotation | documentation<br>07130: % of NAV of the Financial Product expressed in annualized terms (rate of cost deduction to be applied).  |

|  |
|--|
| 0 for structured products. Costs within the products |
|--|

element **EMT\_V3\_FinancialInstrumentType/CostsAndChargesExAnte/Fund/IncidentalCosts**

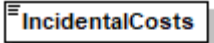
|            |  |
|------------|--|
| diagram    |  <p>07140: % of NAV of the Financial Product expressed in annualized terms (rate of cost deduction to be applied). Includes Performance Fees and other costs.</p> |
| type       | restriction of <b>xs:decimal</b>   |
| properties | isRef 0<br>content simple  |
| facets     | Kind Value annotation<br>minInclusive 0  |
| annotation | documentation<br>07140: % of NAV of the Financial Product expressed in annualized terms (rate of cost deduction to be applied). Includes Performance Fees and other costs.   |

element **EMT\_V3\_FinancialInstrumentType/CostsAndChargesExAnte/StructuredSecurity**

diagram

**StructuredSecurity**  
Relevant fields for structured securities

**GrossMaxEntryCostNonAcquired**

07020:  
"Ask Price" - Fair Value ( as of Reference Date Ex-Ante ).  
This data should only incorporate manufacturer costs (i.e. cost of the financial instrument) and distributor upfront when known by the manufacturer. It should however NOT include distribution fees added on top of the product price by distributors that is out of control of the manufacturer.

**NetEntryCostNonAcquired**

07025: Net\_One-off Entry cost = 07020 less upfront distribution fee embedded in the 07020. In practice 07025 will be the portion of the 07020 retained by the manufacturer. This data is optional and could be used in the event of only one layer of intermediation or in a case where distributor up fronts are paid equally to all distributors. The costs reported in this field is a Net disclosure and therefore the distributor upfront is equal to the difference between 07020 and 07025.

**TypicalExitCost**

07080: Exit cost at the RHP

**ExitCostPriorRHP**

07090: Fixed amount

**OngoingCosts**

07100: Expressed as a % of NAV / Notional (or currency amount for Absolute quotation) of the Financial Product in annualized terms related to Reference in 07150 or 07155 respectively.

**ManagementFee**

07110: Expressed as a % of NAV / Notional (or currency amount for Absolute quotation) of the Financial Product in annualized terms related to Reference Value in 07150 or 07155 respectively. These fees are included in total on going costs. Only applicable if the product has this feature. These fees are used by distributors to calculate their retrocession fees

**IncidentalCostsExAnte**

07140: Expressed as a % of NAV / Notional (or currency amount for Absolute quotation) of the Financial Product in annualized terms related to Reference Value in 07150 or 07155 respectively.

**ReferencePrice**

07150: The Notional Reference Amount is the amount expressed in number of currency units to which a Unit disclosed Ex-Post cost is based and to which a Percentage disclosed cost should be multiplied in order to retrieve the Unit cost. This field is conditional and only used if 07150 is not used.

**NotionalReferenceAmount**

07155: Expressed as a % of NAV / Notional (or currency amount for Absolute quotation) of the Financial Product in annualized terms related to Reference Value in 07150 or 07155 respectively.

|            |   |
|------------|---|
| properties | isRef 0<br>content complex  |
| children   | <a href="#">GrossMaxEntryCostNonAcquired</a> <a href="#">NetEntryCostNonAcquired</a> <a href="#">TypicalExitCost</a> <a href="#">ExitCostPriorRHP</a> <a href="#">OngoingCosts</a> <a href="#">ManagementFee</a> <a href="#">IncidentalCostsExAnte</a> <a href="#">ReferencePrice</a> <a href="#">NotionalReferenceAmount</a> |
| annotation | documentation<br>Relevant fields for structured securities  |

element

**EMT\_V3\_FinancialInstrumentType/CostsAndChargesExAnte/StructuredSecurity/GrossMaxEntryCostNonAcquired**

|            |   |
|------------|---|
| diagram    |  <p>07020:<br/>"Ask Price" - Fair Value ( as of Reference Date Ex-Ante ).<br/>This data should only incorporate manufacturer costs (i.e. cost of the financial instrument) and distributor upfront when known by the manufacturer. It should however NOT include distribution fees added on top of the product price by distributors that is out of control of the manufacturer.</p> |
| type       | <b>xs:decimal</b>   |
| properties | isRef 0<br>content simple   |
| annotation | documentation<br>07020:<br>"Ask Price" - Fair Value ( as of Reference Date Ex-Ante ).<br>This data should only incorporate manufacturer costs (i.e. cost of the financial instrument) and distributor upfront when known by the manufacturer. It should however NOT include distribution fees added on top of the product price by distributors that is out of control of the manufacturer.   |

element

**EMT\_V3\_FinancialInstrumentType/CostsAndChargesExAnte/StructuredSecurity/NetEntryCostNonAcquired**

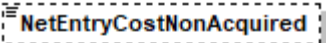
|            |   |
|------------|---|
| diagram    |  <p>07025: Net_One-off Entry cost = 07020 less upfront distribution fee embedded in the 07020. In practice 07025 will be the portion of the 07020 retained by the manufacturer. This data is optional and could be used in the event of only one layer of intermediation or in a case where distributor up fronts are paid equally to all distributors. The costs reported in this field is a Net disclosure and therefore the distributor upfront is equal to the difference between 07020 and 07025.</p> |
| type       | <b>xs:decimal</b>   |
| properties | isRef 0<br>minOcc 0<br>maxOcc 1<br>content simple   |
| annotation | documentation<br>07025: Net_One-off Entry cost = 07020 less upfront distribution fee embedded in the 07020. In practice 07025 will be the portion of the 07020 retained by the manufacturer.<br>This data is optional and could be used in the event of only one layer of intermediation or in a case where distributor up  |

|  |   |
|--|---|
|  | fronts are paid equally to all distributors. The costs reported in this field is a Net disclosure and therefore the distributor upfront is equal to the difference between 07020 and 07025. |
|--|---|

element

**EMT\_V3\_FinancialInstrumentType/CostsAndChargesExAnte/StructuredSecurity/TypicalExitCost**

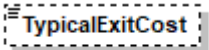
|            |  |
|------------|--|
| diagram    |  <p>07080: Exit cost at the RHP</p> |
| type       | <b>xs:decimal</b>  |
| properties | isRef 0<br>minOcc 0<br>maxOcc 1<br>content simple  |
| annotation | documentation<br>07080: Exit cost at the RHP   |

element

**EMT\_V3\_FinancialInstrumentType/CostsAndChargesExAnte/StructuredSecurity/ExitCostPriorRHP**

|            |  |
|------------|--|
| diagram    |  <p>07090: Fixed amount</p> |
| type       | <b>xs:decimal</b>  |
| properties | isRef 0<br>content simple  |
| annotation | documentation<br>07090: Fixed amount   |

element **EMT\_V3\_FinancialInstrumentType/CostsAndChargesExAnte/StructuredSecurity/OngoingCosts**

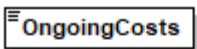
|            |  |
|------------|--|
| diagram    |  <p>07100: Expressed as a % of NAV / Notional (or currency amount for Absolute quotation) of the Financial Product in annualized terms related to Reference in 07150 or 07155 respectively.</p> |
| type       | <b>xs:decimal</b>  |
| properties | isRef 0<br>content simple  |
| annotation | documentation<br>07100: Expressed as a % of NAV / Notional (or currency amount for Absolute quotation) of the Financial Product in annualized terms related to Reference in 07150 or 07155 respectively.   |

element

**EMT\_V3\_FinancialInstrumentType/CostsAndChargesExAnte/StructuredSecurity/ManagementFee**

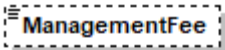
|            |   |
|------------|---|
| diagram    |  <p>07110: Expressed as a % of NAV / Notional (or currency amount for Absolute quotation) of the Financial Product in annualized terms related to Reference Value in 07150 or 07155 respectively. These fees are included in total on going costs. Only applicable if the product has this feature. These fees are used by distributors to calculate their retrocession fees</p> |
| type       | <b>xs:decimal</b>   |
| properties | isRef 0<br>minOcc 0<br>maxOcc 1<br>content simple   |
| annotation | documentation<br>07110: Expressed as a % of NAV / Notional (or currency amount for Absolute quotation) of the Financial Product in annualized terms related to Reference Value in 07150 or 07155 respectively. These fees are included in total on going costs. Only applicable if the product has this feature. These fees are used by distributors to calculate their retrocession fees   |

element

**EMT\_V3\_FinancialInstrumentType/CostsAndChargesExAnte/StructuredSecurity/IncidentalCostsExAnte**

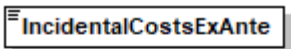
|            |  |
|------------|--|
| diagram    |  <p>07140: Expressed as a % of NAV / Notional (or currency amount for Absolute quotation) of the Financial Product in annualized terms related to Reference Value in 07150 or 07155 respectively.</p> |
| type       | restriction of <b>xs:decimal</b>   |
| properties | isRef 0<br>content simple  |
| annotation | documentation<br>07140: Expressed as a % of NAV / Notional (or currency amount for Absolute quotation) of the Financial Product in annualized terms related to Reference Value in 07150 or 07155 respectively.   |



element

**EMT\_V3\_FinancialInstrumentType/CostsAndChargesExAnte/StructuredSecurity/ReferencePrice**

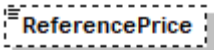
|            |   |
|------------|---|
| diagram    |  <p>07150: The Notional Reference Amount is the amount expressed in number of currency units to which a Unit disclosed Ex-Post cost is based and to which a Percentage disclosed cost should be multiplied in order to retrieve the Unit cost. This field is conditional and only used if 07150 is not used.</p> |
| type       | <b>xs:decimal</b>   |
| properties | <p>isRef 0<br/> minOcc 0<br/> maxOcc 1<br/> content simple</p>  |
| annotation | <p>documentation<br/> 07150: The Notional Reference Amount is the amount expressed in number of currency units to which a Unit disclosed Ex-Post cost is based and to which a Percentage disclosed cost should be multiplied in order to retrieve the Unit cost. This field is conditional and only used if 07150 is not used.</p>  |

element

**EMT\_V3\_FinancialInstrumentType/CostsAndChargesExAnte/StructuredSecurity/NotionalReferenceAmount**

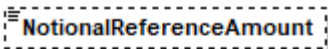
|            |  |
|------------|--|
| diagram    |  <p>07155: Expressed as a % of NAV / Notional (or currency amount for Absolute quotation) of the Financial Product in annualized terms related to Reference Value in 07150 or 07155 respectively.</p> |
| type       | <b>xs:decimal</b>  |
| properties | <p>isRef 0<br/> minOcc 0<br/> maxOcc 1<br/> content simple</p>   |
| annotation | <p>documentation<br/> 07155: Expressed as a % of NAV / Notional (or currency amount for Absolute quotation) of the Financial Product in annualized terms related to Reference Value in 07150 or 07155 respectively.</p>  |

element **EMT\_V3\_FinancialInstrumentType/CostsAndChargesExAnte/CostsReferenceDate**

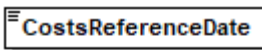
|            |   |
|------------|---|
| diagram    |  <p>07160 : The Reference Date to which all Ex-Ante Cost disclosures refer (i.e NOT to be mistaken for General Reference Date, field 00050 or Generation Date and Time, field 00005)</p> |
| type       | <b>xs:date</b>  |
| properties | <p>isRef 0</p>  |

|            |   |
|------------|---|
|            | content simple  |
| annotation | documentation<br>07160 : The Reference Date to which all Ex-Ante Cost disclosures refer (i.e NOT to be mistaken for General Reference Date, field 00050 or Generation Date and Time, field 00005) |

element **EMT\_V3\_FinancialInstrumentType/CostsAndChargesExPost**

|            |   |
|------------|---|
| diagram    |   |
| properties | isRef 0<br>minOcc 0<br>maxOcc 1<br>content complex                                      |
| children   | <a href="#">Fund</a> <a href="#">StructuredSecurity</a> <a href="#">ReferencePeriod</a> |
| annotation | documentation<br>Costs and Charges ex post  |

element **EMT\_V3\_FinancialInstrumentType/CostsAndChargesExPost/Fund**

|                   |  |
|-------------------|--|
| <p>diagram</p>    | <pre> classDiagram     class Fund {         "Relevant fields for funds"     }     class EntryCostAcquired     class OngoingCosts     class BorrowingCoststUK     class ManagementFee     class DistributionFee     class TransactionCosts     class IncidentalCosts     Fund --&gt; EntryCostAcquired     Fund --&gt; OngoingCosts     Fund --&gt; BorrowingCoststUK     Fund --&gt; ManagementFee     Fund --&gt; DistributionFee     Fund --&gt; TransactionCosts     Fund --&gt; IncidentalCosts     </pre> <p><b>EntryCostAcquired</b><br/>08025: % of NAV</p> <p><b>OngoingCosts</b><br/>08030: % of NAV of the Financial Product expressed in annualized terms (rate of cost deduction to be applied)</p> <p><b>BorrowingCoststUK</b><br/>08045: Financing costs related to borrowing for the purposes of gearing expressed as a % of NAV of the Financial Product expressed in annualized terms (rate of cost deduction to be applied)</p> <p><b>ManagementFee</b><br/>08050: % of NAV of the Financial Product expressed in annualized terms (rate of cost deduction to be applied)</p> <p><b>DistributionFee</b><br/>08060: % of NAV of the Financial Product expressed in annualized terms (rate of cost deduction to be applied). Only applicable if the product has this feature (legal wording in the documentation). These fees are included in total on going costs and are not included into the management fees.</p> <p><b>TransactionCosts</b><br/>08070: % of NAV of the Financial Product expressed in annualized terms (rate of cost deduction to be applied). Costs within the products</p> <p><b>IncidentalCosts</b><br/>08080: Incidental costs ex post % of NAV of the Financial Product expressed in annualized terms (rate of cost deduction to be applied)</p> |
| <p>properties</p> | <p>isRef 0<br/>content complex</p>   |
| <p>children</p>   | <p><a href="#">EntryCostAcquired</a> <a href="#">OngoingCosts</a> <a href="#">BorrowingCoststUK</a> <a href="#">ManagementFee</a> <a href="#">DistributionFee</a> <a href="#">TransactionCosts</a> <a href="#">IncidentalCosts</a></p>   |
| <p>annotation</p> | <p>documentation<br/>Relevant fields for funds</p>   |

element **EMT\_V3\_FinancialInstrumentType/CostsAndChargesExPost/Fund/EntryCostAcquired**

|            |  |
|------------|--|
| diagram    |  <p>08025:<br/>% of NAV</p> |
| type       | restriction of <b>xs:decimal</b>   |
| properties | isRef 0<br>minOcc 0<br>maxOcc 1<br>content simple  |
| annotation | documentation<br>08025:<br>% of NAV  |

element **EMT\_V3\_FinancialInstrumentType/CostsAndChargesExPost/Fund/OngoingCosts**

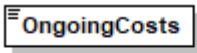
|            |  |
|------------|--|
| diagram    |  <p>08030: % of NAV of the Financial Product expressed in annualized terms (rate of cost deduction to be applied)</p> |
| type       | <b>xs:decimal</b>  |
| properties | isRef 0<br>content simple  |
| annotation | documentation<br>08030: % of NAV of the Financial Product expressed in annualized terms (rate of cost deduction to be applied)   |

element **EMT\_V3\_FinancialInstrumentType/CostsAndChargesExPost/Fund/BorrowingCoststUK**

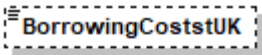
|            |  |
|------------|--|
| diagram    |  <p>08045: Financing costs related to borrowing for the purposes of gearing expressed as a % of NAV of the Financial Product expressed in annualized terms (rate of cost deduction to be applied)</p> |
| type       | <b>xs:decimal</b>  |
| properties | isRef 0<br>minOcc 0<br>maxOcc 1<br>content simple  |
| annotation | documentation<br>08045: Financing costs related to borrowing for the purposes of gearing expressed as a % of NAV of the Financial Product expressed in annualized terms (rate of cost deduction to be applied)   |

element **EMT\_V3\_FinancialInstrumentType/CostsAndChargesExPost/Fund/ManagementFee**

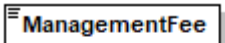
|            |  |
|------------|--|
| diagram    |  <p>08050: % of NAV of the Financial Product expressed in annualized terms (rate of cost deduction to be applied)</p> |
| type       | <b>xs:decimal</b>  |
| properties | isRef 0<br>content simple  |
| annotation | documentation<br>08050: % of NAV of the Financial Product expressed in annualized terms (rate of cost deduction to be applied)   |

element **EMT\_V3\_FinancialInstrumentType/CostsAndChargesExPost/Fund/DistributionFee**

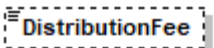
|            |  |
|------------|--|
| diagram    |  <p>08060:<br/>% of NAV of the Financial Product expressed in annualized terms (rate of cost deduction to be applied). Only applicable if the product has this feature (legal wording in the documentation). These fees are included in total on going costs and are not included into the management fees.</p> |
| type       | <b>xs:decimal</b>  |
| properties | isRef 0<br>minOcc 0<br>maxOcc 1<br>content simple  |
| annotation | documentation<br>08060:<br>% of NAV of the Financial Product expressed in annualized terms (rate of cost deduction to be applied). Only applicable if the product has this feature (legal wording in the documentation). These fees are included in total on going costs and are not included into the management fees.  |

element **EMT\_V3\_FinancialInstrumentType/CostsAndChargesExPost/Fund/TransactionCosts**

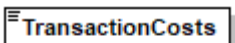
|            |   |
|------------|---|
| diagram    |  <p>08070: % of NAV of the Financial Product expressed in annualized terms (rate of cost deduction to be applied). Costs within the products</p> |
| type       | <b>xs:decimal</b>   |
| properties | isRef 0<br>content simple   |
| annotation | documentation<br>08070: % of NAV of the Financial Product expressed in annualized terms (rate of cost deduction to be applied). Costs within the products   |

element **EMT\_V3\_FinancialInstrumentType/CostsAndChargesExPost/Fund/IncidentalCosts**

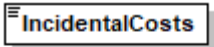
|            |   |
|------------|---|
| diagram    |  <p>08080: Incidental costs ex post<br/>% of NAV of the Financial Product expressed in annualized terms (rate of cost deduction to be applied)</p> |
| type       | <b>xs:decimal</b>   |
| properties | isRef 0<br>content simple   |
| annotation | documentation<br>08080: Incidental costs ex post<br>% of NAV of the Financial Product expressed in annualized terms (rate of cost deduction to be applied)  |

element **EMT\_V3\_FinancialInstrumentType/CostsAndChargesExPost/StructuredSecurity**

diagram

**StructuredSecurity**  
Relevant fields for structured securities

**GrossEntryCost**  
08010: This data should only incorporate manufacturer costs (i.e. cost of the financial instrument) and distributor upfront when known by the manufacturer. It should however NOT include distribution fees added on top of the product price by distributors that is out of control of the manufacturer.

**NetEntryCost**  
08015: Net one off entry cost ex post.  
Net One-off Entry cost = 08010 less upfront distribution fee embedded in the 08010. In practice 08015 will be the portion of the 08010 retained by the manufacturer.  
This data is optional and could be used in the event of only one layer of intermediation or in a case where distributor up fronts are paid equally to all distributors. The costs reported in this field is a Net disclosure and therefore the distributor upfront is equal to the difference between 08010 and 08025.

**ExitCost**  
08020:  
Fixed amount  
If 00096 set to U : number of units in product currency  
If 00096 set to P : % of Reference in field 08110 or 08120 respectively.  
This exit cost is supposed to be prior RHP

**OngoingCosts**  
08030: Expressed as a % of NAV / Notional (or currency amount for Absolute quotation) of the Financial Product in annualized terms related to Reference Value in 08110

**OngoingCostsAccumulated**  
08040: Sum of each daily Recurring Product Costs  
Presented in absolute figures in product currency accumulated during the year up until the End of Reference Date Period. Ex Post in field 08100.  
Mandatory field for Distribution in Germany, Switzerland and Austria

**ManagementFee**  
08050: Expressed as a % of NAV / Notional (or currency amount for Absolute quotation) of the Financial Product in annualized terms related to Reference Value in 08110.  
These fees are included in total on going costs. Only applicable if the product has this feature. These fees are used by distributors to calculate their retrocession fees

**IncidentalCosts**  
08080: Expressed as a % of NAV / Notional (or currency amount for Absolute quotation) of the Financial Product in annualized terms related to Reference Value in 08110  
If 00096 set to U : number of units in product currency  
If 00096 set to P : % of Reference in field 08110 or 08120 respectively.

**ReferencePrice**  
08110: The Reference Price is the instrument price to which a Unit disclosed Ex-Post cost is based and to which a Percentage disclosed cost should be multiplied in order to retrieve the Unit cost. This field is conditional and only used if 08120 is not used.

**NotionalReferenceAmount**  
080120: The Notional Reference Amount is the amount expressed in number of currency units to which a Unit disclosed Ex-Post cost is based and to which a Percentage disclosed cost should be multiplied in order to retrieve the Unit cost. This field is conditional and only used if 08110 is not used.



|            |  |
|------------|--|
| properties | isRef 0<br>content complex   |
| children   | <a href="#">GrossEntryCost</a> <a href="#">NetEntryCost</a> <a href="#">ExitCost</a> <a href="#">OngoingCosts</a> <a href="#">OngoingCostsAccumulated</a> <a href="#">ManagementFee</a> <a href="#">IncidentalCosts</a> <a href="#">ReferencePrice</a> <a href="#">NotionalReferenceAmount</a> |
| annotation | documentation<br>Relevant fields for structured securities   |

element

**EMT\_V3\_FinancialInstrumentType/CostsAndChargesExPost/StructuredSecurity/GrossEntryCost**

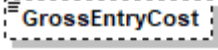
|            |  |
|------------|--|
| diagram    |  <p>08010: This data should only incorporate manufacturer costs (i.e. cost of the financial instrument) and distributor upfront when known by the manufacturer. It should however NOT include distribution fees added on top of the product price by distributors that is out of control of the manufacturer.</p> |
| type       | <b>xs:decimal</b>  |
| properties | isRef 0<br>minOcc 0<br>maxOcc 1<br>content simple  |
| annotation | documentation<br>08010: This data should only incorporate manufacturer costs (i.e. cost of the financial instrument) and distributor upfront when known by the manufacturer. It should however NOT include distribution fees added on top of the product price by distributors that is out of control of the manufacturer.   |

element **EMT\_V3\_FinancialInstrumentType/CostsAndChargesExPost/StructuredSecurity/NetEntryCost**

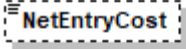
|            |  |
|------------|--|
| diagram    |  <p>08015: Net one off entry cost ex post<br/>Net One-off Entry cost = 08010 less upfront distribution fee embedded in the 08010. In practice 08015 will be the portion of the 08010 retained by the manufacturer.<br/>This data is optional and could be used in the event of only one layer of intermediation or in a case where distributor up fronts are paid equally to all distributors. The costs reported in this field is a Net disclosure and therefore the distributor upfront is equal to the difference between 08010 and 08025.</p> |
| type       | <b>xs:decimal</b>  |
| properties | isRef 0<br>minOcc 0<br>maxOcc 1<br>content simple  |

|            |   |
|------------|---|
| annotation | <p>documentation</p> <p>08015: Net one off entry cost ex post<br/> Net One-off Entry cost = 08010 less upfront distribution fee embedded in the 08010. In practice 08015 will be the portion of the 08010 retained by the manufacturer.</p> <p>This data is optional and could be used in the event of only one layer of intermediation or in a case where distributor up fronts are paid equally to all distributors. The costs reported in this field is a Net disclosure and therefore the distributor upfront is equal to the difference between 08010 and 08025.</p> |
|------------|---|

element **EMT\_V3\_FinancialInstrumentType/CostsAndChargesExPost/StructuredSecurity/ExitCost**

|            |  |
|------------|--|
| diagram    |  <p>08020:<br/> Fixed amount<br/> If 00096 set to U : number of units in product currency<br/> If 00096 set to P : % of Reference in field 08110 or 08120 respectively.<br/> This exit cost is supposed to be prior RHP</p> |
| type       | <b>xs:decimal</b>  |
| properties | isRef 0<br>minOcc 0<br>maxOcc 1<br>content simple  |
| annotation | <p>documentation</p> <p>08020:<br/> Fixed amount<br/> If 00096 set to U : number of units in product currency<br/> If 00096 set to P : % of Reference in field 08110 or 08120 respectively.<br/> This exit cost is supposed to be prior RHP</p>  |

element **EMT\_V3\_FinancialInstrumentType/CostsAndChargesExPost/StructuredSecurity/OngoingCosts**

|            |   |
|------------|---|
| diagram    |  <p>08030: Expressed as a % of NAV / Notional (or currency amount for Absolute quotation) of the Financial Product in annualized terms related to Reference Value in 08110</p> |
| type       | <b>xs:decimal</b>   |
| properties | isRef 0<br>content simple   |
| annotation | <p>documentation</p> <p>08030: Expressed as a % of NAV / Notional (or currency amount for Absolute quotation) of the Financial Product in annualized terms related to Reference Value in 08110</p>  |

element

**EMT\_V3\_FinancialInstrumentType/CostsAndChargesExPost/StructuredSecurity/OngoingCostsAccumulated**

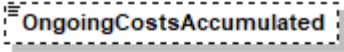
|            |  |
|------------|--|
| diagram    |  <p>08040: Sum of each daily Recurring Product Costs<br/>Presented in absolute figures in product currency accumulated during the year up until the End of Reference Date Period Ex Post in field 08100.<br/>Mandatory field for Distribution in Germany, Switzerland and Austria</p> |
| type       | <b>xs:decimal</b>  |
| properties | isRef 0<br>minOcc 0<br>maxOcc 1<br>content simple  |
| annotation | documentation<br>08040: Sum of each daily Recurring Product Costs<br>Presented in absolute figures in product currency accumulated during the year up until the End of Reference Date Period Ex Post in field 08100.<br>Mandatory field for Distribution in Germany, Switzerland and Austria   |

element

**EMT\_V3\_FinancialInstrumentType/CostsAndChargesExPost/StructuredSecurity/ManagementFee**

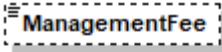
|            |  |
|------------|--|
| diagram    |  <p>08050: Expressed as a % of NAV / Notional (or currency amount for Absolute quotation) of the Financial Product in annualized terms related to Reference Value in 08110.<br/>These fees are included in total on going costs. Only applicable if the product has this feature. These fees are used by distributors to calculate their retrocession fees</p> |
| type       | <b>xs:decimal</b>  |
| properties | isRef 0<br>minOcc 0<br>maxOcc 1<br>content simple  |
| annotation | documentation<br>08050: Expressed as a % of NAV / Notional (or currency amount for Absolute quotation) of the Financial Product in annualized terms related to Reference Value in 08110.<br>These fees are included in total on going costs. Only applicable if the product has this feature. These fees are used by distributors to calculate their retrocession fees   |

element

**EMT\_V3 FinancialInstrumentType/CostsAndChargesExPost/StructuredSecurity/IncidentalCosts**

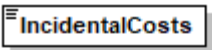
|            |  |
|------------|--|
| diagram    |  <p>08080: Expressed as a % of NAV / Notional (or currency amount for Absolute quotation) of the Financial Product in annualized terms related to Reference Value in 08110<br/>         If 00096 set to U : number of units in product currency<br/>         If 00096 set to P : % of Reference in field 08110 or 08120 respectively.</p> |
| type       | <b>xs:decimal</b>  |
| properties | isRef 0<br>content simple  |
| annotation | documentation<br>08080: Expressed as a % of NAV / Notional (or currency amount for Absolute quotation) of the Financial Product in annualized terms related to Reference Value in 08110<br>If 00096 set to U : number of units in product currency<br>If 00096 set to P : % of Reference in field 08110 or 08120 respectively.   |

element

**EMT\_V3 FinancialInstrumentType/CostsAndChargesExPost/StructuredSecurity/ReferencePrice**

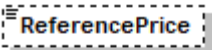
|            |  |
|------------|--|
| diagram    |  <p>08110: The Reference Price is the instrument price to which a Unit disclosed Ex-Post cost is based and to which a Percentage disclosed cost should be multiplied in order to retrieve the Unit cost. This field is conditional and only used if 08120 is not used.</p> |
| type       | <b>xs:decimal</b>  |
| properties | isRef 0<br>minOcc 0<br>maxOcc 1<br>content simple  |
| annotation | documentation<br>08110: The Reference Price is the instrument price to which a Unit disclosed Ex-Post cost is based and to which a Percentage disclosed cost should be multiplied in order to retrieve the Unit cost. This field is conditional and only used if 08120 is not used.  |

element

**EMT\_V3\_FinancialInstrumentType/CostsAndChargesExPost/StructuredSecurity/NotionalReferenceAmount**

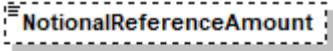
|            |  |
|------------|--|
| diagram    |  <p><b>NotionalReferenceAmount</b></p> <p>080120: The Notional Reference Amount is the amount expressed in number of currency units to which a Unit disclosed Ex-Post cost is based and to which a Percentage disclosed cost should be multiplied in order to retrieve the Unit cost. This field is conditional and only used if 08110 is not used.</p> |
| type       | <b>xs:decimal</b>  |
| properties | <p>isRef 0</p> <p>minOcc 0</p> <p>maxOcc 1</p> <p>content simple</p>   |
| annotation | <p>documentation</p> <p>080120: The Notional Reference Amount is the amount expressed in number of currency units to which a Unit disclosed Ex-Post cost is based and to which a Percentage disclosed cost should be multiplied in order to retrieve the Unit cost. This field is conditional and only used if 08110 is not used.</p>  |

element **EMT\_V3\_FinancialInstrumentType/CostsAndChargesExPost/ReferencePeriod**

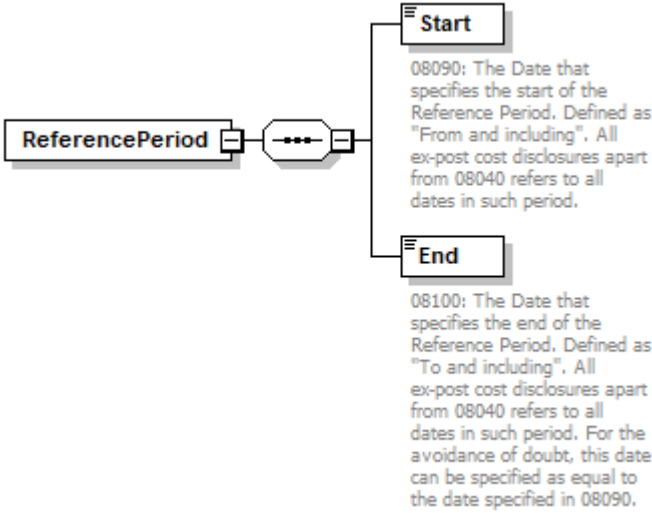
|            |  |
|------------|--|
| diagram    |  <p><b>ReferencePeriod</b></p> <p><b>Start</b></p> <p>08090: The Date that specifies the start of the Reference Period. Defined as "From and including". All ex-post cost disclosures apart from 08040 refers to all dates in such period.</p> <p><b>End</b></p> <p>08100: The Date that specifies the end of the Reference Period. Defined as "To and including". All ex-post cost disclosures apart from 08040 refers to all dates in such period. For the avoidance of doubt, this date can be specified as equal to the date specified in 08090.</p> |
| properties | <p>isRef 0</p> <p>content complex</p>  |
| children   | <a href="#">Start</a> <a href="#">End</a>  |

element **EMT\_V3\_FinancialInstrumentType/CostsAndChargesExPost/ReferencePeriod/Start**

|            |   |
|------------|---|
| diagram    |  <p>08090: The Date that specifies the start of the Reference Period. Defined as "From and including". All ex-post cost disclosures apart from 08040 refers to all dates in such period.</p> |
| type       | <b>xs:date</b>  |
| properties | isRef 0<br>content simple   |
| annotation | documentation<br>08090: The Date that specifies the start of the Reference Period. Defined as "From and including". All ex-post cost disclosures apart from 08040 refers to all dates in such period.   |

element **EMT\_V3\_FinancialInstrumentType/CostsAndChargesExPost/ReferencePeriod/End**

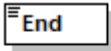
|            |   |
|------------|---|
| diagram    |  <p>08100: The Date that specifies the end of the Reference Period. Defined as "To and including". All ex-post cost disclosures apart from 08040 refers to all dates in such period. For the avoidance of doubt, this date can be specified as equal to the date specified in 08090.</p> |
| type       | <b>xs:date</b>  |
| properties | isRef 0<br>content simple   |
| annotation | documentation<br>08100: The Date that specifies the end of the Reference Period. Defined as "To and including". All ex-post cost disclosures apart from 08040 refers to all dates in such period. For the avoidance of doubt, this date can be specified as equal to the date specified in 08090.   |

element **EMT\_V3\_FinancialInstrumentType/CountrySpecificData**

|                   |  |
|-------------------|--|
| <p>diagram</p>    |  |
| <p>type</p>       | <p><a href="#">CountrySpecificEMTDataType</a></p>  |
| <p>properties</p> | <p>isRef 0<br/> minOcc 0<br/> maxOcc 1<br/> content complex</p>  |
| <p>children</p>   | <p><a href="#">AT</a> <a href="#">DE</a> <a href="#">DK</a> <a href="#">FR</a> <a href="#">LU</a> <a href="#">NL</a></p> |

complexType **EMT\_V41\_FinancialInstrumentType**

|                 |  |
|-----------------|--|
| <p>diagram</p>  |  |
| <p>children</p> | <p><a href="#">FundOrShareClassIdentifiers</a> <a href="#">DataSupplier</a> <a href="#">DataSetInformation</a> <a href="#">GeneralInformation</a> <a href="#">TargetMarket</a> <a href="#">CostsAndChargesExAnte</a> <a href="#">CostsAndChargesExPost</a> <a href="#">AdditionalInformationUK</a></p> |
| <p>used by</p>  | <p>element <a href="#">EMTType_V41/FinancialInstrument</a></p>   |

element **EMT\_V41\_FinancialInstrumentType/FundOrShareClassIdentifiers**

|                   |  |
|-------------------|--|
| <p>diagram</p>    |  |
| <p>type</p>       | <p><a href="#">FundOrShareClassIdentifiersType</a></p>   |
| <p>properties</p> | <p>isRef 0<br/>minOcc 0<br/>maxOcc 1<br/>content complex</p>   |
| <p>children</p>   | <p><a href="#">LEI</a> <a href="#">ISINs</a></p>   |
| <p>annotation</p> | <p>documentation<br/>Fund or share class identifiers for easy connection to other fund or share class data</p> |



element **EMT\_V41\_FinancialInstrumentType/DataSupplier**

|                   |  |
|-------------------|--|
| <p>diagram</p>    |  |
| <p>type</p>       | <p><a href="#">DataSupplierType</a></p>  |
| <p>properties</p> | <p>isRef 0<br/>minOcc 0<br/>maxOcc 1<br/>content complex</p>   |
| <p>children</p>   | <p><a href="#">SystemCountry</a> <a href="#">Short</a> <a href="#">Name</a> <a href="#">Type</a> <a href="#">Contact</a></p> |
| <p>annotation</p> | <p>documentation<br/>Definition of data source (investment company, vendor, ...)</p>   |

element **EMT\_V41\_FinancialInstrumentType/DataSetInformation**

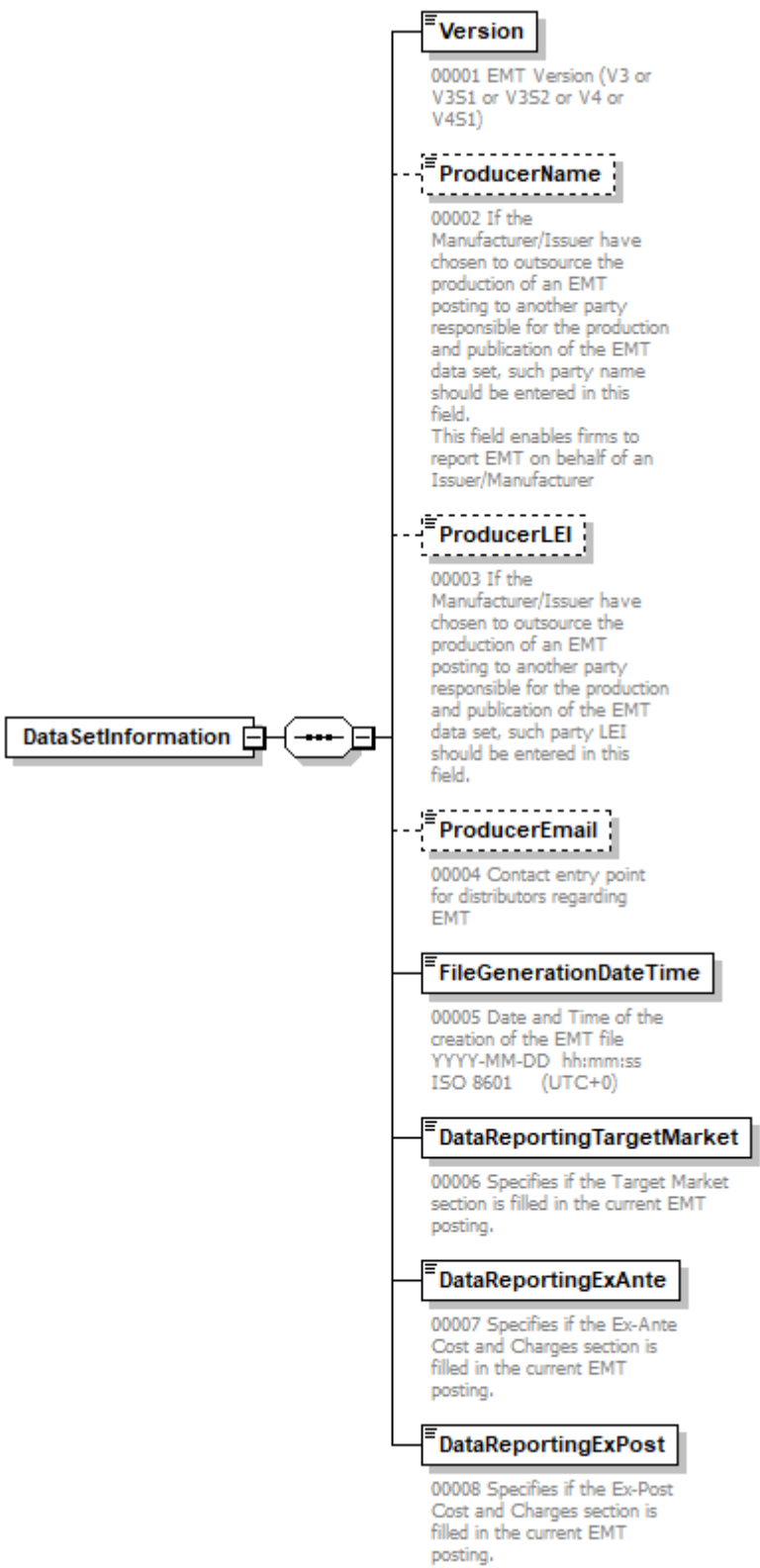
|  |   |
|--|---|
| <p>diagram</p>  | <p><b>Version</b><br/>00001 EMT Version (V3 or V3S1 or V3S2 or V4 or V4S1)</p> <p><b>ProducerName</b><br/>00002 If the Manufacturer/Issuer have chosen to outsource the production of an EMT posting to another party responsible for the production and publication of the EMT data set, such party name should be entered in this field.<br/>This field enables firms to report EMT on behalf of an Issuer/Manufacturer</p> <p><b>ProducerLEI</b><br/>00003 If the Manufacturer/Issuer have chosen to outsource the production of an EMT posting to another party responsible for the production and publication of the EMT data set, such party LEI should be entered in this field.</p> <p><b>ProducerEmail</b><br/>00004 Contact entry point for distributors regarding EMT</p> <p><b>FileGenerationDateTime</b><br/>00005 Date and Time of the creation of the EMT file<br/>YYYY-MM-DD hh:mm:ss<br/>ISO 8601 (UTC+0)</p> <p><b>DataReportingTargetMarket</b><br/>00006 Specifies if the Target Market section is filled in the current EMT posting.</p> <p><b>DataReportingExAnte</b><br/>00007 Specifies if the Ex-Ante Cost and Charges section is filled in the current EMT posting.</p> <p><b>DataReportingExPost</b><br/>00008 Specifies if the Ex-Post Cost and Charges section is filled in the current EMT posting.</p> |
| <p>properties</p>  | <p>isRef 0<br/>content complex</p>  |

|          |   |
|----------|---|
| children | <a href="#">Version</a> <a href="#">ProducerName</a> <a href="#">ProducerLEI</a> <a href="#">ProducerEmail</a> <a href="#">FileGenerationDateTime</a> <a href="#">DataReportingTargetMarket</a> <a href="#">DataReportingExAnte</a> <a href="#">DataReportingExPost</a> |
|----------|---|

element **EMT\_V41\_FinancialInstrumentType/DataSetInformation/Version**

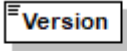
|            |   |
|------------|---|
| diagram    |  <p>00001 EMT Version (V3 or V3S1 or V3S2 or V4 or V4S1)</p> |
| type       | restriction of <b>xs:string</b>   |
| properties | isRef 0<br>content simple   |
| facets     | Kind Value annotation<br>minLength 2<br>maxLength 4   |
| annotation | documentation<br>00001 EMT Version (V3 or V3S1 or V3S2 or V4 or V4S1)   |

element **EMT\_V41\_FinancialInstrumentType/DataSetInformation/ProducerName**

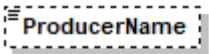
|            |  |
|------------|--|
| diagram    |  <p>00002 If the Manufacturer/Issuer have chosen to outsource the production of an EMT posting to another party responsible for the production and publication of the EMT data set, such party name should be entered in this field.<br/>This field enables firms to report EMT on behalf of an Issuer/Manufacturer</p> |
| type       | restriction of <b>xs:string</b>  |
| properties | isRef 0<br>minOcc 0<br>maxOcc 1<br>content simple  |
| facets     | Kind Value annotation<br>maxLength 255   |
| annotation | documentation<br>00002 If the Manufacturer/Issuer have chosen to outsource the production of an EMT posting to another party responsible for the production and publication of the EMT data set, such party name should be entered in this field.<br>This field enables firms to report EMT on behalf of an Issuer/Manufacturer  |

element **EMT\_V41\_FinancialInstrumentType/DataSetInformation/ProducerLEI**

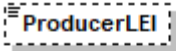
|            |  |
|------------|--|
| diagram    |  <p>00003 If the Manufacturer/Issuer have chosen to outsource the production of an EMT posting to another party responsible for the production and publication of the EMT data set, such party LEI should be entered in this field.</p> |
| type       | <a href="#">LEICodeType</a>  |
| properties | isRef 0<br>minOcc 0<br>maxOcc 1<br>content simple  |
| facets     | Kind Value annotation<br>minLength 20<br>maxLength 20<br>pattern ([0-9a-zA-Z]{18}[0-9]{2})   |
| annotation | documentation<br>00003 If the Manufacturer/Issuer have chosen to outsource the production of an EMT posting to another party responsible for the production and publication of the EMT data set, such party LEI should be entered in this field.   |

element **EMT\_V41\_FinancialInstrumentType/DataSetInformation/ProducerEmail**

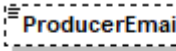
|            |   |
|------------|---|
| diagram    |  <p>00004 Contact entry point for distributors regarding EMT</p> |
| type       | <a href="#">EmailAddressType</a>  |
| properties | isRef 0<br>minOcc 0<br>maxOcc 1<br>content simple   |
| facets     | Kind Value annotation<br>pattern [_\a-zA-Z0-9\.\+]+\@[a-zA-Z0-9](\.[\a-zA-Z0-9]*[a-zA-Z0-9])*   |
| annotation | documentation<br>00004 Contact entry point for distributors regarding EMT   |

element **EMT\_V41\_FinancialInstrumentType/DataSetInformation/FileGenerationDateTime**

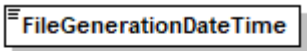
|            |   |
|------------|---|
| diagram    |  <p>00005 Date and Time of the creation of the EMT file<br/>         YYYY-MM-DD hh:mm:ss<br/>         ISO 8601 (UTC+0)</p> |
| type       | <b>xs:dateTime</b>  |
| properties | isRef 0<br>content simple   |
| annotation | documentation<br>00005 Date and Time of the creation of the EMT file<br>YYYY-MM-DD hh:mm:ss ISO 8601 (UTC+0)  |

element **EMT\_V41\_FinancialInstrumentType/DataSetInformation/DataReportingTargetMarket**

|            |  |
|------------|--|
| diagram    |  <b>DataReportingTargetMarket</b><br>00006 Specifies if the Target Market section is filled in the current EMT posting. |
| type       | <a href="#">EMTYesNoType</a>   |
| properties | isRef 0<br>content simple  |
| facets     | Kind Value annotation<br>length 1  |
| annotation | documentation<br>00006 Specifies if the Target Market section is filled in the current EMT posting.  |

element **EMT\_V41\_FinancialInstrumentType/DataSetInformation/DataReportingExAnte**

|            |   |
|------------|---|
| diagram    |  <b>DataReportingExAnte</b><br>00007 Specifies if the Ex-Ante Cost and Charges section is filled in the current EMT posting. |
| type       | <a href="#">EMTYesNoType</a>  |
| properties | isRef 0<br>content simple   |
| facets     | Kind Value annotation<br>length 1   |
| annotation | documentation<br>00007 Specifies if the Ex-Ante Cost and Charges section is filled in the current EMT posting.  |

element **EMT\_V41\_FinancialInstrumentType/DataSetInformation/DataReportingExPost**

|            |   |
|------------|---|
| diagram    |  <b>DataReportingExPost</b><br>00008 Specifies if the Ex-Post Cost and Charges section is filled in the current EMT posting. |
| type       | <a href="#">EMTYesNoType</a>  |
| properties | isRef 0<br>content simple   |
| facets     | Kind Value annotation<br>length 1   |
| annotation | documentation<br>00008 Specifies if the Ex-Post Cost and Charges section is filled in the current EMT posting.  |

element **EMT\_V41\_FinancialInstrumentType/GeneralInformation**

diagram



|            |   |
|------------|---|
| properties | isRef 0<br>content complex  |
| children   | <a href="#">Code</a> <a href="#">CodificationSystem</a> <a href="#">InstrumentName</a> <a href="#">InstrumentCurrency</a> <a href="#">InstrumentPerformanceFee</a> <a href="#">InstrumentDistributionCash</a> <a href="#">GeneralReferenceDate</a> <a href="#">ProductType</a> <a href="#">MaturityDate</a> <a href="#">MaybeTerminatedEarly</a> <a href="#">ManufacturerName</a> <a href="#">ManufacturerLEI</a> <a href="#">ManufacturerEmail</a> <a href="#">ManufacturerProductGovernanceProces</a> <a href="#">GuarantorName</a> <a href="#">ProductCategoryNatureGermany</a> <a href="#">LeveragedOrContingentLiability</a> <a href="#">StructuredSecurity</a> <a href="#">Fund</a> |
| annotation | documentation<br>General Financial Instrument Information   |

element **EMT\_V41\_FinancialInstrumentType/GeneralInformation/Code**

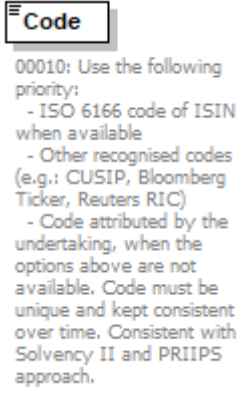
|            |  |
|------------|--|
| diagram    |  <p>00010: Use the following priority:</p> <ul style="list-style-type: none"> <li>- ISO 6166 code of ISIN when available</li> <li>- Other recognised codes (e.g.: CUSIP, Bloomberg Ticker, Reuters RIC)</li> <li>- Code attributed by the undertaking, when the options above are not available. Code must be unique and kept consistent over time. Consistent with Solvency II and PRIIPS approach.</li> </ul> |
| type       | restriction of <b>xs:string</b>  |
| properties | isRef 0<br>content simple  |
| facets     | Kind Value annotation<br>maxLength 255   |
| annotation | documentation<br>00010: Use the following priority:  |

- ISO 6166 code of ISIN when available
- Other recognised codes (e.g.: CUSIP, Bloomberg Ticker, Reuters RIC)
- Code attributed by the undertaking, when the options above are not available. Code must be unique and kept consistent over time. Consistent with Solvency II and PRIIPS approach.

element **EMT\_V41\_FinancialInstrumentType/GeneralInformation/CodificationSystem**

|              |   |            |       |            |              |   |  |              |    |  |
|--------------|---|------------|-------|------------|--------------|---|--|--------------|----|--|
| diagram      | <div data-bbox="293 239 545 289" style="border: 1px solid black; padding: 2px;"> <b>CodificationSystem</b> </div> <p>00020: Codification system used.<br/> Integer corresponding to the following closed list:<br/> 1 - ISO 6166 for ISIN code<br/> 2 - CUSIP (The Committee on Uniform Securities Identification Procedures number assigned by the CUSIP Service Bureau for U.S. and Canadian companies)<br/> 3 - SEDOL (Stock Exchange Daily Official List for the London Stock Exchange)<br/> 4 - WKN (Wertpapier Kenn-Nummer, the alphanumeric German identification number)<br/> 5 - Bloomberg Ticker (Bloomberg letters code that identify a company's securities)<br/> 6 - BBGID (The Bloomberg Global ID)<br/> 7 - Reuters RIC (Reuters instrument code)<br/> 8 - FIGI (Financial Instrument Global Identifier)<br/> 9 - Other code by members of the Association of National Numbering Agencies<br/> 10 - LEI<br/> 99 - Code attributed by the undertaking</p> |            |       |            |              |   |  |              |    |  |
| type         | restriction of <b>xs:short</b>  |            |       |            |              |   |  |              |    |  |
| properties   | isRef 0<br>content simple   |            |       |            |              |   |  |              |    |  |
| facets       | <table border="0"> <tr> <td>Kind</td> <td>Value</td> <td>annotation</td> </tr> <tr> <td>minInclusive</td> <td>1</td> <td></td> </tr> <tr> <td>maxInclusive</td> <td>99</td> <td></td> </tr> </table>  | Kind       | Value | annotation | minInclusive | 1 |  | maxInclusive | 99 |  |
| Kind         | Value   | annotation |       |            |              |   |  |              |    |  |
| minInclusive | 1   |            |       |            |              |   |  |              |    |  |
| maxInclusive | 99  |            |       |            |              |   |  |              |    |  |
| annotation   | documentation<br>00020: Codification system used.<br>Integer corresponding to the following closed list:<br>1 - ISO 6166 for ISIN code<br>2 - CUSIP (The Committee on Uniform Securities Identification Procedures number assigned by the CUSIP Service Bureau for U.S. and Canadian companies)<br>3 - SEDOL (Stock Exchange Daily Official List for the London Stock Exchange)<br>4 - WKN (Wertpapier Kenn-Nummer, the alphanumeric German identification number)<br>5 - Bloomberg Ticker (Bloomberg letters code that identify a company's securities)<br>6 - BBGID (The Bloomberg Global ID)<br>7 - Reuters RIC (Reuters instrument code)<br>8 - FIGI (Financial Instrument Global Identifier)<br>9 - Other code by members of the Association of National Numbering Agencies<br>10 - LEI<br>99 - Code attributed by the undertaking   |            |       |            |              |   |  |              |    |  |



element **EMT\_V41\_FinancialInstrumentType/GeneralInformation/InstrumentName**

|            |  |
|------------|--|
| diagram    |  <p>00030: Name of the financial instrument</p> |
| type       | restriction of <b>xs:string</b>  |
| properties | isRef 0<br>content simple  |
| facets     | Kind Value annotation<br>maxLength 255   |
| annotation | documentation<br>00030: Name of the financial instrument   |

element **EMT\_V41\_FinancialInstrumentType/GeneralInformation/InstrumentCurrency**

|            |   |
|------------|---|
| diagram    |  <p>00040: Denomination currency of the financial instrument</p> |
| type       | <a href="#">ISOCurrencyCodeType</a>   |
| properties | isRef 0<br>content simple   |
| facets     | Kind Value annotation<br>minLength 3<br>maxLength 3<br>pattern [A-Z]{3}   |
| annotation | documentation<br>00040: Denomination currency of the financial instrument   |

element **EMT\_V41\_FinancialInstrumentType/GeneralInformation/InstrumentPerformanceFee**

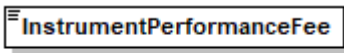
|            |   |
|------------|---|
| diagram    |  <p>00045_Financial_Instrument_Performance_Fee</p> |
| type       | <a href="#">EMTYesNoType</a>  |
| properties | isRef 0<br>content simple   |
| facets     | Kind Value annotation<br>length 1   |
| annotation | documentation<br>00045_Financial_Instrument_Performance_Fee   |

element **EMT\_V41\_FinancialInstrumentType/GeneralInformation/InstrumentDistributionCash**

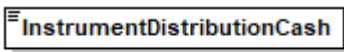
|            |  |
|------------|--|
| diagram    |  <p>00047_Financial_Instrument_Distribution_Of_Cash</p> |
| type       | <a href="#">EMTYesNoType</a>   |
| properties | isRef 0<br>content simple  |

|            |  |
|------------|--|
| facets     | Kind Value annotation<br>length 1                                |
| annotation | documentation<br>00047_Financial_Instrument_Distribution_Of_Cash |

element **EMT\_V41\_FinancialInstrumentType/GeneralInformation/GeneralReferenceDate**

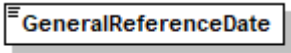
|            |  |
|------------|--|
| diagram    |  <p>00050 Date to which the General data within the EMT refer</p> |
| type       | <b>xs:date</b>   |
| properties | isRef 0<br>content simple  |
| annotation | documentation<br>00050 Date to which the General data within the EMT refer   |

element **EMT\_V41\_FinancialInstrumentType/GeneralInformation/ProductType**

|            |  |
|------------|--|
| diagram    |  <p>00060: Structured Securities or Structured Funds or UCITS or Non UCITS or UCITS Money Market Funds or Non UCITS Money Market Funds or Exchanged Traded Commodities or Bonds</p> |
| type       | restriction of <b>xs:string</b>  |
| properties | isRef 0<br>content simple  |
| facets     | Kind Value annotation<br>minLength 1<br>maxLength 3  |
| annotation | documentation<br>00060: Structured Securities or Structured Funds or UCITS or Non UCITS or UCITS Money Market Funds or Non UCITS Money Market Funds or Exchanged Traded Commodities or Bonds   |

element **EMT\_V41\_FinancialInstrumentType/GeneralInformation/MaturityDate**

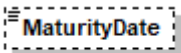
|            |   |
|------------|---|
| diagram    |  <p>00065 Date of Maturity</p> |
| type       | <b>xs:date</b>  |
| properties | isRef 0<br>minOcc 0<br>maxOcc 1<br>content simple   |
| annotation | documentation<br>00065 Date of Maturity   |

element **EMT\_V41\_FinancialInstrumentType/GeneralInformation/MaybeTerminatedEarly**

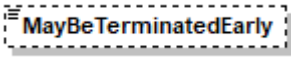
|            |  |
|------------|--|
| diagram    |  <p>00067 Yes or No. Conditional of field 00060 being set to S, SF or B</p> |
| type       | <a href="#">EMTYesNoType</a>   |
| properties | <p>isRef 0</p> <p>minOcc 0</p> <p>maxOcc 1</p> <p>content simple</p>   |
| facets     | <p>Kind Value annotation</p> <p>length 1</p>   |
| annotation | <p>documentation</p> <p>00067 Yes or No. Conditional of field 00060 being set to S, SF or B</p>  |

element **EMT\_V41\_FinancialInstrumentType/GeneralInformation/ManufacturerName**

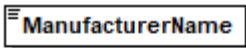
|            |  |
|------------|--|
| diagram    |  <p>00070<br/>Name of Manufacturer of the financial instrument. The one who is responsible for the financial instrument management/issuance</p> |
| type       | restriction of <b>xs:string</b>  |
| properties | <p>isRef 0</p> <p>content simple</p>   |
| facets     | <p>Kind Value annotation</p> <p>maxLength 255</p>  |
| annotation | <p>documentation</p> <p>00070<br/>Name of Manufacturer of the financial instrument. The one who is responsible for the financial instrument management/issuance</p>  |

element **EMT\_V41\_FinancialInstrumentType/GeneralInformation/ManufacturerLEI**

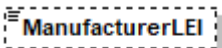
|            |   |
|------------|---|
| diagram    |  <p>00073 Legal Entity Identifier, LEI of the Manufacturer of the financial instrument</p> |
| type       | <a href="#">LEICodeType</a>   |
| properties | <p>isRef 0</p> <p>minOcc 0</p> <p>maxOcc 1</p> <p>content simple</p>  |
| facets     | <p>Kind Value annotation</p> <p>minLength 20</p> <p>maxLength 20</p> <p>pattern ([0-9a-zA-Z]{18}[0-9]{2})</p>   |
| annotation | <p>documentation</p> <p>00073 Legal Entity Identifier, LEI of the Manufacturer of the financial instrument</p>  |

element **EMT\_V41\_FinancialInstrumentType/GeneralInformation/ManufacturerEmail**

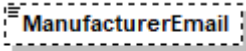
|            |  |
|------------|--|
| diagram    |  <p>00074 Contact entry point for communication with the Manufacturer to either provide feed back reporting or to retrieve details on how to provide feed back reporting.</p> |
| type       | <a href="#">EmailAddressType</a>   |
| properties | isRef 0<br>minOcc 0<br>maxOcc 1<br>content simple  |
| facets     | Kind Value annotation<br>pattern <code>[_\a-zA-Z0-9\.\+]+\@[a-zA-Z0-9](\.[\a-zA-Z0-9]*[a-zA-Z0-9])*</code>   |
| annotation | documentation<br>00074 Contact entry point for communication with the Manufacturer to either provide feed back reporting or to retrieve details on how to provide feed back reporting.   |

element **EMT\_V41\_FinancialInstrumentType/GeneralInformation/ManufacturerProductGovernanceProces**

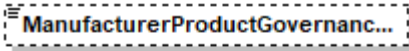
|            |   |
|------------|---|
| diagram    |  <p>00075<br/>         A = Product governance procedure pursuant to MiFID II<br/>         B = Product governance procedure comparable to MiFID II<br/>         C = Product governance procedure not in accordance with MiFID II<br/>         D = No information is requested from the issuer</p> |
| type       | restriction of <b>xs:string</b>   |
| properties | isRef 0<br>minOcc 0<br>maxOcc 1<br>content simple   |
| facets     | Kind Value annotation<br>minLength 1<br>maxLength 1   |
| annotation | documentation<br>00075<br>A = Product governance procedure pursuant to MiFID II<br>B = Product governance procedure comparable to MiFID II<br>C = Product governance procedure not in accordance with MiFID II<br>D = No information is requested from the issuer   |

element **EMT\_V41\_FinancialInstrumentType/GeneralInformation/GuarantorName**

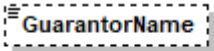
|            |  |
|------------|--|
| diagram    |  <p>00080: Name of guarantor of the financial instrument.</p> |
| type       | restriction of <b>xs:string</b>  |
| properties | isRef 0<br>minOcc 0  |

|            |  |
|------------|--|
|            | maxOcc 1<br>content simple   |
| facets     | Kind Value annotation<br>maxLength 255                                 |
| annotation | documentation<br>00080: Name of guarantor of the financial instrument. |

element **EMT\_V41\_FinancialInstrumentType/GeneralInformation/ProductCategoryNatureGermany**

|            |  |
|------------|--|
| diagram    |  <p>00090: Designation of the respective product category or nature for Germany.<br/>German code: number between 1 and 22, is using the english version of the german categorization.</p> |
| type       | restriction of <b>xs:positiveInteger</b>   |
| properties | isRef 0<br>minOcc 0<br>maxOcc 1<br>content simple  |
| facets     | Kind Value annotation<br>minInclusive 1<br>maxInclusive 22   |
| annotation | documentation<br>00090: Designation of the respective product category or nature for Germany.<br>German code: number between 1 and 22, is using the english version of the german categorization.  |

element **EMT\_V41\_FinancialInstrumentType/GeneralInformation/LeveragedOrContingentLiability**

|            |   |
|------------|---|
| diagram    |  <p>00100: To enable reporting on the depreciation of leveraged financial instruments or contingent liability transactions in accordance with Art. 62 of the MiFID II's Delegated Regulation</p> |
| type       | <a href="#">EMTYesNoType</a>  |
| properties | isRef 0<br>content simple   |
| facets     | Kind Value annotation<br>length 1   |
| annotation | documentation<br>00100: To enable reporting on the depreciation of leveraged financial instruments or contingent liability transactions in accordance with Art. 62 of the MiFID II's Delegated Regulation   |

element **EMT\_V41\_FinancialInstrumentType/GeneralInformation/StructuredSecurity**

|            |  |
|------------|--|
| diagram    | <p><b>StructuredSecurity</b><br/>Relevant fields for structured securities</p> <p><b>TypeNotionalOrItemBased</b><br/>00085: Enables interpretation of Cost and Charges data when used together with fields 00096, 08110 and 08120.<br/>N for Notional based instrument, I for Item based instrument</p> <p><b>ProductCategoryNature</b><br/>00095: If the financial instrument is a structured security complete with the EUSIPA code</p> <p><b>Quotation</b><br/>00096: If 00060 is set to S or ETC.<br/>U for Units, or P for Percentage.<br/>Defines if the quotation type in the Ex-Ante and Ex-Post section of the EMT file is in UNITS or in PERCENTAGE related to the specific Reference as presented in field 07150,07155, 08110 and 08120 respectively.</p> |
| properties | <p>isRef 0</p> <p>minOcc 0</p> <p>maxOcc 1</p> <p>content complex</p>  |
| children   | <p><a href="#">TypeNotionalOrItemBased</a> <a href="#">ProductCategoryNature</a> <a href="#">Quotation</a></p>   |
| annotation | <p>documentation<br/>Relevant fields for structured securities</p>   |

element **EMT\_V41\_FinancialInstrumentType/GeneralInformation/StructuredSecurity/TypeNotionalOrItemBased**

|            |  |
|------------|--|
| diagram    | <p><b>TypeNotionalOrItemBased</b><br/>00085: Enables interpretation of Cost and Charges data when used together with fields 00096, 08110 and 08120.<br/>N for Notional based instrument, I for Item based instrument</p> |
| type       | <p>restriction of <b>xs:string</b></p>   |
| properties | <p>isRef 0</p> <p>minOcc 0</p> <p>maxOcc 1</p> <p>content simple</p>   |
| facets     | <p>Kind Value annotation</p> <p>minLength 1</p> <p>maxLength 1</p>   |
| annotation | <p>documentation<br/>00085: Enables interpretation of Cost and Charges data when used together with fields 00096, 08110 and 08120.<br/>N for Notional based instrument, I for Item based instrument</p>                  |

element

**EMT\_V41\_FinancialInstrumentType/GeneralInformation/StructuredSecurity/ProductCategoryNature**

|            |  |
|------------|--|
| diagram    |  <p><b>ProductCategoryNature</b></p> <p>00095: If the financial instrument is a structured security complete with the EUSIPA code</p> |
| type       | restriction of <a href="#">Text4Type</a>   |
| properties | isRef 0<br>minOcc 0<br>maxOcc 1<br>content simple  |
| facets     | Kind Value annotation<br>maxLength 4   |
| annotation | documentation<br>00095: If the financial instrument is a structured security complete with the EUSIPA code   |

element **EMT\_V41\_FinancialInstrumentType/GeneralInformation/StructuredSecurity/Quotation**

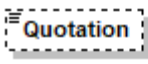
|            |   |
|------------|---|
| diagram    |  <p><b>Quotation</b></p> <p>00096: If 00060 is set to S or ETC, U for Units, or P for Percentage. Defines if the quotation type in the Ex-Ante and Ex-Post section of the EMT file is in UNITS or in PERCENTAGE related to the specific Reference as presented in field 07150,07155, 08110 and 08120 respectively.</p> |
| type       | restriction of <b>xs:string</b>   |
| properties | isRef 0<br>minOcc 0<br>maxOcc 1<br>content simple   |
| facets     | Kind Value annotation<br>minLength 1<br>maxLength 1   |
| annotation | documentation<br>00096: If 00060 is set to S or ETC. U for Units, or P for Percentage. Defines if the quotation type in the Ex-Ante and Ex-Post section of the EMT file is in UNITS or in PERCENTAGE related to the specific Reference as presented in field 07150,07155, 08110 and 08120 respectively.   |

element **EMT\_V41\_FinancialInstrumentType/GeneralInformation/Fund**

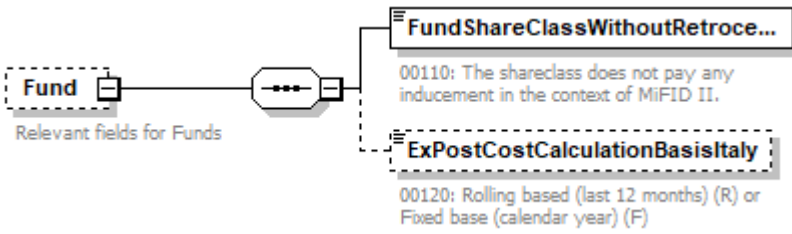
|         |  |
|---------|--|
| diagram |  <p><b>Fund</b></p> <p>Relevant fields for Funds</p> <p><b>FundShareClassWithoutRetroce...</b></p> <p>00110: The shareclass does not pay any inducement in the context of MiFID II.</p> <p><b>ExPostCostCalculationBasisItaly</b></p> <p>00120: Rolling based (last 12 months) (R) or Fixed base (calendar year) (F)</p> |
|---------|--|

|            |   |
|------------|---|
| properties | isRef 0<br>minOcc 0<br>maxOcc 1<br>content complex                                |
| children   | <a href="#">FundShareClassWithoutRetrocession ExPostCostCalculationBasisItaly</a> |
| annotation | documentation<br>Relevant fields for Funds  |

element

**EMT\_V41\_FinancialInstrumentType/GeneralInformation/Fund/FundShareClassWithoutRetrocession**

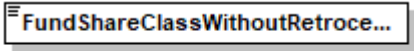
|            |  |
|------------|--|
| diagram    |  <p>00110: The shareclass does not pay any inducement in the context of MiFID II.</p> |
| type       | <a href="#">EMTYesNoType</a>   |
| properties | isRef 0<br>content simple  |
| facets     | Kind Value annotation<br>length 1  |
| annotation | documentation<br>00110: The shareclass does not pay any inducement in the context of MiFID II.   |

element **EMT\_V41\_FinancialInstrumentType/GeneralInformation/Fund/ExPostCostCalculationBasisItaly**

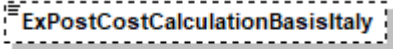
|            |   |
|------------|---|
| diagram    |  <p>00120: Rolling based (last 12 months) (R) or Fixed base (calendar year) (F)</p> |
| type       | restriction of <a href="#">Text1Type</a>  |
| properties | isRef 0<br>minOcc 0<br>maxOcc 1<br>content simple   |
| facets     | Kind Value annotation<br>maxLength 1  |
| annotation | documentation<br>00120: Rolling based (last 12 months) (R) or Fixed base (calendar year) (F)  |



element **EMT\_V41\_FinancialInstrumentType/TargetMarket**

|                   |   |
|-------------------|---|
| <p>diagram</p>    | <pre> classDiagram     class TargetMarket     class GeneralReferenceDate     class InvestorType     class KnowledgeAndExperience     class AbilityToBearLosses     class RiskTolerance     class ClientObjectives     class DistributionStrategy     TargetMarket --&gt; GeneralReferenceDate     TargetMarket --&gt; InvestorType     TargetMarket --&gt; KnowledgeAndExperience     TargetMarket --&gt; AbilityToBearLosses     TargetMarket --&gt; RiskTolerance     TargetMarket --&gt; ClientObjectives     TargetMarket --&gt; DistributionStrategy     </pre> <p><b>GeneralReferenceDate</b><br/>01000 Date to which the Target Market data within the EMT refer</p> <p><b>InvestorType</b> +<br/>Target markets - Investor Type</p> <p><b>KnowledgeAndExperience</b> +<br/>Target markets - Knowledge and/or Experience</p> <p><b>AbilityToBearLosses</b> +<br/>Target markets - Ability To Bear Losses</p> <p><b>RiskTolerance</b> +<br/>Target markets - Risk Tolerance</p> <p><b>ClientObjectives</b> +<br/>Target markets - Client Objectives and Needs</p> <p><b>DistributionStrategy</b> +<br/>Target markets - Distribution Strategy</p> |
| <p>properties</p> | <p>isRef 0<br/>content complex</p>  |
| <p>children</p>   | <p><a href="#">GeneralReferenceDate</a> <a href="#">InvestorType</a> <a href="#">KnowledgeAndExperience</a> <a href="#">AbilityToBearLosses</a> <a href="#">RiskTolerance</a> <a href="#">ClientObjectives</a> <a href="#">DistributionStrategy</a></p>   |

element **EMT\_V41\_FinancialInstrumentType/TargetMarket/GeneralReferenceDate**

|                   |   |
|-------------------|---|
| <p>diagram</p>    | <pre> classDiagram     class GeneralReferenceDate     </pre> <p><b>GeneralReferenceDate</b><br/>01000 Date to which the Target Market data within the EMT refer</p> |
| <p>type</p>       | <p><b>xs:date</b></p>   |
| <p>properties</p> | <p>isRef 0<br/>content simple</p>   |
| <p>annotation</p> | <p>documentation<br/>01000 Date to which the Target Market data within the EMT refer</p>  |

element **EMT\_V41\_FinancialInstrumentType/TargetMarket/InvestorType**

|            |   |
|------------|---|
| diagram    | <p><b>InvestorType</b><br/>Target markets - Investor Type</p> <p><b>Retail</b><br/>01010: Neutral means usage by Retail clients are available under certain conditions.</p> <p><b>Professional</b><br/>01020: Y means both Professional Per Se and Elective Professionals are compatible.<br/>N means that neither Professional Per Se nor Elective Professionals are compatible.<br/>P means that Professional Per Se is compatible but Elective Professionals are not.<br/>E means that Elective Professional is compatible but Professionals Per Se are not.<br/>P is only used if the distinction Per Se is done in the Prospectus.</p> <p><b>EligibleCounterparty</b><br/>01030: Investor Type Eligible Counterparty</p> |
| properties | isRef 0<br>content complex  |
| children   | <a href="#">Retail</a> <a href="#">Professional</a> <a href="#">EligibleCounterparty</a>  |
| annotation | documentation<br>Target markets - Investor Type   |

element **EMT\_V41\_FinancialInstrumentType/TargetMarket/InvestorType/Retail**

|            |   |
|------------|---|
| diagram    | <p><b>Retail</b><br/>01010: Neutral means usage by Retail clients are available under certain conditions.</p> |
| type       | <a href="#">EMTYesNoNeutralType</a>   |
| properties | isRef 0<br>content simple   |
| facets     | Kind Value annotation<br>minLength 1<br>maxLength 7   |
| annotation | documentation<br>01010: Neutral means usage by Retail clients are available under certain conditions.         |

element **EMT\_V41\_FinancialInstrumentType/TargetMarket/InvestorType/Professional**

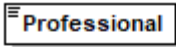
|            |   |
|------------|---|
| diagram    |  <p>01020: Y means both Professional Per Se and Elective Professionals are compatible.<br/> N means that neither Professional Per Se nor Elective Professionals are compatible.<br/> P means that Professional Per Se is compatible but Elective Professionals are not.<br/> E means that Elective Professional is compatible but Professionals Per Se are not.<br/> P is only used if the distinction Per Se is done in the Prospectus.</p> |
| type       | restriction of <b>xs:string</b>   |
| properties | isRef 0<br>content simple   |
| annotation | documentation<br>01020: Y means both Professional Per Se and Elective Professionals are compatible.<br>N means that neither Professional Per Se nor Elective Professionals are compatible.<br>P means that Professional Per Se is compatible but Elective Professionals are not.<br>E means that Elective Professional is compatible but Professionals Per Se are not.<br>P is only used if the distinction Per Se is done in the Prospectus.   |

element **EMT\_V41\_FinancialInstrumentType/TargetMarket/InvestorType/EligibleCounterparty**

|            |   |
|------------|---|
| diagram    |  <p>01030: Investor Type Eligible Counterparty</p> |
| type       | <a href="#">EMTYesNoType</a>  |
| properties | isRef 0<br>content simple   |
| facets     | Kind Value annotation<br>length 1   |
| annotation | documentation<br>01030: Investor Type Eligible Counterparty   |

element **EMT\_V41\_FinancialInstrumentType/TargetMarket/KnowledgeAndExperience**

|                   |  |
|-------------------|--|
| <p>diagram</p>    | <p><b>KnowledgeAndExperience</b><br/>Target markets - Knowledge and/or Experience</p> <p><b>BasicInvestor</b><br/>02010: Investors having the following characteristics:<br/> <ul style="list-style-type: none"> <li>• basic knowledge of relevant financial instruments (a basic investor can make an informed investment decision based on the regulated and authorised offering documentation or with the help of basic information provided by point of sale);</li> <li>• no financial industry experience, i.e. suited to a first time investor</li> </ul> </p> <p><b>InformedInvestor</b><br/>02020: Having one, or more, of the following characteristics:<br/> <ul style="list-style-type: none"> <li>• average knowledge of relevant financial products (an informed investor can make an informed investment decision based on the regulated and authorised offering documentation, together with knowledge and understanding of the specific factors/risks highlighted within them only)</li> <li>• some financial industry experience</li> </ul> </p> <p><b>AdvancedInvestor</b><br/>02030: Investors having one, or more, of the following characteristics:<br/> <ul style="list-style-type: none"> <li>• good knowledge of relevant financial products and transactions</li> <li>• financial industry experience or accompanied by professional investment advice or included in a discretionary portfolio service</li> </ul> </p> <p><b>ExpertInvestorGermany</b><br/>02040: Expert knowledge of and / or experience with highly specialised financial products (Regulatory requirement in Germany/ example: CFD/ the updated list will be provided by the DSGVO)</p> |
| <p>properties</p> | <p>isRef 0<br/>content complex</p>   |
| <p>children</p>   | <p><a href="#">BasicInvestor</a> <a href="#">InformedInvestor</a> <a href="#">AdvancedInvestor</a> <a href="#">ExpertInvestorGermany</a></p>   |
| <p>annotation</p> | <p>documentation<br/>Target markets - Knowledge and/or Experience</p>  |

element **EMT\_V41\_FinancialInstrumentType/TargetMarket/KnowledgeAndExperience/BasicInvestor**

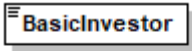
|            |   |
|------------|---|
| diagram    |  <p>02010: Investors having the following characteristics:</p> <ul style="list-style-type: none"> <li>• basic knowledge of relevant financial instruments (a basic investor can make an informed investment decision based on the regulated and authorised offering documentation or with the help of basic information provided by point of sale);</li> <li>• no financial industry experience, i.e. suited to a first time investor</li> </ul> |
| type       | <a href="#">EMTYesNoNeutralType</a>   |
| properties | isRef 0<br>content simple   |
| facets     | Kind Value annotation<br>minLength 1<br>maxLength 7   |
| annotation | documentation<br>02010: Investors having the following characteristics:<br><ul style="list-style-type: none"> <li>• basic knowledge of relevant financial instruments (a basic investor can make an informed investment decision based on the regulated and authorised offering documentation or with the help of basic information provided by point of sale);</li> <li>• no financial industry experience, i.e. suited to a first time investor</li> </ul>  |

element **EMT\_V41\_FinancialInstrumentType/TargetMarket/KnowledgeAndExperience/InformedInvestor**

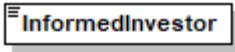
|            |  |
|------------|--|
| diagram    |  <p>02020: Having one, or more, of the following characteristics:</p> <ul style="list-style-type: none"> <li>• average knowledge of relevant financial products (an informed investor can make an informed investment decision based on the regulated and authorised offering documentation, together with knowledge and understanding of the specific factors/risks highlighted within them only)</li> <li>• some financial industry experience</li> </ul> |
| type       | <a href="#">EMTYesNoNeutralType</a>  |
| properties | isRef 0<br>content simple  |
| facets     | Kind Value annotation<br>minLength 1<br>maxLength 7  |
| annotation | documentation<br>02020: Having one, or more, of the following characteristics:<br><ul style="list-style-type: none"> <li>• average knowledge of relevant financial products (an informed investor can make an informed investment decision based on the regulated and authorised offering documentation, together with knowledge and understanding of the specific factors/risks highlighted within them only)</li> <li>• some financial industry experience</li> </ul>  |

element **EMT\_V41\_FinancialInstrumentType/TargetMarket/KnowledgeAndExperience/AdvancedInvestor**

|            |   |
|------------|---|
| diagram    | <p><b>AdvancedInvestor</b></p> <p>02030: Investors having one, or more, of the following characteristics:</p> <ul style="list-style-type: none"> <li>• good knowledge of relevant financial products and transactions</li> <li>• financial industry experience or accompanied by professional investment advice or included in a discretionary portfolio service</li> </ul> |
| type       | <a href="#">EMTYesNoNeutralType</a>   |
| properties | isRef 0<br>content simple   |
| facets     | Kind Value annotation<br>minLength 1<br>maxLength 7   |
| annotation | documentation<br>02030: Investors having one, or more, of the following characteristics: <ul style="list-style-type: none"> <li>• good knowledge of relevant financial products and transactions</li> <li>• financial industry experience or accompanied by professional investment advice or included in a discretionary portfolio service</li> </ul>                      |

element **EMT\_V41\_FinancialInstrumentType/TargetMarket/KnowledgeAndExperience/ExpertInvestorGermany**

|            |  |
|------------|--|
| diagram    | <p><b>ExpertInvestorGermany</b></p> <p>02040: Expert knowledge of and / or experience with highly specialised financial products (Regulatory requirement in Germany/ example: CFD/ the updated list will be provided by the DSGVO)</p> |
| type       | <a href="#">EMTYesNoNeutralType</a>  |
| properties | isRef 0<br>minOcc 0<br>maxOcc 1<br>content simple  |
| facets     | Kind Value annotation<br>minLength 1<br>maxLength 7  |
| annotation | documentation<br>02040: Expert knowledge of and / or experience with highly specialised financial products (Regulatory requirement in Germany/ example: CFD/ the updated list will be provided by the DSGVO)                           |

element **EMT\_V41\_FinancialInstrumentType/TargetMarket/AbilityToBearLosses**

|                   |   |
|-------------------|---|
| <p>diagram</p>    | <p><b>AbilityToBearLosses</b><br/>Target markets - Ability To Bear Losses</p> <p><b>CompatibleWithClientsWhoCanNotBearCapitalLoss</b><br/>03010: Investor can bear no loss of capital. Minor losses especially due to costs possible. Yes or No or Neutral. N for negative target: product should not be sold to investors that cannot bear losses</p> <p><b>CompatibleWithClientsWhoCanBearLimitedCapitalLoss</b><br/>03020: Investor seeking to preserve capital or can bear losses limited to a level specified by the product. Assessment of loss level is based on investments in the same currency as the instrument denomination and do not take into consideration potential adverse FX market performance. To be filled only for structured securities and funds with an explicit capital protection or for Money Market funds. Yes or No or Neutral</p> <p><b>LimitedCapitalLossLevel</b><br/>03030: To be completed for products that have a clearly stated full or partial capital guarantee, provided on the primary market. This field represents the maximum loss a client could incur when investing in this product – it is not the level of capital protection offered</p> <p><b>CompatibleWithClientsWhoDoNotNeedCapitalGuarantee</b><br/>03040: No Capital Guarantee nor protection. 100% capital at risk. Yes or No or Neutral</p> <p><b>CompatibleWithClientsWhoCanBearLossBeyondCapital</b><br/>03050: Loss Beyond the Capital. Yes or No or Neutral</p> |
| <p>properties</p> | <p>isRef 0<br/>content complex</p>  |
| <p>children</p>   | <p><a href="#">CompatibleWithClientsWhoCanNotBearCapitalLoss</a> <a href="#">CompatibleWithClientsWhoCanBearLimitedCapitalLoss</a> <a href="#">LimitedCapitalLossLevel</a> <a href="#">CompatibleWithClientsWhoDoNotNeedCapitalGuarantee</a> <a href="#">CompatibleWithClientsWhoCanBearLossBeyondCapital</a></p>   |
| <p>annotation</p> | <p>documentation<br/>Target markets - Ability To Bear Losses</p>  |

element **EMT\_V41\_FinancialInstrumentType/TargetMarket/AbilityToBearLosses/CompatibleWithClientsWhoCanNotBearCapitalLoss**

|                |  |
|----------------|--|
| <p>diagram</p> | <p><b>CompatibleWithClientsWhoCanNotBearCapitalLoss</b><br/>03010: Investor can bear no loss of capital. Minor losses especially due to costs possible. Yes or No or Neutral. N for negative target: product should not be sold to investors that cannot bear losses</p> |
| <p>type</p>    | <p><a href="#">EMTYesNoNeutralType</a></p>   |

|            |  |
|------------|--|
| properties | isRef 0<br>content simple  |
| facets     | Kind Value annotation<br>minLength 1<br>maxLength 7  |
| annotation | documentation<br>03010: Investor can bear no loss of capital. Minor losses especially due to costs possible. Yes or No or Neutral.<br>N for negative target: product should not be sold to investors that cannot bear losses |

element

**EMT\_V41\_FinancialInstrumentType/TargetMarket/AbilityToBearLosses/CompatibleWithClientsWhoCanBearLimitedCapitalLoss**

|            |   |
|------------|---|
| diagram    | <p>03020: Investor seeking to preserve capital or can bear losses limited to a level specified by the product. Assessment of loss level is based on investments in the same currency as the instrument denomination and do not take into consideration potential adverse FX market performance.<br/>To be filled only for structured securities and funds with an explicit capital protection or for Money Market funds.<br/>Yes or No or Neutral</p>         |
| type       | <a href="#">EMTYesNoNeutralType</a>   |
| properties | isRef 0<br>minOcc 0<br>maxOcc 1<br>content simple   |
| facets     | Kind Value annotation<br>minLength 1<br>maxLength 7   |
| annotation | documentation<br>03020: Investor seeking to preserve capital or can bear losses limited to a level specified by the product. Assessment of loss level is based on investments in the same currency as the instrument denomination and do not take into consideration potential adverse FX market performance.<br>To be filled only for structured securities and funds with an explicit capital protection or for Money Market funds.<br>Yes or No or Neutral |

element

**EMT\_V41\_FinancialInstrumentType/TargetMarket/AbilityToBearLosses/LimitedCapitalLossLevel**

|            |   |
|------------|---|
| diagram    | <p>03030: To be completed for products that have a clearly stated full or partial capital guarantee, provided on the primary market. This field represents the maximum loss a client could incur when investing in this product – it is not the level of capital protection offered</p> |
| type       | <a href="#">PercentageType</a>  |
| properties | isRef 0<br>minOcc 0<br>maxOcc 1<br>content simple   |



|            |   |
|------------|---|
| annotation | documentation<br>03030: To be completed for products that have a clearly stated full or partial capital guarantee, provided on the primary market. This field represents the maximum loss a client could incur when investing in this product – it is not the level of capital protection offered |
|------------|---|

element

**EMT\_V41\_FinancialInstrumentType/TargetMarket/AbilityToBearLosses/CompatibleWithClientsWhoDoNotNeedCapitalGuarantee**

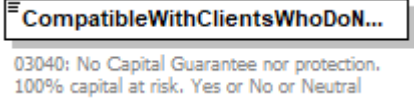
|            |   |
|------------|---|
| diagram    |                        |
| type       | <a href="#">EMTYesNoNeutralType</a>   |
| properties | isRef 0<br>content simple   |
| facets     | Kind Value annotation<br>minLength 1<br>maxLength 7   |
| annotation | documentation<br>03040: No Capital Guarantee nor protection. 100% capital at risk. Yes or No or Neutral |

element

**EMT\_V41\_FinancialInstrumentType/TargetMarket/AbilityToBearLosses/CompatibleWithClientsWhoCanBearLossBeyondCapital**

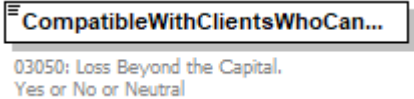
|            |   |
|------------|---|
| diagram    |  |
| type       | <a href="#">EMTYesNoNeutralType</a>   |
| properties | isRef 0<br>content simple   |
| facets     | Kind Value annotation<br>minLength 1<br>maxLength 7                                 |
| annotation | documentation<br>03050: Loss Beyond the Capital. Yes or No or Neutral               |

element **EMT\_V41\_FinancialInstrumentType/TargetMarket/RiskTolerance**

|                   |  |
|-------------------|--|
| <p>diagram</p>    | <p><b>RiskTolerance</b><br/>Target markets - Risk Tolerance</p> <ul style="list-style-type: none"> <li><b>PRIIPSMethodology</b><br/>04010: SRI (1-7), if PRIIPS KID is available. German distributors will use only this Risk Tolerance item</li> <li><b>UCITSMethodology</b><br/>04020: SRRI (1-7; for funds)</li> <li><b>InternalMethodology</b><br/>04030: For Non PRIIPS and Non UCITS:<br/>L ... Low<br/>M ... Medium<br/>H ... High</li> <li><b>MethodologySpain</b><br/>04040: Spanish SRI (1-6) for Non PRIIPS and Non UCITS<br/>For Spanish local NON PRIIPS and NON UCITS products.<br/>Orden ECC/2316/2015, de 4 de noviembre, relativa a las obligaciones de información y clasificación de productos financieros</li> <li><b>NotForInvestorsWithLowestRis...</b><br/>04050: For all products distributed in Germany (Yes or Neutral)</li> </ul> |
| <p>properties</p> | <p>isRef 0<br/>content complex</p>   |
| <p>children</p>   | <p><a href="#">PRIIPSMethodology</a> <a href="#">UCITSMethodology</a> <a href="#">InternalMethodology</a> <a href="#">MethodologySpain</a><br/><a href="#">NotForInvestorsWithLowestRiskToleranceGermany</a></p>   |
| <p>annotation</p> | <p>documentation<br/>Target markets - Risk Tolerance</p>   |

element **EMT\_V41\_FinancialInstrumentType/TargetMarket/RiskTolerance/PRIIPSMethodology**

|                   |  |
|-------------------|--|
| <p>diagram</p>    | <p><b>PRIIPSMethodology</b><br/>04010: SRI (1-7), if PRIIPS KID is available. German distributors will use only this Risk Tolerance item</p> |
| <p>type</p>       | <p>restriction of <b>xs:positiveInteger</b></p>  |
| <p>properties</p> | <p>isRef 0<br/>minOcc 0<br/>maxOcc 1<br/>content simple</p>  |
| <p>facets</p>     | <p>Kind Value annotation<br/>minInclusive 1<br/>maxInclusive 7</p>   |
| <p>annotation</p> | <p>documentation<br/>04010: SRI (1-7), if PRIIPS KID is available. German distributors will use only this Risk Tolerance item</p>            |

element **EMT\_V41\_FinancialInstrumentType/TargetMarket/RiskTolerance/UCITSMethodology**

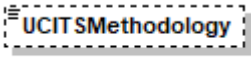
|            |   |
|------------|---|
| diagram    |  <p>04020: SRRI (1-7; for funds)</p> |
| type       | restriction of <b>xs:positiveInteger</b>  |
| properties | isRef 0<br>minOcc 0<br>maxOcc 1<br>content simple   |
| facets     | Kind Value annotation<br>minInclusive 1<br>maxInclusive 7   |
| annotation | documentation<br>04020: SRRI (1-7; for funds)   |

element **EMT\_V41\_FinancialInstrumentType/TargetMarket/RiskTolerance/InternalMethodology**

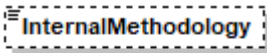
|            |  |
|------------|--|
| diagram    |  <p>04030: For Non PRIIPS and Non UCITS:<br/> L ... Low<br/> M ... Medium<br/> H ... High</p> |
| type       | restriction of <b>xs:string</b>  |
| properties | isRef 0<br>minOcc 0<br>maxOcc 1<br>content simple  |
| annotation | documentation<br>04030: For Non PRIIPS and Non UCITS:<br>L ... Low<br>M ... Medium<br>H ... High   |

element **EMT\_V41\_FinancialInstrumentType/TargetMarket/RiskTolerance/MethodologySpain**

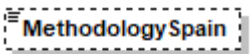
|            |   |
|------------|---|
| diagram    |  <p>04040: Spanish SRI (1-6) for Non PRIIPS and Non UCITS<br/> For Spanish local NON PRIIPS and NON UCITS products.<br/> Orden ECC/2316/2015, de 4 de noviembre, relativa a las obligaciones de información y clasificación de productos financieros</p> |
| type       | restriction of <b>xs:positiveInteger</b>  |
| properties | isRef 0<br>minOcc 0<br>maxOcc 1<br>content simple   |

|            |   |
|------------|---|
| facets     | Kind Value annotation<br>minInclusive 1<br>maxInclusive 6   |
| annotation | documentation<br>04040: Spanish SRI (1-6) for Non PRIIPS and Non UCITS<br>For Spanish local NON PRIIPS and NON UCITS products.<br>Orden ECC/2316/2015, de 4 de noviembre, relativa a las obligaciones de información y clasificación de productos financieros |

element

**EMT\_V41\_FinancialInstrumentType/TargetMarket/RiskTolerance/NotForInvestorsWithLowestRiskToleranceGermany**

|            |  |
|------------|--|
| diagram    |  |
| type       | restriction of xs:string   |
| properties | isRef 0<br>minOcc 0<br>maxOcc 1<br>content simple                                |
| annotation | documentation<br>04050: For all products distributed in Germany (Yes or Neutral) |

element **EMT\_V41\_FinancialInstrumentType/TargetMarket/ClientObjectives**

|            |  |
|------------|--|
| diagram    |  |
| properties | isRef 0<br>content complex   |
| children   | <a href="#">ReturnProfile</a> <a href="#">MinimumRecommendedHoldingPeriod</a> <a href="#">IntendedCompatibleWithClientsHavingSustainabilityPreferences</a> <a href="#">OtherSpecificInvestmentNeed</a> |
| annotation | documentation<br>Target markets - Client Objectives and Needs  |

element **EMT\_V41\_FinancialInstrumentType/TargetMarket/ClientObjectives/ReturnProfile**

|                   |   |
|-------------------|---|
| <p>diagram</p>    | <pre> classDiagram     class ReturnProfile     class ClientLookingForPreservation     class ClientLookingForCapitalGrowth     class ClientLookingForIncome     class OptionOrLeveraged     class PensionSchemeGermany     class StructuredSecurity      ReturnProfile -- ClientLookingForPreservation     ReturnProfile -- ClientLookingForCapitalGrowth     ReturnProfile -- ClientLookingForIncome     ReturnProfile -.- OptionOrLeveraged     ReturnProfile -.- PensionSchemeGermany     ReturnProfile -.- StructuredSecurity     </pre> <p><b>ClientLookingForPreservation</b><br/>05010: Indicates if the product is compatible with clients looking for preserving their capital. Products stipulating a capital preservation objective should be YES. For other products, the answer should be NO or NEUTRAL based on a case-by-case analysis. In Germany fields 05010, 05020 and 05030 are merged and regarded "General Capital Formation". A YES in any of these fields will be regarded a YES in the German combined field.</p> <p><b>ClientLookingForCapitalGrowth</b><br/>05020: Indicates if the product is compatible with clients looking for growing their capital. In Germany fields 05010, 05020 and 05030 are merged and regarded "General Capital Formation". A YES in any of these fields will be regarded a YES in the German combined field.</p> <p><b>ClientLookingForIncome</b><br/>05030: Indicates if the product is compatible with clients looking for Income. In Germany fields 05010, 05020 and 05030 are merged and regarded "General Capital Formation". A YES in any of these fields will be regarded a YES in the German combined field.</p> <p><b>OptionOrLeveraged</b><br/>05050: Yes or No or Neutral</p> <p><b>PensionSchemeGermany</b><br/>05070: Yes or No or Neutral</p> <p><b>StructuredSecurity</b> ⊕</p> |
| <p>properties</p> | <p>isRef 0<br/>content complex</p>  |
| <p>children</p>   | <p><a href="#">ClientLookingForPreservation</a> <a href="#">ClientLookingForCapitalGrowth</a> <a href="#">ClientLookingForIncome</a> <a href="#">OptionOrLeveraged</a> <a href="#">PensionSchemeGermany</a> <a href="#">StructuredSecurity</a></p>  |

element

**EMT\_V41\_FinancialInstrumentType/TargetMarket/ClientObjectives/ReturnProfile/ClientLookingForPreservation**

|            |  |
|------------|--|
| diagram    |  <b>ClientLookingForPreservation</b><br><p>05010: Indicates if the product is compatible with clients looking for preserving their capital. Products stipulating a capital preservation objective should be YES. For other products, the answer should be NO or NEUTRAL based on a case-by-case analysis. In Germany fields 05010, 05020 and 05030 are merged and regarded "General Capital Formation". A YES in any of these fields will be regarded a YES in the German combined field.</p> |
| type       | <a href="#">EMTYesNoNeutralType</a>  |
| properties | isRef 0<br>content simple  |
| facets     | Kind Value annotation<br>minLength 1<br>maxLength 7  |
| annotation | documentation<br>05010: Indicates if the product is compatible with clients looking for preserving their capital. Products stipulating a capital preservation objective should be YES. For other products, the answer should be NO or NEUTRAL based on a case-by-case analysis. In Germany fields 05010, 05020 and 05030 are merged and regarded "General Capital Formation". A YES in any of these fields will be regarded a YES in the German combined field.  |

element

**EMT\_V41\_FinancialInstrumentType/TargetMarket/ClientObjectives/ReturnProfile/ClientLookingForCapitalGrowth**

|            |  |
|------------|--|
| diagram    |  <b>ClientLookingForCapitalGrowth</b><br><p>05020: Indicates if the product is compatible with clients looking for growing their capital. In Germany fields 05010, 05020 and 05030 are merged and regarded "General Capital Formation". A YES in any of these fields will be regarded a YES in the German combined field.</p> |
| type       | <a href="#">EMTYesNoNeutralType</a>  |
| properties | isRef 0<br>content simple  |
| facets     | Kind Value annotation<br>minLength 1<br>maxLength 7  |
| annotation | documentation<br>05020: Indicates if the product is compatible with clients looking for growing their capital. In Germany fields 05010, 05020 and 05030 are merged and regarded "General Capital Formation". A YES in any of these fields will be regarded a YES in the German combined field.   |

element

**EMT\_V41\_FinancialInstrumentType/TargetMarket/ClientObjectives/ReturnProfile/ClientLookingForIncome**

|            |   |
|------------|---|
| diagram    |  <p>05030: Indicates if the product is compatible with clients looking for Income.<br/>In Germany fields 05010, 05020 and 05030 are merged and regarded "General Capital Formation". A YES in any of these fields will be regarded a YES in the German combined field.</p> |
| type       | <a href="#">EMTYesNoNeutralType</a>   |
| properties | isRef 0<br>content simple   |
| facets     | Kind Value annotation<br>minLength 1<br>maxLength 7   |
| annotation | documentation<br>05030: Indicates if the product is compatible with clients looking for Income.<br>In Germany fields 05010, 05020 and 05030 are merged and regarded "General Capital Formation". A YES in any of these fields will be regarded a YES in the German combined field.  |

element

**EMT\_V41\_FinancialInstrumentType/TargetMarket/ClientObjectives/ReturnProfile/OptionOrLeveraged**

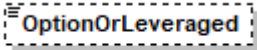
|            |  |
|------------|--|
| diagram    |  <p>05050: Yes or No or Neutral</p> |
| type       | <a href="#">EMTYesNoNeutralType</a>  |
| properties | isRef 0<br>minOcc 0<br>maxOcc 1<br>content simple  |
| facets     | Kind Value annotation<br>minLength 1<br>maxLength 7  |
| annotation | documentation<br>05050: Yes or No or Neutral   |

element

**EMT\_V41\_FinancialInstrumentType/TargetMarket/ClientObjectives/ReturnProfile/PensionSchemeGermany**

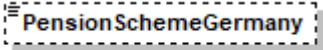
|            |  |
|------------|--|
| diagram    |  <p>05070: Yes or No or Neutral</p> |
| type       | <a href="#">EMTYesNoNeutralType</a>  |
| properties | isRef 0<br>minOcc 0<br>maxOcc 1<br>content simple  |
| facets     | Kind Value annotation<br>minLength 1   |

|            |  |
|------------|--|
|            | maxLength 7                                  |
| annotation | documentation<br>05070: Yes or No or Neutral |

element

**EMT\_V41\_FinancialInstrumentType/TargetMarket/ClientObjectives/ReturnProfile/StructuredSecurity**

|            |   |
|------------|---|
| diagram    | <p>05040: Yes or No or Neutral<br/>Only for structured Securities</p> |
| properties | isRef 0<br>minOcc 0<br>maxOcc 1<br>content complex                    |
| children   | <a href="#">Hedging</a>   |

element

**EMT\_V41\_FinancialInstrumentType/TargetMarket/ClientObjectives/ReturnProfile/StructuredSecurity/Hedging**

|            |  |
|------------|--|
| diagram    | <p>05040: Yes or No or Neutral<br/>Only for structured Securities</p>          |
| type       | <a href="#">EMTYesNoNeutralType</a>  |
| properties | isRef 0<br>content simple  |
| facets     | Kind Value annotation<br>minLength 1<br>maxLength 7                            |
| annotation | documentation<br>05040: Yes or No or Neutral<br>Only for structured Securities |

element

**EMT\_V41\_FinancialInstrumentType/TargetMarket/ClientObjectives/MinimumRecommendedHoldingPeriod**

|            |   |
|------------|---|
| diagram    | <p>05080: Minimum recommended holding period<br/>RHP: Recommended Holding Period</p> <p><b>Years</b><br/>Minimum recommended holding period in years</p> <p><b>Category</b><br/>V ... Very short term (max 1Y)<br/>S ... Short term (max 3Y)<br/>M ... Medium term (max 5Y)<br/>L ... Long term (min 5Y)<br/>H ... Hold to Maturity</p> |
| properties | isRef 0<br>content complex  |
| children   | <a href="#">Years</a> <a href="#">Category</a>  |



|            |   |
|------------|---|
| annotation | documentation<br>05080: Minimum recommended holding period<br>RHP: Recommended Holding Period |
|------------|---|

element

**EMT\_V41\_FinancialInstrumentType/TargetMarket/ClientObjectives/MinimumRecommendedHoldingPeriod/Years**

|            |  |
|------------|--|
| diagram    |  <p>Minimum recommended holding period in years</p> |
| type       | <b>xs:decimal</b>  |
| properties | isRef 0<br>content simple  |
| annotation | documentation<br>Minimum recommended holding period in years   |

element

**EMT\_V41\_FinancialInstrumentType/TargetMarket/ClientObjectives/MinimumRecommendedHoldingPeriod/Category**

|            |  |
|------------|--|
| diagram    |  <p>V ... Very short term (max 1Y)<br/>S ... Short term (max 3Y)<br/>M ... Medium term (max 5Y)<br/>L ... Long term (min 5Y)<br/>H ... Hold to Maturity</p> |
| type       | restriction of <b>xs:string</b>  |
| properties | isRef 0<br>content simple  |
| annotation | documentation<br>V ... Very short term (max 1Y)<br>S ... Short term (max 3Y)<br>M ... Medium term (max 5Y)<br>L ... Long term (min 5Y)<br>H ... Hold to Maturity   |

element

**EMT\_V41\_FinancialInstrumentType/TargetMarket/ClientObjectives/IntendedCompatibleWithClientsHavingSustainabilityPreferences**

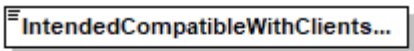
|            |  |
|------------|--|
| diagram    |  <p>05105: Discloses if the product is developed with the aim of being compatible with clients having ESG preferences. (Yes or Neutral).<br/>There is no Negative Target Market</p> |
| type       | <b>EMTYesNeutralType</b>   |
| properties | isRef 0<br>content simple  |
| facets     | Kind Value annotation<br>minLength 1   |

|            |   |
|------------|---|
|            | maxLength 7   |
| annotation | documentation<br>05105: Discloses if the product is developed with the aim of being compatible with clients having ESG preferences. (Yes or Neutral).<br>There is no Negative Target Market |

element

**EMT\_V41\_FinancialInstrumentType/TargetMarket/ClientObjectives/OtherSpecificInvestmentNeed**

|            |   |
|------------|---|
| diagram    | <p><b>OtherSpecificInvestmentNeed</b></p> <p>05115: No, Islamic banking or Other<br/>N...No,<br/>I... Islamic banking<br/>or O... Other</p> |
| type       | restriction of <b>xs:string</b>   |
| properties | isRef 0<br>content simple   |
| facets     | Kind Value annotation<br>length 1   |
| annotation | documentation<br>05115: No, Islamic banking or Other<br>N...No,<br>I... Islamic banking<br>or O... Other                                    |

element **EMT\_V41\_FinancialInstrumentType/TargetMarket/DistributionStrategy**

|            |  |
|------------|--|
| diagram    | <p><b>DistributionStrategy</b></p> <p>Target markets - Distribution Strategy</p> <p><b>ExecutionOnly</b><br/>06010: Retail or Professional or Both or Neither</p> <p><b>ExecutionWithCheckOrNonAdvisedServices</b><br/>06020: Retail or Professional or Both or Neither</p> <p><b>InvestmentAdvice</b><br/>06030: Retail or Professional or Both or Neither</p> <p><b>PortfolioManagement</b><br/>06040: Retail or Professional or Both or Neither</p> |
| properties | isRef 0<br>content complex   |
| children   | <a href="#">ExecutionOnly</a> <a href="#">ExecutionWithCheckOrNonAdvisedServices</a> <a href="#">InvestmentAdvice</a> <a href="#">PortfolioManagement</a>  |
| annotation | documentation<br>Target markets - Distribution Strategy  |

element **EMT\_V41\_FinancialInstrumentType/TargetMarket/DistributionStrategy/ExecutionOnly**

|         |   |
|---------|---|
| diagram | <p><b>ExecutionOnly</b></p> <p>06010: Retail or Professional or Both or Neither</p> |
|---------|---|

|            |   |
|------------|---|
| type       | <a href="#">RetailProfessionalBothNeitherType</a>                 |
| properties | isRef 0<br>content simple   |
| facets     | Kind Value annotation<br>length 1                                 |
| annotation | documentation<br>06010: Retail or Professional or Both or Neither |

element

**EMT\_V41\_FinancialInstrumentType/TargetMarket/DistributionStrategy/ExecutionWithCheckOrNonAdvisedServices**

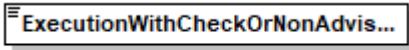
|            |   |
|------------|---|
| diagram    |  <p>06020: Retail or Professional or Both or Neither</p> |
| type       | <a href="#">RetailProfessionalBothNeitherType</a>   |
| properties | isRef 0<br>content simple   |
| facets     | Kind Value annotation<br>length 1   |
| annotation | documentation<br>06020: Retail or Professional or Both or Neither   |

element **EMT\_V41\_FinancialInstrumentType/TargetMarket/DistributionStrategy/InvestmentAdvice**

|            |   |
|------------|---|
| diagram    |  <p>06030: Retail or Professional or Both or Neither</p> |
| type       | <a href="#">RetailProfessionalBothNeitherType</a>   |
| properties | isRef 0<br>content simple   |
| facets     | Kind Value annotation<br>length 1   |
| annotation | documentation<br>06030: Retail or Professional or Both or Neither   |

element **EMT\_V41\_FinancialInstrumentType/TargetMarket/DistributionStrategy/PortfolioManagement**

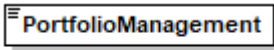
|            |   |
|------------|---|
| diagram    |  <p>06040: Retail or Professional or Both or Neither</p> |
| type       | <a href="#">RetailProfessionalBothNeitherType</a>   |
| properties | isRef 0<br>content simple   |
| facets     | Kind Value annotation<br>length 1   |
| annotation | documentation<br>06040: Retail or Professional or Both or Neither   |

element **EMT\_V41\_FinancialInstrumentType/CostsAndChargesExAnte**

|                   |   |
|-------------------|---|
| <p>diagram</p>    | <p><b>CostsAndChargesExAnte</b><br/>Costs and Charges ex ante</p> <p><b>Fund</b><br/>Relevant fields for funds</p> <p><b>StructuredSecurity</b><br/>Relevant fields for structured securities</p> <p><b>CostsReferenceDate</b><br/>07160 : The Reference Date to which all Ex-Ante Cost disclosures refer (i.e NOT to be mistaken for General Reference Date, field 00050 or Generation Date and Time, field 00005)</p> |
| <p>properties</p> | <p>isRef 0<br/>content complex</p>  |
| <p>children</p>   | <p><a href="#">Fund</a> <a href="#">StructuredSecurity</a> <a href="#">CostsReferenceDate</a></p>   |
| <p>annotation</p> | <p>documentation<br/>Costs and Charges ex ante</p>  |

element EMT\_V41\_FinancialInstrumentType/CostsAndChargesExAnte/Fund

diagram



**GrossMaxEntryCostNonAcquired**  
 07020 Maximum not acquired to the fund. Expressed as a % of the amount to be invested. This data is a maximum cost not assumed to the fund. It is indicative and should be adapted by the distributor reserving the file to take into account the commercial agreement with the asset manager. Conditional to the existence of the feature.

**NetEntryCostNonAcquired**  
 07021 Expressed as a % of the amount to be invested. Subscription NAV - Par Value. Applicable for Structured Fund.

**MaxEntryCostDaily**  
 07020 Maximum fixed amount per subscription, not incorporated. Flat fixed fee defined by the manufacturer (linked to Paying Agent). Only for the Italian Market. Conditional to the existence of the feature. It is subscription related but decided by the manufacturer. In all cases it must be adapted to the specific relationship between the manufacturer and the distributor. This cost is not taken in account in the entry cost item 07020.

**MaxEntryCostAcquired**  
 07040 Subscription fees acquired to the fund. Expressed as a % of the amount to be invested. Not included in the entry cost 07020. Conditional to the fact that the fund has this feature.

**MaxExitCost**  
 07030 Maximum cost acquired to the fund. Expressed as a % of the NAV. Maximum fees not assumed to the funds that could happen at a certain time during the life of the product. Conditional to the existence of this feature.

**MaxExitCostDaily**  
 07030 Maximum fixed amount per redemption, not incorporated. Flat fee defined by the manufacturer. Only for the Italian Market. Conditional to the existence of the feature. It is redemption related but decided by the manufacturer. In all cases it must be adapted to the specific relationship between the manufacturer and the distributor. This cost is not taken in account in the exit cost item 07030.

**MaxExitCostAcquired**  
 07070 Maximum Exit fees acquired to the fund. Expressed as a % of the NAV. Not included in the exit cost item 07030. Conditional to the existence of the feature.

**TypicalExitCost**  
 07080 Current exit cost linked to the RSP or Time to Maturity or 3Y (V) or 3Y(S) or 5Y (M) (the value of 0000). Minimum Assumed exit\_Holding\_Period.

**ExitCostPriorRSP**  
 07090 Expressed as a % of the amount to be distributed (Par Value - Exit Value (eg bid price). For Structured Fund only.

**OngoingCosts**  
 07100 % of NAV of the Financial Product expressed in annualized terms (rate of cost deduction to be applied). Ongoing costs include management fees and distribution fees and exclude all transaction costs, incidental costs and performance fees. Costs reported should reflect current running ongoing costs.

**BorrowingCosts**  
 07120 Financing costs related to borrowing for the purpose of paying, expressed as a % of NAV of the Financial Product expressed in annualized terms (rate of cost deduction to be applied). Only applicable if the product is borrowing. Borrowing costs are included in Ongoing costs.

**ManagementFee**  
 07110 % of NAV of the Financial Product expressed in annualized terms (rate of cost deduction to be applied). These fees are included in total on-going costs. These fees are used by distributors to calculate their gross spread fees. Costs reported should reflect current running management costs.

**DistributionFee**  
 07200 % of NAV of the Financial Product expressed in annualized terms (rate of cost deduction to be applied).

**TransactionCosts**  
 07130 % of NAV of the Financial Product expressed in annualized terms (rate of cost deduction to be applied). 0 for reinvested premium. Costs within the products.

**IncidentalCosts**  
 07140 % of NAV of the Financial Product expressed in annualized terms (rate of cost deduction to be applied). Includes Performance Fees and other costs.

|            |  |
|------------|--|
| properties | isRef 0<br>content complex   |
| children   | <a href="#">GrossMaxEntryCostNonAcquired</a> <a href="#">NetEntryCostNonAcquired</a> <a href="#">MaxEntryCostItaly</a> <a href="#">MaxEntryCostAcquired</a> <a href="#">MaxExitCost</a> <a href="#">MaxExitCostItaly</a> <a href="#">MaxExitCostAcquired</a> <a href="#">TypicalExitCost</a> <a href="#">ExitCostPriorRHP</a> <a href="#">OngoingCosts</a> <a href="#">BorrowingCostsUK</a> <a href="#">ManagementFee</a> <a href="#">DistributionFee</a> <a href="#">TransactionCosts</a> <a href="#">IncidentalCosts</a> |
| annotation | documentation<br>Relevant fields for funds   |

element

**EMT\_V41\_FinancialInstrumentType/CostsAndChargesExAnte/Fund/GrossMaxEntryCostNonAcquired**

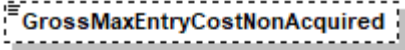
|            |   |
|------------|---|
| diagram    |  <p>07020: Maximum not acquired to the fund. Expressed as a % of the amount to be invested. This data is a maximum cost not acquired to the fund.. It is indicative and should be adapted by the distributor receiving the file to take into account the commercial agreement with the asset manager. Conditional to the existence of this feature</p> |
| type       | <b>xs:decimal</b>   |
| properties | isRef 0<br>minOcc 0<br>maxOcc 1<br>content simple   |
| annotation | documentation<br>07020: Maximum not acquired to the fund. Expressed as a % of the amount to be invested. This data is a maximum cost not acquired to the fund.. It is indicative and should be adapted by the distributor receiving the file to take into account the commercial agreement with the asset manager. Conditional to the existence of this feature   |

element **EMT\_V41\_FinancialInstrumentType/CostsAndChargesExAnte/Fund/NetEntryCostNonAcquired**

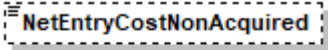
|            |  |
|------------|--|
| diagram    |  <p>07025: Expressed as a % of the amount to be invested. Subscription NAV - Fair Value. Applicable for Structured Fund</p> |
| type       | <b>xs:decimal</b>  |
| properties | isRef 0<br>minOcc 0<br>maxOcc 1<br>content simple  |
| annotation | documentation<br>07025: Expressed as a % of the amount to be invested. Subscription NAV - Fair Value. Applicable for Structured Fund   |

element **EMT\_V41\_FinancialInstrumentType/CostsAndChargesExAnte/Fund/MaxEntryCostItaly**

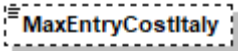
|            |   |
|------------|---|
| diagram    |  <p>07030: Maximum fixed amount per subscription, not incorporated. Flat fixed fee defined by the manufacturer (Linked to Paying Agent) Only for the Italian Market. Conditionnal to the existence of the feature<br/>It is subscription related but decided by the manufacturers. In all cases it must be adapted to the specific relationship between the manufacturers and the distribution. This cost is not taken in account in the entry cost item 07020</p> |
| type       | restriction of <b>xs:decimal</b>  |
| properties | <p>isRef 0<br/>minOcc 0<br/>maxOcc 1<br/>content simple</p>   |
| facets     | <p>Kind Value annotation<br/>minInclusive 0</p>   |
| annotation | <p>documentation<br/>07030: Maximum fixed amount per subscription, not incorporated. Flat fixed fee defined by the manufacturer (Linked to Paying Agent) Only for the Italian Market. Conditionnal to the existence of the feature<br/>It is subscription related but decided by the manufacturers. In all cases it must be adapted to the specific relationship between the manufacturers and the distribution. This cost is not taken in account in the entry cost item 07020</p>   |

element **EMT\_V41\_FinancialInstrumentType/CostsAndChargesExAnte/Fund/MaxEntryCostAcquired**

|            |  |
|------------|--|
| diagram    |  <p>07040: Subscription fees acquired to the fund<br/>Expressed as a % of the amount to be invested.<br/>Not included in the entry cost 07020. Conditionnal to the fact that the fund has this feature.</p> |
| type       | restriction of <b>xs:decimal</b>   |
| properties | <p>isRef 0<br/>minOcc 0<br/>maxOcc 1<br/>content simple</p>  |
| facets     | <p>Kind Value annotation<br/>minInclusive 0</p>  |
| annotation | <p>documentation<br/>07040: Subscription fees acquired to the fund<br/>Expressed as a % of the amount to be invested.<br/>Not included in the entry cost 07020. Conditionnal to the fact that the fund has this feature.</p>   |

element **EMT\_V41\_FinancialInstrumentType/CostsAndChargesExAnte/Fund/MaxExitCost**

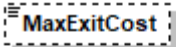
|            |   |
|------------|---|
| diagram    |  <p>07050: Maximum not acquired to the fund Expressed as a % of the NAV.<br/>Maximum fees not acquired to the funds that could happen at a certain time during the life of the product. Conditional to the existence of this feature</p> |
| type       | restriction of <b>xs:decimal</b>  |
| properties | <p>isRef 0<br/>minOcc 0<br/>maxOcc 1<br/>content simple</p>   |
| facets     | <p>Kind Value annotation<br/>minInclusive 0</p>   |
| annotation | <p>documentation<br/>07050: Maximum not acquired to the fund Expressed as a % of the NAV.<br/>Maximum fees not acquired to the funds that could happen at a certain time during the life of the product. Conditional to the existence of this feature</p>   |

element **EMT\_V41\_FinancialInstrumentType/CostsAndChargesExAnte/Fund/MaxExitCostItaly**

|            |  |
|------------|--|
| diagram    |  <p>07060: Maximum fixed amount per redemption, not incorporated. Flat fee defined by the manufacturer. Only for the Italian Market. Conditionnal to the existence of the feature.<br/>It is redemption related but decided by the manufacturers. In all cases it must be adapted to the specific relationship between the manufacturers and the distribution. This cost is not taken in account in the exit cost item 07050</p> |
| type       | restriction of <b>xs:decimal</b>   |
| properties | <p>isRef 0<br/>minOcc 0<br/>maxOcc 1<br/>content simple</p>  |
| facets     | <p>Kind Value annotation<br/>minInclusive 0</p>  |
| annotation | <p>documentation<br/>07060: Maximum fixed amount per redemption, not incorporated. Flat fee defined by the manufacturer. Only for the Italian Market. Conditionnal to the existence of the feature.<br/>It is redemption related but decided by the manufacturers. In all cases it must be adapted to the specific relationship between the manufacturers and the distribution. This cost is not taken in account in the exit cost item 07050</p>  |

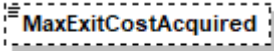

element **EMT\_V41\_FinancialInstrumentType/CostsAndChargesExAnte/Fund/MaxExitCostAcquired**

|            |  |
|------------|--|
| diagram    |  <p><b>MaxExitCostAcquired</b></p> <p>07070: Maximum Exit fees acquired to the fund Expressed as a % of the NAV. Not included in the exit cost item 07050 . Conditional to the existence of this feature.</p> |
| type       | restriction of <b>xs:decimal</b>   |
| properties | isRef 0<br>minOcc 0<br>maxOcc 1<br>content simple  |
| facets     | Kind Value annotation<br>minInclusive 0  |
| annotation | documentation<br>07070: Maximum Exit fees acquired to the fund Expressed as a % of the NAV. Not included in the exit cost item 07050 . Conditional to the existence of this feature.   |

element **EMT\_V41\_FinancialInstrumentType/CostsAndChargesExAnte/Fund/TypicalExitCost**

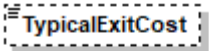
|            |  |
|------------|--|
| diagram    |  <p><b>TypicalExitCost</b></p> <p>07080: Current exit cost linked to the RHP or Time to Maturity or 1Y (V) or 3Y(S) or 5Y (M L) (the value of 05080_Minimum_Recommended_Holding_Period)</p> |
| type       | restriction of <b>xs:decimal</b>   |
| properties | isRef 0<br>minOcc 0<br>maxOcc 1<br>content simple  |
| facets     | Kind Value annotation<br>minInclusive 0  |
| annotation | documentation<br>07080: Current exit cost linked to the RHP or Time to Maturity or 1Y (V) or 3Y(S) or 5Y (M L) (the value of 05080_Minimum_Recommended_Holding_Period)   |

element **EMT\_V41\_FinancialInstrumentType/CostsAndChargesExAnte/Fund/ExitCostPriorRHP**

|            |  |
|------------|--|
| diagram    |  <p><b>ExitCostPriorRHP</b></p> <p>07090: Expressed as a % of the amount to be divested. Fair Value - Exit Value (eg Bid Price). For Structured Fund only</p> |
| type       | restriction of <b>xs:decimal</b>   |
| properties | isRef 0<br>minOcc 0<br>maxOcc 1<br>content simple  |
| facets     | Kind Value annotation  |

|            |   |
|------------|---|
|            | minInclusive 0  |
| annotation | documentation<br>07090: Expressed as a % of the amount to be divested. Fair Value - Exit Value (eg Bid Price). For Structured Fund only |

element **EMT\_V41\_FinancialInstrumentType/CostsAndChargesExAnte/Fund/OngoingCosts**

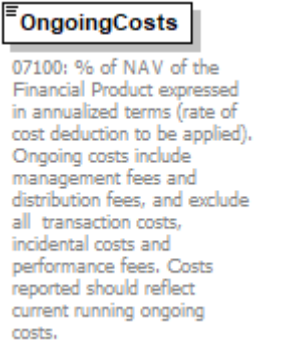
|            |  |
|------------|--|
| diagram    |  <p><b>OngoingCosts</b></p> <p>07100: % of NAV of the Financial Product expressed in annualized terms (rate of cost deduction to be applied). Ongoing costs include management fees and distribution fees, and exclude all transaction costs, incidental costs and performance fees. Costs reported should reflect current running ongoing costs.</p> |
| type       | restriction of <b>xs:decimal</b>   |
| properties | isRef 0<br>content simple  |
| facets     | Kind Value annotation<br>minInclusive 0  |
| annotation | documentation<br>07100: % of NAV of the Financial Product expressed in annualized terms (rate of cost deduction to be applied). Ongoing costs include management fees and distribution fees, and exclude all transaction costs, incidental costs and performance fees. Costs reported should reflect current running ongoing costs.  |

element **EMT\_V41\_FinancialInstrumentType/CostsAndChargesExAnte/Fund/BorrowingCostsUK**

|            |   |
|------------|---|
| diagram    |  <p><b>BorrowingCostsUK</b></p> <p>07105: Financing costs related to borrowing for the purposes of gearing expressed as a % of NAV of the Financial Product expressed in annualized terms (rate of cost deduction to be applied). Only applicable if the product is borrowing. Borrowing costs are included in Ongoing costs.</p> |
| type       | <b>xs:decimal</b>   |
| properties | isRef 0<br>minOcc 0<br>maxOcc 1<br>content simple   |
| annotation | documentation<br>07105: Financing costs related to borrowing for the purposes of gearing expressed as a % of NAV of the Financial Product expressed in annualized terms (rate of cost deduction to be applied). Only applicable if the product is borrowing. Borrowing costs are included in Ongoing costs.   |

element **EMT\_V41\_FinancialInstrumentType/CostsAndChargesExAnte/Fund/ManagementFee**

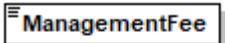
|            |  |
|------------|--|
| diagram    |  <p>07110: % of NAV of the Financial Product expressed in annualized terms (rate of cost deduction to be applied). These fees are included in total on going costs. These fees are used by distributors to calculate their retrocession fees. Costs reported should reflect current running management costs.</p> |
| type       | restriction of <b>xs:decimal</b>   |
| properties | isRef 0<br>content simple  |
| facets     | Kind Value annotation<br>minInclusive 0  |
| annotation | documentation<br>07110: % of NAV of the Financial Product expressed in annualized terms (rate of cost deduction to be applied). These fees are included in total on going costs. These fees are used by distributors to calculate their retrocession fees. Costs reported should reflect current running management costs.   |

element **EMT\_V41\_FinancialInstrumentType/CostsAndChargesExAnte/Fund/DistributionFee**

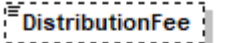
|            |  |
|------------|--|
| diagram    |  <p>07120: % of NAV of the Financial Product expressed in annualized terms (rate of cost deduction to be applied)</p> |
| type       | restriction of <b>xs:decimal</b>   |
| properties | isRef 0<br>minOcc 0<br>maxOcc 1<br>content simple  |
| facets     | Kind Value annotation<br>minInclusive 0  |
| annotation | documentation<br>07120: % of NAV of the Financial Product expressed in annualized terms (rate of cost deduction to be applied)   |

element **EMT\_V41\_FinancialInstrumentType/CostsAndChargesExAnte/Fund/TransactionCosts**

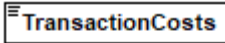
|            |  |
|------------|--|
| diagram    |  <p>07130: % of NAV of the Financial Product expressed in annualized terms (rate of cost deduction to be applied). 0 for structured products. Costs within the products</p> |
| type       | restriction of <b>xs:decimal</b>   |
| properties | isRef 0<br>content simple  |
| facets     | Kind Value annotation<br>minInclusive 0  |
| annotation | documentation<br>07130: % of NAV of the Financial Product expressed in annualized terms (rate of cost deduction to be applied).  |

|  |
|--|
| 0 for structured products. Costs within the products |
|--|

element **EMT\_V41\_FinancialInstrumentType/CostsAndChargesExAnte/Fund/IncidentalCosts**

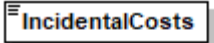
|            |  |
|------------|--|
| diagram    |  <p>07140: % of NAV of the Financial Product expressed in annualized terms (rate of cost deduction to be applied). Includes Performance Fees and other costs.</p> |
| type       | restriction of <b>xs:decimal</b>   |
| properties | isRef 0<br>content simple  |
| facets     | Kind Value annotation<br>minInclusive 0  |
| annotation | documentation<br>07140: % of NAV of the Financial Product expressed in annualized terms (rate of cost deduction to be applied). Includes Performance Fees and other costs.   |

element **EMT\_V41\_FinancialInstrumentType/CostsAndChargesExAnte/StructuredSecurity**

diagram

**StructuredSecurity**

Relevant fields for structured securities

**GrossMaxEntryCostNonAcquired**

07020: "Ask Price" - Fair Value ( as of Reference Date Ex-Ante ). This data should only incorporate manufacturer costs (i.e. cost of the financial instrument) and distributor upfront when known by the manufacturer. It should however NOT include distribution fees added on top of the product price by distributors that is out of control of the manufacturer.

**NetEntryCostNonAcquired**

07025: Net\_One-off Entry cost = 07020 less upfront distribution fee embedded in the 07020. In practice 07025 will be the portion of the 07020 retained by the manufacturer. This data is optional and could be used in the event of only one layer of intermediation or in a case where distributor up fronts are paid equally to all distributors. The costs reported in this field is a Net disclosure and therefore the distributor upfront is equal to the difference between 07020 and 07025.

**TypicalExitCost**

07080: Exit cost at the RHP

**ExitCostPriorRHP**

07090: Fixed amount

**OngoingCosts**

07100: Expressed as a % of NAV / Notional (or currency amount for Absolute quotation) of the Financial Product in annualized terms related to Reference in 07150 or 07155 respectively.

**ManagementFee**

07110: Expressed as a % of NAV / Notional (or currency amount for Absolute quotation) of the Financial Product in annualized terms related to Reference Value in 07150 or 07155 respectively. These fees are included in total on going costs. Only applicable if the product has this feature. These fees are used by distributors to calculate their retrocession fees

**IncidentalCostsExAnte**

07140: Expressed as a % of NAV / Notional (or currency amount for Absolute quotation) of the Financial Product in annualized terms related to Reference Value in 07150 or 07155 respectively.

**ReferencePrice**

07150: The Notional Reference Amount is the amount expressed in number of currency units to which a Unit disclosed Ex-Post cost is based and to which a Percentage disclosed cost should be multiplied in order to retrieve the Unit cost. This field is conditional and only used if 07150 is not used.

**NotionalReferenceAmount**

07155: Expressed as a % of NAV / Notional (or currency amount for Absolute quotation) of the Financial Product in annualized terms related to Reference Value in 07150 or 07155 respectively.

|            |   |
|------------|---|
| properties | isRef 0<br>content complex  |
| children   | <a href="#">GrossMaxEntryCostNonAcquired</a> <a href="#">NetEntryCostNonAcquired</a> <a href="#">TypicalExitCost</a> <a href="#">ExitCostPriorRHP</a> <a href="#">OngoingCosts</a> <a href="#">ManagementFee</a> <a href="#">IncidentalCostsExAnte</a> <a href="#">ReferencePrice</a> <a href="#">NotionalReferenceAmount</a> |
| annotation | documentation<br>Relevant fields for structured securities  |

element

### EMT\_V41\_FinancialInstrumentType/CostsAndChargesExAnte/StructuredSecurity/GrossMaxEntryCostNonAcquired

|            |   |
|------------|---|
| diagram    |  <p>07020:<br/>"Ask Price" - Fair Value ( as of Reference Date Ex-Ante ).<br/>This data should only incorporate manufacturer costs (i.e. cost of the financial instrument) and distributor upfront when known by the manufacturer. It should however NOT include distribution fees added on top of the product price by distributors that is out of control of the manufacturer.</p> |
| type       | <b>xs:decimal</b>   |
| properties | isRef 0<br>content simple   |
| annotation | documentation<br>07020:<br>"Ask Price" - Fair Value ( as of Reference Date Ex-Ante ).<br>This data should only incorporate manufacturer costs (i.e. cost of the financial instrument) and distributor upfront when known by the manufacturer. It should however NOT include distribution fees added on top of the product price by distributors that is out of control of the manufacturer.   |

element

### EMT\_V41\_FinancialInstrumentType/CostsAndChargesExAnte/StructuredSecurity/NetEntryCostNonAcquired

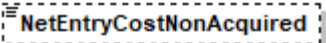
|            |   |
|------------|---|
| diagram    |  <p>07025: Net_One-off Entry cost = 07020 less upfront distribution fee embedded in the 07020. In practice 07025 will be the portion of the 07020 retained by the manufacturer. This data is optional and could be used in the event of only one layer of intermediation or in a case where distributor up fronts are paid equally to all distributors. The costs reported in this field is a Net disclosure and therefore the distributor upfront is equal to the difference between 07020 and 07025.</p> |
| type       | <b>xs:decimal</b>   |
| properties | isRef 0<br>minOcc 0<br>maxOcc 1<br>content simple   |
| annotation | documentation<br>07025: Net_One-off Entry cost = 07020 less upfront distribution fee embedded in the 07020. In practice 07025 will be the portion of the 07020 retained by the manufacturer.<br>This data is optional and could be used in the event of only one layer of intermediation or in a case where distributor up  |

fronts are paid equally to all distributors. The costs reported in this field is a Net disclosure and therefore the distributor upfront is equal to the difference between 07020 and 07025.

element

**EMT\_V41\_FinancialInstrumentType/CostsAndChargesExAnte/StructuredSecurity/TypicalExitCost**

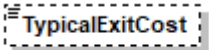
|            |  |
|------------|--|
| diagram    |  <p>07080: Exit cost at the RHP</p> |
| type       | <b>xs:decimal</b>  |
| properties | isRef 0<br>minOcc 0<br>maxOcc 1<br>content simple  |
| annotation | documentation<br>07080: Exit cost at the RHP   |

element

**EMT\_V41\_FinancialInstrumentType/CostsAndChargesExAnte/StructuredSecurity/ExitCostPriorRHP**

|            |  |
|------------|--|
| diagram    |  <p>07090: Fixed amount</p> |
| type       | <b>xs:decimal</b>  |
| properties | isRef 0<br>content simple  |
| annotation | documentation<br>07090: Fixed amount   |

element

**EMT\_V41\_FinancialInstrumentType/CostsAndChargesExAnte/StructuredSecurity/OngoingCosts**

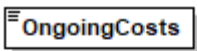
|            |  |
|------------|--|
| diagram    |  <p>07100: Expressed as a % of NAV / Notional (or currency amount for Absolute quotation) of the Financial Product in annualized terms related to Reference in 07150 or 07155 respectively.</p> |
| type       | <b>xs:decimal</b>  |
| properties | isRef 0<br>content simple  |
| annotation | documentation<br>07100: Expressed as a % of NAV / Notional (or currency amount for Absolute quotation) of the Financial Product in annualized terms related to Reference in 07150 or 07155 respectively.   |

element

**EMT\_V41\_FinancialInstrumentType/CostsAndChargesExAnte/StructuredSecurity/ManagementFee**

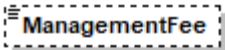
|            |   |
|------------|---|
| diagram    |  <p>07110: Expressed as a % of NAV / Notional (or currency amount for Absolute quotation) of the Financial Product in annualized terms related to Reference Value in 07150 or 07155 respectively. These fees are included in total on going costs. Only applicable if the product has this feature. These fees are used by distributors to calculate their retrocession fees</p> |
| type       | <b>xs:decimal</b>   |
| properties | isRef 0<br>minOcc 0<br>maxOcc 1<br>content simple   |
| annotation | documentation<br>07110: Expressed as a % of NAV / Notional (or currency amount for Absolute quotation) of the Financial Product in annualized terms related to Reference Value in 07150 or 07155 respectively. These fees are included in total on going costs. Only applicable if the product has this feature. These fees are used by distributors to calculate their retrocession fees   |

element

**EMT\_V41\_FinancialInstrumentType/CostsAndChargesExAnte/StructuredSecurity/IncidentalCostsExAnte**

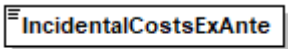
|            |  |
|------------|--|
| diagram    |  <p>07140: Expressed as a % of NAV / Notional (or currency amount for Absolute quotation) of the Financial Product in annualized terms related to Reference Value in 07150 or 07155 respectively.</p> |
| type       | restriction of <b>xs:decimal</b>   |
| properties | isRef 0<br>content simple  |
| annotation | documentation<br>07140: Expressed as a % of NAV / Notional (or currency amount for Absolute quotation) of the Financial Product in annualized terms related to Reference Value in 07150 or 07155 respectively.   |



element

**EMT\_V41\_FinancialInstrumentType/CostsAndChargesExAnte/StructuredSecurity/ReferencePrice**

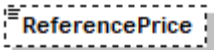
|            |   |
|------------|---|
| diagram    |  <p>07150: The Notional Reference Amount is the amount expressed in number of currency units to which a Unit disclosed Ex-Post cost is based and to which a Percentage disclosed cost should be multiplied in order to retrieve the Unit cost. This field is conditional and only used if 07150 is not used.</p> |
| type       | <b>xs:decimal</b>   |
| properties | isRef 0<br>minOcc 0<br>maxOcc 1<br>content simple   |
| annotation | documentation<br>07150: The Notional Reference Amount is the amount expressed in number of currency units to which a Unit disclosed Ex-Post cost is based and to which a Percentage disclosed cost should be multiplied in order to retrieve the Unit cost. This field is conditional and only used if 07150 is not used.   |

element

**EMT\_V41\_FinancialInstrumentType/CostsAndChargesExAnte/StructuredSecurity/NotionalReferenceAmount**

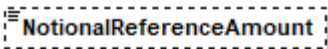
|            |  |
|------------|--|
| diagram    |  <p>07155: Expressed as a % of NAV / Notional (or currency amount for Absolute quotation) of the Financial Product in annualized terms related to Reference Value in 07150 or 07155 respectively.</p> |
| type       | <b>xs:decimal</b>  |
| properties | isRef 0<br>minOcc 0<br>maxOcc 1<br>content simple  |
| annotation | documentation<br>07155: Expressed as a % of NAV / Notional (or currency amount for Absolute quotation) of the Financial Product in annualized terms related to Reference Value in 07150 or 07155 respectively.   |

element **EMT\_V41\_FinancialInstrumentType/CostsAndChargesExAnte/CostsReferenceDate**

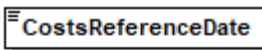
|            |   |
|------------|---|
| diagram    |  <p>07160 : The Reference Date to which all Ex-Ante Cost disclosures refer (i.e NOT to be mistaken for General Reference Date, field 00050 or Generation Date and Time, field 00005)</p> |
| type       | <b>xs:date</b>  |
| properties | isRef 0   |

|            |   |
|------------|---|
|            | content simple  |
| annotation | documentation<br>07160 : The Reference Date to which all Ex-Ante Cost disclosures refer (i.e NOT to be mistaken for General Reference Date, field 00050 or Generation Date and Time, field 00005) |

element **EMT\_V41\_FinancialInstrumentType/CostsAndChargesExPost**

|            |   |
|------------|---|
| diagram    | <p><b>CostsAndChargesExPost</b><br/>Costs and Charges ex post</p> <p><b>Fund</b><br/>Relevant fields for funds</p> <p><b>StructuredSecurity</b><br/>Relevant fields for structured securities</p> <p><b>ReferencePeriod</b></p> |
| properties | isRef 0<br>minOcc 0<br>maxOcc 1<br>content complex  |
| children   | <a href="#">Fund</a> <a href="#">StructuredSecurity</a> <a href="#">ReferencePeriod</a>   |
| annotation | documentation<br>Costs and Charges ex post  |

element **EMT\_V41\_FinancialInstrumentType/CostsAndChargesExPost/Fund**

|                   |   |
|-------------------|---|
| <p>diagram</p>    | <p><b>Fund</b><br/>Relevant fields for funds</p> <ul style="list-style-type: none"> <li><b>EntryCostAcquired</b><br/>08025: % of NAV</li> <li><b>OngoingCosts</b><br/>08030: % of NAV of the Financial Product expressed in annualized terms (rate of cost deduction to be applied)</li> <li><b>BorrowingCoststUK</b><br/>08045: Financing costs related to borrowing for the purposes of gearing expressed as a % of NAV of the Financial Product expressed in annualized terms (rate of cost deduction to be applied)</li> <li><b>ManagementFee</b><br/>08050: % of NAV of the Financial Product expressed in annualized terms (rate of cost deduction to be applied)</li> <li><b>DistributionFee</b><br/>08060: % of NAV of the Financial Product expressed in annualized terms (rate of cost deduction to be applied). Only applicable if the product has this feature (legal wording in the documentation). These fees are included in total on going costs and are not included into the management fees.</li> <li><b>TransactionCosts</b><br/>08070: % of NAV of the Financial Product expressed in annualized terms (rate of cost deduction to be applied). Costs within the products</li> <li><b>IncidentalCosts</b><br/>08080: Incidental costs ex post % of NAV of the Financial Product expressed in annualized terms (rate of cost deduction to be applied)</li> </ul> |
| <p>properties</p> | <p>isRef 0<br/>content complex</p>  |
| <p>children</p>   | <p><a href="#">EntryCostAcquired</a> <a href="#">OngoingCosts</a> <a href="#">BorrowingCoststUK</a> <a href="#">ManagementFee</a> <a href="#">DistributionFee</a> <a href="#">TransactionCosts</a> <a href="#">IncidentalCosts</a></p>  |
| <p>annotation</p> | <p>documentation<br/>Relevant fields for funds</p>  |

element **EMT\_V41\_FinancialInstrumentType/CostsAndChargesExPost/Fund/EntryCostAcquired**

|            |  |
|------------|--|
| diagram    |  <p>08025:<br/>% of NAV</p> |
| type       | restriction of <b>xs:decimal</b>   |
| properties | isRef 0<br>minOcc 0<br>maxOcc 1<br>content simple  |
| annotation | documentation<br>08025:<br>% of NAV  |

element **EMT\_V41\_FinancialInstrumentType/CostsAndChargesExPost/Fund/OngoingCosts**

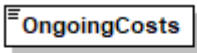
|            |  |
|------------|--|
| diagram    |  <p>08030: % of NAV of the Financial Product expressed in annualized terms (rate of cost deduction to be applied)</p> |
| type       | <b>xs:decimal</b>  |
| properties | isRef 0<br>content simple  |
| annotation | documentation<br>08030: % of NAV of the Financial Product expressed in annualized terms (rate of cost deduction to be applied)   |

element **EMT\_V41\_FinancialInstrumentType/CostsAndChargesExPost/Fund/BorrowingCoststUK**

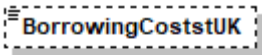
|            |  |
|------------|--|
| diagram    |  <p>08045: Financing costs related to borrowing for the purposes of gearing expressed as a % of NAV of the Financial Product expressed in annualized terms (rate of cost deduction to be applied)</p> |
| type       | <b>xs:decimal</b>  |
| properties | isRef 0<br>minOcc 0<br>maxOcc 1<br>content simple  |
| annotation | documentation<br>08045: Financing costs related to borrowing for the purposes of gearing expressed as a % of NAV of the Financial Product expressed in annualized terms (rate of cost deduction to be applied)   |

element **EMT\_V41\_FinancialInstrumentType/CostsAndChargesExPost/Fund/ManagementFee**

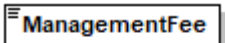
|            |  |
|------------|--|
| diagram    |  <p>08050: % of NAV of the Financial Product expressed in annualized terms (rate of cost deduction to be applied)</p> |
| type       | <b>xs:decimal</b>  |
| properties | isRef 0<br>content simple  |
| annotation | documentation<br>08050: % of NAV of the Financial Product expressed in annualized terms (rate of cost deduction to be applied)   |

element **EMT\_V41\_FinancialInstrumentType/CostsAndChargesExPost/Fund/DistributionFee**

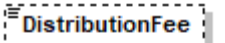
|            |  |
|------------|--|
| diagram    |  <p>08060:<br/>% of NAV of the Financial Product expressed in annualized terms (rate of cost deduction to be applied). Only applicable if the product has this feature (legal wording in the documentation). These fees are included in total on going costs and are not included into the management fees.</p> |
| type       | <b>xs:decimal</b>  |
| properties | isRef 0<br>minOcc 0<br>maxOcc 1<br>content simple  |
| annotation | documentation<br>08060:<br>% of NAV of the Financial Product expressed in annualized terms (rate of cost deduction to be applied). Only applicable if the product has this feature (legal wording in the documentation). These fees are included in total on going costs and are not included into the management fees.  |

element **EMT\_V41\_FinancialInstrumentType/CostsAndChargesExPost/Fund/TransactionCosts**

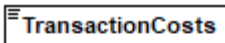
|            |   |
|------------|---|
| diagram    |  <p>08070: % of NAV of the Financial Product expressed in annualized terms (rate of cost deduction to be applied). Costs within the products</p> |
| type       | <b>xs:decimal</b>   |
| properties | isRef 0<br>content simple   |
| annotation | documentation<br>08070: % of NAV of the Financial Product expressed in annualized terms (rate of cost deduction to be applied). Costs within the products   |

element **EMT\_V41\_FinancialInstrumentType/CostsAndChargesExPost/Fund/IncidentalCosts**

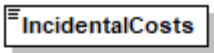
|                   |   |
|-------------------|---|
| <p>diagram</p>    |  <p>08080: Incidental costs ex post<br/>% of NAV of the Financial Product expressed in annualized terms (rate of cost deduction to be applied)</p> |
| <p>type</p>       | <p><b>xs:decimal</b></p>  |
| <p>properties</p> | <p>isRef 0<br/>content simple</p>   |
| <p>annotation</p> | <p>documentation<br/>08080: Incidental costs ex post<br/>% of NAV of the Financial Product expressed in annualized terms (rate of cost deduction to be applied)</p>   |

element **EMT\_V41\_FinancialInstrumentType/CostsAndChargesExPost/StructuredSecurity**

diagram

**StructuredSecurity**  
Relevant fields for structured securities

**GrossEntryCost**  
08010: This data should only incorporate manufacturer costs (i.e. cost of the financial instrument) and distributor upfront when known by the manufacturer. It should however NOT include distribution fees added on top of the product price by distributors that is out of control of the manufacturer.

**NetEntryCost**  
08015: Net one off entry cost ex post.  
Net One-off Entry cost = 08010 less upfront distribution fee embedded in the 08010. In practice 08015 will be the portion of the 08010 retained by the manufacturer.  
This data is optional and could be used in the event of only one layer of intermediation or in a case where distributor up fronts are paid equally to all distributors. The costs reported in this field is a Net disclosure and therefore the distributor upfront is equal to the difference between 08010 and 08025.

**ExitCost**  
08020:  
Fixed amount  
If 00096 set to U : number of units in product currency  
If 00096 set to P : % of Reference in field 08110 or 08120 respectively.  
This exit cost is supposed to be prior RHP

**OngoingCosts**  
08030: Expressed as a % of NAV / Notional (or currency amount for Absolute quotation) of the Financial Product in annualized terms related to Reference Value in 08110

**OngoingCostsAccumulated**  
08040: Sum of each daily Recurring Product Costs  
Presented in absolute figures in product currency accumulated during the year up until the End of Reference Date Period. Ex Post in field 08100.  
Mandatory field for Distribution in Germany, Switzerland and Austria

**ManagementFee**  
08050: Expressed as a % of NAV / Notional (or currency amount for Absolute quotation) of the Financial Product in annualized terms related to Reference Value in 08110.  
These fees are included in total on going costs. Only applicable if the product has this feature. These fees are used by distributors to calculate their retrocession fees

**IncidentalCosts**  
08080: Expressed as a % of NAV / Notional (or currency amount for Absolute quotation) of the Financial Product in annualized terms related to Reference Value in 08110  
If 00096 set to U : number of units in product currency  
If 00096 set to P : % of Reference in field 08110 or 08120 respectively.

**ReferencePrice**  
08110: The Reference Price is the instrument price to which a Unit disclosed Ex-Post cost is based and to which a Percentage disclosed cost should be multiplied in order to retrieve the Unit cost. This field is conditional and only used if 08120 is not used.

**NotionalReferenceAmount**  
080120: The Notional Reference Amount is the amount expressed in number of currency units to which a Unit disclosed Ex-Post cost is based and to which a Percentage disclosed cost should be multiplied in order to retrieve the Unit cost. This field is conditional and only used if 08110 is not used.



|            |  |
|------------|--|
| properties | isRef 0<br>content complex   |
| children   | <a href="#">GrossEntryCost</a> <a href="#">NetEntryCost</a> <a href="#">ExitCost</a> <a href="#">OngoingCosts</a> <a href="#">OngoingCostsAccumulated</a> <a href="#">ManagementFee</a> <a href="#">IncidentalCosts</a> <a href="#">ReferencePrice</a> <a href="#">NotionalReferenceAmount</a> |
| annotation | documentation<br>Relevant fields for structured securities   |

element

**EMT\_V41\_FinancialInstrumentType/CostsAndChargesExPost/StructuredSecurity/GrossEntryCost**

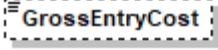
|            |  |
|------------|--|
| diagram    |  <p>08010: This data should only incorporate manufacturer costs (i.e. cost of the financial instrument) and distributor upfront when known by the manufacturer. It should however NOT include distribution fees added on top of the product price by distributors that is out of control of the manufacturer.</p> |
| type       | <b>xs:decimal</b>  |
| properties | isRef 0<br>minOcc 0<br>maxOcc 1<br>content simple  |
| annotation | documentation<br>08010: This data should only incorporate manufacturer costs (i.e. cost of the financial instrument) and distributor upfront when known by the manufacturer. It should however NOT include distribution fees added on top of the product price by distributors that is out of control of the manufacturer.   |

element **EMT\_V41\_FinancialInstrumentType/CostsAndChargesExPost/StructuredSecurity/NetEntryCost**

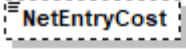
|            |  |
|------------|--|
| diagram    |  <p>08015: Net one off entry cost ex post<br/>Net One-off Entry cost = 08010 less upfront distribution fee embedded in the 08010. In practice 08015 will be the portion of the 08010 retained by the manufacturer.<br/>This data is optional and could be used in the event of only one layer of intermediation or in a case where distributor up fronts are paid equally to all distributors. The costs reported in this field is a Net disclosure and therefore the distributor upfront is equal to the difference between 08010 and 08025.</p> |
| type       | <b>xs:decimal</b>  |
| properties | isRef 0<br>minOcc 0<br>maxOcc 1<br>content simple  |

|            |   |
|------------|---|
| annotation | <p>documentation</p> <p>08015: Net one off entry cost ex post<br/> Net One-off Entry cost = 08010 less upfront distribution fee embedded in the 08010. In practice 08015 will be the portion of the 08010 retained by the manufacturer.</p> <p>This data is optional and could be used in the event of only one layer of intermediation or in a case where distributor up fronts are paid equally to all distributors. The costs reported in this field is a Net disclosure and therefore the distributor upfront is equal to the difference between 08010 and 08025.</p> |
|------------|---|

element **EMT\_V41\_FinancialInstrumentType/CostsAndChargesExPost/StructuredSecurity/ExitCost**

|            |  |
|------------|--|
| diagram    |  <p>08020:<br/> Fixed amount<br/> If 00096 set to U : number of units in product currency<br/> If 00096 set to P : % of Reference in field 08110 or 08120 respectively.<br/> This exit cost is supposed to be prior RHP</p> |
| type       | <b>xs:decimal</b>  |
| properties | isRef 0<br>minOcc 0<br>maxOcc 1<br>content simple  |
| annotation | <p>documentation</p> <p>08020:<br/> Fixed amount<br/> If 00096 set to U : number of units in product currency<br/> If 00096 set to P : % of Reference in field 08110 or 08120 respectively.<br/> This exit cost is supposed to be prior RHP</p>  |

element **EMT\_V41\_FinancialInstrumentType/CostsAndChargesExPost/StructuredSecurity/OngoingCosts**

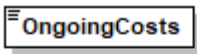
|            |   |
|------------|---|
| diagram    |  <p>08030: Expressed as a % of NAV / Notional (or currency amount for Absolute quotation) of the Financial Product in annualized terms related to Reference Value in 08110</p> |
| type       | <b>xs:decimal</b>   |
| properties | isRef 0<br>content simple   |
| annotation | <p>documentation</p> <p>08030: Expressed as a % of NAV / Notional (or currency amount for Absolute quotation) of the Financial Product in annualized terms related to Reference Value in 08110</p>  |

element

**EMT\_V41\_FinancialInstrumentType/CostsAndChargesExPost/StructuredSecurity/OngoingCostsAccumulated**

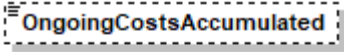
|            |  |
|------------|--|
| diagram    |  <p>08040: Sum of each daily Recurring Product Costs<br/>Presented in absolute figures in product currency accumulated during the year up until the End of Reference Date Period Ex Post in field 08100.<br/>Mandatory field for Distribution in Germany, Switzerland and Austria</p> |
| type       | <b>xs:decimal</b>  |
| properties | isRef 0<br>minOcc 0<br>maxOcc 1<br>content simple  |
| annotation | documentation<br>08040: Sum of each daily Recurring Product Costs<br>Presented in absolute figures in product currency accumulated during the year up until the End of Reference Date Period Ex Post in field 08100.<br>Mandatory field for Distribution in Germany, Switzerland and Austria   |

element

**EMT\_V41\_FinancialInstrumentType/CostsAndChargesExPost/StructuredSecurity/ManagementFee**

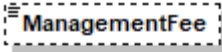
|            |  |
|------------|--|
| diagram    |  <p>08050: Expressed as a % of NAV / Notional (or currency amount for Absolute quotation) of the Financial Product in annualized terms related to Reference Value in 08110.<br/>These fees are included in total on going costs. Only applicable if the product has this feature. These fees are used by distributors to calculate their retrocession fees</p> |
| type       | <b>xs:decimal</b>  |
| properties | isRef 0<br>minOcc 0<br>maxOcc 1<br>content simple  |
| annotation | documentation<br>08050: Expressed as a % of NAV / Notional (or currency amount for Absolute quotation) of the Financial Product in annualized terms related to Reference Value in 08110.<br>These fees are included in total on going costs. Only applicable if the product has this feature. These fees are used by distributors to calculate their retrocession fees   |

element

**EMT\_V41\_FinancialInstrumentType/CostsAndChargesExPost/StructuredSecurity/IncidentalCosts**

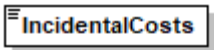
|            |  |
|------------|--|
| diagram    |  <p>08080: Expressed as a % of NAV / Notional (or currency amount for Absolute quotation) of the Financial Product in annualized terms related to Reference Value in 08110<br/>If 00096 set to U : number of units in product currency<br/>If 00096 set to P : % of Reference in field 08110 or 08120 respectively.</p> |
| type       | <b>xs:decimal</b>  |
| properties | isRef 0<br>content simple  |
| annotation | documentation<br>08080: Expressed as a % of NAV / Notional (or currency amount for Absolute quotation) of the Financial Product in annualized terms related to Reference Value in 08110<br>If 00096 set to U : number of units in product currency<br>If 00096 set to P : % of Reference in field 08110 or 08120 respectively.   |

element

**EMT\_V41\_FinancialInstrumentType/CostsAndChargesExPost/StructuredSecurity/ReferencePrice**

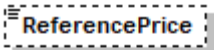
|            |  |
|------------|--|
| diagram    |  <p>08110: The Reference Price is the instrument price to which a Unit disclosed Ex-Post cost is based and to which a Percentage disclosed cost should be multiplied in order to retrieve the Unit cost. This field is conditional and only used if 08120 is not used.</p> |
| type       | <b>xs:decimal</b>  |
| properties | isRef 0<br>minOcc 0<br>maxOcc 1<br>content simple  |
| annotation | documentation<br>08110: The Reference Price is the instrument price to which a Unit disclosed Ex-Post cost is based and to which a Percentage disclosed cost should be multiplied in order to retrieve the Unit cost. This field is conditional and only used if 08120 is not used.  |

element

**EMT\_V41\_FinancialInstrumentType/CostsAndChargesExPost/StructuredSecurity/NotionalReferenceAmount**

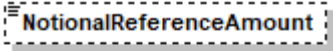
|            |  |
|------------|--|
| diagram    |  <p>080120: The Notional Reference Amount is the amount expressed in number of currency units to which a Unit disclosed Ex-Post cost is based and to which a Percentage disclosed cost should be multiplied in order to retrieve the Unit cost. This field is conditional and only used if 08110 is not used.</p> |
| type       | <b>xs:decimal</b>  |
| properties | <p>isRef 0<br/> minOcc 0<br/> maxOcc 1<br/> content simple</p>   |
| annotation | <p>documentation<br/> 080120: The Notional Reference Amount is the amount expressed in number of currency units to which a Unit disclosed Ex-Post cost is based and to which a Percentage disclosed cost should be multiplied in order to retrieve the Unit cost. This field is conditional and only used if 08110 is not used.</p>  |

element **EMT\_V41\_FinancialInstrumentType/CostsAndChargesExPost/ReferencePeriod**

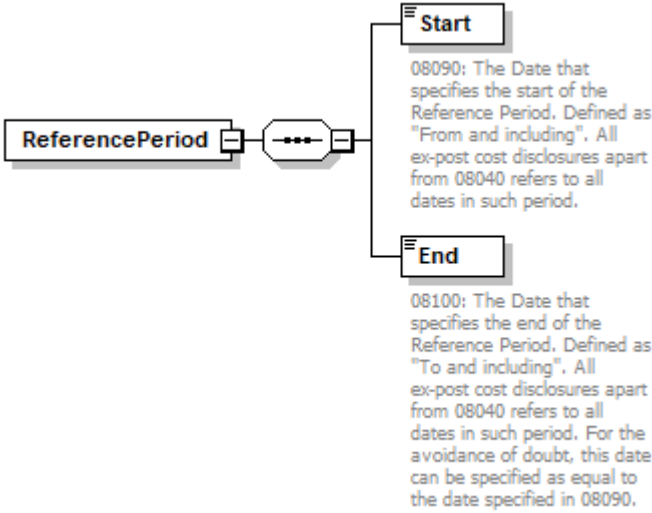
|            |  |
|------------|--|
| diagram    |  <p>08090: The Date that specifies the start of the Reference Period. Defined as "From and including". All ex-post cost disclosures apart from 08040 refers to all dates in such period.</p> <p>08100: The Date that specifies the end of the Reference Period. Defined as "To and including". All ex-post cost disclosures apart from 08040 refers to all dates in such period. For the avoidance of doubt, this date can be specified as equal to the date specified in 08090.</p> |
| properties | <p>isRef 0<br/> content complex</p>  |
| children   | <a href="#">Start</a> <a href="#">End</a>  |

element **EMT\_V41\_FinancialInstrumentType/CostsAndChargesExPost/ReferencePeriod/Start**

|            |   |
|------------|---|
| diagram    |  <p>08090: The Date that specifies the start of the Reference Period. Defined as "From and including". All ex-post cost disclosures apart from 08040 refers to all dates in such period.</p> |
| type       | <b>xs:date</b>  |
| properties | isRef 0<br>content simple   |
| annotation | documentation<br>08090: The Date that specifies the start of the Reference Period. Defined as "From and including". All ex-post cost disclosures apart from 08040 refers to all dates in such period.   |

element **EMT\_V41\_FinancialInstrumentType/CostsAndChargesExPost/ReferencePeriod/End**

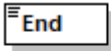
|            |   |
|------------|---|
| diagram    |  <p>08100: The Date that specifies the end of the Reference Period. Defined as "To and including". All ex-post cost disclosures apart from 08040 refers to all dates in such period. For the avoidance of doubt, this date can be specified as equal to the date specified in 08090.</p> |
| type       | <b>xs:date</b>  |
| properties | isRef 0<br>content simple   |
| annotation | documentation<br>08100: The Date that specifies the end of the Reference Period. Defined as "To and including". All ex-post cost disclosures apart from 08040 refers to all dates in such period. For the avoidance of doubt, this date can be specified as equal to the date specified in 08090.   |

element **EMT\_V41\_FinancialInstrumentType/AdditionalInformationUK**

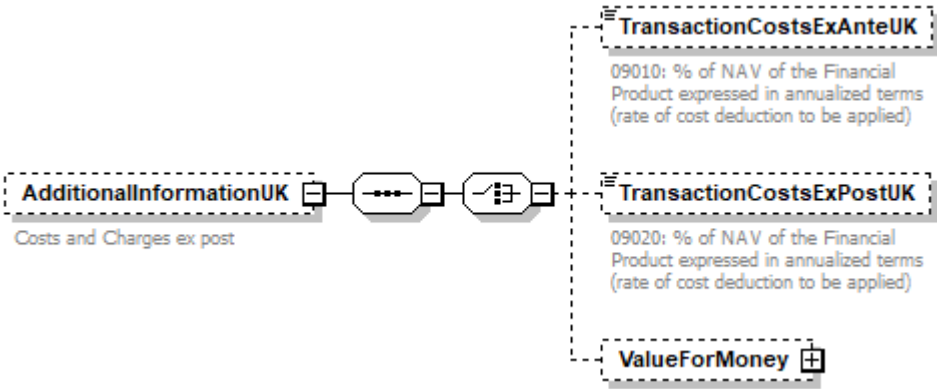
|            |  |
|------------|--|
| diagram    |  <p>09010: % of NAV of the Financial Product expressed in annualized terms (rate of cost deduction to be applied)</p> <p>09020: % of NAV of the Financial Product expressed in annualized terms (rate of cost deduction to be applied)</p> |
| properties | isRef 0<br>minOcc 0<br>maxOcc 1<br>content complex   |

|            |   |
|------------|---|
| children   | <a href="#">TransactionCostsExAnteUK</a> <a href="#">TransactionCostsExPostUK</a> <a href="#">ValueForMoney</a> |
| annotation | documentation<br>Costs and Charges ex post  |

element **EMT\_V41\_FinancialInstrumentType/AdditionalInformationUK/TransactionCostsExAnteUK**

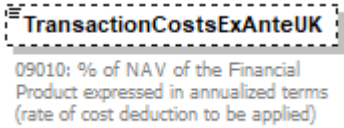
|            |  |
|------------|--|
| diagram    |  <p>09010: % of NAV of the Financial Product expressed in annualized terms (rate of cost deduction to be applied)</p> |
| type       | <b>xs:decimal</b>  |
| properties | isRef 0<br>minOcc 0<br>maxOcc 1<br>content simple  |
| annotation | documentation<br>09010: % of NAV of the Financial Product expressed in annualized terms (rate of cost deduction to be applied)   |

element **EMT\_V41\_FinancialInstrumentType/AdditionalInformationUK/TransactionCostsExPostUK**

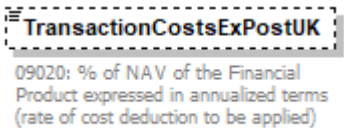
|            |   |
|------------|---|
| diagram    |  <p>09020: % of NAV of the Financial Product expressed in annualized terms (rate of cost deduction to be applied)</p> |
| type       | <b>xs:decimal</b>   |
| properties | isRef 0<br>minOcc 0<br>maxOcc 1<br>content simple   |
| annotation | documentation<br>09020: % of NAV of the Financial Product expressed in annualized terms (rate of cost deduction to be applied)  |

element **EMT\_V41\_FinancialInstrumentType/AdditionalInformationUK/ValueForMoney**

|                   |  |
|-------------------|--|
| <p>diagram</p>    | <p><b>EMTDataReportingVFM</b><br/>09030: Specifies if the Value for Money section is filled in the current EMT posting.</p> <p><b>IsAssessmentOfValueRequired...</b><br/>09040: Specifies if the Value for Money section is filled in the current EMT posting.</p> <p><b>OutcomeOfCOLLAssessmentOf...</b><br/>09050: "1 – charges are justified based on assessment and any action taken or, where the first assessment is not yet due, based on initial product design<br/>2 – charges are not justified, significant action is required"</p> <p><b>OutcomeOfPRINValueAssesse...</b><br/>09060: "1 – product expected to provide fair value for reasonably foreseeable period<br/>2 – review indicates significant changes required in order to provide fair value"</p> <p><b>OtherReviewRelatedToValueAnd...</b><br/>09070: "A – In line with ESMA supervisory briefing on the supervision of costs in UCITS and AIFs or relevant NCA supervisory activity<br/>O – Other local requirements or procedures"</p> <p><b>FurtherInformation</b><br/>09080: Link to sources of relevant information</p> <p><b>ReviewDate</b><br/>09090: Date of value assessment review or date COLL assessment of value report published or initial launch date</p> <p><b>ReviewNextDue</b><br/>09100: The Date that specifies the start of the Reference Period. Defined as "From and including". All ex-post cost disclosures apart from 08040 refers to all dates in such period.</p> |
| <p>properties</p> | <p>isRef 0<br/>minOcc 0<br/>maxOcc 1<br/>content complex</p>   |
| <p>children</p>   | <p><a href="#">EMTDataReportingVFM</a> <a href="#">IsAssessmentOfValueRequiredUnderCOLL</a> <a href="#">OutcomeOfCOLLAssessmentOfValue</a></p>   |



|  |   |
|--|---|
|  | <a href="#">OutcomeOfPRINValueAssessmentOrReview</a> <a href="#">OtherReviewRelatedToValueAndOrCharges</a> <a href="#">FurtherInformation</a><br><a href="#">ReviewDate</a> <a href="#">ReviewNextDue</a> |
|--|---|

element

**EMT\_V41\_FinancialInstrumentType/AdditionalInformationUK/ValueForMoney/EMTDataReportingVFM**

|            |   |
|------------|---|
| diagram    |  <p>EMTDataReportingVFM</p> <p>09030: Specifies if the Value for Money section is filled in the current EMT posting.</p> |
| type       | extension of <a href="#">EMTYesEmptyType</a>  |
| properties | isRef 0<br>content complex  |
| annotation | documentation<br>09030: Specifies if the Value for Money section is filled in the current EMT posting.  |

element

**EMT\_V41\_FinancialInstrumentType/AdditionalInformationUK/ValueForMoney/IsAssessmentOfValueRequiredUnderCOLL**

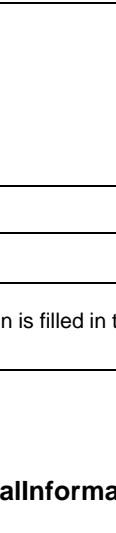
|            |  |
|------------|--|
| diagram    |  <p>IsAssessmentOfValueRequired...</p> <p>09040: Specifies if the Value for Money section is filled in the current EMT posting.</p> |
| type       | <a href="#">EMTYesNoType</a>   |
| properties | isRef 0<br>minOcc 0<br>maxOcc 1<br>content simple  |
| facets     | Kind Value annotation<br>length 1  |
| annotation | documentation<br>09040: Specifies if the Value for Money section is filled in the current EMT posting.   |

element

**EMT\_V41\_FinancialInstrumentType/AdditionalInformationUK/ValueForMoney/OutcomeOfCOLLAssessmentOfValue**

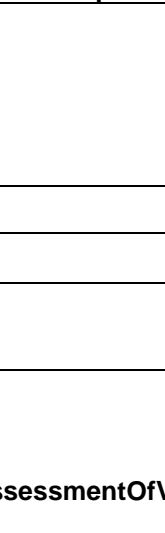
|            |   |
|------------|---|
| diagram    |  <p>OutcomeOfCOLLAssessmentOf...</p> <p>09050: "1 – charges are justified based on assessment and any action taken or, where the first assessment is not yet due, based on initial product design<br/>2 – charges are not justified, significant action is required"</p> |
| type       | restriction of <b>xs:string</b>   |
| properties | isRef 0<br>minOcc 0<br>maxOcc 1   |

|            |  |
|------------|--|
|            | content simple   |
| annotation | documentation<br>09050: "1 – charges are justified based on assessment and any action taken or, where the first assessment is not yet due, based on initial product design<br>2 – charges are not justified, significant action is required" |

element

**EMT\_V41\_FinancialInstrumentType/AdditionalInformationUK/ValueForMoney/OutcomeOfPRINValueAssessmentOrReview**

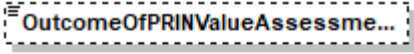
|            |   |
|------------|---|
| diagram    |  <p>09060: "1 – product expected to provide fair value for reasonably foreseeable period<br/>2 – review indicates significant changes required in order to provide fair value"</p> |
| type       | restriction of <b>xs:string</b>   |
| properties | isRef 0<br>minOcc 0<br>maxOcc 1<br>content simple   |
| annotation | documentation<br>09060: "1 – product expected to provide fair value for reasonably foreseeable period<br>2 – review indicates significant changes required in order to provide fair value"  |

element

**EMT\_V41\_FinancialInstrumentType/AdditionalInformationUK/ValueForMoney/OtherReviewRelatedToValueAndCharges**

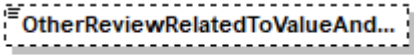
|            |  |
|------------|--|
| diagram    |  <p>09070: "A – In line with ESMA supervisory briefing on the supervision of costs in UCITS and AIFs or relevant NCA supervisory activity<br/>O – Other local requirements or procedures"</p> |
| type       | restriction of <b>xs:string</b>  |
| properties | isRef 0<br>minOcc 0<br>maxOcc 1<br>content simple  |
| annotation | documentation<br>09070: "A – In line with ESMA supervisory briefing on the supervision of costs in UCITS and AIFs or relevant NCA supervisory activity<br>O – Other local requirements or procedures"  |

element

**EMT\_V41\_FinancialInstrumentType/AdditionalInformationUK/ValueForMoney/FurtherInformation**

|            |   |
|------------|---|
| diagram    |  <p>09080: Link to sources of relevant information</p> |
| type       | <b>xs:anyURI</b>  |
| properties | isRef 0<br>minOcc 0<br>maxOcc 1<br>content simple   |
| annotation | documentation<br>09080: Link to sources of relevant information   |

element **EMT\_V41\_FinancialInstrumentType/AdditionalInformationUK/ValueForMoney/ReviewDate**

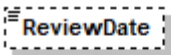
|            |  |
|------------|--|
| diagram    |  <p>09090: Date of value assessment review or date COLL assessment of value report published or initial launch date</p> |
| type       | <b>xs:date</b>   |
| properties | isRef 0<br>minOcc 0<br>maxOcc 1<br>content simple  |
| annotation | documentation<br>09090: Date of value assessment review or date COLL assessment of value report published or initial launch date   |

element **EMT\_V41\_FinancialInstrumentType/AdditionalInformationUK/ValueForMoney/ReviewNextDue**

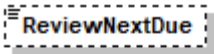
|            |   |
|------------|---|
| diagram    |  <p>09100: The Date that specifies the start of the Reference Period. Defined as "From and including". All ex-post cost disclosures apart from 08040 refers to all dates in such period.</p> |
| type       | <b>xs:date</b>  |
| properties | isRef 0<br>minOcc 0<br>maxOcc 1<br>content simple   |
| annotation | documentation<br>09100: The Date that specifies the start of the Reference Period. Defined as "From and including". All ex-post cost disclosures apart from 08040 refers to all dates in such period.   |

complexType **EMT\_V4\_FinancialInstrumentType**

|                 |   |
|-----------------|---|
| <p>diagram</p>  | <p><b>FundOrShareClassIdentifiers</b> </p> <p>Fund or share class identifiers for easy connection to other fund or share class data</p> <p><b>DataSupplier</b> </p> <p>Definition of data source (investment company, vendor, ...)</p> <p><b>DataSetInformation</b> </p> <p><b>GeneralInformation</b> </p> <p>General Financial Instrument Information</p> <p><b>TargetMarket</b> </p> <p><b>CostsAndChargesExAnte</b> </p> <p>Costs and Charges ex ante</p> <p><b>CostsAndChargesExPost</b> </p> <p>Costs and Charges ex post</p> <p><b>CountrySpecificData</b> </p> |
| <p>children</p> | <p><a href="#">FundOrShareClassIdentifiers</a> <a href="#">DataSupplier</a> <a href="#">DataSetInformation</a> <a href="#">GeneralInformation</a> <a href="#">TargetMarket</a> <a href="#">CostsAndChargesExAnte</a> <a href="#">CostsAndChargesExPost</a> <a href="#">CountrySpecificData</a></p>  |
| <p>used by</p>  | <p>element <a href="#">EMTType V4/FinancialInstrument</a></p>   |

element **EMT\_V4\_FinancialInstrumentType/FundOrShareClassIdentifiers**

|                   |  |
|-------------------|--|
| <p>diagram</p>    | <p><b>FundOrShareClassIdentifiers</b> </p> <p>Fund or share class identifiers for easy connection to other fund or share class data</p> <p><b>FundOrShareClassIdentifiers Type</b></p> <p><b>LEI</b> </p> <p>Legal Entity Identifier of fund</p> <p><b>ISINs</b> </p> <p>List of ISINs for share classes</p> |
| <p>type</p>       | <p><a href="#">FundOrShareClassIdentifiersType</a></p>   |
| <p>properties</p> | <p>isRef 0<br/>minOcc 0<br/>maxOcc 1<br/>content complex</p>   |
| <p>children</p>   | <p><a href="#">LEI</a> <a href="#">ISINs</a></p>   |
| <p>annotation</p> | <p>documentation<br/>Fund or share class identifiers for easy connection to other fund or share class data</p>   |

element **EMT\_V4\_FinancialInstrumentType/DataSupplier**

|                   |  |
|-------------------|--|
| <p>diagram</p>    | <p>The diagram illustrates the structure of the <b>DataSupplierType</b> element. It is a complex type (indicated by a dashed box) that contains several child elements:</p> <ul style="list-style-type: none"> <li><b>SystemCountry</b>: Country of authority defining the list of valid data suppliers (e.g. AT, DE, ...)</li> <li><b>Short</b>: Code of supplier (unique per country)</li> <li><b>Name</b>: Name of data supplier</li> <li><b>Type</b>: Type of data supplier (e.g. IC, CB, NB, Vendor, ...)</li> <li><b>Contact</b>: Contact details (name, phone, email)</li> </ul> <p>Additionally, there is a separate class <b>DataSupplier</b> (represented by a dashed box) which is defined as the "Definition of data source (investment company, vendor, ...)". A line connects this class to the <b>DataSupplierType</b> complex type, indicating that the complex type is derived from or associated with the <b>DataSupplier</b> class.</p> |
| <p>type</p>       | <p><a href="#">DataSupplierType</a></p>  |
| <p>properties</p> | <p>isRef 0<br/>minOcc 0<br/>maxOcc 1<br/>content complex</p>   |
| <p>children</p>   | <p><a href="#">SystemCountry</a> <a href="#">Short</a> <a href="#">Name</a> <a href="#">Type</a> <a href="#">Contact</a></p>   |
| <p>annotation</p> | <p>documentation<br/>Definition of data source (investment company, vendor, ...)</p>   |

element **EMT\_V4\_FinancialInstrumentType/DataSetInformation**

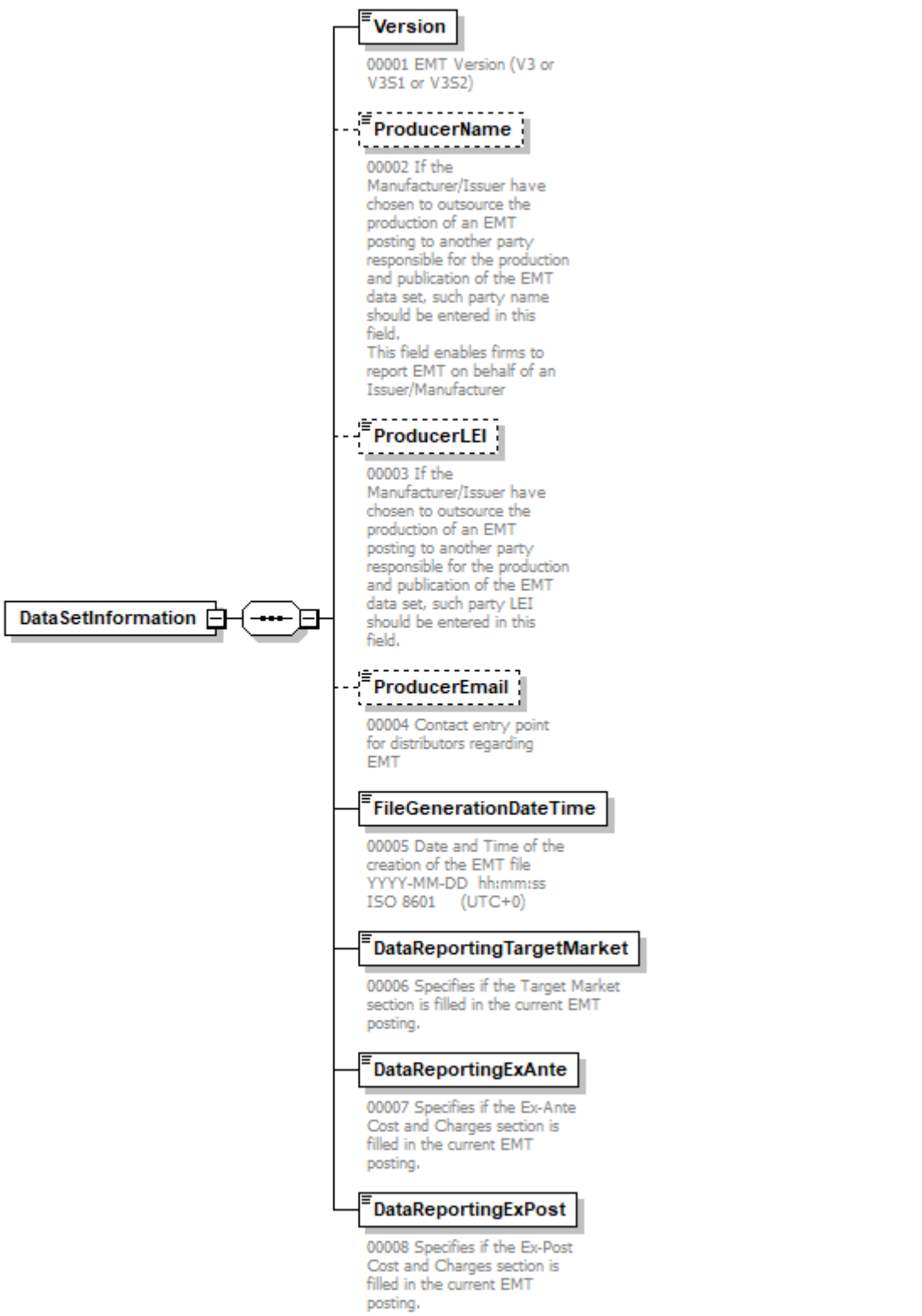
|  |   |
|--|---|
| <p>diagram</p>  | <p><b>Version</b><br/>00001 EMT Version (V3 or V3S1 or V3S2)</p> <p><b>ProducerName</b><br/>00002 If the Manufacturer/Issuer have chosen to outsource the production of an EMT posting to another party responsible for the production and publication of the EMT data set, such party name should be entered in this field.<br/>This field enables firms to report EMT on behalf of an Issuer/Manufacturer</p> <p><b>ProducerLEI</b><br/>00003 If the Manufacturer/Issuer have chosen to outsource the production of an EMT posting to another party responsible for the production and publication of the EMT data set, such party LEI should be entered in this field.</p> <p><b>ProducerEmail</b><br/>00004 Contact entry point for distributors regarding EMT</p> <p><b>FileGenerationDateTime</b><br/>00005 Date and Time of the creation of the EMT file<br/>YYYY-MM-DD hh:mm:ss<br/>ISO 8601 (UTC+0)</p> <p><b>DataReportingTargetMarket</b><br/>00006 Specifies if the Target Market section is filled in the current EMT posting.</p> <p><b>DataReportingExAnte</b><br/>00007 Specifies if the Ex-Ante Cost and Charges section is filled in the current EMT posting.</p> <p><b>DataReportingExPost</b><br/>00008 Specifies if the Ex-Post Cost and Charges section is filled in the current EMT posting.</p> |
| <p>properties</p>  | <p>isRef 0<br/>content complex</p>  |
| <p>children</p>  | <p><a href="#">Version</a> <a href="#">ProducerName</a> <a href="#">ProducerLEI</a> <a href="#">ProducerEmail</a> <a href="#">FileGenerationDateTime</a> <a href="#">DataReportingTargetMarket</a></p>  |

[DataReportingExAnte](#) [DataReportingExPost](#)

element **EMT\_V4\_FinancialInstrumentType/DataSetInformation/Version**

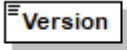
|            |   |
|------------|---|
| diagram    |  <p>00001 EMT Version (V3 or V3S1 or V3S2)</p> |
| type       | restriction of <b>xs:string</b>   |
| properties | isRef 0<br>content simple   |
| facets     | Kind Value annotation<br>minLength 2<br>maxLength 4   |
| annotation | documentation<br>00001 EMT Version (V3 or V3S1 or V3S2)   |

element **EMT\_V4\_FinancialInstrumentType/DataSetInformation/ProducerName**

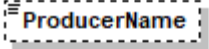
|            |  |
|------------|--|
| diagram    |  <p>00002 If the Manufacturer/Issuer have chosen to outsource the production of an EMT posting to another party responsible for the production and publication of the EMT data set, such party name should be entered in this field.<br/>This field enables firms to report EMT on behalf of an Issuer/Manufacturer</p> |
| type       | restriction of <b>xs:string</b>  |
| properties | isRef 0<br>minOcc 0<br>maxOcc 1<br>content simple  |
| facets     | Kind Value annotation<br>maxLength 255   |
| annotation | documentation<br>00002 If the Manufacturer/Issuer have chosen to outsource the production of an EMT posting to another party responsible for the production and publication of the EMT data set, such party name should be entered in this field.<br>This field enables firms to report EMT on behalf of an Issuer/Manufacturer  |

element **EMT\_V4\_FinancialInstrumentType/DataSetInformation/ProducerLEI**

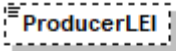
|            |  |
|------------|--|
| diagram    |  <p>00003 If the Manufacturer/Issuer have chosen to outsource the production of an EMT posting to another party responsible for the production and publication of the EMT data set, such party LEI should be entered in this field.</p> |
| type       | <a href="#">LEICodeType</a>  |
| properties | isRef 0<br>minOcc 0<br>maxOcc 1<br>content simple  |
| facets     | Kind Value annotation<br>minLength 20<br>maxLength 20<br>pattern ([0-9a-zA-Z]{18}[0-9]{2})   |
| annotation | documentation<br>00003 If the Manufacturer/Issuer have chosen to outsource the production of an EMT posting to another party responsible for the production and publication of the EMT data set, such party LEI should be entered in this field.   |

element **EMT\_V4\_FinancialInstrumentType/DataSetInformation/ProducerEmail**

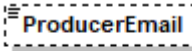
|            |   |
|------------|---|
| diagram    |  <p>00004 Contact entry point for distributors regarding EMT</p> |
| type       | <a href="#">EmailAddressType</a>  |
| properties | isRef 0<br>minOcc 0<br>maxOcc 1<br>content simple   |
| facets     | Kind Value annotation<br>pattern [_\a-zA-Z0-9\.\+]+\@[a-zA-Z0-9](\.[\a-zA-Z0-9]*[a-zA-Z0-9])*   |
| annotation | documentation<br>00004 Contact entry point for distributors regarding EMT   |

element **EMT\_V4\_FinancialInstrumentType/DataSetInformation/FileGenerationDateTime**

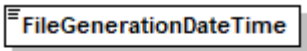
|            |   |
|------------|---|
| diagram    |  <p>00005 Date and Time of the creation of the EMT file<br/>         YYYY-MM-DD hh:mm:ss<br/>         ISO 8601 (UTC+0)</p> |
| type       | <b>xs:dateTime</b>  |
| properties | isRef 0<br>content simple   |
| annotation | documentation<br>00005 Date and Time of the creation of the EMT file<br>YYYY-MM-DD hh:mm:ss ISO 8601 (UTC+0)  |



element **EMT\_V4\_FinancialInstrumentType/DataSetInformation/DataReportingTargetMarket**

|            |  |
|------------|--|
| diagram    |  <b>DataReportingTargetMarket</b><br>00006 Specifies if the Target Market section is filled in the current EMT posting. |
| type       | <a href="#">EMTYesNoType</a>   |
| properties | isRef 0<br>content simple  |
| facets     | Kind Value annotation<br>length 1  |
| annotation | documentation<br>00006 Specifies if the Target Market section is filled in the current EMT posting.  |

element **EMT\_V4\_FinancialInstrumentType/DataSetInformation/DataReportingExAnte**

|            |   |
|------------|---|
| diagram    |  <b>DataReportingExAnte</b><br>00007 Specifies if the Ex-Ante Cost and Charges section is filled in the current EMT posting. |
| type       | <a href="#">EMTYesNoType</a>  |
| properties | isRef 0<br>content simple   |
| facets     | Kind Value annotation<br>length 1   |
| annotation | documentation<br>00007 Specifies if the Ex-Ante Cost and Charges section is filled in the current EMT posting.  |

element **EMT\_V4\_FinancialInstrumentType/DataSetInformation/DataReportingExPost**

|            |   |
|------------|---|
| diagram    |  <b>DataReportingExPost</b><br>00008 Specifies if the Ex-Post Cost and Charges section is filled in the current EMT posting. |
| type       | <a href="#">EMTYesNoType</a>  |
| properties | isRef 0<br>content simple   |
| facets     | Kind Value annotation<br>length 1   |
| annotation | documentation<br>00008 Specifies if the Ex-Post Cost and Charges section is filled in the current EMT posting.  |

# element EMT\_V4\_FinancialInstrumentType/GeneralInformation

diagram

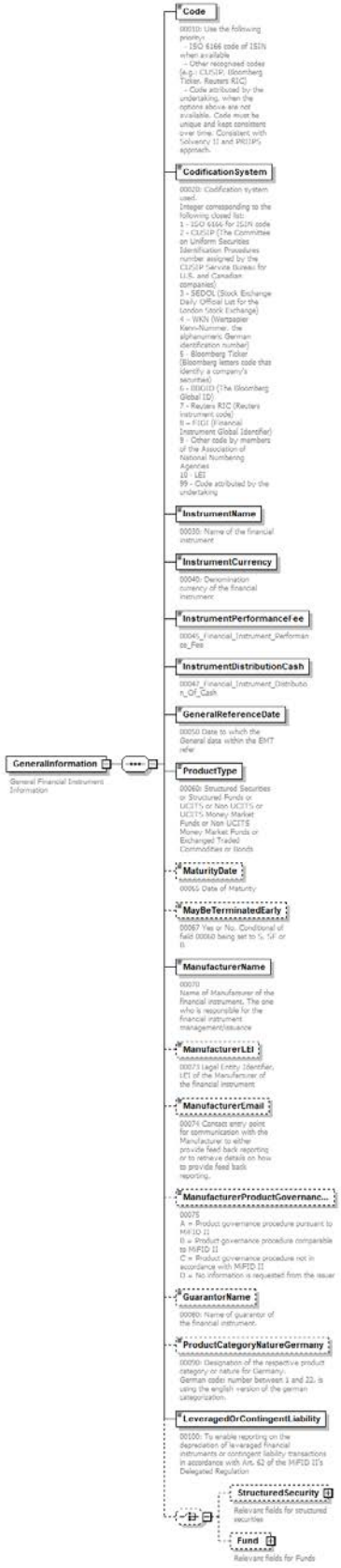

|            |   |
|------------|---|
| properties | isRef 0<br>content complex  |
| children   | <a href="#">Code</a> <a href="#">CodificationSystem</a> <a href="#">InstrumentName</a> <a href="#">InstrumentCurrency</a> <a href="#">InstrumentPerformanceFee</a> <a href="#">InstrumentDistributionCash</a> <a href="#">GeneralReferenceDate</a> <a href="#">ProductType</a> <a href="#">MaturityDate</a> <a href="#">MaybeTerminatedEarly</a> <a href="#">ManufacturerName</a> <a href="#">ManufacturerLEI</a> <a href="#">ManufacturerEmail</a> <a href="#">ManufacturerProductGovernanceProces</a> <a href="#">GuarantorName</a> <a href="#">ProductCategoryNatureGermany</a> <a href="#">LeveragedOrContingentLiability</a> <a href="#">StructuredSecurity</a> <a href="#">Fund</a> |
| annotation | documentation<br>General Financial Instrument Information   |

element **EMT\_V4\_FinancialInstrumentType/GeneralInformation/Code**

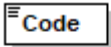
|            |  |
|------------|--|
| diagram    |  <p>00010: Use the following priority:</p> <ul style="list-style-type: none"> <li>- ISO 6166 code of ISIN when available</li> <li>- Other recognised codes (e.g.: CUSIP, Bloomberg Ticker, Reuters RIC)</li> <li>- Code attributed by the undertaking, when the options above are not available. Code must be unique and kept consistent over time. Consistent with Solvency II and PRIIPS approach.</li> </ul> |
| type       | restriction of <b>xs:string</b>  |
| properties | isRef 0<br>content simple  |
| facets     | Kind Value annotation<br>maxLength 255   |
| annotation | documentation<br>00010: Use the following priority:  |

- ISO 6166 code of ISIN when available
- Other recognised codes (e.g.: CUSIP, Bloomberg Ticker, Reuters RIC)
- Code attributed by the undertaking, when the options above are not available. Code must be unique and kept consistent over time. Consistent with Solvency II and PRIIPS approach.

element **EMT\_V4\_FinancialInstrumentType/GeneralInformation/CodificationSystem**

|              |   |            |       |            |              |   |  |              |    |  |
|--------------|---|------------|-------|------------|--------------|---|--|--------------|----|--|
| diagram      | <div data-bbox="297 241 548 289" style="border: 1px solid black; padding: 2px;"> <b>CodificationSystem</b> </div> <p>00020: Codification system used.<br/> Integer corresponding to the following closed list:<br/> 1 - ISO 6166 for ISIN code<br/> 2 - CUSIP (The Committee on Uniform Securities Identification Procedures number assigned by the CUSIP Service Bureau for U.S. and Canadian companies)<br/> 3 - SEDOL (Stock Exchange Daily Official List for the London Stock Exchange)<br/> 4 - WKN (Wertpapier Kenn-Nummer, the alphanumeric German identification number)<br/> 5 - Bloomberg Ticker (Bloomberg letters code that identify a company's securities)<br/> 6 - BBGID (The Bloomberg Global ID)<br/> 7 - Reuters RIC (Reuters instrument code)<br/> 8 - FIGI (Financial Instrument Global Identifier)<br/> 9 - Other code by members of the Association of National Numbering Agencies<br/> 10 - LEI<br/> 99 - Code attributed by the undertaking</p> |            |       |            |              |   |  |              |    |  |
| type         | restriction of <b>xs:short</b>  |            |       |            |              |   |  |              |    |  |
| properties   | isRef 0<br>content simple   |            |       |            |              |   |  |              |    |  |
| facets       | <table border="0"> <tr> <td>Kind</td> <td>Value</td> <td>annotation</td> </tr> <tr> <td>minInclusive</td> <td>1</td> <td></td> </tr> <tr> <td>maxInclusive</td> <td>99</td> <td></td> </tr> </table>  | Kind       | Value | annotation | minInclusive | 1 |  | maxInclusive | 99 |  |
| Kind         | Value   | annotation |       |            |              |   |  |              |    |  |
| minInclusive | 1   |            |       |            |              |   |  |              |    |  |
| maxInclusive | 99  |            |       |            |              |   |  |              |    |  |
| annotation   | documentation<br>00020: Codification system used.<br>Integer corresponding to the following closed list:<br>1 - ISO 6166 for ISIN code<br>2 - CUSIP (The Committee on Uniform Securities Identification Procedures number assigned by the CUSIP Service Bureau for U.S. and Canadian companies)<br>3 - SEDOL (Stock Exchange Daily Official List for the London Stock Exchange)<br>4 - WKN (Wertpapier Kenn-Nummer, the alphanumeric German identification number)<br>5 - Bloomberg Ticker (Bloomberg letters code that identify a company's securities)<br>6 - BBGID (The Bloomberg Global ID)<br>7 - Reuters RIC (Reuters instrument code)<br>8 - FIGI (Financial Instrument Global Identifier)<br>9 - Other code by members of the Association of National Numbering Agencies<br>10 - LEI<br>99 - Code attributed by the undertaking   |            |       |            |              |   |  |              |    |  |

element **EMT\_V4\_FinancialInstrumentType/GeneralInformation/InstrumentName**

|            |  |
|------------|--|
| diagram    |  <p>00030: Name of the financial instrument</p> |
| type       | restriction of <b>xs:string</b>  |
| properties | isRef 0<br>content simple  |
| facets     | Kind Value annotation<br>maxLength 255   |
| annotation | documentation<br>00030: Name of the financial instrument   |

element **EMT\_V4\_FinancialInstrumentType/GeneralInformation/InstrumentCurrency**

|            |   |
|------------|---|
| diagram    |  <p>00040: Denomination currency of the financial instrument</p> |
| type       | <a href="#">ISOCurrencyCodeType</a>   |
| properties | isRef 0<br>content simple   |
| facets     | Kind Value annotation<br>minLength 3<br>maxLength 3<br>pattern [A-Z]{3}   |
| annotation | documentation<br>00040: Denomination currency of the financial instrument   |

element **EMT\_V4\_FinancialInstrumentType/GeneralInformation/InstrumentPerformanceFee**

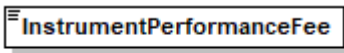
|            |   |
|------------|---|
| diagram    |  <p>00045_Financial_Instrument_Performance_Fee</p> |
| type       | <a href="#">EMTYesNoType</a>  |
| properties | isRef 0<br>content simple   |
| facets     | Kind Value annotation<br>length 1   |
| annotation | documentation<br>00045_Financial_Instrument_Performance_Fee   |

element **EMT\_V4\_FinancialInstrumentType/GeneralInformation/InstrumentDistributionCash**

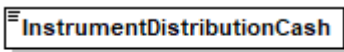
|            |  |
|------------|--|
| diagram    |  <p>00047_Financial_Instrument_Distribution_Of_Cash</p> |
| type       | <a href="#">EMTYesNoType</a>   |
| properties | isRef 0<br>content simple  |

|            |  |
|------------|--|
| facets     | Kind Value annotation<br>length 1                                |
| annotation | documentation<br>00047_Financial_Instrument_Distribution_Of_Cash |

element **EMT\_V4\_FinancialInstrumentType/GeneralInformation/GeneralReferenceDate**

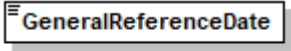
|            |  |
|------------|--|
| diagram    |  <p>00050 Date to which the General data within the EMT refer</p> |
| type       | <b>xs:date</b>   |
| properties | isRef 0<br>content simple  |
| annotation | documentation<br>00050 Date to which the General data within the EMT refer   |

element **EMT\_V4\_FinancialInstrumentType/GeneralInformation/ProductType**

|            |  |
|------------|--|
| diagram    |  <p>00060: Structured Securities or Structured Funds or UCITS or Non UCITS or UCITS Money Market Funds or Non UCITS Money Market Funds or Exchanged Traded Commodities or Bonds</p> |
| type       | restriction of <b>xs:string</b>  |
| properties | isRef 0<br>content simple  |
| facets     | Kind Value annotation<br>minLength 1<br>maxLength 3  |
| annotation | documentation<br>00060: Structured Securities or Structured Funds or UCITS or Non UCITS or UCITS Money Market Funds or Non UCITS Money Market Funds or Exchanged Traded Commodities or Bonds   |

element **EMT\_V4\_FinancialInstrumentType/GeneralInformation/MaturityDate**

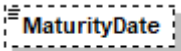
|            |   |
|------------|---|
| diagram    |  <p>00065 Date of Maturity</p> |
| type       | <b>xs:date</b>  |
| properties | isRef 0<br>minOcc 0<br>maxOcc 1<br>content simple   |
| annotation | documentation<br>00065 Date of Maturity   |

element **EMT\_V4\_FinancialInstrumentType/GeneralInformation/MayBeTerminatedEarly**

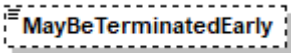
|            |  |
|------------|--|
| diagram    |  <p>00067 Yes or No. Conditional of field 00060 being set to S, SF or B</p> |
| type       | <a href="#">EMTYesNoType</a>   |
| properties | <p>isRef 0</p> <p>minOcc 0</p> <p>maxOcc 1</p> <p>content simple</p>   |
| facets     | <p>Kind Value annotation</p> <p>length 1</p>   |
| annotation | <p>documentation</p> <p>00067 Yes or No. Conditional of field 00060 being set to S, SF or B</p>  |

element **EMT\_V4\_FinancialInstrumentType/GeneralInformation/ManufacturerName**

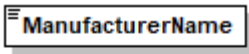
|            |  |
|------------|--|
| diagram    |  <p>00070<br/>Name of Manufacturer of the financial instrument. The one who is responsible for the financial instrument management/issuance</p> |
| type       | restriction of <b>xs:string</b>  |
| properties | <p>isRef 0</p> <p>content simple</p>   |
| facets     | <p>Kind Value annotation</p> <p>maxLength 255</p>  |
| annotation | <p>documentation</p> <p>00070<br/>Name of Manufacturer of the financial instrument. The one who is responsible for the financial instrument management/issuance</p>  |

element **EMT\_V4\_FinancialInstrumentType/GeneralInformation/ManufacturerLEI**

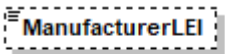
|            |   |
|------------|---|
| diagram    |  <p>00073 Legal Entity Identifier, LEI of the Manufacturer of the financial instrument</p> |
| type       | <a href="#">LEICodeType</a>   |
| properties | <p>isRef 0</p> <p>minOcc 0</p> <p>maxOcc 1</p> <p>content simple</p>  |
| facets     | <p>Kind Value annotation</p> <p>minLength 20</p> <p>maxLength 20</p> <p>pattern ([0-9a-zA-Z]{18}[0-9]{2})</p>   |
| annotation | <p>documentation</p> <p>00073 Legal Entity Identifier, LEI of the Manufacturer of the financial instrument</p>  |

element **EMT\_V4\_FinancialInstrumentType/GeneralInformation/ManufacturerEmail**

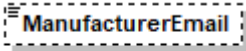
|            |  |
|------------|--|
| diagram    |  <p>00074 Contact entry point for communication with the Manufacturer to either provide feed back reporting or to retrieve details on how to provide feed back reporting.</p> |
| type       | <a href="#">EmailAddressType</a>   |
| properties | isRef 0<br>minOcc 0<br>maxOcc 1<br>content simple  |
| facets     | Kind Value annotation<br>pattern <code>[_\a-zA-Z0-9\.\+]+\@[a-zA-Z0-9](\.[\a-zA-Z0-9]*[a-zA-Z0-9])*</code>   |
| annotation | documentation<br>00074 Contact entry point for communication with the Manufacturer to either provide feed back reporting or to retrieve details on how to provide feed back reporting.   |

element **EMT\_V4\_FinancialInstrumentType/GeneralInformation/ManufacturerProductGovernanceProces**

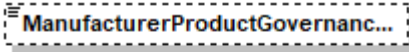
|            |   |
|------------|---|
| diagram    |  <p>00075<br/>         A = Product governance procedure pursuant to MiFID II<br/>         B = Product governance procedure comparable to MiFID II<br/>         C = Product governance procedure not in accordance with MiFID II<br/>         D = No information is requested from the issuer</p> |
| type       | restriction of <b>xs:string</b>   |
| properties | isRef 0<br>minOcc 0<br>maxOcc 1<br>content simple   |
| facets     | Kind Value annotation<br>minLength 1<br>maxLength 1   |
| annotation | documentation<br>00075<br>A = Product governance procedure pursuant to MiFID II<br>B = Product governance procedure comparable to MiFID II<br>C = Product governance procedure not in accordance with MiFID II<br>D = No information is requested from the issuer   |

element **EMT\_V4\_FinancialInstrumentType/GeneralInformation/GuarantorName**

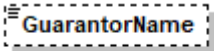
|            |  |
|------------|--|
| diagram    |  <p>00080: Name of guarantor of the financial instrument.</p> |
| type       | restriction of <b>xs:string</b>  |
| properties | isRef 0<br>minOcc 0<br>maxOcc 1<br>content simple  |



|            |  |
|------------|--|
| facets     | Kind Value annotation<br>maxLength 255                                 |
| annotation | documentation<br>00080: Name of guarantor of the financial instrument. |

element **EMT\_V4\_FinancialInstrumentType/GeneralInformation/ProductCategoryNatureGermany**

|            |  |
|------------|--|
| diagram    |  <p>00090: Designation of the respective product category or nature for Germany.<br/>German code: number between 1 and 22, is using the english version of the german categorization.</p> |
| type       | restriction of <b>xs:positiveInteger</b>   |
| properties | isRef 0<br>minOcc 0<br>maxOcc 1<br>content simple  |
| facets     | Kind Value annotation<br>minInclusive 1<br>maxInclusive 22   |
| annotation | documentation<br>00090: Designation of the respective product category or nature for Germany.<br>German code: number between 1 and 22, is using the english version of the german categorization.  |

element **EMT\_V4\_FinancialInstrumentType/GeneralInformation/LeveragedOrContingentLiability**

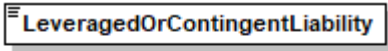
|            |   |
|------------|---|
| diagram    |  <p>00100: To enable reporting on the depreciation of leveraged financial instruments or contingent liability transactions in accordance with Art. 62 of the MiFID II's Delegated Regulation</p> |
| type       | <a href="#">EMTYesNoType</a>  |
| properties | isRef 0<br>content simple   |
| facets     | Kind Value annotation<br>length 1   |
| annotation | documentation<br>00100: To enable reporting on the depreciation of leveraged financial instruments or contingent liability transactions in accordance with Art. 62 of the MiFID II's Delegated Regulation   |

element **EMT\_V4\_FinancialInstrumentType/GeneralInformation/StructuredSecurity**

|            |  |
|------------|--|
| diagram    | <p>The diagram shows a central box labeled <b>StructuredSecurity</b> with the text "Relevant fields for structured securities" below it. To its right, three dashed boxes represent child elements: <b>TypeNotionalOrItemBased</b>, <b>ProductCategoryNature</b>, and <b>Quotation</b>. Dashed lines connect the central box to each of these child boxes.</p> <p><b>TypeNotionalOrItemBased</b><br/>00085: Enables interpretation of Cost and Charges data when used together with fields 00096, 08110 and 08120.<br/>N for Notional based instrument, I for Item based instrument</p> <p><b>ProductCategoryNature</b><br/>00095: If the financial instrument is a structured security complete with the EUSIPA code</p> <p><b>Quotation</b><br/>00096: If 00060 is set to S or ETC.<br/>U for Units, or P for Percentage.<br/>Defines if the quotation type in the Ex-Ante and Ex-Post section of the EMT file is in UNITS or in PERCENTAGE related to the specific Reference as presented in field 07150,07155, 08110 and 08120 respectively.</p> |
| properties | <p>isRef 0<br/>minOcc 0<br/>maxOcc 1<br/>content complex</p>   |
| children   | <p><a href="#">TypeNotionalOrItemBased</a> <a href="#">ProductCategoryNature</a> <a href="#">Quotation</a></p>   |
| annotation | <p>documentation<br/>Relevant fields for structured securities</p>   |

element **EMT\_V4\_FinancialInstrumentType/GeneralInformation/StructuredSecurity/TypeNotionalOrItemBased**

|            |  |
|------------|--|
| diagram    | <p>The diagram shows a dashed box labeled <b>TypeNotionalOrItemBased</b> with the text "restriction of xs:string" below it.</p> <p><b>TypeNotionalOrItemBased</b><br/>00085: Enables interpretation of Cost and Charges data when used together with fields 00096, 08110 and 08120.<br/>N for Notional based instrument, I for Item based instrument</p> |
| type       | <p>restriction of <b>xs:string</b></p>   |
| properties | <p>isRef 0<br/>minOcc 0<br/>maxOcc 1<br/>content simple</p>  |
| facets     | <p>Kind Value annotation<br/>minLength 1<br/>maxLength 1</p>   |
| annotation | <p>documentation<br/>00085: Enables interpretation of Cost and Charges data when used together with fields 00096, 08110 and 08120.<br/>N for Notional based instrument, I for Item based instrument</p>  |

element

**EMT\_V4\_FinancialInstrumentType/GeneralInformation/StructuredSecurity/ProductCategoryNature**

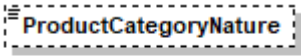
|            |  |
|------------|--|
| diagram    |  <p>00095: If the financial instrument is a structured security complete with the EUSIPA code</p> |
| type       | restriction of <a href="#">Text4Type</a>   |
| properties | isRef 0<br>minOcc 0<br>maxOcc 1<br>content simple  |
| facets     | Kind Value annotation<br>maxLength 4   |
| annotation | documentation<br>00095: If the financial instrument is a structured security complete with the EUSIPA code   |

element **EMT\_V4\_FinancialInstrumentType/GeneralInformation/StructuredSecurity/Quotation**

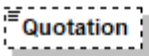
|            |   |
|------------|---|
| diagram    |  <p>00096: If 00060 is set to S or ETC.<br/>U for Units, or P for Percentage.<br/>Defines if the quotation type in the Ex-Ante and Ex-Post section of the EMT file is in UNITS or in PERCENTAGE related to the specific Reference as presented in field 07150,07155, 08110 and 08120 respectively.</p> |
| type       | restriction of <b>xs:string</b>   |
| properties | isRef 0<br>minOcc 0<br>maxOcc 1<br>content simple   |
| facets     | Kind Value annotation<br>minLength 1<br>maxLength 1   |
| annotation | documentation<br>00096: If 00060 is set to S or ETC.<br>U for Units, or P for Percentage.<br>Defines if the quotation type in the Ex-Ante and Ex-Post section of the EMT file is in UNITS or in PERCENTAGE related to the specific Reference as presented in field 07150,07155, 08110 and 08120 respectively.   |

element **EMT\_V4\_FinancialInstrumentType/GeneralInformation/Fund**

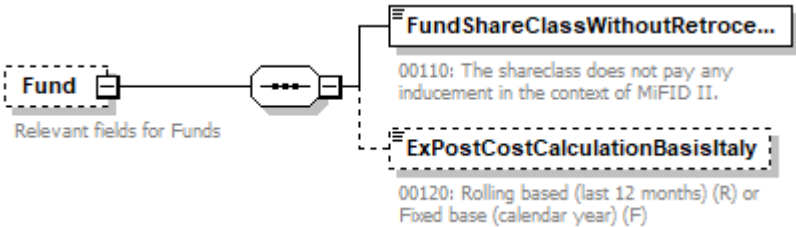
|         |   |
|---------|---|
| diagram |  <p>Relevant fields for Funds</p> <p><b>FundShareClassWithoutRetroce...</b><br/>00110: The shareclass does not pay any inducement in the context of MiFID II.</p> <p><b>ExPostCostCalculationBasisItaly</b><br/>00120: Rolling based (last 12 months) (R) or Fixed base (calendar year) (F)</p> |
|---------|---|

|            |   |
|------------|---|
| properties | isRef 0<br>minOcc 0<br>maxOcc 1<br>content complex                                |
| children   | <a href="#">FundShareClassWithoutRetrocession ExPostCostCalculationBasisItaly</a> |
| annotation | documentation<br>Relevant fields for Funds  |

element

**EMT\_V4 FinancialInstrumentType/GeneralInformation/Fund/FundShareClassWithoutRetrocession**

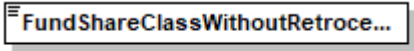
|            |  |
|------------|--|
| diagram    |  <p>00110: The shareclass does not pay any inducement in the context of MiFID II.</p> |
| type       | <a href="#">EMTYesNoType</a>   |
| properties | isRef 0<br>content simple  |
| facets     | Kind Value annotation<br>length 1  |
| annotation | documentation<br>00110: The shareclass does not pay any inducement in the context of MiFID II.   |

element **EMT\_V4 FinancialInstrumentType/GeneralInformation/Fund/ExPostCostCalculationBasisItaly**

|            |   |
|------------|---|
| diagram    |  <p>00120: Rolling based (last 12 months) (R) or Fixed base (calendar year) (F)</p> |
| type       | restriction of <a href="#">Text1Type</a>  |
| properties | isRef 0<br>minOcc 0<br>maxOcc 1<br>content simple   |
| facets     | Kind Value annotation<br>maxLength 1  |
| annotation | documentation<br>00120: Rolling based (last 12 months) (R) or Fixed base (calendar year) (F)  |

element **EMT\_V4\_FinancialInstrumentType/TargetMarket**

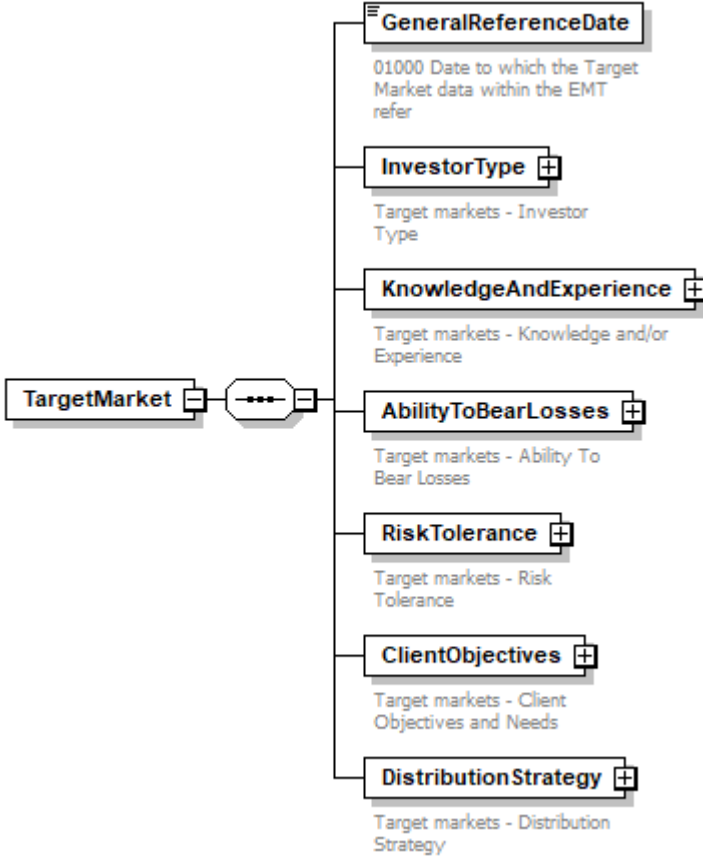
|                   |   |
|-------------------|---|
| <p>diagram</p>    |   |
| <p>properties</p> | <p>isRef 0<br/>content complex</p>  |
| <p>children</p>   | <p><a href="#">GeneralReferenceDate</a> <a href="#">InvestorType</a> <a href="#">KnowledgeAndExperience</a> <a href="#">AbilityToBearLosses</a> <a href="#">RiskTolerance</a> <a href="#">ClientObjectives</a> <a href="#">DistributionStrategy</a></p> |

element **EMT\_V4\_FinancialInstrumentType/TargetMarket/GeneralReferenceDate**

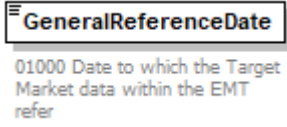
|                   |  |
|-------------------|--|
| <p>diagram</p>    |       |
| <p>type</p>       | <p><b>xs:date</b></p>  |
| <p>properties</p> | <p>isRef 0<br/>content simple</p>  |
| <p>annotation</p> | <p>documentation<br/>01000 Date to which the Target Market data within the EMT refer</p> |

element **EMT\_V4\_FinancialInstrumentType/TargetMarket/InvestorType**

|            |   |
|------------|---|
| diagram    | <p><b>InvestorType</b><br/>Target markets - Investor Type</p> <p><b>Retail</b><br/>01010: Neutral means usage by Retail clients are available under certain conditions.</p> <p><b>Professional</b><br/>01020: Y means both Professional Per Se and Elective Professionals are compatible.<br/>N means that neither Professional Per Se nor Elective Professionals are compatible.<br/>P means that Professional Per Se is compatible but Elective Professionals are not.<br/>E means that Elective Professional is compatible but Professionals Per Se are not.<br/>P is only used if the distinction Per Se is done in the Prospectus.</p> <p><b>EligibleCounterparty</b><br/>01030: Investor Type Eligible Counterparty</p> |
| properties | isRef 0<br>content complex  |
| children   | <a href="#">Retail</a> <a href="#">Professional</a> <a href="#">EligibleCounterparty</a>  |
| annotation | documentation<br>Target markets - Investor Type   |

element **EMT\_V4\_FinancialInstrumentType/TargetMarket/InvestorType/Retail**

|            |   |
|------------|---|
| diagram    | <p><b>Retail</b><br/>01010: Neutral means usage by Retail clients are available under certain conditions.</p> |
| type       | <a href="#">EMTYesNoNeutralType</a>   |
| properties | isRef 0<br>content simple   |
| facets     | Kind Value annotation<br>minLength 1<br>maxLength 7   |
| annotation | documentation<br>01010: Neutral means usage by Retail clients are available under certain conditions.         |

element **EMT\_V4\_FinancialInstrumentType/TargetMarket/InvestorType/Professional**

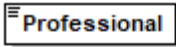
|            |   |
|------------|---|
| diagram    |  <p>01020: Y means both Professional Per Se and Elective Professionals are compatible.<br/> N means that neither Professional Per Se nor Elective Professionals are compatible.<br/> P means that Professional Per Se is compatible but Elective Professionals are not.<br/> E means that Elective Professional is compatible but Professionals Per Se are not.<br/> P is only used if the distinction Per Se is done in the Prospectus.</p> |
| type       | restriction of <b>xs:string</b>   |
| properties | isRef 0<br>content simple   |
| annotation | documentation<br>01020: Y means both Professional Per Se and Elective Professionals are compatible.<br>N means that neither Professional Per Se nor Elective Professionals are compatible.<br>P means that Professional Per Se is compatible but Elective Professionals are not.<br>E means that Elective Professional is compatible but Professionals Per Se are not.<br>P is only used if the distinction Per Se is done in the Prospectus.   |

element **EMT\_V4\_FinancialInstrumentType/TargetMarket/InvestorType/EligibleCounterparty**

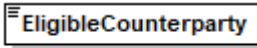
|            |   |
|------------|---|
| diagram    |  <p>01030: Investor Type Eligible Counterparty</p> |
| type       | <a href="#">EMTYesNoType</a>  |
| properties | isRef 0<br>content simple   |
| facets     | Kind Value annotation<br>length 1   |
| annotation | documentation<br>01030: Investor Type Eligible Counterparty   |

element **EMT\_V4\_FinancialInstrumentType/TargetMarket/KnowledgeAndExperience**

|                   |  |
|-------------------|--|
| <p>diagram</p>    | <p><b>KnowledgeAndExperience</b><br/>Target markets - Knowledge and/or Experience</p> <p><b>BasicInvestor</b><br/>02010: Investors having the following characteristics:<br/> <ul style="list-style-type: none"> <li>• basic knowledge of relevant financial instruments (a basic investor can make an informed investment decision based on the regulated and authorised offering documentation or with the help of basic information provided by point of sale);</li> <li>• no financial industry experience, i.e. suited to a first time investor</li> </ul> </p> <p><b>InformedInvestor</b><br/>02020: Having one, or more, of the following characteristics:<br/> <ul style="list-style-type: none"> <li>• average knowledge of relevant financial products (an informed investor can make an informed investment decision based on the regulated and authorised offering documentation, together with knowledge and understanding of the specific factors/risks highlighted within them only)</li> <li>• some financial industry experience</li> </ul> </p> <p><b>AdvancedInvestor</b><br/>02030: Investors having one, or more, of the following characteristics:<br/> <ul style="list-style-type: none"> <li>• good knowledge of relevant financial products and transactions</li> <li>• financial industry experience or accompanied by professional investment advice or included in a discretionary portfolio service</li> </ul> </p> <p><b>ExpertInvestorGermany</b><br/>02040: Expert knowledge of and / or experience with highly specialised financial products (Regulatory requirement in Germany/ example: CFD/ the updated list will be provided by the DSGVO)</p> |
| <p>properties</p> | <p>isRef 0<br/>content complex</p>   |
| <p>children</p>   | <p><a href="#">BasicInvestor</a> <a href="#">InformedInvestor</a> <a href="#">AdvancedInvestor</a> <a href="#">ExpertInvestorGermany</a></p>   |
| <p>annotation</p> | <p>documentation<br/>Target markets - Knowledge and/or Experience</p>  |

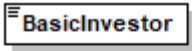

element **EMT\_V4\_FinancialInstrumentType/TargetMarket/KnowledgeAndExperience/BasicInvestor**

|            |   |
|------------|---|
| diagram    |  <p>02010: Investors having the following characteristics:</p> <ul style="list-style-type: none"> <li>• basic knowledge of relevant financial instruments (a basic investor can make an informed investment decision based on the regulated and authorised offering documentation or with the help of basic information provided by point of sale);</li> <li>• no financial industry experience, i.e. suited to a first time investor</li> </ul> |
| type       | <a href="#">EMTYesNoNeutralType</a>   |
| properties | isRef 0<br>content simple   |
| facets     | Kind Value annotation<br>minLength 1<br>maxLength 7   |
| annotation | documentation<br>02010: Investors having the following characteristics:<br><ul style="list-style-type: none"> <li>• basic knowledge of relevant financial instruments (a basic investor can make an informed investment decision based on the regulated and authorised offering documentation or with the help of basic information provided by point of sale);</li> <li>• no financial industry experience, i.e. suited to a first time investor</li> </ul>  |

element **EMT\_V4\_FinancialInstrumentType/TargetMarket/KnowledgeAndExperience/InformedInvestor**

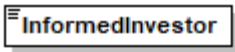
|            |  |
|------------|--|
| diagram    |  <p>02020: Having one, or more, of the following characteristics:</p> <ul style="list-style-type: none"> <li>• average knowledge of relevant financial products (an informed investor can make an informed investment decision based on the regulated and authorised offering documentation, together with knowledge and understanding of the specific factors/risks highlighted within them only)</li> <li>• some financial industry experience</li> </ul> |
| type       | <a href="#">EMTYesNoNeutralType</a>  |
| properties | isRef 0<br>content simple  |
| facets     | Kind Value annotation<br>minLength 1<br>maxLength 7  |
| annotation | documentation<br>02020: Having one, or more, of the following characteristics:<br><ul style="list-style-type: none"> <li>• average knowledge of relevant financial products (an informed investor can make an informed investment decision based on the regulated and authorised offering documentation, together with knowledge and understanding of the specific factors/risks highlighted within them only)</li> <li>• some financial industry experience</li> </ul>  |

element **EMT\_V4\_FinancialInstrumentType/TargetMarket/KnowledgeAndExperience/AdvancedInvestor**

|            |  |
|------------|--|
| diagram    |  <p>02030: Investors having one, or more, of the following characteristics:</p> <ul style="list-style-type: none"> <li>• good knowledge of relevant financial products and transactions</li> <li>• financial industry experience or accompanied by professional investment advice or included in a discretionary portfolio service</li> </ul> |
| type       | <a href="#">EMTYesNoNeutralType</a>  |
| properties | isRef 0<br>content simple  |
| facets     | Kind Value annotation<br>minLength 1<br>maxLength 7  |
| annotation | documentation<br>02030: Investors having one, or more, of the following characteristics:   |

element **EMT\_V4\_FinancialInstrumentType/TargetMarket/KnowledgeAndExperience/ExpertInvestorGermany**

|            |  |
|------------|--|
| diagram    |  <p>02040: Expert knowledge of and / or experience with highly specialised financial products (Regulatory requirement in Germany/ example: CFD/ the updated list will be provided by the DSGVO)</p> |
| type       | <a href="#">EMTYesNoNeutralType</a>  |
| properties | isRef 0<br>minOcc 0<br>maxOcc 1<br>content simple  |
| facets     | Kind Value annotation<br>minLength 1<br>maxLength 7  |
| annotation | documentation<br>02040: Expert knowledge of and / or experience with highly specialised financial products (Regulatory requirement in Germany/ example: CFD/ the updated list will be provided by the DSGVO)   |

element **EMT\_V4\_FinancialInstrumentType/TargetMarket/AbilityToBearLosses**

|                   |  |
|-------------------|--|
| <p>diagram</p>    | <p><b>AbilityToBearLosses</b><br/>Target markets - Ability To Bear Losses</p> <p><b>CompatibleWithClientsWhoCan...</b><br/>03010: Investor can bear no loss of capital. Minor losses especially due to costs possible. Yes or No or Neutral. N for negative target: product should not be sold to investors that cannot bear losses</p> <p><b>CompatibleWithClientsWhoCan...</b><br/>03020: Investor seeking to preserve capital or can bear losses limited to a level specified by the product. Assessment of loss level is based on investments in the same currency as the instrument denomination and do not take into consideration potential adverse FX market performance. To be filled only for structured securities and funds with an explicit capital protection or for Money Market funds. Yes or No or Neutral</p> <p><b>LimitedCapitalLossLevel</b><br/>03030: To be completed for products that have a clearly stated full or partial capital guarantee, provided on the primary market. This field represents the maximum loss a client could incur when investing in this product – it is not the level of capital protection offered</p> <p><b>CompatibleWithClientsWhoDoN...</b><br/>03040: No Capital Guarantee nor protection. 100% capital at risk. Yes or No or Neutral</p> <p><b>CompatibleWithClientsWhoCan...</b><br/>03050: Loss Beyond the Capital. Yes or No or Neutral</p> |
| <p>properties</p> | <p>isRef 0<br/>content complex</p>   |
| <p>children</p>   | <p><a href="#">CompatibleWithClientsWhoCanNotBearCapitalLoss</a> <a href="#">CompatibleWithClientsWhoCanBearLimitedCapitalLoss</a> <a href="#">LimitedCapitalLossLevel</a> <a href="#">CompatibleWithClientsWhoDoNotNeedCapitalGuarantee</a> <a href="#">CompatibleWithClientsWhoCanBearLossBeyondCapital</a></p>  |
| <p>annotation</p> | <p>documentation<br/>Target markets - Ability To Bear Losses</p>   |

element **EMT\_V4\_FinancialInstrumentType/TargetMarket/AbilityToBearLosses/CompatibleWithClientsWhoCanNotBearCapitalLoss**

|                |   |
|----------------|---|
| <p>diagram</p> | <p><b>CompatibleWithClientsWhoCan...</b><br/>03010: Investor can bear no loss of capital. Minor losses especially due to costs possible. Yes or No or Neutral. N for negative target: product should not be sold to investors that cannot bear losses</p> |
| <p>type</p>    | <p><a href="#">EMTYesNoNeutralType</a></p>  |

|            |  |
|------------|--|
| properties | isRef 0<br>content simple  |
| facets     | Kind Value annotation<br>minLength 1<br>maxLength 7  |
| annotation | documentation<br>03010: Investor can bear no loss of capital. Minor losses especially due to costs possible. Yes or No or Neutral.<br>N for negative target: product should not be sold to investors that cannot bear losses |

element

**EMT\_V4\_FinancialInstrumentType/TargetMarket/AbilityToBearLosses/CompatibleWithClientsWhoCanBearLimitedCapitalLoss**

|            |   |
|------------|---|
| diagram    | <p>03020: Investor seeking to preserve capital or can bear losses limited to a level specified by the product. Assessment of loss level is based on investments in the same currency as the instrument denomination and do not take into consideration potential adverse FX market performance.<br/>To be filled only for structured securities and funds with an explicit capital protection or for Money Market funds.<br/>Yes or No or Neutral</p>         |
| type       | <a href="#">EMTYesNoNeutralType</a>   |
| properties | isRef 0<br>minOcc 0<br>maxOcc 1<br>content simple   |
| facets     | Kind Value annotation<br>minLength 1<br>maxLength 7   |
| annotation | documentation<br>03020: Investor seeking to preserve capital or can bear losses limited to a level specified by the product. Assessment of loss level is based on investments in the same currency as the instrument denomination and do not take into consideration potential adverse FX market performance.<br>To be filled only for structured securities and funds with an explicit capital protection or for Money Market funds.<br>Yes or No or Neutral |

element **EMT\_V4\_FinancialInstrumentType/TargetMarket/AbilityToBearLosses/LimitedCapitalLossLevel**

|            |   |
|------------|---|
| diagram    | <p>03030: To be completed for products that have a clearly stated full or partial capital guarantee, provided on the primary market.<br/>This field represents the maximum loss a client could incur when investing in this product – it is not the level of capital protection offered</p> |
| type       | <a href="#">PercentageType</a>  |
| properties | isRef 0<br>minOcc 0<br>maxOcc 1<br>content simple   |
| annotation | documentation<br>03030: To be completed for products that have a clearly stated full or partial capital guarantee, provided on the primary  |

|  |  |
|--|--|
|  | market. This field represents the maximum loss a client could incur when investing in this product – it is not the level of capital protection offered |
|--|--|

element

**EMT\_V4\_FinancialInstrumentType/TargetMarket/AbilityToBearLosses/CompatibleWithClientsWhoDoNotNeedCapitalGuarantee**

|            |   |
|------------|---|
| diagram    |   |
| type       | <a href="#">EMTYesNoNeutralType</a>   |
| properties | isRef 0<br>content simple   |
| facets     | Kind Value annotation<br>minLength 1<br>maxLength 7   |
| annotation | documentation<br>03040: No Capital Guarantee nor protection. 100% capital at risk. Yes or No or Neutral |

element

**EMT\_V4\_FinancialInstrumentType/TargetMarket/AbilityToBearLosses/CompatibleWithClientsWhoCanBearLossBeyondCapital**

|            |  |
|------------|--|
| diagram    |  |
| type       | <a href="#">EMTYesNoNeutralType</a>                                      |
| properties | isRef 0<br>content simple  |
| facets     | Kind Value annotation<br>minLength 1<br>maxLength 7                      |
| annotation | documentation<br>03050: Loss Beyond the Capital.<br>Yes or No or Neutral |

element **EMT\_V4\_FinancialInstrumentType/TargetMarket/RiskTolerance**

|                   |  |
|-------------------|--|
| <p>diagram</p>    | <p><b>RiskTolerance</b><br/>Target markets - Risk Tolerance</p> <ul style="list-style-type: none"> <li><b>PRIIPSMethodology</b><br/>04010: SRI (1-7), if PRIIPS KID is available. German distributors will use only this Risk Tolerance item</li> <li><b>UCITSMethodology</b><br/>04020: SRRI (1-7; for funds)</li> <li><b>InternalMethodology</b><br/>04030: For Non PRIIPS and Non UCITS:<br/>L ... Low<br/>M ... Medium<br/>H ... High</li> <li><b>MethodologySpain</b><br/>04040: Spanish SRI (1-6) for Non PRIIPS and Non UCITS<br/>For Spanish local NON PRIIPS and NON UCITS products.<br/>Orden ECC/2316/2015, de 4 de noviembre, relativa a las obligaciones de información y clasificación de productos financieros</li> <li><b>NotForInvestorsWithLowestRis...</b><br/>04050: For all products distributed in Germany (Yes or Neutral)</li> </ul> |
| <p>properties</p> | <p>isRef 0<br/>content complex</p>   |
| <p>children</p>   | <p><a href="#">PRIIPSMethodology</a> <a href="#">UCITSMethodology</a> <a href="#">InternalMethodology</a> <a href="#">MethodologySpain</a><br/><a href="#">NotForInvestorsWithLowestRiskToleranceGermany</a></p>   |
| <p>annotation</p> | <p>documentation<br/>Target markets - Risk Tolerance</p>   |

element **EMT\_V4\_FinancialInstrumentType/TargetMarket/RiskTolerance/PRIIPSMethodology**

|                   |  |
|-------------------|--|
| <p>diagram</p>    | <p><b>PRIIPSMethodology</b><br/>04010: SRI (1-7), if PRIIPS KID is available. German distributors will use only this Risk Tolerance item</p> |
| <p>type</p>       | <p>restriction of <b>xs:positiveInteger</b></p>  |
| <p>properties</p> | <p>isRef 0<br/>minOcc 0<br/>maxOcc 1<br/>content simple</p>  |
| <p>facets</p>     | <p>Kind Value annotation<br/>minInclusive 1<br/>maxInclusive 7</p>   |
| <p>annotation</p> | <p>documentation<br/>04010: SRI (1-7), if PRIIPS KID is available. German distributors will use only this Risk Tolerance item</p>            |

element **EMT\_V4\_FinancialInstrumentType/TargetMarket/RiskTolerance/UCITSMethodology**

|            |   |
|------------|---|
| diagram    |  <b>UCITSMethodology</b><br>04020: SRRI (1-7; for funds) |
| type       | restriction of <b>xs:positiveInteger</b>  |
| properties | isRef 0<br>minOcc 0<br>maxOcc 1<br>content simple   |
| facets     | Kind Value annotation<br>minInclusive 1<br>maxInclusive 7   |
| annotation | documentation<br>04020: SRRI (1-7; for funds)   |

element **EMT\_V4\_FinancialInstrumentType/TargetMarket/RiskTolerance/InternalMethodology**

|            |   |
|------------|---|
| diagram    |  <b>InternalMethodology</b><br>04030: For Non PRIIPS and Non UCITS:<br>L ... Low<br>M ... Medium<br>H ... High |
| type       | restriction of <b>xs:string</b>   |
| properties | isRef 0<br>minOcc 0<br>maxOcc 1<br>content simple   |
| annotation | documentation<br>04030: For Non PRIIPS and Non UCITS:<br>L ... Low<br>M ... Medium<br>H ... High  |

element **EMT\_V4\_FinancialInstrumentType/TargetMarket/RiskTolerance/MethodologySpain**

|            |   |
|------------|---|
| diagram    |  <b>MethodologySpain</b><br>04040: Spanish SRI (1-6) for Non PRIIPS and Non UCITS<br>For Spanish local NON PRIIPS and NON UCITS products.<br>Orden ECC/2316/2015, de 4 de noviembre, relativa a las obligaciones de información y clasificación de productos financieros |
| type       | restriction of <b>xs:positiveInteger</b>  |
| properties | isRef 0<br>minOcc 0<br>maxOcc 1<br>content simple   |

|            |   |
|------------|---|
| facets     | Kind Value annotation<br>minInclusive 1<br>maxInclusive 6   |
| annotation | documentation<br>04040: Spanish SRI (1-6) for Non PRIIPS and Non UCITS<br>For Spanish local NON PRIIPS and NON UCITS products.<br>Orden ECC/2316/2015, de 4 de noviembre, relativa a las obligaciones de información y clasificación de productos financieros |

element

**EMT\_V4\_FinancialInstrumentType/TargetMarket/RiskTolerance/NotForInvestorsWithLowestRiskToleranceGermany**

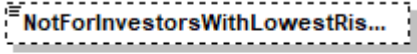
|            |  |
|------------|--|
| diagram    |  <p>04050: For all products distributed in Germany (Yes or Neutral)</p> |
| type       | restriction of xs:string   |
| properties | isRef 0<br>minOcc 0<br>maxOcc 1<br>content simple  |
| annotation | documentation<br>04050: For all products distributed in Germany (Yes or Neutral)   |

element **EMT\_V4\_FinancialInstrumentType/TargetMarket/ClientObjectives**

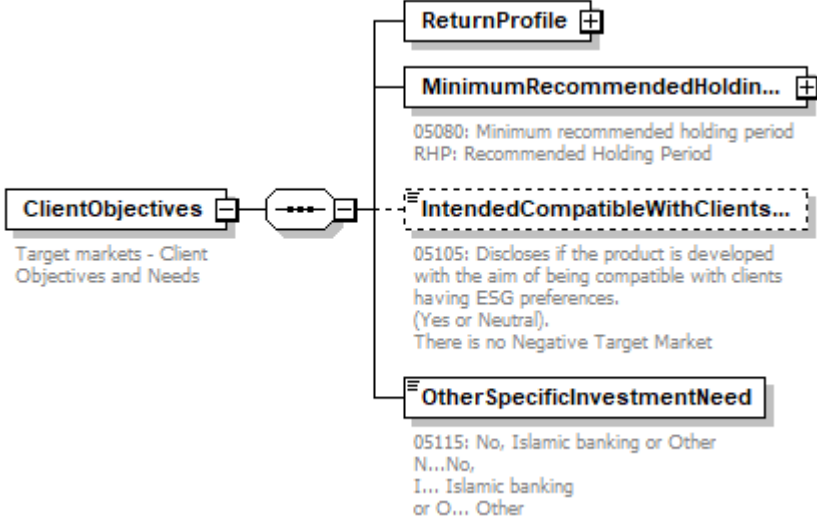
|            |  |
|------------|--|
| diagram    |  <p>Target markets - Client Objectives and Needs</p> <p>05080: Minimum recommended holding period<br/>RHP: Recommended Holding Period</p> <p>05105: Discloses if the product is developed with the aim of being compatible with clients having ESG preferences. (Yes or Neutral).<br/>There is no Negative Target Market</p> <p>05115: No, Islamic banking or Other<br/>N...No,<br/>I... Islamic banking<br/>or O... Other</p> |
| properties | isRef 0<br>content complex   |
| children   | <a href="#">ReturnProfile</a> <a href="#">MinimumRecommendedHoldingPeriod</a> <a href="#">IntendedCompatibleWithClientsHavingSustainabilityPreferences</a> <a href="#">OtherSpecificInvestmentNeed</a>   |
| annotation | documentation<br>Target markets - Client Objectives and Needs  |



element **EMT\_V4\_FinancialInstrumentType/TargetMarket/ClientObjectives/ReturnProfile**

|                   |   |
|-------------------|---|
| <p>diagram</p>    | <pre> classDiagram     class ReturnProfile     class ClientLookingForPreservation     class ClientLookingForCapitalGrowth     class ClientLookingForIncome     class OptionOrLeveraged     class PensionSchemeGermany     class StructuredSecurity      ReturnProfile -- ClientLookingForPreservation     ReturnProfile -- ClientLookingForCapitalGrowth     ReturnProfile -- ClientLookingForIncome     ReturnProfile -.- OptionOrLeveraged     ReturnProfile -.- PensionSchemeGermany     ReturnProfile -.- StructuredSecurity     </pre> <p><b>ClientLookingForPreservation</b><br/>05010: Indicates if the product is compatible with clients looking for preserving their capital. Products stipulating a capital preservation objective should be YES. For other products, the answer should be NO or NEUTRAL based on a case-by-case analysis. In Germany fields 05010, 05020 and 05030 are merged and regarded "General Capital Formation". A YES in any of these fields will be regarded a YES in the German combined field.</p> <p><b>ClientLookingForCapitalGrowth</b><br/>05020: Indicates if the product is compatible with clients looking for growing their capital. In Germany fields 05010, 05020 and 05030 are merged and regarded "General Capital Formation". A YES in any of these fields will be regarded a YES in the German combined field.</p> <p><b>ClientLookingForIncome</b><br/>05030: Indicates if the product is compatible with clients looking for Income. In Germany fields 05010, 05020 and 05030 are merged and regarded "General Capital Formation". A YES in any of these fields will be regarded a YES in the German combined field.</p> <p><b>OptionOrLeveraged</b><br/>05050: Yes or No or Neutral</p> <p><b>PensionSchemeGermany</b><br/>05070: Yes or No or Neutral</p> <p><b>StructuredSecurity</b> ⊕</p> |
| <p>properties</p> | <p>isRef 0<br/>content complex</p>  |
| <p>children</p>   | <p><a href="#">ClientLookingForPreservation</a> <a href="#">ClientLookingForCapitalGrowth</a> <a href="#">ClientLookingForIncome</a> <a href="#">OptionOrLeveraged</a> <a href="#">PensionSchemeGermany</a> <a href="#">StructuredSecurity</a></p>  |

element

**EMT\_V4\_FinancialInstrumentType/TargetMarket/ClientObjectives/ReturnProfile/ClientLookingForPreservation**

|            |   |
|------------|---|
| diagram    |  <p>05010: Indicates if the product is compatible with clients looking for preserving their capital. Products stipulating a capital preservation objective should be YES. For other products, the answer should be NO or NEUTRAL based on a case-by-case analysis. In Germany fields 05010, 05020 and 05030 are merged and regarded "General Capital Formation". A YES in any of these fields will be regarded a YES in the German combined field.</p> |
| type       | <a href="#">EMTYesNoNeutralType</a>   |
| properties | isRef 0<br>content simple   |
| facets     | Kind Value annotation<br>minLength 1<br>maxLength 7   |
| annotation | documentation<br>05010: Indicates if the product is compatible with clients looking for preserving their capital. Products stipulating a capital preservation objective should be YES. For other products, the answer should be NO or NEUTRAL based on a case-by-case analysis. In Germany fields 05010, 05020 and 05030 are merged and regarded "General Capital Formation". A YES in any of these fields will be regarded a YES in the German combined field.   |

element

**EMT\_V4\_FinancialInstrumentType/TargetMarket/ClientObjectives/ReturnProfile/ClientLookingForCapitalGrowth**

|            |  |
|------------|--|
| diagram    |  <p>05020: Indicates if the product is compatible with clients looking for growing their capital. In Germany fields 05010, 05020 and 05030 are merged and regarded "General Capital Formation". A YES in any of these fields will be regarded a YES in the German combined field.</p> |
| type       | <a href="#">EMTYesNoNeutralType</a>  |
| properties | isRef 0<br>content simple  |
| facets     | Kind Value annotation<br>minLength 1<br>maxLength 7  |
| annotation | documentation<br>05020: Indicates if the product is compatible with clients looking for growing their capital. In Germany fields 05010, 05020 and 05030 are merged and regarded "General Capital Formation". A YES in any of these fields will be regarded a YES in the German combined field.   |

element

**EMT\_V4\_FinancialInstrumentType/TargetMarket/ClientObjectives/ReturnProfile/ClientLookingForIncome**

|            |   |
|------------|---|
| diagram    | <br><b>ClientLookingForIncome</b><br>05030: Indicates if the product is compatible with clients looking for Income.<br>In Germany fields 05010, 05020 and 05030 are merged and regarded "General Capital Formation". A YES in any of these fields will be regarded a YES in the German combined field. |
| type       | <a href="#">EMTYesNoNeutralType</a>   |
| properties | isRef 0<br>content simple   |
| facets     | Kind Value annotation<br>minLength 1<br>maxLength 7   |
| annotation | documentation<br>05030: Indicates if the product is compatible with clients looking for Income.<br>In Germany fields 05010, 05020 and 05030 are merged and regarded "General Capital Formation". A YES in any of these fields will be regarded a YES in the German combined field.  |

element

**EMT\_V4\_FinancialInstrumentType/TargetMarket/ClientObjectives/ReturnProfile/OptionOrLeveraged**

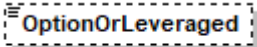
|            |  |
|------------|--|
| diagram    | <br><b>OptionOrLeveraged</b><br>05050: Yes or No or Neutral |
| type       | <a href="#">EMTYesNoNeutralType</a>  |
| properties | isRef 0<br>minOcc 0<br>maxOcc 1<br>content simple  |
| facets     | Kind Value annotation<br>minLength 1<br>maxLength 7  |
| annotation | documentation<br>05050: Yes or No or Neutral   |

element

**EMT\_V4\_FinancialInstrumentType/TargetMarket/ClientObjectives/ReturnProfile/PensionSchemeGermany**

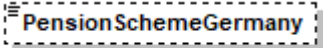
|            |   |
|------------|---|
| diagram    | <br><b>PensionSchemeGermany</b><br>05070: Yes or No or Neutral |
| type       | <a href="#">EMTYesNoNeutralType</a>   |
| properties | isRef 0<br>minOcc 0<br>maxOcc 1<br>content simple   |
| facets     | Kind Value annotation<br>minLength 1  |

|            |  |
|------------|--|
|            | maxLength 7                                  |
| annotation | documentation<br>05070: Yes or No or Neutral |

element

**EMT\_V4\_FinancialInstrumentType/TargetMarket/ClientObjectives/ReturnProfile/StructuredSecurity**

|            |   |
|------------|---|
| diagram    | <p>05040: Yes or No or Neutral<br/>Only for structured Securities</p> |
| properties | isRef 0<br>minOcc 0<br>maxOcc 1<br>content complex                    |
| children   | <a href="#">Hedging</a>   |

element

**EMT\_V4\_FinancialInstrumentType/TargetMarket/ClientObjectives/ReturnProfile/StructuredSecurity/Hedging**

|            |  |
|------------|--|
| diagram    | <p>05040: Yes or No or Neutral<br/>Only for structured Securities</p>          |
| type       | <a href="#">EMTYesNoNeutralType</a>  |
| properties | isRef 0<br>content simple  |
| facets     | Kind Value annotation<br>minLength 1<br>maxLength 7                            |
| annotation | documentation<br>05040: Yes or No or Neutral<br>Only for structured Securities |

element

**EMT\_V4\_FinancialInstrumentType/TargetMarket/ClientObjectives/MinimumRecommendedHoldingPeriod**

|            |   |
|------------|---|
| diagram    | <p>05080: Minimum recommended holding period<br/>RHP: Recommended Holding Period</p> <p><b>Years</b><br/>Minimum recommended holding period in years</p> <p><b>Category</b><br/>V ... Very short term (max 1Y)<br/>S ... Short term (max 3Y)<br/>M ... Medium term (max 5Y)<br/>L ... Long term (min 5Y)<br/>H ... Hold to Maturity</p> |
| properties | isRef 0<br>content complex  |
| children   | <a href="#">Years</a> <a href="#">Category</a>  |

|            |   |
|------------|---|
| annotation | documentation<br>05080: Minimum recommended holding period<br>RHP: Recommended Holding Period |
|------------|---|

element

**EMT\_V4\_FinancialInstrumentType/TargetMarket/ClientObjectives/MinimumRecommendedHoldingPeriod/Years**

|            |  |
|------------|--|
| diagram    |  <p>Minimum recommended holding period in years</p> |
| type       | <b>xs:decimal</b>  |
| properties | isRef 0<br>content simple  |
| annotation | documentation<br>Minimum recommended holding period in years   |

element

**EMT\_V4\_FinancialInstrumentType/TargetMarket/ClientObjectives/MinimumRecommendedHoldingPeriod/Category**

|            |  |
|------------|--|
| diagram    |  <p>V ... Very short term (max 1Y)<br/>S ... Short term (max 3Y)<br/>M ... Medium term (max 5Y)<br/>L ... Long term (min 5Y)<br/>H ... Hold to Maturity</p> |
| type       | restriction of <b>xs:string</b>  |
| properties | isRef 0<br>content simple  |
| annotation | documentation<br>V ... Very short term (max 1Y)<br>S ... Short term (max 3Y)<br>M ... Medium term (max 5Y)<br>L ... Long term (min 5Y)<br>H ... Hold to Maturity   |

element

**EMT\_V4\_FinancialInstrumentType/TargetMarket/ClientObjectives/IntendedCompatibleWithClientsHavingSustainabilityPreferences**

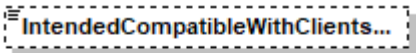
|            |  |
|------------|--|
| diagram    |  <p>05105: Discloses if the product is developed with the aim of being compatible with clients having ESG preferences. (Yes or Neutral).<br/>There is no Negative Target Market</p> |
| type       | <b>EMTYesNeutralType</b>   |
| properties | isRef 0<br>minOcc 0<br>maxOcc 1<br>content simple  |

|            |   |
|------------|---|
| facets     | Kind Value annotation<br>minLength 1<br>maxLength 7   |
| annotation | documentation<br>05105: Discloses if the product is developed with the aim of being compatible with clients having ESG preferences. (Yes or Neutral).<br>There is no Negative Target Market |

element

**EMT\_V4\_FinancialInstrumentType/TargetMarket/ClientObjectives/OtherSpecificInvestmentNeed**

|            |  |
|------------|--|
| diagram    | <p><b>OtherSpecificInvestmentNeed</b><br/>05115: No, Islamic banking or Other<br/>N...No,<br/>I... Islamic banking<br/>or O... Other</p> |
| type       | restriction of <b>xs:string</b>  |
| properties | isRef 0<br>content simple  |
| facets     | Kind Value annotation<br>length 1  |
| annotation | documentation<br>05115: No, Islamic banking or Other<br>N...No,<br>I... Islamic banking<br>or O... Other                                 |

element **EMT\_V4\_FinancialInstrumentType/TargetMarket/DistributionStrategy**

|            |  |
|------------|--|
| diagram    | <p><b>DistributionStrategy</b><br/>Target markets - Distribution Strategy</p> <ul style="list-style-type: none"> <li><b>ExecutionOnly</b><br/>06010: Retail or Professional or Both or Neither</li> <li><b>ExecutionWithCheckOrNonAdvisedServices</b><br/>06020: Retail or Professional or Both or Neither</li> <li><b>InvestmentAdvice</b><br/>06030: Retail or Professional or Both or Neither</li> <li><b>PortfolioManagement</b><br/>06040: Retail or Professional or Both or Neither</li> </ul> |
| properties | isRef 0<br>content complex   |
| children   | <a href="#">ExecutionOnly</a> <a href="#">ExecutionWithCheckOrNonAdvisedServices</a> <a href="#">InvestmentAdvice</a> <a href="#">PortfolioManagement</a>  |
| annotation | documentation<br>Target markets - Distribution Strategy  |

element **EMT\_V4\_FinancialInstrumentType/TargetMarket/DistributionStrategy/ExecutionOnly**

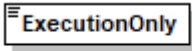
|            |   |
|------------|---|
| diagram    |  <p>06010: Retail or Professional or Both or Neither</p> |
| type       | <a href="#">RetailProfessionalBothNeitherType</a>   |
| properties | isRef 0<br>content simple   |
| facets     | Kind Value annotation<br>length 1   |
| annotation | documentation<br>06010: Retail or Professional or Both or Neither   |

element **EMT\_V4\_FinancialInstrumentType/TargetMarket/DistributionStrategy/ExecutionWithCheckOrNonAdvisedServices**

|            |   |
|------------|---|
| diagram    |  <p>06020: Retail or Professional or Both or Neither</p> |
| type       | <a href="#">RetailProfessionalBothNeitherType</a>   |
| properties | isRef 0<br>content simple   |
| facets     | Kind Value annotation<br>length 1   |
| annotation | documentation<br>06020: Retail or Professional or Both or Neither   |

element **EMT\_V4\_FinancialInstrumentType/TargetMarket/DistributionStrategy/InvestmentAdvice**

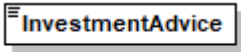
|            |   |
|------------|---|
| diagram    |  <p>06030: Retail or Professional or Both or Neither</p> |
| type       | <a href="#">RetailProfessionalBothNeitherType</a>   |
| properties | isRef 0<br>content simple   |
| facets     | Kind Value annotation<br>length 1   |
| annotation | documentation<br>06030: Retail or Professional or Both or Neither   |

element **EMT\_V4\_FinancialInstrumentType/TargetMarket/DistributionStrategy/PortfolioManagement**

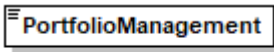
|            |   |
|------------|---|
| diagram    |  <p>06040: Retail or Professional or Both or Neither</p> |
| type       | <a href="#">RetailProfessionalBothNeitherType</a>   |
| properties | isRef 0<br>content simple   |
| facets     | Kind Value annotation   |

|            |   |
|------------|---|
|            | length 1  |
| annotation | documentation<br>06040: Retail or Professional or Both or Neither |

element **EMT\_V4\_FinancialInstrumentType/CostsAndChargesExAnte**

|            |   |
|------------|---|
| diagram    | <pre> classDiagram     class CostsAndChargesExAnte     class Fund     class StructuredSecurity     class CostsReferenceDate      CostsAndChargesExAnte --&gt; Choice1[ ]     Choice1 --&gt; Fund     Choice1 --&gt; StructuredSecurity     Choice1 --&gt; CostsReferenceDate     Fund --&gt; Choice2[ ]     StructuredSecurity --&gt; Choice2   </pre> <p>Costs and Charges ex ante</p> <p>Relevant fields for funds</p> <p>Relevant fields for structured securities</p> <p>07160 : The Reference Date to which all Ex-Ante Cost disclosures refer (i.e NOT to be mistaken for General Reference Date, field 00050 or Generation Date and Time, field 00005)</p> |
| properties | isRef 0<br>content complex  |
| children   | <a href="#">Fund</a> <a href="#">StructuredSecurity</a> <a href="#">CostsReferenceDate</a>  |
| annotation | documentation<br>Costs and Charges ex ante  |



element EMT\_V4\_FinancialInstrumentType/CostsAndChargesExAnte/Fund

diagram



**GrossMaxEntryCostNonAcquired**

07020 Maximum not acquired to the fund. Expressed as a % of the amount to be invested. This data is a maximum cost not acquired to the fund. It is indicative and should be adapted by the distributor reserving the file to take into account the commercial agreement with the asset manager. Conditional to the existence of this feature.

**NetEntryCostNonAcquired**

07021 Expressed as a % of the amount to be invested. Subscription NAV - Par Value. Applicable for Structured Fund.

**MaxEntryCostDaily**

07020 Maximum fixed amount per subscription, not incorporated. Flat fixed fee defined by the manufacturer (linked to Paying Agent). Only for the Italian Market. Conditional to the existence of the feature. It is subscription related but decided by the manufacturer. In all cases it must be adapted to the specific relationship between the manufacturer and the distributor. This cost is not taken in account in the entry cost item 07020.

**MaxEntryCostAcquired**

07040 Subscription fees acquired to the fund. Expressed as a % of the amount to be invested. Not included in the entry cost 07020. Conditional to the fact that the fund has this feature.

**MaxExitCost**

07030 Maximum cost acquired to the fund. Expressed as a % of the NAV. Maximum fees not acquired to the funds that could happen at a certain time during the life of the product. Conditional to the existence of this feature.

**MaxExitCostDaily**

07060 Maximum fixed amount per redemption, not incorporated. Flat fee defined by the manufacturer. Only for the Italian Market. Conditional to the existence of the feature. It is redemption related but decided by the manufacturer. In all cases it must be adapted to the specific relationship between the manufacturer and the distributor. This cost is not taken in account in the exit cost item 07030.

**MaxExitCostAcquired**

07070 Maximum Exit fees acquired to the fund. Expressed as a % of the NAV. Not included in the exit cost item 07030. Conditional to the existence of the feature.

**TypicalExitCost**

07080 Current exit cost linked to the RSP or Time to Maturity or 3Y (V) or 3Y(S) or 5Y (M) (the value of 0000). Minimum, Assumed, del\_Holding\_Period.

**ExitCostPriorRSP**

07090 Expressed as a % of the amount to be divested (Par Value - Exit Value (eg bid price). For Structured Fund only.

**OngoingCosts**

07100 % of NAV of the Financial Product expressed in annualized terms (rate of cost deduction to be applied). Ongoing costs include management fees and distribution fees and exclude all transaction costs, incidental costs and performance fees. Costs reported should reflect current running ongoing costs.

**BorrowingCosts**

07120 Financing costs related to borrowing for the purpose of paying, expressed as a % of NAV of the Financial Product expressed in annualized terms (rate of cost deduction to be applied). Only applicable if the product is borrowing. Borrowing costs are included in Ongoing costs.

**ManagementFee**

07110 % of NAV of the Financial Product expressed in annualized terms (rate of cost deduction to be applied). These fees are included in total on-going costs. These fees are used by distributors to calculate their gross spread fees. Costs reported should reflect current running management costs.

**DistributionFee**

07120 % of NAV of the Financial Product expressed in annualized terms (rate of cost deduction to be applied).

**TransactionCosts**

07130 % of NAV of the Financial Product expressed in annualized terms (rate of cost deduction to be applied). 0 for reinvested premium. Costs within the products.

**IncidentalCosts**

07140 % of NAV of the Financial Product expressed in annualized terms (rate of cost deduction to be applied). Includes Performance Fees and other costs.

|            |  |
|------------|--|
| properties | isRef 0<br>content complex   |
| children   | <a href="#">GrossMaxEntryCostNonAcquired</a> <a href="#">NetEntryCostNonAcquired</a> <a href="#">MaxEntryCostItaly</a> <a href="#">MaxEntryCostAcquired</a> <a href="#">MaxExitCost</a> <a href="#">MaxExitCostItaly</a> <a href="#">MaxExitCostAcquired</a> <a href="#">TypicalExitCost</a> <a href="#">ExitCostPriorRHP</a> <a href="#">OngoingCosts</a> <a href="#">BorrowingCostsUK</a> <a href="#">ManagementFee</a> <a href="#">DistributionFee</a> <a href="#">TransactionCosts</a> <a href="#">IncidentalCosts</a> |
| annotation | documentation<br>Relevant fields for funds   |

element

**EMT\_V4\_FinancialInstrumentType/CostsAndChargesExAnte/Fund/GrossMaxEntryCostNonAcquired**

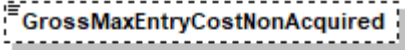
|            |   |
|------------|---|
| diagram    |  <p>07020: Maximum not acquired to the fund. Expressed as a % of the amount to be invested. This data is a maximum cost not acquired to the fund.. It is indicative and should be adapted by the distributor receiving the file to take into account the commercial agreement with the asset manager. Conditional to the existence of this feature</p> |
| type       | <b>xs:decimal</b>   |
| properties | isRef 0<br>minOcc 0<br>maxOcc 1<br>content simple   |
| annotation | documentation<br>07020: Maximum not acquired to the fund. Expressed as a % of the amount to be invested. This data is a maximum cost not acquired to the fund.. It is indicative and should be adapted by the distributor receiving the file to take into account the commercial agreement with the asset manager. Conditional to the existence of this feature   |

element **EMT\_V4\_FinancialInstrumentType/CostsAndChargesExAnte/Fund/NetEntryCostNonAcquired**

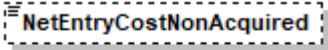
|            |   |
|------------|---|
| diagram    |  <p>07025: Expressed as a % of the amount to be invested. Subscription NAV - Fair Value. Applicable for Structured Frund</p> |
| type       | <b>xs:decimal</b>   |
| properties | isRef 0<br>minOcc 0<br>maxOcc 1<br>content simple   |
| annotation | documentation<br>07025: Expressed as a % of the amount to be invested. Subscription NAV - Fair Value. Applicable for Structured Frund   |

element **EMT\_V4\_FinancialInstrumentType/CostsAndChargesExAnte/Fund/MaxEntryCostItaly**

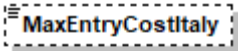
|            |   |
|------------|---|
| diagram    |  <p>07030: Maximum fixed amount per subscription, not incorporated. Flat fixed fee defined by the manufacturer (Linked to Paying Agent) Only for the Italian Market. Conditionnal to the existence of the feature<br/>It is subscription related but decided by the manufacturers. In all cases it must be adapted to the specific relationship between the manufacturers and the distribution. This cost is not taken in account in the entry cost item 07020</p> |
| type       | restriction of <b>xs:decimal</b>  |
| properties | <p>isRef 0<br/>minOcc 0<br/>maxOcc 1<br/>content simple</p>   |
| facets     | <p>Kind Value annotation<br/>minInclusive 0</p>   |
| annotation | <p>documentation<br/>07030: Maximum fixed amount per subscription, not incorporated. Flat fixed fee defined by the manufacturer (Linked to Paying Agent) Only for the Italian Market. Conditionnal to the existence of the feature<br/>It is subscription related but decided by the manufacturers. In all cases it must be adapted to the specific relationship between the manufacturers and the distribution. This cost is not taken in account in the entry cost item 07020</p>   |

element **EMT\_V4\_FinancialInstrumentType/CostsAndChargesExAnte/Fund/MaxEntryCostAcquired**

|            |  |
|------------|--|
| diagram    |  <p>07040: Subscription fees acquired to the fund<br/>Expressed as a % of the amount to be invested.<br/>Not included in the entry cost 07020. Conditionnal to the fact that the fund has this feature.</p> |
| type       | restriction of <b>xs:decimal</b>   |
| properties | <p>isRef 0<br/>minOcc 0<br/>maxOcc 1<br/>content simple</p>  |
| facets     | <p>Kind Value annotation<br/>minInclusive 0</p>  |
| annotation | <p>documentation<br/>07040: Subscription fees acquired to the fund<br/>Expressed as a % of the amount to be invested.<br/>Not included in the entry cost 07020. Conditionnal to the fact that the fund has this feature.</p>   |

element **EMT\_V4\_FinancialInstrumentType/CostsAndChargesExAnte/Fund/MaxExitCost**

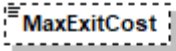
|            |   |
|------------|---|
| diagram    |  <p>07050: Maximum not acquired to the fund Expressed as a % of the NAV.<br/>Maximum fees not acquired to the funds that could happen at a certain time during the life of the product. Conditional to the existence of this feature</p> |
| type       | restriction of <b>xs:decimal</b>  |
| properties | isRef 0<br>minOcc 0<br>maxOcc 1<br>content simple   |
| facets     | Kind Value annotation<br>minInclusive 0   |
| annotation | documentation<br>07050: Maximum not acquired to the fund Expressed as a % of the NAV.<br>Maximum fees not acquired to the funds that could happen at a certain time during the life of the product. Conditional to the existence of this feature  |

element **EMT\_V4\_FinancialInstrumentType/CostsAndChargesExAnte/Fund/MaxExitCostItaly**

|            |  |
|------------|--|
| diagram    |  <p>07060: Maximum fixed amount per redemption, not incorporated. Flat fee defined by the manufacturer. Only for the Italian Market. Conditionnal to the existence of the feature.<br/>It is redemption related but decided by the manufacturers. In all cases it must be adapted to the specific relationship between the manufacturers and the distribution. This cost is not taken in account in the exit cost item 07050</p> |
| type       | restriction of <b>xs:decimal</b>   |
| properties | isRef 0<br>minOcc 0<br>maxOcc 1<br>content simple  |
| facets     | Kind Value annotation<br>minInclusive 0  |
| annotation | documentation<br>07060: Maximum fixed amount per redemption, not incorporated. Flat fee defined by the manufacturer. Only for the Italian Market. Conditionnal to the existence of the feature.<br>It is redemption related but decided by the manufacturers. In all cases it must be adapted to the specific relationship between the manufacturers and the distribution. This cost is not taken in account in the exit cost item 07050   |

element **EMT\_V4\_FinancialInstrumentType/CostsAndChargesExAnte/Fund/MaxExitCostAcquired**

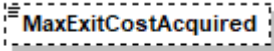
|            |  |
|------------|--|
| diagram    |  <p><b>MaxExitCostAcquired</b></p> <p>07070: Maximum Exit fees acquired to the fund Expressed as a % of the NAV. Not included in the exit cost item 07050 . Conditional to the existence of this feature.</p> |
| type       | restriction of <b>xs:decimal</b>   |
| properties | isRef 0<br>minOcc 0<br>maxOcc 1<br>content simple  |
| facets     | Kind Value annotation<br>minInclusive 0  |
| annotation | documentation<br>07070: Maximum Exit fees acquired to the fund Expressed as a % of the NAV. Not included in the exit cost item 07050 . Conditional to the existence of this feature.   |

element **EMT\_V4\_FinancialInstrumentType/CostsAndChargesExAnte/Fund/TypicalExitCost**

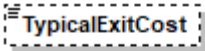
|            |  |
|------------|--|
| diagram    |  <p><b>TypicalExitCost</b></p> <p>07080: Current exit cost linked to the RHP or Time to Maturity or 1Y (V) or 3Y(S) or 5Y (M L) (the value of 05080_Minimum_Recommended_Holding_Period)</p> |
| type       | restriction of <b>xs:decimal</b>   |
| properties | isRef 0<br>minOcc 0<br>maxOcc 1<br>content simple  |
| facets     | Kind Value annotation<br>minInclusive 0  |
| annotation | documentation<br>07080: Current exit cost linked to the RHP or Time to Maturity or 1Y (V) or 3Y(S) or 5Y (M L) (the value of 05080_Minimum_Recommended_Holding_Period)   |

element **EMT\_V4\_FinancialInstrumentType/CostsAndChargesExAnte/Fund/ExitCostPriorRHP**

|            |  |
|------------|--|
| diagram    |  <p><b>ExitCostPriorRHP</b></p> <p>07090: Expressed as a % of the amount to be divested. Fair Value - Exit Value (eg Bid Price). For Structured Fund only</p> |
| type       | restriction of <b>xs:decimal</b>   |
| properties | isRef 0<br>minOcc 0<br>maxOcc 1<br>content simple  |
| facets     | Kind Value annotation  |

|            |   |
|------------|---|
|            | minInclusive 0  |
| annotation | documentation<br>07090: Expressed as a % of the amount to be divested. Fair Value - Exit Value (eg Bid Price). For Structured Fund only |

element **EMT\_V4\_FinancialInstrumentType/CostsAndChargesExAnte/Fund/OngoingCosts**

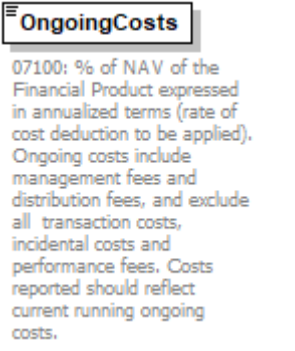
|            |   |
|------------|---|
| diagram    |    |
| type       | restriction of <b>xs:decimal</b>  |
| properties | isRef 0<br>content simple   |
| facets     | Kind Value annotation<br>minInclusive 0   |
| annotation | documentation<br>07100: % of NAV of the Financial Product expressed in annualized terms (rate of cost deduction to be applied). Ongoing costs include management fees and distribution fees, and exclude all transaction costs, incidental costs and performance fees. Costs reported should reflect current running ongoing costs. |

element **EMT\_V4\_FinancialInstrumentType/CostsAndChargesExAnte/Fund/BorrowingCostsUK**

|            |   |
|------------|---|
| diagram    |   |
| type       | <b>xs:decimal</b>   |
| properties | isRef 0<br>minOcc 0<br>maxOcc 1<br>content simple   |
| annotation | documentation<br>07105: Financing costs related to borrowing for the purposes of gearing expressed as a % of NAV of the Financial Product expressed in annualized terms (rate of cost deduction to be applied). Only applicable if the product is borrowing. Borrowing costs are included in Ongoing costs. |

element **EMT\_V4\_FinancialInstrumentType/CostsAndChargesExAnte/Fund/ManagementFee**

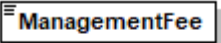
|            |  |
|------------|--|
| diagram    |  <p>07110: % of NAV of the Financial Product expressed in annualized terms (rate of cost deduction to be applied). These fees are included in total on going costs. These fees are used by distributors to calculate their retrocession fees. Costs reported should reflect current running management costs.</p> |
| type       | restriction of <b>xs:decimal</b>   |
| properties | isRef 0<br>content simple  |
| facets     | Kind Value annotation<br>minInclusive 0  |
| annotation | documentation<br>07110: % of NAV of the Financial Product expressed in annualized terms (rate of cost deduction to be applied). These fees are included in total on going costs. These fees are used by distributors to calculate their retrocession fees. Costs reported should reflect current running management costs.   |

element **EMT\_V4\_FinancialInstrumentType/CostsAndChargesExAnte/Fund/DistributionFee**

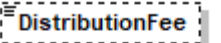
|            |  |
|------------|--|
| diagram    |  <p>07120: % of NAV of the Financial Product expressed in annualized terms (rate of cost deduction to be applied)</p> |
| type       | restriction of <b>xs:decimal</b>   |
| properties | isRef 0<br>minOcc 0<br>maxOcc 1<br>content simple  |
| facets     | Kind Value annotation<br>minInclusive 0  |
| annotation | documentation<br>07120: % of NAV of the Financial Product expressed in annualized terms (rate of cost deduction to be applied)   |

element **EMT\_V4\_FinancialInstrumentType/CostsAndChargesExAnte/Fund/TransactionCosts**

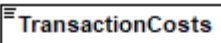
|            |  |
|------------|--|
| diagram    |  <p>07130: % of NAV of the Financial Product expressed in annualized terms (rate of cost deduction to be applied). 0 for structured products. Costs within the products</p> |
| type       | restriction of <b>xs:decimal</b>   |
| properties | isRef 0<br>content simple  |
| facets     | Kind Value annotation<br>minInclusive 0  |
| annotation | documentation<br>07130: % of NAV of the Financial Product expressed in annualized terms (rate of cost deduction to be applied).  |

|  |
|--|
| 0 for structured products. Costs within the products |
|--|

element **EMT\_V4\_FinancialInstrumentType/CostsAndChargesExAnte/Fund/IncidentalCosts**

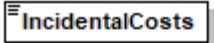
|            |  |
|------------|--|
| diagram    |  <p>07140: % of NAV of the Financial Product expressed in annualized terms (rate of cost deduction to be applied). Includes Performance Fees and other costs.</p> |
| type       | restriction of <b>xs:decimal</b>   |
| properties | isRef 0<br>content simple  |
| facets     | Kind Value annotation<br>minInclusive 0  |
| annotation | documentation<br>07140: % of NAV of the Financial Product expressed in annualized terms (rate of cost deduction to be applied). Includes Performance Fees and other costs.   |



element **EMT\_V4\_FinancialInstrumentType/CostsAndChargesExAnte/StructuredSecurity**

diagram

**StructuredSecurity**

Relevant fields for structured securities

**GrossMaxEntryCostNonAcquired**

07020: "Ask Price" - Fair Value ( as of Reference Date Ex-Ante ). This data should only incorporate manufacturer costs (i.e. cost of the financial instrument) and distributor upfront when known by the manufacturer. It should however NOT include distribution fees added on top of the product price by distributors that is out of control of the manufacturer.

**NetEntryCostNonAcquired**

07025: Net\_One-off Entry cost = 07020 less upfront distribution fee embedded in the 07020. In practice 07025 will be the portion of the 07020 retained by the manufacturer. This data is optional and could be used in the event of only one layer of intermediation or in a case where distributor up fronts are paid equally to all distributors. The costs reported in this field is a Net disclosure and therefore the distributor upfront is equal to the difference between 07020 and 07025.

**TypicalExitCost**

07080: Exit cost at the RHP

**ExitCostPriorRHP**

07090: Fixed amount

**OngoingCosts**

07100: Expressed as a % of NAV / Notional (or currency amount for Absolute quotation) of the Financial Product in annualized terms related to Reference in 07150 or 07155 respectively.

**ManagementFee**

07110: Expressed as a % of NAV / Notional (or currency amount for Absolute quotation) of the Financial Product in annualized terms related to Reference Value in 07150 or 07155 respectively. These fees are included in total on going costs. Only applicable if the product has this feature. These fees are used by distributors to calculate their retrocession fees

**IncidentalCostsExAnte**

07140: Expressed as a % of NAV / Notional (or currency amount for Absolute quotation) of the Financial Product in annualized terms related to Reference Value in 07150 or 07155 respectively.

**ReferencePrice**

07150: The Notional Reference Amount is the amount expressed in number of currency units to which a Unit disclosed Ex-Post cost is based and to which a Percentage disclosed cost should be multiplied in order to retrieve the Unit cost. This field is conditional and only used if 07150 is not used.

**NotionalReferenceAmount**

07155: Expressed as a % of NAV / Notional (or currency amount for Absolute quotation) of the Financial Product in annualized terms related to Reference Value in 07150 or 07155 respectively.

|            |   |
|------------|---|
| properties | isRef 0<br>content complex  |
| children   | <a href="#">GrossMaxEntryCostNonAcquired</a> <a href="#">NetEntryCostNonAcquired</a> <a href="#">TypicalExitCost</a> <a href="#">ExitCostPriorRHP</a> <a href="#">OngoingCosts</a> <a href="#">ManagementFee</a> <a href="#">IncidentalCostsExAnte</a> <a href="#">ReferencePrice</a> <a href="#">NotionalReferenceAmount</a> |
| annotation | documentation<br>Relevant fields for structured securities  |

element

**EMT\_V4\_FinancialInstrumentType/CostsAndChargesExAnte/StructuredSecurity/GrossMaxEntryCostNonAcquired**

|            |   |
|------------|---|
| diagram    |  <p>07020:<br/>"Ask Price" - Fair Value ( as of Reference Date Ex-Ante ).<br/>This data should only incorporate manufacturer costs (i.e. cost of the financial instrument) and distributor upfront when known by the manufacturer. It should however NOT include distribution fees added on top of the product price by distributors that is out of control of the manufacturer.</p> |
| type       | <b>xs:decimal</b>   |
| properties | isRef 0<br>content simple   |
| annotation | documentation<br>07020:<br>"Ask Price" - Fair Value ( as of Reference Date Ex-Ante ).<br>This data should only incorporate manufacturer costs (i.e. cost of the financial instrument) and distributor upfront when known by the manufacturer. It should however NOT include distribution fees added on top of the product price by distributors that is out of control of the manufacturer.   |

element

**EMT\_V4\_FinancialInstrumentType/CostsAndChargesExAnte/StructuredSecurity/NetEntryCostNonAcquired**

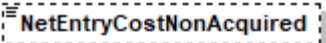
|            |   |
|------------|---|
| diagram    |  <p>07025: Net_One-off Entry cost = 07020 less upfront distribution fee embedded in the 07020. In practice 07025 will be the portion of the 07020 retained by the manufacturer. This data is optional and could be used in the event of only one layer of intermediation or in a case where distributor up fronts are paid equally to all distributors. The costs reported in this field is a Net disclosure and therefore the distributor upfront is equal to the difference between 07020 and 07025.</p> |
| type       | <b>xs:decimal</b>   |
| properties | isRef 0<br>minOcc 0<br>maxOcc 1<br>content simple   |
| annotation | documentation<br>07025: Net_One-off Entry cost = 07020 less upfront distribution fee embedded in the 07020. In practice 07025 will be the portion of the 07020 retained by the manufacturer.<br>This data is optional and could be used in the event of only one layer of intermediation or in a case where distributor up  |

|  |   |
|--|---|
|  | fronts are paid equally to all distributors. The costs reported in this field is a Net disclosure and therefore the distributor upfront is equal to the difference between 07020 and 07025. |
|--|---|

element

**EMT\_V4\_FinancialInstrumentType/CostsAndChargesExAnte/StructuredSecurity/TypicalExitCost**

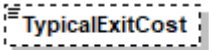
|            |  |
|------------|--|
| diagram    |  <p>07080: Exit cost at the RHP</p> |
| type       | <b>xs:decimal</b>  |
| properties | isRef 0<br>minOcc 0<br>maxOcc 1<br>content simple  |
| annotation | documentation<br>07080: Exit cost at the RHP   |

element

**EMT\_V4\_FinancialInstrumentType/CostsAndChargesExAnte/StructuredSecurity/ExitCostPriorRHP**

|            |  |
|------------|--|
| diagram    |  <p>07090: Fixed amount</p> |
| type       | <b>xs:decimal</b>  |
| properties | isRef 0<br>content simple  |
| annotation | documentation<br>07090: Fixed amount   |

element **EMT\_V4\_FinancialInstrumentType/CostsAndChargesExAnte/StructuredSecurity/OngoingCosts**

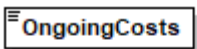
|            |  |
|------------|--|
| diagram    |  <p>07100: Expressed as a % of NAV / Notional (or currency amount for Absolute quotation) of the Financial Product in annualized terms related to Reference in 07150 or 07155 respectively.</p> |
| type       | <b>xs:decimal</b>  |
| properties | isRef 0<br>content simple  |
| annotation | documentation<br>07100: Expressed as a % of NAV / Notional (or currency amount for Absolute quotation) of the Financial Product in annualized terms related to Reference in 07150 or 07155 respectively.   |

element

**EMT\_V4\_FinancialInstrumentType/CostsAndChargesExAnte/StructuredSecurity/ManagementFee**

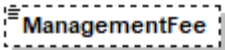
|            |   |
|------------|---|
| diagram    |  <p>07110: Expressed as a % of NAV / Notional (or currency amount for Absolute quotation) of the Financial Product in annualized terms related to Reference Value in 07150 or 07155 respectively. These fees are included in total on going costs. Only applicable if the product has this feature. These fees are used by distributors to calculate their retrocession fees</p> |
| type       | <b>xs:decimal</b>   |
| properties | isRef 0<br>minOcc 0<br>maxOcc 1<br>content simple   |
| annotation | documentation<br>07110: Expressed as a % of NAV / Notional (or currency amount for Absolute quotation) of the Financial Product in annualized terms related to Reference Value in 07150 or 07155 respectively. These fees are included in total on going costs. Only applicable if the product has this feature. These fees are used by distributors to calculate their retrocession fees   |

element

**EMT\_V4\_FinancialInstrumentType/CostsAndChargesExAnte/StructuredSecurity/IncidentalCostsExAnte**

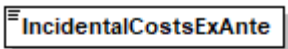
|            |  |
|------------|--|
| diagram    |  <p>07140: Expressed as a % of NAV / Notional (or currency amount for Absolute quotation) of the Financial Product in annualized terms related to Reference Value in 07150 or 07155 respectively.</p> |
| type       | restriction of <b>xs:decimal</b>   |
| properties | isRef 0<br>content simple  |
| annotation | documentation<br>07140: Expressed as a % of NAV / Notional (or currency amount for Absolute quotation) of the Financial Product in annualized terms related to Reference Value in 07150 or 07155 respectively.   |

element

**EMT\_V4\_FinancialInstrumentType/CostsAndChargesExAnte/StructuredSecurity/ReferencePrice**

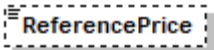
|            |   |
|------------|---|
| diagram    |  <p>07150: The Notional Reference Amount is the amount expressed in number of currency units to which a Unit disclosed Ex-Post cost is based and to which a Percentage disclosed cost should be multiplied in order to retrieve the Unit cost. This field is conditional and only used if 07150 is not used.</p> |
| type       | <b>xs:decimal</b>   |
| properties | isRef 0<br>minOcc 0<br>maxOcc 1<br>content simple   |
| annotation | documentation<br>07150: The Notional Reference Amount is the amount expressed in number of currency units to which a Unit disclosed Ex-Post cost is based and to which a Percentage disclosed cost should be multiplied in order to retrieve the Unit cost. This field is conditional and only used if 07150 is not used.   |

element

**EMT\_V4\_FinancialInstrumentType/CostsAndChargesExAnte/StructuredSecurity/NotionalReferenceAmount**

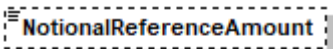
|            |  |
|------------|--|
| diagram    |  <p>07155: Expressed as a % of NAV / Notional (or currency amount for Absolute quotation) of the Financial Product in annualized terms related to Reference Value in 07150 or 07155 respectively.</p> |
| type       | <b>xs:decimal</b>  |
| properties | isRef 0<br>minOcc 0<br>maxOcc 1<br>content simple  |
| annotation | documentation<br>07155: Expressed as a % of NAV / Notional (or currency amount for Absolute quotation) of the Financial Product in annualized terms related to Reference Value in 07150 or 07155 respectively.   |

element **EMT\_V4\_FinancialInstrumentType/CostsAndChargesExAnte/CostsReferenceDate**

|            |   |
|------------|---|
| diagram    |  <p>07160 : The Reference Date to which all Ex-Ante Cost disclosures refer (i.e NOT to be mistaken for General Reference Date, field 00050 or Generation Date and Time, field 00005)</p> |
| type       | <b>xs:date</b>  |
| properties | isRef 0   |

|            |   |
|------------|---|
|            | content simple  |
| annotation | documentation<br>07160 : The Reference Date to which all Ex-Ante Cost disclosures refer (i.e NOT to be mistaken for General Reference Date, field 00050 or Generation Date and Time, field 00005) |

element **EMT\_V4\_FinancialInstrumentType/CostsAndChargesExPost**

|            |   |
|------------|---|
| diagram    | <p><b>CostsAndChargesExPost</b><br/>Costs and Charges ex post</p> <p><b>Fund</b><br/>Relevant fields for funds</p> <p><b>StructuredSecurity</b><br/>Relevant fields for structured securities</p> <p><b>ReferencePeriod</b></p> |
| properties | isRef 0<br>minOcc 0<br>maxOcc 1<br>content complex  |
| children   | <a href="#">Fund</a> <a href="#">StructuredSecurity</a> <a href="#">ReferencePeriod</a>   |
| annotation | documentation<br>Costs and Charges ex post  |

element **EMT\_V4\_FinancialInstrumentType/CostsAndChargesExPost/Fund**

|                   |   |
|-------------------|---|
| <p>diagram</p>    | <p><b>Fund</b><br/>Relevant fields for funds</p> <ul style="list-style-type: none"> <li><b>EntryCostAcquired</b><br/>08025: % of NAV</li> <li><b>OngoingCosts</b><br/>08030: % of NAV of the Financial Product expressed in annualized terms (rate of cost deduction to be applied)</li> <li><b>BorrowingCoststUK</b><br/>08045: Financing costs related to borrowing for the purposes of gearing expressed as a % of NAV of the Financial Product expressed in annualized terms (rate of cost deduction to be applied)</li> <li><b>ManagementFee</b><br/>08050: % of NAV of the Financial Product expressed in annualized terms (rate of cost deduction to be applied)</li> <li><b>DistributionFee</b><br/>08060: % of NAV of the Financial Product expressed in annualized terms (rate of cost deduction to be applied). Only applicable if the product has this feature (legal wording in the documentation). These fees are included in total on going costs and are not included into the management fees.</li> <li><b>TransactionCosts</b><br/>08070: % of NAV of the Financial Product expressed in annualized terms (rate of cost deduction to be applied). Costs within the products</li> <li><b>IncidentalCosts</b><br/>08080: Incidental costs ex post % of NAV of the Financial Product expressed in annualized terms (rate of cost deduction to be applied)</li> </ul> |
| <p>properties</p> | <p>isRef 0<br/>content complex</p>  |
| <p>children</p>   | <p><a href="#">EntryCostAcquired</a> <a href="#">OngoingCosts</a> <a href="#">BorrowingCoststUK</a> <a href="#">ManagementFee</a> <a href="#">DistributionFee</a> <a href="#">TransactionCosts</a> <a href="#">IncidentalCosts</a></p>  |
| <p>annotation</p> | <p>documentation<br/>Relevant fields for funds</p>  |

element **EMT\_V4\_FinancialInstrumentType/CostsAndChargesExPost/Fund/EntryCostAcquired**

|            |  |
|------------|--|
| diagram    |  <p>08025:<br/>% of NAV</p> |
| type       | restriction of <b>xs:decimal</b>   |
| properties | isRef 0<br>minOcc 0<br>maxOcc 1<br>content simple  |
| annotation | documentation<br>08025:<br>% of NAV  |

element **EMT\_V4\_FinancialInstrumentType/CostsAndChargesExPost/Fund/OngoingCosts**

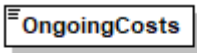
|            |  |
|------------|--|
| diagram    |  <p>08030: % of NAV of the Financial Product expressed in annualized terms (rate of cost deduction to be applied)</p> |
| type       | <b>xs:decimal</b>  |
| properties | isRef 0<br>content simple  |
| annotation | documentation<br>08030: % of NAV of the Financial Product expressed in annualized terms (rate of cost deduction to be applied)   |

element **EMT\_V4\_FinancialInstrumentType/CostsAndChargesExPost/Fund/BorrowingCoststUK**

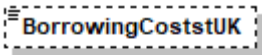
|            |  |
|------------|--|
| diagram    |  <p>08045: Financing costs related to borrowing for the purposes of gearing expressed as a % of NAV of the Financial Product expressed in annualized terms (rate of cost deduction to be applied)</p> |
| type       | <b>xs:decimal</b>  |
| properties | isRef 0<br>minOcc 0<br>maxOcc 1<br>content simple  |
| annotation | documentation<br>08045: Financing costs related to borrowing for the purposes of gearing expressed as a % of NAV of the Financial Product expressed in annualized terms (rate of cost deduction to be applied)   |



element **EMT\_V4\_FinancialInstrumentType/CostsAndChargesExPost/Fund/ManagementFee**

|            |   |
|------------|---|
| diagram    |  <b>ManagementFee</b><br>08050: % of NAV of the Financial Product expressed in annualized terms (rate of cost deduction to be applied) |
| type       | <b>xs:decimal</b>   |
| properties | isRef 0<br>content simple   |
| annotation | documentation<br>08050: % of NAV of the Financial Product expressed in annualized terms (rate of cost deduction to be applied)  |

element **EMT\_V4\_FinancialInstrumentType/CostsAndChargesExPost/Fund/DistributionFee**

|            |  |
|------------|--|
| diagram    |  <b>DistributionFee</b><br>08060:<br>% of NAV of the Financial Product expressed in annualized terms (rate of cost deduction to be applied). Only applicable if the product has this feature (legal wording in the documentation). These fees are included in total on going costs and are not included into the management fees. |
| type       | <b>xs:decimal</b>  |
| properties | isRef 0<br>minOcc 0<br>maxOcc 1<br>content simple  |
| annotation | documentation<br>08060:<br>% of NAV of the Financial Product expressed in annualized terms (rate of cost deduction to be applied). Only applicable if the product has this feature (legal wording in the documentation). These fees are included in total on going costs and are not included into the management fees.  |

element **EMT\_V4\_FinancialInstrumentType/CostsAndChargesExPost/Fund/TransactionCosts**

|            |   |
|------------|---|
| diagram    |  <b>TransactionCosts</b><br>08070: % of NAV of the Financial Product expressed in annualized terms (rate of cost deduction to be applied). Costs within the products |
| type       | <b>xs:decimal</b>   |
| properties | isRef 0<br>content simple   |
| annotation | documentation<br>08070: % of NAV of the Financial Product expressed in annualized terms (rate of cost deduction to be applied). Costs within the products   |

element **EMT\_V4\_FinancialInstrumentType/CostsAndChargesExPost/Fund/IncidentalCosts**

|                   |   |
|-------------------|---|
| <p>diagram</p>    |  <p>08080: Incidental costs ex post<br/>% of NAV of the Financial Product expressed in annualized terms (rate of cost deduction to be applied)</p> |
| <p>type</p>       | <p><b>xs:decimal</b></p>  |
| <p>properties</p> | <p>isRef 0<br/>content simple</p>   |
| <p>annotation</p> | <p>documentation<br/>08080: Incidental costs ex post<br/>% of NAV of the Financial Product expressed in annualized terms (rate of cost deduction to be applied)</p>   |

element **EMT\_V4\_FinancialInstrumentType/CostsAndChargesExPost/StructuredSecurity**

diagram

**StructuredSecurity**  
Relevant fields for structured securities

**GrossEntryCost**  
08010: This data should only incorporate manufacturer costs (i.e. cost of the financial instrument) and distributor upfront when known by the manufacturer. It should however NOT include distribution fees added on top of the product price by distributors that is out of control of the manufacturer.

**NetEntryCost**  
08015: Net one off entry cost ex post.  
Net One-off Entry cost = 08010 less upfront distribution fee embedded in the 08010. In practice 08015 will be the portion of the 08010 retained by the manufacturer.  
This data is optional and could be used in the event of only one layer of intermediation or in a case where distributor up fronts are paid equally to all distributors. The costs reported in this field is a Net disclosure and therefore the distributor upfront is equal to the difference between 08010 and 08025.

**ExitCost**  
08020:  
Fixed amount  
If 00096 set to U : number of units in product currency  
If 00096 set to P : % of Reference in field 08110 or 08120 respectively.  
This exit cost is supposed to be prior RHP

**OngoingCosts**  
08030: Expressed as a % of NAV / Notional (or currency amount for Absolute quotation) of the Financial Product in annualized terms related to Reference Value in 08110

**OngoingCostsAccumulated**  
08040: Sum of each daily Recurring Product Costs  
Presented in absolute figures in product currency accumulated during the year up until the End of Reference Date Period. Ex Post in field 08100.  
Mandatory field for Distribution in Germany, Switzerland and Austria

**ManagementFee**  
08050: Expressed as a % of NAV / Notional (or currency amount for Absolute quotation) of the Financial Product in annualized terms related to Reference Value in 08110.  
These fees are included in total on going costs. Only applicable if the product has this feature. These fees are used by distributors to calculate their retrocession fees

**IncidentalCosts**  
08080: Expressed as a % of NAV / Notional (or currency amount for Absolute quotation) of the Financial Product in annualized terms related to Reference Value in 08110  
If 00096 set to U : number of units in product currency  
If 00096 set to P : % of Reference in field 08110 or 08120 respectively.

**ReferencePrice**  
08110: The Reference Price is the instrument price to which a Unit disclosed Ex-Post cost is based and to which a Percentage disclosed cost should be multiplied in order to retrieve the Unit cost. This field is conditional and only used if 08120 is not used.

**NotionalReferenceAmount**  
080120: The Notional Reference Amount is the amount expressed in number of currency units to which a Unit disclosed Ex-Post cost is based and to which a Percentage disclosed cost should be multiplied in order to retrieve the Unit cost. This field is conditional and only used if 08110 is not used.

|            |  |
|------------|--|
| properties | isRef 0<br>content complex   |
| children   | <a href="#">GrossEntryCost</a> <a href="#">NetEntryCost</a> <a href="#">ExitCost</a> <a href="#">OngoingCosts</a> <a href="#">OngoingCostsAccumulated</a> <a href="#">ManagementFee</a> <a href="#">IncidentalCosts</a> <a href="#">ReferencePrice</a> <a href="#">NotionalReferenceAmount</a> |
| annotation | documentation<br>Relevant fields for structured securities   |

element

**EMT\_V4\_FinancialInstrumentType/CostsAndChargesExPost/StructuredSecurity/GrossEntryCost**

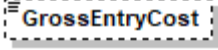
|            |  |
|------------|--|
| diagram    |  <p>08010: This data should only incorporate manufacturer costs (i.e. cost of the financial instrument) and distributor upfront when known by the manufacturer. It should however NOT include distribution fees added on top of the product price by distributors that is out of control of the manufacturer.</p> |
| type       | <b>xs:decimal</b>  |
| properties | isRef 0<br>minOcc 0<br>maxOcc 1<br>content simple  |
| annotation | documentation<br>08010: This data should only incorporate manufacturer costs (i.e. cost of the financial instrument) and distributor upfront when known by the manufacturer. It should however NOT include distribution fees added on top of the product price by distributors that is out of control of the manufacturer.   |

element **EMT\_V4\_FinancialInstrumentType/CostsAndChargesExPost/StructuredSecurity/NetEntryCost**

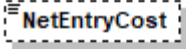
|            |  |
|------------|--|
| diagram    |  <p>08015: Net one off entry cost ex post<br/>Net One-off Entry cost = 08010 less upfront distribution fee embedded in the 08010. In practice 08015 will be the portion of the 08010 retained by the manufacturer.<br/>This data is optional and could be used in the event of only one layer of intermediation or in a case where distributor up fronts are paid equally to all distributors. The costs reported in this field is a Net disclosure and therefore the distributor upfront is equal to the difference between 08010 and 08025.</p> |
| type       | <b>xs:decimal</b>  |
| properties | isRef 0<br>minOcc 0<br>maxOcc 1<br>content simple  |

|            |   |
|------------|---|
| annotation | <p>documentation</p> <p>08015: Net one off entry cost ex post<br/> Net One-off Entry cost = 08010 less upfront distribution fee embedded in the 08010. In practice 08015 will be the portion of the 08010 retained by the manufacturer.</p> <p>This data is optional and could be used in the event of only one layer of intermediation or in a case where distributor up fronts are paid equally to all distributors. The costs reported in this field is a Net disclosure and therefore the distributor upfront is equal to the difference between 08010 and 08025.</p> |
|------------|---|

element **EMT\_V4\_FinancialInstrumentType/CostsAndChargesExPost/StructuredSecurity/ExitCost**

|            |  |
|------------|--|
| diagram    |  <p>08020:<br/> Fixed amount<br/> If 00096 set to U : number of units in product currency<br/> If 00096 set to P : % of Reference in field 08110 or 08120 respectively.<br/> This exit cost is supposed to be prior RHP</p> |
| type       | <b>xs:decimal</b>  |
| properties | isRef 0<br>minOcc 0<br>maxOcc 1<br>content simple  |
| annotation | <p>documentation</p> <p>08020:<br/> Fixed amount<br/> If 00096 set to U : number of units in product currency<br/> If 00096 set to P : % of Reference in field 08110 or 08120 respectively.<br/> This exit cost is supposed to be prior RHP</p>  |

element **EMT\_V4\_FinancialInstrumentType/CostsAndChargesExPost/StructuredSecurity/OngoingCosts**

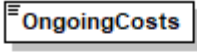
|            |   |
|------------|---|
| diagram    |  <p>08030: Expressed as a % of NAV / Notional (or currency amount for Absolute quotation) of the Financial Product in annualized terms related to Reference Value in 08110</p> |
| type       | <b>xs:decimal</b>   |
| properties | isRef 0<br>content simple   |
| annotation | <p>documentation</p> <p>08030: Expressed as a % of NAV / Notional (or currency amount for Absolute quotation) of the Financial Product in annualized terms related to Reference Value in 08110</p>  |

element

**EMT\_V4\_FinancialInstrumentType/CostsAndChargesExPost/StructuredSecurity/OngoingCostsAccumulated**

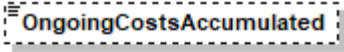
|            |  |
|------------|--|
| diagram    |  <p>08040: Sum of each daily Recurring Product Costs<br/>Presented in absolute figures in product currency accumulated during the year up until the End of Reference Date Period Ex Post in field 08100.<br/>Mandatory field for Distribution in Germany, Switzerland and Austria</p> |
| type       | <b>xs:decimal</b>  |
| properties | isRef 0<br>minOcc 0<br>maxOcc 1<br>content simple  |
| annotation | documentation<br>08040: Sum of each daily Recurring Product Costs<br>Presented in absolute figures in product currency accumulated during the year up until the End of Reference Date Period Ex Post in field 08100.<br>Mandatory field for Distribution in Germany, Switzerland and Austria   |

element

**EMT\_V4\_FinancialInstrumentType/CostsAndChargesExPost/StructuredSecurity/ManagementFee**

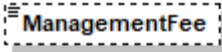
|            |  |
|------------|--|
| diagram    |  <p>08050: Expressed as a % of NAV / Notional (or currency amount for Absolute quotation) of the Financial Product in annualized terms related to Reference Value in 08110.<br/>These fees are included in total on going costs. Only applicable if the product has this feature. These fees are used by distributors to calculate their retrocession fees</p> |
| type       | <b>xs:decimal</b>  |
| properties | isRef 0<br>minOcc 0<br>maxOcc 1<br>content simple  |
| annotation | documentation<br>08050: Expressed as a % of NAV / Notional (or currency amount for Absolute quotation) of the Financial Product in annualized terms related to Reference Value in 08110.<br>These fees are included in total on going costs. Only applicable if the product has this feature. These fees are used by distributors to calculate their retrocession fees   |

element

**EMT\_V4 FinancialInstrumentType/CostsAndChargesExPost/StructuredSecurity/IncidentalCosts**

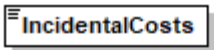
|            |  |
|------------|--|
| diagram    |  <p>08080: Expressed as a % of NAV / Notional (or currency amount for Absolute quotation) of the Financial Product in annualized terms related to Reference Value in 08110<br/>If 00096 set to U : number of units in product currency<br/>If 00096 set to P : % of Reference in field 08110 or 08120 respectively.</p> |
| type       | <b>xs:decimal</b>  |
| properties | isRef 0<br>content simple  |
| annotation | documentation<br>08080: Expressed as a % of NAV / Notional (or currency amount for Absolute quotation) of the Financial Product in annualized terms related to Reference Value in 08110<br>If 00096 set to U : number of units in product currency<br>If 00096 set to P : % of Reference in field 08110 or 08120 respectively.   |

element

**EMT\_V4 FinancialInstrumentType/CostsAndChargesExPost/StructuredSecurity/ReferencePrice**

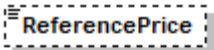
|            |  |
|------------|--|
| diagram    |  <p>08110: The Reference Price is the instrument price to which a Unit disclosed Ex-Post cost is based and to which a Percentage disclosed cost should be multiplied in order to retrieve the Unit cost. This field is conditional and only used if 08120 is not used.</p> |
| type       | <b>xs:decimal</b>  |
| properties | isRef 0<br>minOcc 0<br>maxOcc 1<br>content simple  |
| annotation | documentation<br>08110: The Reference Price is the instrument price to which a Unit disclosed Ex-Post cost is based and to which a Percentage disclosed cost should be multiplied in order to retrieve the Unit cost. This field is conditional and only used if 08120 is not used.  |



element

**EMT\_V4\_FinancialInstrumentType/CostsAndChargesExPost/StructuredSecurity/NotionalReferenceAmount**

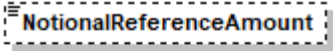
|            |  |
|------------|--|
| diagram    |  <p><b>NotionalReferenceAmount</b></p> <p>080120: The Notional Reference Amount is the amount expressed in number of currency units to which a Unit disclosed Ex-Post cost is based and to which a Percentage disclosed cost should be multiplied in order to retrieve the Unit cost. This field is conditional and only used if 08110 is not used.</p> |
| type       | <b>xs:decimal</b>  |
| properties | <p>isRef 0</p> <p>minOcc 0</p> <p>maxOcc 1</p> <p>content simple</p>   |
| annotation | <p>documentation</p> <p>080120: The Notional Reference Amount is the amount expressed in number of currency units to which a Unit disclosed Ex-Post cost is based and to which a Percentage disclosed cost should be multiplied in order to retrieve the Unit cost. This field is conditional and only used if 08110 is not used.</p>  |

element **EMT\_V4\_FinancialInstrumentType/CostsAndChargesExPost/ReferencePeriod**

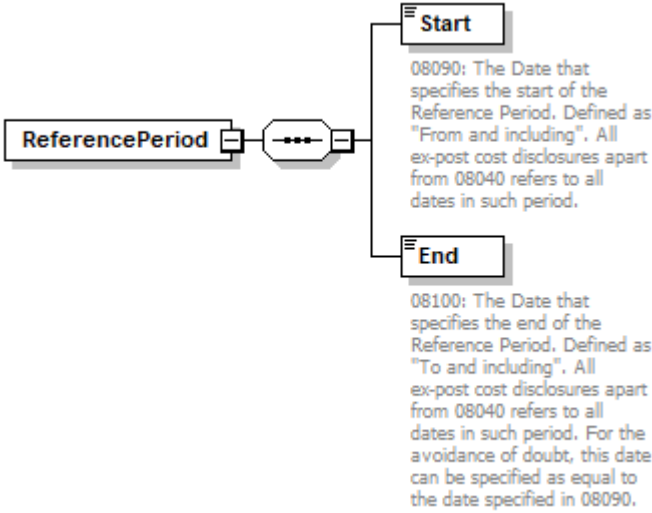
|            |  |
|------------|--|
| diagram    |  <p><b>ReferencePeriod</b></p> <p><b>Start</b></p> <p>08090: The Date that specifies the start of the Reference Period. Defined as "From and including". All ex-post cost disclosures apart from 08040 refers to all dates in such period.</p> <p><b>End</b></p> <p>08100: The Date that specifies the end of the Reference Period. Defined as "To and including". All ex-post cost disclosures apart from 08040 refers to all dates in such period. For the avoidance of doubt, this date can be specified as equal to the date specified in 08090.</p> |
| properties | <p>isRef 0</p> <p>content complex</p>  |
| children   | <a href="#">Start</a> <a href="#">End</a>  |

element **EMT\_V4\_FinancialInstrumentType/CostsAndChargesExPost/ReferencePeriod/Start**

|            |   |
|------------|---|
| diagram    |  <p>08090: The Date that specifies the start of the Reference Period. Defined as "From and including". All ex-post cost disclosures apart from 08040 refers to all dates in such period.</p> |
| type       | <b>xs:date</b>  |
| properties | isRef 0<br>content simple   |
| annotation | documentation<br>08090: The Date that specifies the start of the Reference Period. Defined as "From and including". All ex-post cost disclosures apart from 08040 refers to all dates in such period.   |

element **EMT\_V4\_FinancialInstrumentType/CostsAndChargesExPost/ReferencePeriod/End**

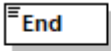
|            |   |
|------------|---|
| diagram    |  <p>08100: The Date that specifies the end of the Reference Period. Defined as "To and including". All ex-post cost disclosures apart from 08040 refers to all dates in such period. For the avoidance of doubt, this date can be specified as equal to the date specified in 08090.</p> |
| type       | <b>xs:date</b>  |
| properties | isRef 0<br>content simple   |
| annotation | documentation<br>08100: The Date that specifies the end of the Reference Period. Defined as "To and including". All ex-post cost disclosures apart from 08040 refers to all dates in such period. For the avoidance of doubt, this date can be specified as equal to the date specified in 08090.   |

element **EMT\_V4\_FinancialInstrumentType/CountrySpecificData**

|                   |  |
|-------------------|--|
| <p>diagram</p>    | <pre> classDiagram     class CountrySpecificData     class CountrySpecificEMTDataType     class AT     class DE     class DK     class FR     class LU     class NL      CountrySpecificData "1" *-- "1" CountrySpecificEMTDataType     CountrySpecificEMTDataType &lt; -- AT     CountrySpecificEMTDataType &lt; -- DE     CountrySpecificEMTDataType &lt; -- DK     CountrySpecificEMTDataType &lt; -- FR     CountrySpecificEMTDataType &lt; -- LU     CountrySpecificEMTDataType &lt; -- NL     </pre> |
| <p>type</p>       | <p><a href="#">CountrySpecificEMTDataType</a></p>  |
| <p>properties</p> | <p>isRef 0<br/> minOcc 0<br/> maxOcc 1<br/> content complex</p>  |
| <p>children</p>   | <p><a href="#">AT</a> <a href="#">DE</a> <a href="#">DK</a> <a href="#">FR</a> <a href="#">LU</a> <a href="#">NL</a></p>   |

complexType **EMTFinancialInstrumentType**

|                 |  |
|-----------------|--|
| <p>diagram</p>  | <p><b>FundOrShareClassIdentifiers</b> </p> <p>Fund or share class identifiers for easy connection to other fund or share class data</p> <p><b>DataSupplier</b> </p> <p>Definition of data source (investment company, vendor, ...)</p> <p><b>GeneralInformation</b> </p> <p>General Financial Instrument Information</p> <p><b>InvestorType</b> </p> <p>Target markets - Investor Type</p> <p><b>KnowledgeAndExperience</b> </p> <p>Target markets - Knowledge and/or Experience</p> <p><b>AbilityToBearLosses</b> </p> <p>Target markets - Ability To Bear Losses</p> <p><b>RiskTolerance</b> </p> <p>Target markets - Risk Tolerance</p> <p><b>ClientObjectives</b> </p> <p>Target markets - Client Objectives and Needs</p> <p><b>DistributionStrategy</b> </p> <p>Distribution Strategy</p> <p><b>CostsAndChargesExAnte</b> </p> <p>Costs and Charges ex ante</p> <p><b>CostsAndChargesExPost</b> </p> <p>Costs and Charges ex post</p> <p><b>CountrySpecificData</b> </p> |
| <p>children</p> | <p><a href="#">FundOrShareClassIdentifiers</a> <a href="#">DataSupplier</a> <a href="#">GeneralInformation</a> <a href="#">InvestorType</a> <a href="#">KnowledgeAndExperience</a> <a href="#">AbilityToBearLosses</a> <a href="#">RiskTolerance</a> <a href="#">ClientObjectives</a> <a href="#">DistributionStrategy</a> <a href="#">CostsAndChargesExAnte</a> <a href="#">CostsAndChargesExPost</a> <a href="#">CountrySpecificData</a></p>   |
| <p>used by</p>  | <p>element <a href="#">EMTType/FinancialInstrument</a></p>   |

element **EMTFinancialInstrumentType/FundOrShareClassIdentifiers**

|            |  |
|------------|--|
| diagram    |  |
| type       | <a href="#">FundOrShareClassIdentifiersType</a>  |
| properties | isRef 0<br>minOcc 0<br>maxOcc 1<br>content complex   |
| children   | <a href="#">LEI</a> <a href="#">ISINs</a>  |
| annotation | documentation<br>Fund or share class identifiers for easy connection to other fund or share class data |

element **EMTFinancialInstrumentType/DataSupplier**

|            |   |
|------------|---|
| diagram    |   |
| type       | <a href="#">DataSupplierType</a>  |
| properties | isRef 0<br>minOcc 0<br>maxOcc 1<br>content complex  |
| children   | <a href="#">SystemCountry</a> <a href="#">Short</a> <a href="#">Name</a> <a href="#">Type</a> <a href="#">Contact</a> |
| annotation | documentation<br>Definition of data source (investment company, vendor, ...)  |



element **EMTFinancialInstrumentType/GeneralInformation**

diagram

**GeneralInformation**  
 General Financial Instrument  
 Information

**Code**

00010: Use the following priority:  
 - ISO 6166 code of ISIN when available  
 - Other recognised codes (e.g.: CUSIP, Bloomberg Ticker, Reuters RIC)  
 - Code attributed by the undertaking, when the options above are not available. Code must be unique and kept consistent over time.

**CodificationSystem**

00020: Codification system used.  
 Integer corresponding to the following closed list:  
 1 - ISO 6166 for ISIN code  
 2 - CUSIP (The Committee on Uniform Securities Identification Procedures number assigned by the CUSIP Service Bureau for U.S. and Canadian companies)  
 3 - SEDOL (Stock Exchange Daily Official List for the London Stock Exchange)  
 4 - WKN (Wertpapier Kenn-Nummer, the alphanumeric German identification number)  
 5 - Bloomberg Ticker (Bloomberg letters code that identify a company's securities)  
 6 - BBGID (The Bloomberg Global ID)  
 7 - Reuters RIC (Reuters instrument code)  
 8 - FIGI (Financial Instrument Global Identifier)  
 9 - Other code by members of the Association of National Numbering Agencies  
 99 - Code attributed by the undertaking

**InstrumentName**

00030: Name of the financial instrument

**InstrumentCurrency**

00040: Denomination currency of the financial instrument

**ReportingDate**

00050: Date to which the data refer

**LegalStructure**

00060: Structured Securities or Structured Funds or UCITS or Non UCITS

**IssuerName**

00070: Name of issuer of the financial instrument. The one who is responsible for the financial instrument management/issuance

**GuarantorName**

00080: Name of guarantor of the financial instrument.

**ProductCategoryNature**

00090: Designation of the respective product category or nature

**LeveragedOrContingentLiability**

00100: To enable reporting on the depreciation of leveraged financial instruments or contingent liability transactions in accordance with Art. 62 of the MIFID II's Delegated Regulation

|            |  |
|------------|--|
| properties | isRef 0<br>content complex   |
| children   | <a href="#">Code</a> <a href="#">CodificationSystem</a> <a href="#">InstrumentName</a> <a href="#">InstrumentCurrency</a> <a href="#">ReportingDate</a> <a href="#">LegalStructure</a> <a href="#">IssuerName</a> <a href="#">GuarantorName</a> <a href="#">ProductCategoryNature</a> <a href="#">LeveragedOrContingentLiability</a> |
| annotation | documentation<br>General Financial Instrument Information  |

element **EMTFinancialInstrumentType/GeneralInformation/Code**

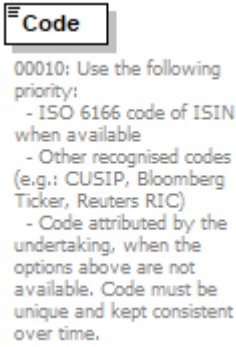
|            |   |
|------------|---|
| diagram    |  <p>00010: Use the following priority:</p> <ul style="list-style-type: none"> <li>- ISO 6166 code of ISIN when available</li> <li>- Other recognised codes (e.g.: CUSIP, Bloomberg Ticker, Reuters RIC)</li> <li>- Code attributed by the undertaking, when the options above are not available. Code must be unique and kept consistent over time.</li> </ul> |
| type       | restriction of <b>xs:string</b>   |
| properties | isRef 0<br>content simple   |
| facets     | Kind Value annotation<br>maxLength 255  |
| annotation | documentation<br>00010: Use the following priority:   |

00010: Use the following priority:

- ISO 6166 code of ISIN when available
- Other recognised codes (e.g.: CUSIP, Bloomberg Ticker, Reuters RIC)
- Code attributed by the undertaking, when the options above are not available. Code must be unique and kept consistent over time.

00010: Use the following priority:

- ISO 6166 code of ISIN when available
- Other recognised codes (e.g.: CUSIP, Bloomberg Ticker, Reuters RIC)
- Code attributed by the undertaking, when the options above are not available. Code must be unique and kept consistent over time.



element **EMTFinancialInstrumentType/GeneralInformation/CodificationSystem**

|                   |  |            |       |            |              |   |  |              |    |  |
|-------------------|--|------------|-------|------------|--------------|---|--|--------------|----|--|
| <p>diagram</p>    | <div style="border: 1px solid black; padding: 5px; margin-bottom: 10px;"> <b>CodificationSystem</b> </div> <p>00020: Codification system used.<br/> Integer corresponding to the following closed list:<br/> 1 - ISO 6166 for ISIN code<br/> 2 - CUSIP (The Committee on Uniform Securities Identification Procedures number assigned by the CUSIP Service Bureau for U.S. and Canadian companies)<br/> 3 - SEDOL (Stock Exchange Daily Official List for the London Stock Exchange)<br/> 4 - WKN (Wertpapier Kenn-Nummer, the alphanumeric German identification number)<br/> 5 - Bloomberg Ticker (Bloomberg letters code that identify a company's securities)<br/> 6 - BBGID (The Bloomberg Global ID)<br/> 7 - Reuters RIC (Reuters instrument code)<br/> 8 - FIGI (Financial Instrument Global Identifier)<br/> 9 - Other code by members of the Association of National Numbering Agencies<br/> 99 - Code attributed by the undertaking</p> |            |       |            |              |   |  |              |    |  |
| <p>type</p>       | <p>restriction of <b>xs:short</b></p>  |            |       |            |              |   |  |              |    |  |
| <p>properties</p> | <p>isRef 0<br/> content simple</p>   |            |       |            |              |   |  |              |    |  |
| <p>facets</p>     | <table border="0"> <tr> <td>Kind</td> <td>Value</td> <td>annotation</td> </tr> <tr> <td>minInclusive</td> <td>1</td> <td></td> </tr> <tr> <td>maxInclusive</td> <td>99</td> <td></td> </tr> </table>   | Kind       | Value | annotation | minInclusive | 1 |  | maxInclusive | 99 |  |
| Kind              | Value  | annotation |       |            |              |   |  |              |    |  |
| minInclusive      | 1  |            |       |            |              |   |  |              |    |  |
| maxInclusive      | 99   |            |       |            |              |   |  |              |    |  |
| <p>annotation</p> | <p>documentation<br/> 00020: Codification system used.<br/> Integer corresponding to the following closed list:<br/> 1 - ISO 6166 for ISIN code<br/> 2 - CUSIP (The Committee on Uniform Securities Identification Procedures number assigned by the CUSIP Service Bureau for U.S. and Canadian companies)<br/> 3 - SEDOL (Stock Exchange Daily Official List for the London Stock Exchange)<br/> 4 - WKN (Wertpapier Kenn-Nummer, the alphanumeric German identification number)<br/> 5 - Bloomberg Ticker (Bloomberg letters code that identify a company's securities)<br/> 6 - BBGID (The Bloomberg Global ID)<br/> 7 - Reuters RIC (Reuters instrument code)<br/> 8 - FIGI (Financial Instrument Global Identifier)<br/> 9 - Other code by members of the Association of National Numbering Agencies<br/> 99 - Code attributed by the undertaking</p>   |            |       |            |              |   |  |              |    |  |

element **EMTFinancialInstrumentType/GeneralInformation/InstrumentName**

|                |   |
|----------------|---|
| <p>diagram</p> | <div style="border: 1px solid black; padding: 5px; margin-bottom: 10px;"> <b>InstrumentName</b> </div> <p>00030: Name of the financial instrument</p> |
|----------------|---|

|            |  |
|------------|--|
| type       | restriction of <b>xs:string</b>                          |
| properties | isRef 0<br>content simple                                |
| facets     | Kind Value annotation<br>maxLength 255                   |
| annotation | documentation<br>00030: Name of the financial instrument |

element **EMTFinancialInstrumentType/GeneralInformation/InstrumentCurrency**

|            |   |
|------------|---|
| diagram    |  <p>00040: Denomination<br/>currency of the financial<br/>instrument</p> |
| type       | <a href="#">ISOCurrencyCodeType</a>   |
| properties | isRef 0<br>content simple   |
| facets     | Kind Value annotation<br>minLength 3<br>maxLength 3<br>pattern [A-Z]{3}   |
| annotation | documentation<br>00040: Denomination currency of the financial instrument   |

element **EMTFinancialInstrumentType/GeneralInformation/ReportingDate**

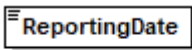
|            |  |
|------------|--|
| diagram    |  <p>00050: Date to which the<br/>data refer</p> |
| type       | <b>xs:date</b>   |
| properties | isRef 0<br>content simple  |
| annotation | documentation<br>00050: Date to which the data refer   |

element **EMTFinancialInstrumentType/GeneralInformation/LegalStructure**

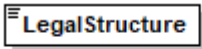
|            |   |
|------------|---|
| diagram    |  <p>00060: Structured Securities<br/>or Structured Funds or<br/>UCITS or Non UCITS</p> |
| type       | restriction of <b>xs:string</b>   |
| properties | isRef 0<br>content simple   |
| facets     | Kind Value annotation<br>minLength 1<br>maxLength 2   |
| annotation | documentation<br>00060: Structured Securities or Structured Funds or UCITS or Non UCITS   |

element **EMTFinancialInstrumentType/GeneralInformation/IssuerName**

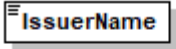
|            |   |
|------------|---|
| diagram    |  <p>00070: Name of Issuer of the financial instrument. The one who is responsible for the financial instrument management/issuance</p> |
| type       | restriction of <b>xs:string</b>   |
| properties | isRef 0<br>content simple   |
| facets     | Kind Value annotation<br>maxLength 255  |
| annotation | documentation<br>00070: Name of Issuer of the financial instrument. The one who is responsible for the financial instrument management/issuance   |

element **EMTFinancialInstrumentType/GeneralInformation/GuarantorName**

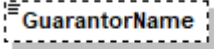
|            |  |
|------------|--|
| diagram    |  <p>00080: Name of guarantor of the financial instrument.</p> |
| type       | restriction of <b>xs:string</b>  |
| properties | isRef 0<br>minOcc 0<br>maxOcc 1<br>content simple  |
| facets     | Kind Value annotation<br>maxLength 255   |
| annotation | documentation<br>00080: Name of guarantor of the financial instrument.   |

element **EMTFinancialInstrumentType/GeneralInformation/ProductCategoryNature**

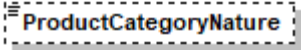
|            |  |
|------------|--|
| diagram    |  <p>00090: Designation of the respective product category or nature</p> |
| type       | restriction of <b>xs:string</b>  |
| properties | isRef 0<br>minOcc 0<br>maxOcc 1<br>content simple  |
| facets     | Kind Value annotation<br>maxLength 255   |
| annotation | documentation<br>00090: Designation of the respective product category or nature   |

element **EMTFinancialInstrumentType/GeneralInformation/LeveragedOrContingentLiability**

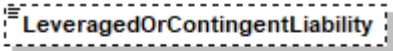
|            |   |
|------------|---|
| diagram    |  <p>00100: To enable reporting on the depreciation of leveraged financial instruments or contingent liability transactions in accordance with Art. 62 of the MiFID II's Delegated Regulation</p> |
| type       | <a href="#">EMTYesNoType</a>  |
| properties | isRef 0<br>minOcc 0<br>maxOcc 1<br>content simple   |
| facets     | Kind Value annotation<br>length 1   |
| annotation | documentation<br>00100: To enable reporting on the depreciation of leveraged financial instruments or contingent liability transactions in accordance with Art. 62 of the MiFID II's Delegated Regulation   |

element **EMTFinancialInstrumentType/InvestorType**

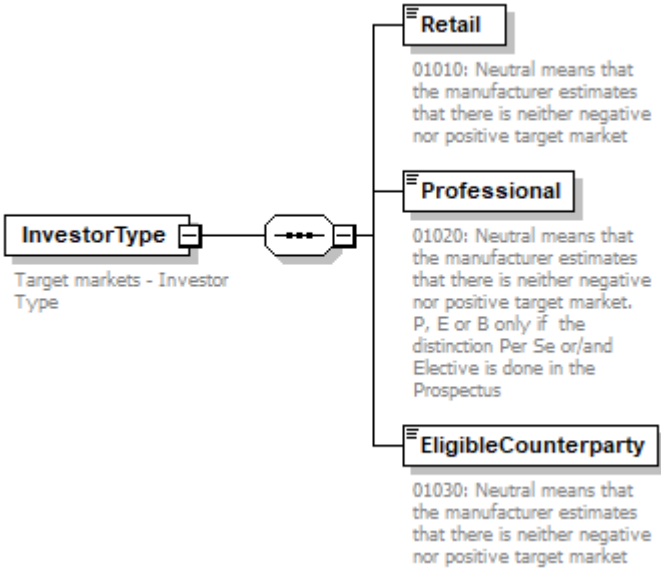
|            |  |
|------------|--|
| diagram    |  <p>Target markets - Investor Type</p> <p><b>Retail</b><br/>01010: Neutral means that the manufacturer estimates that there is neither negative nor positive target market</p> <p><b>Professional</b><br/>01020: Neutral means that the manufacturer estimates that there is neither negative nor positive target market. P, E or B only if the distinction Per Se or/and Elective is done in the Prospectus</p> <p><b>EligibleCounterparty</b><br/>01030: Neutral means that the manufacturer estimates that there is neither negative nor positive target market</p> |
| properties | isRef 0<br>content complex   |
| children   | <a href="#">Retail</a> <a href="#">Professional</a> <a href="#">EligibleCounterparty</a>   |
| annotation | documentation<br>Target markets - Investor Type  |

element **EMTFinancialInstrumentType/InvestorType/Retail**

|         |   |
|---------|---|
| diagram |  <p>01010: Neutral means that the manufacturer estimates that there is neither negative nor positive target market</p> |
| type    | <a href="#">EMTYesNoNeutralType</a>   |

|            |   |
|------------|---|
| properties | isRef 0<br>content simple   |
| facets     | Kind Value annotation<br>minLength 1<br>maxLength 7   |
| annotation | documentation<br>01010: Neutral means that the manufacturer estimates that there is neither negative nor positive target market |

element **EMTFinancialInstrumentType/InvestorType/Professional**

|            |   |
|------------|---|
| diagram    |  <p>01020: Neutral means that the manufacturer estimates that there is neither negative nor positive target market. P, E or B only if the distinction Per Se or/and Elective is done in the Prospectus</p> |
| type       | restriction of <b>xs:string</b>   |
| properties | isRef 0<br>content simple   |
| annotation | documentation<br>01020: Neutral means that the manufacturer estimates that there is neither negative nor positive target market. P, E or B only if the distinction Per Se or/and Elective is done in the Prospectus   |

element **EMTFinancialInstrumentType/InvestorType/EligibleCounterparty**

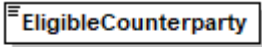
|            |   |
|------------|---|
| diagram    |  <p>01030: Neutral means that the manufacturer estimates that there is neither negative nor positive target market</p> |
| type       | <a href="#">EMTYesNoNeutralType</a>   |
| properties | isRef 0<br>content simple   |
| facets     | Kind Value annotation<br>minLength 1<br>maxLength 7   |
| annotation | documentation<br>01030: Neutral means that the manufacturer estimates that there is neither negative nor positive target market   |

element **EMTFinancialInstrumentType/KnowledgeAndExperience**

|                   |  |
|-------------------|--|
| <p>diagram</p>    | <p><b>KnowledgeAndExperience</b><br/>Target markets - Knowledge and/or Experience</p> <p><b>BasicInvestor</b><br/>02010: Investors having the following characteristics:<br/> <ul style="list-style-type: none"> <li>• basic knowledge of relevant financial instruments (a basic investor can make an informed investment decision based on the regulated and authorised offering documentation or with the help of basic information provided by point of sale);</li> <li>• no financial industry experience, i.e. suited to a first time investor</li> </ul> </p> <p><b>InformedInvestor</b><br/>02020: Having one, or more, of the following characteristics:<br/> <ul style="list-style-type: none"> <li>• average knowledge of relevant financial products (an informed investor can make an informed investment decision based on the regulated and authorised offering documentation, together with knowledge and understanding of the specific factors/risks highlighted within them only)</li> <li>• some financial industry experience</li> </ul> </p> <p><b>AdvancedInvestor</b><br/>02030: Investors having one, or more, of the following characteristics:<br/> <ul style="list-style-type: none"> <li>• good knowledge of relevant financial products and transactions</li> <li>• financial industry experience or accompanied by professional investment advice or included in a discretionary portfolio service</li> </ul> </p> <p><b>ExpertInvestorGermany</b><br/>02040: Expert knowledge of and / or experience with highly specialised financial products (Regulatory requirement in Germany/ example: CFD/ the updated list will be provided by the DSGVO)</p> |
| <p>properties</p> | <p>isRef 0<br/>content complex</p>   |
| <p>children</p>   | <p><a href="#">BasicInvestor</a> <a href="#">InformedInvestor</a> <a href="#">AdvancedInvestor</a> <a href="#">ExpertInvestorGermany</a></p>   |
| <p>annotation</p> | <p>documentation<br/>Target markets - Knowledge and/or Experience</p>  |

element **EMTFinancialInstrumentType/KnowledgeAndExperience/BasicInvestor**

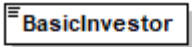
|            |   |
|------------|---|
| diagram    |  <p>02010: Investors having the following characteristics:</p> <ul style="list-style-type: none"> <li>• basic knowledge of relevant financial instruments (a basic investor can make an informed investment decision based on the regulated and authorised offering documentation or with the help of basic information provided by point of sale);</li> <li>• no financial industry experience, i.e. suited to a first time investor</li> </ul> |
| type       | <a href="#">EMTYesNoNeutralType</a>   |
| properties | isRef 0<br>content simple   |
| facets     | Kind Value annotation<br>minLength 1<br>maxLength 7   |
| annotation | documentation<br>02010: Investors having the following characteristics:<br><ul style="list-style-type: none"> <li>• basic knowledge of relevant financial instruments (a basic investor can make an informed investment decision based on the regulated and authorised offering documentation or with the help of basic information provided by point of sale);</li> <li>• no financial industry experience, i.e. suited to a first time investor</li> </ul>  |

element **EMTFinancialInstrumentType/KnowledgeAndExperience/InformedInvestor**

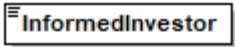
|            |  |
|------------|--|
| diagram    |  <p>02020: Having one, or more, of the following characteristics:</p> <ul style="list-style-type: none"> <li>• average knowledge of relevant financial products (an informed investor can make an informed investment decision based on the regulated and authorised offering documentation, together with knowledge and understanding of the specific factors/risks highlighted within them only)</li> <li>• some financial industry experience</li> </ul> |
| type       | <a href="#">EMTYesNoNeutralType</a>  |
| properties | isRef 0<br>content simple  |
| facets     | Kind Value annotation<br>minLength 1<br>maxLength 7  |
| annotation | documentation<br>02020: Having one, or more, of the following characteristics:<br><ul style="list-style-type: none"> <li>• average knowledge of relevant financial products (an informed investor can make an informed investment decision based on the regulated and authorised offering documentation, together with knowledge and understanding of the specific factors/risks highlighted within them only)</li> <li>• some financial industry experience</li> </ul>  |

element **EMTFinancialInstrumentType/KnowledgeAndExperience/AdvancedInvestor**

|            |  |
|------------|--|
| diagram    |  <p>02030: Investors having one, or more, of the following characteristics:</p> <ul style="list-style-type: none"> <li>• good knowledge of relevant financial products and transactions</li> <li>• financial industry experience or accompanied by professional investment advice or included in a discretionary portfolio service</li> </ul> |
| type       | <a href="#">EMTYesNoNeutralType</a>  |
| properties | isRef 0<br>content simple  |
| facets     | Kind Value annotation<br>minLength 1<br>maxLength 7  |
| annotation | documentation<br>02030: Investors having one, or more, of the following characteristics:<br><ul style="list-style-type: none"> <li>• good knowledge of relevant financial products and transactions</li> <li>• financial industry experience or accompanied by professional investment advice or included in a discretionary portfolio service</li> </ul>  |

element **EMTFinancialInstrumentType/KnowledgeAndExperience/ExpertInvestorGermany**

|            |  |
|------------|--|
| diagram    |  <p>02040: Expert knowledge of and / or experience with highly specialised financial products (Regulatory requirement in Germany/ example: CFD/ the updated list will be provided by the DSGVO)</p> |
| type       | <a href="#">EMTYesNoNeutralType</a>  |
| properties | isRef 0<br>minOcc 0<br>maxOcc 1<br>content simple  |
| facets     | Kind Value annotation<br>minLength 1<br>maxLength 7  |
| annotation | documentation<br>02040: Expert knowledge of and / or experience with highly specialised financial products (Regulatory requirement in Germany/ example: CFD/ the updated list will be provided by the DSGVO)   |



element **EMTFinancialInstrumentType/AbilityToBearLosses**

|            |  |
|------------|--|
| diagram    | <p>The diagram illustrates the composition of the <b>AbilityToBearLosses</b> element. It is composed of five sub-elements: <b>NoCapitalLoss</b>, <b>LimitedCapitalLoss</b>, <b>LimitedCapitalLossLevel</b>, <b>NoCapitalGuarantee</b>, and <b>LossBeyondCapital</b>. The <b>LimitedCapitalLossLevel</b> element is shown with a dashed border, indicating it is a derived or optional component. The main element is described as 'Target markets - Ability To Bear Losses'.</p> |
| properties | isRef 0<br>content complex   |
| children   | <a href="#">NoCapitalLoss</a> <a href="#">LimitedCapitalLoss</a> <a href="#">LimitedCapitalLossLevel</a> <a href="#">NoCapitalGuarantee</a> <a href="#">LossBeyondCapital</a>  |
| annotation | documentation<br>Target markets - Ability To Bear Losses   |

element **EMTFinancialInstrumentType/AbilityToBearLosses/NoCapitalLoss**

|            |   |
|------------|---|
| diagram    | <p>The diagram shows the <b>NoCapitalLoss</b> element with the text '03010: Investor can bear no loss of capital. Minor losses especially due to costs possible. Yes or No or Neutral'.</p> |
| type       | <a href="#">EMTYesNoNeutralType</a>   |
| properties | isRef 0<br>content simple   |
| facets     | Kind Value annotation<br>minLength 1<br>maxLength 7   |
| annotation | documentation<br>03010: Investor can bear no loss of capital. Minor losses especially due to costs possible. Yes or No or Neutral   |

element **EMTFinancialInstrumentType/AbilityToBearLosses/LimitedCapitalLoss**

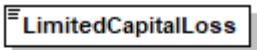
|            |  |
|------------|--|
| diagram    |  <p>03020: Investor seeking to preserve capital or can bear losses limited to a level specified by the product .<br/>Yes or No or Neutral</p> |
| type       | <a href="#">EMTYesNoNeutralType</a>  |
| properties | isRef 0<br>content simple  |
| facets     | Kind Value annotation<br>minLength 1<br>maxLength 7  |
| annotation | documentation<br>03020: Investor seeking to preserve capital or can bear losses limited to a level specified by the product .<br>Yes or No or Neutral  |

element **EMTFinancialInstrumentType/AbilityToBearLosses/LimitedCapitalLossLevel**

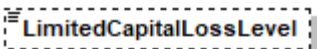
|            |  |
|------------|--|
| diagram    |  <p>03030: It is just for structured products or structured funds. To be used only when a clear partial capital guarantee is provided on the primary market and the product is held until maturity. The level of potential losses is the one that could be calculated according to the offering documentation</p> |
| type       | <a href="#">PercentageType</a>   |
| properties | isRef 0<br>minOcc 0<br>maxOcc 1<br>content simple  |
| annotation | documentation<br>03030: It is just for structured products or structured funds. To be used only when a clear partial capital guarantee is provided on the primary market and the product is held until maturity. The level of potential losses is the one that could be calculated according to the offering documentation   |

element **EMTFinancialInstrumentType/AbilityToBearLosses/NoCapitalGuarantee**

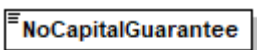
|            |   |
|------------|---|
| diagram    |  <p>03040: No Capital Guarantee nor protection. 100% capital at risk. Yes or No or Neutral</p> |
| type       | <a href="#">EMTYesNoNeutralType</a>   |
| properties | isRef 0<br>content simple   |
| facets     | Kind Value annotation<br>minLength 1<br>maxLength 7   |

|            |   |
|------------|---|
| annotation | documentation<br>03040: No Capital Guarantee nor protection. 100% capital at risk. Yes or No or Neutral |
|------------|---|

element **EMTFinancialInstrumentType/AbilityToBearLosses/LossBeyondCapital**

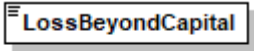
|            |  |
|------------|--|
| diagram    |  <p><b>LossBeyondCapital</b><br/>03050: Loss Beyond the Capital.<br/>Yes or No or Neutral</p> |
| type       | <a href="#">EMTYesNoNeutralType</a>  |
| properties | isRef 0<br>content simple  |
| facets     | Kind Value annotation<br>minLength 1<br>maxLength 7  |
| annotation | documentation<br>03050: Loss Beyond the Capital.<br>Yes or No or Neutral   |

element **EMTFinancialInstrumentType/RiskTolerance**

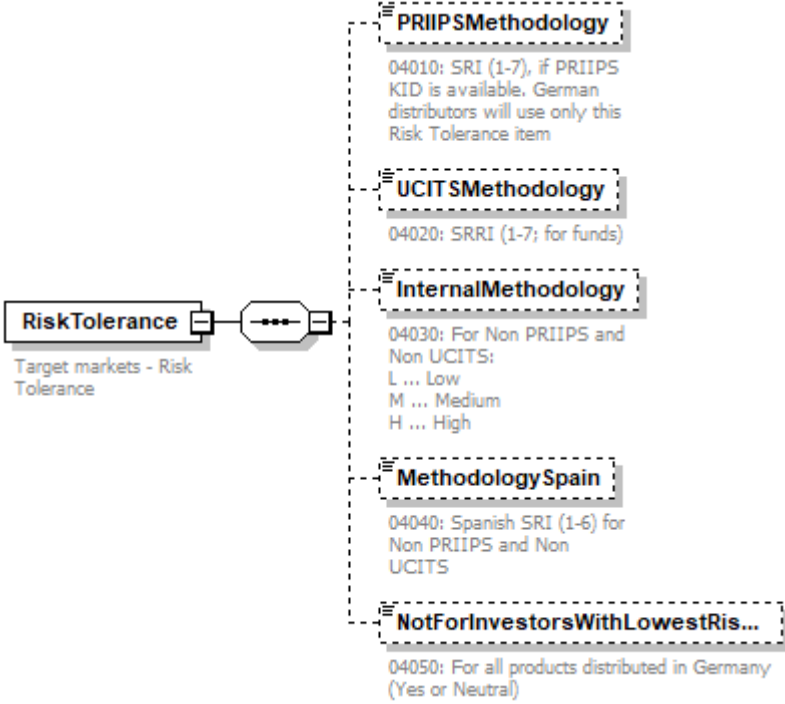
|            |  |
|------------|--|
| diagram    |  <p><b>RiskTolerance</b><br/>Target markets - Risk Tolerance</p> <ul style="list-style-type: none"> <li><b>PRIIPSMethodology</b><br/>04010: SRI (1-7), if PRIIPS KID is available. German distributors will use only this Risk Tolerance item</li> <li><b>UCITSMethodology</b><br/>04020: SRRI (1-7; for funds)</li> <li><b>InternalMethodology</b><br/>04030: For Non PRIIPS and Non UCITS;<br/>L ... Low<br/>M ... Medium<br/>H ... High</li> <li><b>Methodology Spain</b><br/>04040: Spanish SRI (1-6) for Non PRIIPS and Non UCITS</li> <li><b>NotForInvestorsWithLowestRis...</b><br/>04050: For all products distributed in Germany (Yes or Neutral)</li> </ul> |
| properties | isRef 0<br>content complex   |
| children   | <a href="#">PRIIPSMethodology</a> <a href="#">UCITSMethodology</a> <a href="#">InternalMethodology</a> <a href="#">MethodologySpain</a> <a href="#">NotForInvestorsWithLowestRiskToleranceGermany</a>  |
| annotation | documentation<br>Target markets - Risk Tolerance   |

element **EMTFinancialInstrumentType/RiskTolerance/PRIIPSMethodology**

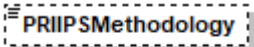
|            |   |
|------------|---|
| diagram    |  <p><b>PRIIPSMethodology</b></p> <p>04010: SRI (1-7), if PRIIPS KID is available. German distributors will use only this Risk Tolerance item</p> |
| type       | restriction of <b>xs:positiveInteger</b>  |
| properties | isRef 0<br>minOcc 0<br>maxOcc 1<br>content simple   |
| facets     | Kind Value annotation<br>minInclusive 1<br>maxInclusive 7   |
| annotation | documentation<br>04010: SRI (1-7), if PRIIPS KID is available. German distributors will use only this Risk Tolerance item   |

element **EMTFinancialInstrumentType/RiskTolerance/UCITSMethodology**

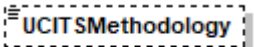
|            |  |
|------------|--|
| diagram    |  <p><b>UCITSMethodology</b></p> <p>04020: SRRI (1-7; for funds)</p> |
| type       | restriction of <b>xs:positiveInteger</b>   |
| properties | isRef 0<br>minOcc 0<br>maxOcc 1<br>content simple  |
| facets     | Kind Value annotation<br>minInclusive 1<br>maxInclusive 7  |
| annotation | documentation<br>04020: SRRI (1-7; for funds)  |

element **EMTFinancialInstrumentType/RiskTolerance/InternalMethodology**

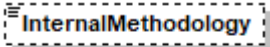
|            |  |
|------------|--|
| diagram    |  <p><b>InternalMethodology</b></p> <p>04030: For Non PRIIPS and Non UCITS:<br/>           L ... Low<br/>           M ... Medium<br/>           H ... High</p> |
| type       | restriction of <b>xs:string</b>  |
| properties | isRef 0<br>minOcc 0<br>maxOcc 1<br>content simple  |
| annotation | documentation<br>04030: For Non PRIIPS and Non UCITS:<br>L ... Low<br>M ... Medium<br>H ... High   |

element **EMTFinancialInstrumentType/RiskTolerance/MethodologySpain**

|            |  |
|------------|--|
| diagram    |  |
| type       | restriction of <b>xs:positiveInteger</b>                               |
| properties | isRef 0<br>minOcc 0<br>maxOcc 1<br>content simple                      |
| facets     | Kind Value annotation<br>minInclusive 1<br>maxInclusive 6              |
| annotation | documentation<br>04040: Spanish SRI (1-6) for Non PRIIPS and Non UCITS |

element **EMTFinancialInstrumentType/RiskTolerance/NotForInvestorsWithLowestRiskToleranceGermany**

|            |  |
|------------|--|
| diagram    |  |
| type       | restriction of <b>xs:string</b>  |
| properties | isRef 0<br>minOcc 0<br>maxOcc 1<br>content simple                                |
| annotation | documentation<br>04050: For all products distributed in Germany (Yes or Neutral) |

element **EMTFinancialInstrumentType/ClientObjectives**

|            |                            |
|------------|----------------------------|
| diagram    |                            |
| properties | isRef 0<br>content complex |

|            |  |
|------------|--|
| children   | <a href="#">ReturnProfile</a> <a href="#">TimeHorizon</a> <a href="#">MaturityDate</a> <a href="#">MaybeTerminatedEarly</a> <a href="#">SpecificInvestmentNeed</a> |
| annotation | documentation<br>Target markets - Client Objectives and Needs  |

element **EMTFinancialInstrumentType/ClientObjectives/ReturnProfile**

|            |   |
|------------|---|
| diagram    |   |
| properties | isRef 0<br>content complex  |
| children   | <a href="#">Preservation</a> <a href="#">Growth</a> <a href="#">Income</a> <a href="#">Hedging</a> <a href="#">OptionOrLeveraged</a> <a href="#">Other</a> <a href="#">PensionSchemeGermany</a> |

element **EMTFinancialInstrumentType/ClientObjectives/ReturnProfile/Preservation**

| diagram    |   |            |       |            |           |   |  |           |   |  |
|------------|---|------------|-------|------------|-----------|---|--|-----------|---|--|
| type       | <a href="#">EMTYesNoNeutralType</a>   |            |       |            |           |   |  |           |   |  |
| properties | isRef 0<br>content simple   |            |       |            |           |   |  |           |   |  |
| facets     | <table border="1"> <thead> <tr> <th>Kind</th> <th>Value</th> <th>annotation</th> </tr> </thead> <tbody> <tr> <td>minLength</td> <td>1</td> <td></td> </tr> <tr> <td>maxLength</td> <td>7</td> <td></td> </tr> </tbody> </table> | Kind       | Value | annotation | minLength | 1 |  | maxLength | 7 |  |
| Kind       | Value   | annotation |       |            |           |   |  |           |   |  |
| minLength  | 1   |            |       |            |           |   |  |           |   |  |
| maxLength  | 7   |            |       |            |           |   |  |           |   |  |
| annotation | documentation<br>05010: Yes or No or Neutral  |            |       |            |           |   |  |           |   |  |

element **EMTFinancialInstrumentType/ClientObjectives/ReturnProfile/Growth**

|         |  |
|---------|--|
| diagram |  |
|---------|--|

|            |   |
|------------|---|
| type       | <a href="#">EMTYesNoNeutralType</a>                 |
| properties | isRef 0<br>content simple                           |
| facets     | Kind Value annotation<br>minLength 1<br>maxLength 7 |
| annotation | documentation<br>05020: Yes or No or Neutral        |

element **EMTFinancialInstrumentType/ClientObjectives/ReturnProfile/Income**

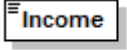
|            |  |
|------------|--|
| diagram    | <br>05030: Yes or No or Neutral |
| type       | <a href="#">EMTYesNoNeutralType</a>  |
| properties | isRef 0<br>content simple  |
| facets     | Kind Value annotation<br>minLength 1<br>maxLength 7  |
| annotation | documentation<br>05030: Yes or No or Neutral   |

element **EMTFinancialInstrumentType/ClientObjectives/ReturnProfile/Hedging**

|            |  |
|------------|--|
| diagram    | <br>05040: Yes or No or Neutral |
| type       | <a href="#">EMTYesNoNeutralType</a>  |
| properties | isRef 0<br>content simple  |
| facets     | Kind Value annotation<br>minLength 1<br>maxLength 7  |
| annotation | documentation<br>05040: Yes or No or Neutral   |

element **EMTFinancialInstrumentType/ClientObjectives/ReturnProfile/OptionOrLeveraged**

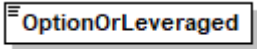
|            |  |
|------------|--|
| diagram    | <br>05050: Yes or No or Neutral |
| type       | <a href="#">EMTYesNoNeutralType</a>  |
| properties | isRef 0<br>content simple  |
| facets     | Kind Value annotation<br>minLength 1<br>maxLength 7  |
| annotation | documentation<br>05050: Yes or No or Neutral   |

element **EMTFinancialInstrumentType/ClientObjectives/ReturnProfile/Other**

|            |   |
|------------|---|
| diagram    |  |
| type       | restriction of <b>xs:string</b>   |
| properties | isRef 0<br>content simple   |
| facets     | Kind Value annotation<br>minLength 1<br>maxLength 7                               |
| annotation | documentation<br>05060: Yes or Neutral  |

element **EMTFinancialInstrumentType/ClientObjectives/ReturnProfile/PensionSchemeGermany**

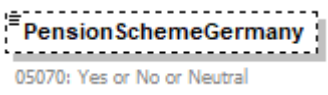
|            |   |
|------------|---|
| diagram    |  |
| type       | <a href="#">EMTYesNoNeutralType</a>   |
| properties | isRef 0<br>minOcc 0<br>maxOcc 1<br>content simple                                 |
| facets     | Kind Value annotation<br>minLength 1<br>maxLength 7                               |
| annotation | documentation<br>05070: Yes or No or Neutral                                      |

element **EMTFinancialInstrumentType/ClientObjectives/TimeHorizon**

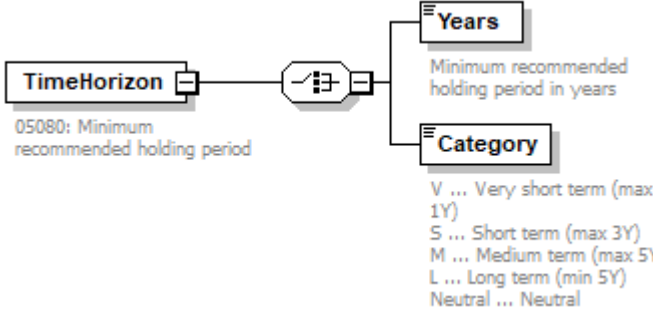
|            |   |
|------------|---|
| diagram    |  |
| properties | isRef 0<br>content complex  |
| children   | <a href="#">Years</a> <a href="#">Category</a>                                      |
| annotation | documentation<br>05080: Minimum recommended holding period                          |

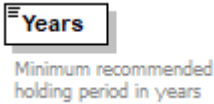

element **EMTFinancialInstrumentType/ClientObjectives/TimeHorizon/Years**

|            |   |
|------------|---|
| diagram    |  |
| type       | <b>xs:decimal</b>   |
| properties | isRef 0<br>content simple   |
| annotation | documentation<br>Minimum recommended holding period in years                      |

element **EMTFinancialInstrumentType/ClientObjectives/TimeHorizon/Category**

|            |   |
|------------|---|
| diagram    |    |
| type       | restriction of <b>xs:string</b>   |
| properties | isRef 0<br>content simple   |
| annotation | documentation<br>V ... Very short term (max 1Y)<br>S ... Short term (max 3Y)<br>M ... Medium term (max 5Y)<br>L ... Long term (min 5Y)<br>Neutral ... Neutral |

element **EMTFinancialInstrumentType/ClientObjectives/MaturityDate**

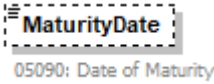
|            |   |
|------------|---|
| diagram    |  |
| type       | <b>xs:date</b>  |
| properties | isRef 0<br>minOcc 0<br>maxOcc 1<br>content simple                                   |
| annotation | documentation<br>05090: Date of Maturity  |

element **EMTFinancialInstrumentType/ClientObjectives/MayBeTerminatedEarly**

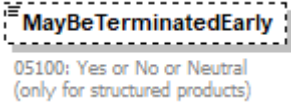
|            |   |
|------------|---|
| diagram    |  |
| type       | <a href="#">EMTYesNoNeutralType</a>   |
| properties | isRef 0<br>minOcc 0<br>maxOcc 1<br>content simple                                   |

|            |   |
|------------|---|
| facets     | Kind Value annotation<br>minLength 1<br>maxLength 7                         |
| annotation | documentation<br>05100: Yes or No or Neutral (only for structured products) |

element **EMTFinancialInstrumentType/ClientObjectives/SpecificInvestmentNeed**

|            |  |
|------------|--|
| diagram    | <p><b>SpecificInvestmentNeed</b><br/>05110: Yes or No or (Green investment, Ethical investment, Islamic banking, ESG, Other)</p> |
| type       | restriction of <b>xs:string</b>  |
| properties | isRef 0<br>content simple  |
| facets     | Kind Value annotation<br>length 1  |
| annotation | documentation<br>05110: Yes or No or (Green investment, Ethical investment, Islamic banking, ESG, Other)                         |

element **EMTFinancialInstrumentType/DistributionStrategy**

|            |   |
|------------|---|
| diagram    | <p><b>DistributionStrategy</b><br/>Distribution Strategy</p> <ul style="list-style-type: none"> <li><b>ExecutionOnly</b><br/>06010: Retail or Professional or Both or Neither</li> <li><b>ExecutionWithCheckOrNonAdvisedServices</b><br/>06020: Retail or Professional or Both or Neither</li> <li><b>InvestmentAdvice</b><br/>06030: Retail or Professional or Both or Neither</li> <li><b>PortfolioManagement</b><br/>06040: Retail or Professional or Both or Neither</li> </ul> |
| properties | isRef 0<br>content complex  |
| children   | <a href="#">ExecutionOnly</a> <a href="#">ExecutionWithCheckOrNonAdvisedServices</a> <a href="#">InvestmentAdvice</a> <a href="#">PortfolioManagement</a>   |
| annotation | documentation<br>Distribution Strategy  |

element **EMTFinancialInstrumentType/DistributionStrategy/ExecutionOnly**

|            |  |
|------------|--|
| diagram    | <p><b>ExecutionOnly</b><br/>06010: Retail or Professional or Both or Neither</p> |
| type       | <a href="#">RetailProfessionalBothNeitherType</a>                                |
| properties | isRef 0<br>content simple  |

|            |   |
|------------|---|
| facets     | Kind Value annotation<br>length 1                                 |
| annotation | documentation<br>06010: Retail or Professional or Both or Neither |

element **EMTFinancialInstrumentType/DistributionStrategy/ExecutionWithCheckOrNonAdvisedServices**

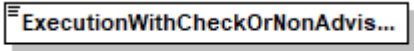
|            |   |
|------------|---|
| diagram    | <br>06020: Retail or Professional or Both or Neither |
| type       | <a href="#">RetailProfessionalBothNeitherType</a>   |
| properties | isRef 0<br>content simple   |
| facets     | Kind Value annotation<br>length 1   |
| annotation | documentation<br>06020: Retail or Professional or Both or Neither   |

element **EMTFinancialInstrumentType/DistributionStrategy/InvestmentAdvice**

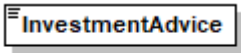
|            |   |
|------------|---|
| diagram    | <br>06030: Retail or Professional or Both or Neither |
| type       | <a href="#">RetailProfessionalBothNeitherType</a>   |
| properties | isRef 0<br>content simple   |
| facets     | Kind Value annotation<br>length 1   |
| annotation | documentation<br>06030: Retail or Professional or Both or Neither   |

element **EMTFinancialInstrumentType/DistributionStrategy/PortfolioManagement**

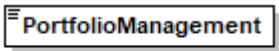
|            |   |
|------------|---|
| diagram    | <br>06040: Retail or Professional or Both or Neither |
| type       | <a href="#">RetailProfessionalBothNeitherType</a>   |
| properties | isRef 0<br>content simple   |
| facets     | Kind Value annotation<br>length 1   |
| annotation | documentation<br>06040: Retail or Professional or Both or Neither   |

element **EMTFinancialInstrumentType/CostsAndChargesExAnte**

|                   |   |
|-------------------|---|
| <p>diagram</p>    | <pre> classDiagram     class CostsAndChargesExAnte {         Costs and Charges ex ante     }     class Fund {         Relevant fields for funds     }     class StructuredSecurity {         Relevant fields for structured securities     }     CostsAndChargesExAnte &lt; -- Fund     CostsAndChargesExAnte &lt; -- StructuredSecurity     </pre> |
| <p>properties</p> | <p>isRef 0<br/>content complex</p>  |
| <p>children</p>   | <p><a href="#">Fund</a> <a href="#">StructuredSecurity</a></p>  |
| <p>annotation</p> | <p>documentation<br/>Costs and Charges ex ante</p>  |

element **EMTFinancialInstrumentType/CostsAndChargesExAnte/Fund**

diagram

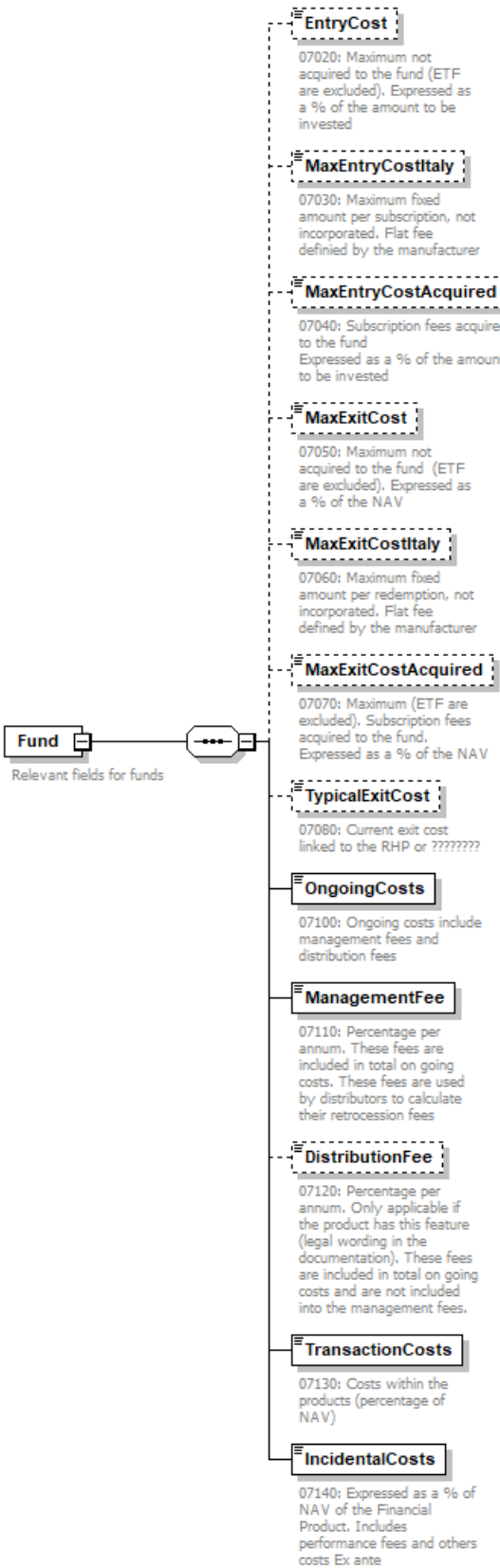

|            |   |
|------------|---|
| properties | isRef 0<br>content complex  |
| children   | <a href="#">EntryCost</a> <a href="#">MaxEntryCostItaly</a> <a href="#">MaxEntryCostAcquired</a> <a href="#">MaxExitCost</a> <a href="#">MaxExitCostItaly</a> <a href="#">MaxExitCostAcquired</a> <a href="#">TypicalExitCost</a> <a href="#">OngoingCosts</a> <a href="#">ManagementFee</a> <a href="#">DistributionFee</a> <a href="#">TransactionCosts</a> <a href="#">IncidentalCosts</a> |
| annotation | documentation<br>Relevant fields for funds  |

element **EMTFinancialInstrumentType/CostsAndChargesExAnte/Fund/EntryCost**

|            |  |
|------------|--|
| diagram    |  <p>07020: Maximum not acquired to the fund (ETF are excluded). Expressed as a % of the amount to be invested</p> |
| type       | <b>xs:decimal</b>  |
| properties | isRef 0<br>minOcc 0<br>maxOcc 1<br>content simple  |
| annotation | documentation<br>07020: Maximum not acquired to the fund (ETF are excluded). Expressed as a % of the amount to be invested   |

element **EMTFinancialInstrumentType/CostsAndChargesExAnte/Fund/MaxEntryCostItaly**

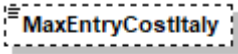
|            |  |
|------------|--|
| diagram    |  <p>07030: Maximum fixed amount per subscription, not incorporated. Flat fee defined by the manufacturer</p> |
| type       | <b>xs:decimal</b>  |
| properties | isRef 0<br>minOcc 0<br>maxOcc 1<br>content simple  |
| annotation | documentation<br>07030: Maximum fixed amount per subscription, not incorporated. Flat fee defined by the manufacturer  |

element **EMTFinancialInstrumentType/CostsAndChargesExAnte/Fund/MaxEntryCostAcquired**

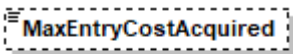
|            |  |
|------------|--|
| diagram    |  <p>07040: Subscription fees acquired to the fund<br/>Expressed as a % of the amount to be invested</p> |
| type       | <b>xs:decimal</b>  |
| properties | isRef 0<br>minOcc 0<br>maxOcc 1<br>content simple  |
| annotation | documentation<br>07040: Subscription fees acquired to the fund<br>Expressed as a % of the amount to be invested  |

element **EMTFinancialInstrumentType/CostsAndChargesExAnte/Fund/MaxExitCost**

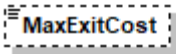
|            |  |
|------------|--|
| diagram    |  <p>07050: Maximum not acquired to the fund (ETF are excluded). Expressed as a % of the NAV</p> |
| type       | <b>xs:decimal</b>  |
| properties | isRef 0<br>minOcc 0<br>maxOcc 1<br>content simple  |
| annotation | documentation<br>07050: Maximum not acquired to the fund (ETF are excluded). Expressed as a % of the NAV   |

element **EMTFinancialInstrumentType/CostsAndChargesExAnte/Fund/MaxExitCostItaly**

|            |   |
|------------|---|
| diagram    |  <p>07060: Maximum fixed amount per redemption, not incorporated. Flat fee defined by the manufacturer</p> |
| type       | <b>xs:decimal</b>   |
| properties | isRef 0<br>minOcc 0<br>maxOcc 1<br>content simple   |
| annotation | documentation<br>07060: Maximum fixed amount per redemption, not incorporated. Flat fee defined by the manufacturer   |

element **EMTFinancialInstrumentType/CostsAndChargesExAnte/Fund/MaxExitCostAcquired**

|            |   |
|------------|---|
| diagram    |  <p>07070: Maximum (ETF are excluded). Subscription fees acquired to the fund. Expressed as a % of the NAV</p> |
| type       | <b>xs:decimal</b>   |
| properties | isRef 0<br>minOcc 0<br>maxOcc 1<br>content simple   |
| annotation | documentation<br>07070: Maximum (ETF are excluded). Subscription fees acquired to the fund. Expressed as a % of the NAV   |

element **EMTFinancialInstrumentType/CostsAndChargesExAnte/Fund/TypicalExitCost**

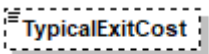
|         |   |
|---------|---|
| diagram |  <p>07080: Current exit cost linked to the RHP or ??????????</p> |
| type    | <b>xs:decimal</b>   |

|            |   |
|------------|---|
| properties | isRef 0<br>minOcc 0<br>maxOcc 1<br>content simple                       |
| annotation | documentation<br>07080: Current exit cost linked to the RHP or ???????? |

element **EMTFinancialInstrumentType/CostsAndChargesExAnte/Fund/OngoingCosts**

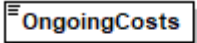
|            |   |
|------------|---|
| diagram    |  <p>07100: Ongoing costs include management fees and distribution fees</p> |
| type       | <b>xs:decimal</b>   |
| properties | isRef 0<br>content simple   |
| annotation | documentation<br>07100: Ongoing costs include management fees and distribution fees   |

element **EMTFinancialInstrumentType/CostsAndChargesExAnte/Fund/ManagementFee**

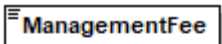
|            |   |
|------------|---|
| diagram    |  <p>07110: Percentage per annum. These fees are included in total on going costs. These fees are used by distributors to calculate their retrocession fees</p> |
| type       | <b>xs:decimal</b>   |
| properties | isRef 0<br>content simple   |
| annotation | documentation<br>07110: Percentage per annum. These fees are included in total on going costs. These fees are used by distributors to calculate their retrocession fees   |

element **EMTFinancialInstrumentType/CostsAndChargesExAnte/Fund/DistributionFee**

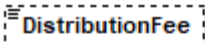
|            |  |
|------------|--|
| diagram    |  <p>07120: Percentage per annum. Only applicable if the product has this feature (legal wording in the documentation). These fees are included in total on going costs and are not included into the management fees.</p> |
| type       | <b>xs:decimal</b>  |
| properties | isRef 0<br>minOcc 0<br>maxOcc 1<br>content simple  |
| annotation | documentation<br>07120: Percentage per annum. Only applicable if the product has this feature (legal wording in the documentation). These fees are included in total on going costs and are not included into the management fees.   |

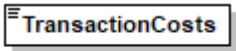

element **EMTFinancialInstrumentType/CostsAndChargesExAnte/Fund/TransactionCosts**

|            |   |
|------------|---|
| diagram    |  <p>07130: Costs within the products (percentage of NAV)</p> |
| type       | <b>xs:decimal</b>   |
| properties | isRef 0<br>content simple   |
| annotation | documentation<br>07130: Costs within the products (percentage of NAV)   |

element **EMTFinancialInstrumentType/CostsAndChargesExAnte/Fund/IncidentalCosts**

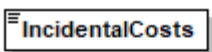
|            |  |
|------------|--|
| diagram    |  <p>07140: Expressed as a % of NAV of the Financial Product. Includes performance fees and others costs Ex ante</p> |
| type       | <b>xs:decimal</b>  |
| properties | isRef 0<br>content simple  |
| annotation | documentation<br>07140: Expressed as a % of NAV of the Financial Product. Includes performance fees and others costs Ex ante   |

element **EMTFinancialInstrumentType/CostsAndChargesExAnte/StructuredSecurity**

|                   |  |
|-------------------|--|
| <p>diagram</p>    | <p><b>StructuredSecurity</b><br/>Relevant fields for structured securities</p> <ul style="list-style-type: none"> <li><b>Quotation</b><br/>07010: Unit quotation in Units figures or Percentage quotation of the amount to be invested</li> <li><b>OneOffEntryCost</b><br/>07020: "Ask Price" - Fair Value (as of reporting date)</li> <li><b>TypicalExitCost</b><br/>07080: Exit cost at the RHP (typically 0%)</li> <li><b>ExitCostPriorRHP</b><br/>07090: For non exchange traded structured securities</li> <li><b>OngoingCosts</b><br/>07100: Expressed as a % of NAV / Notional (or currency amount for Absolute quotation) of the Financial Product / always per annum</li> <li><b>ManagementFee</b><br/>07110: Percentage per annum. These fees are included in total on going costs. Only applicable if the product has this feature. These fees are used by distributors to calculate their retrocession fees</li> </ul> |
| <p>properties</p> | <p>isRef 0<br/>content complex</p>   |
| <p>children</p>   | <p><a href="#">Quotation</a> <a href="#">OneOffEntryCost</a> <a href="#">TypicalExitCost</a> <a href="#">ExitCostPriorRHP</a> <a href="#">OngoingCosts</a> <a href="#">ManagementFee</a></p>   |
| <p>annotation</p> | <p>documentation<br/>Relevant fields for structured securities</p>   |

element **EMTFinancialInstrumentType/CostsAndChargesExAnte/StructuredSecurity/Quotation**

|                   |   |
|-------------------|---|
| <p>diagram</p>    | <p><b>Quotation</b><br/>07010: Unit quotation in Units figures or Percentage quotation of the amount to be invested</p> |
| <p>type</p>       | <p>restriction of <b>xs:string</b></p>  |
| <p>properties</p> | <p>isRef 0<br/>content simple</p>   |
| <p>facets</p>     | <p>Kind Value annotation<br/>length 1</p>   |
| <p>annotation</p> | <p>documentation<br/>07010: Unit quotation in Units figures or Percentage quotation of the amount to be invested</p>    |

element **EMTFinancialInstrumentType/CostsAndChargesExAnte/StructuredSecurity/OneOffEntryCost**

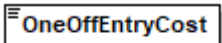
|            |   |
|------------|---|
| diagram    |  <p>07020: "Ask Price" - Fair Value (as of reporting date)</p> |
| type       | <b>xs:decimal</b>   |
| properties | isRef 0<br>content simple   |
| annotation | documentation<br>07020: "Ask Price" - Fair Value (as of reporting date)   |

element **EMTFinancialInstrumentType/CostsAndChargesExAnte/StructuredSecurity/TypicalExitCost**

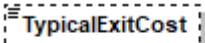
|            |   |
|------------|---|
| diagram    |  <p>07080: Exit cost at the RHP (typically 0%)</p> |
| type       | <b>xs:decimal</b>   |
| properties | isRef 0<br>minOcc 0<br>maxOcc 1<br>content simple   |
| annotation | documentation<br>07080: Exit cost at the RHP (typically 0%)   |

element **EMTFinancialInstrumentType/CostsAndChargesExAnte/StructuredSecurity/ExitCostPriorRHP**

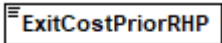
|            |   |
|------------|---|
| diagram    |  <p>07090: For non exchange traded structured securities</p> |
| type       | <b>xs:decimal</b>   |
| properties | isRef 0<br>content simple   |
| annotation | documentation<br>07090: For non exchange traded structured securities   |

element **EMTFinancialInstrumentType/CostsAndChargesExAnte/StructuredSecurity/OngoingCosts**

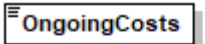
|            |  |
|------------|--|
| diagram    |  <p>07100: Expressed as a % of NAV / Notional (or currency amount for Absolute quotation) of the Financial Product / always per annum</p> |
| type       | <b>xs:decimal</b>  |
| properties | isRef 0<br>content simple  |
| annotation | documentation<br>07100: Expressed as a % of NAV / Notional (or currency amount for Absolute quotation) of the Financial Product / always per annum   |

element **EMTFinancialInstrumentType/CostsAndChargesExAnte/StructuredSecurity/ManagementFee**

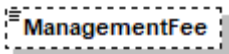
|            |  |
|------------|--|
| diagram    |  <p><b>ManagementFee</b></p> <p>07110: Percentage per annum. These fees are included in total on going costs. Only applicable if the product has this feature. These fees are used by distributors to calculate their retrocession fees</p> |
| type       | <b>xs:decimal</b>  |
| properties | isRef 0<br>minOcc 0<br>maxOcc 1<br>content simple  |
| annotation | documentation<br>07110: Percentage per annum. These fees are included in total on going costs. Only applicable if the product has this feature. These fees are used by distributors to calculate their retrocession fees   |

element **EMTFinancialInstrumentType/CostsAndChargesExPost**

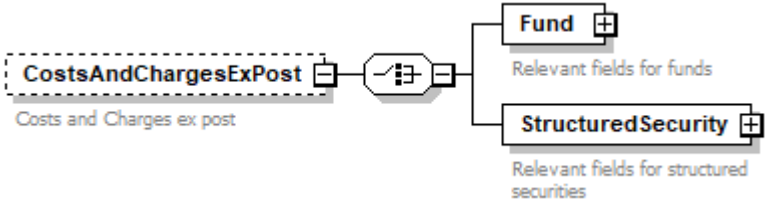
|            |  |
|------------|--|
| diagram    |  <p><b>CostsAndChargesExPost</b></p> <p>Costs and Charges ex post</p> <p><b>Fund</b> +<br/>Relevant fields for funds</p> <p><b>StructuredSecurity</b> +<br/>Relevant fields for structured securities</p> |
| properties | isRef 0<br>minOcc 0<br>maxOcc 1<br>content complex   |
| children   | <a href="#">Fund</a> <a href="#">StructuredSecurity</a>  |
| annotation | documentation<br>Costs and Charges ex post   |

element **EMTFinancialInstrumentType/CostsAndChargesExPost/Fund**

|                   |  |
|-------------------|--|
| <p>diagram</p>    | <p><b>Fund</b><br/>Relevant fields for funds</p> <p><b>OngoingCosts</b><br/>08030: Ongoing costs ex post<br/>Definition tbd as a % of NAV of the Financial Product / per annum.<br/>Occured costs over one year</p> <p><b>ManagementFee</b><br/>08050: Management fee ex post<br/>Definition tbd as a % of NAV of the Financial Product / per annum.<br/>Occured costs over one year</p> <p><b>DistributionFee</b><br/>08060: Distribution fee ex post<br/>Definition tbd as a % of NAV of the Financial Product / per annum.<br/>Occured costs over one year</p> <p><b>TransactionCosts</b><br/>08070: Transaction costs ex post<br/>Definition tbd as a % of NAV of the Financial Product / per annum.<br/>Occured costs over one year</p> <p><b>IncidentalCosts</b><br/>08080: Incidental costs ex post<br/>Definition tbd as a % of NAV of the Financial Product / per annum.<br/>Occured costs over one year</p> <p><b>CalculationPeriod</b> <br/>Mandatory for German and Swiss distributors</p> |
| <p>properties</p> | <p>isRef 0<br/>content complex</p>   |
| <p>children</p>   | <p><a href="#">OngoingCosts</a> <a href="#">ManagementFee</a> <a href="#">DistributionFee</a> <a href="#">TransactionCosts</a> <a href="#">IncidentalCosts</a> <a href="#">CalculationPeriod</a></p>   |
| <p>annotation</p> | <p>documentation<br/>Relevant fields for funds</p>   |

element **EMTFinancialInstrumentType/CostsAndChargesExPost/Fund/OngoingCosts**

|                |   |
|----------------|---|
| <p>diagram</p> | <p><b>OngoingCosts</b></p> <p>08030: Ongoing costs ex post<br/>Definition tbd as a % of NAV of the Financial Product / per annum.<br/>Occured costs over one year</p> |
|----------------|---|

|            |   |
|------------|---|
| type       | <b>xs:decimal</b>   |
| properties | isRef 0<br>minOcc 0<br>maxOcc 1<br>content simple   |
| annotation | documentation<br>08030: Ongoing costs ex post<br>Definition tbd as a % of NAV of the Financial Product / per annum. Occured costs over one year |

element **EMTFinancialInstrumentType/CostsAndChargesExPost/Fund/ManagementFee**

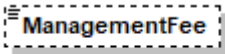
|            |  |
|------------|--|
| diagram    |  <p>08050: Management fee ex post<br/> Definition tbd as a % of NAV of the Financial Product / per annum. Occured costs over one year</p> |
| type       | <b>xs:decimal</b>  |
| properties | isRef 0<br>minOcc 0<br>maxOcc 1<br>content simple  |
| annotation | documentation<br>08050: Management fee ex post<br>Definition tbd as a % of NAV of the Financial Product / per annum. Occured costs over one year   |

element **EMTFinancialInstrumentType/CostsAndChargesExPost/Fund/DistributionFee**

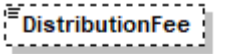
|            |  |
|------------|--|
| diagram    |  <p>08060: Distribution fee ex post<br/> Definition tbd as a % of NAV of the Financial Product / per annum. Occured costs over one year</p> |
| type       | <b>xs:decimal</b>  |
| properties | isRef 0<br>minOcc 0<br>maxOcc 1<br>content simple  |
| annotation | documentation<br>08060: Distribution fee ex post<br>Definition tbd as a % of NAV of the Financial Product / per annum. Occured costs over one year   |

element **EMTFinancialInstrumentType/CostsAndChargesExPost/Fund/TransactionCosts**

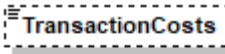
|         |   |
|---------|---|
| diagram |  <p>08070: Transaction costs ex post<br/> Definition tbd as a % of NAV of the Financial Product / per annum. Occured costs over one year</p> |
| type    | <b>xs:decimal</b>   |

|            |   |
|------------|---|
| properties | isRef 0<br>minOcc 0<br>maxOcc 1<br>content simple   |
| annotation | documentation<br>08070: Transaction costs ex post<br>Definition tbd as a % of NAV of the Financial Product / per annum. Occured costs over one year |

element **EMTFinancialInstrumentType/CostsAndChargesExPost/Fund/IncidentalCosts**

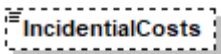
|            |  |
|------------|--|
| diagram    |  <p><b>IncidentalCosts</b><br/>08080: Incidental costs ex post<br/>Definition tbd as a % of NAV of the Financial Product / per annum. Occured costs over one year</p> |
| type       | <b>xs:decimal</b>  |
| properties | isRef 0<br>minOcc 0<br>maxOcc 1<br>content simple  |
| annotation | documentation<br>08080: Incidental costs ex post<br>Definition tbd as a % of NAV of the Financial Product / per annum. Occured costs over one year   |

element **EMTFinancialInstrumentType/CostsAndChargesExPost/Fund/CalculationPeriod**

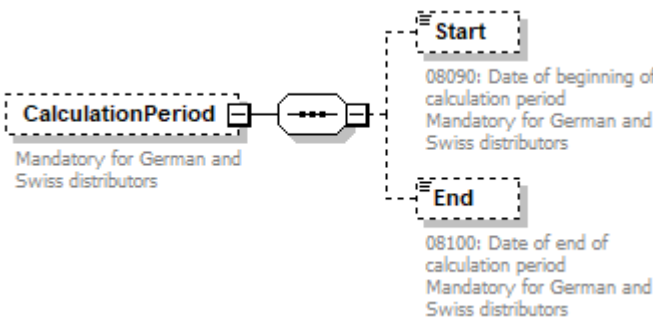
|            |   |
|------------|---|
| diagram    |  <p><b>CalculationPeriod</b><br/>Mandatory for German and Swiss distributors</p> <p><b>Start</b><br/>08090: Date of beginning of calculation period<br/>Mandatory for German and Swiss distributors</p> <p><b>End</b><br/>08100: Date of end of calculation period<br/>Mandatory for German and Swiss distributors</p> |
| properties | isRef 0<br>minOcc 0<br>maxOcc 1<br>content complex  |
| children   | <a href="#">Start</a> <a href="#">End</a>   |
| annotation | documentation<br>Mandatory for German and Swiss distributors  |

element **EMTFinancialInstrumentType/CostsAndChargesExPost/Fund/CalculationPeriod/Start**

|         |  |
|---------|--|
| diagram |  <p><b>Start</b><br/>08090: Date of beginning of calculation period<br/>Mandatory for German and Swiss distributors</p> |
| type    | <b>xs:date</b>   |

|            |  |
|------------|--|
| properties | isRef 0<br>minOcc 0<br>maxOcc 1<br>content simple  |
| annotation | documentation<br>08090: Date of beginning of calculation period<br>Mandatory for German and Swiss distributors |

element **EMTFinancialInstrumentType/CostsAndChargesExPost/Fund/CalculationPeriod/End**

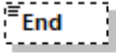
|            |   |
|------------|---|
| diagram    |  <p>08100: Date of end of calculation period<br/>Mandatory for German and Swiss distributors</p> |
| type       | <b>xs:date</b>  |
| properties | isRef 0<br>minOcc 0<br>maxOcc 1<br>content simple   |
| annotation | documentation<br>08100: Date of end of calculation period<br>Mandatory for German and Swiss distributors  |



element **EMTFinancialInstrumentType/CostsAndChargesExPost/StructuredSecurity**

|                   |   |
|-------------------|---|
| <p>diagram</p>    | <p><b>StructuredSecurity</b><br/>Relevant fields for structured securities</p> <p><b>EntryCost</b><br/>08010: One off entry cost ex post<br/>If 07010 set to U : absolute figures in product currency<br/>If 07010 set to P : % of Notional or NAV (not per annum)</p> <p><b>ExitCost</b><br/>08020: One off exit cost ex post<br/>If 07010 set to U : absolute figures in product currency<br/>If 07010 set to P : % of Notional or NAV (not per annum)</p> <p><b>OngoingCosts</b><br/>08030: Ongoing costs ex post<br/>If 07010 set to U : absolute figures in product currency<br/>If 07010 set to P : % of Notional or NAV (not per annum)</p> <p><b>OngoingCostsAccumulated</b><br/>08040: Ongoing costs ex post accumulated<br/>If 07010 set to U : absolute figures in product currency<br/>If 07010 set to P : % of Notional or NAV (not per annum)</p> <p><b>ManagementFee</b><br/>08050: Management fee ex post<br/>If 07010 set to U : absolute figures in product currency<br/>If 07010 set to P : % of Notional or NAV (not per annum)</p> |
| <p>properties</p> | <p>isRef 0<br/>content complex</p>  |
| <p>children</p>   | <p><a href="#">EntryCost</a> <a href="#">ExitCost</a> <a href="#">OngoingCosts</a> <a href="#">OngoingCostsAccumulated</a> <a href="#">ManagementFee</a></p>  |
| <p>annotation</p> | <p>documentation<br/>Relevant fields for structured securities</p>  |

element **EMTFinancialInstrumentType/CostsAndChargesExPost/StructuredSecurity/EntryCost**

|                |   |
|----------------|---|
| <p>diagram</p> | <p><b>EntryCost</b><br/>08010: One off entry cost ex post<br/>If 07010 set to U : absolute figures in product currency<br/>If 07010 set to P : % of Notional or NAV (not per annum)</p> |
|----------------|---|

|            |  |
|------------|--|
| type       | <b>xs:decimal</b>  |
| properties | isRef 0<br>minOcc 0<br>maxOcc 1<br>content simple  |
| annotation | documentation<br>08010: One off entry cost ex post<br>If 07010 set to U : absolute figures in product currency<br>If 07010 set to P : % of Notional or NAV (not per annum) |

element **EMTFinancialInstrumentType/CostsAndChargesExPost/StructuredSecurity/ExitCost**

|            |   |
|------------|---|
| diagram    |  <p>08020: One off exit cost ex post<br/>If 07010 set to U : absolute figures in product currency<br/>If 07010 set to P : % of Notional or NAV (not per annum)</p> |
| type       | <b>xs:decimal</b>   |
| properties | isRef 0<br>minOcc 0<br>maxOcc 1<br>content simple   |
| annotation | documentation<br>08020: One off exit cost ex post<br>If 07010 set to U : absolute figures in product currency<br>If 07010 set to P : % of Notional or NAV (not per annum)   |

element **EMTFinancialInstrumentType/CostsAndChargesExPost/StructuredSecurity/OngoingCosts**

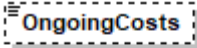
|            |   |
|------------|---|
| diagram    |  <p>08030: Ongoing costs ex post<br/>If 07010 set to U : absolute figures in product currency<br/>If 07010 set to P : % of Notional or NAV (not per annum)</p> |
| type       | <b>xs:decimal</b>   |
| properties | isRef 0<br>minOcc 0<br>maxOcc 1<br>content simple   |
| annotation | documentation<br>08030: Ongoing costs ex post<br>If 07010 set to U : absolute figures in product currency<br>If 07010 set to P : % of Notional or NAV (not per annum)   |

element

**EMTFinancialInstrumentType/CostsAndChargesExPost/StructuredSecurity/OngoingCostsAccumulated**

|            |   |
|------------|---|
| diagram    |  <p>08040: Ongoing costs ex post accumulated<br/>If 07010 set to U : absolute figures in product currency<br/>If 07010 set to P : % of Notional or NAV (not per annum)</p> |
| type       | <b>xs:decimal</b>   |
| properties | isRef 0<br>minOcc 0<br>maxOcc 1<br>content simple   |
| annotation | documentation<br>08040: Ongoing costs ex post accumulated<br>If 07010 set to U : absolute figures in product currency<br>If 07010 set to P : % of Notional or NAV (not per annum)   |

element **EMTFinancialInstrumentType/CostsAndChargesExPost/StructuredSecurity/ManagementFee**

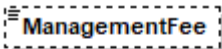
|            |  |
|------------|--|
| diagram    |  <p>08050: Management fee ex post<br/>If 07010 set to U : absolute figures in product currency<br/>If 07010 set to P : % of Notional or NAV (not per annum)</p> |
| type       | <b>xs:decimal</b>  |
| properties | isRef 0<br>minOcc 0<br>maxOcc 1<br>content simple  |
| annotation | documentation<br>08050: Management fee ex post<br>If 07010 set to U : absolute figures in product currency<br>If 07010 set to P : % of Notional or NAV (not per annum)   |

element **EMTFinancialInstrumentType/CountrySpecificData**

|            |   |
|------------|---|
| diagram    |   |
| type       | <a href="#">CountrySpecificEMTDataType</a>  |
| properties | isRef 0<br>minOcc 0<br>maxOcc 1<br>content complex  |
| children   | <a href="#">AT</a> <a href="#">DE</a> <a href="#">DK</a> <a href="#">FR</a> <a href="#">LU</a> <a href="#">NL</a> |

complexType **EMTType**

|          |   |
|----------|---|
| diagram  |   |
| children | <a href="#">FinancialInstrument</a>             |
| used by  | element <a href="#">DirectReportingType/EMT</a> |

element **EMTType/FinancialInstrument**

diagram

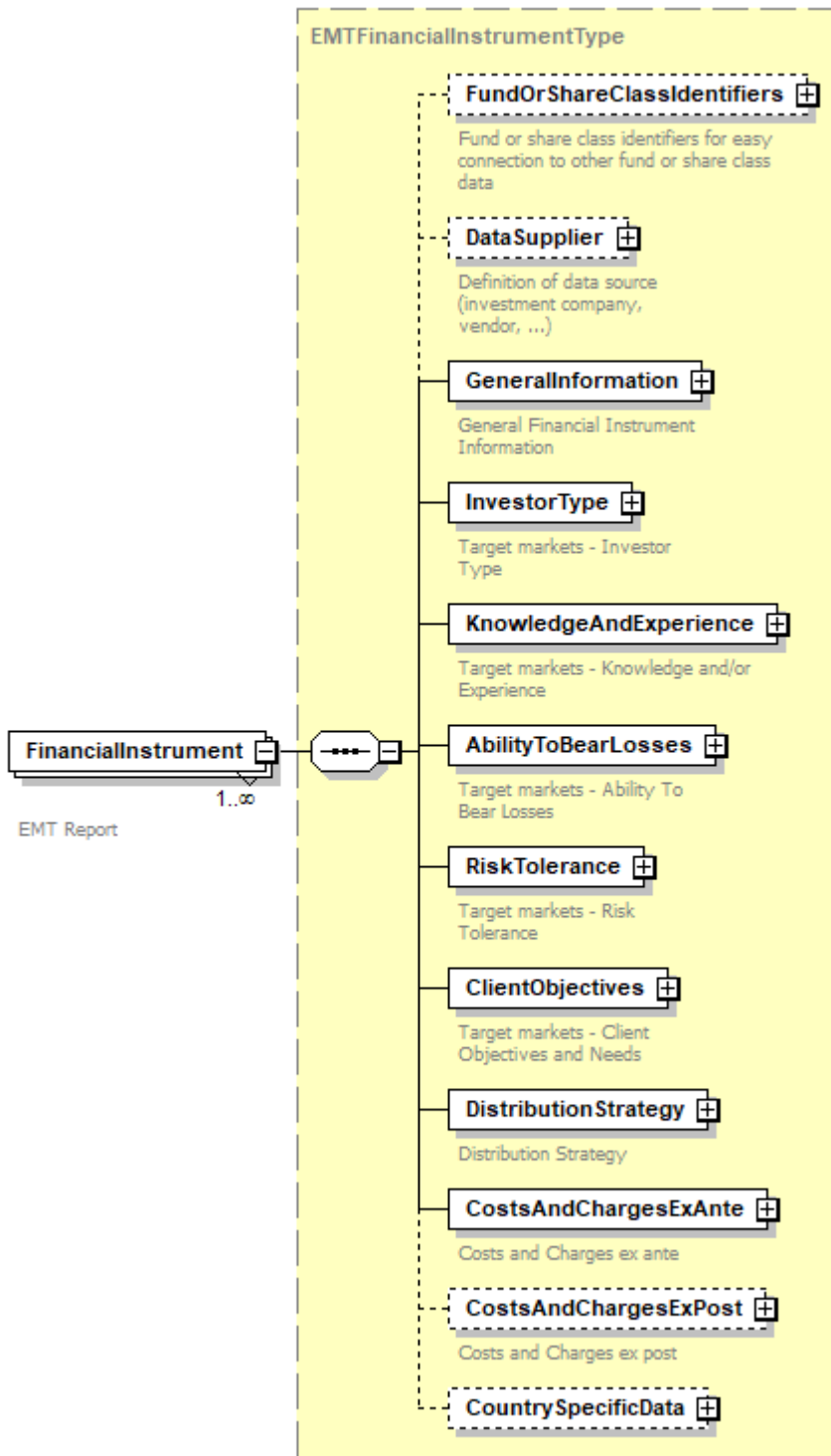

type [EMTFinancialInstrumentType](#)

properties  
 isRef 0  
 minOcc 1  
 maxOcc unbounded  
 content complex

children [FundOrShareClassIdentifiers](#) [DataSupplier](#) [GeneralInformation](#) [InvestorType](#) [KnowledgeAndExperience](#)

|            |   |
|------------|---|
|            | <a href="#">AbilityToBearLosses</a> <a href="#">RiskTolerance</a> <a href="#">ClientObjectives</a> <a href="#">DistributionStrategy</a> <a href="#">CostsAndChargesExAnte</a> <a href="#">CostsAndChargesExPost</a> <a href="#">CountrySpecificData</a> |
| annotation | documentation<br>EMT Report   |

complexType **EMTType\_V3**

|          |  |
|----------|--|
| diagram  | <p>EMT Version 3 Report</p>                        |
| children | <a href="#">FinancialInstrument</a>                |
| used by  | element <a href="#">DirectReportingType/EMT_V3</a> |

element **EMTType\_V3/FinancialInstrument**

|            |  |
|------------|--|
| diagram    | <p>The diagram shows the structure of the <b>EMT_V3_FinancialInstrumentType</b>. It is a complex type containing several elements:</p> <ul style="list-style-type: none"> <li><b>FundOrShareClassIdentifiers</b>: Fund or share class identifiers for easy connection to other fund or share class data.</li> <li><b>DataSupplier</b>: Definition of data source (investment company, vendor, ...).</li> <li><b>DataSetInformation</b>: General Financial Instrument Information.</li> <li><b>GeneralInformation</b>: General Financial Instrument Information.</li> <li><b>TargetMarket</b>: Target Market.</li> <li><b>CostsAndChargesExAnte</b>: Costs and Charges ex ante.</li> <li><b>CostsAndChargesExPost</b>: Costs and Charges ex post.</li> <li><b>CountrySpecificData</b>: Country Specific Data.</li> </ul> <p>The <b>FinancialInstrument</b> element (1..∞) is shown on the left, containing the <b>EMT_V3_FinancialInstrumentType</b> structure.</p> |
| type       | <a href="#">EMT_V3_FinancialInstrumentType</a>   |
| properties | isRef 0<br>minOcc 1<br>maxOcc unbounded<br>content complex   |
| children   | <a href="#">FundOrShareClassIdentifiers</a> <a href="#">DataSupplier</a> <a href="#">DataSetInformation</a> <a href="#">GeneralInformation</a> <a href="#">TargetMarket</a> <a href="#">CostsAndChargesExAnte</a> <a href="#">CostsAndChargesExPost</a> <a href="#">CountrySpecificData</a>  |

|            |                                       |
|------------|---------------------------------------|
| annotation | documentation<br>EMT Version 3 Report |
|------------|---------------------------------------|

complexType **EMTType\_V4**

|          |  |
|----------|--|
| diagram  | <p>EMT Version 4 Report</p>                        |
| children | <a href="#">FinancialInstrument</a>                |
| used by  | element <a href="#">DirectReportingType/EMT_V4</a> |

element **EMTType\_V4/FinancialInstrument**

|            |   |
|------------|---|
| diagram    |   |
| type       | <a href="#">EMT_V4_FinancialInstrumentType</a>  |
| properties | isRef 0<br>minOcc 1<br>maxOcc unbounded<br>content complex  |
| children   | <a href="#">FundOrShareClassIdentifiers</a> <a href="#">DataSupplier</a> <a href="#">DataSetInformation</a> <a href="#">GeneralInformation</a> <a href="#">TargetMarket</a> <a href="#">CostsAndChargesExAnte</a> <a href="#">CostsAndChargesExPost</a> <a href="#">CountrySpecificData</a> |
| annotation | documentation<br>EMT Version 4 Report   |

complexType **EMTType\_V41**

|          |  |
|----------|--|
| diagram  | <p>EMT Version 4.1 Report</p>                        |
| children | <a href="#">FinancialInstrument</a>                  |
| used by  | element <a href="#">DirectReportingType/EMT_V4_1</a> |

element **EMTType\_V41/FinancialInstrument**

|            |   |
|------------|---|
| diagram    | <p>EMT Version 4.1 Report</p>   |
| type       | <a href="#">EMT_V41_FinancialInstrumentType</a>   |
| properties | <p>isRef 0<br/> minOcc 1<br/> maxOcc unbounded<br/> content complex</p>   |
| children   | <a href="#">FundOrShareClassIdentifiers</a> <a href="#">DataSupplier</a> <a href="#">DataSetInformation</a> <a href="#">GeneralInformation</a> <a href="#">TargetMarket</a> <a href="#">CostsAndChargesExAnte</a> <a href="#">CostsAndChargesExPost</a> <a href="#">AdditionalInformationUK</a> |
| annotation | <p>documentation<br/> EMT Version 4.1 Report</p>  |



### simpleType **EMTYesEmptyType**

|            |   |
|------------|---|
| type       | restriction of <b>xs:string</b>   |
| properties | base <b>xs:string</b>   |
| used by    | element <a href="#">EMT_V41_FinancialInstrumentType/AdditionalInformationUK/ValueForMoney/EMTDataReportingVFM</a> |
| annotation | documentation<br>Y or Empty   |

### simpleType **EMTYesNeutralType**

|            |   |
|------------|---|
| type       | restriction of <b>xs:string</b>   |
| properties | base <b>xs:string</b>   |
| used by    | elements <a href="#">EMT_V3_FinancialInstrumentType/TargetMarket/ClientObjectives/IntendedCompatibleWithClientsHavingESGPPreferences</a><br><a href="#">EMT_V4_FinancialInstrumentType/TargetMarket/ClientObjectives/IntendedCompatibleWithClientsHavingSustainabilityPreferences</a><br><a href="#">EMT_V41_FinancialInstrumentType/TargetMarket/ClientObjectives/IntendedCompatibleWithClientsHavingSustainabilityPreferences</a> |
| facets     | Kind Value annotation<br>minLength 1<br>maxLength 7   |

### simpleType **EMTYesNoNeutralType**

|            |  |
|------------|--|
| type       | restriction of <b>xs:string</b>  |
| properties | base <b>xs:string</b>  |
| used by    | elements <a href="#">EMT_V4_FinancialInstrumentType/TargetMarket/KnowledgeAndExperience/AdvancedInvestor</a><br><a href="#">EMT_V41_FinancialInstrumentType/TargetMarket/KnowledgeAndExperience/AdvancedInvestor</a><br><a href="#">EMT_V3_FinancialInstrumentType/TargetMarket/KnowledgeAndExperience/AdvancedInvestor</a><br><a href="#">EMTFinancialInstrumentType/KnowledgeAndExperience/AdvancedInvestor</a><br><a href="#">EMT_V4_FinancialInstrumentType/TargetMarket/KnowledgeAndExperience/BasicInvestor</a><br><a href="#">EMT_V3_FinancialInstrumentType/TargetMarket/KnowledgeAndExperience/BasicInvestor</a><br><a href="#">EMT_V41_FinancialInstrumentType/TargetMarket/KnowledgeAndExperience/BasicInvestor</a><br><a href="#">EMTFinancialInstrumentType/KnowledgeAndExperience/BasicInvestor</a><br><a href="#">EMT_V4_FinancialInstrumentType/TargetMarket/ClientObjectives/ReturnProfile/ClientLookingForCapitalGrowth</a><br><a href="#">EMT_V41_FinancialInstrumentType/TargetMarket/ClientObjectives/ReturnProfile/ClientLookingForCapitalGrowth</a><br><a href="#">EMT_V3_FinancialInstrumentType/TargetMarket/ClientObjectives/ReturnProfile/ClientLookingForCapitalGrowth</a><br><a href="#">EMT_V3_FinancialInstrumentType/TargetMarket/ClientObjectives/ReturnProfile/ClientLookingForIncome</a><br><a href="#">EMT_V4_FinancialInstrumentType/TargetMarket/ClientObjectives/ReturnProfile/ClientLookingForIncome</a><br><a href="#">EMT_V41_FinancialInstrumentType/TargetMarket/ClientObjectives/ReturnProfile/ClientLookingForIncome</a><br><a href="#">EMT_V4_FinancialInstrumentType/TargetMarket/ClientObjectives/ReturnProfile/ClientLookingForPreservation</a><br><a href="#">EMT_V41_FinancialInstrumentType/TargetMarket/ClientObjectives/ReturnProfile/ClientLookingForPreservation</a><br><a href="#">EMT_V3_FinancialInstrumentType/TargetMarket/ClientObjectives/ReturnProfile/ClientLookingForPreservation</a><br><a href="#">EMT_V41_FinancialInstrumentType/TargetMarket/AbilityToBearLosses/CompatibleWithClientsWhoCanBearLimitedCapitalLoss</a><br><a href="#">EMT_V4_FinancialInstrumentType/TargetMarket/AbilityToBearLosses/CompatibleWithClientsWhoCanBearLimitedCapitalLoss</a><br><a href="#">EMT_V3_FinancialInstrumentType/TargetMarket/AbilityToBearLosses/CompatibleWithClientsWhoCanBearLimitedCapitalLoss</a><br><a href="#">EMT_V4_FinancialInstrumentType/TargetMarket/AbilityToBearLosses/CompatibleWithClientsWhoCanBearLossBeyondCapital</a> |

|           | <a href="#">EMT_V41_FinancialInstrumentType/TargetMarket/AbilityToBearLosses/CompatibleWithClientsWhoCanBearLossBeyondCapital</a><br><a href="#">EMT_V3_FinancialInstrumentType/TargetMarket/AbilityToBearLosses/CompatibleWithClientsWhoCanBearLossBeyondCapital</a><br><a href="#">EMT_V3_FinancialInstrumentType/TargetMarket/AbilityToBearLosses/CompatibleWithClientsWhoCanNotBearCapitalLoss</a><br><a href="#">EMT_V4_FinancialInstrumentType/TargetMarket/AbilityToBearLosses/CompatibleWithClientsWhoCanNotBearCapitalLoss</a><br><a href="#">EMT_V41_FinancialInstrumentType/TargetMarket/AbilityToBearLosses/CompatibleWithClientsWhoCanNotBearCapitalLoss</a><br><a href="#">EMT_V4_FinancialInstrumentType/TargetMarket/AbilityToBearLosses/CompatibleWithClientsWhoDoNotNeedCapitalGuarantee</a><br><a href="#">EMT_V41_FinancialInstrumentType/TargetMarket/AbilityToBearLosses/CompatibleWithClientsWhoDoNotNeedCapitalGuarantee</a><br><a href="#">EMT_V3_FinancialInstrumentType/TargetMarket/AbilityToBearLosses/CompatibleWithClientsWhoDoNotNeedCapitalGuarantee</a> <a href="#">EMTFinancialInstrumentType/InvestorType/EligibleCounterparty</a><br><a href="#">EMT_V4_FinancialInstrumentType/TargetMarket/KnowledgeAndExperience/ExpertInvestorGermany</a><br><a href="#">EMT_V3_FinancialInstrumentType/TargetMarket/KnowledgeAndExperience/ExpertInvestorGermany</a><br><a href="#">EMTFinancialInstrumentType/KnowledgeAndExperience/ExpertInvestorGermany</a><br><a href="#">EMT_V41_FinancialInstrumentType/TargetMarket/KnowledgeAndExperience/ExpertInvestorGermany</a><br><a href="#">EMTFinancialInstrumentType/ClientObjectives/ReturnProfile/Growth</a><br><a href="#">EMT_V4_FinancialInstrumentType/TargetMarket/ClientObjectives/ReturnProfile/StructuredSecurity/Hedging</a> <a href="#">EMTFinancialInstrumentType/ClientObjectives/ReturnProfile/Hedging</a><br><a href="#">EMT_V41_FinancialInstrumentType/TargetMarket/ClientObjectives/ReturnProfile/StructuredSecurity/Hedging</a><br><a href="#">EMT_V3_FinancialInstrumentType/TargetMarket/ClientObjectives/ReturnProfile/StructuredSecurity/Hedging</a> <a href="#">EMTFinancialInstrumentType/ClientObjectives/ReturnProfile/Income</a><br><a href="#">EMT_V41_FinancialInstrumentType/TargetMarket/KnowledgeAndExperience/InformedInvestor</a><br><a href="#">EMT_V3_FinancialInstrumentType/TargetMarket/KnowledgeAndExperience/InformedInvestor</a><br><a href="#">EMT_V4_FinancialInstrumentType/TargetMarket/KnowledgeAndExperience/InformedInvestor</a><br><a href="#">EMTFinancialInstrumentType/KnowledgeAndExperience/InformedInvestor</a><br><a href="#">EMTFinancialInstrumentType/AbilityToBearLosses/LimitedCapitalLoss</a><br><a href="#">EMTFinancialInstrumentType/AbilityToBearLosses/LossBeyondCapital</a><br><a href="#">EMTFinancialInstrumentType/ClientObjectives/MayBeTerminatedEarly</a><br><a href="#">EMTFinancialInstrumentType/AbilityToBearLosses/NoCapitalGuarantee</a><br><a href="#">EMTFinancialInstrumentType/AbilityToBearLosses/NoCapitalLoss</a><br><a href="#">EMTFinancialInstrumentType/ClientObjectives/ReturnProfile/OptionOrLeveraged</a><br><a href="#">EMT_V4_FinancialInstrumentType/TargetMarket/ClientObjectives/ReturnProfile/OptionOrLeveraged</a><br><a href="#">EMT_V41_FinancialInstrumentType/TargetMarket/ClientObjectives/ReturnProfile/OptionOrLeveraged</a><br><a href="#">EMT_V3_FinancialInstrumentType/TargetMarket/ClientObjectives/ReturnProfile/OptionOrLeveraged</a><br><a href="#">EMTFinancialInstrumentType/ClientObjectives/ReturnProfile/PensionSchemeGermany</a><br><a href="#">EMT_V4_FinancialInstrumentType/TargetMarket/ClientObjectives/ReturnProfile/PensionSchemeGermany</a><br><a href="#">EMT_V41_FinancialInstrumentType/TargetMarket/ClientObjectives/ReturnProfile/PensionSchemeGermany</a><br><a href="#">EMT_V3_FinancialInstrumentType/TargetMarket/ClientObjectives/ReturnProfile/PensionSchemeGermany</a><br><a href="#">EMTFinancialInstrumentType/ClientObjectives/ReturnProfile/Preservation</a><br><a href="#">EMTFinancialInstrumentType/InvestorType/Retail</a><br><a href="#">EMT_V41_FinancialInstrumentType/TargetMarket/InvestorType/Retail</a><br><a href="#">EMT_V4_FinancialInstrumentType/TargetMarket/InvestorType/Retail</a><br><a href="#">EMT_V3_FinancialInstrumentType/TargetMarket/InvestorType/Retail</a> |            |       |            |           |   |  |           |   |  |
|-----------|---|------------|-------|------------|-----------|---|--|-----------|---|--|
| facets    | <table border="1"> <thead> <tr> <th>Kind</th> <th>Value</th> <th>annotation</th> </tr> </thead> <tbody> <tr> <td>minLength</td> <td>1</td> <td></td> </tr> <tr> <td>maxLength</td> <td>7</td> <td></td> </tr> </tbody> </table>   | Kind       | Value | annotation | minLength | 1 |  | maxLength | 7 |  |
| Kind      | Value   | annotation |       |            |           |   |  |           |   |  |
| minLength | 1   |            |       |            |           |   |  |           |   |  |
| maxLength | 7   |            |       |            |           |   |  |           |   |  |

### simpleType **EMTYesNoType**

| type       | restriction of <b>xs:string</b>   |          |  |  |   |  |  |  |   |  |   |  |  |  |   |  |   |  |  |
|------------|---|----------|--|--|---|--|--|--|---|--|---|--|--|--|---|--|---|--|--|
| properties | base <b>xs:string</b>   |          |  |  |   |  |  |  |   |  |   |  |  |  |   |  |   |  |  |
| used by    | <table border="1"> <thead> <tr> <th>elements</th> <th></th> </tr> </thead> <tbody> <tr> <td></td> <td><a href="#">EMT_V4_FinancialInstrumentType/DataSetInformation/DataReportingExAnte</a></td> </tr> <tr> <td></td> <td><a href="#">EMT_V41_FinancialInstrumentType/DataSetInformation/DataReportingExAnte</a></td> </tr> <tr> <td></td> <td><a href="#">EMT_V3_FinancialInstrumentType/DataSetInformation/DataReportingExAnte</a></td> </tr> <tr> <td></td> <td><a href="#">EMT_V4_FinancialInstrumentType/DataSetInformation/DataReportingExPost</a></td> </tr> <tr> <td></td> <td><a href="#">EMT_V41_FinancialInstrumentType/DataSetInformation/DataReportingExPost</a></td> </tr> <tr> <td></td> <td><a href="#">EMT_V3_FinancialInstrumentType/DataSetInformation/DataReportingExPost</a></td> </tr> <tr> <td></td> <td><a href="#">EMT_V4_FinancialInstrumentType/DataSetInformation/DataReportingTargetMarket</a></td> </tr> <tr> <td></td> <td><a href="#">EMT_V41_FinancialInstrumentType/DataSetInformation/DataReportingTargetMarket</a></td> </tr> </tbody> </table> | elements |  |  | <a href="#">EMT_V4_FinancialInstrumentType/DataSetInformation/DataReportingExAnte</a> |  | <a href="#">EMT_V41_FinancialInstrumentType/DataSetInformation/DataReportingExAnte</a> |  | <a href="#">EMT_V3_FinancialInstrumentType/DataSetInformation/DataReportingExAnte</a> |  | <a href="#">EMT_V4_FinancialInstrumentType/DataSetInformation/DataReportingExPost</a> |  | <a href="#">EMT_V41_FinancialInstrumentType/DataSetInformation/DataReportingExPost</a> |  | <a href="#">EMT_V3_FinancialInstrumentType/DataSetInformation/DataReportingExPost</a> |  | <a href="#">EMT_V4_FinancialInstrumentType/DataSetInformation/DataReportingTargetMarket</a> |  | <a href="#">EMT_V41_FinancialInstrumentType/DataSetInformation/DataReportingTargetMarket</a> |
| elements   |   |          |  |  |   |  |  |  |   |  |   |  |  |  |   |  |   |  |  |
|            | <a href="#">EMT_V4_FinancialInstrumentType/DataSetInformation/DataReportingExAnte</a>   |          |  |  |   |  |  |  |   |  |   |  |  |  |   |  |   |  |  |
|            | <a href="#">EMT_V41_FinancialInstrumentType/DataSetInformation/DataReportingExAnte</a>  |          |  |  |   |  |  |  |   |  |   |  |  |  |   |  |   |  |  |
|            | <a href="#">EMT_V3_FinancialInstrumentType/DataSetInformation/DataReportingExAnte</a>   |          |  |  |   |  |  |  |   |  |   |  |  |  |   |  |   |  |  |
|            | <a href="#">EMT_V4_FinancialInstrumentType/DataSetInformation/DataReportingExPost</a>   |          |  |  |   |  |  |  |   |  |   |  |  |  |   |  |   |  |  |
|            | <a href="#">EMT_V41_FinancialInstrumentType/DataSetInformation/DataReportingExPost</a>  |          |  |  |   |  |  |  |   |  |   |  |  |  |   |  |   |  |  |
|            | <a href="#">EMT_V3_FinancialInstrumentType/DataSetInformation/DataReportingExPost</a>   |          |  |  |   |  |  |  |   |  |   |  |  |  |   |  |   |  |  |
|            | <a href="#">EMT_V4_FinancialInstrumentType/DataSetInformation/DataReportingTargetMarket</a>   |          |  |  |   |  |  |  |   |  |   |  |  |  |   |  |   |  |  |
|            | <a href="#">EMT_V41_FinancialInstrumentType/DataSetInformation/DataReportingTargetMarket</a>  |          |  |  |   |  |  |  |   |  |   |  |  |  |   |  |   |  |  |

|            |  |
|------------|--|
|            | <a href="#">EMT_V3_FinancialInstrumentType/DataSetInformation/DataReportingTargetMarket</a><br><a href="#">EMT_V4_FinancialInstrumentType/TargetMarket/InvestorType/EligibleCounterparty</a><br><a href="#">EMT_V41_FinancialInstrumentType/TargetMarket/InvestorType/EligibleCounterparty</a><br><a href="#">EMT_V3_FinancialInstrumentType/TargetMarket/InvestorType/EligibleCounterparty</a><br><a href="#">EMT_V4_FinancialInstrumentType/GeneralInformation/Fund/FundShareClassWithoutRetrocession</a><br><a href="#">EMT_V41_FinancialInstrumentType/GeneralInformation/Fund/FundShareClassWithoutRetrocession</a><br><a href="#">EMT_V3_FinancialInstrumentType/GeneralInformation/Fund/FundShareClassWithoutRetrocession</a><br><a href="#">EMT_V4_FinancialInstrumentType/GeneralInformation/InstrumentDistributionCash</a><br><a href="#">EMT_V41_FinancialInstrumentType/GeneralInformation/InstrumentDistributionCash</a><br><a href="#">EMT_V3_FinancialInstrumentType/GeneralInformation/InstrumentDistributionCash</a><br><a href="#">EMT_V4_FinancialInstrumentType/GeneralInformation/InstrumentPerformanceFee</a><br><a href="#">EMT_V41_FinancialInstrumentType/GeneralInformation/InstrumentPerformanceFee</a><br><a href="#">EMT_V3_FinancialInstrumentType/GeneralInformation/InstrumentPerformanceFee</a><br><a href="#">EMT_V41_FinancialInstrumentType/AdditionalInformationUK/ValueForMoney/IsAssessmentOfValueRequiredUnderCOLL</a><br><a href="#">EMT_V4_FinancialInstrumentType/GeneralInformation/LeveragedOrContingentLiability</a><br><a href="#">EMT_V41_FinancialInstrumentType/GeneralInformation/LeveragedOrContingentLiability</a><br><a href="#">EMT_V3_FinancialInstrumentType/GeneralInformation/LeveragedOrContingentLiability</a><br><a href="#">EMT_V4_FinancialInstrumentType/GeneralInformation/MaybeTerminatedEarly</a><br><a href="#">EMT_V41_FinancialInstrumentType/GeneralInformation/MaybeTerminatedEarly</a><br><a href="#">EMT_V3_FinancialInstrumentType/GeneralInformation/MaybeTerminatedEarly</a> |
| facets     | Kind Value annotation<br>length 1  |
| annotation | documentation<br>Y or N  |

### simpleType RetailProfessionalBothNeitherType

|            |  |
|------------|--|
| type       | restriction of <b>xs:string</b>  |
| properties | base <b>xs:string</b>  |
| used by    | elements<br><a href="#">EMT_V4_FinancialInstrumentType/TargetMarket/DistributionStrategy/ExecutionOnly</a><br><a href="#">EMT_V41_FinancialInstrumentType/TargetMarket/DistributionStrategy/ExecutionOnly</a><br><a href="#">EMTFinancialInstrumentType/DistributionStrategy/ExecutionOnly</a><br><a href="#">EMT_V3_FinancialInstrumentType/TargetMarket/DistributionStrategy/ExecutionOnly</a><br><a href="#">EMT_V4_FinancialInstrumentType/TargetMarket/DistributionStrategy/ExecutionWithCheckOrNonAdvisedServices</a><br><a href="#">EMT_V41_FinancialInstrumentType/TargetMarket/DistributionStrategy/ExecutionWithCheckOrNonAdvisedServices</a><br><a href="#">EMTFinancialInstrumentType/DistributionStrategy/ExecutionWithCheckOrNonAdvisedServices</a><br><a href="#">EMT_V3_FinancialInstrumentType/TargetMarket/DistributionStrategy/ExecutionWithCheckOrNonAdvisedServices</a><br><a href="#">EMT_V4_FinancialInstrumentType/TargetMarket/DistributionStrategy/InvestmentAdvice</a><br><a href="#">EMT_V41_FinancialInstrumentType/TargetMarket/DistributionStrategy/InvestmentAdvice</a><br><a href="#">EMTFinancialInstrumentType/DistributionStrategy/InvestmentAdvice</a><br><a href="#">EMT_V3_FinancialInstrumentType/TargetMarket/DistributionStrategy/InvestmentAdvice</a><br><a href="#">EMT_V4_FinancialInstrumentType/TargetMarket/DistributionStrategy/PortfolioManagement</a><br><a href="#">EMT_V41_FinancialInstrumentType/TargetMarket/DistributionStrategy/PortfolioManagement</a><br><a href="#">EMTFinancialInstrumentType/DistributionStrategy/PortfolioManagement</a><br><a href="#">EMT_V3_FinancialInstrumentType/TargetMarket/DistributionStrategy/PortfolioManagement</a> |
| facets     | Kind Value annotation<br>length 1  |

### complexType KIIDsType

|          |   |
|----------|---|
| diagram  |   |
| children | <a href="#">KIID</a>                              |
| used by  | element <a href="#">DirectReportingType/KIIDs</a> |



element **KIIDType/KIID**

diagram

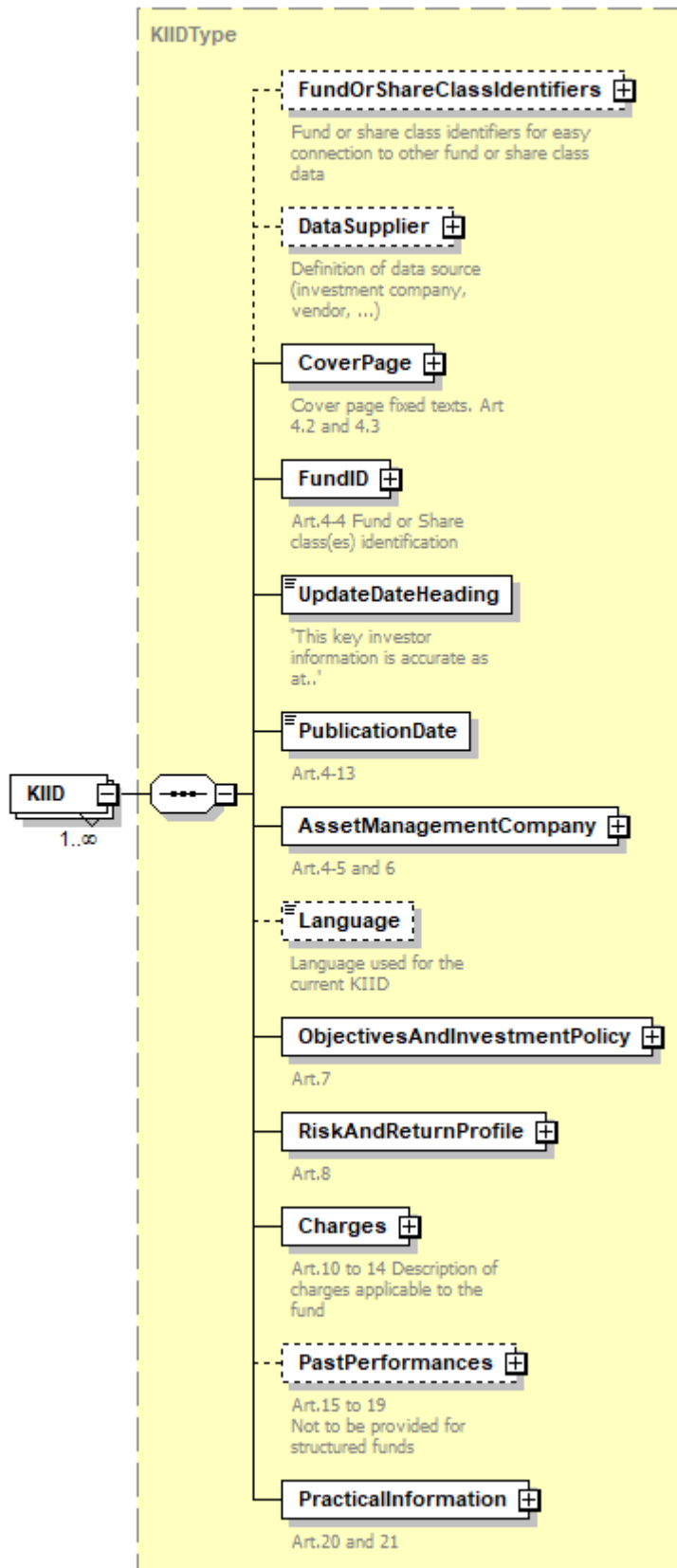

|            |  |
|------------|--|
| type       | <a href="#"><b>KLIDType</b></a>  |
| properties | isRef 0<br>minOcc 1<br>maxOcc unbounded<br>content complex   |
| children   | <a href="#">FundOrShareClassIdentifiers</a> <a href="#">DataSupplier</a> <a href="#">CoverPage</a> <a href="#">FundID</a> <a href="#">UpdateDateHeading</a> <a href="#">PublicationDate</a><br><a href="#">AssetManagementCompany</a> <a href="#">Language</a> <a href="#">ObjectivesAndInvestmentPolicy</a> <a href="#">RiskAndReturnProfile</a> <a href="#">Charges</a><br><a href="#">PastPerformances</a> <a href="#">PracticalInformation</a> |

complexType **KIIDType**

diagram

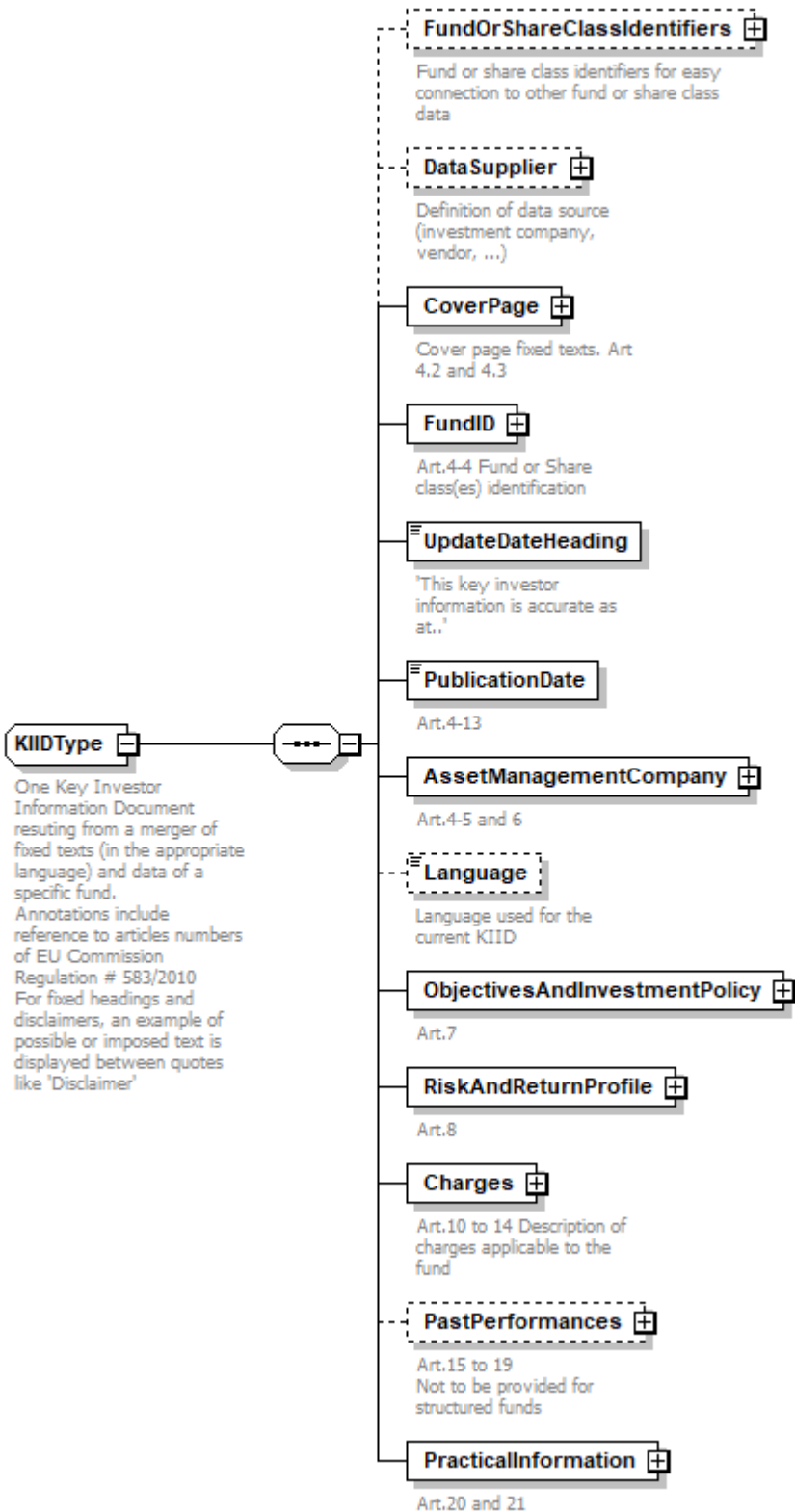

children

[FundOrShareClassIdentifiers](#) [DataSupplier](#) [CoverPage](#) [FundID](#) [UpdateDateHeading](#) [PublicationDate](#) [AssetManagementCompany](#) [Language](#) [ObjectivesAndInvestmentPolicy](#) [RiskAndReturnProfile](#) [Charges](#)

|            |  |
|------------|--|
|            | <a href="#">PastPerformances PracticalInformation</a>  |
| used by    | element <a href="#">KIIDsType/KIID</a>   |
| annotation | documentation<br>One Key Investor Information Document resulting from a merger of fixed texts (in the appropriate language) and data of a specific fund.<br>Annotations include reference to articles numbers of EU Commission Regulation # 583/2010<br>For fixed headings and disclaimers, an example of possible or imposed text is displayed between quotes like 'Disclaimer' |

element **KIIDType/FundOrShareClassIdentifiers**

|            |  |
|------------|--|
| diagram    | <p>The diagram illustrates the structure of the <b>FundOrShareClassIdentifiersType</b>. It is represented as a dashed box containing two elements: <b>LEI</b> (Legal Entity Identifier of fund) and <b>ISINs</b> (List of ISINs for share classes). A separate dashed box labeled <b>FundOrShareClassIdentifiers</b> is connected to the main type via a solid line with a small square at the end, indicating a reference relationship. Below the <b>FundOrShareClassIdentifiers</b> box, there is a note: "Fund or share class identifiers for easy connection to other fund or share class data".</p> |
| type       | <a href="#">FundOrShareClassIdentifiersType</a>  |
| properties | isRef 0<br>minOcc 0<br>maxOcc 1<br>content complex   |
| children   | <a href="#">LEI</a> <a href="#">ISINs</a>  |
| annotation | documentation<br>Fund or share class identifiers for easy connection to other fund or share class data   |



element **KIIDType/DataSupplier**

|                   |  |
|-------------------|--|
| <p>diagram</p>    |  |
| <p>type</p>       | <p><a href="#">DataSupplierType</a></p>  |
| <p>properties</p> | <p>isRef 0<br/>minOcc 0<br/>maxOcc 1<br/>content complex</p>   |
| <p>children</p>   | <p><a href="#">SystemCountry</a> <a href="#">Short</a> <a href="#">Name</a> <a href="#">Type</a> <a href="#">Contact</a></p> |
| <p>annotation</p> | <p>documentation<br/>Definition of data source (investment company, vendor, ...)</p>   |

element **KIIDType/CoverPage**

|                   |   |
|-------------------|---|
| <p>diagram</p>    |   |
| <p>properties</p> | <p>isRef 0<br/>content complex</p>                                  |
| <p>children</p>   | <p><a href="#">KIIDHeading</a> <a href="#">GlobalDisclaimer</a></p> |
| <p>annotation</p> | <p>documentation<br/>Cover page fixed texts. Art 4.2 and 4.3</p>    |

element **KIIDType/CoverPage/KIIDHeading**

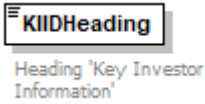
|            |   |
|------------|---|
| diagram    |  |
| type       | <b>xs:string</b>  |
| properties | isRef 0<br>content simple   |
| annotation | documentation<br>Heading 'Key Investor Information'                               |

element **KIIDType/CoverPage/GlobalDisclaimer**

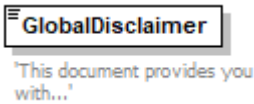
|            |   |
|------------|---|
| diagram    |  |
| type       | <b>xs:string</b>  |
| properties | isRef 0<br>content simple   |
| annotation | documentation<br>'This document provides you with...'                             |

element **KIIDType/FundID**

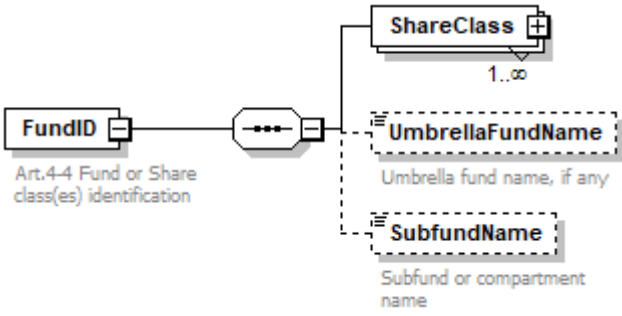
|            |   |
|------------|---|
| diagram    |      |
| properties | isRef 0<br>content complex  |
| children   | <a href="#">ShareClass</a> <a href="#">UmbrellaFundName</a> <a href="#">SubfundName</a> |
| annotation | documentation<br>Art.4-4 Fund or Share class(es) identification                         |

element **KIIDType/FundID/ShareClass**

|            |  |       |   |        |   |        |           |         |         |
|------------|--|-------|---|--------|---|--------|-----------|---------|---------|
| diagram    |  |       |   |        |   |        |           |         |         |
| properties | <table> <tr><td>isRef</td><td>0</td></tr> <tr><td>minOcc</td><td>1</td></tr> <tr><td>maxOcc</td><td>unbounded</td></tr> <tr><td>content</td><td>complex</td></tr> </table> | isRef | 0 | minOcc | 1 | maxOcc | unbounded | content | complex |
| isRef      | 0  |       |   |        |   |        |           |         |         |
| minOcc     | 1  |       |   |        |   |        |           |         |         |
| maxOcc     | unbounded  |       |   |        |   |        |           |         |         |
| content    | complex  |       |   |        |   |        |           |         |         |
| children   | <a href="#">ShareClassName</a> <a href="#">ShareClassIsinHeading</a> <a href="#">ShareClassISIN</a> <a href="#">MainShareClassIndicator</a>                                |       |   |        |   |        |           |         |         |

element **KIIDType/FundID/ShareClass/ShareClassName**

|            |   |       |   |         |        |
|------------|---|-------|---|---------|--------|
| diagram    |   |       |   |         |        |
| type       | <b>xs:string</b>  |       |   |         |        |
| properties | <table> <tr><td>isRef</td><td>0</td></tr> <tr><td>content</td><td>simple</td></tr> </table> | isRef | 0 | content | simple |
| isRef      | 0   |       |   |         |        |
| content    | simple  |       |   |         |        |

element **KIIDType/FundID/ShareClass/ShareClassIsinHeading**

|            |   |       |   |         |        |
|------------|---|-------|---|---------|--------|
| diagram    |   |       |   |         |        |
| type       | <b>xs:string</b>  |       |   |         |        |
| properties | <table> <tr><td>isRef</td><td>0</td></tr> <tr><td>content</td><td>simple</td></tr> </table> | isRef | 0 | content | simple |
| isRef      | 0   |       |   |         |        |
| content    | simple  |       |   |         |        |
| annotation | documentation<br>'ISIN:'  |       |   |         |        |

element **KIIDType/FundID/ShareClass/ShareClassISIN**

|            |   |       |   |         |        |
|------------|---|-------|---|---------|--------|
| diagram    |   |       |   |         |        |
| type       | <b>xs:string</b>  |       |   |         |        |
| properties | <table> <tr><td>isRef</td><td>0</td></tr> <tr><td>content</td><td>simple</td></tr> </table> | isRef | 0 | content | simple |
| isRef      | 0   |       |   |         |        |
| content    | simple  |       |   |         |        |
| annotation | documentation<br>ISIN code of the share class   |       |   |         |        |

element **KIIDType/FundID/ShareClass/MainShareClassIndicator**

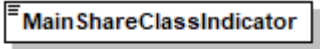
|            |   |
|------------|---|
| diagram    |  <p>Indicator set to true if the current share class is the main share class. Performances and risk indicator are computed with the main share class data.</p> |
| type       | <b>xs:boolean</b>   |
| properties | isRef 0<br>content simple   |
| annotation | documentation<br>Indicator set to true if the current share class is the main share class. Performances and risk indicator are computed with the main share class data.   |

element **KIIDType/FundID/UmbrellaFundName**

|            |   |
|------------|---|
| diagram    |  <p>Umbrella fund name, if any</p> |
| type       | <b>xs:string</b>  |
| properties | isRef 0<br>minOcc 0<br>maxOcc 1<br>content simple   |
| annotation | documentation<br>Umbrella fund name, if any   |

element **KIIDType/FundID/SubfundName**

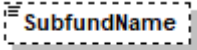
|            |  |
|------------|--|
| diagram    |  <p>Subfund or compartment name</p> |
| type       | <b>xs:string</b>   |
| properties | isRef 0<br>minOcc 0<br>maxOcc 1<br>content simple  |
| annotation | documentation<br>Subfund or compartment name   |

element **KIIDType/UpdateDateHeading**

|            |  |
|------------|--|
| diagram    |  <p>'This key investor information is accurate as at..'</p> |
| type       | <b>xs:string</b>   |
| properties | isRef 0<br>content simple  |
| annotation | documentation<br>'This key investor information is accurate as at..'   |

element **KIIDType/PublicationDate**

|            |  |
|------------|--|
| diagram    |  <p><b>PublicationDate</b><br/>Art.4-13</p> |
| type       | <b>xs:date</b>   |
| properties | isRef 0<br>content simple  |
| annotation | documentation<br>Art.4-13  |

element **KIIDType/AssetManagementCompany**

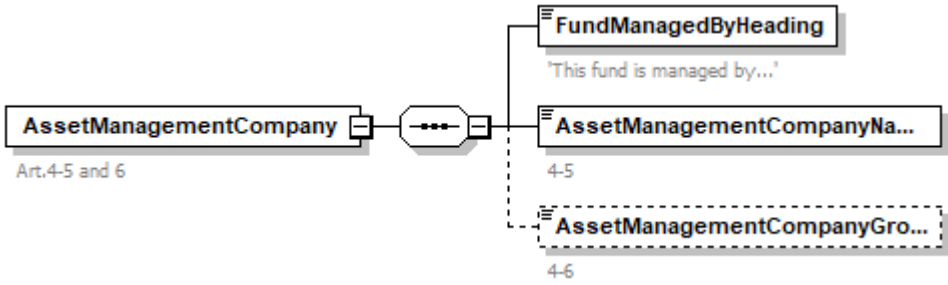
|            |  |
|------------|--|
| diagram    |  <p><b>AssetManagementCompany</b><br/>Art.4-5 and 6</p> <p><b>FundManagedByHeading</b><br/>'This fund is managed by...'</p> <p><b>AssetManagementCompanyNa...</b><br/>4-5</p> <p><b>AssetManagementCompanyGro...</b><br/>4-6</p> |
| properties | isRef 0<br>content complex   |
| children   | <a href="#">FundManagedByHeading</a> <a href="#">AssetManagementCompanyName</a> <a href="#">AssetManagementCompanyGroupName</a>  |
| annotation | documentation<br>Art.4-5 and 6   |

element **KIIDType/AssetManagementCompany/FundManagedByHeading**

|            |   |
|------------|---|
| diagram    |  <p><b>FundManagedByHeading</b><br/>'This fund is managed by...'</p> |
| type       | <b>xs:string</b>  |
| properties | isRef 0<br>content simple   |
| annotation | documentation<br>'This fund is managed by...'   |

element **KIIDType/AssetManagementCompany/AssetManagementCompanyName**

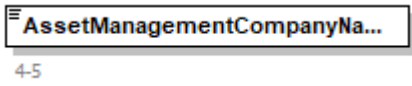
|            |   |
|------------|---|
| diagram    |  <p><b>AssetManagementCompanyNa...</b><br/>4-5</p> |
| type       | <b>xs:string</b>  |
| properties | isRef 0<br>content simple   |
| annotation | documentation<br>4-5  |

element **KIIDType/AssetManagementCompany/AssetManagementCompanyName**

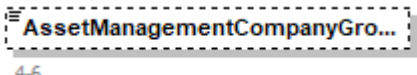
|            |  |
|------------|--|
| diagram    |  <p>The diagram shows a rectangular box with a dashed border containing the text "AssetManagementCompanyGro...". Below the box is the number "4-6".</p> |
| type       | <b>xs:string</b>   |
| properties | isRef 0<br>minOcc 0<br>maxOcc 1<br>content simple  |
| annotation | documentation<br>4-6   |

element **KIIDType/Language**

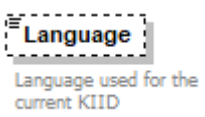
|            |   |
|------------|---|
| diagram    |  <p>The diagram shows a rectangular box with a dashed border containing the text "Language". Below the box is the text "Language used for the current KIID".</p> |
| type       | <b>xs:string</b>  |
| properties | isRef 0<br>minOcc 0<br>maxOcc 1<br>content simple   |
| annotation | documentation<br>Language used for the current KIID   |

element **KIIDType/ObjectivesAndInvestmentPolicy**

|                   |  |
|-------------------|--|
| <p>diagram</p>    |  |
| <p>properties</p> | <p>isRef 0<br/>content complex</p>   |
| <p>children</p>   | <p><a href="#">Heading</a> <a href="#">GeneralStrategyDescription</a> <a href="#">MainAssetsHeading</a> <a href="#">FinancialInstruments</a> <a href="#">DealingFrequencyHeading</a> <a href="#">DealingFrequency</a> <a href="#">DistributionPolicyHeading</a> <a href="#">DistributionPolicy</a> <a href="#">Benchmark</a> <a href="#">OtherInformationOnStrategy</a> <a href="#">StructuredFundSpecialInformation</a></p> |
| <p>annotation</p> | <p>documentation<br/>Art.7</p>   |

element **KIIDType/ObjectivesAndInvestmentPolicy/Heading**

|            |   |
|------------|---|
| diagram    |   |
| type       | <b>xs:string</b>                                    |
| properties | isRef 0<br>content simple                           |
| annotation | documentation<br>'Objectives and Investment Policy' |

element **KIIDType/ObjectivesAndInvestmentPolicy/GeneralStrategyDescription**

|            |   |
|------------|---|
| diagram    |   |
| type       | <b>xs:string</b>                                  |
| properties | isRef 0<br>minOcc 0<br>maxOcc 1<br>content simple |
| annotation | documentation<br>7-1 complement an/or 7-4         |

element **KIIDType/ObjectivesAndInvestmentPolicy/MainAssetsHeading**

|            |   |
|------------|---|
| diagram    |   |
| type       | <b>xs:string</b>                              |
| properties | isRef 0<br>content simple                     |
| annotation | documentation<br>7-1a 'Main asset categories' |

element **KIIDType/ObjectivesAndInvestmentPolicy/FinancialInstruments**

|            |  |
|------------|--|
| diagram    |  |
| properties | isRef 0<br>minOcc 1<br>maxOcc unbounded<br>content complex                           |
| children   | <a href="#">InstrumentCategoryCode</a> <a href="#">InstrumentCategoryDescription</a> |
| annotation | documentation<br>7-1a Instruments categories the fund may invest in                  |

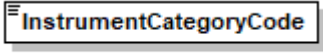

element **KIIDType/ObjectivesAndInvestmentPolicy/FinancialInstruments/InstrumentCategoryCode**

|            |  |
|------------|--|
| diagram    |  <p>InstrumentCategoryCode<br/>Category of eligible instruments</p> |
| type       | <b>xs:string</b>   |
| properties | isRef 0<br>content simple  |
| annotation | documentation<br>Category of eligible instruments  |

element

**KIIDType/ObjectivesAndInvestmentPolicy/FinancialInstruments/InstrumentCategoryDescription**

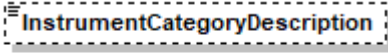
|            |   |
|------------|---|
| diagram    |  <p>InstrumentCategoryDescription<br/>1-7-1c - Description of instrument category selection criteria (geographical, economic, market, ...)</p> |
| type       | <b>xs:string</b>  |
| properties | isRef 0<br>minOcc 0<br>maxOcc 1<br>content simple   |
| annotation | documentation<br>1-7-1c - Description of instrument category selection criteria (geographical, economic, market, ...)   |

element **KIIDType/ObjectivesAndInvestmentPolicy/DealingFrequencyHeading**

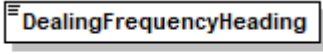
|            |  |
|------------|--|
| diagram    |  <p>DealingFrequencyHeading<br/>7-1b 'Frequency of Subscription/redemption: '</p> |
| type       | <b>xs:string</b>   |
| properties | isRef 0<br>content simple  |
| annotation | documentation<br>7-1b 'Frequency of Subscription/redemption: '   |

element **KIIDType/ObjectivesAndInvestmentPolicy/DealingFrequency**

|            |  |
|------------|--|
| diagram    |  <p>DealingFrequency<br/>7-1b Dealing frequency for subscription/redemption (daily, weekly, monthly, ...)</p> |
| type       | <b>xs:string</b>   |
| properties | isRef 0<br>content simple  |
| annotation | documentation<br>7-1b Dealing frequency for subscription/redemption (daily, weekly, monthly, ...)  |

element **KIIDType/ObjectivesAndInvestmentPolicy/DistributionPolicyHeading**

|            |  |
|------------|--|
| diagram    | <p><b>DistributionPolicyHeading</b><br/>7-1e 'Distribution policy: '</p> |
| type       | <b>xs:string</b>   |
| properties | isRef 0<br>content simple  |
| annotation | documentation<br>7-1e 'Distribution policy: '                            |

element **KIIDType/ObjectivesAndInvestmentPolicy/DistributionPolicy**

|            |  |
|------------|--|
| diagram    | <p><b>DistributionPolicy</b><br/>7-1e Distribution or Capitalization description</p> |
| type       | <b>xs:string</b>   |
| properties | isRef 0<br>content simple  |
| annotation | documentation<br>7-1e Distribution or Capitalization description                     |

element **KIIDType/ObjectivesAndInvestmentPolicy/Benchmark**

|            |   |
|------------|---|
| diagram    | <p><b>Benchmark</b><br/>7-1d Reference to a benchmark</p> <p><b>BenchmarkHeading</b><br/>'The fund refers to the following benchmark: '</p> <p><b>BenchmarkName</b></p> <p><b>BenchmarkPolicy</b><br/>Description of the degree of freedom in relation to the benchmark</p> |
| properties | isRef 0<br>minOcc 0<br>maxOcc 1<br>content complex  |
| children   | <a href="#">BenchmarkHeading</a> <a href="#">BenchmarkName</a> <a href="#">BenchmarkPolicy</a>  |
| annotation | documentation<br>7-1d Reference to a benchmark  |

element **KIIDType/ObjectivesAndInvestmentPolicy/Benchmark/BenchmarkHeading**

|            |   |
|------------|---|
| diagram    | <p><b>BenchmarkHeading</b><br/>'The fund refers to the following benchmark: '</p> |
| type       | <b>xs:string</b>  |
| properties | isRef 0<br>content simple   |
| annotation | documentation   |

'The fund refers to the following benchmark: '

element **KIIDType/ObjectivesAndInvestmentPolicy/Benchmark/BenchmarkName**

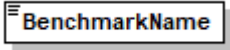
|            |   |
|------------|---|
| diagram    |  |
| type       | <b>xs:string</b>  |
| properties | isRef 0<br>content simple   |

element **KIIDType/ObjectivesAndInvestmentPolicy/Benchmark/BenchmarkPolicy**

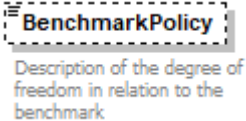
|            |  |
|------------|--|
| diagram    |   |
| type       | <b>xs:string</b>   |
| properties | isRef 0<br>minOcc 0<br>maxOcc 1<br>content simple                                  |
| annotation | documentation<br>Description of the degree of freedom in relation to the benchmark |

element **KIIDType/ObjectivesAndInvestmentPolicy/OtherInformationOnStrategy**

|            |  |
|------------|--|
| diagram    |  |
| properties | <p>isRef 0<br/> minOcc 0<br/> maxOcc 1<br/> content complex</p>  |
| children   | <p><a href="#">Heading</a> <a href="#">DebtSecuritiesDetails</a> <a href="#">AssetChoiceCriteria</a> <a href="#">SpecificTechniquesHeading</a> <a href="#">SpecificTechniquesDescription</a> <a href="#">TransactionsCostsStatement</a> <a href="#">MinimumRecommendedTermHeading</a> <a href="#">MinimumRecommendedTerm</a></p> |
| annotation | <p>documentation<br/> 7-2</p>  |

element **KIIDType/ObjectivesAndInvestmentPolicy/OtherInformationOnStrategy/Heading**

|            |   |
|------------|---|
| diagram    |   |
| type       | <p><b>xs:string</b></p>   |
| properties | <p>isRef 0<br/> content simple</p>                              |
| annotation | <p>documentation<br/> 'Additional information on strategy:'</p> |

element **KIIDType/ObjectivesAndInvestmentPolicy/OtherInformationOnStrategy/DebtSecuritiesDetails**

|            |  |
|------------|--|
| diagram    | <p>The diagram shows a central element labeled <b>DebtSecuritiesDetails</b> with the reference number 7-2a. It is connected via a line to a container element. From this container, two dashed boxes branch out: one labeled <b>IssuersAllowed</b> (7-2a) and another labeled <b>MinimumRating</b> (7-2a). The <b>IssuersAllowed</b> box contains the text: "7-2a Indication of issuers allowed: governments, corporate,..."</p> |
| properties | isRef 0<br>minOcc 0<br>maxOcc 1<br>content complex   |
| children   | <a href="#">IssuersAllowed</a> <a href="#">MinimumRating</a>   |
| annotation | documentation<br>7-2a  |

element **KIIDType/ObjectivesAndInvestmentPolicy/OtherInformationOnStrategy/DebtSecuritiesDetails/IssuersAllowed**

|            |   |
|------------|---|
| diagram    | <p>The diagram shows a dashed box labeled <b>IssuersAllowed</b> with the reference number 7-2a. Below the box is the text: "7-2a Indication of issuers allowed: governments, corporate,..."</p> |
| type       | <b>xs:string</b>  |
| properties | isRef 0<br>minOcc 0<br>maxOcc 1<br>content simple   |
| annotation | documentation<br>7-2a Indication of issuers allowed: governments, corporate,...   |

element **KIIDType/ObjectivesAndInvestmentPolicy/OtherInformationOnStrategy/DebtSecuritiesDetails/MinimumRating**

|            |  |
|------------|--|
| diagram    | <p>The diagram shows a dashed box labeled <b>MinimumRating</b> with the reference number 7-2a.</p> |
| type       | <b>xs:string</b>   |
| properties | isRef 0<br>minOcc 0<br>maxOcc 1<br>content simple  |
| annotation | documentation<br>7-2a  |

element **KIIDType/ObjectivesAndInvestmentPolicy/OtherInformationOnStrategy/AssetChoiceCriteria**

|            |   |
|------------|---|
| diagram    |  |
| type       | <b>xs:string</b>  |
| properties | isRef 0<br>minOcc 0<br>maxOcc 1<br>content simple                                 |
| annotation | documentation<br>7-2c Growth, Value or High dividends                             |

element **KIIDType/ObjectivesAndInvestmentPolicy/OtherInformationOnStrategy/SpecificTechniquesHeading**

|            |   |
|------------|---|
| diagram    |  |
| type       | <b>xs:string</b>  |
| properties | isRef 0<br>content simple   |
| annotation | documentation<br>7-2d 'Specific asset management techniques used: '               |

element **KIIDType/ObjectivesAndInvestmentPolicy/OtherInformationOnStrategy/SpecificTechniquesDescription**

|            |   |
|------------|---|
| diagram    |  |
| type       | <b>xs:string</b>  |
| properties | isRef 0<br>minOcc 0<br>maxOcc 1<br>content simple                                   |
| annotation | documentation<br>7-2d Eg. Hedging, arbitrage, leverage, etc.                        |

element **KIIDType/ObjectivesAndInvestmentPolicy/OtherInformationOnStrategy/TransactionsCostsStatement**

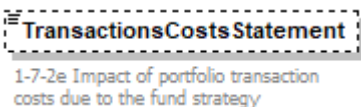
|            |  |
|------------|--|
| diagram    |     |
| type       | <b>xs:string</b>   |
| properties | isRef 0<br>minOcc 0<br>maxOcc 1<br>content simple                                      |
| annotation | documentation<br>1-7-2e Impact of portfolio transaction costs due to the fund strategy |

element

**KIIDType/ObjectivesAndInvestmentPolicy/OtherInformationOnStrategy/MinimumRecommendedTermHeading**

|            |   |
|------------|---|
| diagram    | <p><b>MinimumRecommendedTermH...</b><br/>7-1f 'Recommendation: this fund may not be appropriate for investors...'</p> |
| type       | <b>xs:string</b>  |
| properties | isRef 0<br>minOcc 0<br>maxOcc 1<br>content simple   |
| annotation | documentation<br>7-1f 'Recommendation: this fund may not be appropriate for investors...'.                            |

element

**KIIDType/ObjectivesAndInvestmentPolicy/OtherInformationOnStrategy/MinimumRecommendedTerm**

|            |   |
|------------|---|
| diagram    | <p><b>MinimumRecommendedTerm</b><br/>1-7-2f Statement on minimum holding period as an essential element</p> |
| type       | <b>xs:string</b>  |
| properties | isRef 0<br>minOcc 0<br>maxOcc 1<br>content simple   |
| annotation | documentation<br>1-7-2f Statement on minimum holding period as an essential element                         |

element **KIIDType/ObjectivesAndInvestmentPolicy/StructuredFundSpecialInformation**

|         |   |
|---------|---|
| diagram | <p><b>StructuredFundSpecialInformat...</b><br/>Art.7-2b and 36 Additional information for a structured fund</p> <ul style="list-style-type: none"> <li><b>StructuredFundExplanation</b><br/>Description of elements necessary for a correct understanding of the pay-off</li> <li><b>PerformanceFactors</b></li> <li><b>AlgorithmDescription</b><br/>References to the details of the algorithm (reference to the prospectus)</li> <li><b>PerformanceScenario</b> <span style="border: 1px solid black; padding: 2px;">+</span><br/>1..∞<br/>Art.36</li> <li><b>ScenariosWarning</b><br/>36-6 Scenarios are just examples of possible situations</li> </ul> |
|---------|---|

|            |  |
|------------|--|
| properties | isRef 0<br>minOcc 0<br>maxOcc 1<br>content complex   |
| children   | <a href="#">StructuredFundExplanation</a> <a href="#">PerformanceFactors</a> <a href="#">AlgorithmDescription</a> <a href="#">PerformanceScenario</a> <a href="#">ScenariosWarning</a> |
| annotation | documentation<br>Art.7-2b and 36 Additional information for a structured fund  |

element

**KIIDType/ObjectivesAndInvestmentPolicy/StructuredFundSpecialInformation/StructuredFundExplanation**

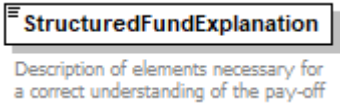
|            |  |
|------------|--|
| diagram    |  <p><b>StructuredFundExplanation</b><br/>Description of elements necessary for a correct understanding of the pay-off</p> |
| type       | <b>xs:string</b>   |
| properties | isRef 0<br>content simple  |
| annotation | documentation<br>Description of elements necessary for a correct understanding of the pay-off  |

element

**KIIDType/ObjectivesAndInvestmentPolicy/StructuredFundSpecialInformation/PerformanceFactors**

|            |   |
|------------|---|
| diagram    |  <p><b>PerformanceFactors</b></p> |
| type       | <b>xs:string</b>  |
| properties | isRef 0<br>content simple   |

element

**KIIDType/ObjectivesAndInvestmentPolicy/StructuredFundSpecialInformation/AlgorithmDescription**

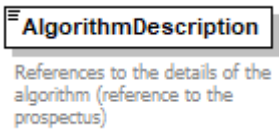
|            |   |
|------------|---|
| diagram    |  <p><b>AlgorithmDescription</b><br/>References to the details of the algorithm (reference to the prospectus)</p> |
| type       | <b>xs:string</b>  |
| properties | isRef 0<br>content simple   |
| annotation | documentation<br>References to the details of the algorithm (reference to the prospectus)   |



element

**KIIDType/ObjectivesAndInvestmentPolicy/StructuredFundSpecialInformation/PerformanceScenario**

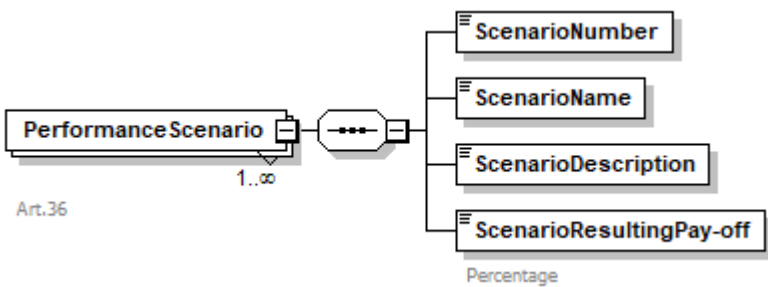
|            |  |
|------------|--|
| diagram    |  <p>The diagram shows the 'PerformanceScenario' element (Art.36) with a multiplicity of 1..∞. It is connected to a container element (hexagon with three dots) which contains four child elements: 'ScenarioNumber', 'ScenarioName', 'ScenarioDescription', and 'ScenarioResultingPay-off'. The 'ScenarioResultingPay-off' element is annotated with 'Percentage'.</p> |
| properties | isRef 0<br>minOcc 1<br>maxOcc unbounded<br>content complex   |
| children   | <a href="#">ScenarioNumber</a> <a href="#">ScenarioName</a> <a href="#">ScenarioDescription</a> <a href="#">ScenarioResultingPay-off</a>   |
| annotation | documentation<br>Art.36  |

element

**KIIDType/ObjectivesAndInvestmentPolicy/StructuredFundSpecialInformation/PerformanceScenario/ScenarioNumber**

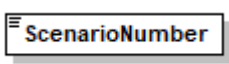
|            |  |
|------------|--|
| diagram    |  <p>The diagram shows the 'ScenarioNumber' element.</p> |
| type       | <b>xs:int</b>  |
| properties | isRef 0<br>content simple  |

element

**KIIDType/ObjectivesAndInvestmentPolicy/StructuredFundSpecialInformation/PerformanceScenario/ScenarioName**

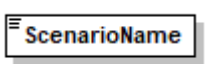
|            |  |
|------------|--|
| diagram    |  <p>The diagram shows the 'ScenarioName' element.</p> |
| type       | <b>xs:string</b>   |
| properties | isRef 0<br>content simple  |

element

**KIIDType/ObjectivesAndInvestmentPolicy/StructuredFundSpecialInformation/PerformanceScenario/ScenarioDescription**

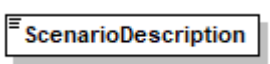
|            |   |
|------------|---|
| diagram    |  <p>The diagram shows the 'ScenarioDescription' element.</p> |
| type       | <b>xs:string</b>  |
| properties | isRef 0<br>content simple   |

element

**KIIDType/ObjectivesAndInvestmentPolicy/StructuredFundSpecialInformation/PerformanceScenario/ScenarioResultingPay-off**

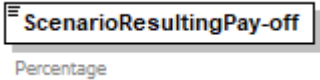
|            |   |
|------------|---|
| diagram    |  |
| type       | <b>xs:decimal</b>   |
| properties | isRef 0<br>content simple   |
| annotation | documentation<br>Percentage   |

element

**KIIDType/ObjectivesAndInvestmentPolicy/StructuredFundSpecialInformation/ScenariosWarning**

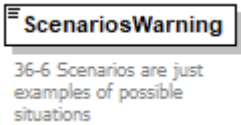
|            |   |
|------------|---|
| diagram    |  |
| type       | <b>xs:string</b>  |
| properties | isRef 0<br>content simple   |
| annotation | documentation<br>36-6 Scenarios are just examples of possible situations          |

element **KIIDType/RiskAndReturnProfile**

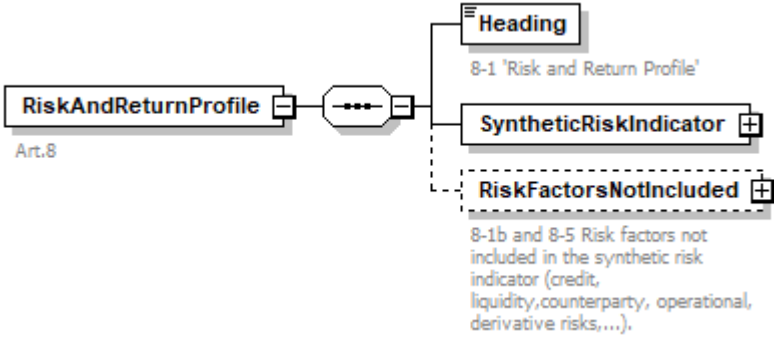
|            |   |
|------------|---|
| diagram    |                   |
| properties | isRef 0<br>content complex  |
| children   | <a href="#">Heading</a> <a href="#">SyntheticRiskIndicator</a> <a href="#">RiskFactorsNotIncluded</a> |
| annotation | documentation<br>Art.8  |

element **KIIDType/RiskAndReturnProfile/Heading**

|         |   |
|---------|---|
| diagram |  |
| type    | <b>xs:string</b>  |

|            |  |
|------------|--|
| properties | isRef 0<br>content simple                      |
| annotation | documentation<br>8-1 'Risk and Return Profile' |

element **KIIDType/RiskAndReturnProfile/SyntheticRiskIndicator**

|            |  |
|------------|--|
| diagram    |  |
| properties | isRef 0<br>content complex   |
| children   | <a href="#">RiskIndicatorLegend</a> <a href="#">SyntheticRiskIndicatorExplanation</a> <a href="#">IndicatorValue</a> <a href="#">IndicatorComputationDescription</a> |

element **KIIDType/RiskAndReturnProfile/SyntheticRiskIndicator/RiskIndicatorLegend**

|            |   |
|------------|---|
| diagram    |   |
| properties | isRef 0<br>content complex  |
| children   | <a href="#">UpperLeft</a> <a href="#">UpperRight</a> <a href="#">LowerLeft</a> <a href="#">LowerRight</a> |

element **KIIDType/RiskAndReturnProfile/SyntheticRiskIndicator/RiskIndicatorLegend/UpperLeft**

|            |                               |
|------------|-------------------------------|
| diagram    |                               |
| type       | <b>xs:string</b>              |
| properties | isRef 0<br>content simple     |
| annotation | documentation<br>'Lower risk' |

element **KIIDType/RiskAndReturnProfile/SyntheticRiskIndicator/RiskIndicatorLegend/UpperRight**

|            |   |
|------------|---|
| diagram    |  |
| type       | <b>xs:string</b>  |
| properties | isRef 0<br>content simple   |
| annotation | documentation<br>'Higher risk'  |

element **KIIDType/RiskAndReturnProfile/SyntheticRiskIndicator/RiskIndicatorLegend/LowerLeft**

|            |   |
|------------|---|
| diagram    |  |
| type       | <b>xs:string</b>  |
| properties | isRef 0<br>content simple   |
| annotation | documentation<br>'Typically lower rewards'  |

element **KIIDType/RiskAndReturnProfile/SyntheticRiskIndicator/RiskIndicatorLegend/LowerRight**

|            |   |
|------------|---|
| diagram    |  |
| type       | <b>xs:string</b>  |
| properties | isRef 0<br>content simple   |
| annotation | documentation<br>'Typically higher rewards'   |

element **KIIDType/RiskAndReturnProfile/SyntheticRiskIndicator/SyntheticRiskIndicatorExplanation**

|            |   |
|------------|---|
| diagram    | <p>The diagram shows a box for <b>SyntheticRiskIndicatorExplanation</b> with the text "8-4a to 8-4d" below it. A line connects this box to a vertical list of elements:</p> <ul style="list-style-type: none"> <li><b>RiskCommentsHeading</b>: "Risk indicator comments:"</li> <li><b>Explanation4a</b>: "8-4a Historical data is no indication of future risk profile"</li> <li><b>Explanation4b</b>: "8-4b Indicator value liable to change over time"</li> <li><b>Explanation4c</b>: "8-4c Lowest indicator value doesn't mean risk-free"</li> <li><b>Explanation4d</b>: "8-4d Explanation of why the fund is in its risk category"</li> <li><b>Explanation4e</b>: "Details of capital guarantee or protection" (shown in a dashed box)</li> </ul> |
| properties | isRef 0<br>content complex  |
| children   | <a href="#">RiskCommentsHeading</a> <a href="#">Explanation4a</a> <a href="#">Explanation4b</a> <a href="#">Explanation4c</a> <a href="#">Explanation4d</a> <a href="#">Explanation4e</a>   |
| annotation | documentation<br>8-4a to 8-4d   |

element **KIIDType/RiskAndReturnProfile/SyntheticRiskIndicator/SyntheticRiskIndicatorExplanation/RiskCommentsHeading**

|            |  |
|------------|--|
| diagram    | <p>The diagram shows a box for <b>RiskCommentsHeading</b> with the text "'Risk indicator comments:'" below it.</p> |
| type       | <b>xs:string</b>   |
| properties | isRef 0<br>content simple  |
| annotation | documentation<br>'Risk indicator comments:'  |

element **KIIDType/RiskAndReturnProfile/SyntheticRiskIndicator/SyntheticRiskIndicatorExplanation/Explanation4a**

|         |  |
|---------|--|
| diagram | <p>The diagram shows a box for <b>Explanation4a</b> with the text "8-4a Historical data is no indication of future risk profile" below it.</p> |
|---------|--|

|            |   |
|------------|---|
| type       | <b>xs:string</b>  |
| properties | isRef 0<br>content simple   |
| annotation | documentation<br>8-4a Historical data is no indication of future risk profile |

element

**KIIDType/RiskAndReturnProfile/SyntheticRiskIndicator/SyntheticRiskIndicatorExplanation/Explanation 4b**

|            |   |
|------------|---|
| diagram    |  |
| type       | <b>xs:string</b>  |
| properties | isRef 0<br>content simple   |
| annotation | documentation<br>8-4b Indicator value liable to change over time                  |

element

**KIIDType/RiskAndReturnProfile/SyntheticRiskIndicator/SyntheticRiskIndicatorExplanation/Explanation 4c**

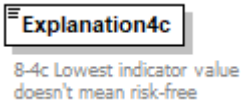
|            |  |
|------------|--|
| diagram    |  |
| type       | <b>xs:string</b>   |
| properties | isRef 0<br>content simple  |
| annotation | documentation<br>8-4c Lowest indicator value doesn't mean risk-free                |

element

**KIIDType/RiskAndReturnProfile/SyntheticRiskIndicator/SyntheticRiskIndicatorExplanation/Explanation 4d**

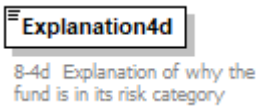
|            |   |
|------------|---|
| diagram    |  |
| type       | <b>xs:string</b>  |
| properties | isRef 0<br>content simple   |
| annotation | documentation<br>8-4d Explanation of why the fund is in its risk category           |

element

**KIIDType/RiskAndReturnProfile/SyntheticRiskIndicator/SyntheticRiskIndicatorExplanation/Explanation  
4e**

|            |   |
|------------|---|
| diagram    |  |
| type       | <b>xs:string</b>  |
| properties | isRef 0<br>minOcc 0<br>maxOcc 1<br>content simple                                 |
| annotation | documentation<br>Details of capital guarantee or protection                       |

element **KIIDType/RiskAndReturnProfile/SyntheticRiskIndicator/IndicatorValue**

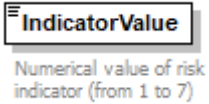
|            |   |
|------------|---|
| diagram    |  |
| type       | restriction of <b>xs:int</b>  |
| properties | isRef 0<br>content simple   |
| facets     | Kind Value annotation<br>minInclusive 1<br>maxInclusive 7                         |
| annotation | documentation<br>Numerical value of risk indicator (from 1 to 7)                  |

element **KIIDType/RiskAndReturnProfile/SyntheticRiskIndicator/IndicatorComputationDescription**

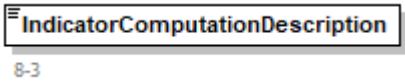
|            |   |
|------------|---|
| diagram    |  |
| type       | <b>xs:string</b>  |
| properties | isRef 0<br>content simple   |
| annotation | documentation<br>8-3  |

element **KIIDType/RiskAndReturnProfile/RiskFactorsNotIncluded**

|            |  |
|------------|--|
| diagram    | <p><b>RiskFactorsNotIncluded</b><br/>8-1b and 8-5 Risk factors not included in the synthetic risk indicator (credit, liquidity,counterparty, operational, derivative risks,...).</p> <ul style="list-style-type: none"> <li><b>Heading</b>: 'Other information about this fund's risks:'</li> <li><b>CreditRisk</b>: 8-5a Credit risk for debt securities</li> <li><b>LiquidityRisk</b>: 8-5b Liquidity risk description</li> <li><b>CounterpartyRisk</b>: 8-5c Counterparty risk description</li> <li><b>OperationalRisks</b>: 8-5d</li> <li><b>DerivativesRisk</b>: 8-5e Derivatives risk description</li> </ul> |
| properties | <p>isRef 0<br/>minOcc 0<br/>maxOcc 1<br/>content complex</p>   |
| children   | <p><a href="#">Heading</a> <a href="#">CreditRisk</a> <a href="#">LiquidityRisk</a> <a href="#">CounterpartyRisk</a> <a href="#">OperationalRisks</a> <a href="#">DerivativesRisk</a></p>  |
| annotation | <p>documentation<br/>8-1b and 8-5 Risk factors not included in the synthetic risk indicator (credit, liquidity,counterparty, operational, derivative risks,...).</p>   |

element **KIIDType/RiskAndReturnProfile/RiskFactorsNotIncluded/Heading**

|            |  |
|------------|--|
| diagram    | <p><b>Heading</b><br/>'Other information about this fund's risks:'</p> |
| type       | <p><b>xs:string</b></p>  |
| properties | <p>isRef 0<br/>minOcc 0<br/>maxOcc 1<br/>content simple</p>            |
| annotation | <p>documentation<br/>'Other information about this fund's risks:'</p>  |

element **KIIDType/RiskAndReturnProfile/RiskFactorsNotIncluded/CreditRisk**

|         |   |
|---------|---|
| diagram | <p><b>CreditRisk</b><br/>8-5a Credit risk for debt securities</p> |
| type    | <p><b>xs:string</b></p>   |



|            |   |
|------------|---|
| properties | isRef 0<br>minOcc 0<br>maxOcc 1<br>content simple     |
| annotation | documentation<br>8-5a Credit risk for debt securities |

element **KIIDType/RiskAndReturnProfile/RiskFactorsNotIncluded/LiquidityRisk**

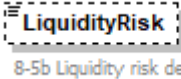
|            |  |
|------------|--|
| diagram    | <br>8-5b Liquidity risk description |
| type       | <b>xs:string</b>   |
| properties | isRef 0<br>minOcc 0<br>maxOcc 1<br>content simple  |
| annotation | documentation<br>8-5b Liquidity risk description   |

element **KIIDType/RiskAndReturnProfile/RiskFactorsNotIncluded/CounterpartyRisk**

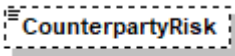
|            |   |
|------------|---|
| diagram    | <br>8-5c Counterparty risk description |
| type       | <b>xs:string</b>  |
| properties | isRef 0<br>minOcc 0<br>maxOcc 1<br>content simple   |
| annotation | documentation<br>8-5c Counterparty risk description   |

element **KIIDType/RiskAndReturnProfile/RiskFactorsNotIncluded/OperationalRisks**

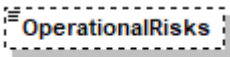
|            |   |
|------------|---|
| diagram    | <br>8-5d |
| type       | <b>xs:string</b>  |
| properties | isRef 0<br>minOcc 0<br>maxOcc 1<br>content simple   |
| annotation | documentation<br>8-5d   |

element **KIIDType/RiskAndReturnProfile/RiskFactorsNotIncluded/DerivativesRisk**

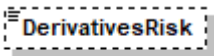
|         |  |
|---------|--|
| diagram | <br>8-5e Derivatives risk description |
| type    | <b>xs:string</b>   |

|            |  |
|------------|--|
| properties | isRef 0<br>minOcc 0<br>maxOcc 1<br>content simple  |
| annotation | documentation<br>8-5e Derivatives risk description |

element **KIIDType/Charges**

diagram

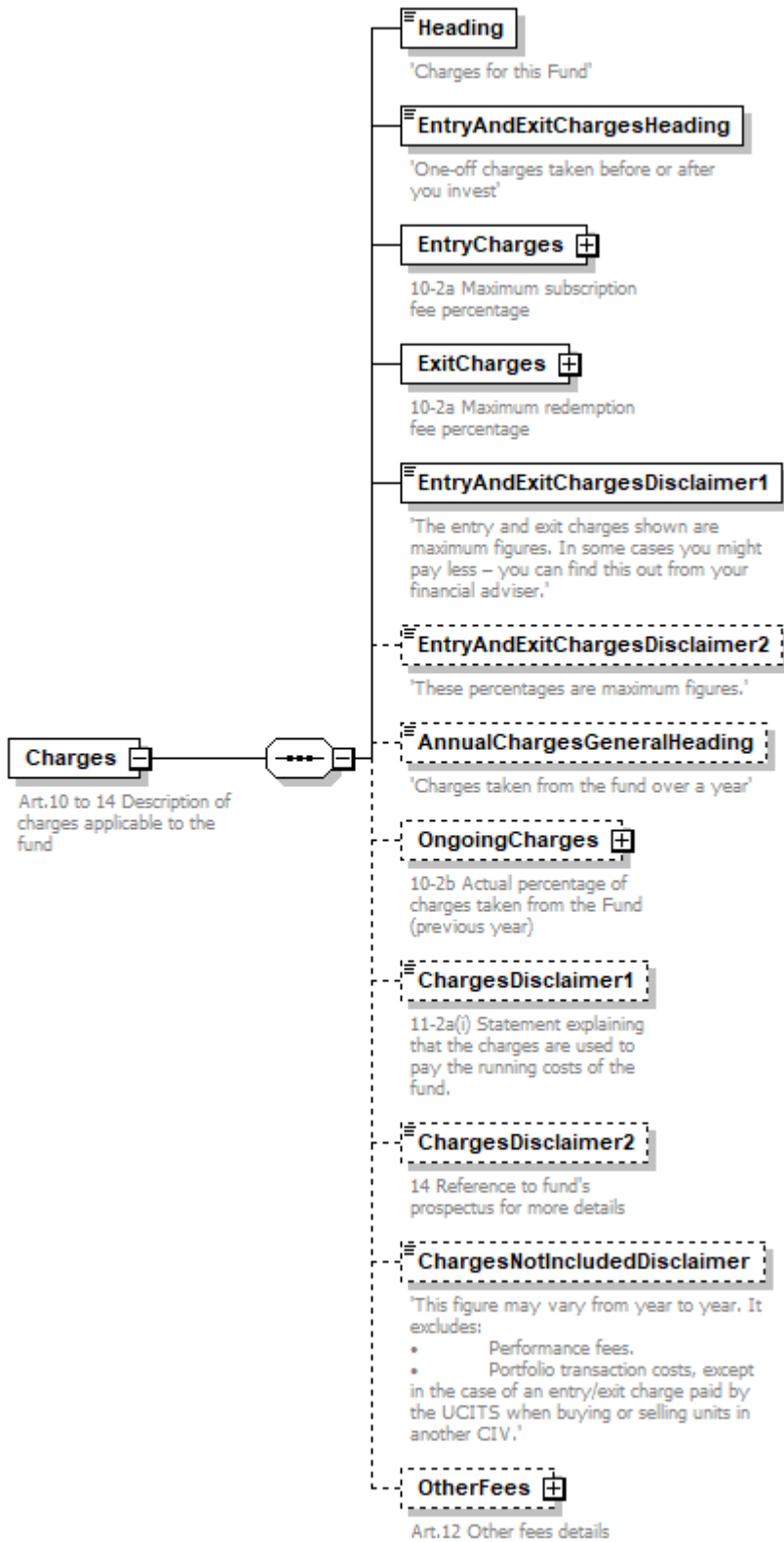

properties

isRef 0  
content complex

|            |   |
|------------|---|
| children   | <a href="#">Heading</a> <a href="#">EntryAndExitChargesHeading</a> <a href="#">EntryCharges</a> <a href="#">ExitCharges</a> <a href="#">EntryAndExitChargesDisclaimer1</a> <a href="#">EntryAndExitChargesDisclaimer2</a> <a href="#">AnnualChargesGeneralHeading</a> <a href="#">OngoingCharges</a> <a href="#">ChargesDisclaimer1</a> <a href="#">ChargesDisclaimer2</a> <a href="#">ChargesNotIncludedDisclaimer</a> <a href="#">OtherFees</a> |
| annotation | documentation<br>Art.10 to 14 Description of charges applicable to the fund   |

element **KIIDType/Charges/Heading**

|            |   |
|------------|---|
| diagram    |  |
| type       | <b>xs:string</b>  |
| properties | isRef 0<br>content simple   |
| annotation | documentation<br>'Charges for this Fund'  |

element **KIIDType/Charges/EntryAndExitChargesHeading**

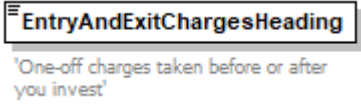
|            |   |
|------------|---|
| diagram    |  |
| type       | <b>xs:string</b>  |
| properties | isRef 0<br>content simple   |
| annotation | documentation<br>'One-off charges taken before or after you invest'               |

element **KIIDType/Charges/EntryCharges**

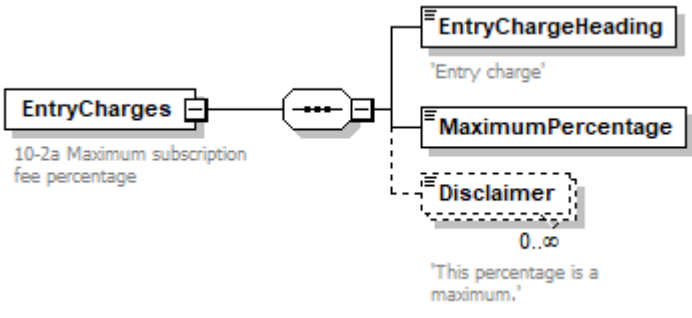
|            |   |
|------------|---|
| diagram    |              |
| properties | isRef 0<br>content complex  |
| children   | <a href="#">EntryChargeHeading</a> <a href="#">MaximumPercentage</a> <a href="#">Disclaimer</a> |
| annotation | documentation<br>10-2a Maximum subscription fee percentage                                      |

element **KIIDType/Charges/EntryCharges/EntryChargeHeading**

|         |   |
|---------|---|
| diagram |  |
|---------|---|

|            |                                 |
|------------|---------------------------------|
| type       | <b>xs:string</b>                |
| properties | isRef 0<br>content simple       |
| annotation | documentation<br>'Entry charge' |

element **KIIDType/Charges/EntryCharges/MaximumPercentage**

|            |                           |
|------------|---------------------------|
| diagram    |                           |
| type       | <b>xs:decimal</b>         |
| properties | isRef 0<br>content simple |

element **KIIDType/Charges/EntryCharges/Disclaimer**

|            |   |
|------------|---|
| diagram    |   |
| type       | <b>xs:string</b>  |
| properties | isRef 0<br>minOcc 0<br>maxOcc unbounded<br>content simple |
| annotation | documentation<br>'This percentage is a maximum.'          |

element **KIIDType/Charges/ExitCharges**

|            |  |
|------------|--|
| diagram    |  |
| properties | isRef 0<br>content complex   |
| children   | <a href="#">ExitChargeHeading</a> <a href="#">MaximumPercentage</a> <a href="#">Disclaimer</a> |
| annotation | documentation<br>10-2a Maximum redemption fee percentage                                       |

element **KIIDType/Charges/ExitCharges/ExitChargeHeading**

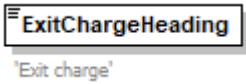
|            |   |
|------------|---|
| diagram    |  |
| type       | <b>xs:string</b>  |
| properties | isRef 0<br>content simple   |
| annotation | documentation<br>'Exit charge'  |

element **KIIDType/Charges/ExitCharges/MaximumPercentage**

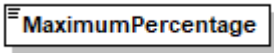
|            |   |
|------------|---|
| diagram    |  |
| type       | <b>xs:decimal</b>   |
| properties | isRef 0<br>content simple   |

element **KIIDType/Charges/ExitCharges/Disclaimer**

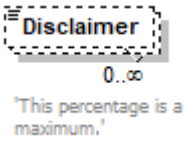
|            |  |
|------------|--|
| diagram    |  |
| type       | <b>xs:string</b>   |
| properties | isRef 0<br>minOcc 0<br>maxOcc unbounded<br>content simple                          |
| annotation | documentation<br>'This percentage is a maximum.'                                   |

element **KIIDType/Charges/EntryAndExitChargesDisclaimer1**

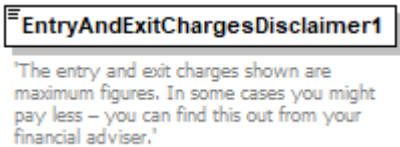
|            |  |
|------------|--|
| diagram    |   |
| type       | <b>xs:string</b>   |
| properties | isRef 0<br>content simple  |
| annotation | documentation<br>'The entry and exit charges shown are maximum figures. In some cases you might pay less – you can find this out from your financial adviser.' |

element **KIIDType/Charges/EntryAndExitChargesDisclaimer2**

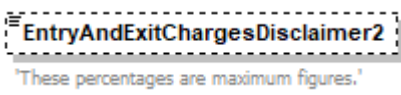
|            |   |
|------------|---|
| diagram    |  <p><b>EntryAndExitChargesDisclaimer2</b><br/>'These percentages are maximum figures.'</p> |
| type       | <b>xs:string</b>  |
| properties | isRef 0<br>minOcc 0<br>maxOcc 1<br>content simple   |
| annotation | documentation<br>'These percentages are maximum figures.'   |

element **KIIDType/Charges/AnnualChargesGeneralHeading**

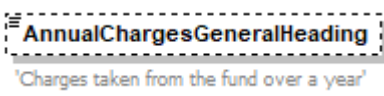
|            |   |
|------------|---|
| diagram    |  <p><b>AnnualChargesGeneralHeading</b><br/>'Charges taken from the fund over a year'</p> |
| type       | <b>xs:string</b>  |
| properties | isRef 0<br>minOcc 0<br>maxOcc 1<br>content simple   |
| annotation | documentation<br>'Charges taken from the fund over a year'  |

element **KIIDType/Charges/OngoingCharges**

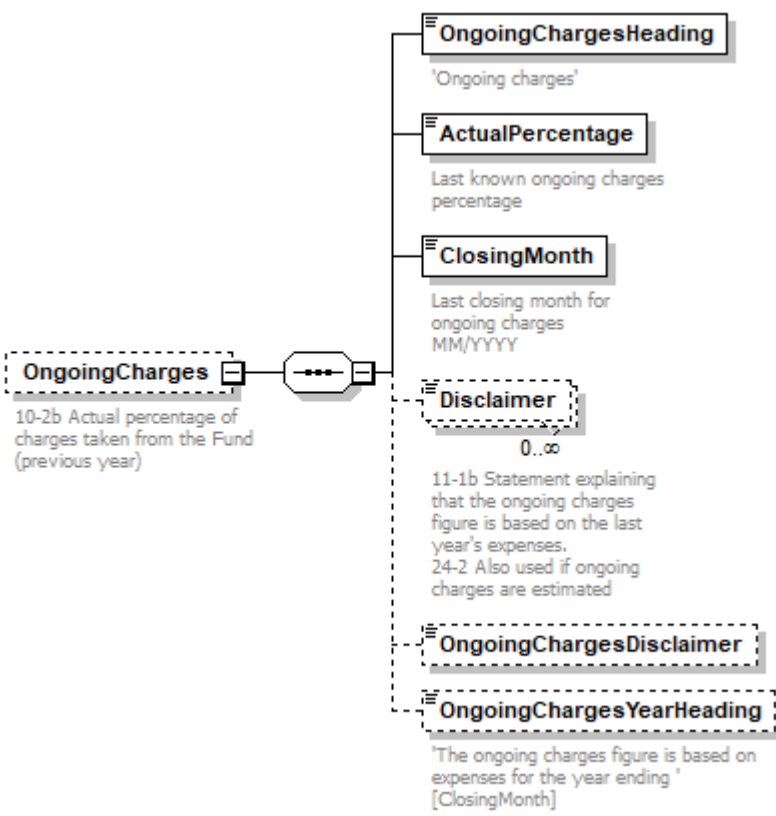
|         |  |
|---------|--|
| diagram |  <p><b>OngoingCharges</b><br/>10-2b Actual percentage of charges taken from the Fund (previous year)</p> <ul style="list-style-type: none"> <li><b>OngoingChargesHeading</b><br/>'Ongoing charges'</li> <li><b>ActualPercentage</b><br/>Last known ongoing charges percentage</li> <li><b>ClosingMonth</b><br/>Last closing month for ongoing charges MM/YYYY</li> <li><b>Disclaimer</b><br/>0..∞<br/>11-1b Statement explaining that the ongoing charges figure is based on the last year's expenses.<br/>24-2 Also used if ongoing charges are estimated</li> <li><b>OngoingChargesDisclaimer</b></li> <li><b>OngoingChargesYearHeading</b><br/>'The ongoing charges figure is based on expenses for the year ending '<br/>[ClosingMonth]</li> </ul> |
|---------|--|

|            |  |
|------------|--|
| properties | isRef 0<br>minOcc 0<br>maxOcc 1<br>content complex   |
| children   | <a href="#">OngoingChargesHeading</a> <a href="#">ActualPercentage</a> <a href="#">ClosingMonth</a> <a href="#">Disclaimer</a> <a href="#">OngoingChargesDisclaimer</a><br><a href="#">OngoingChargesYearHeading</a> |
| annotation | documentation<br>10-2b Actual percentage of charges taken from the Fund (previous year)  |

element **KIIDType/Charges/OngoingCharges/OngoingChargesHeading**

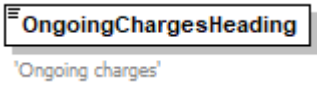
|            |   |
|------------|---|
| diagram    |  |
| type       | <b>xs:string</b>  |
| properties | isRef 0<br>content simple   |
| annotation | documentation<br>'Ongoing charges'  |

element **KIIDType/Charges/OngoingCharges/ActualPercentage**

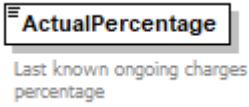
|            |  |
|------------|--|
| diagram    |  |
| type       | <b>xs:decimal</b>  |
| properties | isRef 0<br>content simple  |
| annotation | documentation<br>Last known ongoing charges percentage                             |

element **KIIDType/Charges/OngoingCharges/ClosingMonth**

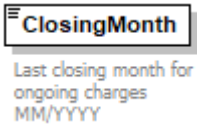
|            |   |
|------------|---|
| diagram    |  |
| type       | restriction of <b>xs:string</b>   |
| properties | isRef 0<br>content simple   |
| annotation | documentation<br>Last closing month for ongoing charges<br>MM/YYYY                  |

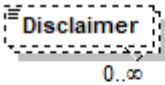

element **KIIDType/Charges/OngoingCharges/Disclaimer**

|            |   |
|------------|---|
| diagram    |  <p>0..∞</p> <p>11-1b Statement explaining that the ongoing charges figure is based on the last year's expenses.<br/>24-2 Also used if ongoing charges are estimated</p> |
| type       | <b>xs:string</b>  |
| properties | <p>isRef 0</p> <p>minOcc 0</p> <p>maxOcc unbounded</p> <p>content simple</p>  |
| annotation | <p>documentation</p> <p>11-1b Statement explaining that the ongoing charges figure is based on the last year's expenses.<br/>24-2 Also used if ongoing charges are estimated</p>  |

element **KIIDType/Charges/OngoingCharges/OngoingChargesDisclaimer**

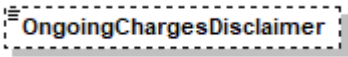
|            |   |
|------------|---|
| diagram    |  |
| type       | <b>xs:string</b>  |
| properties | <p>isRef 0</p> <p>minOcc 0</p> <p>maxOcc 1</p> <p>content simple</p>              |

element **KIIDType/Charges/OngoingCharges/OngoingChargesYearHeading**

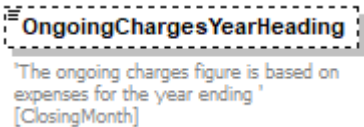
|            |   |
|------------|---|
| diagram    |  <p>'The ongoing charges figure is based on expenses for the year ending ' [ClosingMonth]'</p> |
| type       | <b>xs:string</b>  |
| properties | <p>isRef 0</p> <p>minOcc 0</p> <p>maxOcc 1</p> <p>content simple</p>  |
| annotation | <p>documentation</p> <p>'The ongoing charges figure is based on expenses for the year ending ' [ClosingMonth]</p>   |

element **KIIDType/Charges/ChargesDisclaimer1**

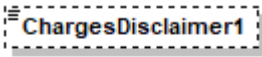
|            |  |
|------------|--|
| diagram    |  <p>11-2a(i) Statement explaining that the charges are used to pay the running costs of the fund.</p> |
| type       | <b>xs:string</b>   |
| properties | <p>isRef 0</p> <p>minOcc 0</p>   |

|            |  |
|------------|--|
|            | maxOcc 1<br>content simple   |
| annotation | documentation<br>11-2a(i) Statement explaining that the charges are used to pay the running costs of the fund. |

element **KIIDType/Charges/ChargesDisclaimer2**

|            |   |
|------------|---|
| diagram    |   |
| type       | <b>xs:string</b>  |
| properties | isRef 0<br>minOcc 0<br>maxOcc 1<br>content simple                   |
| annotation | documentation<br>14 Reference to fund's prospectus for more details |

element **KIIDType/Charges/ChargesNotIncludedDisclaimer**

|            |  |
|------------|--|
| diagram    |  |
| type       | <b>xs:string</b>   |
| properties | isRef 0<br>minOcc 0<br>maxOcc 1<br>content simple  |
| annotation | documentation<br>'This figure may vary from year to year. It excludes:<br><ul style="list-style-type: none"> <li>• Performance fees.</li> <li>• Portfolio transaction costs, except in the case of an entry/exit charge paid by the UCITS when buying or selling units in another CIV.'</li> </ul> |

element **KIIDType/Charges/OtherFees**

|            |   |
|------------|---|
| diagram    |   |
| properties | isRef 0<br>minOcc 0<br>maxOcc 1<br>content complex        |
| children   | <a href="#">OtherFeesHeading</a> <a href="#">OtherFee</a> |

|            |  |
|------------|--|
| annotation | documentation<br>Art.12 Other fees details |
|------------|--|

element **KIIDType/Charges/OtherFees/OtherFeesHeading**

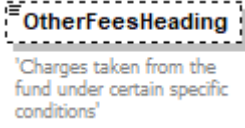
|            |   |
|------------|---|
| diagram    |  |
| type       | <b>xs:string</b>  |
| properties | isRef 0<br>minOcc 0<br>maxOcc 1<br>content simple                                 |
| annotation | documentation<br>'Charges taken from the fund under certain specific conditions'  |

element **KIIDType/Charges/OtherFees/OtherFee**

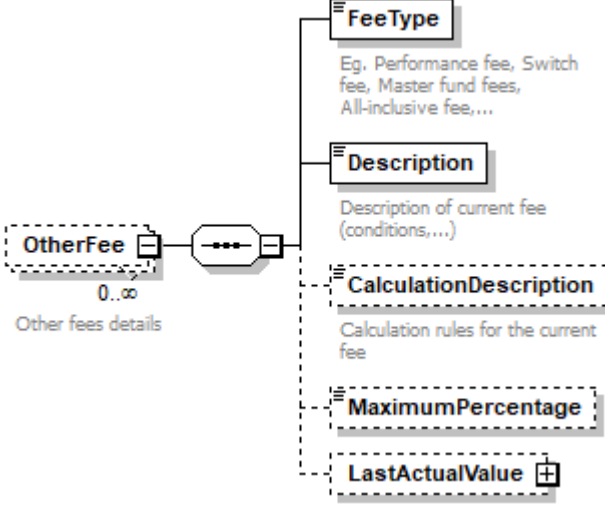
|            |  |
|------------|--|
| diagram    |    |
| properties | isRef 0<br>minOcc 0<br>maxOcc unbounded<br>content complex   |
| children   | <a href="#">FeeType</a> <a href="#">Description</a> <a href="#">CalculationDescription</a> <a href="#">MaximumPercentage</a> <a href="#">LastActualValue</a> |
| annotation | documentation<br>Other fees details  |

element **KIIDType/Charges/OtherFees/OtherFee/FeeType**

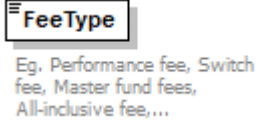
|            |   |
|------------|---|
| diagram    |  |
| type       | <b>xs:string</b>  |
| properties | isRef 0<br>content simple   |

|            |   |
|------------|---|
| annotation | documentation<br>Eg. Performance fee, Switch fee, Master fund fees, All-inclusive fee,... |
|------------|---|

element **KIIDType/Charges/OtherFees/OtherFee/Description**

|            |  |
|------------|--|
| diagram    |  |
| type       | <b>xs:string</b>   |
| properties | isRef 0<br>content simple                                    |
| annotation | documentation<br>Description of current fee (conditions,...) |

element **KIIDType/Charges/OtherFees/OtherFee/CalculationDescription**

|            |  |
|------------|--|
| diagram    |  |
| type       | <b>xs:string</b>                                       |
| properties | isRef 0<br>minOcc 0<br>maxOcc 1<br>content simple      |
| annotation | documentation<br>Calculation rules for the current fee |

element **KIIDType/Charges/OtherFees/OtherFee/MaximumPercentage**

|            |   |
|------------|---|
| diagram    |   |
| type       | <b>xs:decimal</b>                                 |
| properties | isRef 0<br>minOcc 0<br>maxOcc 1<br>content simple |

element **KIIDType/Charges/OtherFees/OtherFee/LastActualValue**

|            |   |
|------------|---|
| diagram    |   |
| properties | isRef 0<br>minOcc 0<br>maxOcc 1<br>content complex      |
| children   | <a href="#">Percentage</a> <a href="#">ClosingMonth</a> |

element **KIIDType/Charges/OtherFees/OtherFee/LastActualValue/Percentage**

|            |                           |
|------------|---------------------------|
| diagram    |                           |
| type       | <b>xs:decimal</b>         |
| properties | isRef 0<br>content simple |

element **KIIDType/Charges/OtherFees/OtherFee/LastActualValue/ClosingMonth**

|            |   |
|------------|---|
| diagram    | <br>Last closing month for current fee MM/YYYY              |
| type       | restriction of <b>xs:string</b>                             |
| properties | isRef 0<br>content simple                                   |
| annotation | documentation<br>Last closing month for current fee MM/YYYY |

element **KIIDType/PastPerformances**

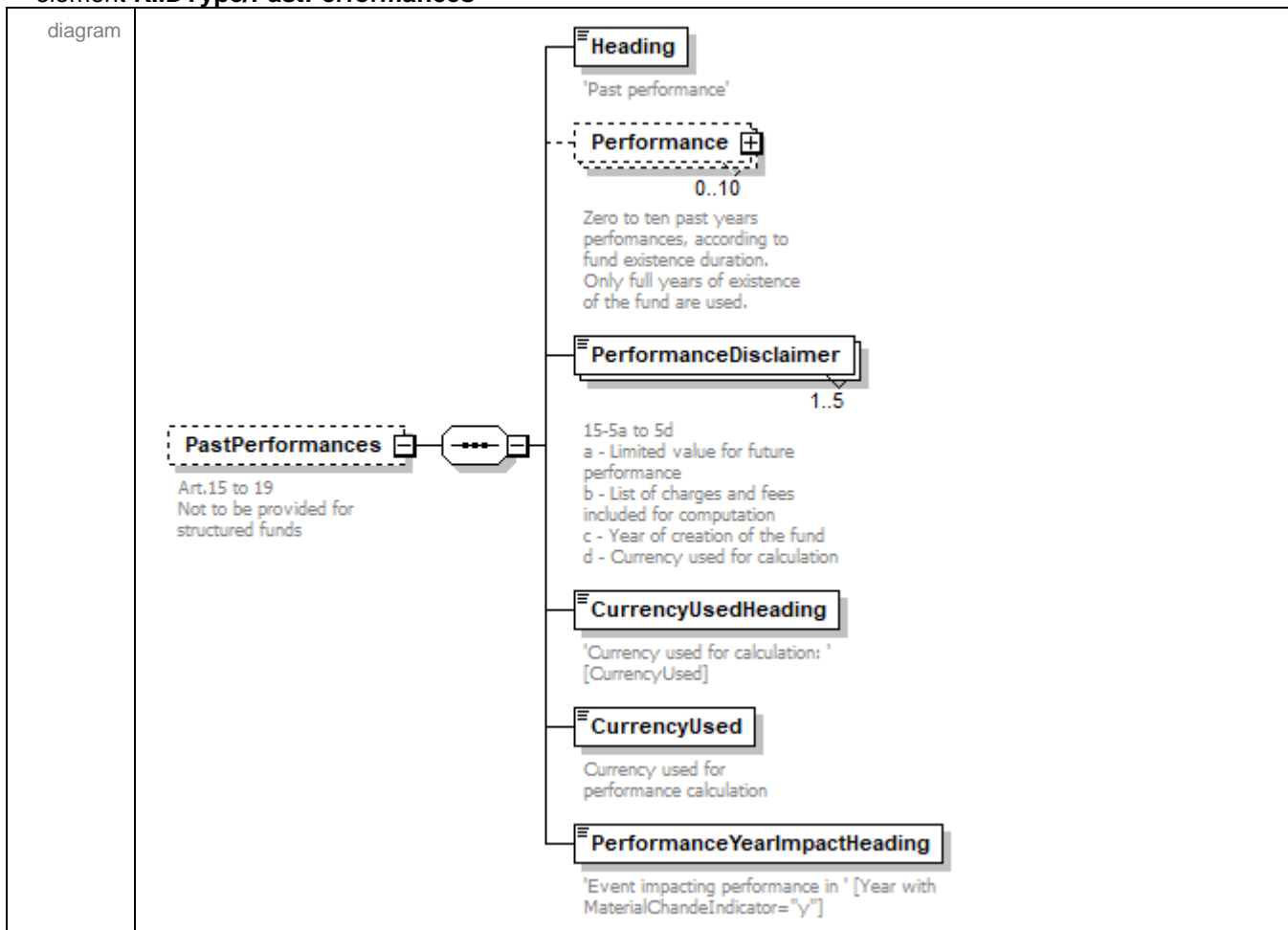

|            |   |
|------------|---|
| properties | isRef 0<br>minOcc 0<br>maxOcc 1<br>content complex  |
| children   | <a href="#">Heading</a> <a href="#">PerformanceDisclaimer</a> <a href="#">CurrencyUsedHeading</a> <a href="#">CurrencyUsed</a> <a href="#">PerformanceYearImpactHeading</a> |
| annotation | documentation<br>Art.15 to 19<br>Not to be provided for structured funds  |

element **KIIDType/PastPerformances/Heading**

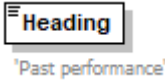
|            |   |
|------------|---|
| diagram    |  |
| type       | xs:string   |
| properties | isRef 0<br>content simple   |
| annotation | documentation<br>'Past performance'   |

element **KIIDType/PastPerformances/Performance**

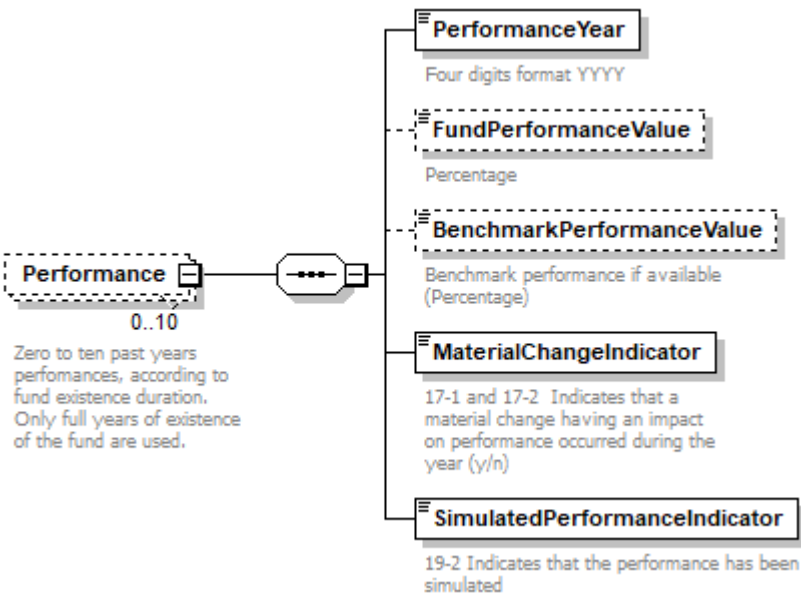
|            |  |
|------------|--|
| diagram    |   |
| properties | isRef 0<br>minOcc 0<br>maxOcc 10<br>content complex  |
| children   | <a href="#">PerformanceYear</a> <a href="#">FundPerformanceValue</a> <a href="#">BenchmarkPerformanceValue</a> <a href="#">MaterialChangeIndicator</a> <a href="#">SimulatedPerformanceIndicator</a> |
| annotation | documentation<br>Zero to ten past years performances, according to fund existence duration.<br>Only full years of existence of the fund are used.  |

element **KIIDType/PastPerformances/Performance/PerformanceYear**

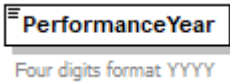
|            |   |
|------------|---|
| diagram    |  |
| type       | <b>xs:integer</b>   |
| properties | isRef 0<br>content simple   |
| annotation | documentation<br>Four digits format YYYY  |

element **KIIDType/PastPerformances/Performance/FundPerformanceValue**

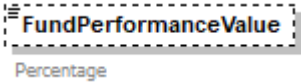
|            |   |
|------------|---|
| diagram    |  |
| type       | <b>xs:decimal</b>   |
| properties | isRef 0<br>minOcc 0<br>maxOcc 1<br>content simple                                 |
| annotation | documentation<br>Percentage   |

element **KIIDType/PastPerformances/Performance/BenchmarkPerformanceValue**

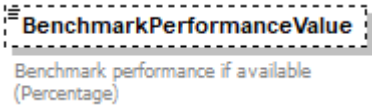
|            |   |
|------------|---|
| diagram    |  |
| type       | <b>xs:decimal</b>   |
| properties | isRef 0<br>minOcc 0<br>maxOcc 1<br>content simple                                   |
| annotation | documentation<br>Benchmark performance if available (Percentage)                    |

element **KIIDType/PastPerformances/Performance/MaterialChangeIndicator**

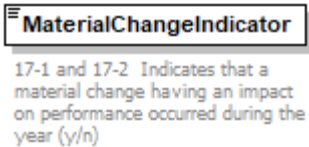
|            |  |
|------------|--|
| diagram    |   |
| type       | <b>xs:boolean</b>  |
| properties | isRef 0<br>content simple  |
| annotation | documentation<br>17-1 and 17-2 Indicates that a material change having an impact on performance occurred during the year (y/n) |

element **KIIDType/PastPerformances/Performance/SimulatedPerformanceIndicator**

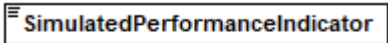
|            |   |
|------------|---|
| diagram    |  <p>19-2 Indicates that the performance has been simulated</p> |
| type       | <b>xs:boolean</b>   |
| properties | isRef 0<br>content simple   |
| annotation | documentation<br>19-2 Indicates that the performance has been simulated   |

element **KIIDType/PastPerformances/PerformanceDisclaimer**

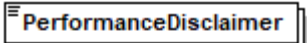
|            |  |
|------------|--|
| diagram    |  <p>15-5a to 5d<br/>a - Limited value for future performance<br/>b - List of charges and fees included for computation<br/>c - Year of creation of the fund<br/>d - Currency used for calculation</p> <p>1..5</p> |
| type       | <b>xs:string</b>   |
| properties | isRef 0<br>minOcc 1<br>maxOcc 5<br>content simple  |
| annotation | documentation<br>15-5a to 5d<br>a - Limited value for future performance<br>b - List of charges and fees included for computation<br>c - Year of creation of the fund<br>d - Currency used for calculation   |

element **KIIDType/PastPerformances/CurrencyUsedHeading**

|            |   |
|------------|---|
| diagram    |  <p>'Currency used for calculation: '<br/>[CurrencyUsed]</p> |
| type       | <b>xs:string</b>  |
| properties | isRef 0<br>content simple   |
| annotation | documentation<br>'Currency used for calculation: ' [CurrencyUsed]   |

element **KIIDType/PastPerformances/CurrencyUsed**

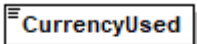
|         |  |
|---------|--|
| diagram |  <p>Currency used for performance calculation</p> |
| type    | <a href="#">ISOCurrencyCodeType</a>  |



|            |   |
|------------|---|
| properties | isRef 0<br>content simple   |
| facets     | Kind Value annotation<br>minLength 3<br>maxLength 3<br>pattern [A-Z]{3} |
| annotation | documentation<br>Currency used for performance calculation              |

element **KIIDType/PastPerformances/PerformanceYearImpactHeading**

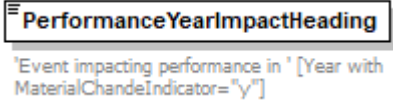
|            |  |
|------------|--|
| diagram    |           |
| type       | <b>xs:string</b>   |
| properties | isRef 0<br>content simple  |
| annotation | documentation<br>'Event impacting performance in ' [Year with MaterialChandeIndicator="y"] |

element **KIIDType/PracticalInformation**

|                   |   |
|-------------------|---|
| <p>diagram</p>    | <p><b>PracticalInformation</b><br/>Art.20 and 21</p> <ul style="list-style-type: none"> <li><b>Heading</b><br/>'Practical information'</li> <li><b>DepositoryNameHeading</b><br/>'Depository: '</li> <li><b>DepositoryName</b><br/>20-1a</li> <li><b>FurtherInformation</b><br/>20-1b and 1c Where to find...</li> <li><b>TaxLegislationWarning</b><br/>20-1d Impact of country of residence on taxes</li> <li><b>AMCompanyLiabilityDisclaimer</b><br/>20-1e</li> <li><b>CompartmentSwitchInformation</b><br/>20-3 Statement on possibility of switch between compartments</li> <li><b>MainsShareClassInformation</b><br/>20-3 Name of the share class used for the current KIID</li> <li><b>OtherSourcesOfInformation</b><br/>0..∞<br/>21-1 Possible additional sources of information: prospectus, annual reports, website(s), etc.</li> <li><b>CompartmentFundWarning</b><br/>0..3<br/>25-2 Specific information for compartment funds<br/>2a KIID describes a compartment<br/>2b Information on segregation of assets and liabilities of each compartment<br/>2c Information on switch between compartments (how to...)</li> <li><b>MasterFundInformation</b><br/>34 Additional information if the fund is a feeder of a master fund</li> </ul> |
| <p>properties</p> | <p>isRef 0<br/>content complex</p>  |
| <p>children</p>   | <p><a href="#">Heading</a> <a href="#">DepositoryNameHeading</a> <a href="#">DepositoryName</a> <a href="#">FurtherInformation</a> <a href="#">TaxLegislationWarning</a> <a href="#">AMCompanyLiabilityDisclaimer</a> <a href="#">CompartmentSwitchInformation</a> <a href="#">MainsShareClassInformation</a> <a href="#">OtherSourcesOfInformation</a> <a href="#">CompartmentFundWarning</a> <a href="#">MasterFundInformation</a></p>  |
| <p>annotation</p> | <p>documentation<br/>Art.20 and 21</p>  |

element **KIIDType/PracticalInformation/Heading**

|            |  |
|------------|--|
| diagram    |  |
| type       | <b>xs:string</b>                         |
| properties | isRef 0<br>content simple                |
| annotation | documentation<br>'Practical information' |

element **KIIDType/PracticalInformation/DepositoryNameHeading**

|            |                                 |
|------------|---------------------------------|
| diagram    |                                 |
| type       | <b>xs:string</b>                |
| properties | isRef 0<br>content simple       |
| annotation | documentation<br>'Depository: ' |

element **KIIDType/PracticalInformation/DepositoryName**

|            |                           |
|------------|---------------------------|
| diagram    |                           |
| type       | <b>xs:string</b>          |
| properties | isRef 0<br>content simple |
| annotation | documentation<br>20-1a    |

element **KIIDType/PracticalInformation/FurtherInformation**

|            |  |
|------------|--|
| diagram    |  |
| properties | isRef 0<br>content complex   |
| children   | <a href="#">FurtherInformationDetails</a> <a href="#">AdditionalInformationLanguagesHeading</a> <a href="#">FurtherInformationLanguage</a> |

|            |  |
|------------|--|
| annotation | documentation<br>20-1b and 1c Where to find... |
|------------|--|

element **KIIDType/PracticalInformation/FurtherInformation/FurtherInformationDetails**

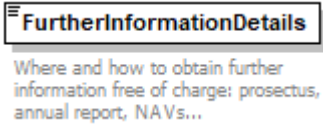
|            |   |
|------------|---|
| diagram    |  <p><b>FurtherInformationDetails</b><br/>Where and how to obtain further information free of charge: prosectus, annual report, NAVs...</p> |
| type       | <b>xs:string</b>  |
| properties | isRef 0<br>content simple   |
| annotation | documentation<br>Where and how to obtain further information free of charge: prosectus, annual report, NAVs...  |

element **KIIDType/PracticalInformation/FurtherInformation/AdditionalInformationLanguagesHeading**

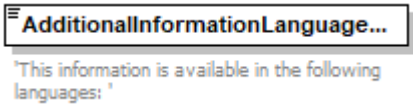
|            |   |
|------------|---|
| diagram    |  <p><b>AdditionalInformationLanguage...</b><br/>'This information is available in the following languages: '</p> |
| type       | <b>xs:string</b>  |
| properties | isRef 0<br>content simple   |
| annotation | documentation<br>'This information is available in the following languages: '   |

element **KIIDType/PracticalInformation/FurtherInformation/FurtherInformationLanguage**

|            |   |
|------------|---|
| diagram    |  <p><b>FurtherInformationLanguage</b><br/>1..∞<br/>List of languages available</p> |
| type       | <a href="#">ISOCountryCodeType</a>  |
| properties | isRef 0<br>minOcc 1<br>maxOcc unbounded<br>content simple   |
| facets     | Kind Value annotation<br>minLength 2<br>maxLength 2   |
| annotation | documentation<br>List of languages available  |

element **KIIDType/PracticalInformation/TaxLegislationWarning**

|         |   |
|---------|---|
| diagram |  <p><b>TaxLegislationWarning</b><br/>20-1d Impact of country of residence on taxes</p> |
| type    | <b>xs:string</b>  |

|            |  |
|------------|--|
| properties | isRef 0<br>content simple                                      |
| annotation | documentation<br>20-1d Impact of country of residence on taxes |

element **KIIDType/PracticalInformation/AMCompanyLiabilityDisclaimer**

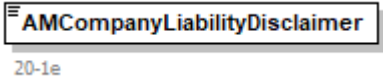
|            |  |
|------------|--|
| diagram    | <br>20-1e |
| type       | <b>xs:string</b>   |
| properties | isRef 0<br>content simple  |
| annotation | documentation<br>20-1e   |

element **KIIDType/PracticalInformation/CompartmentSwitchInformation**

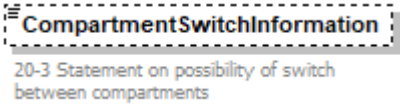
|            |   |
|------------|---|
| diagram    | <br>20-3 Statement on possibility of switch between compartments |
| type       | <b>xs:string</b>  |
| properties | isRef 0<br>minOcc 0<br>maxOcc 1<br>content simple   |
| annotation | documentation<br>20-3 Statement on possibility of switch between compartments   |

element **KIIDType/PracticalInformation/MainsShareClassInformation**

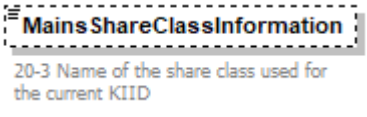
|            |   |
|------------|---|
| diagram    | <br>20-3 Name of the share class used for the current KIID |
| type       | <b>xs:string</b>  |
| properties | isRef 0<br>minOcc 0<br>maxOcc 1<br>content simple   |
| annotation | documentation<br>20-3 Name of the share class used for the current KIID   |

element **KIIDType/PracticalInformation/OtherSourcesOfInformation**

|         |  |
|---------|--|
| diagram | <br>0..∞<br>21-1 Possible additional sources of information: prospectus, annual reports, website(s), etc. |
| type    | <b>xs:string</b>   |

|            |  |
|------------|--|
| properties | isRef 0<br>minOcc 0<br>maxOcc unbounded<br>content simple  |
| annotation | documentation<br>21-1 Possible additional sources of information: prospectus, annual reports, website(s), etc. |

element **KIIDType/PracticalInformation/CompartmentFundWarning**

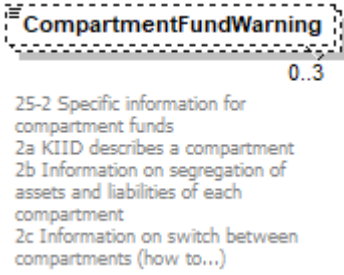
|            |  |
|------------|--|
| diagram    |  <p>25-2 Specific information for compartment funds<br/>2a KIID describes a compartment<br/>2b Information on segregation of assets and liabilities of each compartment<br/>2c Information on switch between compartments (how to...)</p> |
| type       | <b>xs:string</b>   |
| properties | isRef 0<br>minOcc 0<br>maxOcc 3<br>content simple  |
| annotation | documentation<br>25-2 Specific information for compartment funds<br>2a KIID describes a compartment<br>2b Information on segregation of assets and liabilities of each compartment<br>2c Information on switch between compartments (how to...)  |

element **KIIDType/PracticalInformation/MasterFundInformation**

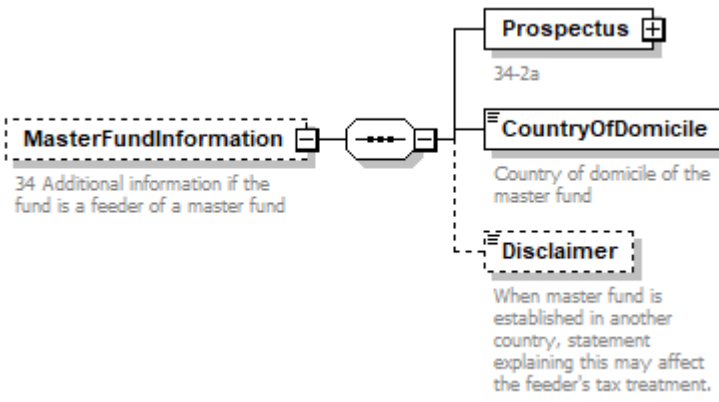
|            |   |
|------------|---|
| diagram    |  <p>34 Additional information if the fund is a feeder of a master fund</p> <p>Prospectus +<br/>34-2a</p> <p>CountryOfDomicile<br/>Country of domicile of the master fund</p> <p>Disclaimer<br/>When master fund is established in another country, statement explaining this may affect the feeder's tax treatment.</p> |
| properties | isRef 0<br>minOcc 0<br>maxOcc 1<br>content complex  |
| children   | <a href="#">Prospectus</a> <a href="#">CountryOfDomicile</a> <a href="#">Disclaimer</a>   |
| annotation | documentation<br>34 Additional information if the fund is a feeder of a master fund   |

element **KIIDType/PracticalInformation/MasterFundInformation/Prospectus**

|            |   |
|------------|---|
| diagram    | <p><b>Prospectus</b><br/>34-2a</p> <p><b>WhereToFind</b><br/>Statement explaining where to find information about the master fund (prospectus, KIID, annual reports, etc.)</p> <p><b>Language</b><br/>1..∞<br/>List of language(s) in which information is available</p> <p><b>Media</b><br/>Available media(s): paper, CD, Web, etc.</p> <p><b>Cost</b><br/>'Free delivery' or description of fees to be paid for medias</p> |
| properties | isRef 0<br>content complex  |
| children   | <a href="#">WhereToFind</a> <a href="#">Language</a> <a href="#">Media</a> <a href="#">Cost</a>   |
| annotation | documentation<br>34-2a  |

element **KIIDType/PracticalInformation/MasterFundInformation/Prospectus/WhereToFind**

|            |   |
|------------|---|
| diagram    | <p><b>WhereToFind</b><br/>Statement explaining where to find information about the master fund (prospectus, KIID, annual reports, etc.)</p> |
| type       | <b>xs:string</b>  |
| properties | isRef 0<br>content simple   |
| annotation | documentation<br>Statement explaining where to find information about the master fund (prospectus, KIID, annual reports, etc.)              |

element **KIIDType/PracticalInformation/MasterFundInformation/Prospectus/Language**

|            |   |
|------------|---|
| diagram    | <p><b>Language</b><br/>1..∞<br/>List of language(s) in which information is available</p> |
| type       | <a href="#">ISOCountryCodeType</a>  |
| properties | isRef 0<br>minOcc 1<br>maxOcc unbounded<br>content simple                                 |
| facets     | Kind Value annotation<br>minLength 2<br>maxLength 2                                       |

|            |  |
|------------|--|
| annotation | documentation<br>List of language(s) in which information is available |
|------------|--|

element **KIIDType/PracticalInformation/MasterFundInformation/Prospectus/Media**

|            |   |
|------------|---|
| diagram    |  <p>Available media(s): paper, CD, Web, etc.</p> |
| type       | <b>xs:string</b>  |
| properties | isRef 0<br>minOcc 0<br>maxOcc 1<br>content simple   |
| annotation | documentation<br>Available media(s): paper, CD, Web, etc.   |

element **KIIDType/PracticalInformation/MasterFundInformation/Prospectus/Cost**

|            |   |
|------------|---|
| diagram    |  <p>'Free delivery' or description of fees to be paid for medias</p> |
| type       | <b>xs:string</b>  |
| properties | isRef 0<br>content simple   |
| annotation | documentation<br>'Free delivery' or description of fees to be paid for medias   |

element **KIIDType/PracticalInformation/MasterFundInformation/CountryOfDomicile**

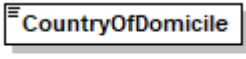
|            |   |
|------------|---|
| diagram    |  <p>Country of domicile of the master fund</p> |
| type       | <a href="#">ISOCountryCodeType</a>  |
| properties | isRef 0<br>content simple   |
| facets     | Kind Value annotation<br>minLength 2<br>maxLength 2   |
| annotation | documentation<br>Country of domicile of the master fund   |

element **KIIDType/PracticalInformation/MasterFundInformation/Disclaimer**

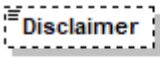
|         |   |
|---------|---|
| diagram |  <p>When master fund is established in another country, statement explaining this may affect the feeder's tax treatment.</p> |
|---------|---|



|            |   |
|------------|---|
| type       | <b>xs:string</b>  |
| properties | isRef 0<br>minOcc 0<br>maxOcc 1<br>content simple   |
| annotation | documentation<br>When master fund is established in another country, statement explaining this may affect the feeder's tax treatment. |

# complexType CEPT\_PriceType

diagram



|          |  |
|----------|--|
| children | <a href="#">SharePriceDate</a> <a href="#">SharePrice</a> <a href="#">SharePriceCurrency</a> <a href="#">Share price factor</a> <a href="#">DistributionValue</a> <a href="#">ShareSplitFactor</a> <a href="#">Old share class currency</a> <a href="#">Exchange rate for change in share class currency</a> <a href="#">Old Valuation</a> <a href="#">Frequency</a> |
| used by  | element <a href="#">PRIIPS ReportType/CEPT Prices/CEPT Price</a>   |

#### element CEPT\_PriceType/SharePriceDate

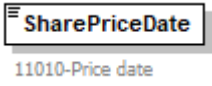
|            |   |
|------------|---|
| diagram    |  |
| type       | <b>xs:date</b>  |
| properties | isRef 0<br>content simple   |
| annotation | documentation<br>11010-Price date   |

#### element CEPT\_PriceType/SharePrice

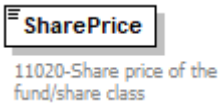
|            |   |
|------------|---|
| diagram    |  |
| type       | restriction of <b>xs:decimal</b>  |
| properties | isRef 0<br>content simple   |
| facets     | Kind Value annotation<br>minInclusive 0   |
| annotation | documentation<br>11020-Share price of the fund/share class                        |

#### element CEPT\_PriceType/SharePriceCurrency

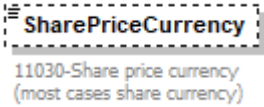
|            |   |
|------------|---|
| diagram    |  |
| type       | <a href="#">ISOCurrencyCodeType</a>   |
| properties | isRef 0<br>minOcc 0<br>maxOcc 1<br>content simple                                   |
| facets     | Kind Value annotation<br>minLength 3<br>maxLength 3<br>pattern [A-Z]{3}             |
| annotation | documentation<br>11030-Share price currency (most cases share currency)             |

element **CEPT\_PriceType/Share\_price\_factor**

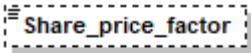
|            |   |
|------------|---|
| diagram    |  <p>11040-Factor as combination of distribution value and share split factor (if this field is provided then following fields are not required). Value which the price should be multiplied to to obtain the correct performance time series. This should reflect the multiplying factor and should be populated every day. In case of null value, '1' is taken as default. Should only be populated in case a share price factor is relevant.</p> |
| type       | <b>xs:decimal</b>   |
| properties | isRef 0<br>minOcc 0<br>maxOcc 1<br>content simple   |
| annotation | documentation<br>11040-Factor as combination of distribution value and share split factor (if this field is provided then following fields are not required). Value which the price should be multiplied to to obtain the correct performance time series. This should reflect the multiplying factor and should be populated every day. In case of null value, '1' is taken as default. Should only be populated in case a share price factor is relevant.   |

element **CEPT\_PriceType/DistributionValue**

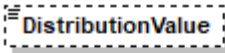
|            |   |
|------------|---|
| diagram    |  <p>11050-Distribution value in share price currency. Should be populated on day of distribution only and only in case a distribution has taken place.</p> |
| type       | <b>xs:decimal</b>   |
| properties | isRef 0<br>minOcc 0<br>maxOcc 1<br>content simple   |
| annotation | documentation<br>11050-Distribution value in share price currency. Should be populated on day of distribution only and only in case a distribution has taken place.   |

element **CEPT\_PriceType/ShareSplitFactor**

|         |  |
|---------|--|
| diagram |  <p>11060-Should only be populated in case of a share split - then respective factor should be populated. This should reflect the multiplying factor and should be populated every day. In case of null value, '1' is taken as default.</p> |
| type    | <b>xs:decimal</b>  |

|            |  |
|------------|--|
| properties | isRef 0<br>minOcc 0<br>maxOcc 1<br>content simple  |
| annotation | documentation<br>11060-Should only be populated in case of a share split - then respective factor should be populated. This should reflect the multiplying factor and should be populated every day. In case of null value, '1' is taken as default. |

element **CEPT\_PriceType/Old\_share\_class\_currency**

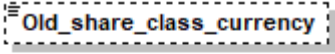
|            |   |
|------------|---|
| diagram    |  <p>11070-In the rare occasion of a share class currency change - this needs to be populated with the old share class currency. Should only be populated in case a share class currency change took place.</p> |
| type       | <a href="#">ISOCurrencyCodeType</a>   |
| properties | isRef 0<br>minOcc 0<br>maxOcc 1<br>content simple   |
| facets     | Kind Value annotation<br>minLength 3<br>maxLength 3<br>pattern [A-Z]{3}   |
| annotation | documentation<br>11070-In the rare occasion of a share class currency change - this needs to be populated with the old share class currency. Should only be populated in case a share class currency change took place.   |

element **CEPT\_PriceType/Exchange\_rate\_for\_change\_in\_share\_class\_currency**

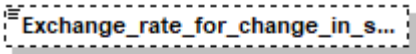
|            |   |
|------------|---|
| diagram    |  <p>11080-In the rare occasion of a share class currency change - this needs to be populated with the value: (old share class currency/new share class currency). Should only be populated in case a share class currency change took place.</p> |
| type       | <b>xs:decimal</b>   |
| properties | isRef 0<br>minOcc 0<br>maxOcc 1<br>content simple   |
| annotation | documentation<br>11080-In the rare occasion of a share class currency change - this needs to be populated with the value: (old share class currency/new share class currency). Should only be populated in case a share class currency change took place.   |

element **CEPT\_PriceType/Old\_Valuation\_Frequency**

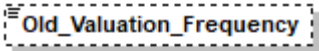
|            |   |
|------------|---|
| diagram    |  <p>11090-In the rare occasion of a valuation frequency change - this needs to be populated with the old value of EPT field 01010_Valuation_Frequency. Should only be populated in case a share class currency change took place.<br/>         "0" = other than<br/>         "1" = annual<br/>         "2" = biannual<br/>         "4" = quarterly<br/>         "12" = monthly<br/>         "24" = bimonthly<br/>         "52" = weekly<br/>         "104" = biweekly<br/>         "252" = daily</p> |
| type       | restriction of <b>xs:int</b>  |
| properties | isRef 0<br>minOcc 0<br>maxOcc 1<br>content simple   |
| annotation | documentation<br>11090-In the rare occasion of a valuation frequency change - this needs to be populated with the old value of EPT field 01010_Valuation_Frequency. Should only be populated in case a share class currency change took place.<br>"0" = other than<br>"1" = annual<br>"2" = biannual<br>"4" = quarterly<br>"12" = monthly<br>"24" = bimonthly<br>"52" = weekly<br>"104" = biweekly<br>"252" = daily   |

complexType **CEPT\_RHPSType**

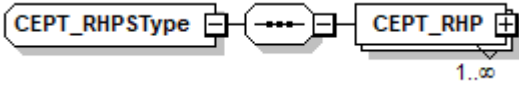
|          |   |
|----------|---|
| diagram  |  <p>The diagram shows a complex type <b>CEPT_RHPSType</b> containing a sequence of elements. The first element is <b>CEPT_RHP</b>, which is repeated 1 to infinity times (1..∞).</p> |
| children | <a href="#">CEPT_RHP</a>  |
| used by  | element <a href="#">PRIIPS_ReportType/CEPT_RHPS</a>   |

element **CEPT\_RHPSType/CEPT\_RHP**

|                   |  |
|-------------------|--|
| <p>diagram</p>    | <pre> classDiagram     class CEPT_RHP {         "1..∞"     }     class RHPPeriodsDefinition {         "31-Definition of periods per RHPs and investment amount base"     }     class Risk {         "32- Risk section"     }     class PerformaceScenario {         "33-Performance Scenario Section. The following calculated investment amounts are based on value 31060_Investment amount."     }     class Cost {         "34-Cost Section. The amounts shown here are the cumulative costs of the product itself, for three different holding periods. They include potential early exit penalties. The figures assume you invest field value 01040_Investment amount = 10 000. The figures are estimates and may change in the future."     }     CEPT_RHP --&gt; RHPPeriodsDefinition     CEPT_RHP --&gt; Risk     CEPT_RHP --&gt; PerformaceScenario     CEPT_RHP --&gt; Cost     </pre> |
| <p>properties</p> | <p>isRef 0<br/> minOcc 1<br/> maxOcc unbounded<br/> content complex</p>  |
| <p>children</p>   | <p><a href="#">RHPPeriodsDefinition</a> <a href="#">Risk</a> <a href="#">PerformaceScenario</a> <a href="#">Cost</a></p>   |

element **CEPT\_RHPSType/CEPT\_RHP/RHPPeriodsDefinition**

|                   |  |
|-------------------|--|
| <p>diagram</p>    | <p><b>RHPPeriodsDefinition</b><br/>31-Definition of periods per RHPs and investment amount base</p> <p><b>Period_1</b><br/>31010-Has to be set as default value 1 and only to be filled when HP of product is <math>\geq 3</math></p> <p><b>Period_2</b><br/>31020-Is considered as RHP/2 and rounded up to the nearest year. Has to be filled when RHP is <math>&gt; 3</math></p> <p><b>HP_Period_3</b><br/>31030-The holding period (HP) is the period used as a basis for the calculation of the subsequent purposes. It gives the MOPs manufacturer the possibility to align the HP of the underlying investment option with the RHP of the MOP.</p> <p><b>Lump_sum_or_regular_premiu...</b><br/>31050-To indicate whether a lump sum or regular premium option has been chosen. One of the options in the following closed list to be used:<br/>LS - Lump sum<br/>RP - Regular premium</p> <p><b>Investment_Amount</b><br/>31060-Standard 10,000 for lump sum or 1,000 for regular premium</p> <p><b>Accumulated_Investment_amo...</b><br/>31070-</p> |
| <p>properties</p> | <p>isRef 0<br/>content complex</p>   |
| <p>children</p>   | <p><a href="#">Period_1</a> <a href="#">Period_2</a> <a href="#">HP_Period_3</a> <a href="#">Lump_sum_or_regular_premiu...</a> <a href="#">Investment_Amount</a> <a href="#">Accumulated_Investment_amo...</a></p>   |
| <p>annotation</p> | <p>documentation<br/>31-Definition of periods per RHPs and investment amount base</p>  |

element **CEPT\_RHPSType/CEPT\_RHP/RHPPeriodsDefinition/Period\_1**

|                   |   |
|-------------------|---|
| <p>diagram</p>    | <p><b>Period_1</b><br/>31010-Has to be set as default value 1 and only to be filled when HP of product is <math>\geq 3</math></p> |
| <p>type</p>       | <p><b>xs:positiveInteger</b></p>  |
| <p>properties</p> | <p>isRef 0<br/>minOcc 0<br/>maxOcc 1<br/>content simple</p>   |



|            |   |
|------------|---|
| annotation | documentation<br>31010-Has to be set as default value 1 and only to be filled when HP of product is >=3 |
|------------|---|

element **CEPT\_RHPSType/CEPT\_RHP/RHPPeriodsDefinition/Period\_2**

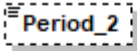
|            |  |
|------------|--|
| diagram    |  <p>31020-Is considered as RHP/2 and rounded up to the nearest year. Has to be filled when RHP is &gt;3</p> |
| type       | <b>xs:positiveInteger</b>  |
| properties | isRef 0<br>minOcc 0<br>maxOcc 1<br>content simple  |
| annotation | documentation<br>31020-Is considered as RHP/2 and rounded up to the nearest year. Has to be filled when RHP is >3  |

element **CEPT\_RHPSType/CEPT\_RHP/RHPPeriodsDefinition/HP\_Period\_3**

|            |  |
|------------|--|
| diagram    |  <p>31030-The holding period (HP) is the period used as a basis for the calculation of the subsequent purposes. It gives the MOPs manufacturer the possibility to align the HP of the underlying investment option with the RHP of the MOP.</p> |
| type       | <b>xs:positiveInteger</b>  |
| properties | isRef 0<br>content simple  |
| annotation | documentation<br>31030-The holding period (HP) is the period used as a basis for the calculation of the subsequent purposes. It gives the MOPs manufacturer the possibility to align the HP of the underlying investment option with the RHP of the MOP.   |

element **CEPT\_RHPSType/CEPT\_RHP/RHPPeriodsDefinition/Lump\_sum\_or\_regular\_premium\_indicator**

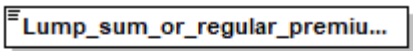
|            |  |
|------------|--|
| diagram    |  <p>31050-To indicate whether a lump sum or regular premium option has been chosen<br/>One of the options in the following closed list to be used:<br/>LS - Lump sum<br/>RP - Regular premium</p> |
| type       | restriction of <b>xs:string</b>  |
| properties | isRef 0<br>content simple  |
| facets     | Kind Value annotation<br>maxLength 2   |
| annotation | documentation<br>31050-To indicate whether a lump sum or regular premium option has been chosen<br>One of the options in the following closed list to be used:<br>LS - Lump sum<br>RP - Regular premium  |

element **CEPT\_RHPSType/CEPT\_RHP/RHPPeriodsDefinition/Investment\_Amount**

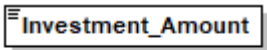
|            |  |
|------------|--|
| diagram    |  <p>31060-Standard 10,000 for lump sum or 1,000 for regular premium</p> |
| type       | <b>xs:positiveInteger</b>  |
| properties | isRef 0<br>content simple  |
| annotation | documentation<br>31060-Standard 10,000 for lump sum or 1,000 for regular premium   |

element **CEPT\_RHPSType/CEPT\_RHP/RHPPeriodsDefinition/Accumulated\_Investment\_amount**

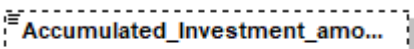
|            |   |
|------------|---|
| diagram    |  <p>31070-</p> |
| type       | <b>xs:decimal</b>   |
| properties | isRef 0<br>minOcc 0<br>maxOcc 1<br>content simple   |
| annotation | documentation<br>31070-   |

element **CEPT\_RHPSType/CEPT\_RHP/Risk**

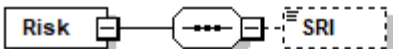
|            |  |
|------------|--|
| diagram    |  <p>32- Risk section</p> <p>32010-The summary risk indicator (SRI) shall be presented in a numerical scale ranging from 1 to 7, where 1 indicates the lowest risk class and 7 indicates the highest risk class. Calculated based on the RHP of the underlying PRIIP</p> |
| properties | isRef 0<br>content complex   |
| children   | <a href="#">SRI</a>  |
| annotation | documentation<br>32- Risk section  |

element **CEPT\_RHPSType/CEPT\_RHP/Risk/SRI**

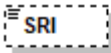
|            |  |
|------------|--|
| diagram    |  <p>32010-The summary risk indicator (SRI) shall be presented in a numerical scale ranging from 1 to 7, where 1 indicates the lowest risk class and 7 indicates the highest risk class.<br/>Calculated based on the RHP of the underlying PRIIP</p> |
| type       | restriction of <b>xs:integer</b>   |
| properties | <p>isRef 0<br/>minOcc 0<br/>maxOcc 1<br/>content simple</p>  |
| annotation | <p>documentation<br/>32010-The summary risk indicator (SRI) shall be presented in a numerical scale ranging from 1 to 7, where 1 indicates the lowest risk class and 7 indicates the highest risk class.<br/>Calculated based on the RHP of the underlying PRIIP</p>   |

element **CEPT\_RHPSType/CEPT\_RHP/PerformanceScenario**

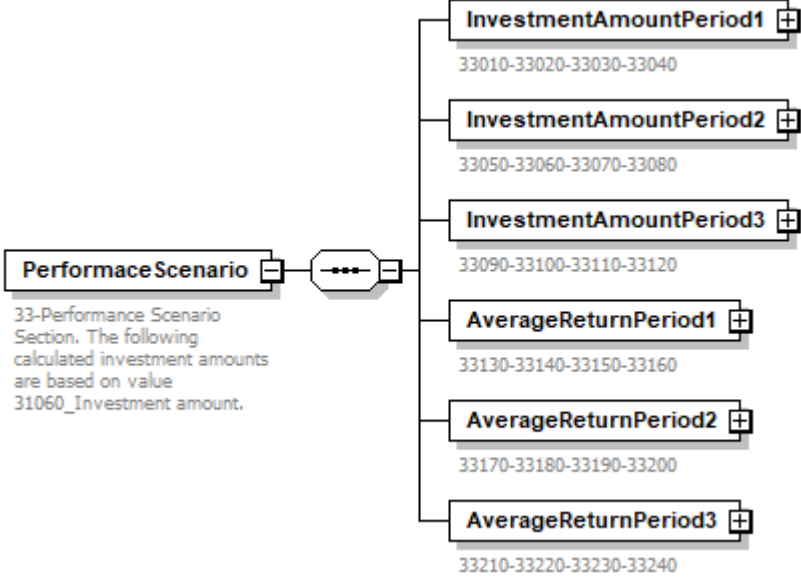
|            |   |
|------------|---|
| diagram    |  <p>33-Performance Scenario Section. The following calculated investment amounts are based on value 31060_Investment amount.</p>                               |
| properties | <p>isRef 0<br/>content complex</p>  |
| children   | <p><a href="#">InvestmentAmountPeriod1</a> <a href="#">InvestmentAmountPeriod2</a> <a href="#">InvestmentAmountPeriod3</a> <a href="#">AverageReturnPeriod1</a><br/><a href="#">AverageReturnPeriod2</a> <a href="#">AverageReturnPeriod3</a></p> |
| annotation | <p>documentation<br/>33-Performance Scenario Section. The following calculated investment amounts are based on value 31060_Investment amount.</p>   |

element **CEPT\_RHPSType/CEPT\_RHP/PerformaceScenario/InvestmentAmountPeriod1**

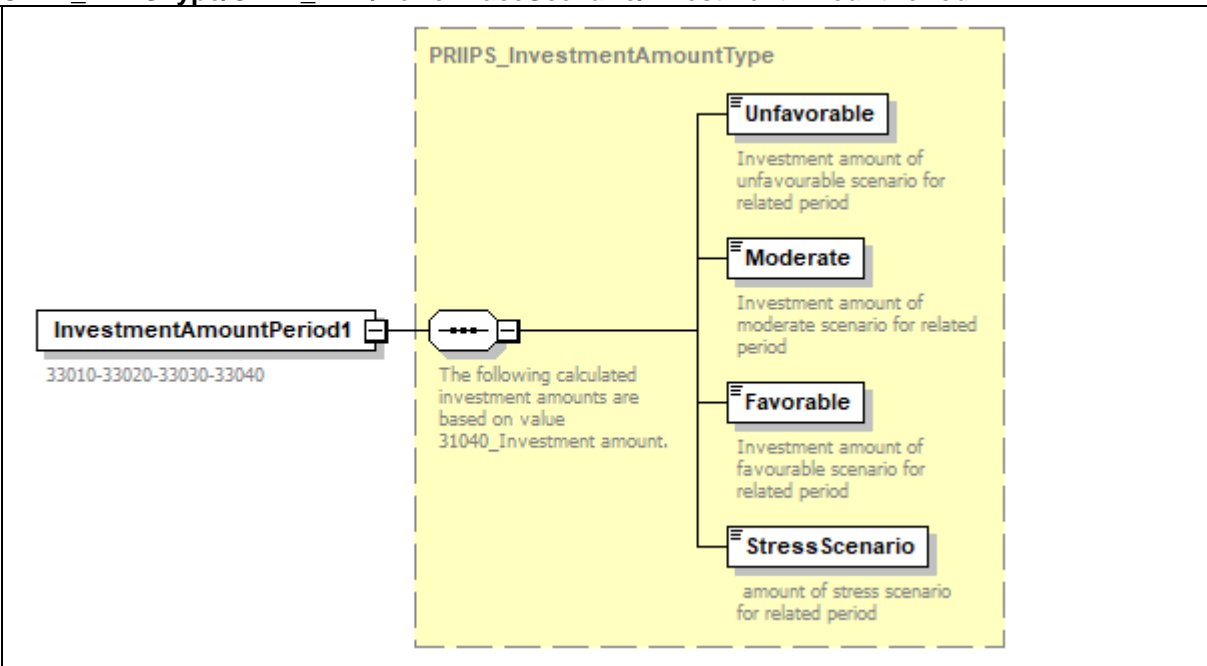
|                   |  |
|-------------------|--|
| <p>diagram</p>    |                                    |
| <p>type</p>       | <p><a href="#">PRIIPS_InvestmentAmountType</a></p>   |
| <p>properties</p> | <p>isRef 0<br/>content complex</p>   |
| <p>children</p>   | <p><a href="#">Unfavorable</a> <a href="#">Moderate</a> <a href="#">Favorable</a> <a href="#">StressScenario</a></p> |
| <p>annotation</p> | <p>documentation<br/>33010-33020-33030-33040</p>   |

element **CEPT\_RHPSType/CEPT\_RHP/PerformaceScenario/InvestmentAmountPeriod2**

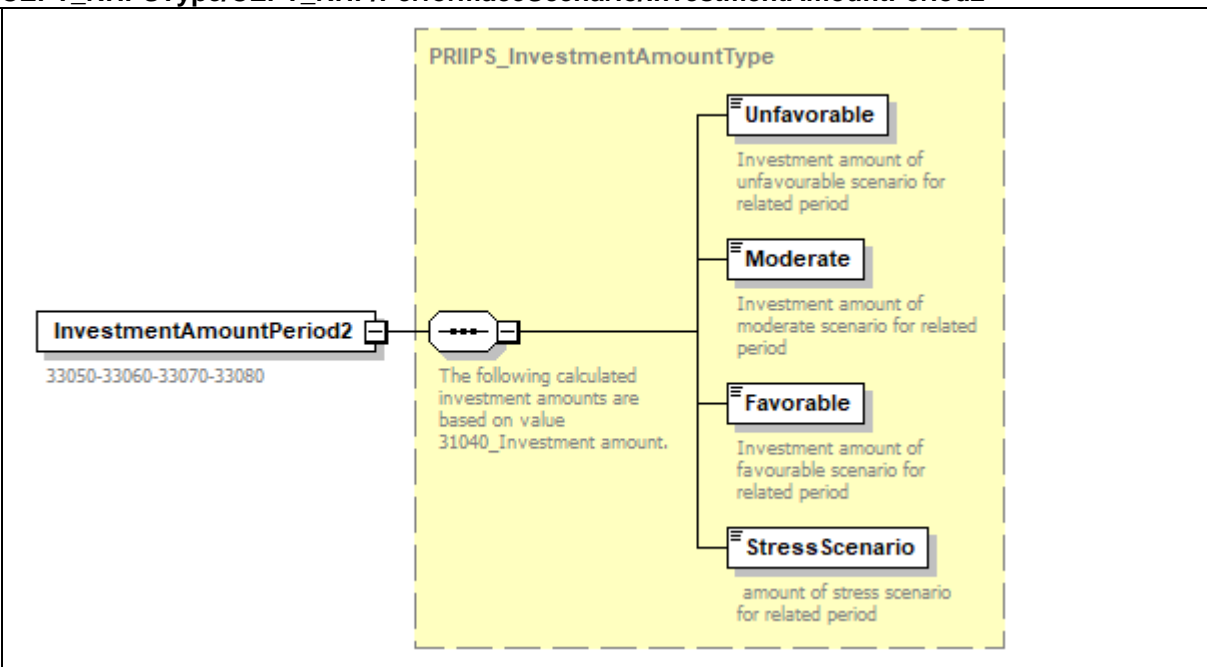
|                |  |
|----------------|--|
| <p>diagram</p> |  |
| <p>type</p>    | <p><a href="#">PRIIPS_InvestmentAmountType</a></p>                                   |

|            |   |
|------------|---|
| properties | isRef 0<br>content complex  |
| children   | <a href="#">Unfavorable</a> <a href="#">Moderate</a> <a href="#">Favorable</a> <a href="#">StressScenario</a> |
| annotation | documentation<br>33050-33060-33070-33080  |

element **CEPT\_RHPSType/CEPT\_RHP/PerformaceScenario/InvestmentAmountPeriod3**

|            |   |
|------------|---|
| diagram    |   |
| type       | <a href="#">PRIIPS_InvestmentAmountType</a>   |
| properties | isRef 0<br>content complex  |
| children   | <a href="#">Unfavorable</a> <a href="#">Moderate</a> <a href="#">Favorable</a> <a href="#">StressScenario</a> |
| annotation | documentation<br>33090-33100-33110-33120  |

element **CEPT\_RHPSType/CEPT\_RHP/PerformaceScenario/AverageReturnPeriod1**

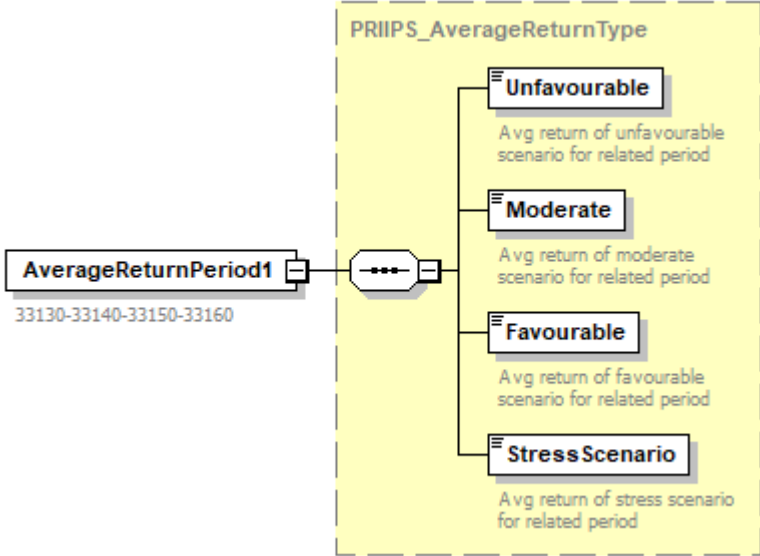
|                   |  |
|-------------------|--|
| <p>diagram</p>    |                                      |
| <p>type</p>       | <p><a href="#">PRIIPS_AverageReturnTypes</a></p>   |
| <p>properties</p> | <p>isRef 0<br/>content complex</p>   |
| <p>children</p>   | <p><a href="#">Unfavourable</a> <a href="#">Moderate</a> <a href="#">Favourable</a> <a href="#">StressScenario</a></p> |
| <p>annotation</p> | <p>documentation<br/>33130-33140-33150-33160</p>   |

element **CEPT\_RHPSType/CEPT\_RHP/PerformaceScenario/AverageReturnPeriod2**

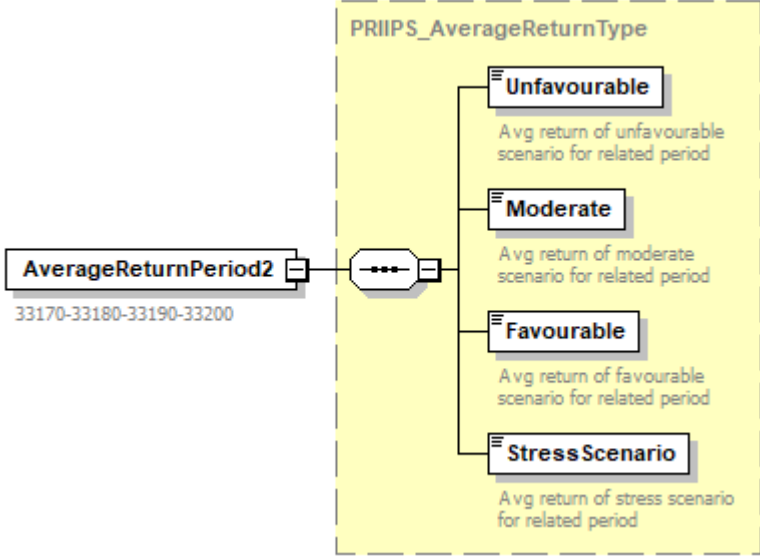
|                   |  |
|-------------------|--|
| <p>diagram</p>    |                                    |
| <p>type</p>       | <p><a href="#">PRIIPS_AverageReturnTypes</a></p>   |
| <p>properties</p> | <p>isRef 0<br/>content complex</p>   |
| <p>children</p>   | <p><a href="#">Unfavourable</a> <a href="#">Moderate</a> <a href="#">Favourable</a> <a href="#">StressScenario</a></p> |
| <p>annotation</p> | <p>documentation<br/>33170-33180-33190-33200</p>   |

element CEPT\_RHPSType/CEPT\_RHP/PerformaceScenario/AverageReturnPeriod3

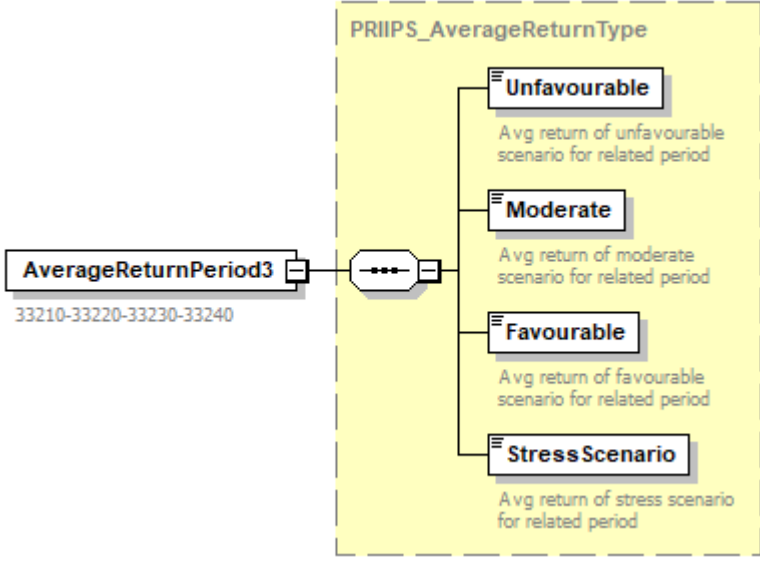
|                   |   |
|-------------------|---|
| <p>diagram</p>    |  <p>The diagram illustrates the structure of the <b>AverageReturnPeriod3</b> element. It is represented by a class box with the ID <b>33210-33220-33230-33240</b>. This class is connected to a container box labeled <b>PRIIPS_AverageReturnTypes</b>. Inside this container, there are four subclasses, each with a description of its average return for a related period:</p> <ul style="list-style-type: none"> <li><b>Unfavourable</b>: Avg return of unfavourable scenario for related period</li> <li><b>Moderate</b>: Avg return of moderate scenario for related period</li> <li><b>Favourable</b>: Avg return of favourable scenario for related period</li> <li><b>Stress Scenario</b>: Avg return of stress scenario for related period</li> </ul> |
| <p>type</p>       | <p><a href="#">PRIIPS_AverageReturnTypes</a></p>  |
| <p>properties</p> | <p>isRef 0<br/>content complex</p>  |
| <p>children</p>   | <p><a href="#">Unfavourable</a> <a href="#">Moderate</a> <a href="#">Favourable</a> <a href="#">StressScenario</a></p>  |
| <p>annotation</p> | <p>documentation<br/>33210-33220-33230-33240</p>  |

element **CEPT\_RHPSType/CEPT\_RHP/Cost**

diagram



34-Cost Section. The amounts shown here are the cumulative costs of the product itself, for three different holding periods. They include potential early exit penalties. The figures assume you invest field value 01040\_Investment amount = 10 000. The figures are estimates and may change in the future.

**TotalPeriod1**

34010-The Reduction in Yield (RIY) shows what impact the total costs you pay will have on the investment return you might get. The total costs take into account one-off, ongoing and incidental costs. The Reduction in Yield (RIY) shows what impact the total costs you pay will have on the investment return you might get. The total costs take into account one-off, ongoing and incidental costs.

The amounts shown here are the cumulative costs of the product itself, for three different holding periods. They include potential early exit penalties. The figures assume you invest field value 01040\_Investment amount = 10 000. The figures are estimates and may change in the future.

**TotalPeriod2**

34020-The Reduction in Yield (RIY) shows what impact the total costs you pay will have on the investment return you might get. The total costs take into account one-off, ongoing and incidental costs. The Reduction in Yield (RIY) shows what impact the total costs you pay will have on the investment return you might get. The total costs take into account one-off, ongoing and incidental costs.

The amounts shown here are the cumulative costs of the product itself, for three different holding periods. They include potential early exit penalties. The figures assume you invest field value 01040\_Investment amount = 10 000. The figures are estimates and may change in the future.

**TotalPeriod3**

34030-The Reduction in Yield (RIY) shows what impact the total costs you pay will have on the investment return you might get. The total costs take into account one-off, ongoing and incidental costs. The Reduction in Yield (RIY) shows what impact the total costs you pay will have on the investment return you might get. The total costs take into account one-off, ongoing and incidental costs.

The amounts shown here are the cumulative costs of the product itself, for three different holding periods. They include potential early exit penalties. The figures assume you invest field value 01040\_Investment amount = 10 000. The figures are estimates and may change in the future.

**PercentageRIYPeriod1**

34040

**PercentageRIYPeriod2**

34050

**PercentageRIYPeriod3**

34060



|            |  |
|------------|--|
| properties | isRef 0<br>content complex   |
| children   | <a href="#">TotalPeriod1</a> <a href="#">TotalPeriod2</a> <a href="#">TotalPeriod3</a> <a href="#">PercentageRIYPeriod1</a> <a href="#">PercentageRIYPeriod2</a> <a href="#">PercentageRIYPeriod3</a>  |
| annotation | documentation<br>34-Cost Section. The amounts shown here are the cumulative costs of the product itself, for three different holding periods. They include potential early exit penalties. The figures assume you invest field value 01040_Investment amount = 10 000. The figures are estimates and may change in the future. |

element **CEPT\_RHPSType/CEPT\_RHP/Cost/TotalPeriod1**

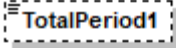
|            |  |
|------------|--|
| diagram    |  <p>34010-The Reduction in Yield (RIY) shows what impact the total costs you pay will have on the investment return you might get. The total costs take into account one-off, ongoing and incidental costs. The Reduction in Yield (RIY) shows what impact the total costs you pay will have on the investment return you might get. The total costs take into account one-off, ongoing and incidental costs.</p> <p>The amounts shown here are the cumulative costs of the product itself, for three different holding periods. They include potential early exit penalties. The figures assume you invest field value 01040_Investment amount = 10 000. The figures are estimates and may change in the future.</p> |
| type       | <b>xs:decimal</b>  |
| properties | isRef 0<br>minOcc 0<br>maxOcc 1<br>content simple  |
| annotation | documentation<br>34010-The Reduction in Yield (RIY) shows what impact the total costs you pay will have on the investment return you might get. The total costs take into account one-off, ongoing and incidental costs. The Reduction in Yield (RIY) shows what impact the total costs you pay will have on the investment return you might get. The total costs take into account one-off, ongoing and incidental costs. <p>The amounts shown here are the cumulative costs of the product itself, for three different holding periods. They include potential early exit penalties. The figures assume you invest field value 01040_Investment amount = 10 000. The figures are estimates and may change in the future.</p>   |

element **CEPT\_RHPSType/CEPT\_RHP/Cost/TotalPeriod2**

|                   |   |
|-------------------|---|
| <p>diagram</p>    |  <p><b>TotalPeriod2</b></p> <p>34020-The Reduction in Yield (RIY) shows what impact the total costs you pay will have on the investment return you might get. The total costs take into account one-off, ongoing and incidental costs. The Reduction in Yield (RIY) shows what impact the total costs you pay will have on the investment return you might get. The total costs take into account one-off, ongoing and incidental costs.</p> <p>The amounts shown here are the cumulative costs of the product itself, for three different holding periods. They include potential early exit penalties. The figures assume you invest field value 01040_Investment amount = 10 000. The figures are estimates and may change in the future.</p> |
| <p>type</p>       | <p><b>xs:decimal</b></p>  |
| <p>properties</p> | <p>isRef 0<br/> minOcc 0<br/> maxOcc 1<br/> content simple</p>  |
| <p>annotation</p> | <p>documentation<br/> 34020-The Reduction in Yield (RIY) shows what impact the total costs you pay will have on the investment return you might get. The total costs take into account one-off, ongoing and incidental costs. The Reduction in Yield (RIY) shows what impact the total costs you pay will have on the investment return you might get. The total costs take into account one-off, ongoing and incidental costs.</p> <p>The amounts shown here are the cumulative costs of the product itself, for three different holding periods. They include potential early exit penalties. The figures assume you invest field value 01040_Investment amount = 10 000. The figures are estimates and may change in the future.</p>   |

element **CEPT\_RHPSType/CEPT\_RHP/Cost/TotalPeriod3**

|            |  |
|------------|--|
| diagram    |  <p>34030-The Reduction in Yield (RIY) shows what impact the total costs you pay will have on the investment return you might get. The total costs take into account one-off, ongoing and incidental costs. The Reduction in Yield (RIY) shows what impact the total costs you pay will have on the investment return you might get. The total costs take into account one-off, ongoing and incidental costs.</p> <p>The amounts shown here are the cumulative costs of the product itself, for three different holding periods. They include potential early exit penalties. The figures assume you invest field value 01040_Investment amount = 10 000. The figures are estimates and may change in the future.</p> |
| type       | <b>xs:decimal</b>  |
| properties | isRef 0<br>minOcc 0<br>maxOcc 1<br>content simple  |
| annotation | documentation<br>34030-The Reduction in Yield (RIY) shows what impact the total costs you pay will have on the investment return you might get. The total costs take into account one-off, ongoing and incidental costs. The Reduction in Yield (RIY) shows what impact the total costs you pay will have on the investment return you might get. The total costs take into account one-off, ongoing and incidental costs.   |
|            | The amounts shown here are the cumulative costs of the product itself, for three different holding periods. They include potential early exit penalties. The figures assume you invest field value 01040_Investment amount = 10 000. The figures are estimates and may change in the future.   |

element **CEPT\_RHPSType/CEPT\_RHP/Cost/PercentageRIYPeriod1**

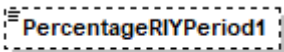
|            |  |
|------------|--|
| diagram    |  <p>34040</p> |
| type       | <b>xs:decimal</b>  |
| properties | isRef 0<br>minOcc 0<br>maxOcc 1<br>content simple  |
| annotation | documentation<br>34040   |

element **CEPT\_RHPSType/CEPT\_RHP/Cost/PercentageRIYPeriod2**

|            |  |
|------------|--|
| diagram    |  The diagram shows a rectangular box with a dashed border containing the text "PercentageRIYPeriod2" and the number "34050" below it. |
| type       | <b>xs:decimal</b>  |
| properties | isRef 0<br>minOcc 0<br>maxOcc 1<br>content simple  |
| annotation | documentation<br>34050   |

element **CEPT\_RHPSType/CEPT\_RHP/Cost/PercentageRIYPeriod3**

|            |  |
|------------|--|
| diagram    |  The diagram shows a rectangular box with a dashed border containing the text "PercentageRIYPeriod3" and the number "34060" below it. |
| type       | <b>xs:decimal</b>  |
| properties | isRef 0<br>minOcc 0<br>maxOcc 1<br>content simple  |
| annotation | documentation<br>34060   |

complexType **CEPTV2\_RHPSType**

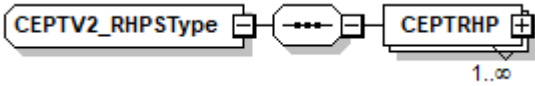
|          |  |
|----------|--|
| diagram  |  The diagram shows a sequence of three elements: "CEPTV2_RHPSType" (a rounded rectangle), a dashed line with a central circle (representing a sequence), and "CEPTRHP" (a rounded rectangle). The "CEPTRHP" element has a cardinality of "1..∞" below it. |
| children | <a href="#">CEPTRHP</a>  |
| used by  | element <a href="#">CEPTV2PerformanceType/CEPTRHPS</a>   |

element **CEPTV2\_RHPSType/CEPTRHP**

|                   |  |
|-------------------|--|
| <p>diagram</p>    | <pre> graph LR     CEPTRHP[CEPTRHP 1..∞] --- Container(( ))     Container --- RHPPeriodsDefinition[RHPPeriodsDefinition]     Container --- Risk[Risk]     Container --- PerformanceScenario[PerformanceScenario]     Container --- Cost[Cost]     </pre> <p><b>RHPPeriodsDefinition</b> </p> <p>31-Definition of periods per RHPs and investment amount base</p> <p><b>Risk</b> </p> <p>32- Risk section</p> <p><b>PerformanceScenario</b> </p> <p>33-Performance Scenario Section. The following calculated investment amounts are based on value 31060_Investment amount.</p> <p><b>Cost</b> </p> <p>34-Cost Section. The amounts shown here are the cumulative costs of the product itself, for three different holding periods. They include potential early exit penalties. The figures assume you invest field value 01040_Investment amount = 10 000. The figures are estimates and may change in the future.</p> |
| <p>properties</p> | <p>isRef 0<br/> minOcc 1<br/> maxOcc unbounded<br/> content complex</p>  |
| <p>children</p>   | <p><a href="#">RHPPeriodsDefinition</a> <a href="#">Risk</a> <a href="#">PerformanceScenario</a> <a href="#">Cost</a></p>  |

element **CEPTV2\_RHPSType/CEPTRHP/RHPPeriodsDefinition**

|                   |  |
|-------------------|--|
| <p>diagram</p>    | <p><b>RHPPeriodsDefinition</b><br/>31-Definition of periods per RHPs and investment amount base</p> <p><b>Period_1</b><br/>31010-Has to be set as default value 1 and only to be filled when HP of product is <math>\geq 3</math></p> <p><b>Period_2</b><br/>31020-Is considered as RHP/2 and rounded up to the nearest year. Has to be filled when RHP is <math>&gt; 3</math></p> <p><b>HP_Period_3</b><br/>31030-The holding period (HP) is the period used as a basis for the calculation of the subsequent purposes. It gives the MOPs manufacturer the possibility to align the HP of the underlying investment option with the RHP of the MOP.</p> <p><b>Lump_sum_or_regular_premiu...</b><br/>31050-To indicate whether a lump sum or regular premium option has been chosen. One of the options in the following closed list to be used:<br/>LS - Lump sum<br/>RP - Regular premium</p> <p><b>Investment_Amount</b><br/>31060-Standard 10,000 for lump sum or 1,000 for regular premium</p> <p><b>Accumulated_Investment_amo...</b><br/>31070-</p> |
| <p>properties</p> | <p>isRef 0<br/>content complex</p>   |
| <p>children</p>   | <p><a href="#">Period_1</a> <a href="#">Period_2</a> <a href="#">HP_Period_3</a> <a href="#">Lump_sum_or_regular_premium_indicator</a> <a href="#">Investment_Amount</a> <a href="#">Accumulated_Investment_amount</a></p>   |
| <p>annotation</p> | <p>documentation<br/>31-Definition of periods per RHPs and investment amount base</p>  |

element **CEPTV2\_RHPSType/CEPTRHP/RHPPeriodsDefinition/Period\_1**

|                   |   |
|-------------------|---|
| <p>diagram</p>    | <p><b>Period_1</b><br/>31010-Has to be set as default value 1 and only to be filled when HP of product is <math>\geq 3</math></p> |
| <p>type</p>       | <p><b>xs:positiveInteger</b></p>  |
| <p>properties</p> | <p>isRef 0<br/>minOcc 0<br/>maxOcc 1<br/>content simple</p>   |

|            |   |
|------------|---|
| annotation | documentation<br>31010-Has to be set as default value 1 and only to be filled when HP of product is >=3 |
|------------|---|

element **CEPTV2\_RHPSType/CEPTRHP/RHPPeriodsDefinition/Period\_2**

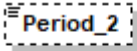
|            |  |
|------------|--|
| diagram    |  <p>31020-Is considered as RHP/2 and rounded up to the nearest year. Has to be filled when RHP is &gt;3</p> |
| type       | <b>xs:positiveInteger</b>  |
| properties | isRef 0<br>minOcc 0<br>maxOcc 1<br>content simple  |
| annotation | documentation<br>31020-Is considered as RHP/2 and rounded up to the nearest year. Has to be filled when RHP is >3  |

element **CEPTV2\_RHPSType/CEPTRHP/RHPPeriodsDefinition/HP\_Period\_3**

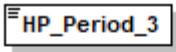
|            |  |
|------------|--|
| diagram    |  <p>31030-The holding period (HP) is the period used as a basis for the calculation of the subsequent purposes. It gives the MOPs manufacturer the possibility to align the HP of the underlying investment option with the RHP of the MOP.</p> |
| type       | <b>xs:positiveInteger</b>  |
| properties | isRef 0<br>content simple  |
| annotation | documentation<br>31030-The holding period (HP) is the period used as a basis for the calculation of the subsequent purposes. It gives the MOPs manufacturer the possibility to align the HP of the underlying investment option with the RHP of the MOP.   |

element **CEPTV2\_RHPSType/CEPTRHP/RHPPeriodsDefinition/Lump\_sum\_or\_regular\_premium\_indicator**

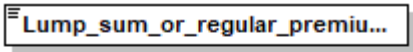
|            |  |
|------------|--|
| diagram    |  <p>31050-To indicate whether a lump sum or regular premium option has been chosen<br/>One of the options in the following closed list to be used:<br/>LS - Lump sum<br/>RP - Regular premium</p> |
| type       | restriction of <b>xs:string</b>  |
| properties | isRef 0<br>content simple  |
| facets     | Kind Value annotation<br>maxLength 2   |
| annotation | documentation<br>31050-To indicate whether a lump sum or regular premium option has been chosen<br>One of the options in the following closed list to be used:   |

|  |                                       |
|--|---------------------------------------|
|  | LS - Lump sum<br>RP - Regular premium |
|--|---------------------------------------|

element **CEPTV2\_RHPSType/CEPTRHP/RHPPeriodsDefinition/Investment\_Amount**

|            |  |
|------------|--|
| diagram    |  <p>31060-Standard 10,000 for lump sum or 1,000 for regular premium</p> |
| type       | <b>xs:positiveInteger</b>  |
| properties | isRef 0<br>content simple  |
| annotation | documentation<br>31060-Standard 10,000 for lump sum or 1,000 for regular premium   |

element **CEPTV2\_RHPSType/CEPTRHP/RHPPeriodsDefinition/Accumulated\_Investment\_amount**

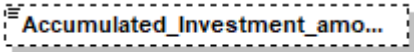
|            |   |
|------------|---|
| diagram    |  <p>31070-</p> |
| type       | <b>xs:decimal</b>   |
| properties | isRef 0<br>minOcc 0<br>maxOcc 1<br>content simple   |
| annotation | documentation<br>31070-   |

element **CEPTV2\_RHPSType/CEPTRHP/Risk**

|            |  |
|------------|--|
| diagram    |  <p>32- Risk section</p> <p>32010-The summary risk indicator (SRI) shall be presented in a numerical scale ranging from 1 to 7, where 1 indicates the lowest risk class and 7 indicates the highest risk class. Calculated based on the RHP of the underlying PRIIP</p> |
| properties | isRef 0<br>content complex   |
| children   | <a href="#">SRI</a>  |
| annotation | documentation<br>32- Risk section  |

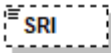

element **CEPTV2\_RHPSType/CEPTRHP/Risk/SRI**

|            |  |
|------------|--|
| diagram    |  <p>32010-The summary risk indicator (SRI) shall be presented in a numerical scale ranging from 1 to 7, where 1 indicates the lowest risk class and 7 indicates the highest risk class.<br/>Calculated based on the RHP of the underlying PRIIP</p> |
| type       | restriction of <b>xs:integer</b>   |
| properties | <p>isRef 0<br/>minOcc 0<br/>maxOcc 1<br/>content simple</p>  |
| annotation | <p>documentation<br/>32010-The summary risk indicator (SRI) shall be presented in a numerical scale ranging from 1 to 7, where 1 indicates the lowest risk class and 7 indicates the highest risk class.<br/>Calculated based on the RHP of the underlying PRIIP</p>   |

element **CEPTV2\_RHPSType/CEPTRHP/PerformanceScenario**

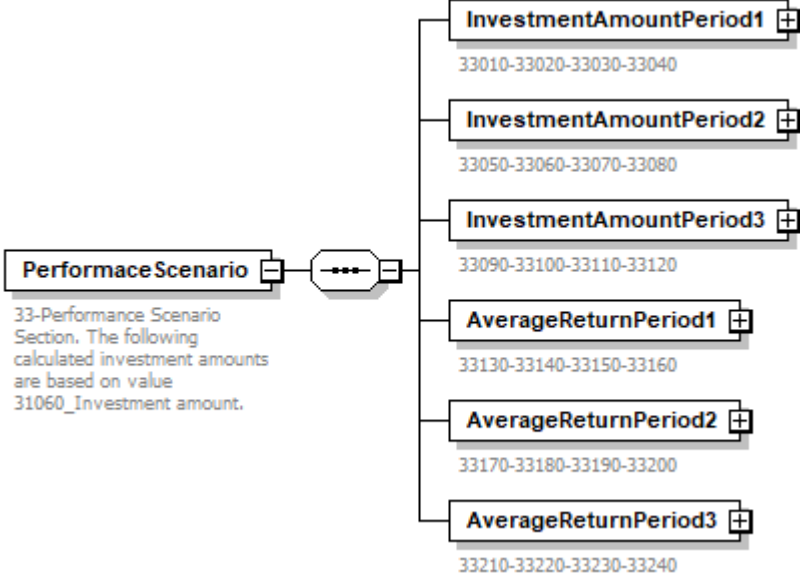
|            |   |
|------------|---|
| diagram    |  <p>33-Performance Scenario Section. The following calculated investment amounts are based on value 31060_Investment amount.</p>                           |
| properties | <p>isRef 0<br/>content complex</p>  |
| children   | <p><a href="#">InvestmentAmountPeriod1</a> <a href="#">InvestmentAmountPeriod2</a> <a href="#">InvestmentAmountPeriod3</a> <a href="#">AverageReturnPeriod1</a> <a href="#">AverageReturnPeriod2</a> <a href="#">AverageReturnPeriod3</a></p> |
| annotation | <p>documentation<br/>33-Performance Scenario Section. The following calculated investment amounts are based on value 31060_Investment amount.</p>   |

element CEPTV2\_RHPSType/CEPTRHP/PerformaceScenario/InvestmentAmountPeriod1

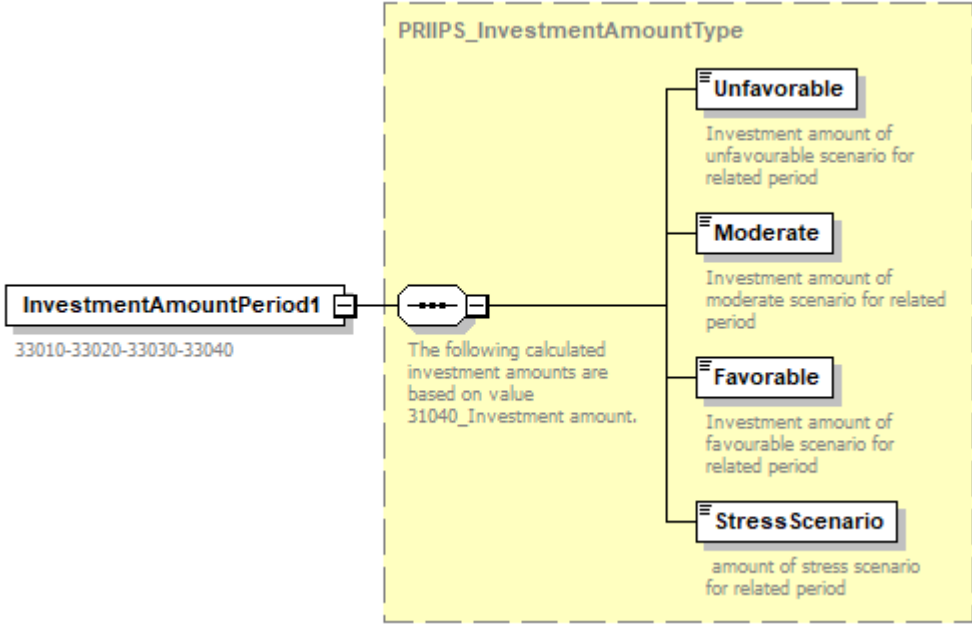
|                   |  |
|-------------------|--|
| <p>diagram</p>    |                                    |
| <p>type</p>       | <p><a href="#">PRIIPS_InvestmentAmountType</a></p>   |
| <p>properties</p> | <p>isRef 0<br/>content complex</p>   |
| <p>children</p>   | <p><a href="#">Unfavorable</a> <a href="#">Moderate</a> <a href="#">Favorable</a> <a href="#">StressScenario</a></p> |
| <p>annotation</p> | <p>documentation<br/>33010-33020-33030-33040</p>   |

element CEPTV2\_RHPSType/CEPTRHP/PerformaceScenario/InvestmentAmountPeriod2

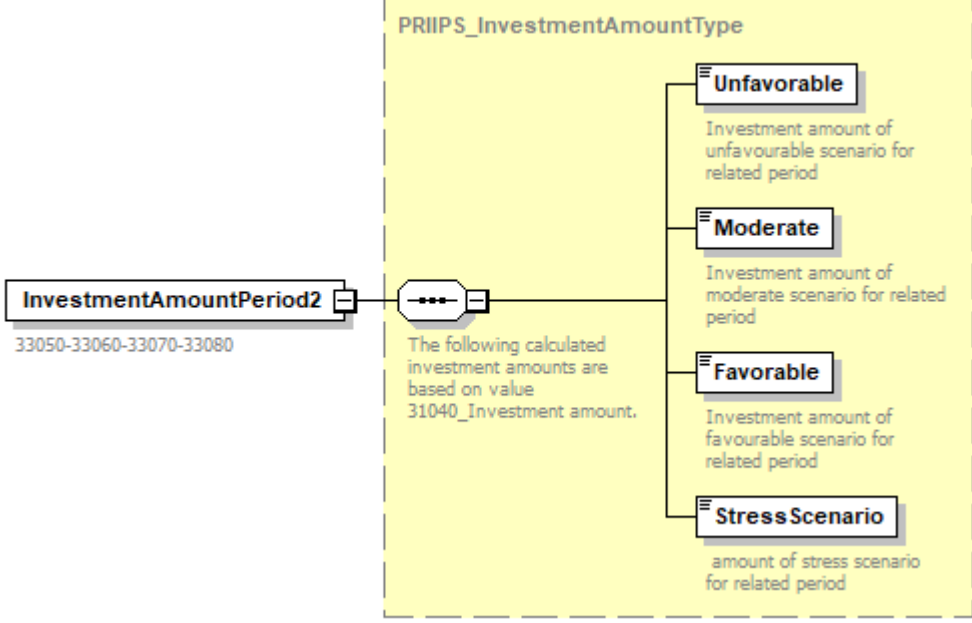
|                |  |
|----------------|--|
| <p>diagram</p> |  |
| <p>type</p>    | <p><a href="#">PRIIPS_InvestmentAmountType</a></p>                                   |

|            |   |
|------------|---|
| properties | isRef 0<br>content complex  |
| children   | <a href="#">Unfavorable</a> <a href="#">Moderate</a> <a href="#">Favorable</a> <a href="#">StressScenario</a> |
| annotation | documentation<br>33050-33060-33070-33080  |

element **CEPTV2\_RHPSType/CEPTRHP/PerformaceScenario/InvestmentAmountPeriod3**

|            |  |
|------------|--|
| diagram    | <p>The diagram illustrates the structure of the <b>InvestmentAmountPeriod3</b> element. It is a class with a dashed line indicating a complex content. The content is a <b>PRIIPS_InvestmentAmountType</b>, which is a container for four scenarios: <b>Unfavorable</b>, <b>Moderate</b>, <b>Favorable</b>, and <b>Stress Scenario</b>. Each scenario has a descriptive text box below it.</p> <p><b>InvestmentAmountPeriod3</b><br/>33090-33100-33110-33120</p> <p><b>PRIIPS_InvestmentAmountType</b></p> <p>The following calculated investment amounts are based on value 31040_Investment amount.</p> <ul style="list-style-type: none"> <li><b>Unfavorable</b>: Investment amount of unfavourable scenario for related period</li> <li><b>Moderate</b>: Investment amount of moderate scenario for related period</li> <li><b>Favorable</b>: Investment amount of favourable scenario for related period</li> <li><b>Stress Scenario</b>: amount of stress scenario for related period</li> </ul> |
| type       | <a href="#">PRIIPS_InvestmentAmountType</a>  |
| properties | isRef 0<br>content complex   |
| children   | <a href="#">Unfavorable</a> <a href="#">Moderate</a> <a href="#">Favorable</a> <a href="#">StressScenario</a>  |
| annotation | documentation<br>33090-33100-33110-33120   |

element **CEPTV2\_RHPSType/CEPTRHP/PerformaceScenario/AverageReturnPeriod1**

|                   |   |
|-------------------|---|
| <p>diagram</p>    | <pre> classDiagram     class AverageReturnPeriod1 {         33130-33140-33150-33160     }     class PRIIPS_AverageReturntype {         Unfavourable {             Avg return of unfavourable scenario for related period         }         Moderate {             Avg return of moderate scenario for related period         }         Favourable {             Avg return of favourable scenario for related period         }         StressScenario {             Avg return of stress scenario for related period         }     }     AverageReturnPeriod1 -- &gt; PRIIPS_AverageReturntype             </pre> |
| <p>type</p>       | <p><a href="#">PRIIPS_AverageReturntype</a></p>   |
| <p>properties</p> | <p>isRef 0<br/>content complex</p>  |
| <p>children</p>   | <p><a href="#">Unfavourable</a> <a href="#">Moderate</a> <a href="#">Favourable</a> <a href="#">StressScenario</a></p>  |
| <p>annotation</p> | <p>documentation<br/>33130-33140-33150-33160</p>  |

element **CEPTV2\_RHPSType/CEPTRHP/PerformaceScenario/AverageReturnPeriod2**

|                   |   |
|-------------------|---|
| <p>diagram</p>    | <pre> classDiagram     class AverageReturnPeriod2 {         33170-33180-33190-33200     }     class PRIIPS_AverageReturntype {         Unfavourable {             Avg return of unfavourable scenario for related period         }         Moderate {             Avg return of moderate scenario for related period         }         Favourable {             Avg return of favourable scenario for related period         }         StressScenario {             Avg return of stress scenario for related period         }     }     AverageReturnPeriod2 -- &gt; PRIIPS_AverageReturntype             </pre> |
| <p>type</p>       | <p><a href="#">PRIIPS_AverageReturntype</a></p>   |
| <p>properties</p> | <p>isRef 0<br/>content complex</p>  |
| <p>children</p>   | <p><a href="#">Unfavourable</a> <a href="#">Moderate</a> <a href="#">Favourable</a> <a href="#">StressScenario</a></p>  |
| <p>annotation</p> | <p>documentation<br/>33170-33180-33190-33200</p>  |

element CEPTV2\_RHPSType/CEPTRHP/PerformanceScenario/AverageReturnPeriod3

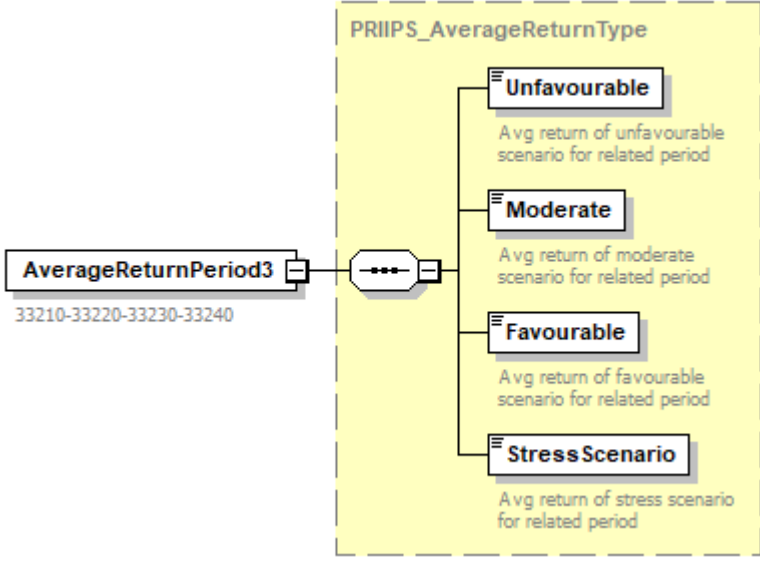
|                   |  |
|-------------------|--|
| <p>diagram</p>    |                                      |
| <p>type</p>       | <p><a href="#">PRIIPS_AverageReturnTypes</a></p>   |
| <p>properties</p> | <p>isRef 0<br/>content complex</p>   |
| <p>children</p>   | <p><a href="#">Unfavourable</a> <a href="#">Moderate</a> <a href="#">Favourable</a> <a href="#">StressScenario</a></p> |
| <p>annotation</p> | <p>documentation<br/>33210-33220-33230-33240</p>   |

element **CEPTV2\_RHPSType/CEPTRHP/Cost**

diagram



34-Cost Section. The amounts shown here are the cumulative costs of the product itself, for three different holding periods. They include potential early exit penalties. The figures assume you invest field value 01040\_Investment amount = 10 000. The figures are estimates and may change in the future.

**TotalPeriod1**

34010-The Reduction in Yield (RIY) shows what impact the total costs you pay will have on the investment return you might get. The total costs take into account one-off, ongoing and incidental costs. The Reduction in Yield (RIY) shows what impact the total costs you pay will have on the investment return you might get. The total costs take into account one-off, ongoing and incidental costs.

The amounts shown here are the cumulative costs of the product itself, for three different holding periods. They include potential early exit penalties. The figures assume you invest field value 01040\_Investment amount = 10 000. The figures are estimates and may change in the future.

**TotalPeriod2**

34020-The Reduction in Yield (RIY) shows what impact the total costs you pay will have on the investment return you might get. The total costs take into account one-off, ongoing and incidental costs. The Reduction in Yield (RIY) shows what impact the total costs you pay will have on the investment return you might get. The total costs take into account one-off, ongoing and incidental costs.

The amounts shown here are the cumulative costs of the product itself, for three different holding periods. They include potential early exit penalties. The figures assume you invest field value 01040\_Investment amount = 10 000. The figures are estimates and may change in the future.

**TotalPeriod3**

34030-The Reduction in Yield (RIY) shows what impact the total costs you pay will have on the investment return you might get. The total costs take into account one-off, ongoing and incidental costs. The Reduction in Yield (RIY) shows what impact the total costs you pay will have on the investment return you might get. The total costs take into account one-off, ongoing and incidental costs.

The amounts shown here are the cumulative costs of the product itself, for three different holding periods. They include potential early exit penalties. The figures assume you invest field value 01040\_Investment amount = 10 000. The figures are estimates and may change in the future.

**PercentageRIYPeriod1**

34040

**PercentageRIYPeriod2**

34050

**PercentageRIYPeriod3**

34060

|            |  |
|------------|--|
| properties | isRef 0<br>content complex   |
| children   | <a href="#">TotalPeriod1</a> <a href="#">TotalPeriod2</a> <a href="#">TotalPeriod3</a> <a href="#">PercentageRIYPeriod1</a> <a href="#">PercentageRIYPeriod2</a> <a href="#">PercentageRIYPeriod3</a>  |
| annotation | documentation<br>34-Cost Section. The amounts shown here are the cumulative costs of the product itself, for three different holding periods. They include potential early exit penalties. The figures assume you invest field value 01040_Investment amount = 10 000. The figures are estimates and may change in the future. |

element **CEPTV2\_RHPSType/CEPTRHP/Cost/TotalPeriod1**

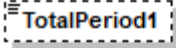
|            |  |
|------------|--|
| diagram    |  <p>34010-The Reduction in Yield (RIY) shows what impact the total costs you pay will have on the investment return you might get. The total costs take into account one-off, ongoing and incidental costs. The Reduction in Yield (RIY) shows what impact the total costs you pay will have on the investment return you might get. The total costs take into account one-off, ongoing and incidental costs.</p> <p>The amounts shown here are the cumulative costs of the product itself, for three different holding periods. They include potential early exit penalties. The figures assume you invest field value 01040_Investment amount = 10 000. The figures are estimates and may change in the future.</p> |
| type       | <b>xs:decimal</b>  |
| properties | isRef 0<br>minOcc 0<br>maxOcc 1<br>content simple  |
| annotation | documentation<br>34010-The Reduction in Yield (RIY) shows what impact the total costs you pay will have on the investment return you might get. The total costs take into account one-off, ongoing and incidental costs. The Reduction in Yield (RIY) shows what impact the total costs you pay will have on the investment return you might get. The total costs take into account one-off, ongoing and incidental costs. <p>The amounts shown here are the cumulative costs of the product itself, for three different holding periods. They include potential early exit penalties. The figures assume you invest field value 01040_Investment amount = 10 000. The figures are estimates and may change in the future.</p>   |

element **CEPTV2\_RHPSType/CEPTRHP/Cost/TotalPeriod2**

|                   |   |
|-------------------|---|
| <p>diagram</p>    |  <p><b>TotalPeriod2</b></p> <p>34020-The Reduction in Yield (RIY) shows what impact the total costs you pay will have on the investment return you might get. The total costs take into account one-off, ongoing and incidental costs. The Reduction in Yield (RIY) shows what impact the total costs you pay will have on the investment return you might get. The total costs take into account one-off, ongoing and incidental costs.</p> <p>The amounts shown here are the cumulative costs of the product itself, for three different holding periods. They include potential early exit penalties. The figures assume you invest field value 01040_Investment amount = 10 000. The figures are estimates and may change in the future.</p> |
| <p>type</p>       | <p><b>xs:decimal</b></p>  |
| <p>properties</p> | <p>isRef 0<br/> minOcc 0<br/> maxOcc 1<br/> content simple</p>  |
| <p>annotation</p> | <p>documentation<br/> 34020-The Reduction in Yield (RIY) shows what impact the total costs you pay will have on the investment return you might get. The total costs take into account one-off, ongoing and incidental costs. The Reduction in Yield (RIY) shows what impact the total costs you pay will have on the investment return you might get. The total costs take into account one-off, ongoing and incidental costs.</p> <p>The amounts shown here are the cumulative costs of the product itself, for three different holding periods. They include potential early exit penalties. The figures assume you invest field value 01040_Investment amount = 10 000. The figures are estimates and may change in the future.</p>   |



element **CEPTV2\_RHPSType/CEPTRHP/Cost/TotalPeriod3**

|            |  |
|------------|--|
| diagram    |  <p>34030-The Reduction in Yield (RIY) shows what impact the total costs you pay will have on the investment return you might get. The total costs take into account one-off, ongoing and incidental costs. The Reduction in Yield (RIY) shows what impact the total costs you pay will have on the investment return you might get. The total costs take into account one-off, ongoing and incidental costs.</p> <p>The amounts shown here are the cumulative costs of the product itself, for three different holding periods. They include potential early exit penalties. The figures assume you invest field value 01040_Investment amount = 10 000. The figures are estimates and may change in the future.</p> |
| type       | <b>xs:decimal</b>  |
| properties | isRef 0<br>minOcc 0<br>maxOcc 1<br>content simple  |
| annotation | documentation<br>34030-The Reduction in Yield (RIY) shows what impact the total costs you pay will have on the investment return you might get. The total costs take into account one-off, ongoing and incidental costs. The Reduction in Yield (RIY) shows what impact the total costs you pay will have on the investment return you might get. The total costs take into account one-off, ongoing and incidental costs.   |
|            | The amounts shown here are the cumulative costs of the product itself, for three different holding periods. They include potential early exit penalties. The figures assume you invest field value 01040_Investment amount = 10 000. The figures are estimates and may change in the future.   |

element **CEPTV2\_RHPSType/CEPTRHP/Cost/PercentageRIYPeriod1**

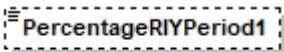
|            |  |
|------------|--|
| diagram    |  <p>34040</p> |
| type       | <b>xs:decimal</b>  |
| properties | isRef 0<br>minOcc 0<br>maxOcc 1<br>content simple  |
| annotation | documentation<br>34040   |

element **CEPTV2\_RHPSType/CEPTRHP/Cost/PercentageRIYPeriod2**

|            |   |
|------------|---|
| diagram    |  |
| type       | <b>xs:decimal</b>   |
| properties | isRef 0<br>minOcc 0<br>maxOcc 1<br>content simple                                 |
| annotation | documentation<br>34050  |

element **CEPTV2\_RHPSType/CEPTRHP/Cost/PercentageRIYPeriod3**

|            |   |
|------------|---|
| diagram    |  |
| type       | <b>xs:decimal</b>   |
| properties | isRef 0<br>minOcc 0<br>maxOcc 1<br>content simple                                 |
| annotation | documentation<br>34060  |

complexType **CEPTV2HistoryType**

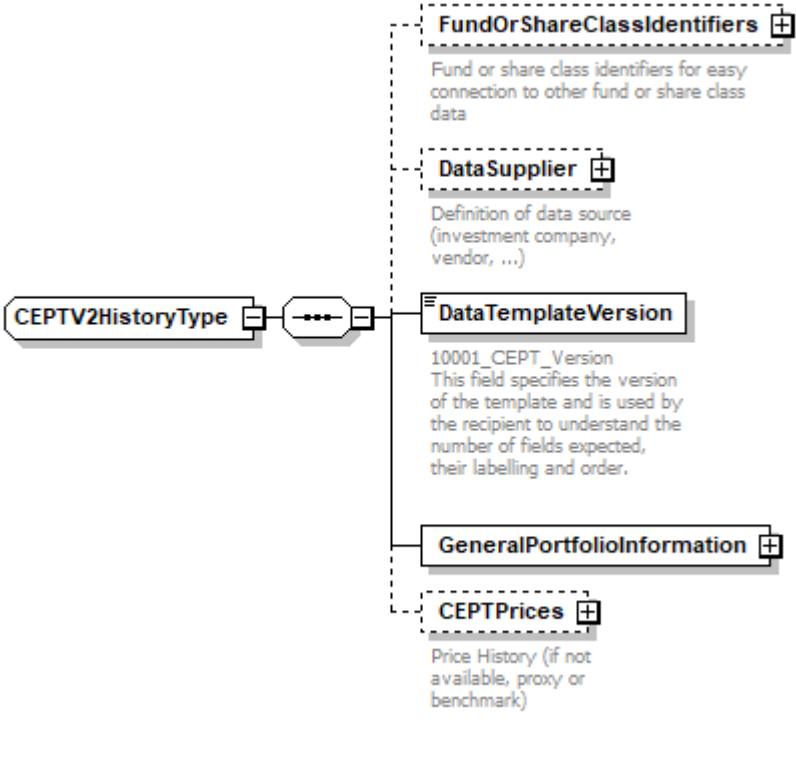
|          |   |
|----------|---|
| diagram  |   |
| children | <a href="#">FundOrShareClassIdentifiers</a> <a href="#">DataSupplier</a> <a href="#">DataTemplateVersion</a> <a href="#">GeneralPortfolioInformation</a> <a href="#">CEPTPrices</a> |

|         |  |
|---------|--|
| used by | element <a href="#">PRIIPSType_V20/CEPTV2History</a> |
|---------|--|

element **CEPTV2HistoryType/FundOrShareClassIdentifiers**

|            |  |
|------------|--|
| diagram    |  |
| type       | <a href="#">FundOrShareClassIdentifiersType</a>  |
| properties | isRef 0<br>minOcc 0<br>maxOcc 1<br>content complex   |
| children   | <a href="#">LEI</a> <a href="#">ISINs</a>  |
| annotation | documentation<br>Fund or share class identifiers for easy connection to other fund or share class data |

element **CEPTV2HistoryType/DataSupplier**

|            |  |
|------------|--|
| diagram    |  |
| type       | <a href="#">DataSupplierType</a>                   |
| properties | isRef 0<br>minOcc 0<br>maxOcc 1<br>content complex |

|            |  |
|------------|--|
| children   | <a href="#">SystemCountry Short Name Type Contact</a>                        |
| annotation | documentation<br>Definition of data source (investment company, vendor, ...) |

element **CEPTV2HistoryType/DataTemplateVersion**

|            |   |
|------------|---|
| diagram    | <p><b>DataTemplateVersion</b></p> <p>10001_CEPT_Version<br/>This field specifies the version of the template and is used by the recipient to understand the number of fields expected, their labelling and order.</p> |
| type       | restriction of <b>xs:string</b>   |
| properties | isRef 0<br>content simple<br>fixed V20  |
| annotation | documentation<br>10001_CEPT_Version<br>This field specifies the version of the template and is used by the recipient to understand the number of fields expected, their labelling and order.                          |

element **CEPTV2HistoryType/GeneralPortfolioInformation**

|            |  |
|------------|--|
| diagram    | <p><b>GeneralPortfolioInformation</b></p> <ul style="list-style-type: none"> <li><b>PortfolioIdentifyingData</b> (10020_Portfolio_Identifying_Data): Identification of the fund or share class or segregated account</li> <li><b>PortfolioID</b> (10030_Type_Of_Identification_Code_For_The_Fund_Share_Or_Portfolio)</li> <li><b>ShareClassCurrency</b> (10040_Portfolio_Or_Share_Class_Currency)</li> <li><b>ReferenceDate</b> (10050_General_Reference_Date)</li> <li><b>PortfolioHistoricalStartDate</b> (10060_Historical_Start_Date): "Start date of the data set"</li> </ul> |
| properties | isRef 0<br>content complex   |

|          |  |
|----------|--|
| children | <a href="#">PortfolioIdentifyingData</a> <a href="#">PortfolioID</a> <a href="#">ShareClassCurrency</a> <a href="#">ReferenceDate</a> <a href="#">PortfolioHistoricalStartDate</a> |
|----------|--|

element **CEPTV2HistoryType/GeneralPortfolioInformation/PortfolioIdentifyingData**

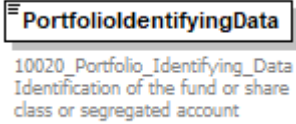
|            |   |
|------------|---|
| diagram    |  <p><b>PortfolioIdentifyingData</b><br/> 10020_Portfolio_Identifying_Data<br/> Identification of the fund or share class or segregated account</p> |
| type       | restriction of <b>xs:string</b>   |
| properties | isRef 0<br>content simple   |
| facets     | Kind Value annotation<br>maxLength 255  |
| annotation | documentation<br>10020_Portfolio_Identifying_Data<br>Identification of the fund or share class or segregated account  |

element **CEPTV2HistoryType/GeneralPortfolioInformation/PortfolioID**

|                   |   |
|-------------------|---|
| <p>diagram</p>    | <p><b>PortfolioID</b></p> <p>10030_Type_Of_Identificati<br/>on_Code_For_The_Fund_Sh<br/>are_Or_Portfolio</p> <p><b>PRIIPS_SecurityCodificationType</b></p> <p><b>CodificationSystem</b></p> <p>Codification system used.<br/>Integer corresponding to the<br/>following closed list:<br/>1 - ISO 6166 for ISIN code<br/>2 - CUSIP (The Committee<br/>on Uniform Securities<br/>Identification Procedures<br/>number assigned by the<br/>CUSIP Service Bureau for<br/>U.S. and Canadian<br/>companies)<br/>3 - SEDOL (Stock Exchange<br/>Daily Official List for the<br/>London Stock Exchange)<br/>4 - WKN (Wertpapier<br/>Kenn-Number, the<br/>alphanumeric German<br/>identification number)<br/>5 - Bloomberg Ticker<br/>(Bloomberg letters code that<br/>identify a company's<br/>securities)<br/>6 - BBGID (The Bloomberg<br/>Global ID)<br/>7 - Reuters RIC (Reuters<br/>instrument code)<br/>8 - FIGI (Financial<br/>Instrument Global Identifier)<br/>9 - Other code by members<br/>of the Association of<br/>National Numbering<br/>Agencies<br/>99 - Code attributed by the<br/>undertaking</p> <p><b>Code</b></p> <p>Value of code in<br/>CodificationSystem</p> |
| <p>type</p>       | <p><a href="#">PRIIPS_SecurityCodificationType</a></p>  |
| <p>properties</p> | <p>isRef 0<br/>content complex</p>  |
| <p>children</p>   | <p><a href="#">CodificationSystem</a> <a href="#">Code</a></p>  |
| <p>annotation</p> | <p>documentation<br/>10030_Type_Of_Identification_Code_For_The_Fund_Share_Or_Portfolio</p>  |

element **CEPTV2HistoryType/GeneralPortfolioInformation/ShareClassCurrency**

|                   |  |
|-------------------|--|
| <p>diagram</p>    | <p><b>ShareClassCurrency</b></p> <p>10040_Portfolio_Or_Share_Cl<br/>ass_Currency</p> |
| <p>type</p>       | <p><a href="#">ISOCurrencyCodeType</a></p>   |
| <p>properties</p> | <p>isRef 0<br/>content simple</p>  |
| <p>facets</p>     | <p>Kind Value annotation</p>   |

|            |  |
|------------|--|
|            | minLength 3<br>maxLength 3<br>pattern [A-Z]{3}           |
| annotation | documentation<br>10040_Portfolio_Or_Share_Class_Currency |

element **CEPTV2HistoryType/GeneralPortfolioInformation/ReferenceDate**

|            |   |
|------------|---|
| diagram    |   |
| type       | <b>xs:date</b>                                |
| properties | isRef 0<br>content simple                     |
| annotation | documentation<br>10050_General_Reference_Date |

element **CEPTV2HistoryType/GeneralPortfolioInformation/PortfolioHistoricalStartDate**

|            |  |
|------------|--|
| diagram    |  |
| type       | <b>xs:date</b>   |
| properties | isRef 0<br>minOcc 0<br>maxOcc 1<br>content simple                                |
| annotation | documentation<br>10060_Historical_Start_Date<br>"Start date of the data set<br>" |

element **CEPTV2HistoryType/CEPTPrices**

|            |  |
|------------|--|
| diagram    |  |
| properties | isRef 0<br>minOcc 0<br>maxOcc 1<br>content complex |
| children   | <a href="#">CEPTPrice</a>                          |

|            |   |
|------------|---|
| annotation | documentation<br>Price History (if not available, proxy or benchmark) |
|------------|---|

element **CEPTV2HistoryType/CEPTPrices/CEPTPrice**

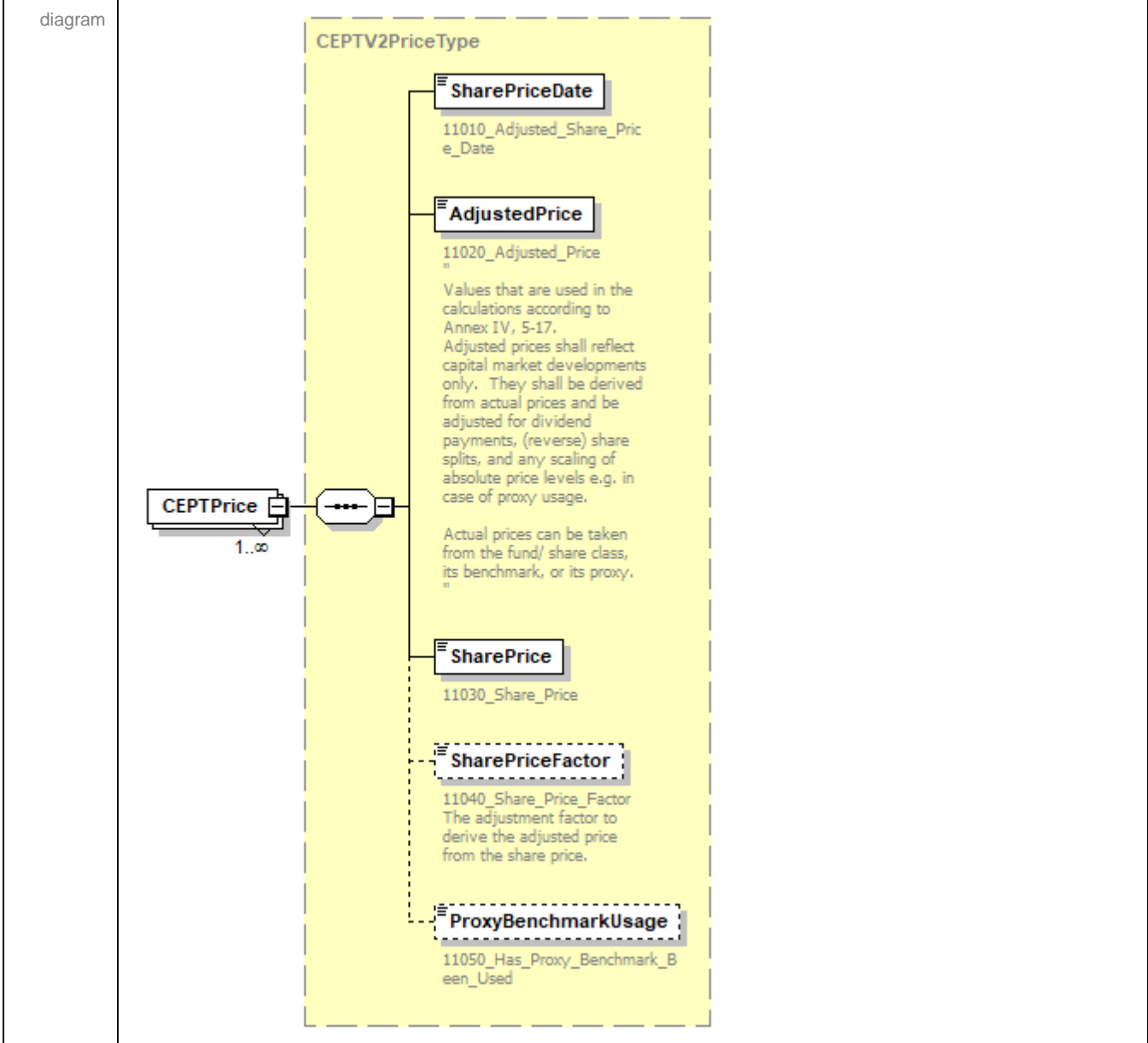

|            |  |
|------------|--|
| type       | <a href="#">CEPTV2PriceType</a>  |
| properties | isRef 0<br>minOcc 1<br>maxOcc unbounded<br>content complex   |
| children   | <a href="#">SharePriceDate</a> <a href="#">AdjustedPrice</a> <a href="#">SharePrice</a> <a href="#">SharePriceFactor</a> <a href="#">ProxyBenchmarkUsage</a> |



complexType **CEPTV2PerformanceType**

diagram

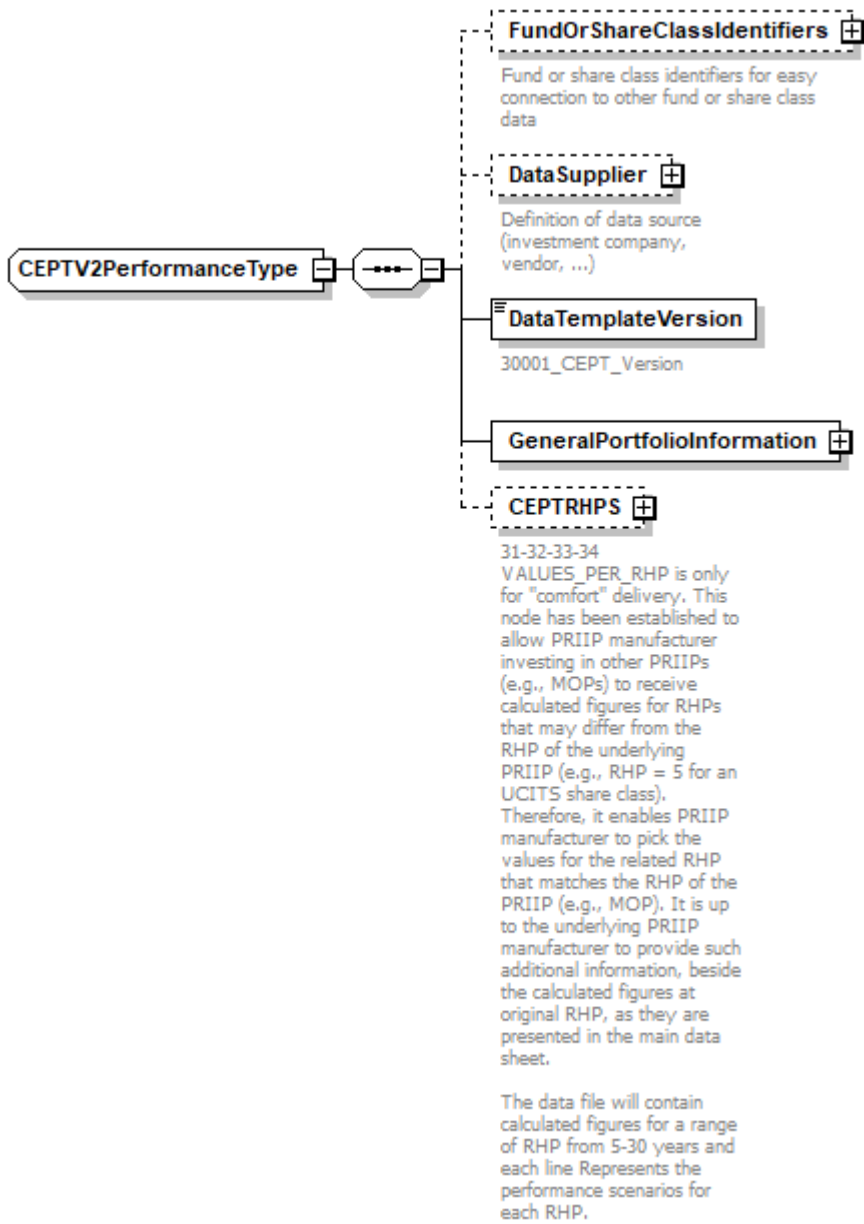

children

[FundOrShareClassIdentifiers](#) [DataSupplier](#) [DataTemplateVersion](#) [GeneralPortfolioInformation](#) [CEPTRHPS](#)

used by

element [PRIIPSType\\_V20/CEPTV2Performance](#)

element **CEPTV2PerformanceType/FundOrShareClassIdentifiers**

|            |  |
|------------|--|
| diagram    |  |
| type       | <a href="#">FundOrShareClassIdentifiersType</a>  |
| properties | isRef 0<br>minOcc 0<br>maxOcc 1<br>content complex   |
| children   | <a href="#">LEI</a> <a href="#">ISINs</a>  |
| annotation | documentation<br>Fund or share class identifiers for easy connection to other fund or share class data |

element **CEPTV2PerformanceType/DataSupplier**

|            |   |
|------------|---|
| diagram    |   |
| type       | <a href="#">DataSupplierType</a>  |
| properties | isRef 0<br>minOcc 0<br>maxOcc 1<br>content complex  |
| children   | <a href="#">SystemCountry</a> <a href="#">Short</a> <a href="#">Name</a> <a href="#">Type</a> <a href="#">Contact</a> |
| annotation | documentation<br>Definition of data source (investment company, vendor, ...)  |

element **CEPTV2PerformanceType/DataTemplateVersion**

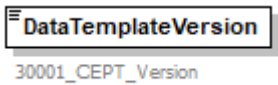
|            |  |
|------------|--|
| diagram    |  <p><b>DataTemplateVersion</b><br/>30001_CEPT_Version</p> |
| type       | restriction of <b>xs:string</b>  |
| properties | isRef 0<br>content simple<br>fixed V20   |
| annotation | documentation<br>30001_CEPT_Version  |

element **CEPTV2PerformanceType/GeneralPortfolioInformation**

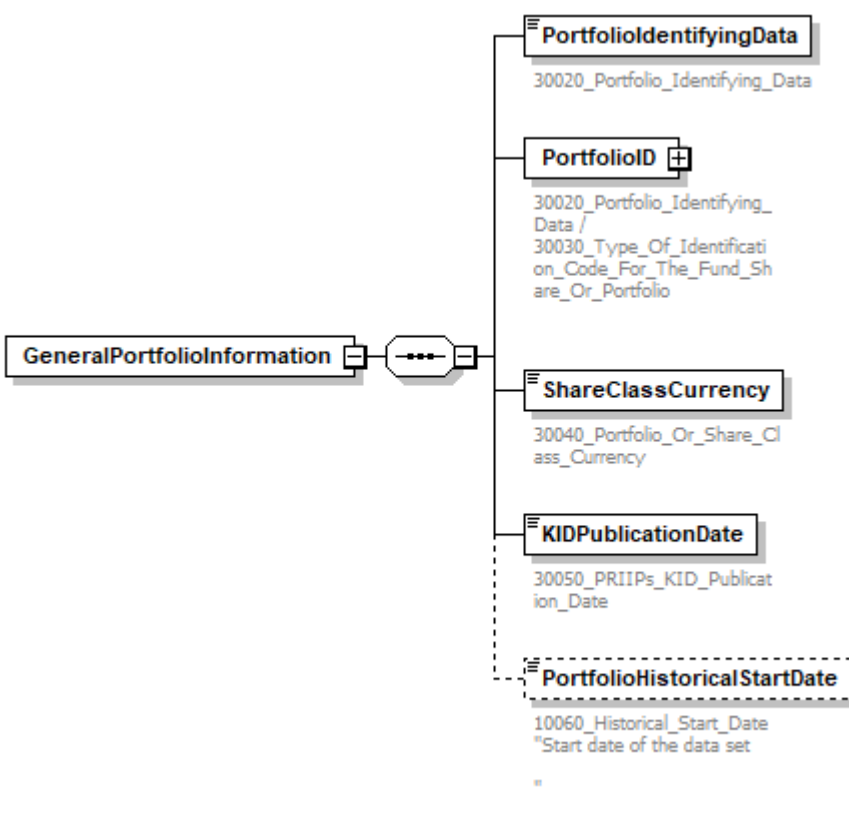
|            |   |
|------------|---|
| diagram    |  <p><b>GeneralPortfolioInformation</b> is composed of:</p> <ul style="list-style-type: none"> <li><b>PortfolioIdentifyingData</b> (30020_Portfolio_Identifying_Data)</li> <li><b>PortfolioID</b> (30020_Portfolio_Identifying_Data / 30030_Type_Of_Identification_Code_For_The_Fund_Share_Or_Portfolio)</li> <li><b>ShareClassCurrency</b> (30040_Portfolio_Or_Share_Class_Currency)</li> <li><b>KIDPublicationDate</b> (30050_PRIIPs_KID_Publication_Date)</li> <li><b>PortfolioHistoricalStartDate</b> (10060_Historical_Start_Date "Start date of the data set")</li> </ul> |
| properties | isRef 0<br>content complex  |
| children   | <a href="#">PortfolioIdentifyingData</a> <a href="#">PortfolioID</a> <a href="#">ShareClassCurrency</a> <a href="#">KIDPublicationDate</a> <a href="#">PortfolioHistoricalStartDate</a>   |

element **CEPTV2PerformanceType/GeneralPortfolioInformation/PortfolioIdentifyingData**

|         |   |
|---------|---|
| diagram |  <p><b>PortfolioIdentifyingData</b><br/>30020_Portfolio_Identifying_Data</p> |
|---------|---|

|            |   |
|------------|---|
| type       | restriction of <b>xs:string</b>                   |
| properties | isRef 0<br>content simple                         |
| facets     | Kind Value annotation<br>maxLength 255            |
| annotation | documentation<br>30020_Portfolio_Identifying_Data |

element **CEPTV2PerformanceType/GeneralPortfolioInformation/PortfolioID**

|            |  |
|------------|--|
| diagram    | <p>The diagram illustrates the structure of the <b>PortfolioID</b> element. It is a restriction of <b>xs:string</b> with a <b>maxLength</b> of 255. The element is associated with the <b>PRIIPS_SecurityCodificationType</b>, which is a complex type containing two elements: <b>CodificationSystem</b> and <b>Code</b>. The <b>CodificationSystem</b> is an integer corresponding to a list of identification systems, and the <b>Code</b> is the value of the code in the <b>CodificationSystem</b>.</p> <p><b>PortfolioID</b><br/>30020_Portfolio_Identifying_Data / 30030_Type_Of_Identification_Code_For_The_Fund_Share_Or_Portfolio</p> <p><b>PRIIPS_SecurityCodificationType</b></p> <p><b>CodificationSystem</b><br/>Codification system used. Integer corresponding to the following closed list:<br/>1 - ISO 6166 for ISIN code<br/>2 - CUSIP (The Committee on Uniform Securities Identification Procedures number assigned by the CUSIP Service Bureau for U.S. and Canadian companies)<br/>3 - SEDOL (Stock Exchange Daily Official List for the London Stock Exchange)<br/>4 - WKN (Wertpapier Kenn-Nummer, the alphanumeric German identification number)<br/>5 - Bloomberg Ticker (Bloomberg letters code that identify a company's securities)<br/>6 - BBGID (The Bloomberg Global ID)<br/>7 - Reuters RIC (Reuters instrument code)<br/>8 - FIGI (Financial Instrument Global Identifier)<br/>9 - Other code by members of the Association of National Numbering Agencies<br/>99 - Code attributed by the undertaking</p> <p><b>Code</b><br/>Value of code in CodificationSystem</p> |
| type       | <a href="#">PRIIPS_SecurityCodificationType</a>  |
| properties | isRef 0<br>content complex   |
| children   | <a href="#">CodificationSystem</a> <a href="#">Code</a>  |
| annotation | documentation<br>30020_Portfolio_Identifying_Data / 30030_Type_Of_Identification_Code_For_The_Fund_Share_Or_Portfolio  |

element **CEPTV2PerformanceType/GeneralPortfolioInformation/ShareClassCurrency**

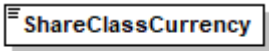
|            |  |
|------------|--|
| diagram    |  <p>30040_Portfolio_Or_Share_Class_Currency</p> |
| type       | <a href="#">ISOCurrencyCodeType</a>  |
| properties | isRef 0<br>content simple  |
| facets     | Kind Value annotation<br>minLength 3<br>maxLength 3<br>pattern [A-Z]{3}  |
| annotation | documentation<br>30040_Portfolio_Or_Share_Class_Currency   |

element **CEPTV2PerformanceType/GeneralPortfolioInformation/KIDPublicationDate**

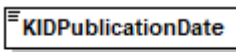
|            |  |
|------------|--|
| diagram    |  <p>30050_PRIIPs_KID_Publication_Date</p> |
| type       | <b>xs:date</b>   |
| properties | isRef 0<br>content simple  |
| annotation | documentation<br>30050_PRIIPs_KID_Publication_Date   |

element **CEPTV2PerformanceType/GeneralPortfolioInformation/PortfolioHistoricalStartDate**

|            |   |
|------------|---|
| diagram    |  <p>10060_Historical_Start_Date<br/>"Start date of the data set"</p> |
| type       | <b>xs:date</b>  |
| properties | isRef 0<br>minOcc 0<br>maxOcc 1<br>content simple   |
| annotation | documentation<br>10060_Historical_Start_Date<br>"Start date of the data set"  |

element **CEPTV2PerformanceType/CEPTRHPS**

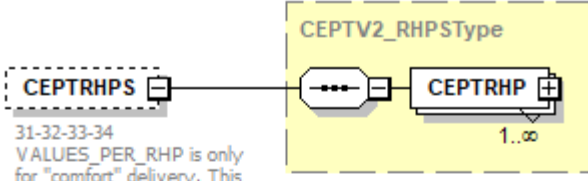
|                   |  |
|-------------------|--|
| <p>diagram</p>    |  <p>31-32-33-34<br/>VALUES_PER_RHP is only for "comfort" delivery. This node has been established to allow PRIIP manufacturer investing in other PRIIPs (e.g., MOPs) to receive calculated figures for RHPs that may differ from the RHP of the underlying PRIIP (e.g., RHP = 5 for an UCITS share class). Therefore, it enables PRIIP manufacturer to pick the values for the related RHP that matches the RHP of the PRIIP (e.g., MOP). It is up to the underlying PRIIP manufacturer to provide such additional information, beside the calculated figures at original RHP, as they are presented in the main data sheet.</p> <p>The data file will contain calculated figures for a range of RHP from 5-30 years and each line Represents the performance scenarios for each RHP.</p> |
| <p>type</p>       | <p><a href="#">CEPTV2_RHPSType</a></p>   |
| <p>properties</p> | <p>isRef 0<br/>minOcc 0<br/>maxOcc 1<br/>content complex</p>   |
| <p>children</p>   | <p><a href="#">CEPTRHP</a></p>   |
| <p>annotation</p> | <p>documentation<br/>31-32-33-34 VALUES_PER_RHP is only for "comfort" delivery. This node has been established to allow PRIIP manufacturer investing in other PRIIPs (e.g., MOPs) to receive calculated figures for RHPs that may differ from the RHP of the underlying PRIIP (e.g., RHP = 5 for an UCITS share class). Therefore, it enables PRIIP manufacturer to pick the values for the related RHP that matches the RHP of the PRIIP (e.g., MOP). It is up to the underlying PRIIP manufacturer to provide such additional information, beside the calculated figures at original RHP, as they are presented in the main data sheet.</p> <p>The data file will contain calculated figures for a range of RHP from 5-30 years and each line Represents the performance scenarios for each RHP.</p>   |

complexType **CEPTV2PriceType**

|                 |   |
|-----------------|---|
| <p>diagram</p>  | <p><b>SharePriceDate</b><br/>11010_Adjusted_Share_Price_Date</p> <p><b>AdjustedPrice</b><br/>11020_Adjusted_Price<br/>Values that are used in the calculations according to Annex IV, 5-17. Adjusted prices shall reflect capital market developments only. They shall be derived from actual prices and be adjusted for dividend payments, (reverse) share splits, and any scaling of absolute price levels e.g. in case of proxy usage.<br/>Actual prices can be taken from the fund/ share class, its benchmark, or its proxy.</p> <p><b>SharePrice</b><br/>11030_Share_Price</p> <p><b>SharePriceFactor</b><br/>11040_Share_Price_Factor<br/>The adjustment factor to derive the adjusted price from the share price.</p> <p><b>ProxyBenchmarkUsage</b><br/>11050_Has_Proxy_Benchmark_Been_Used</p> |
| <p>children</p> | <p><a href="#">SharePriceDate</a> <a href="#">AdjustedPrice</a> <a href="#">SharePrice</a> <a href="#">SharePriceFactor</a> <a href="#">ProxyBenchmarkUsage</a></p>   |
| <p>used by</p>  | <p>element <a href="#">CEPTV2HistoryType/CEPTPrices/CEPTPrice</a></p>   |

element **CEPTV2PriceType/SharePriceDate**

|                   |  |
|-------------------|--|
| <p>diagram</p>    | <p><b>SharePriceDate</b><br/>11010_Adjusted_Share_Price_Date</p> |
| <p>type</p>       | <p><b>xs:date</b></p>  |
| <p>properties</p> | <p>isRef 0<br/>content simple</p>                                |
| <p>annotation</p> | <p>documentation<br/>11010_Adjusted_Share_Price_Date</p>         |

element **CEPTV2PriceType/AdjustedPrice**

|            |   |
|------------|---|
| diagram    |  <p>11020_Adjusted_Price</p> <p>Values that are used in the calculations according to Annex IV, 5-17. Adjusted prices shall reflect capital market developments only. They shall be derived from actual prices and be adjusted for dividend payments, (reverse) share splits, and any scaling of absolute price levels e.g. in case of proxy usage.</p> <p>Actual prices can be taken from the fund/ share class, its benchmark, or its proxy.</p> |
| type       | restriction of <b>xs:decimal</b>  |
| properties | isRef 0<br>content simple   |
| facets     | Kind Value annotation<br>minInclusive 0   |
| annotation | documentation<br>11020_Adjusted_Price<br>"<br>Values that are used in the calculations according to Annex IV, 5-17. Adjusted prices shall reflect capital market developments only. They shall be derived from actual prices and be adjusted for dividend payments, (reverse) share splits, and any scaling of absolute price levels e.g. in case of proxy usage.<br><br>Actual prices can be taken from the fund/ share class, its benchmark, or its proxy.<br>"   |

element **CEPTV2PriceType/SharePrice**

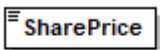
|            |  |
|------------|--|
| diagram    |  <p>11030_Share_Price</p> |
| type       | restriction of <b>xs:decimal</b>   |
| properties | isRef 0<br>content simple  |
| facets     | Kind Value annotation<br>minInclusive 0  |
| annotation | documentation<br>11030_Share_Price   |

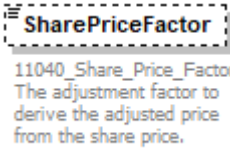

element **CEPTV2PriceType/SharePriceFactor**

|            |  |
|------------|--|
| diagram    |  <p><b>SharePriceFactor</b><br/>11040_Share_Price_Factor<br/>The adjustment factor to derive the adjusted price from the share price.</p> |
| type       | <b>xs:decimal</b>  |
| properties | isRef 0<br>minOcc 0<br>maxOcc 1<br>content simple  |
| annotation | documentation<br>11040_Share_Price_Factor<br>The adjustment factor to derive the adjusted price from the share price.  |

element **CEPTV2PriceType/ProxyBenchmarkUsage**

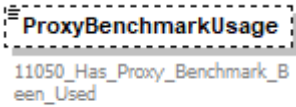
|            |   |
|------------|---|
| diagram    |  <p><b>ProxyBenchmarkUsage</b><br/>11050_Has_Proxy_Benchmark_Been_Used</p> |
| type       | <a href="#">YesNoType</a>   |
| properties | isRef 0<br>minOcc 0<br>maxOcc 1<br>content simple   |
| annotation | documentation<br>11050_Has_Proxy_Benchmark_Been_Used  |

complexType **PRIIPS\_AverageReturnType**

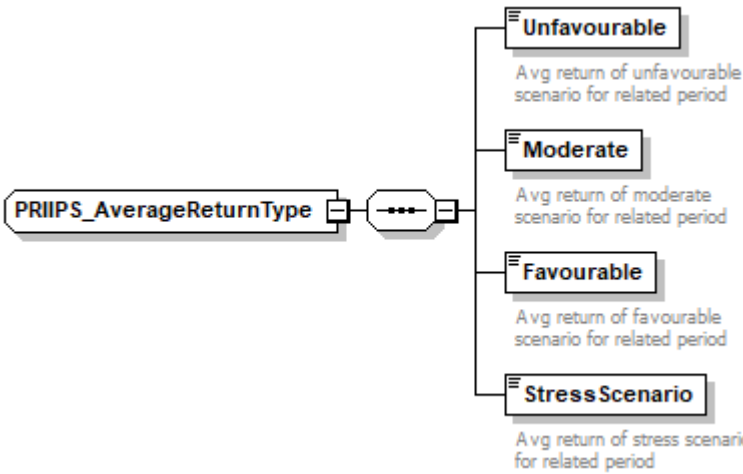
|          |   |
|----------|---|
| diagram  |  <p>The diagram shows a complex type <b>PRIIPS_AverageReturnType</b> containing four child elements: <b>Unfavourable</b>, <b>Moderate</b>, <b>Favourable</b>, and <b>Stress Scenario</b>. Each element is represented by a box with a description: 'Avg return of unfavourable scenario for related period', 'Avg return of moderate scenario for related period', 'Avg return of favourable scenario for related period', and 'Avg return of stress scenario for related period' respectively.</p> |
| children | <a href="#">Unfavourable</a> <a href="#">Moderate</a> <a href="#">Favourable</a> <a href="#">StressScenario</a>   |
| used by  | elements <a href="#">CEPT_RHPSType/CEPT_RHP/PerformanceScenario/AverageReturnPeriod1</a><br><a href="#">CEPTV2_RHPSType/CEPTRHP/PerformanceScenario/AverageReturnPeriod1</a><br><a href="#">CEPT_RHPSType/CEPT_RHP/PerformanceScenario/AverageReturnPeriod2</a>   |

[CEPTV2\\_RHPSType/CEPTRHP/PerformaceScenario/AverageReturnPeriod2](#)  
[CEPT\\_RHPSType/CEPT\\_RHP/PerformaceScenario/AverageReturnPeriod3](#)  
[CEPTV2\\_RHPSType/CEPTRHP/PerformaceScenario/AverageReturnPeriod3](#)

element **PRIIPS\_AverageReturnType/Unfavourable**

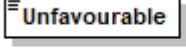
|            |   |
|------------|---|
| diagram    |  <p>Avg return of unfavourable scenario for related period</p> |
| type       | <b>xs:decimal</b>   |
| properties | isRef 0<br>content simple   |
| annotation | documentation<br>Avg return of unfavourable scenario for related period   |

element **PRIIPS\_AverageReturnType/Moderate**

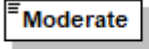
|            |   |
|------------|---|
| diagram    |  <p>Avg return of moderate scenario for related period</p> |
| type       | <b>xs:decimal</b>   |
| properties | isRef 0<br>content simple   |
| annotation | documentation<br>Avg return of moderate scenario for related period   |

element **PRIIPS\_AverageReturnType/Favourable**

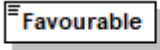
|            |   |
|------------|---|
| diagram    |  <p>Avg return of favourable scenario for related period</p> |
| type       | <b>xs:decimal</b>   |
| properties | isRef 0<br>content simple   |
| annotation | documentation<br>Avg return of favourable scenario for related period   |

element **PRIIPS\_AverageReturnType/StressScenario**

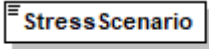
|            |   |
|------------|---|
| diagram    |  <p>Avg return of stress scenario for related period</p> |
| type       | <b>xs:decimal</b>   |
| properties | isRef 0<br>content simple   |
| annotation | documentation<br>Avg return of stress scenario for related period   |

complexType **PRIIPS\_InvestmentAmountType**

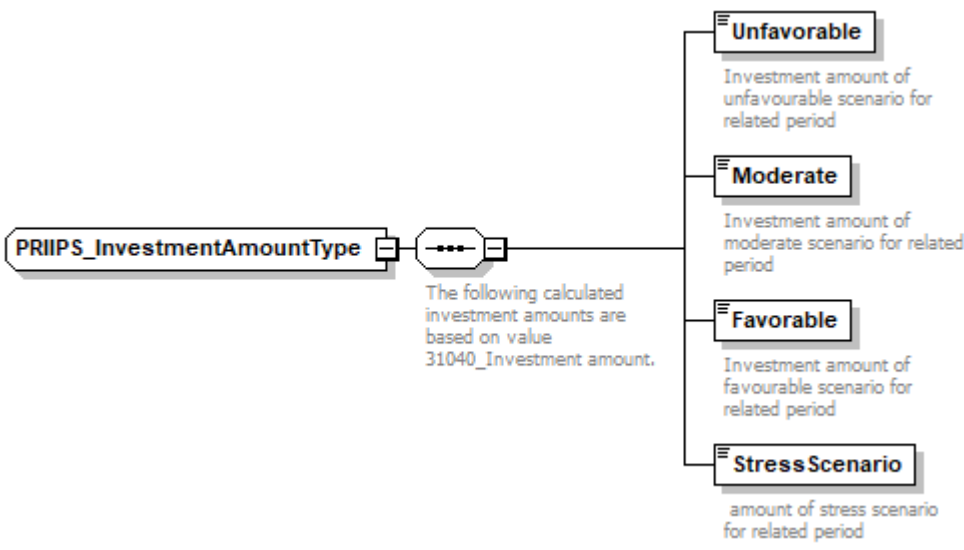
|          |  |
|----------|--|
| diagram  |    |
| children | <a href="#">Unfavorable</a> <a href="#">Moderate</a> <a href="#">Favorable</a> <a href="#">StressScenario</a>  |
| used by  | elements <a href="#">CEPT_RHPSType/CEPT_RHP/PerformaceScenario/InvestmentAmountPeriod1</a><br><a href="#">CEPTV2_RHPSType/CEPTRHP/PerformaceScenario/InvestmentAmountPeriod1</a><br><a href="#">CEPT_RHPSType/CEPT_RHP/PerformaceScenario/InvestmentAmountPeriod2</a><br><a href="#">CEPTV2_RHPSType/CEPTRHP/PerformaceScenario/InvestmentAmountPeriod2</a><br><a href="#">CEPT_RHPSType/CEPT_RHP/PerformaceScenario/InvestmentAmountPeriod3</a><br><a href="#">CEPTV2_RHPSType/CEPTRHP/PerformaceScenario/InvestmentAmountPeriod3</a> |

element **PRIIPS\_InvestmentAmountType/Unfavorable**

|            |   |
|------------|---|
| diagram    |  |
| type       | <b>xs:positiveInteger</b>   |
| properties | isRef 0<br>content simple   |
| annotation | documentation<br>Investment amount of unfavourable scenario for related period      |

element **PRIIPS\_InvestmentAmountType/Moderate**

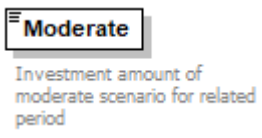
|            |   |
|------------|---|
| diagram    |  |
| type       | <b>xs:positiveInteger</b>   |
| properties | isRef 0<br>content simple   |
| annotation | documentation<br>Investment amount of moderate scenario for related period          |

element **PRIIPS\_InvestmentAmountType/Favorable**

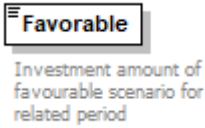
|            |   |
|------------|---|
| diagram    |  |
| type       | <b>xs:positiveInteger</b>   |
| properties | isRef 0<br>content simple   |
| annotation | documentation<br>Investment amount of favourable scenario for related period      |

element **PRIIPS\_InvestmentAmountType/StressScenario**

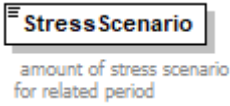
|            |   |
|------------|---|
| diagram    |  |
| type       | <b>xs:positiveInteger</b>   |
| properties | isRef 0<br>content simple   |
| annotation | documentation<br>amount of stress scenario for related period                     |

complexType **PRIIPS\_NarrativesType**

diagram

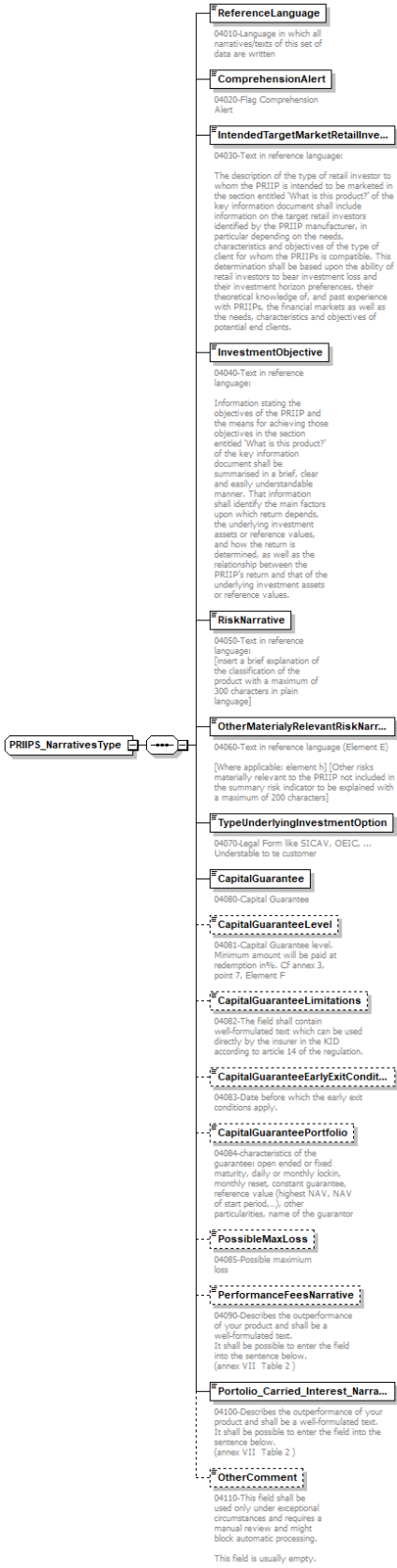

|          |  |
|----------|--|
| children | <a href="#">ReferenceLanguage</a> <a href="#">ComprehensionAlert</a> <a href="#">IntendedTargetMarketRetailInvestor</a> <a href="#">InvestmentObjective</a> <a href="#">RiskNarrative</a> <a href="#">OtherMaterial</a> <a href="#">RelevantRiskNarrative</a> <a href="#">TypeUnderlyingInvestmentOption</a> <a href="#">CapitalGuarantee</a> <a href="#">CapitalGuaranteeLevel</a> <a href="#">CapitalGuaranteeLimitations</a> <a href="#">CapitalGuaranteeEarlyExitConditions</a> <a href="#">CapitalGuaranteePortfolio</a> <a href="#">PossibleMaxLoss</a> <a href="#">PerformanceFeesNarrative</a> <a href="#">Portfolio</a> <a href="#">Carried</a> <a href="#">Interest</a> <a href="#">Narrative</a> <a href="#">OtherComment</a> |
| used by  | elements <a href="#">PRIIPS_ReportType/CEPT_Narratives</a> <a href="#">PRIIPS_ReportType/EPT_BaseData/Narratives</a>   |

#### element [PRIIPS\\_NarrativesType/ReferenceLanguage](#)

|            |   |
|------------|---|
| diagram    |  <p>04010-Language in which all narratives/texts of this set of data are written</p> |
| type       | <a href="#">ISOLanguageCodeType</a>   |
| properties | isRef 0<br>content simple   |
| facets     | Kind Value annotation<br>minLength 2<br>maxLength 2   |
| annotation | documentation<br>04010-Language in which all narratives/texts of this set of data are written   |

#### element [PRIIPS\\_NarrativesType/ComprehensionAlert](#)

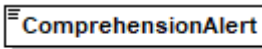
|            |  |
|------------|--|
| diagram    |  <p>04020-Flag Comprehension Alert</p> |
| type       | <a href="#">YesNoType</a>  |
| properties | isRef 0<br>content simple  |
| annotation | documentation<br>04020-Flag Comprehension Alert  |

#### element [PRIIPS\\_NarrativesType/IntendedTargetMarketRetailInvestor](#)

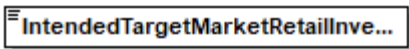
|         |   |
|---------|---|
| diagram |  <p>04030-Text in reference language:</p> <p>The description of the type of retail investor to whom the PRIIP is intended to be marketed in the section entitled "What is this product?" of the key information document shall include information on the target retail investors identified by the PRIIP manufacturer, in particular depending on the needs, characteristics and objectives of the type of client for whom the PRIIPs is compatible. This determination shall be based upon the ability of retail investors to bear investment loss and their investment horizon preferences, their theoretical knowledge of, and past experience with PRIIPs, the financial markets as well as the needs, characteristics and objectives of potential end clients.</p> |
| type    | restriction of <b>xs:string</b>   |

|            |   |
|------------|---|
| properties | isRef 0<br>content simple   |
| facets     | Kind Value annotation<br>maxLength 750  |
| annotation | documentation<br>04030-Text in reference language:<br><br>The description of the type of retail investor to whom the PRIIP is intended to be marketed in the section entitled 'What is this product?' of the key information document shall include information on the target retail investors identified by the PRIIP manufacturer, in particular depending on the needs, characteristics and objectives of the type of client for whom the PRIIPs is compatible. This determination shall be based upon the ability of retail investors to bear investment loss and their investment horizon preferences, their theoretical knowledge of, and past experience with PRIIPs, the financial markets as well as the needs, characteristics and objectives of potential end clients. |

element **PRIIPS\_NarrativesType/InvestmentObjective**

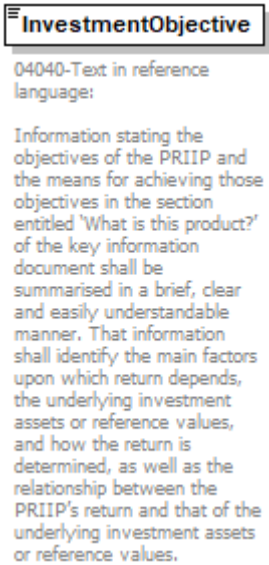
|            |  |
|------------|--|
| diagram    |  <p><b>InvestmentObjective</b></p> <p>04040-Text in reference language:</p> <p>Information stating the objectives of the PRIIP and the means for achieving those objectives in the section entitled 'What is this product?' of the key information document shall be summarised in a brief, clear and easily understandable manner. That information shall identify the main factors upon which return depends, the underlying investment assets or reference values, and how the return is determined, as well as the relationship between the PRIIP's return and that of the underlying investment assets or reference values.</p> |
| type       | restriction of <b>xs:string</b>  |
| properties | isRef 0<br>content simple  |
| facets     | Kind Value annotation<br>maxLength 2500  |
| annotation | documentation<br>04040-Text in reference language:<br><br>Information stating the objectives of the PRIIP and the means for achieving those objectives in the section entitled 'What is this product?' of the key information document shall be summarised in a brief, clear and easily understandable manner. That information shall identify the main factors upon which return depends, the underlying investment assets or reference values, and how the return is determined, as well as the relationship between the PRIIP's return and that of the underlying investment assets or reference values.  |



element **PRIIPS\_NarrativesType/RiskNarrative**

|            |   |
|------------|---|
| diagram    |  <p>04050-Text in reference language:<br/>[insert a brief explanation of the classification of the product with a maximum of 300 characters in plain language]</p> |
| type       | restriction of <b>xs:string</b>   |
| properties | isRef 0<br>content simple   |
| facets     | Kind Value annotation<br>maxLength 300  |
| annotation | documentation<br>04050-Text in reference language:<br>[insert a brief explanation of the classification of the product with a maximum of 300 characters in plain language]  |

element **PRIIPS\_NarrativesType/OtherMaterialyRelevantRiskNarrative**

|            |   |
|------------|---|
| diagram    |  <p>04060-Text in reference language (Element E)<br/><br/>[Where applicable: element h] [Other risks materially relevant to the PRIIP not included in the summary risk indicator to be explained with a maximum of 200 characters]</p> |
| type       | restriction of <b>xs:string</b>   |
| properties | isRef 0<br>content simple   |
| facets     | Kind Value annotation<br>maxLength 200  |
| annotation | documentation<br>04060-Text in reference language (Element E)<br><br>[Where applicable: element h] [Other risks materially relevant to the PRIIP not included in the summary risk indicator to be explained with a maximum of 200 characters]   |

element **PRIIPS\_NarrativesType/TypeUnderlyingInvestmentOption**

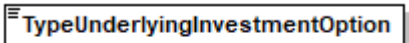
|            |  |
|------------|--|
| diagram    |  <p>04070-Legal Form like SICAV, OEIC, ...<br/>Understable to te customer</p> |
| type       | restriction of <b>xs:string</b>  |
| properties | isRef 0<br>content simple  |
| facets     | Kind Value annotation<br>maxLength 300   |
| annotation | documentation<br>04070-Legal Form like SICAV, OEIC, ... Understable to te customer   |

element **PRIIPS\_NarrativesType/CapitalGuarantee**

|            |  |
|------------|--|
| diagram    |  <p>04080-Capital Guarantee</p> |
| type       | <a href="#">YesNoType</a>  |
| properties | isRef 0<br>content simple  |
| annotation | documentation<br>04080-Capital Guarantee   |

element **PRIIPS\_NarrativesType/CapitalGuaranteeLevel**

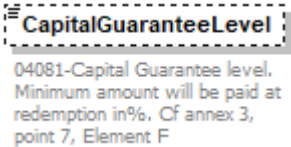
|            |   |
|------------|---|
| diagram    |  <p>04081-Capital Guarantee level.<br/>Minimum amount will be paid at redemption in%. Cf annex 3, point 7, Element F</p> |
| type       | <b>xs:decimal</b>   |
| properties | isRef 0<br>minOcc 0<br>maxOcc 1<br>content simple   |
| annotation | documentation<br>04081-Capital Guarantee level. Minimum amount will be paid at redemption in%. Cf annex 3, point 7, Element F   |

element **PRIIPS\_NarrativesType/CapitalGuaranteeLimitations**

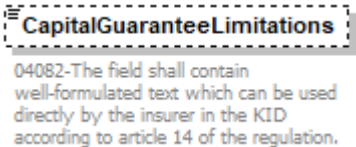
|            |   |
|------------|---|
| diagram    |  <p>04082-The field shall contain well-formulated text which can be used directly by the insurer in the KID according to article 14 of the regulation.</p> |
| type       | restriction of <b>xs:string</b>   |
| properties | isRef 0<br>minOcc 0<br>maxOcc 1<br>content simple   |
| facets     | Kind Value annotation<br>maxLength 300  |
| annotation | documentation<br>04082-The field shall contain well-formulated text which can be used directly by the insurer in the KID according to article 14 of the regulation.   |

element **PRIIPS\_NarrativesType/CapitalGuaranteeEarlyExitConditions**

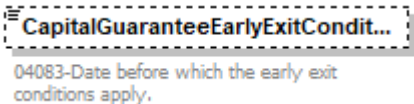
|            |   |
|------------|---|
| diagram    |  <p>04083-Date before which the early exit conditions apply.</p> |
| type       | <b>xs:date</b>  |
| properties | isRef 0<br>minOcc 0<br>maxOcc 1   |

|            |   |
|------------|---|
|            | content simple  |
| annotation | documentation<br>04083-Date before which the early exit conditions apply. |

element **PRIIPS\_NarrativesType/CapitalGuaranteePortfolio**

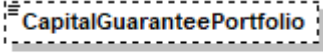
|            |   |
|------------|---|
| diagram    |  <p>04084-characteristics of the guarantee: open ended or fixed maturity, daily or monthly lockin, monthly reset, constant guarantee, reference value (highest NAV, NAV of start period,...), other particularities, name of the guarantor</p> |
| type       | restriction of <b>xs:string</b>   |
| properties | isRef 0<br>minOcc 0<br>maxOcc 1<br>content simple   |
| facets     | Kind Value annotation<br>maxLength 2500   |
| annotation | documentation<br>04084-characteristics of the guarantee: open ended or fixed maturity, daily or monthly lockin, monthly reset, constant guarantee, reference value (highest NAV, NAV of start period,...), other particularities, name of the guarantor   |

element **PRIIPS\_NarrativesType/PossibleMaxLoss**

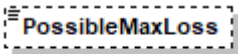
|            |  |
|------------|--|
| diagram    |  <p>04085-Possible maximum loss</p> |
| type       | restriction of <b>xs:decimal</b>   |
| properties | isRef 0<br>minOcc 0<br>maxOcc 1<br>content simple  |
| annotation | documentation<br>04085-Possible maximum loss   |

element **PRIIPS\_NarrativesType/PerformanceFeesNarrative**

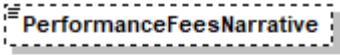
|            |  |
|------------|--|
| diagram    |  <p>04090-Describes the outperformance of your product and shall be a well-formulated text. It shall be possible to enter the field into the sentence below. (annex VII Table 2 )</p> |
| type       | restriction of <b>xs:string</b>  |
| properties | isRef 0<br>minOcc 0<br>maxOcc 1<br>content simple  |
| facets     | Kind Value annotation<br>maxLength 300   |

|            |  |
|------------|--|
| annotation | documentation<br>04090-Describes the outperformance of your product and shall be a well-formulated text.<br>It shall be possible to enter the field into the sentence below.<br>(annex VII Table 2 ) |
|------------|--|

element **PRIIPS\_NarrativesType/Portolio\_Carried\_Interest\_Narrative**

|            |  |
|------------|--|
| diagram    |  <p>04100-Describes the outperformance of your product and shall be a well-formulated text.<br/>It shall be possible to enter the field into the sentence below.<br/>(annex VII Table 2 )</p> |
| type       | restriction of <b>xs:string</b>  |
| properties | isRef 0<br>content simple  |
| facets     | Kind Value annotation<br>maxLength 300   |
| annotation | documentation<br>04100-Describes the outperformance of your product and shall be a well-formulated text.<br>It shall be possible to enter the field into the sentence below.<br>(annex VII Table 2 )   |

element **PRIIPS\_NarrativesType/OtherComment**

|            |  |
|------------|--|
| diagram    |  <p>04110-This field shall be used only under exceptional circumstances and requires a manual review and might block automatic processing.<br/><br/>This field is usually empty.</p> |
| type       | restriction of <b>xs:string</b>  |
| properties | isRef 0<br>minOcc 0<br>maxOcc 1<br>content simple  |
| facets     | Kind Value annotation<br>maxLength 2000  |
| annotation | documentation<br>04110-This field shall be used only under exceptional circumstances and requires a manual review and might block automatic processing.<br><br>This field is usually empty.  |

complexType **PRIIPS\_ReportType**

diagram

**FundOrShareClassIdentifiers**

Fund or share class identifiers for easy connection to other fund or share class data

**DataSupplier**

Definition of data source (investment company, vendor, ...)

**DataTemplateVersion**

09999 - Data Exchange Template Published Version. The version corresponding to the current XML schema is "V1.1"

**GeneralPortfolioInformation**

EPT 00 / CEPT PRICES 10 / CEPT RHP 30

**EPT\_BaseData**

01-02-03-04 This sheet aims to provide minimum data points for an investment options (wrapper [e.g., in UK MOPs invest in wrappers, which are investing into Funds], funds resp. share class data) of Multi Option PRIIPs (MOPs) and discretionary portfolios of an insurance product.

**EPT\_SpecificUCITS**

05-Specific UCITS data for insurers opting for Art 14.2 for MOP

**EPT\_SpecificStructuredProducts**

07-Specific data for Structured Products - RIY Costs  
Note: Cost fields in RIY terms as requested by the PRIIPs KID. This section is optional and is required only if it is impossible to calculate RIY from the previous section. This happens for products with periodical coupons and/or early callability features. In this case, the Performance Scenario fields together with the Cost fields are not adequate to calculate the IRR of the gross and net scenarios.

PRIIPs\_ReportType

**CEPT\_Prices**

11-Price History, PRICES is only for "comfort" delivery. This node aims to provide raw price data of the investment options, which can be used by the MOP manufacturer to perform calculations in the context of the MOP KID preparation

**CEPT\_Narratives**

04-Narratives translated per reference language provided. NARRATIVES is only for "comfort" delivery. This node has been established to allow investment option manufacturer to provide narratives in languages that may differ from the original base language. It aims to enable MOP manufacturers to align the narrative languages required for the MOP KID.

**CEPT\_RHPs**

31-32-33-34 VALUES\_PER\_RHP is only for "comfort" delivery. This node has been established to allow PRIIP manufacturer investing in other PRIIPs (e.g., MOPs) to receive calculated figures for RHPs that may differ from the RHP of the underlying PRIIP (e.g., RHP = 5 for an UCITS share class). Therefore, it enables PRIIP manufacturer to pick the values for the related RHP that matches the RHP of the PRIIP (e.g., MOP). It is up to the underlying PRIIP manufacturer to provide such additional information, beside the calculated figures at original RHP, as they are presented in the main data sheet.

The data file will contain calculated figures for a range of RHP from 5-30 years and each line Represents the performance scenarios for each RHP.

**CountrySpecificData**

|          |  |
|----------|--|
| children | <a href="#">FundOrShareClassIdentifiers</a> <a href="#">DataSupplier</a> <a href="#">DataTemplateVersion</a> <a href="#">GeneralPortfolioInformation</a> <a href="#">EPT</a> <a href="#">BaseData</a> <a href="#">EPT</a> <a href="#">SpecificUCITS</a> <a href="#">EPT</a> <a href="#">SpecificStructuredProducts</a> <a href="#">CEPT</a> <a href="#">Prices</a> <a href="#">CEPT</a> <a href="#">Narratives</a> <a href="#">CEPT</a> <a href="#">RHPS</a> <a href="#">CountrySpecificData</a> |
| used by  | element <a href="#">PRIIPSType/PRIIPS</a> <a href="#">Report</a>   |

element **PRIIPS\_ReportType/FundOrShareClassIdentifiers**

|            |  |
|------------|--|
| diagram    |  |
| type       | <a href="#">FundOrShareClassIdentifiersType</a>  |
| properties | isRef 0<br>minOcc 0<br>maxOcc 1<br>content complex   |
| children   | <a href="#">LEI</a> <a href="#">ISINs</a>  |
| annotation | documentation<br>Fund or share class identifiers for easy connection to other fund or share class data |

element **PRIIPS\_ReportType/DataSupplier**

|         |                                  |
|---------|----------------------------------|
| diagram |                                  |
| type    | <a href="#">DataSupplierType</a> |

|            |   |
|------------|---|
| properties | isRef 0<br>minOcc 0<br>maxOcc 1<br>content complex  |
| children   | <a href="#">SystemCountry</a> <a href="#">Short Name</a> <a href="#">Type</a> <a href="#">Contact</a> |
| annotation | documentation<br>Definition of data source (investment company, vendor, ...)                          |

element **PRIIPS\_ReportType/DataTemplateVersion**

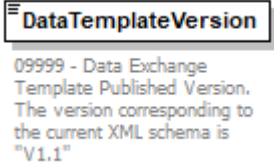
|            |   |
|------------|---|
| diagram    |    |
| type       | restriction of <b>xs:string</b>   |
| properties | isRef 0<br>content simple<br>fixed V1.1   |
| annotation | documentation<br>09999 - Data Exchange Template Published Version.<br>The version corresponding to the current XML schema is "V1.1" |



element **PRIIPS\_ReportType/GeneralPortfolioInformation**

diagram

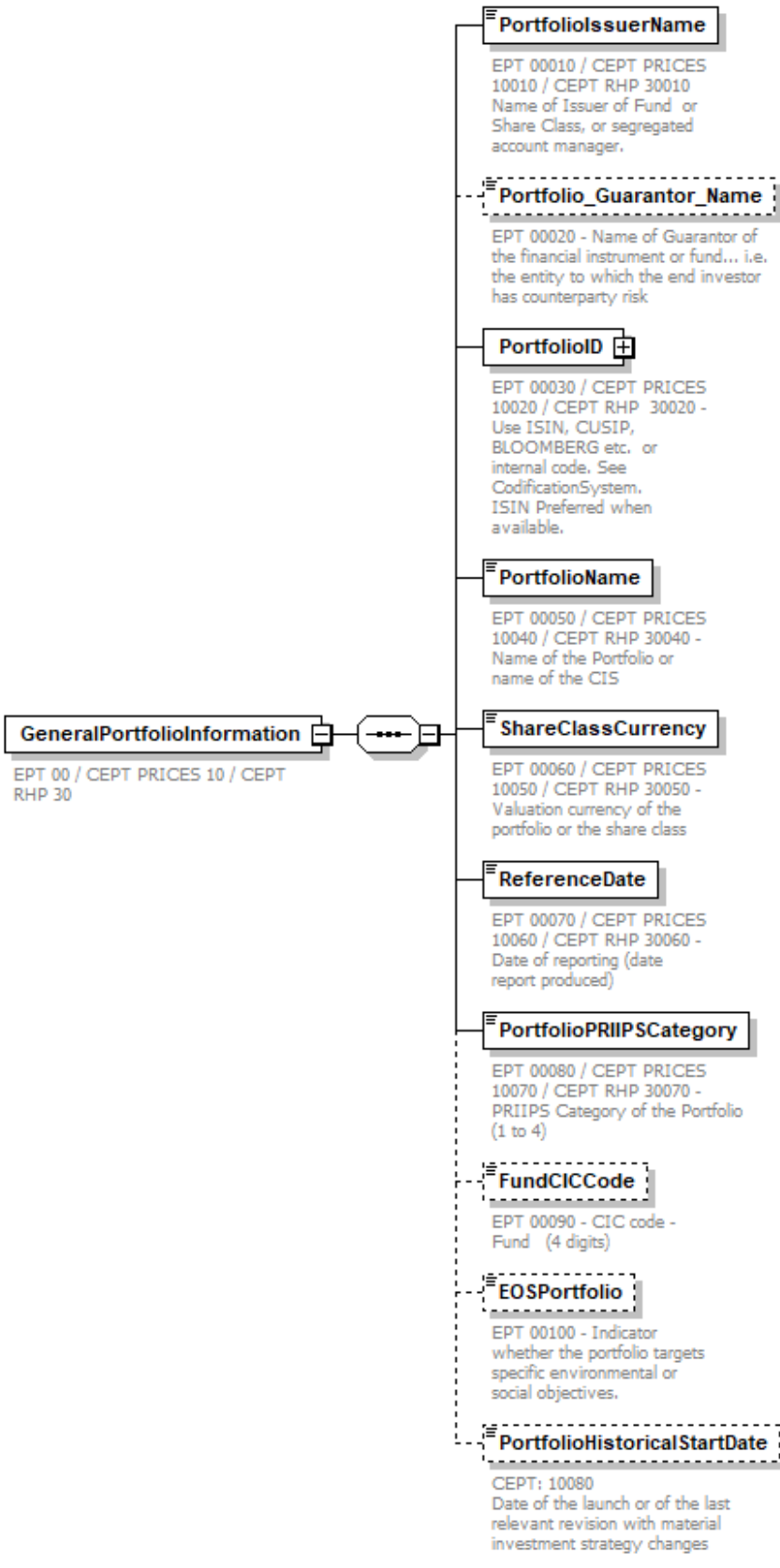

|            |  |
|------------|--|
| properties | isRef 0<br>content complex   |
| children   | <a href="#">PortfolioIssuerName</a> <a href="#">Portfolio_Guarantor_Name</a> <a href="#">PortfolioID</a> <a href="#">PortfolioName</a> <a href="#">ShareClassCurrency</a> <a href="#">ReferenceDate</a><br><a href="#">PortfolioPRIIPSCategory</a> <a href="#">FundCICCode</a> <a href="#">EOSPortfolio</a> <a href="#">PortfolioHistoricalStartDate</a> |
| annotation | documentation<br>EPT 00 / CEPT PRICES 10 / CEPT RHP 30   |

element **PRIIPS\_ReportType/GeneralPortfolioInformation/PortfolioIssuerName**

|            |   |
|------------|---|
| diagram    |  <p>EPT 00010 / CEPT PRICES<br/>10010 / CEPT RHP 30010<br/>Name of Issuer of Fund or<br/>Share Class, or segregated<br/>account manager.</p> |
| type       | restriction of <b>xs:string</b>   |
| properties | isRef 0<br>content simple   |
| facets     | Kind Value annotation<br>maxLength 255  |
| annotation | documentation<br>EPT 00010 / CEPT PRICES 10010 / CEPT RHP 30010<br>Name of Issuer of Fund or Share Class, or segregated account manager.  |

element **PRIIPS\_ReportType/GeneralPortfolioInformation/Portfolio\_Guarantor\_Name**

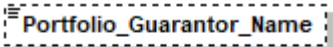
|            |   |
|------------|---|
| diagram    |  <p>EPT 00020 - Name of Guarantor of<br/>the financial instrument or fund... i.e.<br/>the entity to which the end investor<br/>has counterparty risk</p> |
| type       | restriction of <b>xs:string</b>   |
| properties | isRef 0<br>minOcc 0<br>maxOcc 1<br>content simple   |
| facets     | Kind Value annotation<br>maxLength 255  |
| annotation | documentation<br>EPT 00020 - Name of Guarantor of the financial instrument or fund... i.e. the entity to which the end investor has counterparty risk   |

element **PRIIPS\_ReportType/GeneralPortfolioInformation/PortfolioID**

|                   |   |
|-------------------|---|
| <p>diagram</p>    | <p><b>PortfolioID</b></p> <p>EPT 00030 / CEPT PRICES 10020 / CEPT RHP 30020 - Use ISIN, CUSIP, BLOOMBERG etc. or internal code. See CodificationSystem. ISIN Preferred when available.</p> <p><b>PRIIPS_SecurityCodificationType</b></p> <p><b>CodificationSystem</b></p> <p>Codification system used. Integer corresponding to the following closed list:<br/>     1 - ISO 6166 for ISIN code<br/>     2 - CUSIP (The Committee on Uniform Securities Identification Procedures number assigned by the CUSIP Service Bureau for U.S. and Canadian companies)<br/>     3 - SEDOL (Stock Exchange Daily Official List for the London Stock Exchange)<br/>     4 - WKN (Wertpapier Kenn-Nummer, the alphanumeric German identification number)<br/>     5 - Bloomberg Ticker (Bloomberg letters code that identify a company's securities)<br/>     6 - BBGID (The Bloomberg Global ID)<br/>     7 - Reuters RIC (Reuters instrument code)<br/>     8 - FIGI (Financial Instrument Global Identifier)<br/>     9 - Other code by members of the Association of National Numbering Agencies<br/>     99 - Code attributed by the undertaking</p> <p><b>Code</b></p> <p>Value of code in CodificationSystem</p> |
| <p>type</p>       | <p><a href="#">PRIIPS_SecurityCodificationType</a></p>  |
| <p>properties</p> | <p>isRef 0<br/>content complex</p>  |
| <p>children</p>   | <p><a href="#">CodificationSystem</a> <a href="#">Code</a></p>  |
| <p>annotation</p> | <p>documentation<br/>         EPT 00030 / CEPT PRICES 10020 / CEPT RHP 30020 - Use ISIN, CUSIP, BLOOMBERG etc. or internal code. See CodificationSystem. ISIN Preferred when available.</p>   |

element **PRIIPS\_ReportType/GeneralPortfolioInformation/PortfolioName**

|                   |  |
|-------------------|--|
| <p>diagram</p>    | <p><b>PortfolioName</b></p> <p>EPT 00050 / CEPT PRICES 10040 / CEPT RHP 30040 - Name of the Portfolio or name of the CIS</p> |
| <p>type</p>       | <p><a href="#">Text256Type</a></p>   |
| <p>properties</p> | <p>isRef 0<br/>content simple</p>  |

|            |  |
|------------|--|
| facets     | Kind Value annotation<br>maxLength 256   |
| annotation | documentation<br>EPT 00050 / CEPT PRICES 10040 / CEPT RHP 30040 - Name of the Portfolio or name of the CIS |

element **PRIIPS\_ReportType/GeneralPortfolioInformation/ShareClassCurrency**

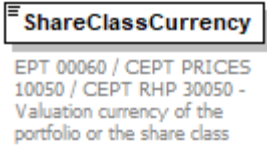
|            |  |
|------------|--|
| diagram    |  <p><b>ShareClassCurrency</b><br/>EPT 00060 / CEPT PRICES 10050 / CEPT RHP 30050 - Valuation currency of the portfolio or the share class</p> |
| type       | <a href="#">ISOCurrencyCodeType</a>  |
| properties | isRef 0<br>content simple  |
| facets     | Kind Value annotation<br>minLength 3<br>maxLength 3<br>pattern [A-Z]{3}  |
| annotation | documentation<br>EPT 00060 / CEPT PRICES 10050 / CEPT RHP 30050 - Valuation currency of the portfolio or the share class   |

element **PRIIPS\_ReportType/GeneralPortfolioInformation/ReferenceDate**

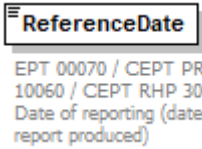
|            |  |
|------------|--|
| diagram    |  <p><b>ReferenceDate</b><br/>EPT 00070 / CEPT PRICES 10060 / CEPT RHP 30060 - Date of reporting (date report produced)</p> |
| type       | <b>xs:date</b>   |
| properties | isRef 0<br>content simple  |
| annotation | documentation<br>EPT 00070 / CEPT PRICES 10060 / CEPT RHP 30060 - Date of reporting (date report produced)   |

element **PRIIPS\_ReportType/GeneralPortfolioInformation/PortfolioPRIIPSCategory**

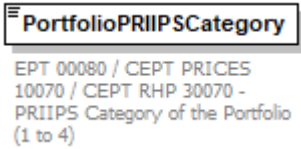
|            |  |
|------------|--|
| diagram    |  <p><b>PortfolioPRIIPSCategory</b><br/>EPT 00080 / CEPT PRICES 10070 / CEPT RHP 30070 - PRIIPS Category of the Portfolio (1 to 4)</p> |
| type       | restriction of <b>xs:short</b>   |
| properties | isRef 0<br>content simple  |
| annotation | documentation<br>EPT 00080 / CEPT PRICES 10070 / CEPT RHP 30070 - PRIIPS Category of the Portfolio (1 to 4)  |

element **PRIIPS\_ReportType/GeneralPortfolioInformation/FundCICCode**

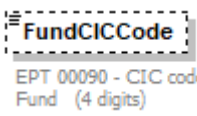
|            |   |
|------------|---|
| diagram    |  |
| type       | restriction of <b>xs:string</b>   |
| properties | isRef 0<br>minOcc 0<br>maxOcc 1<br>content simple                                 |
| facets     | Kind Value annotation<br>length 4<br>pattern [A-Z]{2}[0-9]{2}                     |
| annotation | documentation<br>EPT 00090 - CIC code - Fund (4 digits)                           |

element **PRIIPS\_ReportType/GeneralPortfolioInformation/EOSPortfolio**

|            |   |
|------------|---|
| diagram    |                                  |
| type       | <a href="#">YesNoType</a>   |
| properties | isRef 0<br>minOcc 0<br>maxOcc 1<br>content simple   |
| annotation | documentation<br>EPT 00100 - Indicator whether the portfolio targets specific environmental or social objectives. |

element **PRIIPS\_ReportType/GeneralPortfolioInformation/PortfolioHistoricalStartDate**

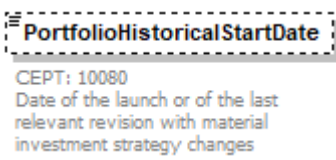
|            |   |
|------------|---|
| diagram    |    |
| type       | <b>xs:date</b>  |
| properties | isRef 0<br>minOcc 0<br>maxOcc 1<br>content simple   |
| annotation | documentation<br>CEPT: 10080<br>Date of the launch or of the last relevant revision with material investment strategy changes |

element **PRIIPS\_ReportType/EPT\_BaseData**

|                   |   |
|-------------------|---|
| <p>diagram</p>    | <p>01-02-03-04 This sheet aims to provide minimum data points for an investment options (wrapper [e.g., in UK MOPs invest in wrappers, which are investing into funds], funds resp. share class data) of Multi Option PRIIPs (MOPs) and discretionary portfolios of an insurance product.</p>                   |
| <p>properties</p> | <p>isRef 0<br/>content complex</p>  |
| <p>children</p>   | <p><a href="#">RiskAssessment</a> <a href="#">PerformanceScenario</a> <a href="#">Costs</a> <a href="#">Narratives</a></p>  |
| <p>annotation</p> | <p>documentation<br/>01-02-03-04 This sheet aims to provide minimum data points for an investment options (wrapper [e.g., in UK MOPs invest in wrappers, which are investing into funds], funds resp. share class data) of Multi Option PRIIPs (MOPs) and discretionary portfolios of an insurance product.</p> |

element **PRIIPS\_ReportType/EPT\_BaseData/RiskAssessment**

diagram

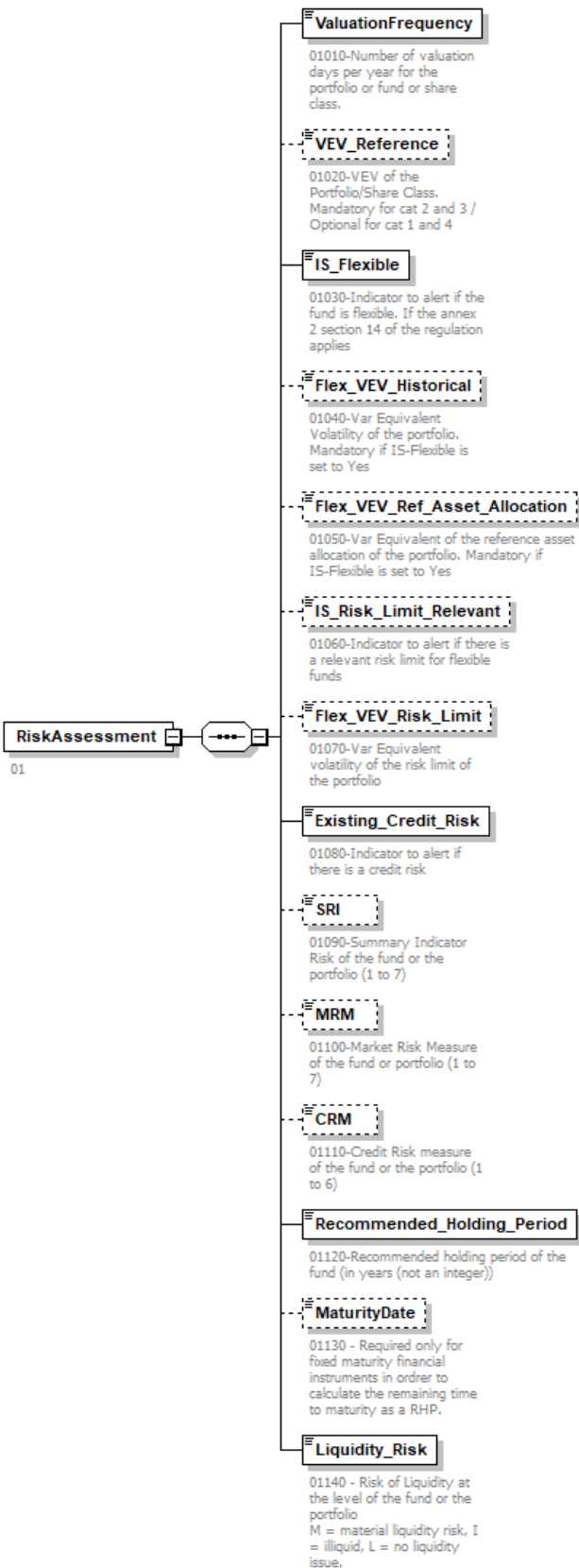

|            |   |
|------------|---|
| properties | isRef 0<br>content complex  |
| children   | <a href="#">ValuationFrequency</a> <a href="#">VEV Reference</a> <a href="#">IS Flexible</a> <a href="#">Flex VEV Historical Flex VEV Ref Asset Allocation</a> <a href="#">IS Risk Limit Relevant Flex VEV Risk Limit Existing Credit Risk SRI MRM CRM Recommended Holding Period</a> <a href="#">MaturityDate</a> <a href="#">Liquidity Risk</a> |
| annotation | documentation<br>01   |

element **PRIIPS\_ReportType/EPT\_BaseData/RiskAssessment/ValuationFrequency**

|            |  |
|------------|--|
| diagram    |  <p>01010-Number of valuation days per year for the portfolio or fund or share class.</p> |
| type       | <a href="#">PRIIPSFrequencyType</a>  |
| properties | isRef 0<br>content simple  |
| annotation | documentation<br>01010-Number of valuation days per year for the portfolio or fund or share class.   |

element **PRIIPS\_ReportType/EPT\_BaseData/RiskAssessment/VEV\_Reference**

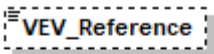
|            |   |
|------------|---|
| diagram    |  <p>01020-VEV of the Portfolio/Share Class. Mandatory for cat 2 and 3 / Optional for cat 1 and 4</p> |
| type       | <b>xs:decimal</b>   |
| properties | isRef 0<br>minOcc 0<br>maxOcc 1<br>content simple   |
| annotation | documentation<br>01020-VEV of the Portfolio/Share Class. Mandatory for cat 2 and 3 / Optional for cat 1 and 4   |

element **PRIIPS\_ReportType/EPT\_BaseData/RiskAssessment/IS\_Flexible**

|            |  |
|------------|--|
| diagram    |  <p>01030-Indicator to alert if the fund is flexible. If the annex 2 section 14 of the regulation applies</p> |
| type       | <a href="#">YesNoType</a>  |
| properties | isRef 0<br>content simple  |
| annotation | documentation<br>01030-Indicator to alert if the fund is flexible. If the annex 2 section 14 of the regulation applies   |

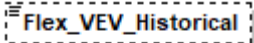

element **PRIIPS\_ReportType/EPT\_BaseData/RiskAssessment/Flex\_VEV\_Historical**

|            |   |
|------------|---|
| diagram    |  <p>01040-Var Equivalent Volatility of the portfolio. Mandatory if IS-Flexible is set to Yes</p> |
| type       | <b>xs:decimal</b>   |
| properties | isRef 0<br>minOcc 0<br>maxOcc 1<br>content simple   |
| annotation | documentation<br>01040-Var Equivalent Volatility of the portfolio. Mandatory if IS-Flexible is set to Yes   |

element **PRIIPS\_ReportType/EPT\_BaseData/RiskAssessment/Flex\_VEV\_Ref\_Asset\_Allocation**

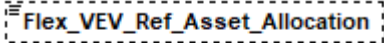
|            |  |
|------------|--|
| diagram    |  <p>01050-Var Equivalent of the reference asset allocation of the portfolio. Mandatory if IS-Flexible is set to Yes</p> |
| type       | <b>xs:decimal</b>  |
| properties | isRef 0<br>minOcc 0<br>maxOcc 1<br>content simple  |
| annotation | documentation<br>01050-Var Equivalent of the reference asset allocation of the portfolio. Mandatory if IS-Flexible is set to Yes   |

element **PRIIPS\_ReportType/EPT\_BaseData/RiskAssessment/IS\_Risk\_Limit\_Relevant**

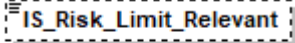
|            |  |
|------------|--|
| diagram    |  <p>01060-Indicator to alert if there is a relevant risk limit for flexible funds</p> |
| type       | <a href="#">YesNoType</a>  |
| properties | isRef 0<br>minOcc 0<br>maxOcc 1<br>content simple  |
| annotation | documentation<br>01060-Indicator to alert if there is a relevant risk limit for flexible funds   |

element **PRIIPS\_ReportType/EPT\_BaseData/RiskAssessment/Flex\_VEV\_Risk\_Limit**

|            |   |
|------------|---|
| diagram    |  <p>01070-Var Equivalent volatility of the risk limit of the portfolio</p> |
| type       | <b>xs:decimal</b>   |
| properties | isRef 0<br>minOcc 0<br>maxOcc 1   |

|            |   |
|------------|---|
|            | content simple  |
| annotation | documentation<br>01070-Var Equivalent volatility of the risk limit of the portfolio |

element **PRIIPS\_ReportType/EPT\_BaseData/RiskAssessment/Existing\_Credit\_Risk**

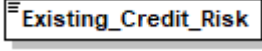
|            |   |
|------------|---|
| diagram    |  <p>Existing_Credit_Risk</p> <p>01080-Indicator to alert if there is a credit risk</p> |
| type       | <a href="#">YesNoType</a>   |
| properties | isRef 0<br>content simple   |
| annotation | documentation<br>01080-Indicator to alert if there is a credit risk   |

element **PRIIPS\_ReportType/EPT\_BaseData/RiskAssessment/SRI**

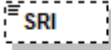
|            |  |
|------------|--|
| diagram    |  <p>SRI</p> <p>01090-Summary Indicator Risk of the fund or the portfolio (1 to 7)</p> |
| type       | restriction of <b>xs:short</b>   |
| properties | isRef 0<br>minOcc 0<br>maxOcc 1<br>content simple  |
| annotation | documentation<br>01090-Summary Indicator Risk of the fund or the portfolio (1 to 7)  |

element **PRIIPS\_ReportType/EPT\_BaseData/RiskAssessment/MRM**

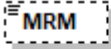
|            |   |
|------------|---|
| diagram    |  <p>MRM</p> <p>01100-Market Risk Measure of the fund or portfolio (1 to 7)</p> |
| type       | restriction of <b>xs:short</b>  |
| properties | isRef 0<br>minOcc 0<br>maxOcc 1<br>content simple   |
| annotation | documentation<br>01100-Market Risk Measure of the fund or portfolio (1 to 7)  |

element **PRIIPS\_ReportType/EPT\_BaseData/RiskAssessment/CRM**

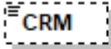
|         |   |
|---------|---|
| diagram |  <p>CRM</p> <p>01110-Credit Risk measure of the fund or the portfolio (1 to 6)</p> |
| type    | restriction of <b>xs:short</b>  |

|            |  |
|------------|--|
| properties | isRef 0<br>minOcc 0<br>maxOcc 1<br>content simple                                |
| annotation | documentation<br>01110-Credit Risk measure of the fund or the portfolio (1 to 6) |

element **PRIIPS\_ReportType/EPT\_BaseData/RiskAssessment/Recommended\_Holding\_Period**

|            |   |
|------------|---|
| diagram    |  <p>01120-Recommended holding period of the fund (in years (not an integer))</p> |
| type       | <b>xs:decimal</b>   |
| properties | isRef 0<br>content simple   |
| annotation | documentation<br>01120-Recommended holding period of the fund (in years (not an integer))   |

element **PRIIPS\_ReportType/EPT\_BaseData/RiskAssessment/MaturityDate**

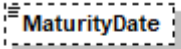
|            |  |
|------------|--|
| diagram    |  <p>01130 - Required only for fixed maturity financial instruments in order to calculate the remaining time to maturity as a RHP.</p> |
| type       | <b>xs:date</b>   |
| properties | isRef 0<br>minOcc 0<br>maxOcc 1<br>content simple  |
| annotation | documentation<br>01130 - Required only for fixed maturity financial instruments in order to calculate the remaining time to maturity as a RHP.   |

element **PRIIPS\_ReportType/EPT\_BaseData/RiskAssessment/Liquidity\_Risk**

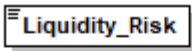
|            |   |
|------------|---|
| diagram    |  <p>01140 - Risk of Liquidity at the level of the fund or the portfolio<br/>M = material liquidity risk, I = illiquid, L = no liquidity issue.</p> |
| type       | restriction of <b>xs:string</b>   |
| properties | isRef 0<br>content simple   |
| annotation | documentation<br>01140 - Risk of Liquidity at the level of the fund or the portfolio<br>M = material liquidity risk, I = illiquid, L = no liquidity issue.  |

element **PRIIPS\_ReportType/EPT\_BaseData/PerformanceScenario**

|                   |   |
|-------------------|---|
| <p>diagram</p>    | <pre> classDiagram     class PerformanceScenario {         02     }     class ReturnUnfavorable {         02010-02020-02030 Annual return of the portfolio, fund, share class corresponding to the unfavorable scenario.     }     class ReturnModerate {         02040-02050-02060 Return of the portfolio, fund, share class corresponding to the moderate scenario     }     class ReturnFavorable {         02070-02080-02090 Annual return of the portfolio, fund, share class corresponding to the favorable scenario     }     class ReturnStress {         02100-02110-02120 Annual return of the portfolio, fund, share class corresponding to the stress scenario     }     class NumberOfObservedReturn_M0 {         02130-See PRIIPS regulation. Mandatory for PRIIPS cat equals to 2     }     class MeanObservedReturns_M1 {         02140-See PRIIPS Regulation. M1. Mandatory for PRIIPS cat equals to 2     }     class ObservedSigma {         02150-See PRIIPS Regulation. Square root of M2. Mandatory for PRIIPS cat equals to 2     }     class ObservedSkewness {         02160-See PRIIPS Regulation. Mandatory for PRIIPS cat equals to 2     }     class ObservedExcessKurtosis {         02170-See PRIIPS Regulation. Mandatory for PRIIPS cat equals to 2     }     class ObservedStressedVolatility {         02180-Volatility used to calculate stress scenario     }      PerformanceScenario &lt; -- ReturnUnfavorable     PerformanceScenario &lt; -- ReturnModerate     PerformanceScenario &lt; -- ReturnFavorable     PerformanceScenario &lt; -- ReturnStress     PerformanceScenario .. NumberOfObservedReturn_M0     PerformanceScenario .. MeanObservedReturns_M1     PerformanceScenario .. ObservedSigma     PerformanceScenario .. ObservedSkewness     PerformanceScenario .. ObservedExcessKurtosis     PerformanceScenario .. ObservedStressedVolatility     </pre> <p>02</p> <p><b>ReturnUnfavorable</b> +</p> <p>02010-02020-02030 Annual return of the portfolio, fund, share class corresponding to the unfavorable scenario.</p> <p><b>ReturnModerate</b> +</p> <p>02040-02050-02060 Return of the portfolio, fund, share class corresponding to the moderate scenario</p> <p><b>ReturnFavorable</b> +</p> <p>02070-02080-02090 Annual return of the portfolio, fund, share class corresponding to the favorable scenario</p> <p><b>ReturnStress</b> +</p> <p>02100-02110-02120 Annual return of the portfolio, fund, share class corresponding to the stress scenario</p> <p><b>NumberOfObservedReturn_M0</b></p> <p>02130-See PRIIPS regulation. Mandatory for PRIIPS cat equals to 2</p> <p><b>MeanObservedReturns_M1</b></p> <p>02140-See PRIIPS Regulation. M1. Mandatory for PRIIPS cat equals to 2</p> <p><b>ObservedSigma</b></p> <p>02150-See PRIIPS Regulation. Square root of M2. Mandatory for PRIIPS cat equals to 2</p> <p><b>ObservedSkewness</b></p> <p>02160-See PRIIPS Regulation. Mandatory for PRIIPS cat equals to 2</p> <p><b>ObservedExcessKurtosis</b></p> <p>02170-See PRIIPS Regulation. Mandatory for PRIIPS cat equals to 2</p> <p><b>ObservedStressedVolatility</b></p> <p>02180-Volatility used to calculate stress scenario</p> |
| <p>properties</p> | <p>isRef 0<br/>content complex</p>  |
| <p>children</p>   | <p><a href="#">ReturnUnfavorable</a> <a href="#">ReturnModerate</a> <a href="#">ReturnFavorable</a> <a href="#">ReturnStress</a> <a href="#">NumberOfObservedReturn_M0</a> <a href="#">MeanObservedReturns_M1</a> <a href="#">ObservedSigma</a> <a href="#">ObservedSkewness</a> <a href="#">ObservedExcessKurtosis</a> <a href="#">ObservedStressedVolatility</a></p>  |

|            |                     |
|------------|---------------------|
| annotation | documentation<br>02 |
|------------|---------------------|

element **PRIIPS\_ReportType/EPT\_BaseData/PerformanceScenario/ReturnUnfavorable**

|            |  |
|------------|--|
| diagram    | <p>The diagram shows the structure of the <b>ReturnUnfavorable</b> element. It is a complex type that contains a sequence of three elements: <b>OneYear</b>, <b>HalfRHP</b>, and <b>RHP</b>. The <b>OneYear</b> element is mandatory if the RHP is greater than 1 year. The <b>HalfRHP</b> element is mandatory if the RHP is greater than 2 years. The <b>RHP</b> element is mandatory at the RHP. The diagram also includes a description of the element: "02010-02020-02030 Annual return of the portfolio, fund, share class corresponding to the unfavorable scenario."</p> |
| type       | <a href="#">PRIIPS_ReturnScenarioType</a>  |
| properties | isRef 0<br>content complex   |
| children   | <a href="#">OneYear</a> <a href="#">HalfRHP</a> <a href="#">RHP</a>  |
| annotation | documentation<br>02010-02020-02030 Annual return of the portfolio, fund, share class corresponding to the unfavorable scenario.  |

element **PRIIPS\_ReportType/EPT\_BaseData/PerformanceScenario/ReturnModerate**

|            |  |
|------------|--|
| diagram    | <p>The diagram shows the structure of the <b>ReturnModerate</b> element. It is a complex type that contains a sequence of three elements: <b>OneYear</b>, <b>HalfRHP</b>, and <b>RHP</b>. The <b>OneYear</b> element is mandatory if the RHP is greater than 1 year. The <b>HalfRHP</b> element is mandatory if the RHP is greater than 2 years. The <b>RHP</b> element is mandatory at the RHP. The diagram also includes a description of the element: "02040-02050-02060 Return of the portfolio, fund, share class corresponding to the moderate scenario"</p> |
| type       | <a href="#">PRIIPS_ReturnScenarioType</a>  |
| properties | isRef 0<br>content complex   |
| children   | <a href="#">OneYear</a> <a href="#">HalfRHP</a> <a href="#">RHP</a>  |
| annotation | documentation<br>02040-02050-02060 Return of the portfolio, fund, share class corresponding to the moderate scenario   |

element **PRIIPS\_ReportType/EPT\_BaseData/PerformanceScenario/ReturnFavorable**

|            |  |
|------------|--|
| diagram    | <p><b>ReturnFavorable</b><br/>02070-02080-02090 Annual return of the portfolio, fund, share class corresponding to the favorable scenario</p> <p><b>PRIIPS_ReturnScenarioType</b></p> <ul style="list-style-type: none"> <li><b>OneYear</b><br/>After one year. Mandatory if RHP &gt;1 year.</li> <li><b>HalfRHP</b><br/>After half of the RHP. Mandatory if the RHP &gt; 2 years.</li> <li><b>RHP</b><br/>At the RHP</li> </ul> |
| type       | <a href="#">PRIIPS_ReturnScenarioType</a>  |
| properties | isRef 0<br>content complex   |
| children   | <a href="#">OneYear</a> <a href="#">HalfRHP</a> <a href="#">RHP</a>  |
| annotation | documentation<br>02070-02080-02090 Annual return of the portfolio, fund, share class corresponding to the favorable scenario   |

element **PRIIPS\_ReportType/EPT\_BaseData/PerformanceScenario/ReturnStress**

|            |  |
|------------|--|
| diagram    | <p><b>ReturnStress</b><br/>02100-02110-02120 Annual return of the portfolio, fund, share class corresponding to the stress scenario</p> <p><b>PRIIPS_ReturnScenarioType</b></p> <ul style="list-style-type: none"> <li><b>OneYear</b><br/>After one year. Mandatory if RHP &gt;1 year.</li> <li><b>HalfRHP</b><br/>After half of the RHP. Mandatory if the RHP &gt; 2 years.</li> <li><b>RHP</b><br/>At the RHP</li> </ul> |
| type       | <a href="#">PRIIPS_ReturnScenarioType</a>  |
| properties | isRef 0<br>content complex   |
| children   | <a href="#">OneYear</a> <a href="#">HalfRHP</a> <a href="#">RHP</a>  |
| annotation | documentation<br>02100-02110-02120 Annual return of the portfolio, fund, share class corresponding to the stress scenario  |

element **PRIIPS\_ReportType/EPT\_BaseData/PerformanceScenario/NumberOfObservedReturn\_M0**

|         |   |
|---------|---|
| diagram | <p><b>NumberOfObservedReturn_M0</b><br/>02130-See PRIIPS regulation.<br/>Mandatory for PRIIPS cat equals to 2</p> |
|---------|---|

|            |   |
|------------|---|
| type       | <b>xs:decimal</b>   |
| properties | isRef 0<br>minOcc 0<br>maxOcc 1<br>content simple                                     |
| annotation | documentation<br>02130-See PRIIPS regulation.<br>Mandatory for PRIIPS cat equals to 2 |

element **PRIIPS\_ReportType/EPT\_BaseData/PerformanceScenario/MeanObservedReturns\_M1**

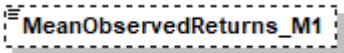
|            |  |
|------------|--|
| diagram    |  <p><b>MeanObservedReturns_M1</b><br/>02140-See PRIIPS Regulation.<br/>M1. Mandatory for PRIIPS cat equals to 2</p> |
| type       | <b>xs:decimal</b>  |
| properties | isRef 0<br>minOcc 0<br>maxOcc 1<br>content simple  |
| annotation | documentation<br>02140-See PRIIPS Regulation.<br>M1. Mandatory for PRIIPS cat equals to 2  |

element **PRIIPS\_ReportType/EPT\_BaseData/PerformanceScenario/ObservedSigma**

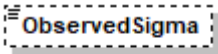
|            |  |
|------------|--|
| diagram    |  <p><b>ObservedSigma</b><br/>02150-See PRIIPS<br/>Regulation. Square root of<br/>M2. Mandatory for PRIIPS<br/>cat equals to 2</p> |
| type       | <b>xs:decimal</b>  |
| properties | isRef 0<br>minOcc 0<br>maxOcc 1<br>content simple  |
| annotation | documentation<br>02150-See PRIIPS Regulation. Square root of M2. Mandatory for PRIIPS cat equals to 2  |

element **PRIIPS\_ReportType/EPT\_BaseData/PerformanceScenario/ObservedSkewness**

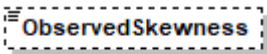
|            |  |
|------------|--|
| diagram    |  <p><b>ObservedSkewness</b><br/>02160-See PRIIPS<br/>Regulation. Mandatory for<br/>PRIIPS cat equals to 2</p> |
| type       | <b>xs:decimal</b>  |
| properties | isRef 0<br>minOcc 0<br>maxOcc 1<br>content simple  |
| annotation | documentation<br>02160-See PRIIPS Regulation. Mandatory for PRIIPS cat equals to 2   |

element **PRIIPS\_ReportType/EPT\_BaseData/PerformanceScenario/ObservedExcessKurtosis**

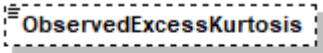
|            |   |
|------------|---|
| diagram    |  <p><b>ObservedExcessKurtosis</b></p> <p>02170-See PRIIPS Regulation. Mandatory for PRIIPS cat equals to 2</p> |
| type       | <b>xs:decimal</b>   |
| properties | isRef 0<br>minOcc 0<br>maxOcc 1<br>content simple   |
| annotation | documentation<br>02170-See PRIIPS Regulation. Mandatory for PRIIPS cat equals to 2  |

element **PRIIPS\_ReportType/EPT\_BaseData/PerformanceScenario/ObservedStressedVolatility**

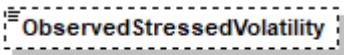
|            |  |
|------------|--|
| diagram    |  <p><b>ObservedStressedVolatility</b></p> <p>02180-Volatility used to calculate stress scenario</p> |
| type       | <b>xs:decimal</b>  |
| properties | isRef 0<br>minOcc 0<br>maxOcc 1<br>content simple  |
| annotation | documentation<br>02180-Volatility used to calculate stress scenario  |

element **PRIIPS\_ReportType/EPT\_BaseData/Costs**

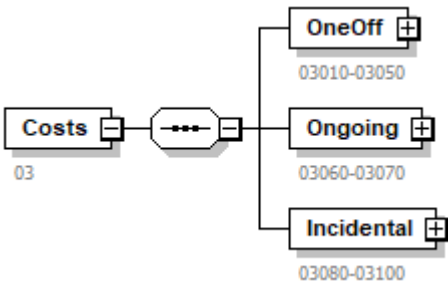
|            |  |
|------------|--|
| diagram    |  <p>The diagram shows a tree structure for the <b>Costs</b> element. The root is <b>Costs</b> (code 03). It has a complex content type indicated by a dashed box. It branches into three children: <b>OneOff</b> (code 03010-03050), <b>Ongoing</b> (code 03060-03070), and <b>Incidental</b> (code 03080-03100). Each child element has a plus sign icon, indicating it is a complex type.</p> |
| properties | isRef 0<br>content complex   |
| children   | <a href="#">OneOff</a> <a href="#">Ongoing</a> <a href="#">Incidental</a>  |
| annotation | documentation<br>03  |



element **PRIIPS\_ReportType/EPT\_BaseData/Costs/OneOff**

|                   |  |
|-------------------|--|
| <p>diagram</p>    | <p><b>OneOff</b><br/>03010-03050</p> <p><b>EntryCost</b><br/>03010-Subscription fees not acquired to the fund or the share class or portfolio mandate. Expressed as a % of the amount to be invested</p> <p><b>EntryCostsAcquired</b><br/>03015-Subscription fees acquired to the fund or the share class or portfolio mandate. Expressed as a % of the amount to be invested</p> <p><b>ExitCostAtRHP</b><br/>03020-Exit fees at the end of RHP for the portfolio or fund or share class. It is expressed as a % of net asset value.</p> <p><b>ExitCostOneYear</b><br/>03030-Exit fees after one year for the portfolio or fund or shar class. It is expressed as a % of net asset value. Mandatory if datapoint Sliding exit cost is Yes.</p> <p><b>ExitCostHalfRHP</b><br/>03040-Exit fees after half of the RHP for the portfolio or fund or shar class. It is expressed as a % of net asset value. Mandatory if datapoint Sliding exit cost is Yes.</p> <p><b>SlidingExitCostIndicator</b><br/>03050-Sliding exit cost indicator</p> |
| <p>properties</p> | <p>isRef 0<br/>content complex</p>   |
| <p>children</p>   | <p><a href="#">EntryCost</a> <a href="#">EntryCostsAcquired</a> <a href="#">ExitCostAtRHP</a> <a href="#">ExitCostOneYear</a> <a href="#">ExitCostHalfRHP</a> <a href="#">SlidingExitCostIndicator</a></p>   |
| <p>annotation</p> | <p>documentation<br/>03010-03050</p>   |

element **PRIIPS\_ReportType/EPT\_BaseData/Costs/OneOff/EntryCost**

|                   |   |
|-------------------|---|
| <p>diagram</p>    | <p><b>EntryCost</b><br/>03010-Subscription fees not acquired to the fund or the share class or portfolio mandate. Expressed as a % of the amount to be invested</p> |
| <p>type</p>       | <p>restriction of <b>xs:decimal</b></p>   |
| <p>properties</p> | <p>isRef 0<br/>content simple</p>   |

|            |  |
|------------|--|
| facets     | Kind Value annotation<br>minInclusive 0  |
| annotation | documentation<br>03010-Subscription fees not acquired to the fund or the share class or portfolio mandate. Expressed as a % of the amount to be invested |

element **PRIIPS\_ReportType/EPT\_BaseData/Costs/OneOff/EntryCostsAcquired**

|            |  |
|------------|--|
| diagram    |  <p>03015-Subscription fees acquired to the fund or the share class or portfolio mandate. Expressed as a % of the amount to be invested</p> |
| type       | <b>xs:decimal</b>  |
| properties | isRef 0<br>content simple  |
| annotation | documentation<br>03015-Subscription fees acquired to the fund or the share class or portfolio mandate. Expressed as a % of the amount to be invested   |

element **PRIIPS\_ReportType/EPT\_BaseData/Costs/OneOff/ExitCostAtRHP**

|            |   |
|------------|---|
| diagram    |  <p>03020-Exit fees at the end of RHP for the portfolio or fund or share class. It is expressed as a % of net asset value.</p> |
| type       | restriction of <b>xs:decimal</b>  |
| properties | isRef 0<br>content simple   |
| facets     | Kind Value annotation<br>minInclusive 0   |
| annotation | documentation<br>03020-Exit fees at the end of RHP for the portfolio or fund or share class. It is expressed as a % of net asset value.   |

element **PRIIPS\_ReportType/EPT\_BaseData/Costs/OneOff/ExitCostOneYear**

|            |  |
|------------|--|
| diagram    |  <p>03030-Exit fees after one year for the portfolio or fund or shar class. It is expressed as a % of net asset value. Mandatory if datapoint Sliding exit cost is Yes.</p> |
| type       | restriction of <b>xs:decimal</b>   |
| properties | isRef 0<br>minOcc 0<br>maxOcc 1<br>content simple  |
| facets     | Kind Value annotation<br>minInclusive 0  |
| annotation | documentation<br>03030-Exit fees after one year for the portfolio or fund or shar class. It is expressed as a % of net asset value. Mandatory  |

|  |  |
|--|--|
|  | if datapoint Sliding exit cost is Yes. |
|--|--|

element **PRIIPS\_ReportType/EPT\_BaseData/Costs/OneOff/ExitCostHalfRHP**

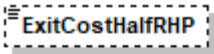
|            |   |
|------------|---|
| diagram    |  <p>03040-Exit fees after half of the RHP for the portfolio or fund or shar class. It is expressed as a % of net asset value. Mandatory if datapoint Sliding exit cost is Yes.</p> |
| type       | restriction of <b>xs:decimal</b>  |
| properties | isRef 0<br>minOcc 0<br>maxOcc 1<br>content simple   |
| facets     | Kind Value annotation<br>minInclusive 0   |
| annotation | documentation<br>03040-Exit fees after half of the RHP for the portfolio or fund or shar class. It is expressed as a % of net asset value. Mandatory if datapoint Sliding exit cost is Yes.   |

element **PRIIPS\_ReportType/EPT\_BaseData/Costs/OneOff/SlidingExitCostIndicator**

|            |   |
|------------|---|
| diagram    |  <p>03050-Sliding exit cost indicator</p> |
| type       | <a href="#">YesNoType</a>   |
| properties | isRef 0<br>content simple   |
| annotation | documentation<br>03050-Sliding exit cost indicator  |

element **PRIIPS\_ReportType/EPT\_BaseData/Costs/Ongoing**

|            |   |
|------------|---|
| diagram    | <p><b>OtherCost</b><br/>03060-See PRIIPS definition as a % of NAV of the portfolio, the funds or the share class / per annum. Maximum fees, including look through for fund of funds / custodian fees / management fees.</p> <p><b>ManagementCosts</b><br/>03070-Maximum fee. Can be submitted to reduction for some specific commercial agreement between insurers and structurers.</p> <p><b>Transaction</b><br/>03080-See PRIIPS definition as a % of NAV of the portfolio, the funds or the share class / per annum</p> |
| properties | isRef 0<br>content complex  |
| children   | <a href="#">OtherCost</a> <a href="#">ManagementCosts</a> <a href="#">Transaction</a>   |
| annotation | documentation<br>03060-03070  |

element **PRIIPS\_ReportType/EPT\_BaseData/Costs/Ongoing/OtherCost**

|            |  |
|------------|--|
| diagram    | <p><b>OtherCost</b><br/>03060-See PRIIPS definition as a % of NAV of the portfolio, the funds or the share class / per annum. Maximum fees, including look through for fund of funds / custodian fees / management fees.</p> |
| type       | restriction of <b>xs:decimal</b>   |
| properties | isRef 0<br>content simple  |
| facets     | Kind Value annotation<br>minInclusive 0  |
| annotation | documentation<br>03060-See PRIIPS definition as a % of NAV of the portfolio, the funds or the share class / per annum. Maximum fees, including look through for fund of funds / custodian fees / management fees.            |

element **PRIIPS\_ReportType/EPT\_BaseData/Costs/Ongoing/ManagementCosts**

|         |   |
|---------|---|
| diagram | <p><b>ManagementCosts</b><br/>03070-Maximum fee. Can be submitted to reduction for some specific commercial agreement between insurers and structurers.</p> |
|---------|---|

|            |  |
|------------|--|
| properties | isRef 0  |
| annotation | documentation<br>03070-Maximum fee. Can be submitted to reduction for some specific commercial agreement between insurers and structurers. |

element **PRIIPS\_ReportType/EPT\_BaseData/Costs/Ongoing/Transaction**

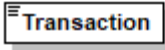
|            |   |
|------------|---|
| diagram    |  <p>03080-See PRIIPS definition as a % of NAV of the portfolio, the funds or the share class / per annum</p> |
| type       | restriction of <b>xs:decimal</b>  |
| properties | isRef 0<br>content simple   |
| facets     | Kind Value annotation<br>minInclusive 0   |
| annotation | documentation<br>03080-See PRIIPS definition as a % of NAV of the portfolio, the funds or the share class / per annum   |

element **PRIIPS\_ReportType/EPT\_BaseData/Costs/Incidental**

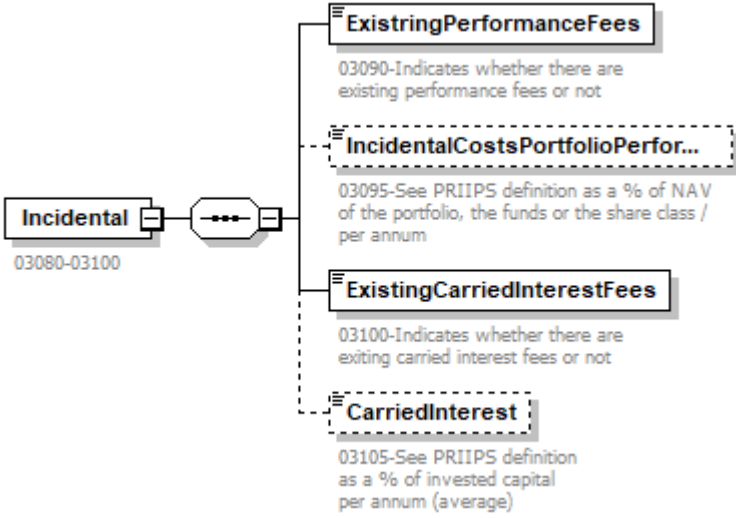
|            |  |
|------------|--|
| diagram    |  <p>03080-03100</p> <p><b>ExistingPerformanceFees</b><br/>03090-Indicates whether there are existing performance fees or not</p> <p><b>IncidentalCostsPortfolioPerfor...</b><br/>03095-See PRIIPS definition as a % of NAV of the portfolio, the funds or the share class / per annum</p> <p><b>ExistingCarriedInterestFees</b><br/>03100-Indicates whether there are exiting carried interest fees or not</p> <p><b>CarriedInterest</b><br/>03105-See PRIIPS definition as a % of invested capital per annum (average)</p> |
| properties | isRef 0<br>content complex   |
| children   | <a href="#">ExistingPerformanceFees</a> <a href="#">IncidentalCostsPortfolioPerformanceFees</a> <a href="#">ExistingCarriedInterestFees</a> <a href="#">CarriedInterest</a>  |
| annotation | documentation<br>03080-03100   |

element **PRIIPS\_ReportType/EPT\_BaseData/Costs/Incidental/ExistingPerformanceFees**

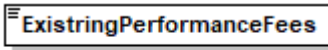
|         |   |
|---------|---|
| diagram |  <p>03090-Indicates whether there are existing performance fees or not</p> |
| type    | <a href="#">YesNoType</a>   |

|            |   |
|------------|---|
| properties | isRef 0<br>content simple   |
| annotation | documentation<br>03090-Indicates whether there are existing performance fees or not |

element **PRIIPS\_ReportType/EPT\_BaseData/Costs/Incidental/IncidentalCostsPortfolioPerformanceFees**

|            |   |
|------------|---|
| diagram    |  <p>03095-See PRIIPS definition as a % of NAV of the portfolio, the funds or the share class / per annum</p> |
| type       | <b>xs:decimal</b>   |
| properties | isRef 0<br>minOcc 0<br>maxOcc 1<br>content simple   |
| annotation | documentation<br>03095-See PRIIPS definition as a % of NAV of the portfolio, the funds or the share class / per annum   |

element **PRIIPS\_ReportType/EPT\_BaseData/Costs/Incidental/ExistingCarriedInterestFees**

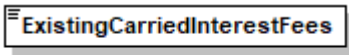
|            |   |
|------------|---|
| diagram    |  <p>03100-Indicates whether there are exiting carried interest fees or not</p> |
| properties | isRef 0   |
| annotation | documentation<br>03100-Indicates whether there are exiting carried interest fees or not   |

element **PRIIPS\_ReportType/EPT\_BaseData/Costs/Incidental/CarriedInterest**

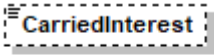
|            |   |
|------------|---|
| diagram    |  <p>03105-See PRIIPS definition as a % of invested capital per annum (average)</p> |
| type       | restriction of <b>xs:decimal</b>  |
| properties | isRef 0<br>minOcc 0<br>maxOcc 1<br>content simple   |
| facets     | Kind Value annotation<br>minInclusive 0   |
| annotation | documentation<br>03105-See PRIIPS definition as a % of invested capital per annum (average)   |

element PRIIPS\_ReportType/EPT\_BaseData/Narratives

diagram

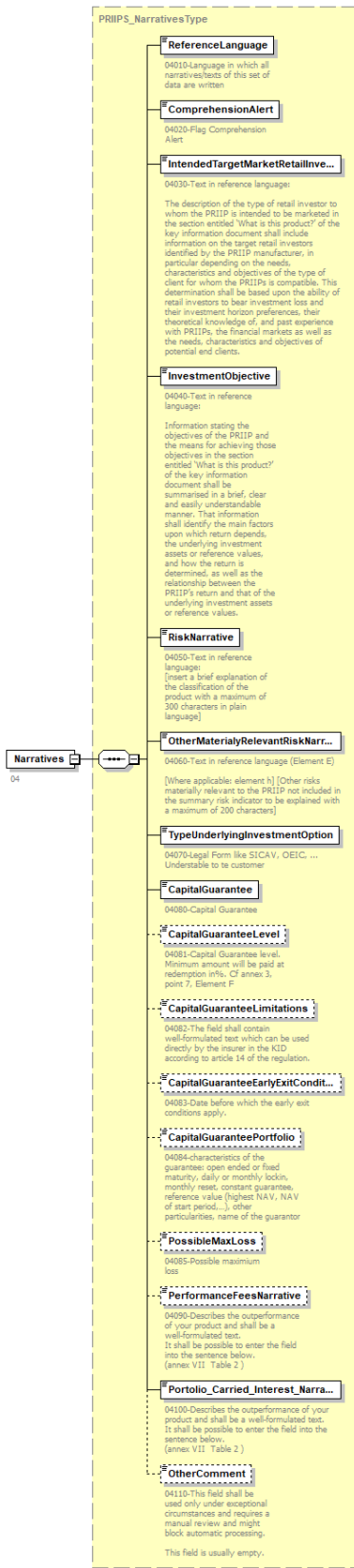

|            |   |
|------------|---|
| type       | <a href="#">PRIIPS NarrativesType</a>   |
| properties | isRef 0<br>content complex  |
| children   | <a href="#">ReferenceLanguage</a> <a href="#">ComprehensionAlert</a> <a href="#">IntendedTargetMarketRetailInvestor</a> <a href="#">InvestmentObjective</a> <a href="#">RiskNarrative</a> <a href="#">OtherMaterialyRelevantRiskNarrative</a> <a href="#">TypeUnderlyingInvestmentOption</a> <a href="#">CapitalGuarantee</a> <a href="#">CapitalGuaranteeLevel</a> <a href="#">CapitalGuaranteeLimitations</a> <a href="#">CapitalGuaranteeEarlyExitConditions</a> <a href="#">CapitalGuaranteePortfolio</a> <a href="#">PossibleMaxLoss</a> <a href="#">PerformanceFeesNarrative</a> <a href="#">Portolio</a> <a href="#">Carried</a> <a href="#">Interest</a> <a href="#">Narrative</a> <a href="#">OtherComment</a> |
| annotation | documentation<br>04   |

element **PRIIPS\_ReportType/EPT\_SpecificUCITS**

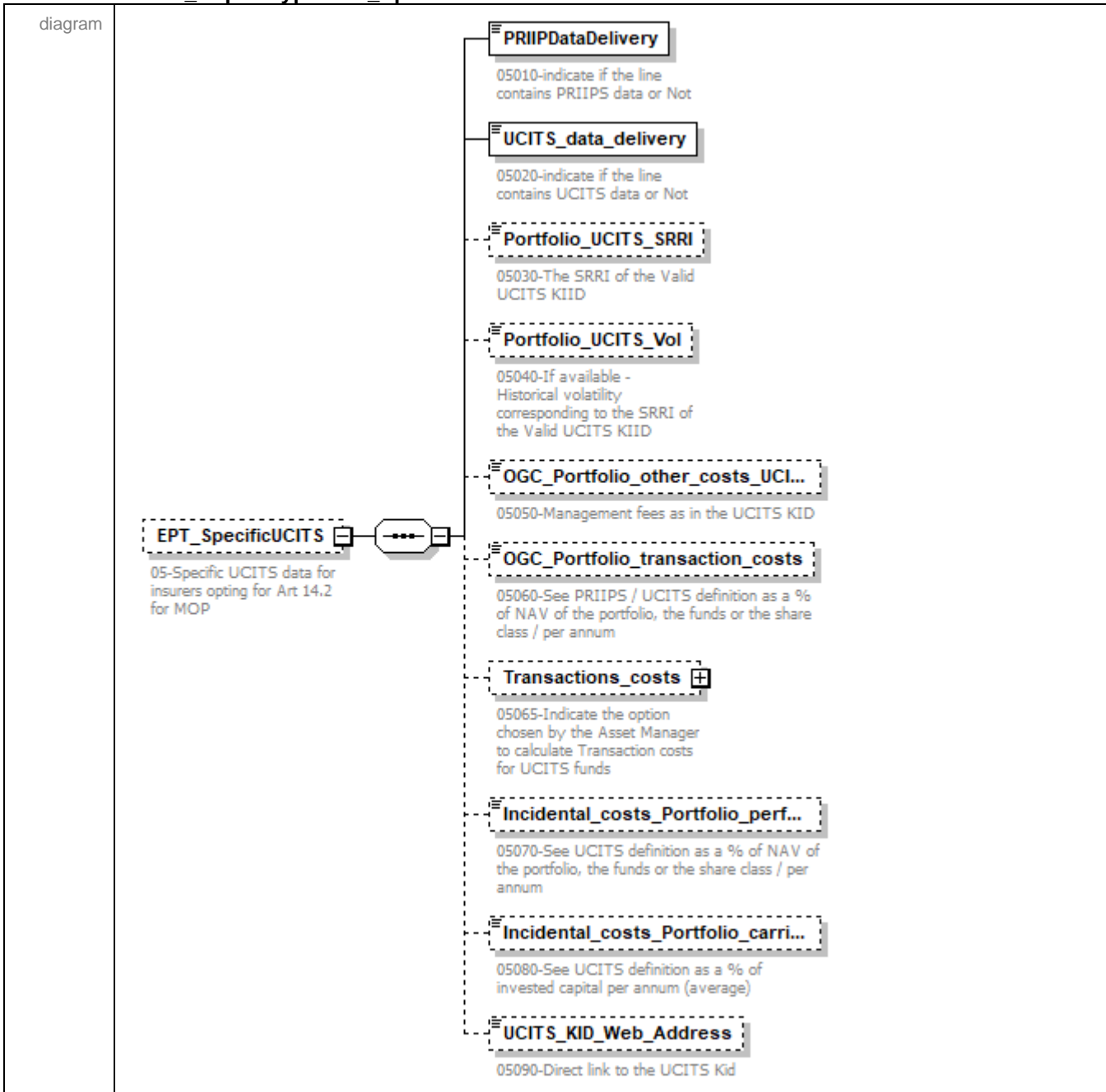



|            |   |
|------------|---|
| properties | isRef 0<br>minOcc 0<br>maxOcc 1<br>content complex  |
| children   | <a href="#">PRIIPDataDelivery UCITS data delivery Portfolio UCITS SRRl Portfolio UCITS Vol OGC Portfolio other costs UCITS OGC Portfolio transaction costs Transactions costs Incidental costs Portfolio performance fees UCITS Incidental costs Portfolio carried interest UCITS UCITS KID Web Address</a> |
| annotation | documentation<br>05-Specific UCITS data for insurers opting for Art 14.2 for MOP  |

element **PRIIPS\_ReportType/EPT\_SpecificUCITS/PRIIPDataDelivery**

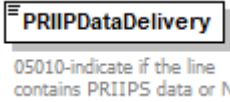
|            |   |
|------------|---|
| diagram    |  |
| type       | <a href="#">YesNoType</a>   |
| properties | isRef 0<br>content simple   |
| annotation | documentation<br>05010-indicate if the line contains PRIIPS data or Not           |

element **PRIIPS\_ReportType/EPT\_SpecificUCITS/UCITS\_data\_delivery**

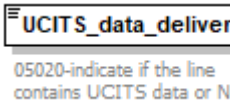
|            |  |
|------------|--|
| diagram    |  |
| type       | <a href="#">YesNoType</a>  |
| properties | isRef 0<br>content simple  |
| annotation | documentation<br>05020-indicate if the line contains UCITS data or Not             |

element **PRIIPS\_ReportType/EPT\_SpecificUCITS/Portfolio\_UCITS\_SRRl**

|            |   |
|------------|---|
| diagram    |  |
| type       | restriction of <b>xs:string</b>   |
| properties | isRef 0<br>minOcc 0<br>maxOcc 1<br>content simple                                   |
| facets     | Kind Value annotation<br>maxLength 1  |
| annotation | documentation<br>05030-The SRRl of the Valid UCITS KIID                             |

element **PRIIPS\_ReportType/EPT\_SpecificUCITS/Portfolio\_UCITS\_Vol**

|            |   |
|------------|---|
| diagram    |  <p>05040-If available -<br/>Historical volatility<br/>corresponding to the SRRI of<br/>the Valid UCITS KIID</p> |
| type       | <b>xs:decimal</b>   |
| properties | isRef 0<br>minOcc 0<br>maxOcc 1<br>content simple   |
| annotation | documentation<br>05040-If available - Historical volatility corresponding to the SRRI of the Valid UCITS KIID   |

element **PRIIPS\_ReportType/EPT\_SpecificUCITS/OGC\_Portfolio\_other\_costs\_UCITS**

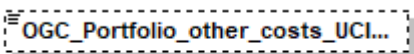
|            |  |
|------------|--|
| diagram    |  <p>05050-Management fees as in the UCITS KID</p> |
| type       | <b>xs:decimal</b>  |
| properties | isRef 0<br>minOcc 0<br>maxOcc 1<br>content simple  |
| annotation | documentation<br>05050-Management fees as in the UCITS KID   |

element **PRIIPS\_ReportType/EPT\_SpecificUCITS/OGC\_Portfolio\_transaction\_costs**

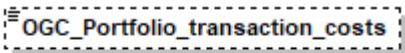
|            |   |
|------------|---|
| diagram    |  <p>05060-See PRIIPS / UCITS definition as a %<br/>of NAV of the portfolio, the funds or the share<br/>class / per annum</p> |
| type       | <b>xs:decimal</b>   |
| properties | isRef 0<br>minOcc 0<br>maxOcc 1<br>content simple   |
| annotation | documentation<br>05060-See PRIIPS / UCITS definition as a % of NAV of the portfolio, the funds or the share class / per annum   |

element **PRIIPS\_ReportType/EPT\_SpecificUCITS/Transactions\_costs**

|            |   |
|------------|---|
| diagram    | <p>The diagram shows a central element labeled <b>Transactions_costs</b> with a dashed border. Below it is the text: "05065-Indicate the option chosen by the Asset Manager to calculate Transaction costs for UCITS funds". To its right, a dashed line connects to a <b>Methodology</b> element (dashed border) containing a list: "1. New PRIIPS methodology", "2. Full PRIIPS methodology", "3. Other methodology", "4. None", "5. text". Below that, another dashed line connects to a <b>MethodologyText</b> element (solid border) containing "5. Text".</p> |
| properties | <p>isRef 0<br/> minOcc 0<br/> maxOcc 1<br/> content complex</p>   |
| children   | <p><a href="#">Methodology</a> <a href="#">MethodologyText</a></p>  |
| annotation | <p>documentation<br/> 05065-Indicate the option chosen by the Asset Manager to calculate Transaction costs for UCITS funds</p>  |

element **PRIIPS\_ReportType/EPT\_SpecificUCITS/Transactions\_costs/Methodology**

|            |   |
|------------|---|
| diagram    | <p>The diagram shows a <b>Methodology</b> element (dashed border) containing a list: "1. New PRIIPS methodology", "2. Full PRIIPS methodology", "3. Other methodology", "4. None", "5. text".</p> |
| type       | <p>restriction of <b>xs:string</b></p>  |
| properties | <p>isRef 0<br/> minOcc 0<br/> maxOcc 1<br/> content simple</p>  |
| annotation | <p>documentation<br/> 1. New PRIIPS methodology<br/> 2. Full PRIIPS methodology<br/> 3. Other methodology<br/> 4. None<br/> 5. text</p>   |

element **PRIIPS\_ReportType/EPT\_SpecificUCITS/Transactions\_costs/MethodologyText**

|            |   |
|------------|---|
| diagram    | <p>The diagram shows a <b>MethodologyText</b> element (solid border) containing the text "5. Text".</p> |
| type       | <p>restriction of <b>xs:string</b></p>  |
| properties | <p>isRef 0<br/> content simple</p>  |
| facets     | <p>Kind Value annotation<br/> maxLength 255</p>   |
| annotation | <p>documentation<br/> 5. Text</p>   |

element **PRIIPS\_ReportType/EPT\_SpecificUCITS/Incidental\_costs\_Portfolio\_performance\_fees\_UCITS**

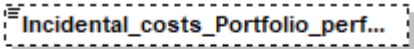
|            |  |
|------------|--|
| diagram    |  <p>05070-See UCITS definition as a % of NAV of the portfolio, the funds or the share class / per annum</p> |
| type       | <b>xs:decimal</b>  |
| properties | isRef 0<br>minOcc 0<br>maxOcc 1<br>content simple  |
| annotation | documentation<br>05070-See UCITS definition as a % of NAV of the portfolio, the funds or the share class / per annum   |

element **PRIIPS\_ReportType/EPT\_SpecificUCITS/Incidental\_costs\_Portfolio\_carried\_interest\_UCITS**

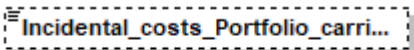
|            |  |
|------------|--|
| diagram    |  <p>05080-See UCITS definition as a % of invested capital per annum (average)</p> |
| type       | <b>xs:decimal</b>  |
| properties | isRef 0<br>minOcc 0<br>maxOcc 1<br>content simple  |
| annotation | documentation<br>05080-See UCITS definition as a % of invested capital per annum (average)   |

element **PRIIPS\_ReportType/EPT\_SpecificUCITS/UCITS\_KID\_Web\_Address**

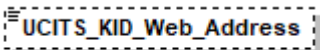
|            |   |
|------------|---|
| diagram    |  <p>05090-Direct link to the UCITS Kid</p> |
| type       | <b>xs:anyURI</b>  |
| properties | isRef 0<br>minOcc 0<br>maxOcc 1<br>content simple   |
| annotation | documentation<br>05090-Direct link to the UCITS Kid   |

element **PRIIPS\_ReportType/EPT\_SpecificStructuredProducts**

diagram

**EPT\_SpecificStructuredProducts**

07-Specific data for Structured Products - RIY Costs  
 Note: Cost fields in RIY terms as requested by the PRIIPS KID. This section is optional and is required only if it is impossible to calculate RIY from the previous section. This happens for products with periodical coupons and/or early callability features. In this case, the Performance Scenario fields together with the Cost fields are not adequate to calculate the IRR of the gross and net scenarios.

**Total\_cost\_1\_year**

07010-Total cost in 00060\_Share\_Class\_Currency terms in case the investor cashes in after one year, as requested in the "Costs over time" table. Rebased to 1.

**RIY\_1\_year**

07020-RIY in case the investor cashes in after one year, as requested in the "Costs over time" table.

**Total\_cost\_half\_RHP**

07030-Total cost in 00060\_Share\_Class\_Currency terms in case the investor cashes in at the middle of the RHP, as requested in the "Costs over time" table.

**RIY\_half\_RHP**

07040-RIY in case the investor cashes in at the middle of the RHP, as requested in the "Costs over time" table.

**Total\_cost\_RHP**

07050-Total cost in 00060\_Share\_Class\_Currency terms in case the investor cashes in at the RHP, as requested in the "Costs over time" table.

**RIY\_RHP**

07060-RIY in case the investor cashes in at the RHP, as requested in the "Costs over time" table.

**One-off\_costs\_Portfolio\_entry\_...**

07070-The entry cost in RIY terms, as requested in the "Composition of costs" table.

**One-off\_costs\_Portfolio\_exit\_co...**

07080-The exit cost in RIY terms, as requested in the "Composition of costs" table.

**Ongoing\_costs\_Portfolio\_transa...**

07090-The portfolio transaction costs in RIY terms, as requested in the "Composition of costs" table.

**Ongoing\_costs\_Other\_ongoing\_...**

07100-The other ongoing costs in RIY terms, as requested in the "Composition of costs" table.

**Incidental\_costs\_Portfolio\_perf...**

07110-The performance fees in RIY terms, as requested in the "Composition of costs" table.

**Incidental\_costs\_Portfolio\_carri...**

07120-The carried interests in RIY terms, as requested in the "Composition of costs" table.

|            |   |
|------------|---|
| properties | isRef 0<br>minOcc 0<br>maxOcc 1<br>content complex  |
| children   | <a href="#">Total cost 1 year RIY 1 year</a> <a href="#">Total cost half RHP RIY half RHP</a> <a href="#">Total cost RHP RIY RHP</a><br><a href="#">One-off costs Portfolio entry cost RIY</a> <a href="#">One-off costs Portfolio exit cost RIY</a><br><a href="#">Ongoing costs Portfolio transaction costs RIY</a> <a href="#">Ongoing costs Other ongoing costs RIY</a><br><a href="#">Incidental costs Portfolio performance fees RIY</a> <a href="#">Incidental costs Portfolio carried interests RIY</a> |
| annotation | documentation<br>07-Specific data for Structured Products - RIY Costs<br>Note: Cost fields in RIY terms as requested by the PRIIPS KID. This section is optional and is required only if it is impossible to calculate RIY from the previous section. This happens for products with periodical coupons and/or early callability features. In this case, the Performance Scenario fields together with the Cost fields are not adequate to calculate the IRR of the gross and net scenarios.                    |

element **PRIIPS\_ReportType/EPT\_SpecificStructuredProducts/Total\_cost\_1\_year**

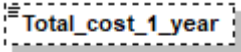
|            |   |
|------------|---|
| diagram    | <br>07010-Total cost in 00060_Share_Class_Currency terms in case the investor cashes in after one year, as requested in the "Costs over time" table. Rebased to 1. |
| type       | <b>xs:decimal</b>   |
| properties | isRef 0<br>minOcc 0<br>maxOcc 1<br>content simple   |
| annotation | documentation<br>07010-Total cost in 00060_Share_Class_Currency terms in case the investor cashes in after one year, as requested in the "Costs over time" table. Rebased to 1.   |

element **PRIIPS\_ReportType/EPT\_SpecificStructuredProducts/RIY\_1\_year**

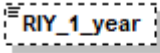
|            |  |
|------------|--|
| diagram    | <br>07020-RIY in case the investor cashes in after one year, as requested in the "Costs over time" table. |
| type       | <b>xs:decimal</b>  |
| properties | isRef 0<br>minOcc 0<br>maxOcc 1<br>content simple  |
| annotation | documentation<br>07020-RIY in case the investor cashes in after one year, as requested in the "Costs over time" table.   |

element **PRIIPS\_ReportType/EPT\_SpecificStructuredProducts/Total\_cost\_half\_RHP**

|            |   |
|------------|---|
| diagram    |  <p>07030-Total cost in 00060_Share_Class_Currency terms in case the investor cashes in at the middle of the RHP, as requested in the "Costs over time" table.</p> |
| type       | <b>xs:decimal</b>   |
| properties | <p>isRef 0<br/> minOcc 0<br/> maxOcc 1<br/> content simple</p>  |
| annotation | <p>documentation<br/> 07030-Total cost in 00060_Share_Class_Currency terms in case the investor cashes in at the middle of the RHP, as requested in the "Costs over time" table.</p>  |

element **PRIIPS\_ReportType/EPT\_SpecificStructuredProducts/RIY\_half\_RHP**

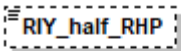
|            |  |
|------------|--|
| diagram    |  <p>07040-RIY in case the investor cashes in at the middle of the RHP, as requested in the "Costs over time" table.</p> |
| type       | <b>xs:decimal</b>  |
| properties | <p>isRef 0<br/> minOcc 0<br/> maxOcc 1<br/> content simple</p>   |
| annotation | <p>documentation<br/> 07040-RIY in case the investor cashes in at the middle of the RHP, as requested in the "Costs over time" table.</p>  |

element **PRIIPS\_ReportType/EPT\_SpecificStructuredProducts/Total\_cost\_RHP**

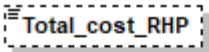
|            |   |
|------------|---|
| diagram    |  <p>07050-Total cost in 00060_Share_Class_Currency terms in case the investor cashes in at the RHP, as requested in the "Costs over time" table.</p> |
| type       | <b>xs:decimal</b>   |
| properties | <p>isRef 0<br/> minOcc 0<br/> maxOcc 1<br/> content simple</p>  |
| annotation | <p>documentation<br/> 07050-Total cost in 00060_Share_Class_Currency terms in case the investor cashes in at the RHP, as requested in the "Costs over time" table.</p>  |

element **PRIIPS\_ReportType/EPT\_SpecificStructuredProducts/RIY\_RHP**

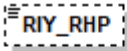
|            |  |
|------------|--|
| diagram    |  <p>07060-RIY in case the investor cashes in at the RHP, as requested in the "Costs over time" table.</p> |
| type       | <b>xs:decimal</b>  |
| properties | isRef 0<br>minOcc 0<br>maxOcc 1<br>content simple  |
| annotation | documentation<br>07060-RIY in case the investor cashes in at the RHP, as requested in the "Costs over time" table.   |

element **PRIIPS\_ReportType/EPT\_SpecificStructuredProducts/One-off costs Portfolio entry cost RIY**

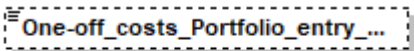
|            |   |
|------------|---|
| diagram    |  <p>07070-The entry cost in RIY terms, as requested in the "Composition of costs" table.</p> |
| type       | <b>xs:decimal</b>   |
| properties | isRef 0<br>minOcc 0<br>maxOcc 1<br>content simple   |
| annotation | documentation<br>07070-The entry cost in RIY terms, as requested in the "Composition of costs" table.   |

element **PRIIPS\_ReportType/EPT\_SpecificStructuredProducts/One-off costs Portfolio exit cost RIY**

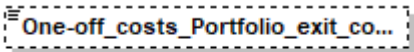
|            |  |
|------------|--|
| diagram    |  <p>07080-The exit cost in RIY terms, as requested in the "Composition of costs" table.</p> |
| type       | <b>xs:decimal</b>  |
| properties | isRef 0<br>minOcc 0<br>maxOcc 1<br>content simple  |
| annotation | documentation<br>07080-The exit cost in RIY terms, as requested in the "Composition of costs" table.   |

element

**PRIIPS\_ReportType/EPT\_SpecificStructuredProducts/Ongoing costs Portfolio transaction costs RIY**

|            |  |
|------------|--|
| diagram    |  <p>07090-The portfolio transaction costs in RIY terms, as requested in the "Composition of costs" table.</p> |
| type       | <b>xs:decimal</b>  |
| properties | isRef 0<br>minOcc 0<br>maxOcc 1  |



|            |  |
|------------|--|
|            | content simple   |
| annotation | documentation<br>07090-The portfolio transaction costs in RIY terms, as requested in the "Composition of costs" table. |

element

**PRIIPS\_ReportType/EPT\_SpecificStructuredProducts/Ongoing\_costs\_Other\_ongoing\_costs\_RIY**

|            |   |
|------------|---|
| diagram    |  <b>Ongoing_costs_Other_ongoing_...</b><br>07100-The other ongoing costs in RIY terms, as requested in the "Composition of costs" table. |
| type       | <b>xs:decimal</b>   |
| properties | isRef 0<br>minOcc 0<br>maxOcc 1<br>content simple   |
| annotation | documentation<br>07100-The other ongoing costs in RIY terms, as requested in the "Composition of costs" table.  |

element

**PRIIPS\_ReportType/EPT\_SpecificStructuredProducts/Incidental\_costs\_Portfolio\_performance\_fees\_RIY**

|            |   |
|------------|---|
| diagram    |  <b>Incidental_costs_Portfolio_perf...</b><br>07110-The performance fees in RIY terms, as requested in the "Composition of costs" table. |
| type       | <b>xs:decimal</b>   |
| properties | isRef 0<br>minOcc 0<br>maxOcc 1<br>content simple   |
| annotation | documentation<br>07110-The performance fees in RIY terms, as requested in the "Composition of costs" table.   |

element

**PRIIPS\_ReportType/EPT\_SpecificStructuredProducts/Incidental\_costs\_Portfolio\_carried\_interests\_RIY**

|            |   |
|------------|---|
| diagram    |  <b>Incidental_costs_Portfolio_carri...</b><br>07120-The carried interests in RIY terms, as requested in the "Composition of costs" table. |
| type       | <b>xs:decimal</b>   |
| properties | isRef 0<br>minOcc 0<br>maxOcc 1<br>content simple   |
| annotation | documentation<br>07120-The carried interests in RIY terms, as requested in the "Composition of costs" table.  |

element **PRIIPS\_ReportType/CEPT\_Prices**

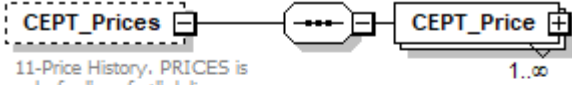
|                   |   |
|-------------------|---|
| <p>diagram</p>    |  <p>11-Price History. PRICES is only for "comfort" delivery. This node aims to provide raw price data of the investment options, which can be used by the MOP manufacturer to perform calculations in the context of the MOP KID preparation</p> |
| <p>properties</p> | <p>isRef 0<br/> minOcc 0<br/> maxOcc 1<br/> content complex</p>   |
| <p>children</p>   | <p><a href="#">CEPT_Price</a></p>   |
| <p>annotation</p> | <p>documentation<br/> 11-Price History. PRICES is only for "comfort" delivery. This node aims to provide raw price data of the investment options, which can be used by the MOP manufacturer to perform calculations in the context of the MOP KID preparation</p>  |

element PRIIPS\_ReportType/CEPT\_Prices/CEPT\_Price

diagram

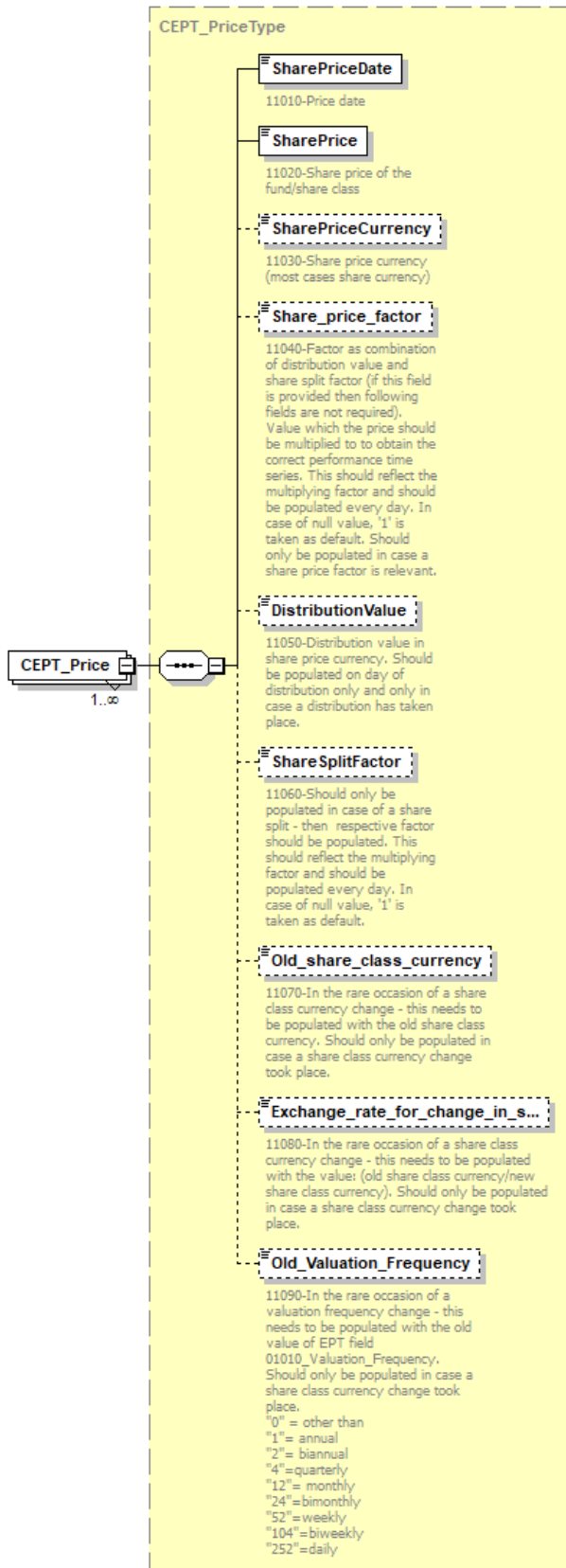

|            |   |
|------------|---|
| type       | <a href="#">CEPT PriceType</a>  |
| properties | isRef 0<br>minOcc 1<br>maxOcc unbounded<br>content complex  |
| children   | <a href="#">SharePriceDate</a> <a href="#">SharePrice</a> <a href="#">SharePriceCurrency</a> <a href="#">Share_price_factor</a> <a href="#">DistributionValue</a> <a href="#">ShareSplitFactor</a><br><a href="#">Old_share_class_currency</a> <a href="#">Exchange_rate_for_change_in_share_class_currency</a> <a href="#">Old_Valuation</a> <a href="#">Frequency</a> |

element PRIIPS\_ReportType/CEPT\_Narratives

diagram

**CEPT\_Narratives**  
 04-Narratives translated per reference language provided. NARRATIVES is only for "comfort" delivery. This node has been established to allow investment option manufacturer to provide narratives in languages that may differ from the original base language. It aims to enable MOP manufacturers to align the narrative languages required for the MOP KID.

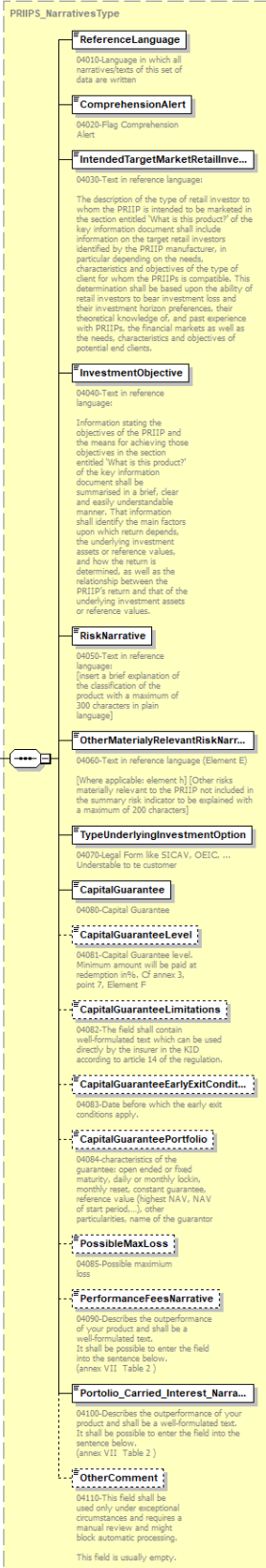

|            |   |
|------------|---|
| type       | <a href="#">PRIIPS NarrativesType</a>   |
| properties | isRef 0<br>minOcc 0<br>maxOcc 1<br>content complex  |
| children   | <a href="#">ReferenceLanguage</a> <a href="#">ComprehensionAlert</a> <a href="#">IntendedTargetMarketRetailInvestor</a> <a href="#">InvestmentObjective</a> <a href="#">RiskNarrative</a> <a href="#">OtherMaterialyRelevantRiskNarrative</a> <a href="#">TypeUnderlyingInvestmentOption</a> <a href="#">CapitalGuarantee</a> <a href="#">CapitalGuaranteeLevel</a> <a href="#">CapitalGuaranteeLimitations</a> <a href="#">CapitalGuaranteeEarlyExitConditions</a> <a href="#">CapitalGuaranteePortfolio</a> <a href="#">PossibleMaxLoss</a> <a href="#">PerformanceFeesNarrative</a> <a href="#">Portolio</a> <a href="#">Carried</a> <a href="#">Interest</a> <a href="#">Narrative</a> <a href="#">OtherComment</a> |
| annotation | documentation<br>04-Narratives translated per reference language provided. NARRATIVES is only for "comfort" delivery. This node has been established to allow investment option manufacturer to provide narratives in languages that may differ from the original base language.<br>It aims to enable MOP manufacturers to align the narrative languages required for the MOP KID.  |

element [PRIIPS\\_ReportType/CEPT\\_RHPS](#)

|            |   |
|------------|---|
| diagram    | <pre> classDiagram     CEPT_RHPS .. CEPT_RHPSType     class CEPT_RHPSType {         CEPT_RHP 1..∞     } </pre>  |
|            | <p>31-32-33-34<br/> VALUES_PER_RHP is only for "comfort" delivery. This node has been established to allow PRIIP manufacturer investing in other PRIIPs (e.g., MOPs) to receive calculated figures for RHPs that may differ from the RHP of the underlying PRIIP (e.g., RHP = 5 for an UCITS share class). Therefore, it enables PRIIP manufacturer to pick the values for the related RHP that matches the RHP of the PRIIP (e.g., MOP). It is up to the underlying PRIIP manufacturer to provide such additional information, beside the calculated figures at original RHP, as they are presented in the main data sheet.</p> <p>The data file will contain calculated figures for a range of RHP from 5-30 years and each line Represents the performance scenarios for each RHP.</p> |
| type       | <a href="#">CEPT_RHPSType</a>   |
| properties | isRef 0<br>minOcc 0<br>maxOcc 1<br>content complex  |
| children   | <a href="#">CEPT_RHP</a>  |
| annotation | documentation<br>31-32-33-34 VALUES_PER_RHP is only for "comfort" delivery. This node has been established to allow PRIIP manufacturer investing in other PRIIPs (e.g., MOPs) to receive calculated figures for RHPs that may differ from the RHP of the underlying PRIIP (e.g., RHP = 5 for an UCITS share class). Therefore, it enables PRIIP manufacturer to pick the values for the related RHP that matches the RHP of the PRIIP (e.g., MOP). It is up to the underlying PRIIP manufacturer to provide such additional information, beside the calculated figures at original RHP, as they are presented in the main data sheet.   |

The data file will contain calculated figures for a range of RHP from 5-30 years and each line Represents the performance scenarios for each RHP.

element **PRIIPS\_ReportType/CountrySpecificData**

|            |  |
|------------|--|
| diagram    |  |
| properties | isRef 0<br>minOcc 0<br>maxOcc 1<br>content complex   |
| children   | <a href="#">AT</a> <a href="#">DE</a> <a href="#">DK</a> <a href="#">FR</a> <a href="#">LU</a> <a href="#">NL</a> <a href="#">UKPRIIPsDataReferenceDate</a> <a href="#">UK</a> |

element **PRIIPS\_ReportType/CountrySpecificData/AT**

| diagram    |  |            |       |            |           |   |  |
|------------|--|------------|-------|------------|-----------|---|--|
| type       | restriction of <b>xs:string</b>  |            |       |            |           |   |  |
| properties | isRef 0<br>minOcc 0<br>maxOcc 1<br>content simple  |            |       |            |           |   |  |
| facets     | <table border="1"> <thead> <tr> <th>Kind</th> <th>Value</th> <th>annotation</th> </tr> </thead> <tbody> <tr> <td>maxLength</td> <td>0</td> <td></td> </tr> </tbody> </table> | Kind       | Value | annotation | maxLength | 0 |  |
| Kind       | Value  | annotation |       |            |           |   |  |
| maxLength  | 0  |            |       |            |           |   |  |

element **PRIIPS\_ReportType/CountrySpecificData/DE**

|            |   |
|------------|---|
| diagram    |   |
| type       | <a href="#">PRIIPS_DE_EPT_PiaType</a>                               |
| properties | isRef 0<br>minOcc 0<br>maxOcc 1<br>content complex                  |
| children   | <a href="#">Characteristics</a> <a href="#">CapitalPreservation</a> |
| annotation | documentation<br>Specific data for German CAT IV PRIIPs (PIA model) |

element **PRIIPS\_ReportType/CountrySpecificData/DK**

|            |   |
|------------|---|
| diagram    |   |
| type       | restriction of <b>xs:string</b>                   |
| properties | isRef 0<br>minOcc 0<br>maxOcc 1<br>content simple |
| facets     | Kind Value annotation<br>maxLength 0              |

element **PRIIPS\_ReportType/CountrySpecificData/FR**

|            |   |
|------------|---|
| diagram    |   |
| type       | restriction of <b>xs:string</b>                   |
| properties | isRef 0<br>minOcc 0<br>maxOcc 1<br>content simple |
| facets     | Kind Value annotation<br>maxLength 0              |

element **PRIIPS\_ReportType/CountrySpecificData/LU**

|         |                                 |
|---------|---------------------------------|
| diagram |                                 |
| type    | restriction of <b>xs:string</b> |



|            |   |
|------------|---|
| properties | isRef 0<br>minOcc 0<br>maxOcc 1<br>content simple |
| facets     | Kind Value annotation<br>maxLength 0              |

element **PRIIPS\_ReportType/CountrySpecificData/NL**

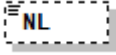
|            |   |
|------------|---|
| diagram    |  |
| type       | restriction of <b>xs:string</b>   |
| properties | isRef 0<br>minOcc 0<br>maxOcc 1<br>content simple                                 |
| facets     | Kind Value annotation<br>maxLength 0  |

element **PRIIPS\_ReportType/CountrySpecificData/UKPRIIPsDataReferenceDate**

|            |   |
|------------|---|
| diagram    |  |
| type       | <b>xs:date</b>  |
| properties | isRef 0<br>content simple   |
| annotation | documentation<br>The date to which the UK PRIIPs data in this section relates     |

element PRIIPS\_ReportType/CountrySpecificData/UK

diagram

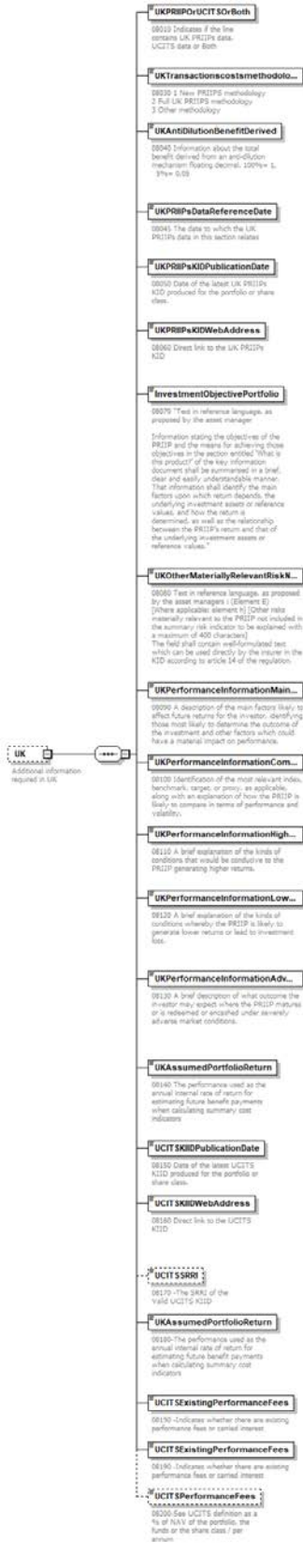

|            |  |
|------------|--|
| properties | isRef 0<br>minOcc 0<br>maxOcc 1<br>content complex   |
| children   | <a href="#">UKPRIIPOrUCITSoBoth</a> <a href="#">UKTransactionscostsmethodology</a> <a href="#">UKAntiDilutionBenefitDerived</a><br><a href="#">UKPRIIPsDataReferenceDate</a> <a href="#">UKPRIIPsKIDPublicationDate</a> <a href="#">UKPRIIPsKIDWebAddress</a> <a href="#">InvestmentObjectivePortfolio</a><br><a href="#">UKOtherMateriallyRelevantRiskNarrativePortfolio</a> <a href="#">UKPerformanceInformationMainFactors</a><br><a href="#">UKPerformanceInformationComparator</a> <a href="#">UKPerformanceInformationHigherReturns</a><br><a href="#">UKPerformanceInformationLowerReturnsOrLoss</a> <a href="#">UKPerformanceInformationAdverseConditions</a><br><a href="#">UKAssumedPortfolioReturn</a> <a href="#">UCITSKIIDPublicationDate</a> <a href="#">UCITSKIIDWebAddress</a> <a href="#">UCITSSRRI</a><br><a href="#">UKAssumedPortfolioReturn</a> <a href="#">UCITSExistingPerformanceFees</a> <a href="#">UCITSExistingPerformanceFees</a><br><a href="#">UCITSPerformanceFees</a> |
| annotation | documentation<br>Additional information required in UK   |

element **PRIIPS\_ReportType/CountrySpecificData/UK/UKPRIIPOrUCITSoBoth**

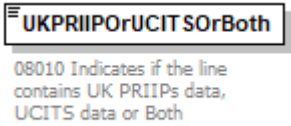
|            |  |
|------------|--|
| diagram    |         |
| type       | restriction of <b>xs:string</b>  |
| properties | isRef 0<br>content simple  |
| annotation | documentation<br>08010 Indicates if the line contains UK PRIIPs data, UCITS data or Both |

element **PRIIPS\_ReportType/CountrySpecificData/UK/UKTransactionscostsmethodology**

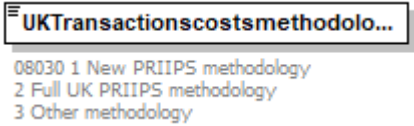
|            |  |
|------------|--|
| diagram    |                     |
| type       | restriction of <b>xs:short</b>   |
| properties | isRef 0<br>content simple  |
| facets     | Kind Value annotation<br>minInclusive 1<br>maxInclusive 3  |
| annotation | documentation<br>08030 1 New PRIIPS methodology<br>2 Full UK PRIIPS methodology<br>3 Other methodology |

element **PRIIPS\_ReportType/CountrySpecificData/UK/UKAntiDilutionBenefitDerived**

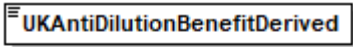
|            |  |
|------------|--|
| diagram    |  <p>08040 Information about the total benefit derived from an anti-dilution mechanism floating decimal. 100%= 1, 5%= 0,05</p> |
| type       | <b>xs:decimal</b>  |
| properties | isRef 0<br>content simple  |
| annotation | documentation<br>08040 Information about the total benefit derived from an anti-dilution mechanism floating decimal. 100%= 1, 5%= 0,05   |

element **PRIIPS\_ReportType/CountrySpecificData/UK/UKPRIIPsDataReferenceDate**

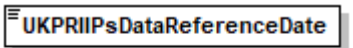
|            |   |
|------------|---|
| diagram    |  <p>08045 The date to which the UK PRIIPs data in this section relates</p> |
| type       | <b>xs:date</b>  |
| properties | isRef 0<br>content simple   |
| annotation | documentation<br>08045 The date to which the UK PRIIPs data in this section relates   |

element **PRIIPS\_ReportType/CountrySpecificData/UK/UKPRIIPsKIDPublicationDate**

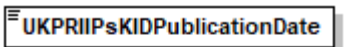
|            |  |
|------------|--|
| diagram    |  <p>08050 Date of the latest UK PRIIPs KID produced for the portfolio or share class.</p> |
| type       | <b>xs:date</b>   |
| properties | isRef 0<br>content simple  |
| annotation | documentation<br>08050 Date of the latest UK PRIIPs KID produced for the portfolio or share class.   |

element **PRIIPS\_ReportType/CountrySpecificData/UK/UKPRIIPsKIDWebAddress**

|         |   |
|---------|---|
| diagram |  <p>08060 Direct link to the UK PRIIPs KID</p> |
|---------|---|

|            |   |
|------------|---|
| type       | <b>xs:anyURI</b>  |
| properties | isRef 0<br>content simple                               |
| annotation | documentation<br>08060 Direct link to the UK PRIIPs KID |

element **PRIIPS\_ReportType/CountrySpecificData/UK/InvestmentObjectivePortfolio**

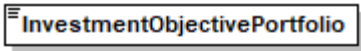
|            |   |
|------------|---|
| diagram    |  <p>08070 "Text in reference language, as proposed by the asset manager"</p> <p>Information stating the objectives of the PRIIP and the means for achieving those objectives in the section entitled 'What is this product?' of the key information document shall be summarised in a brief, clear and easily understandable manner. That information shall identify the main factors upon which return depends, the underlying investment assets or reference values, and how the return is determined, as well as the relationship between the PRIIP's return and that of the underlying investment assets or reference values."</p> |
| type       | restriction of <b>xs:string</b>   |
| properties | isRef 0<br>content simple   |
| facets     | Kind Value annotation<br>maxLength 2500   |
| annotation | documentation<br>08070 "Text in reference language, as proposed by the asset manager"   |
|            | Information stating the objectives of the PRIIP and the means for achieving those objectives in the section entitled 'What is this product?' of the key information document shall be summarised in a brief, clear and easily understandable manner. That information shall identify the main factors upon which return depends, the underlying investment assets or reference values, and how the return is determined, as well as the relationship between the PRIIP's return and that of the underlying investment assets or reference values."  |

element **PRIIPS\_ReportType/CountrySpecificData/UK/UKOtherMateriallyRelevantRiskNarrativePortfolio**

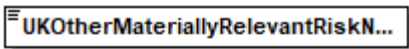
|            |  |
|------------|--|
| diagram    |  <p>08080 Text in reference language, as proposed by the asset managers : (Element E)<br/>[Where applicable: element h] [Other risks materially relevant to the PRIIP not included in the summary risk indicator to be explained with a maximum of 400 characters]<br/>The field shall contain well-formulated text which can be used directly by the insurer in the KID according to article 14 of the regulation.</p> |
| type       | restriction of <b>xs:string</b>  |
| properties | isRef 0<br>content simple  |

|            |  |
|------------|--|
| facets     | Kind Value annotation<br>maxLength 400   |
| annotation | documentation<br>08080 Text in reference language, as proposed by the asset managers : (Element E)<br>[Where applicable: element h] [Other risks materially relevant to the PRIIP not included in the summary risk indicator to be explained with a maximum of 400 characters]<br>The field shall contain well-formulated text which can be used directly by the insurer in the KID according to article 14 of the regulation. |

element **PRIIPS\_ReportType/CountrySpecificData/UK/UKPerformanceInformationMainFactors**

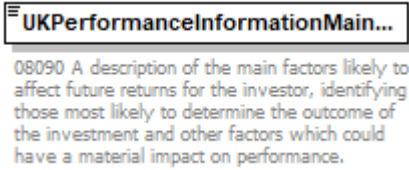
|            |  |
|------------|--|
| diagram    |  <p>08090 A description of the main factors likely to affect future returns for the investor, identifying those most likely to determine the outcome of the investment and other factors which could have a material impact on performance.</p> |
| type       | restriction of <b>xs:string</b>  |
| properties | isRef 0<br>content simple  |
| facets     | Kind Value annotation<br>maxLength 4000  |
| annotation | documentation<br>08090 A description of the main factors likely to affect future returns for the investor, identifying those most likely to determine the outcome of the investment and other factors which could have a material impact on performance.   |

element **PRIIPS\_ReportType/CountrySpecificData/UK/UKPerformanceInformationComparator**

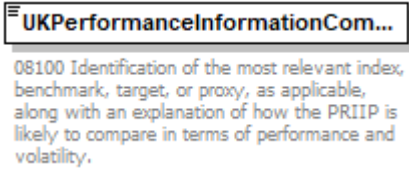
|            |   |
|------------|---|
| diagram    |  <p>08100 Identification of the most relevant index, benchmark, target, or proxy, as applicable, along with an explanation of how the PRIIP is likely to compare in terms of performance and volatility.</p> |
| type       | restriction of <b>xs:string</b>   |
| properties | isRef 0<br>content simple   |
| facets     | Kind Value annotation<br>maxLength 1000   |
| annotation | documentation<br>08100 Identification of the most relevant index, benchmark, target, or proxy, as applicable, along with an explanation of how the PRIIP is likely to compare in terms of performance and volatility.   |

element **PRIIPS\_ReportType/CountrySpecificData/UK/UKPerformanceInformationHigherReturns**

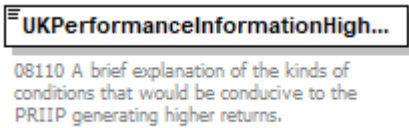
|            |   |
|------------|---|
| diagram    |  <p>08110 A brief explanation of the kinds of conditions that would be conducive to the PRIIP generating higher returns.</p> |
| type       | restriction of <b>xs:string</b>   |
| properties | isRef 0<br>content simple   |

|            |   |
|------------|---|
| facets     | Kind Value annotation<br>maxLength 1000   |
| annotation | documentation<br>08110 A brief explanation of the kinds of conditions that would be conducive to the PRIIP generating higher returns. |

element **PRIIPS\_ReportType/CountrySpecificData/UK/UKPerformanceInformationLowerReturnsOrLoss**

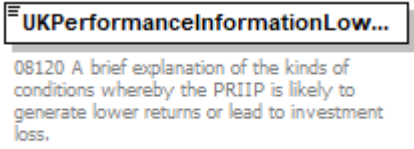
|            |   |
|------------|---|
| diagram    |    |
| type       | restriction of <b>xs:string</b>   |
| properties | isRef 0<br>content simple   |
| facets     | Kind Value annotation<br>maxLength 1000   |
| annotation | documentation<br>08120 A brief explanation of the kinds of conditions whereby the PRIIP is likely to generate lower returns or lead to investment loss. |

element **PRIIPS\_ReportType/CountrySpecificData/UK/UKPerformanceInformationAdverseConditions**

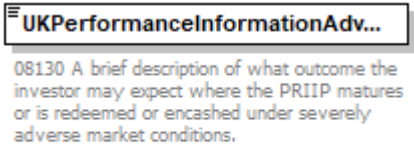
|            |   |
|------------|---|
| diagram    |    |
| type       | restriction of <b>xs:string</b>   |
| properties | isRef 0<br>content simple   |
| facets     | Kind Value annotation<br>maxLength 1000   |
| annotation | documentation<br>08130 A brief description of what outcome the investor may expect where the PRIIP matures or is redeemed or encashed under severely adverse market conditions. |

element **PRIIPS\_ReportType/CountrySpecificData/UK/UKAssumedPortfolioReturn**

|            |   |
|------------|---|
| diagram    |  <p>08140 The performance used as the annual internal rate of return for estimating future benefit payments when calculating summary cost indicators</p> |
| type       | <b>xs:decimal</b>   |
| properties | isRef 0<br>content simple   |
| annotation | documentation<br>08140 The performance used as the annual internal rate of return for estimating future benefit payments when calculating summary cost indicators   |

element **PRIIPS\_ReportType/CountrySpecificData/UK/UCITSKIIDPublicationDate**

|            |   |
|------------|---|
| diagram    |  <p>08150 Date of the latest UCITS KIID produced for the portfolio or share class.</p> |
| type       | <b>xs:date</b>  |
| properties | isRef 0<br>content simple   |
| annotation | documentation<br>08150 Date of the latest UCITS KIID produced for the portfolio or share class.   |

element **PRIIPS\_ReportType/CountrySpecificData/UK/UCITSKIIDWebAddress**

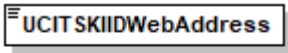
|            |  |
|------------|--|
| diagram    |  <p>08160 Direct link to the UCITS KIID</p> |
| type       | <b>xs:anyURI</b>   |
| properties | isRef 0<br>content simple  |
| annotation | documentation<br>08160 Direct link to the UCITS KIID   |

element **PRIIPS\_ReportType/CountrySpecificData/UK/UCITSSRRI**

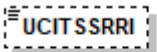
|         |  |
|---------|--|
| diagram |  <p>08170 -The SRRI of the Valid UCITS KIID</p> |
| type    | restriction of <b>xs:short</b>   |



|            |  |
|------------|--|
| properties | isRef 0<br>minOcc 0<br>maxOcc 1<br>content simple        |
| annotation | documentation<br>08170 -The SRR1 of the Valid UCITS KIID |

element **PRIIPS\_ReportType/CountrySpecificData/UK/UKAssumedPortfolioReturn**

|            |   |
|------------|---|
| diagram    |  <p>08180-The performance used as the annual internal rate of return for estimating future benefit payments when calculating summary cost indicators</p> |
| type       | <b>xs:decimal</b>   |
| properties | isRef 0<br>content simple   |
| annotation | documentation<br>08180-The performance used as the annual internal rate of return for estimating future benefit payments when calculating summary cost indicators   |

element **PRIIPS\_ReportType/CountrySpecificData/UK/UCITSExistingPerformanceFees**

|            |  |
|------------|--|
| diagram    |  <p>08190 -Indicates whether there are existing performance fees or carried interest</p> |
| type       | <a href="#">YesNoType</a>  |
| properties | isRef 0<br>content simple  |
| annotation | documentation<br>08190 -Indicates whether there are existing performance fees or carried interest  |

element **PRIIPS\_ReportType/CountrySpecificData/UK/UCITSExistingPerformanceFees**

|            |   |
|------------|---|
| diagram    |  <p>08190 -Indicates whether there are existing performance fees or carried interest</p> |
| type       | <a href="#">YesNoType</a>   |
| properties | isRef 0<br>content simple   |
| annotation | documentation<br>08190 -Indicates whether there are existing performance fees or carried interest   |

element **PRIIPS\_ReportType/CountrySpecificData/UK/UCITSPerformanceFees**

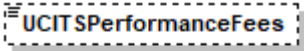
|            |  |
|------------|--|
| diagram    |  <p>08200-See UCITS definition as a % of NAV of the portfolio, the funds or the share class / per annum</p> |
| type       | <b>xs:decimal</b>  |
| properties | <p>isRef 0<br/> minOcc 0<br/> maxOcc 1<br/> content simple</p>   |
| annotation | <p>documentation<br/> 08200-See UCITS definition as a % of NAV of the portfolio, the funds or the share class / per annum</p>  |

complexType **PRIIPS\_ReturnScenarioType**

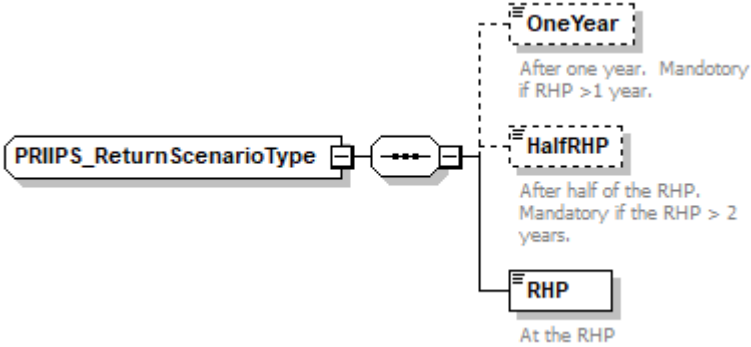
|          |   |
|----------|---|
| diagram  |  <p>The diagram shows the complex type <b>PRIIPS_ReturnScenarioType</b> containing three elements: <b>OneYear</b>, <b>HalfRHP</b>, and <b>RHP</b>. <b>OneYear</b> is described as "After one year. Mandatory if RHP &gt;1 year." <b>HalfRHP</b> is described as "After half of the RHP. Mandatory if the RHP &gt; 2 years." <b>RHP</b> is described as "At the RHP".</p> |
| children | <a href="#">OneYear</a> <a href="#">HalfRHP</a> <a href="#">RHP</a>   |
| used by  | <p>elements <a href="#">PRIIPS_ReportType/EPT_BaseData/PerformanceScenario/ReturnFavorable</a><br/> <a href="#">PRIIPS_ReportType/EPT_BaseData/PerformanceScenario/ReturnModerate</a><br/> <a href="#">PRIIPS_ReportType/EPT_BaseData/PerformanceScenario/ReturnStress</a><br/> <a href="#">PRIIPS_ReportType/EPT_BaseData/PerformanceScenario/ReturnUnfavorable</a></p>  |

element **PRIIPS\_ReturnScenarioType/OneYear**

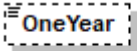
|            |   |
|------------|---|
| diagram    |  <p>After one year. Mandatory if RHP &gt;1 year.</p> |
| type       | <b>xs:decimal</b>   |
| properties | <p>isRef 0<br/> minOcc 0<br/> maxOcc 1<br/> content simple</p>  |
| annotation | <p>documentation<br/> After one year. Mandatory if RHP &gt;1 year.</p>  |

element **PRIIPS\_ReturnScenarioType/HalfRHP**

|            |  |
|------------|--|
| diagram    |  <p>After half of the RHP.<br/>Mandatory if the RHP &gt; 2 years.</p> |
| type       | <b>xs:decimal</b>  |
| properties | <p>isRef 0<br/>minOcc 0<br/>maxOcc 1<br/>content simple</p>  |
| annotation | <p>documentation<br/>After half of the RHP. Mandatory if the RHP &gt; 2 years.</p>   |

element **PRIIPS\_ReturnScenarioType/RHP**

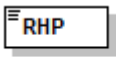
|            |   |
|------------|---|
| diagram    |  <p>At the RHP</p> |
| type       | <b>xs:decimal</b>   |
| properties | <p>isRef 0<br/>content simple</p>   |
| annotation | <p>documentation<br/>At the RHP</p>   |

complexType **PRIIPS\_SecurityCodificationType**

|                   |   |
|-------------------|---|
| <p>diagram</p>    | <p><b>PRIIPS_SecurityCodificationType</b><br/>CodificationSystem (restricted list for Securities) and Code expressed in CodificationSystem</p> <p><b>CodificationSystem</b><br/>Codification system used. Integer corresponding to the following closed list:<br/>1 - ISO 6166 for ISIN code<br/>2 - CUSIP (The Committee on Uniform Securities Identification Procedures number assigned by the CUSIP Service Bureau for U.S. and Canadian companies)<br/>3 - SEDOL (Stock Exchange Daily Official List for the London Stock Exchange)<br/>4 - WKN (Wertpapier Kenn-Nummer, the alphanumeric German identification number)<br/>5 - Bloomberg Ticker (Bloomberg letters code that identify a company's securities)<br/>6 - BBGID (The Bloomberg Global ID)<br/>7 - Reuters RIC (Reuters instrument code)<br/>8 - FIGI (Financial Instrument Global Identifier)<br/>9 - Other code by members of the Association of National Numbering Agencies<br/>99 - Code attributed by the undertaking</p> <p><b>Code</b><br/>Value of code in CodificationSystem</p> |
| <p>children</p>   | <p><a href="#">CodificationSystem</a> <a href="#">Code</a></p>  |
| <p>used by</p>    | <p>elements <a href="#">PRIIPS_ReportType/GeneralPortfolioInformation/PortfolioID</a><br/><a href="#">CEPTV2PerformanceType/GeneralPortfolioInformation/PortfolioID</a><br/><a href="#">CEPTV2HistoryType/GeneralPortfolioInformation/PortfolioID</a><br/><a href="#">PRIIPSType_V20/EPTV2/GeneralPortfolioInformation/PortfolioID</a></p>  |
| <p>annotation</p> | <p>documentation<br/>CodificationSystem (restricted list for Securities) and Code expressed in CodificationSystem</p>   |

element **PRIIPS\_SecurityCodificationType/CodificationSystem**

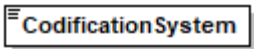
|            |   |
|------------|---|
| diagram    |  <p>Codification system used.<br/>Integer corresponding to the following closed list:<br/>1 - ISO 6166 for ISIN code<br/>2 - CUSIP (The Committee on Uniform Securities Identification Procedures number assigned by the CUSIP Service Bureau for U.S. and Canadian companies)<br/>3 - SEDOL (Stock Exchange Daily Official List for the London Stock Exchange)<br/>4 - WKN (Wertpapier Kenn-Nummer, the alphanumeric German identification number)<br/>5 - Bloomberg Ticker (Bloomberg letters code that identify a company's securities)<br/>6 - BBGID (The Bloomberg Global ID)<br/>7 - Reuters RIC (Reuters instrument code)<br/>8 - FIGI (Financial Instrument Global Identifier)<br/>9 - Other code by members of the Association of National Numbering Agencies<br/>99 - Code attributed by the undertaking</p> |
| type       | restriction of <b>xs:short</b>  |
| properties | isRef 0<br>content <b>simple</b>  |
| facets     | Kind Value annotation<br>minInclusive 1<br>maxInclusive 99  |
| annotation | documentation<br>Codification system used.<br>Integer corresponding to the following closed list:<br>1 - ISO 6166 for ISIN code<br>2 - CUSIP (The Committee on Uniform Securities Identification Procedures number assigned by the CUSIP Service Bureau for U.S. and Canadian companies)<br>3 - SEDOL (Stock Exchange Daily Official List for the London Stock Exchange)<br>4 - WKN (Wertpapier Kenn-Nummer, the alphanumeric German identification number)<br>5 - Bloomberg Ticker (Bloomberg letters code that identify a company's securities)<br>6 - BBGID (The Bloomberg Global ID)<br>7 - Reuters RIC (Reuters instrument code)<br>8 - FIGI (Financial Instrument Global Identifier)<br>9 - Other code by members of the Association of National Numbering Agencies<br>99 - Code attributed by the undertaking  |

element **PRIIPS\_SecurityCodificationType/Code**

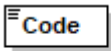
|         |  |
|---------|--|
| diagram |  <p>Value of code in CodificationSystem</p> |
| type    | restriction of <b>xs:string</b>  |

|            |  |
|------------|--|
| properties | isRef 0<br>content simple                            |
| facets     | Kind Value annotation<br>maxLength 255               |
| annotation | documentation<br>Value of code in CodificationSystem |

# complexType PRIIPS\_V2\_NarrativesType

diagram

PRIIPS\_V2\_NarrativesType

- ComprehensionAlert**  
04020-Flag Comprehension Alert
- IntendedTargetMarketRetailInve...**  
04030-Text in reference language:  
  
The description of the type of retail investor to whom the PRIIP is intended to be marketed in the section entitled "What is this product?" of the key information document shall include information on the target retail investors identified by the PRIIP manufacturer, in particular depending on the needs, characteristics and objectives of the type of client for whom the PRIIPs is comparable. The determination shall be based upon the ability of retail investors to bear investment loss and their investment horizon preferences, their theoretical knowledge of, and past experience with PRIIPs, the financial markets as well as the needs, characteristics and objectives of potential end clients.
- InvestmentObjective**  
04040-Text in reference language:  
  
Information stating the objectives of the PRIIP and the means for achieving those objectives in the section entitled "What is this product?" of the key information document shall be summarised in a brief, clear and easily understandable manner. That information shall identify the main factors upon which return depends, the underlying investment assets or reference values, and how the return is determined, as well as the relationship between the PRIIP's return and that of the underlying investment assets or reference values.
- RiskNarrative**  
04050-Text in reference language:  
[insert a brief explanation of the classification of the product with a maximum of 300 characters in plain language]
- OtherMateriallyRelevantRiskNarr...**  
04060-Text in reference language (Element E)  
  
[Where applicable: element h] [Other risks materially relevant to the PRIIP not included in the summary risk indicator to be explained with a maximum of 200 characters]
- TypeUnderlyingInvestmentOption**  
04070-Legal Form like SICAV, OEIC, ...  
Understandable to the customer
- CapitalGuarantee**  
04080-Capital Guarantee
- CapitalGuaranteeLevel**  
04081-Capital Guarantee level.  
Minimum amount will be paid at redemption in%, Cf annex 3, point 7, Element F
- CapitalGuaranteeLimitations**  
04082-The field shall contain well-formulated text which can be used directly by the issuer in the KID according to article 14 of the regulation.
- CapitalGuaranteeEarlyExitCondit...**  
04083-Date before which the early exit conditions apply.
- CapitalGuaranteePortfolio**  
04084-characteristics of the guarantee: open ended or fixed maturity, daily or monthly lockin, monthly reset, constant guarantee, reference value (highest NAV, NAV of start period,...), other particularities, name of the guarantor
- PossibleMaxLoss**  
04085-Possible maximum loss
- DescriptionPastInterval**  
04086 - 04089
- PerformanceFeesCarriedIntere...**  
04090 - Describes the outperformance of your product and shall be a well-formulated text.
- OneOffCostPortfolioEntryCostD...**  
04120 - Description of the entry cost, not more than 300 characters.
- OneOffCostPortfolioExitCostDes...**  
04130 - Description of exit cost, not more than 300 characters.
- OngoingCostsPortfolioManage...**  
04140 - Description of the ongoing cost, not more than 150 characters.
- DoCostsDependOnInvestedAm...**  
04150 - Indicates whether the costs depend on the invested amount.
- CostDependenceExplanation**  
04160 - Describes the dependence of costs on the invested amount, not more than 300 characters

|          |   |
|----------|---|
| children | <a href="#">ComprehensionAlert</a> <a href="#">IntendedTargetMarketRetailInvestor</a> <a href="#">InvestmentObjective</a> <a href="#">RiskNarrative</a> <a href="#">OtherMaterialyRelevantRiskNarrative</a> <a href="#">TypeUnderlyingInvestmentOption</a> <a href="#">CapitalGuarantee</a> <a href="#">CapitalGuaranteeLevel</a> <a href="#">CapitalGuaranteeLimitations</a> <a href="#">CapitalGuaranteeEarlyExitConditions</a> <a href="#">CapitalGuaranteePortfolio</a> <a href="#">PossibleMaxLoss</a> <a href="#">DescriptionPastInterval</a> <a href="#">PerformanceFeesCarriedInterestNarrative</a> <a href="#">OneOffCostPortfolioEntryCostDescription</a> <a href="#">OneOffCostPortfolioExitCostDescription</a> <a href="#">OngoingCostsPortfolioManagementCostsDescription</a> <a href="#">DoCostsDependOnInvestedAmount</a> <a href="#">CostDepenanceExplanation</a> |
| used by  | element <a href="#">PRIIPSType_V20/EPTV2/Narratives</a>   |

element **PRIIPS\_V2\_NarrativesType/ComprehensionAlert**

|            |   |
|------------|---|
| diagram    |   |
| type       | <a href="#">YesNoType</a>                       |
| properties | isRef 0<br>content simple                       |
| annotation | documentation<br>04020-Flag Comprehension Alert |

element **PRIIPS\_V2\_NarrativesType/IntendedTargetMarketRetailInvestor**

|            |   |
|------------|---|
| diagram    |   |
| type       | restriction of <b>xs:string</b>   |
| properties | isRef 0<br>content simple   |
| facets     | Kind Value annotation<br>maxLength 4000   |
| annotation | documentation<br>04030-Text in reference language:<br><br>The description of the type of retail investor to whom the PRIIP is intended to be marketed in the section entitled 'What is this product?' of the key information document shall include information on the target retail investors identified by the PRIIP manufacturer, in particular depending on the needs, characteristics and objectives of the type of client for whom the PRIIPs is compatible. This determination shall be based upon the ability of retail investors to bear investment loss and their investment horizon preferences, their theoretical knowledge of, and past experience with PRIIPs, the financial markets as well as the needs, characteristics and objectives of potential end clients. |

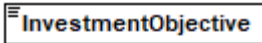

element **PRIIPS\_V2\_NarrativesType/InvestmentObjective**

|            |   |
|------------|---|
| diagram    |  <p>04040-Text in reference language:</p> <p>Information stating the objectives of the PRIIP and the means for achieving those objectives in the section entitled 'What is this product?' of the key information document shall be summarised in a brief, clear and easily understandable manner. That information shall identify the main factors upon which return depends, the underlying investment assets or reference values, and how the return is determined, as well as the relationship between the PRIIP's return and that of the underlying investment assets or reference values.</p> |
| type       | restriction of <b>xs:string</b>   |
| properties | isRef 0<br>content simple   |
| facets     | Kind Value annotation<br>maxLength 8000   |
| annotation | documentation<br>04040-Text in reference language:<br><br>Information stating the objectives of the PRIIP and the means for achieving those objectives in the section entitled 'What is this product?' of the key information document shall be summarised in a brief, clear and easily understandable manner. That information shall identify the main factors upon which return depends, the underlying investment assets or reference values, and how the return is determined, as well as the relationship between the PRIIP's return and that of the underlying investment assets or reference values.   |

element **PRIIPS\_V2\_NarrativesType/RiskNarrative**

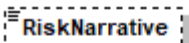
|            |   |
|------------|---|
| diagram    |  <p>04050-Text in reference language:<br/>[insert a brief explanation of the classification of the product with a maximum of 300 characters in plain language]</p> |
| type       | restriction of <b>xs:string</b>   |
| properties | isRef 0<br>minOcc 0<br>maxOcc 1<br>content simple   |
| facets     | Kind Value annotation<br>maxLength 300  |
| annotation | documentation<br>04050-Text in reference language:<br>[insert a brief explanation of the classification of the product with a maximum of 300 characters in plain language]  |

element **PRIIPS\_V2\_NarrativesType/OtherMaterialyRelevantRiskNarrative**

|            |   |
|------------|---|
| diagram    |  <p>04060-Text in reference language (Element E)</p> <p>[Where applicable: element h] [Other risks materially relevant to the PRIIP not included in the summary risk indicator to be explained with a maximum of 200 characters]</p> |
| type       | restriction of <b>xs:string</b>   |
| properties | isRef 0<br>content simple   |
| facets     | Kind Value annotation<br>maxLength 200  |
| annotation | documentation<br>04060-Text in reference language (Element E)   |
|            | [Where applicable: element h] [Other risks materially relevant to the PRIIP not included in the summary risk indicator to be explained with a maximum of 200 characters]  |

element **PRIIPS\_V2\_NarrativesType/TypeUnderlyingInvestmentOption**

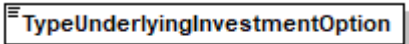
|            |  |
|------------|--|
| diagram    |  <p>04070-Legal Form like SICAV, OEIC, ... Understable to te customer</p> |
| type       | restriction of <b>xs:string</b>  |
| properties | isRef 0<br>content simple  |
| facets     | Kind Value annotation<br>maxLength 300   |
| annotation | documentation<br>04070-Legal Form like SICAV, OEIC, ... Understable to te customer   |

element **PRIIPS\_V2\_NarrativesType/CapitalGuarantee**

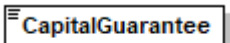
|            |  |
|------------|--|
| diagram    |  <p>04080-Capital Guarantee</p> |
| type       | <a href="#">YesNoType</a>  |
| properties | isRef 0<br>content simple  |
| annotation | documentation<br>04080-Capital Guarantee   |

element **PRIIPS\_V2\_NarrativesType/CapitalGuaranteeLevel**

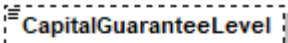
|         |   |
|---------|---|
| diagram |  <p>04081-Capital Guarantee level. Minimum amount will be paid at redemption in%. Cf annex 3, point 7, Element F</p> |
| type    | restriction of <b>xs:decimal</b>  |

|            |   |
|------------|---|
| properties | isRef 0<br>minOcc 0<br>maxOcc 1<br>content simple   |
| facets     | Kind Value annotation<br>minInclusive 0<br>maxInclusive 1   |
| annotation | documentation<br>04081-Capital Guarantee level. Minimum amount will be paid at redemption in%. Cf annex 3, point 7, Element F |

element **PRIIPS\_V2\_NarrativesType/CapitalGuaranteeLimitations**

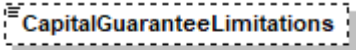
|            |   |
|------------|---|
| diagram    |  <p>04082-The field shall contain well-formulated text which can be used directly by the insurer in the KID according to article 14 of the regulation.</p> |
| type       | restriction of <b>xs:string</b>   |
| properties | isRef 0<br>minOcc 0<br>maxOcc 1<br>content simple   |
| facets     | Kind Value annotation<br>maxLength 300  |
| annotation | documentation<br>04082-The field shall contain well-formulated text which can be used directly by the insurer in the KID according to article 14 of the regulation.   |

element **PRIIPS\_V2\_NarrativesType/CapitalGuaranteeEarlyExitConditions**

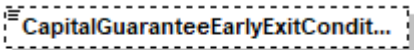
|            |   |
|------------|---|
| diagram    |  <p>04083-Date before which the early exit conditions apply.</p> |
| type       | <b>xs:date</b>  |
| properties | isRef 0<br>minOcc 0<br>maxOcc 1<br>content simple   |
| annotation | documentation<br>04083-Date before which the early exit conditions apply.   |

element **PRIIPS\_V2\_NarrativesType/CapitalGuaranteePortfolio**

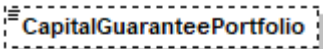
|            |   |
|------------|---|
| diagram    |  <p>04084-characteristics of the guarantee: open ended or fixed maturity, daily or monthly lockin, monthly reset, constant guarantee, reference value (highest NAV, NAV of start period,...), other particularities, name of the guarantor</p> |
| type       | restriction of <b>xs:string</b>   |
| properties | isRef 0<br>minOcc 0   |

|            |   |
|------------|---|
|            | maxOcc 1<br>content simple  |
| facets     | Kind Value annotation<br>maxLength 2500   |
| annotation | documentation<br>04084-characteristics of the guarantee: open ended or fixed maturity, daily or monthly lockin, monthly reset, constant guarantee, reference value (highest NAV, NAV of start period,...), other particularities, name of the guarantor |

element **PRIIPS\_V2\_NarrativesType/PossibleMaxLoss**

|            |   |
|------------|---|
| diagram    |   |
| type       | restriction of <b>xs:decimal</b>                          |
| properties | isRef 0<br>minOcc 0<br>maxOcc 1<br>content simple         |
| facets     | Kind Value annotation<br>minInclusive 0<br>maxInclusive 1 |
| annotation | documentation<br>04085-Possible maximum loss              |

element **PRIIPS\_V2\_NarrativesType/DescriptionPastInterval**

|            |  |
|------------|--|
| diagram    |  |
| properties | isRef 0<br>minOcc 0<br>maxOcc 1<br>content complex   |
| children   | <a href="#">UnfavorableScenario</a> <a href="#">ModerateScenario</a> <a href="#">FavorableScenario</a> |
| annotation | documentation<br>04086 - 04089   |

element **PRIIPS\_V2\_NarrativesType/DescriptionPastInterval/UnfavorableScenario**

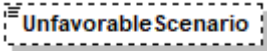
|            |  |
|------------|--|
| diagram    |  <p>04086 - Describes the historical time period the unfavourable scenario corresponds to</p> |
| type       | restriction of <b>xs:string</b>  |
| properties | isRef 0<br>minOcc 0<br>maxOcc 1<br>content simple  |
| facets     | Kind Value annotation<br>maxLength 300   |
| annotation | documentation<br>04086 - Describes the historical time period the unfavourable scenario corresponds to   |

element **PRIIPS\_V2\_NarrativesType/DescriptionPastInterval/ModerateScenario**

|            |  |
|------------|--|
| diagram    |  <p>04087 - Describes the historical time period the moderate scenario corresponds to</p> |
| type       | restriction of <b>xs:string</b>  |
| properties | isRef 0<br>minOcc 0<br>maxOcc 1<br>content simple  |
| facets     | Kind Value annotation<br>maxLength 300   |
| annotation | documentation<br>04087 - Describes the historical time period the moderate scenario corresponds to   |

element **PRIIPS\_V2\_NarrativesType/DescriptionPastInterval/FavorableScenario**

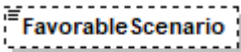
|            |  |
|------------|--|
| diagram    |  <p>00489 - Describes the historical time period the favourable scenario corresponds to</p> |
| type       | restriction of <b>xs:string</b>  |
| properties | isRef 0<br>minOcc 0<br>maxOcc 1<br>content simple  |
| facets     | Kind Value annotation<br>maxLength 300   |
| annotation | documentation<br>00489 - Describes the historical time period the favourable scenario corresponds to   |

element **PRIIPS\_V2\_NarrativesType/PerformanceFeesCarriedInterestNarrative**

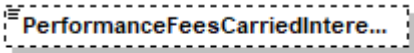
|            |  |
|------------|--|
| diagram    |  <p>04090 - Describes the outperformance of your product and shall be a well-formulated text.</p> |
| type       | restriction of <b>xs:string</b>  |
| properties | isRef 0<br>minOcc 0<br>maxOcc 1<br>content simple  |
| facets     | Kind Value annotation<br>maxLength 300   |
| annotation | documentation<br>04090 - Describes the outperformance of your product and shall be a well-formulated text.   |

element **PRIIPS\_V2\_NarrativesType/OneOffCostPortfolioEntryCostDescription**

|            |   |
|------------|---|
| diagram    |  <p>04120 - Description of the entry cost, not more than 300 characters.</p> |
| type       | restriction of <b>xs:string</b>   |
| properties | isRef 0<br>minOcc 0<br>maxOcc 1<br>content simple   |
| facets     | Kind Value annotation<br>maxLength 300  |
| annotation | documentation<br>04120 - Description of the entry cost, not more than 300 characters.   |

element **PRIIPS\_V2\_NarrativesType/OneOffCostPortfolioExitCostDescription**

|            |  |
|------------|--|
| diagram    |  <p>04130 - Description of exit cost, not more than 300 characters.</p> |
| type       | restriction of <b>xs:string</b>  |
| properties | isRef 0<br>content simple  |
| facets     | Kind Value annotation<br>maxLength 300   |
| annotation | documentation<br>04130 - Description of exit cost, not more than 300 characters.   |

element **PRIIPS\_V2\_NarrativesType/OngoingCostsPortfolioManagementCostsDescription**

|            |   |
|------------|---|
| diagram    |  <p>04140 - Description of the ongoing cost, not more than 150 characters.</p> |
| type       | restriction of <b>xs:string</b>   |
| properties | isRef 0   |

|            |   |
|------------|---|
|            | content simple  |
| facets     | Kind Value annotation<br>maxLength 150  |
| annotation | documentation<br>04140 - Description of the ongoing cost, not more than 150 characters. |

element **PRIIPS\_V2\_NarrativesType/DoCostsDependOnInvestedAmount**

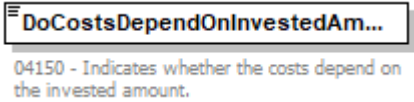
|            |   |
|------------|---|
| diagram    |    |
| type       | <a href="#">YesNoType</a>   |
| properties | isRef 0<br>content simple   |
| annotation | documentation<br>04150 - Indicates whether the costs depend on the invested amount. |

element **PRIIPS\_V2\_NarrativesType/CostDepenanceExplanation**

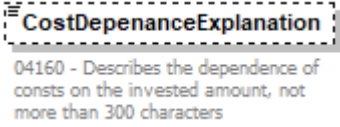
|            |  |
|------------|--|
| diagram    |                                 |
| type       | restriction of <b>xs:string</b>  |
| properties | isRef 0<br>minOcc 0<br>maxOcc 1<br>content simple  |
| facets     | Kind Value annotation<br>maxLength 150   |
| annotation | documentation<br>04160 - Describes the dependence of consts on the invested amount, not more than 300 characters |

complexType **PRIIPS\_V2\_ReturnScenarioType**

|          |   |
|----------|---|
| diagram  | <p><b>OneYear</b><br/>After one year. Mandatory if RHP &gt;1 year. For autocallables only if called after 1y</p> <p><b>HalfRHP</b><br/>After half of the RHP. Mandatory if the RHP</p> <p><b>RHPOrFirstCallDateOrFirstCallDate</b><br/>At the RHP</p> <p><b>AutoCallApplied</b><br/>Indicate if the call has been applied</p> <p><b>AutocallDate</b><br/>End date of the product, call date or maturity corresponding to the moderate scenario of autocallables</p> |
| children | <a href="#">OneYear</a> <a href="#">HalfRHP</a> <a href="#">RHPOrFirstCallDateOrFirstCallDate</a> <a href="#">AutoCallApplied</a> <a href="#">AutocallDate</a>  |
| used by  | elements <a href="#">PRIIPSType_V20/EPTV2/PerformanceScenario/ReturnFavorable</a><br><a href="#">PRIIPSType_V20/EPTV2/PerformanceScenario/ReturnModerate</a><br><a href="#">PRIIPSType_V20/EPTV2/PerformanceScenario/ReturnStress</a><br><a href="#">PRIIPSType_V20/EPTV2/PerformanceScenario/ReturnUnfavorable</a>   |

element **PRIIPS\_V2\_ReturnScenarioType/OneYear**

|            |  |
|------------|--|
| diagram    | <p><b>OneYear</b><br/>After one year. Mandatory if RHP &gt;1 year. For autocallables only if called after 1y</p> |
| type       | <b>xs:decimal</b>  |
| properties | isRef 0<br>minOcc 0<br>maxOcc 1<br>content simple  |
| annotation | documentation<br>After one year. Mandatory if RHP >1 year. For autocallables only if called after 1y             |

element **PRIIPS\_V2\_ReturnScenarioType/HalfRHP**

|            |   |
|------------|---|
| diagram    | <p><b>HalfRHP</b><br/>After half of the RHP. Mandatory if the RHP</p> |
| type       | <b>xs:decimal</b>   |
| properties | isRef 0<br>minOcc 0   |



|            |  |
|------------|--|
|            | maxOcc 1<br>content simple                                   |
| annotation | documentation<br>After half of the RHP. Mandatory if the RHP |

element **PRIIPS\_V2\_ReturnScenarioType/RHPOrFirstCallDateOrFirstCallDate**

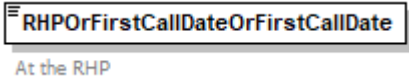
|            |   |
|------------|---|
| diagram    | <br>At the RHP |
| type       | <b>xs:decimal</b>   |
| properties | isRef 0<br>content simple   |
| annotation | documentation<br>At the RHP   |

element **PRIIPS\_V2\_ReturnScenarioType/AutoCallApplied**

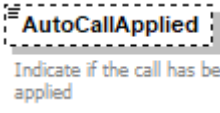
|            |  |
|------------|--|
| diagram    | <br>Indicate if the call has been applied |
| type       | <a href="#">YesNoType</a>  |
| properties | isRef 0<br>minOcc 0<br>maxOcc 1<br>content simple  |
| annotation | documentation<br>Indicate if the call has been applied   |

element **PRIIPS\_V2\_ReturnScenarioType/AutocallDate**

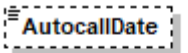
|            |   |
|------------|---|
| diagram    | <br>End date of the product, call date or maturity corresponding to the moderate scenario of autocallables |
| type       | <b>xs:date</b>  |
| properties | isRef 0<br>minOcc 0<br>maxOcc 1<br>content simple   |
| annotation | documentation<br>End date of the product, call date or maturity corresponding to the moderate scenario of autocallables   |

complexType **PRIIPSType**

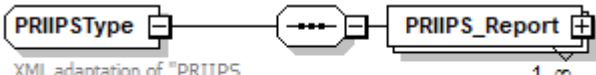
|         |  |
|---------|--|
| diagram | <br>XML adaptation of "PRIIPS Pan European Data Exchange Template" 1..∞ |
|---------|--|

|            |   |
|------------|---|
| children   | <a href="#">PRIIPS Report</a>   |
| used by    | element <a href="#">IndirectReportingType/PRIIPS</a>                            |
| annotation | documentation<br>XML adaptation of "PRIIPS Pan European Data Exchange Template" |

# element PRIIPSType/PRIIPS\_Report

diagram

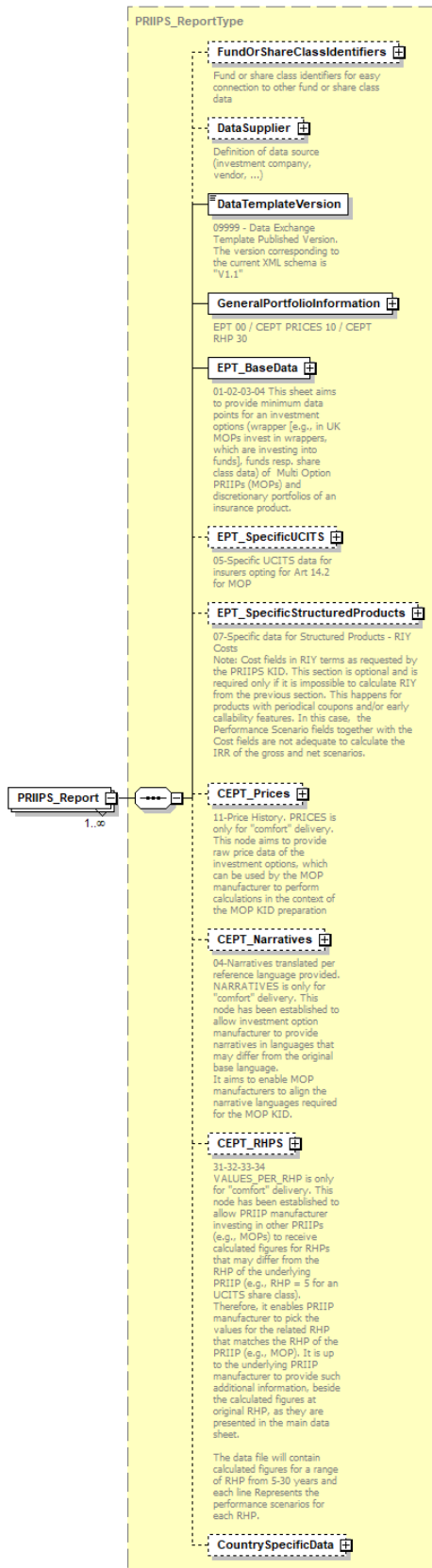

|            |  |
|------------|--|
| type       | <a href="#">PRIIPS_ReportType</a>  |
| properties | isRef 0<br>minOcc 1<br>maxOcc unbounded<br>content complex   |
| children   | <a href="#">FundOrShareClassIdentifiers</a> <a href="#">DataSupplier</a> <a href="#">DataTemplateVersion</a> <a href="#">GeneralPortfolioInformation</a> <a href="#">EPT_BaseData</a><br><a href="#">EPT_SpecificUCITS</a> <a href="#">EPT_SpecificStructuredProducts</a> <a href="#">CEPT_Prices</a> <a href="#">CEPT_Narratives</a> <a href="#">CEPT_RHPS</a><br><a href="#">CountrySpecificData</a> |

complexType **PRIIPSType\_V20**

|          |   |
|----------|---|
| diagram  |   |
| children | <a href="#">EPTV2</a> <a href="#">CEPTV2History</a> <a href="#">CEPTV2Performance</a> |
| used by  | element <a href="#">IndirectReportingType/PRIIPS_V20</a>                              |

element PRIIPSType\_V20/EPTV2

|                   |   |
|-------------------|---|
| <p>diagram</p>    | <p><b>FundOrShareClassIdentifiers</b> </p> <p>Fund or share class identifiers for easy connection to other fund or share class data</p> <p><b>DataSupplier</b> </p> <p>Definition of data source (investment company, vendor, ...)</p> <p><b>DataSetInformation</b> </p> <p>PRIIPs Data Set Information</p> <p><b>GeneralPortfolioInformation</b> </p> <p>EPT 00 / CEPT PRICES 10 / CEPT RHP 30</p> <p><b>RiskAssessment</b> </p> <p>01</p> <p><b>PerformanceScenario</b> </p> <p>02</p> <p><b>Costs</b> </p> <p>03</p> <p><b>Narratives</b> </p> <p>04 - Narratives - mandatory section for underlying options offered in German or Italian MOPs</p> <p><b>AdditionalInformationRequired...</b> </p> <p>07-Additional information required for structured PRIIPs: RIY Costs</p> <p><b>CountrySpecificData</b> </p> |
| <p>properties</p> | <p>isRef 0<br/>content complex</p>  |
| <p>children</p>   | <p><a href="#">FundOrShareClassIdentifiers</a> <a href="#">DataSupplier</a> <a href="#">DataSetInformation</a> <a href="#">GeneralPortfolioInformation</a> <a href="#">RiskAssessment</a> <a href="#">PerformanceScenario</a> <a href="#">Costs</a> <a href="#">Narratives</a> <a href="#">AdditionalInformationRequiredForStructuredPRIIPs</a> <a href="#">CountrySpecificData</a></p>   |

element **PRIIPSType\_V20/EPTV2/FundOrShareClassIdentifiers**

|            |  |
|------------|--|
| diagram    |  |
| type       | <a href="#">FundOrShareClassIdentifiersType</a>  |
| properties | isRef 0<br>minOcc 0<br>maxOcc 1<br>content complex   |
| children   | <a href="#">LEI</a> <a href="#">ISINs</a>  |
| annotation | documentation<br>Fund or share class identifiers for easy connection to other fund or share class data |

element **PRIIPSType\_V20/EPTV2/DataSupplier**

|            |   |
|------------|---|
| diagram    |   |
| type       | <a href="#">DataSupplierType</a>  |
| properties | isRef 0<br>minOcc 0<br>maxOcc 1<br>content complex  |
| children   | <a href="#">SystemCountry</a> <a href="#">Short</a> <a href="#">Name</a> <a href="#">Type</a> <a href="#">Contact</a> |
| annotation | documentation<br>Definition of data source (investment company, vendor, ...)  |

element **PRIIPSType\_V20/EPTV2/DataSetInformation**

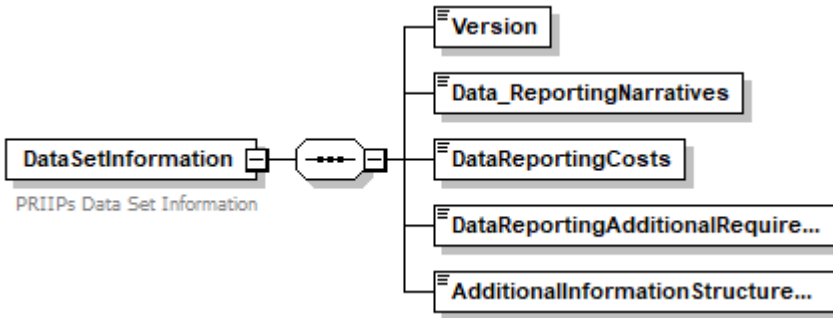
|            |  |
|------------|--|
| diagram    |  <p>The diagram shows a box labeled 'DataSetInformation' with the text 'PRIIPs Data Set Information' below it. To its right is a circle containing four dots. Lines connect this circle to five separate boxes: 'Version', 'Data_ReportingNarratives', 'DataReportingCosts', 'DataReportingAdditionalRequire...', and 'AdditionalInformationStructure...'.</p> |
| properties | isRef 0<br>content complex   |
| children   | <a href="#">Version</a> <a href="#">Data_ReportingNarratives</a> <a href="#">DataReportingCosts</a> <a href="#">DataReportingAdditionalRequirementsGermanMOPs</a> <a href="#">AdditionalInformationStructuredProductsRIY</a>   |
| annotation | documentation<br>PRIIPs Data Set Information   |

element **PRIIPSType\_V20/EPTV2/DataSetInformation/Version**

|            |   |
|------------|---|
| diagram    |  <p>A box labeled 'Version' with a small icon to its left.</p> |
| type       | restriction of <b>xs:string</b>   |
| properties | isRef 0<br>content simple   |

element **PRIIPSType\_V20/EPTV2/DataSetInformation/Data\_ReportingNarratives**

|            |  |
|------------|--|
| diagram    |  <p>A box labeled 'Data_ReportingNarratives' with a small icon to its left.</p> |
| type       | <a href="#">YesNoType</a>  |
| properties | isRef 0<br>content simple  |

element **PRIIPSType\_V20/EPTV2/DataSetInformation/DataReportingCosts**

|            |  |
|------------|--|
| diagram    |  <p>A box labeled 'DataReportingCosts' with a small icon to its left.</p> |
| type       | <a href="#">YesNoType</a>  |
| properties | isRef 0<br>content simple  |

element **PRIIPSType\_V20/EPTV2/DataSetInformation/DataReportingAdditionalRequirementsGermanMOPs**

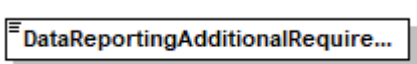
|         |   |
|---------|---|
| diagram |  <p>A box labeled 'DataReportingAdditionalRequire...' with a small icon to its left.</p> |
|---------|---|

|            |                           |
|------------|---------------------------|
| type       | <a href="#">YesNoType</a> |
| properties | isRef 0<br>content simple |

element **PRIIPSType\_V20/EPTV2/DataSetInformation/AdditionalInformationStructuredProductsRIY**

|            |  |
|------------|--|
| diagram    |  <b>AdditionalInformationStructure...</b> |
| type       | <a href="#">YesNoType</a>  |
| properties | isRef 0<br>content simple  |



element **PRIIPSType\_V20/EPTV2/GeneralPortfolioInformation**

diagram

**GeneralPortfolioInformation**  
 EPT 00 / CEPT PRICES 10 / CEPT RHP 30

**PortfolioManufacturerName**

EPT 00010 - (a) entity that manufactures PRIIPs;  
 (b) entity that makes changes to an existing PRIIP including, but not limited to, altering its risk and reward profile or the costs associated with an investment in a PRIIP

**PortfolioManufacturerGroupName**

EPT 00015 - Name of the group PRIIPs manufacturer belongs to

**PortfolioManufacturerLEI**

00016 - Legal Entity Identifier, LEI of the manufacturer of the portfolio

**PortfolioManufacturerEmail**

00017 - Contact entry point for communication with the manufacturer to either provide feed back reporting or to retrieve details on how to provide feed back reporting.

**Portfolio\_Guarantor\_Name**

EPT 00020 - Name of Guarantor of the financial instrument ... i.e. the entity to which the end investor has counterparty risk

**PortfolioID**

EPT 00030 / CEPT PRICES 10020 / C - Use ISIN, CUSIP, BLOOMBERG etc. or internal code. See CodificationSystem. ISIN Preferred when available.

**PortfolioName**

EPT 00050 Name of the Portfolio or name of the CIS

**PortfolioCurrency**

EPT 00060 - Denomination currency of the portfolio

**GeneralReferenceDate**

EPT 00070- Date to which the general data within the EPT refer

**PortfolioPRIIPSCategory**

EPT 00080 PRIIPS Category of the Portfolio (1 to 4)

**FundCICCode**

EPT 00090 - CIC code - Fund (4 digits)

**IsAnAutocallableProduct**

00110 - indication of whether the product is an autocallable

**ReferenceLanguage**

00120 - Language in which the linked website with past performance, the historical performance (02190\_Past\_Performance\_Link and 02200\_Previous\_Performance\_Scenarios\_Calculation\_Link) and all narratives/texts of this set of data are written

|            |  |
|------------|--|
| properties | isRef 0<br>content complex   |
| children   | <a href="#">PortfolioManufacturerName</a> <a href="#">PortfolioManufacturerGroupName</a> <a href="#">PortfolioManufacturerLEI</a><br><a href="#">PortfolioManufacturerEmail</a> <a href="#">Portfolio_Guarantor_Name</a> <a href="#">PortfolioID</a> <a href="#">PortfolioName</a> <a href="#">PortfolioCurrency</a><br><a href="#">GeneralReferenceDate</a> <a href="#">PortfolioPRIIPSCategory</a> <a href="#">FundCICCode</a> <a href="#">IsAnAutocallableProduct</a> <a href="#">ReferenceLanguage</a> |
| annotation | documentation<br>EPT 00 / CEPT PRICES 10 / CEPT RHP 30   |

element **PRIIPSType\_V20/EPTV2/GeneralPortfolioInformation/PortfolioManufacturerName**

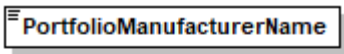
|            |  |
|------------|--|
| diagram    |  <p>EPT 00010 - (a) entity that manufactures PRIIPs;<br/>(b) entity that makes changes to an existing PRIIP including, but not limited to, altering its risk and reward profile or the costs associated with an investment in a PRIIP</p> |
| type       | restriction of <b>xs:string</b>  |
| properties | isRef 0<br>content simple  |
| facets     | Kind Value annotation<br>maxLength 255   |
| annotation | documentation<br>EPT 00010 - (a) entity that manufactures PRIIPs;<br>(b) entity that makes changes to an existing PRIIP including, but not limited to, altering its risk and reward profile or the costs associated with an investment in a PRIIP  |

element **PRIIPSType\_V20/EPTV2/GeneralPortfolioInformation/PortfolioManufacturerGroupName**

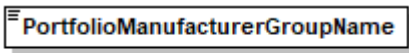
|            |   |
|------------|---|
| diagram    |  <p>EPT 00015 - Name of the group PRIIPs manufacturer belongs to</p> |
| type       | restriction of <b>xs:string</b>   |
| properties | isRef 0<br>content simple   |
| facets     | Kind Value annotation<br>maxLength 255  |
| annotation | documentation<br>EPT 00015 - Name of the group PRIIPs manufacturer belongs to   |

element **PRIIPSType\_V20/EPTV2/GeneralPortfolioInformation/PortfolioManufacturerLEI**

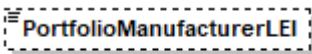
|            |  |
|------------|--|
| diagram    |  <p>00016 - Legal Entity Identifier, LEI of the manufacturer of the portfolio</p> |
| type       | <a href="#">LEICodeType</a>  |
| properties | isRef 0<br>minOcc 0<br>maxOcc 1<br>content simple  |
| facets     | Kind Value annotation<br>minLength 20  |

|            |  |
|------------|--|
|            | maxLength 20<br>pattern ([0-9a-zA-Z]{18}[0-9]{2})  |
| annotation | documentation<br>00016 - Legal Entity Identifier, LEI of the manufacturer of the portfolio |

element **PRIIPSType\_V20/EPTV2/GeneralPortfolioInformation/PortfolioManufacturerEmail**

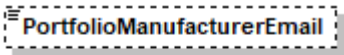
|            |  |
|------------|--|
| diagram    |  <p>00017 - Contact entry point for communication with the manufacturer to either provide feed back reporting or to retrieve details on how to provide feed back reporting.</p> |
| type       | restriction of <b>xs:string</b>  |
| properties | isRef 0<br>minOcc 0<br>maxOcc 1<br>content simple  |
| facets     | Kind Value annotation<br>maxLength 255   |
| annotation | documentation<br>00017 - Contact entry point for communication with the manufacturer to either provide feed back reporting or to retrieve details on how to provide feed back reporting.   |

element **PRIIPSType\_V20/EPTV2/GeneralPortfolioInformation/Portfolio\_Guarantor\_Name**

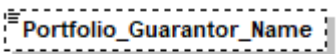
|            |  |
|------------|--|
| diagram    |  <p>EPT 00020 - Name of Guarantor of the financial instrument ... i.e. the entity to which the end investor has counterparty risk</p> |
| type       | restriction of <b>xs:string</b>  |
| properties | isRef 0<br>minOcc 0<br>maxOcc 1<br>content simple  |
| facets     | Kind Value annotation<br>maxLength 255   |
| annotation | documentation<br>EPT 00020 - Name of Guarantor of the financial instrument ... i.e. the entity to which the end investor has counterparty risk   |

element **PRIIPSType\_V20/EPTV2/GeneralPortfolioInformation/PortfolioID**

|                   |   |
|-------------------|---|
| <p>diagram</p>    | <p><b>PortfolioID</b></p> <p>EPT 00030 / CEPT PRICES 10020 / C - Use ISIN, CUSIP, BLOOMBERG etc. or internal code. See CodificationSystem. ISIN Preferred when available.</p> <p><b>PRIIPS_SecurityCodificationType</b></p> <p><b>CodificationSystem</b></p> <p>Codification system used. Integer corresponding to the following closed list:</p> <ul style="list-style-type: none"> <li>1 - ISO 6166 for ISIN code</li> <li>2 - CUSIP (The Committee on Uniform Securities Identification Procedures number assigned by the CUSIP Service Bureau for U.S. and Canadian companies)</li> <li>3 - SEDOL (Stock Exchange Daily Official List for the London Stock Exchange)</li> <li>4 - WKN (Wertpapier Kenn-Nummer, the alphanumeric German identification number)</li> <li>5 - Bloomberg Ticker (Bloomberg letters code that identify a company's securities)</li> <li>6 - BBGID (The Bloomberg Global ID)</li> <li>7 - Reuters RIC (Reuters instrument code)</li> <li>8 - FIGI (Financial Instrument Global Identifier)</li> <li>9 - Other code by members of the Association of National Numbering Agencies</li> <li>99 - Code attributed by the undertaking</li> </ul> <p><b>Code</b></p> <p>Value of code in CodificationSystem</p> |
| <p>type</p>       | <p><a href="#">PRIIPS_SecurityCodificationType</a></p>  |
| <p>properties</p> | <p>isRef 0<br/>content complex</p>  |
| <p>children</p>   | <p><a href="#">CodificationSystem</a> <a href="#">Code</a></p>  |
| <p>annotation</p> | <p>documentation<br/>EPT 00030 / CEPT PRICES 10020 / C - Use ISIN, CUSIP, BLOOMBERG etc. or internal code. See CodificationSystem. ISIN Preferred when available.</p>   |

element **PRIIPSType\_V20/EPTV2/GeneralPortfolioInformation/PortfolioName**

|                   |   |
|-------------------|---|
| <p>diagram</p>    | <p><b>PortfolioName</b></p> <p>EPT 00050 Name of the Portfolio or name of the CIS</p> |
| <p>type</p>       | <p><a href="#">Text256Type</a></p>  |
| <p>properties</p> | <p>isRef 0<br/>content simple</p>   |
| <p>facets</p>     | <p>Kind Value annotation<br/>maxLength 256</p>  |

|            |   |
|------------|---|
| annotation | documentation<br>EPT 00050 Name of the Portfolio or name of the CIS |
|------------|---|

element **PRIIPSType\_V20/EPTV2/GeneralPortfolioInformation/PortfolioCurrency**

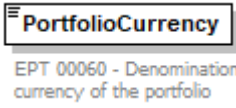
|            |  |
|------------|--|
| diagram    |  <p><b>PortfolioCurrency</b><br/>EPT 00060 - Denomination<br/>currency of the portfolio</p> |
| type       | <a href="#">ISOCurrencyCodeType</a>  |
| properties | isRef 0<br>content simple  |
| facets     | Kind Value annotation<br>minLength 3<br>maxLength 3<br>pattern [A-Z]{3}  |
| annotation | documentation<br>EPT 00060 - Denomination currency of the portfolio  |

element **PRIIPSType\_V20/EPTV2/GeneralPortfolioInformation/GeneralReferenceDate**

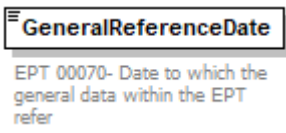
|            |  |
|------------|--|
| diagram    |  <p><b>GeneralReferenceDate</b><br/>EPT 00070- Date to which the<br/>general data within the EPT<br/>refer</p> |
| type       | <b>xs:date</b>   |
| properties | isRef 0<br>content simple  |
| annotation | documentation<br>EPT 00070- Date to which the general data within the EPT refer  |

element **PRIIPSType\_V20/EPTV2/GeneralPortfolioInformation/PortfolioPRIIPSCategory**

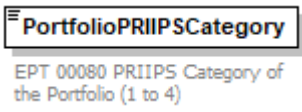
|            |   |
|------------|---|
| diagram    |  <p><b>PortfolioPRIIPSCategory</b><br/>EPT 00080 PRIIPS Category of<br/>the Portfolio (1 to 4)</p> |
| type       | restriction of <b>xs:short</b>  |
| properties | isRef 0<br>content simple   |
| annotation | documentation<br>EPT 00080 PRIIPS Category of the Portfolio (1 to 4)  |

element **PRIIPSType\_V20/EPTV2/GeneralPortfolioInformation/FundCICCode**

|            |  |
|------------|--|
| diagram    |  <p><b>FundCICCode</b><br/>EPT 00090 - CIC code -<br/>Fund (4 digits)</p> |
| type       | restriction of <b>xs:string</b>  |
| properties | isRef 0<br>minOcc 0  |

|            |   |
|------------|---|
|            | maxOcc 1<br>content simple                                    |
| facets     | Kind Value annotation<br>length 4<br>pattern [A-Z]{2}[0-9]{2} |
| annotation | documentation<br>EPT 00090 - CIC code - Fund (4 digits)       |

element **PRIIPSType\_V20/EPTV2/GeneralPortfolioInformation/IsAnAutocallableProduct**

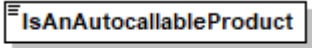
|            |   |
|------------|---|
| diagram    |  <p>00110 - indication of whether the product is an autocallable</p> |
| type       | <a href="#">YesNoType</a>   |
| properties | isRef 0<br>content simple   |
| annotation | documentation<br>00110 - indication of whether the product is an autocallable   |

element **PRIIPSType\_V20/EPTV2/GeneralPortfolioInformation/ReferenceLanguage**

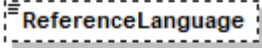
|            |  |
|------------|--|
| diagram    |  <p>00120 - Language in which the linked website with past performance, the historical performance (02190_Past_Performance_Link and 02200_Previous_Performance_Scenarios_Calculation_Link) and all narratives/texts of this set of data are written</p> |
| type       | <b>xs:date</b>   |
| properties | isRef 0<br>minOcc 0<br>maxOcc 1<br>content simple  |
| annotation | documentation<br>00120 - Language in which the linked website with past performance, the historical performance (02190_Past_Performance_Link and 02200_Previous_Performance_Scenarios_Calculation_Link) and all narratives/texts of this set of data are written   |

element **PRIIPSType\_V20/EPTV2/RiskAssessment**

diagram

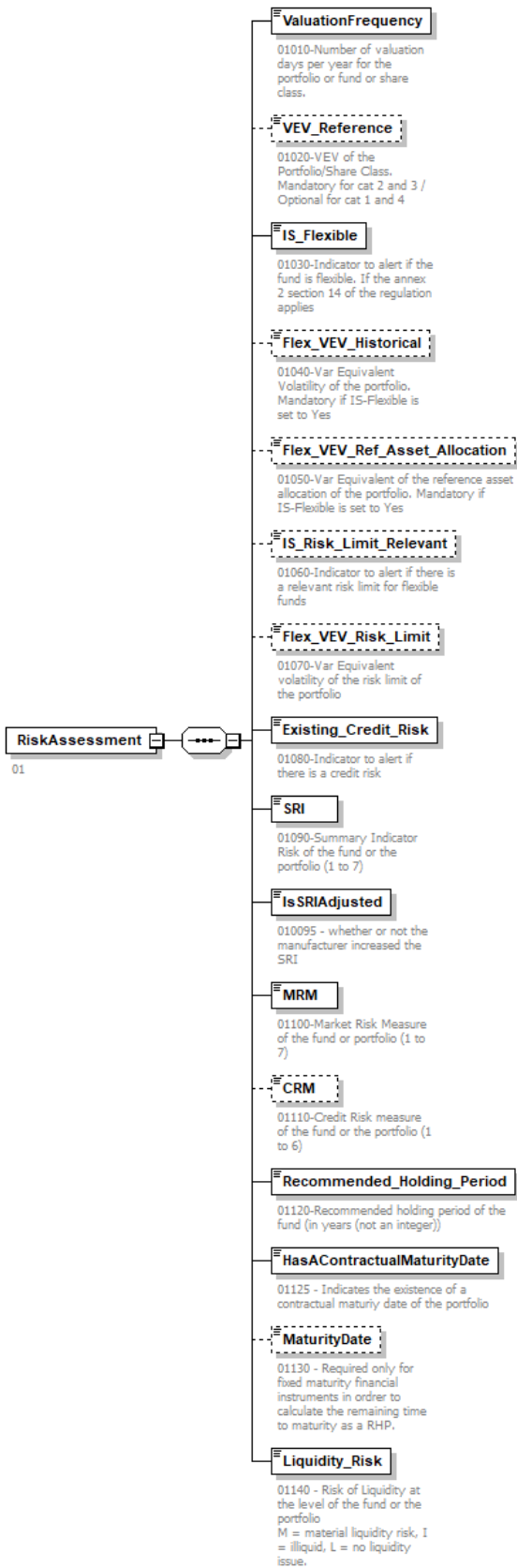



|            |   |
|------------|---|
| properties | isRef 0<br>content complex  |
| children   | <a href="#">ValuationFrequency</a> <a href="#">VEV</a> <a href="#">Reference</a> <a href="#">IS</a> <a href="#">Flexible</a> <a href="#">Flex</a> <a href="#">VEV</a> <a href="#">Historical</a> <a href="#">Flex</a> <a href="#">VEV</a> <a href="#">Ref</a> <a href="#">Asset</a> <a href="#">Allocation</a> <a href="#">IS</a> <a href="#">Risk</a> <a href="#">Limit</a> <a href="#">Relevant</a> <a href="#">Flex</a> <a href="#">VEV</a> <a href="#">Risk</a> <a href="#">Limit</a> <a href="#">Existing</a> <a href="#">Credit</a> <a href="#">Risk</a> <a href="#">SRI</a> <a href="#">IsSRIAdjusted</a> <a href="#">MRM</a> <a href="#">CRM</a> <a href="#">Recommended</a> <a href="#">Holding</a> <a href="#">Period</a> <a href="#">HasAContractualMaturityDate</a> <a href="#">MaturityDate</a> <a href="#">Liquidity</a> <a href="#">Risk</a> |
| annotation | documentation<br>01   |

element **PRIIPSType\_V20/EPTV2/RiskAssessment/ValuationFrequency**

|            |  |
|------------|--|
| diagram    |  <p>01010-Number of valuation days per year for the portfolio or fund or share class.</p> |
| type       | <a href="#">PRIIPSFrequencyType</a>  |
| properties | isRef 0<br>content simple  |
| annotation | documentation<br>01010-Number of valuation days per year for the portfolio or fund or share class.   |

element **PRIIPSType\_V20/EPTV2/RiskAssessment/VEV\_Reference**

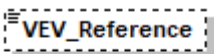
|            |   |
|------------|---|
| diagram    |  <p>01020-VEV of the Portfolio/Share Class. Mandatory for cat 2 and 3 / Optional for cat 1 and 4</p> |
| type       | <b>xs:decimal</b>   |
| properties | isRef 0<br>minOcc 0<br>maxOcc 1<br>content simple   |
| annotation | documentation<br>01020-VEV of the Portfolio/Share Class. Mandatory for cat 2 and 3 / Optional for cat 1 and 4   |

element **PRIIPSType\_V20/EPTV2/RiskAssessment/IS\_Flexible**

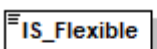
|            |  |
|------------|--|
| diagram    |  <p>01030-Indicator to alert if the fund is flexible. If the annex 2 section 14 of the regulation applies</p> |
| type       | <a href="#">YesNoType</a>  |
| properties | isRef 0<br>content simple  |
| annotation | documentation<br>01030-Indicator to alert if the fund is flexible. If the annex 2 section 14 of the regulation applies   |

element **PRIIPSType\_V20/EPTV2/RiskAssessment/Flex\_VEV\_Historical**

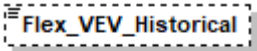
|            |   |
|------------|---|
| diagram    |  <p>01040-Var Equivalent Volatility of the portfolio. Mandatory if IS-Flexible is set to Yes</p> |
| type       | <b>xs:decimal</b>   |
| properties | isRef 0<br>minOcc 0<br>maxOcc 1<br>content simple   |
| annotation | documentation<br>01040-Var Equivalent Volatility of the portfolio. Mandatory if IS-Flexible is set to Yes   |

element **PRIIPSType\_V20/EPTV2/RiskAssessment/Flex\_VEV\_Ref\_Asset\_Allocation**

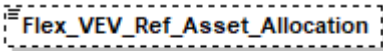
|            |  |
|------------|--|
| diagram    |  <p>01050-Var Equivalent of the reference asset allocation of the portfolio. Mandatory if IS-Flexible is set to Yes</p> |
| type       | <b>xs:decimal</b>  |
| properties | isRef 0<br>minOcc 0<br>maxOcc 1<br>content simple  |
| annotation | documentation<br>01050-Var Equivalent of the reference asset allocation of the portfolio. Mandatory if IS-Flexible is set to Yes   |

element **PRIIPSType\_V20/EPTV2/RiskAssessment/IS\_Risk\_Limit\_Relevant**

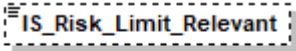
|            |  |
|------------|--|
| diagram    |  <p>01060-Indicator to alert if there is a relevant risk limit for flexible funds</p> |
| type       | <a href="#">YesNoType</a>  |
| properties | isRef 0<br>minOcc 0<br>maxOcc 1<br>content simple  |
| annotation | documentation<br>01060-Indicator to alert if there is a relevant risk limit for flexible funds   |

element **PRIIPSType\_V20/EPTV2/RiskAssessment/Flex\_VEV\_Risk\_Limit**

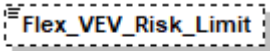
|            |   |
|------------|---|
| diagram    |  <p>01070-Var Equivalent volatility of the risk limit of the portfolio</p> |
| type       | <b>xs:decimal</b>   |
| properties | isRef 0<br>minOcc 0<br>maxOcc 1   |

|            |   |
|------------|---|
|            | content simple  |
| annotation | documentation<br>01070-Var Equivalent volatility of the risk limit of the portfolio |

element **PRIIPSType\_V20/EPTV2/RiskAssessment/Existing\_Credit\_Risk**

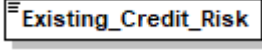
|            |   |
|------------|---|
| diagram    |  <p>01080-Indicator to alert if there is a credit risk</p> |
| type       | <a href="#">YesNoType</a>   |
| properties | isRef 0<br>content simple   |
| annotation | documentation<br>01080-Indicator to alert if there is a credit risk   |

element **PRIIPSType\_V20/EPTV2/RiskAssessment/SRI**

|            |   |
|------------|---|
| diagram    |  <p>01090-Summary Indicator Risk of the fund or the portfolio (1 to 7)</p> |
| type       | restriction of <b>xs:short</b>  |
| properties | isRef 0<br>content simple   |
| annotation | documentation<br>01090-Summary Indicator Risk of the fund or the portfolio (1 to 7)   |

element **PRIIPSType\_V20/EPTV2/RiskAssessment/IsSRIAdjusted**

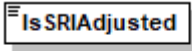
|            |   |
|------------|---|
| diagram    |  <p>010095 - whether or not the manufacturer increased the SRI</p> |
| type       | <a href="#">YesNoType</a>   |
| properties | isRef 0<br>content simple   |
| annotation | documentation<br>010095 - whether or not the manufacturer increased the SRI   |

element **PRIIPSType\_V20/EPTV2/RiskAssessment/MRM**

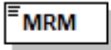
|            |  |
|------------|--|
| diagram    |  <p>01100-Market Risk Measure of the fund or portfolio (1 to 7)</p> |
| type       | restriction of <b>xs:short</b>   |
| properties | isRef 0<br>content simple  |
| annotation | documentation<br>01100-Market Risk Measure of the fund or portfolio (1 to 7)   |

element **PRIIPSType\_V20/EPTV2/RiskAssessment/CRM**

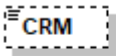
|            |  |
|------------|--|
| diagram    |  <p>01110-Credit Risk measure of the fund or the portfolio (1 to 6)</p> |
| type       | restriction of <b>xs:short</b>   |
| properties | isRef 0<br>minOcc 0<br>maxOcc 1<br>content simple  |
| annotation | documentation<br>01110-Credit Risk measure of the fund or the portfolio (1 to 6)   |

element **PRIIPSType\_V20/EPTV2/RiskAssessment/Recommended\_Holding\_Period**

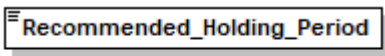
|            |   |
|------------|---|
| diagram    |  <p>01120-Recommended holding period of the fund (in years (not an integer))</p> |
| type       | <b>xs:decimal</b>   |
| properties | isRef 0<br>content simple   |
| annotation | documentation<br>01120-Recommended holding period of the fund (in years (not an integer))   |

element **PRIIPSType\_V20/EPTV2/RiskAssessment/HasAContractualMaturityDate**

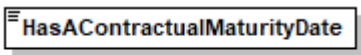
|            |  |
|------------|--|
| diagram    |  <p>01125 - Indicates the existence of a contractual maturity date of the portfolio</p> |
| type       | <a href="#">YesNoType</a>  |
| properties | isRef 0<br>content simple  |
| annotation | documentation<br>01125 - Indicates the existence of a contractual maturity date of the portfolio   |

element **PRIIPSType\_V20/EPTV2/RiskAssessment/MaturityDate**

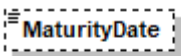
|            |  |
|------------|--|
| diagram    |  <p>01130 - Required only for fixed maturity financial instruments in order to calculate the remaining time to maturity as a RHP.</p> |
| type       | <b>xs:date</b>   |
| properties | isRef 0<br>minOcc 0<br>maxOcc 1<br>content simple  |

|            |  |
|------------|--|
| annotation | documentation<br>01130 - Required only for fixed maturity financial instruments in order to calculate the remaining time to maturity as a RHP. |
|------------|--|

element **PRIIPSType\_V20/EPTV2/RiskAssessment/Liquidity\_Risk**

|            |   |
|------------|---|
| diagram    |  <p>01140 - Risk of Liquidity at the level of the fund or the portfolio<br/>M = material liquidity risk, I = illiquid, L = no liquidity issue.</p> |
| type       | restriction of <b>xs:string</b>   |
| properties | isRef 0<br>content simple   |
| annotation | documentation<br>01140 - Risk of Liquidity at the level of the fund or the portfolio<br>M = material liquidity risk, I = illiquid, L = no liquidity issue.  |

element PRIIPSType\_V20/EPTV2/PerformanceScenario

diagram



|            |   |
|------------|---|
| properties | isRef 0<br>content complex  |
| children   | <a href="#">ReturnUnfavorable</a> <a href="#">ReturnModerate</a> <a href="#">ReturnFavorable</a> <a href="#">ReturnStress</a> <a href="#">NumberOfObservedReturn</a> <a href="#">M0</a> <a href="#">MeanObservedReturns</a> <a href="#">M1</a> <a href="#">ObservedSigma</a> <a href="#">ObservedSkewness</a> <a href="#">ObservedExcessKurtosis</a> <a href="#">ObservedStressedVolatility</a> <a href="#">PortfolioPastPerformanceDisclosureRequired</a> <a href="#">PastPerformanceLink</a> <a href="#">PreviousPerformanceScenariosCalculationLink</a> <a href="#">PastPerformanceNumberOfYears</a> <a href="#">InvestedAmountOtherCurrency</a> |
| annotation | documentation<br>02   |

element **PRIIPSType\_V20/EPTV2/PerformanceScenario/ReturnUnfavorable**

|            |  |
|------------|--|
| diagram    | <pre> classDiagram     class PRIIPS_V2_ReturnScenarioType {         OneYear         HalfRHP         RHPOrFirstCallDateOrFirstCallDate         AutoCallApplied         AutocallDate     }     class ReturnUnfavorable {         02010-02020-02030 Annual return of the portfolio, fund, share class corresponding to the unfavorable scenario.     }     ReturnUnfavorable "1" -- "*" PRIIPS_V2_ReturnScenarioType     ReturnUnfavorable -- OneYear     ReturnUnfavorable -- HalfRHP     ReturnUnfavorable -- RHPOrFirstCallDateOrFirstCallDate     ReturnUnfavorable -- AutoCallApplied     ReturnUnfavorable -- AutocallDate     </pre> <p><b>ReturnUnfavorable</b><br/>02010-02020-02030 Annual return of the portfolio, fund, share class corresponding to the unfavorable scenario.</p> <p><b>PRIIPS_V2_ReturnScenarioType</b></p> <ul style="list-style-type: none"> <li><b>OneYear</b><br/>After one year. Mandatory if RHP &gt; 1 year. For autocallables only if called after 1y</li> <li><b>HalfRHP</b><br/>After half of the RHP. Mandatory if the RHP</li> <li><b>RHPOrFirstCallDateOrFirstCallDate</b><br/>At the RHP</li> <li><b>AutoCallApplied</b><br/>Indicate if the call has been applied</li> <li><b>AutocallDate</b><br/>End date of the product, call date or maturity corresponding to the moderate scenario of autocallables</li> </ul> |
| type       | <a href="#">PRIIPS_V2_ReturnScenarioType</a>   |
| properties | isRef 0<br>content complex   |
| children   | <a href="#">OneYear</a> <a href="#">HalfRHP</a> <a href="#">RHPOrFirstCallDateOrFirstCallDate</a> <a href="#">AutoCallApplied</a> <a href="#">AutocallDate</a>   |
| annotation | documentation<br>02010-02020-02030 Annual return of the portfolio, fund, share class corresponding to the unfavorable scenario.  |

element **PRIIPSType\_V20/EPTV2/PerformanceScenario/ReturnModerate**

|                   |   |
|-------------------|---|
| <p>diagram</p>    | <p><b>ReturnModerate</b><br/>02040-02050-02060 Return of the portfolio, fund, share class corresponding to the moderate scenario</p> <p><b>PRIIPSType_V2_ReturnScenarioType</b></p> <ul style="list-style-type: none"> <li><b>OneYear</b><br/>After one year. Mandatory if RHP &gt; 1 year. For autocallables only if called after 1y</li> <li><b>HalfRHP</b><br/>After half of the RHP. Mandatory if the RHP</li> <li><b>RHPorFirstCallDateOrFirstCallDate</b><br/>At the RHP</li> <li><b>AutoCallApplied</b><br/>Indicate if the call has been applied</li> <li><b>AutocallDate</b><br/>End date of the product, call date or maturity corresponding to the moderate scenario of autocallables</li> </ul> |
| <p>type</p>       | <p><a href="#">PRIIPSType_V2_ReturnScenarioType</a></p>   |
| <p>properties</p> | <p>isRef 0<br/>content complex</p>  |
| <p>children</p>   | <p><a href="#">OneYear</a> <a href="#">HalfRHP</a> <a href="#">RHPorFirstCallDateOrFirstCallDate</a> <a href="#">AutoCallApplied</a> <a href="#">AutocallDate</a></p>   |
| <p>annotation</p> | <p>documentation<br/>02040-02050-02060 Return of the portfolio, fund, share class corresponding to the moderate scenario</p>  |



element **PRIIPSType\_V20/EPTV2/PerformanceScenario/ReturnFavorable**

|                   |  |
|-------------------|--|
| <p>diagram</p>    | <p><b>ReturnFavorable</b><br/>02070-02080-02090 Annual return of the portfolio, fund, share class corresponding to the favorable scenario</p> <p><b>PRIIP_V2_ReturnScenarioType</b></p> <ul style="list-style-type: none"> <li><b>OneYear</b><br/>After one year. Mandatory if RHP &gt;1 year. For autocallables only if called after 1y</li> <li><b>HalfRHP</b><br/>After half of the RHP. Mandatory if the RHP</li> <li><b>RHPorFirstCallDateOrFirstCallDate</b><br/>At the RHP</li> <li><b>AutoCallApplied</b><br/>Indicate if the call has been applied</li> <li><b>AutocallDate</b><br/>End date of the product, call date or maturity corresponding to the moderate scenario of autocallables</li> </ul> |
| <p>type</p>       | <p><a href="#">PRIIP_V2_ReturnScenarioType</a></p>   |
| <p>properties</p> | <p>isRef 0<br/>content complex</p>   |
| <p>children</p>   | <p><a href="#">OneYear</a> <a href="#">HalfRHP</a> <a href="#">RHPorFirstCallDateOrFirstCallDate</a> <a href="#">AutoCallApplied</a> <a href="#">AutocallDate</a></p>  |
| <p>annotation</p> | <p>documentation<br/>02070-02080-02090 Annual return of the portfolio, fund, share class corresponding to the favorable scenario</p>   |

element **PRIIPSType\_V20/EPTV2/PerformanceScenario/ReturnStress**

|                   |  |
|-------------------|--|
| <p>diagram</p>    | <p><b>ReturnStress</b><br/>02100-02110-02120 Annual return of the portfolio, fund, share class corresponding to the stress scenario</p> <p><b>PRIIPS_V2_ReturnScenarioType</b></p> <ul style="list-style-type: none"> <li><b>OneYear</b>: After one year. Mandatory if RHP &gt;1 year. For autocallables only if called after 1y</li> <li><b>HalfRHP</b>: After half of the RHP. Mandatory if the RHP</li> <li><b>RHPorFirstCallDateOrFirstCallDate</b>: At the RHP</li> <li><b>AutoCallApplied</b>: Indicate if the call has been applied</li> <li><b>AutocallDate</b>: End date of the product, call date or maturity corresponding to the moderate scenario of autocallables</li> </ul> |
| <p>type</p>       | <p><a href="#">PRIIPS_V2_ReturnScenarioType</a></p>  |
| <p>properties</p> | <p>isRef 0<br/>content complex</p>   |
| <p>children</p>   | <p><a href="#">OneYear</a> <a href="#">HalfRHP</a> <a href="#">RHPorFirstCallDateOrFirstCallDate</a> <a href="#">AutoCallApplied</a> <a href="#">AutocallDate</a></p>  |
| <p>annotation</p> | <p>documentation<br/>02100-02110-02120 Annual return of the portfolio, fund, share class corresponding to the stress scenario</p>  |

element **PRIIPSType\_V20/EPTV2/PerformanceScenario/NumberOfObservedReturn\_M0**

|                   |   |
|-------------------|---|
| <p>diagram</p>    | <p><b>NumberOfObservedReturn_M0</b><br/>02130-See PRIIPS regulation. Mandatory for PRIIPS cat equals to 2</p> |
| <p>type</p>       | <p><b>xs:decimal</b></p>  |
| <p>properties</p> | <p>isRef 0<br/>minOcc 0<br/>maxOcc 1<br/>content simple</p>   |
| <p>annotation</p> | <p>documentation<br/>02130-See PRIIPS regulation. Mandatory for PRIIPS cat equals to 2</p>                    |

element **PRIIPSType\_V20/EPTV2/PerformanceScenario/MeanObservedReturns\_M1**

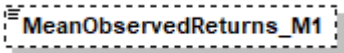
|            |  |
|------------|--|
| diagram    |  <p>02140-See PRIIPS Regulation.<br/>M1. Mandatory for PRIIPS cat equals to 2</p> |
| type       | <b>xs:decimal</b>  |
| properties | <p>isRef 0<br/>minOcc 0<br/>maxOcc 1<br/>content simple</p>  |
| annotation | <p>documentation<br/>02140-See PRIIPS Regulation.<br/>M1. Mandatory for PRIIPS cat equals to 2</p>   |

element **PRIIPSType\_V20/EPTV2/PerformanceScenario/ObservedSigma**

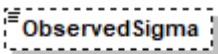
|            |   |
|------------|---|
| diagram    |  <p>02150-See PRIIPS Regulation. Square root of M2. Mandatory for PRIIPS cat equals to 2</p> |
| type       | <b>xs:decimal</b>   |
| properties | <p>isRef 0<br/>minOcc 0<br/>maxOcc 1<br/>content simple</p>   |
| annotation | <p>documentation<br/>02150-See PRIIPS Regulation. Square root of M2. Mandatory for PRIIPS cat equals to 2</p>   |

element **PRIIPSType\_V20/EPTV2/PerformanceScenario/ObservedSkewness**

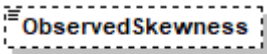
|            |  |
|------------|--|
| diagram    |  <p>02160-See PRIIPS Regulation. Mandatory for PRIIPS cat equals to 2</p> |
| type       | <b>xs:decimal</b>  |
| properties | <p>isRef 0<br/>minOcc 0<br/>maxOcc 1<br/>content simple</p>  |
| annotation | <p>documentation<br/>02160-See PRIIPS Regulation. Mandatory for PRIIPS cat equals to 2</p>   |

element **PRIIPSType\_V20/EPTV2/PerformanceScenario/ObservedExcessKurtosis**

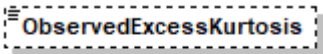
|            |  |
|------------|--|
| diagram    |  <p>02170-See PRIIPS Regulation. Mandatory for PRIIPS cat equals to 2</p> |
| type       | <b>xs:decimal</b>  |
| properties | <p>isRef 0<br/>minOcc 0</p>  |

|            |  |
|------------|--|
|            | maxOcc 1<br>content simple   |
| annotation | documentation<br>02170-See PRIIPS Regulation. Mandatory for PRIIPS cat equals to 2 |

element **PRIIPSType\_V20/EPTV2/PerformanceScenario/ObservedStressedVolatility**

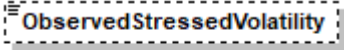
|            |   |
|------------|---|
| diagram    |  <p>02180-Volatility used to calculate stress scenario<br/>stressed volatility applied for stress scenario calculations for &gt;1y</p> |
| type       | <b>xs:decimal</b>   |
| properties | isRef 0<br>minOcc 0<br>maxOcc 1<br>content simple   |
| annotation | documentation<br>02180-Volatility used to calculate stress scenario<br>stressed volatility applied for stress scenario calculations for >1y   |

element **PRIIPSType\_V20/EPTV2/PerformanceScenario/PortfolioPastPerformanceDisclosureRequired**

|            |  |
|------------|--|
| diagram    |  <p>02185-Does this product fulfil conditions sets in Annex VIII number 1 a and b</p> |
| type       | <a href="#">YesNoType</a>  |
| properties | isRef 0<br>content simple  |
| annotation | documentation<br>02185-Does this product fulfil conditions sets in Annex VIII number 1 a and b   |

element **PRIIPSType\_V20/EPTV2/PerformanceScenario/PastPerformanceLink**

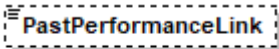
|            |   |
|------------|---|
| diagram    |  <p>02190 - link to the past performance of the fund</p> |
| type       | <b>xs:anyURI</b>  |
| properties | isRef 0<br>minOcc 0<br>maxOcc 1<br>content simple   |
| annotation | documentation<br>02190 - link to the past performance of the fund   |

element **PRIIPSType\_V20/EPTV2/PerformanceScenario/PreviousPerformanceScenariosCalculationLink**

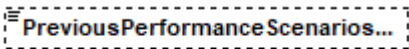
|         |  |
|---------|--|
| diagram |  <p>02200 - Link to the previous calculations</p> |
| type    | <b>xs:anyURI</b>   |

|            |  |
|------------|--|
| properties | isRef 0<br>minOcc 0<br>maxOcc 1<br>content simple          |
| annotation | documentation<br>02200 - Link to the previous calculations |

element **PRIIPSType\_V20/EPTV2/PerformanceScenario/PastPerformanceNumberOfYears**

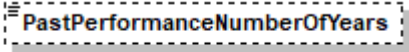
|            |  |
|------------|--|
| diagram    |  <p>02210 - Number of years for which past performance is presented</p> |
| type       | restriction of <b>xs:decimal</b>   |
| properties | isRef 0<br>minOcc 0<br>maxOcc 1<br>content simple  |
| facets     | Kind Value annotation<br>minInclusive 0<br>maxInclusive 10   |
| annotation | documentation<br>02210 - Number of years for which past performance is presented   |

element **PRIIPSType\_V20/EPTV2/PerformanceScenario/InvestedAmountOtherCurrency**

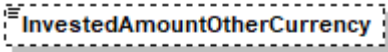
|            |  |
|------------|--|
| diagram    |  <p>02220 - invested amount if the currency of the PRIIP is not EUR as shown in the performance scenarios.<br/>Mandatory if the share class in 00060_Share_Class_Currency is not in EUR.</p> |
| type       | <b>xs:int</b>  |
| properties | isRef 0<br>minOcc 0<br>maxOcc 1<br>content simple  |
| annotation | documentation<br>02220 - invested amount if the currency of the PRIIP is not EUR as shown in the performance scenarios.<br>Mandatory if the share class in 00060_Share_Class_Currency is not in EUR.   |

element **PRIIPSType\_V20/EPTV2/Costs**

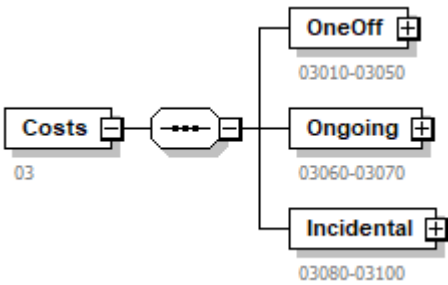
|            |   |
|------------|---|
| diagram    |  <p>The diagram shows a tree structure for the 'Costs' element. The root is 'Costs' (03), which is connected to a container element (represented by a hexagon with four dots). This container element branches into three sub-elements: 'OneOff' (03010-03050), 'Ongoing' (03060-03070), and 'Incidental' (03080-03100). Each sub-element has a '+' icon in its top right corner, indicating it is optional.</p> |
| properties | isRef 0<br>content complex  |

|            |   |
|------------|---|
| children   | <a href="#">OneOff</a> <a href="#">Ongoing</a> <a href="#">Incidental</a> |
| annotation | documentation<br>03   |

element **PRIIPSType\_V20/EPTV2/Costs/OneOff**

|            |  |
|------------|--|
| diagram    | <p>The diagram shows a class <b>OneOff</b> (ID: 03010-03050) on the left. A solid line with an open arrowhead points from <b>OneOff</b> to a composition box (a rectangle with a dashed line and a small square on the right). This composition box is connected to six other classes on the right: <b>EntryCost</b>, <b>EntryCostsAcquired</b>, <b>ExitCostAtRHP</b>, <b>ExitCostOneYear</b>, <b>ExitCostHalfRHP</b>, and <b>SlidingExitCostIndicator</b>. The classes <b>ExitCostOneYear</b> and <b>ExitCostHalfRHP</b> are enclosed in dashed boxes, indicating they are optional or abstract components.</p> <p><b>EntryCost</b><br/>03010-Subscription fees not acquired to the fund or the share class or portfolio mandate. Expressed as a % of the amount to be invested</p> <p><b>EntryCostsAcquired</b><br/>03015-Subscription fees acquired to the fund or the share class or portfolio mandate. Expressed as a % of the amount to be invested</p> <p><b>ExitCostAtRHP</b><br/>03020-Exit fees at the end of RHP for the portfolio or fund or share class. It is expressed as a % of net asset value.</p> <p><b>ExitCostOneYear</b><br/>03030-Exit fees after one year for the portfolio or fund or shar class. It is expressed as a % of net asset value. Mandatory if datapoint Sliding exit cost is Yes.</p> <p><b>ExitCostHalfRHP</b><br/>03040-Exit fees after half of the RHP for the portfolio or fund or shar class. It is expressed as a % of net asset value. Mandatory if datapoint Sliding exit cost is Yes.</p> <p><b>SlidingExitCostIndicator</b><br/>03050-Sliding exit cost indicator</p> |
| properties | isRef 0<br>content complex   |
| children   | <a href="#">EntryCost</a> <a href="#">EntryCostsAcquired</a> <a href="#">ExitCostAtRHP</a> <a href="#">ExitCostOneYear</a> <a href="#">ExitCostHalfRHP</a> <a href="#">SlidingExitCostIndicator</a>  |
| annotation | documentation<br>03010-03050   |

element **PRIIPSType\_V20/EPTV2/Costs/OneOff/EntryCost**

|            |  |
|------------|--|
| diagram    |  <p>03010-Subscription fees not acquired to the fund or the share class or portfolio mandate. Expressed as a % of the amount to be invested</p> |
| type       | restriction of <b>xs:decimal</b>   |
| properties | isRef 0<br>content simple  |
| facets     | Kind Value annotation<br>minInclusive 0  |
| annotation | documentation<br>03010-Subscription fees not acquired to the fund or the share class or portfolio mandate. Expressed as a % of the amount to be invested   |

element **PRIIPSType\_V20/EPTV2/Costs/OneOff/EntryCostsAcquired**

|            |  |
|------------|--|
| diagram    |  <p>03015-Subscription fees acquired to the fund or the share class or portfolio mandate. Expressed as a % of the amount to be invested</p> |
| type       | <b>xs:decimal</b>  |
| properties | isRef 0<br>content simple  |
| annotation | documentation<br>03015-Subscription fees acquired to the fund or the share class or portfolio mandate. Expressed as a % of the amount to be invested   |

element **PRIIPSType\_V20/EPTV2/Costs/OneOff/ExitCostAtRHP**

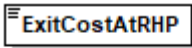
|            |   |
|------------|---|
| diagram    |  <p>03020-Exit fees at the end of RHP for the portfolio or fund or share class. It is expressed as a % of net asset value.</p> |
| type       | restriction of <b>xs:decimal</b>  |
| properties | isRef 0<br>content simple   |
| facets     | Kind Value annotation<br>minInclusive 0   |
| annotation | documentation<br>03020-Exit fees at the end of RHP for the portfolio or fund or share class. It is expressed as a % of net asset value.   |

element **PRIIPSType\_V20/EPTV2/Costs/OneOff/ExitCostOneYear**

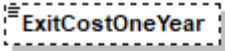
|            |  |
|------------|--|
| diagram    |  <p><b>ExitCostOneYear</b></p> <p>03030-Exit fees after one year for the portfolio or fund or shar class. It is expressed as a % of net asset value. Mandatory if datapoint Sliding exit cost is Yes.</p> |
| type       | restriction of <b>xs:decimal</b>   |
| properties | <p>isRef 0</p> <p>minOcc 0</p> <p>maxOcc 1</p> <p>content simple</p>   |
| facets     | <p>Kind Value annotation</p> <p>minInclusive 0</p>   |
| annotation | <p>documentation</p> <p>03030-Exit fees after one year for the portfolio or fund or shar class. It is expressed as a % of net asset value. Mandatory if datapoint Sliding exit cost is Yes.</p>  |

element **PRIIPSType\_V20/EPTV2/Costs/OneOff/ExitCostHalfRHP**

|            |   |
|------------|---|
| diagram    |  <p><b>ExitCostHalfRHP</b></p> <p>03040-Exit fees after half of the RHP for the portfolio or fund or shar class. It is expressed as a % of net asset value. Mandatory if datapoint Sliding exit cost is Yes.</p> |
| type       | restriction of <b>xs:decimal</b>  |
| properties | <p>isRef 0</p> <p>minOcc 0</p> <p>maxOcc 1</p> <p>content simple</p>  |
| facets     | <p>Kind Value annotation</p> <p>minInclusive 0</p>  |
| annotation | <p>documentation</p> <p>03040-Exit fees after half of the RHP for the portfolio or fund or shar class. It is expressed as a % of net asset value. Mandatory if datapoint Sliding exit cost is Yes.</p>  |

element **PRIIPSType\_V20/EPTV2/Costs/OneOff/SlidingExitCostIndicator**

|            |   |
|------------|---|
| diagram    |  <p><b>SlidingExitCostIndicator</b></p> <p>03050-Sliding exit cost indicator</p> |
| type       | <a href="#">YesNoType</a>   |
| properties | <p>isRef 0</p> <p>content simple</p>  |
| annotation | <p>documentation</p> <p>03050-Sliding exit cost indicator</p>   |



element **PRIIPSType\_V20/EPTV2/Costs/Ongoing**

|            |   |
|------------|---|
| diagram    | <p><b>Ongoing</b><br/>03060-03070</p> <p><b>OtherCost</b><br/>03060-See PRIIPS definition as a % of NAV of the portfolio, the funds or the share class / per annum. Maximum fees, including look through for fund of funds / custodian fees / management fees.</p> <p><b>ManagementCosts</b><br/>03070-Maximum fee. Can be submitted to reduction for some specific commercial agreement between insurers and structurers.</p> <p><b>Transaction</b><br/>03080-See PRIIPS definition as a % of NAV of the portfolio, the funds or the share class / per annum</p> |
| properties | isRef 0<br>content complex  |
| children   | <a href="#">OtherCost</a> <a href="#">ManagementCosts</a> <a href="#">Transaction</a>   |
| annotation | documentation<br>03060-03070  |

element **PRIIPSType\_V20/EPTV2/Costs/Ongoing/OtherCost**

|            |  |
|------------|--|
| diagram    | <p><b>OtherCost</b><br/>03060-See PRIIPS definition as a % of NAV of the portfolio, the funds or the share class / per annum. Maximum fees, including look through for fund of funds / custodian fees / management fees.</p> |
| type       | restriction of <b>xs:decimal</b>   |
| properties | isRef 0<br>content simple  |
| facets     | Kind Value annotation<br>minInclusive 0  |
| annotation | documentation<br>03060-See PRIIPS definition as a % of NAV of the portfolio, the funds or the share class / per annum. Maximum fees, including look through for fund of funds / custodian fees / management fees.            |

element **PRIIPSType\_V20/EPTV2/Costs/Ongoing/ManagementCosts**

|         |   |
|---------|---|
| diagram | <p><b>ManagementCosts</b><br/>03070-Maximum fee. Can be submitted to reduction for some specific commercial agreement between insurers and structurers.</p> |
|---------|---|

|            |  |
|------------|--|
| properties | isRef 0  |
| annotation | documentation<br>03070-Maximum fee. Can be submitted to reduction for some specific commercial agreement between insurers and structurers. |

element **PRIIPSType\_V20/EPTV2/Costs/Ongoing/Transaction**

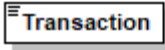
|            |   |
|------------|---|
| diagram    |  <p>03080-See PRIIPS definition as a % of NAV of the portfolio, the funds or the share class / per annum</p> |
| type       | restriction of <b>xs:decimal</b>  |
| properties | isRef 0<br>content simple   |
| facets     | Kind Value annotation<br>minInclusive 0   |
| annotation | documentation<br>03080-See PRIIPS definition as a % of NAV of the portfolio, the funds or the share class / per annum   |

element **PRIIPSType\_V20/EPTV2/Costs/Incidental**

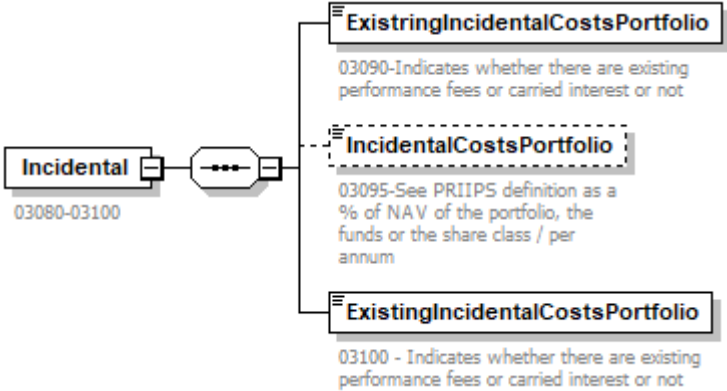
|            |  |
|------------|--|
| diagram    |  <p>03080-03100</p> <p>03090-Indicates whether there are existing performance fees or carried interest or not</p> <p>03095-See PRIIPS definition as a % of NAV of the portfolio, the funds or the share class / per annum</p> <p>03100 - Indicates whether there are existing performance fees or carried interest or not</p> |
| properties | isRef 0<br>content complex   |
| children   | <a href="#">ExistingIncidentalCostsPortfolio</a> <a href="#">IncidentalCostsPortfolio</a> <a href="#">ExistingIncidentalCostsPortfolio</a>   |
| annotation | documentation<br>03080-03100   |

element **PRIIPSType\_V20/EPTV2/Costs/Incidental/ExistingIncidentalCostsPortfolio**

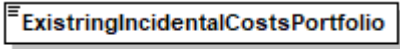
|            |   |
|------------|---|
| diagram    |  <p>03090-Indicates whether there are existing performance fees or carried interest or not</p> |
| type       | <a href="#">YesNoType</a>   |
| properties | isRef 0<br>content simple   |
| annotation | documentation<br>03090-Indicates whether there are existing performance fees or carried interest or not   |

element **PRIIPSType\_V20/EPTV2/Costs/Incidental/IncidentalCostsPortfolio**

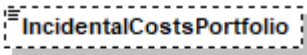
|            |   |
|------------|---|
| diagram    |  <p>03095-See PRIIPS definition as a % of NAV of the portfolio, the funds or the share class / per annum</p> |
| type       | <b>xs:decimal</b>   |
| properties | <p>isRef 0<br/> minOcc 0<br/> maxOcc 1<br/> content simple</p>  |
| annotation | <p>documentation<br/> 03095-See PRIIPS definition as a % of NAV of the portfolio, the funds or the share class / per annum</p>  |

element **PRIIPSType\_V20/EPTV2/Costs/Incidental/ExistingIncidentalCostsPortfolio**

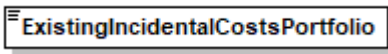
|            |   |
|------------|---|
| diagram    |  <p>03100 - Indicates whether there are existing performance fees or carried interest or not</p> |
| type       | <b>YesNoType</b>  |
| properties | <p>isRef 0<br/> content simple</p>  |
| annotation | <p>documentation<br/> 03100 - Indicates whether there are existing performance fees or carried interest or not</p>  |

# element PRIIPSType\_V20/EPTV2/Narratives

diagram

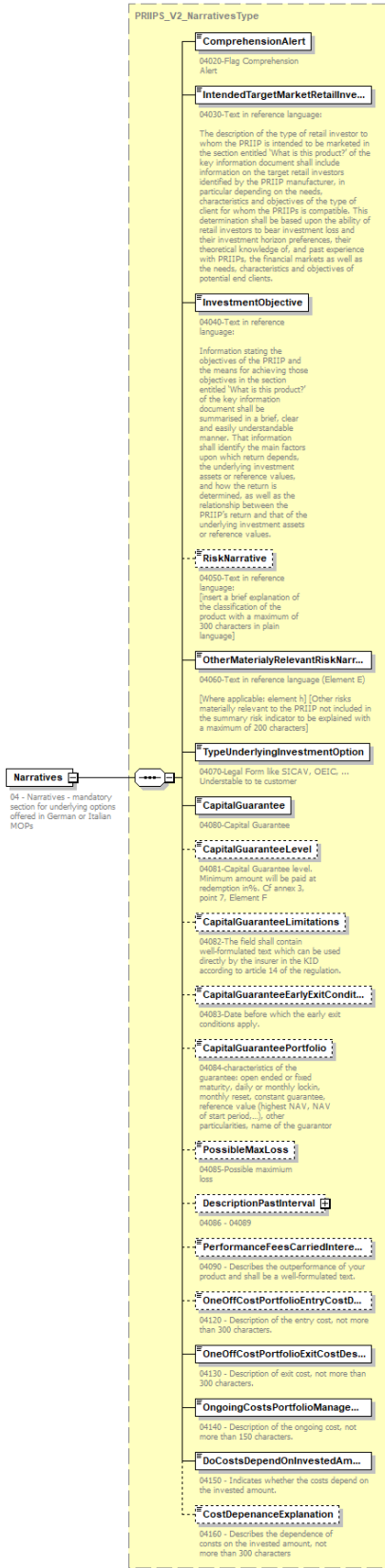

|            |   |
|------------|---|
| type       | <a href="#">PRIIPS V2 NarrativesType</a>  |
| properties | isRef 0<br>content complex  |
| children   | <a href="#">ComprehensionAlert</a> <a href="#">IntendedTargetMarketRetailInvestor</a> <a href="#">InvestmentObjective</a> <a href="#">RiskNarrative</a> <a href="#">OtherMaterialyRelevantRiskNarrative</a> <a href="#">TypeUnderlyingInvestmentOption</a> <a href="#">CapitalGuarantee</a> <a href="#">CapitalGuaranteeLevel</a> <a href="#">CapitalGuaranteeLimitations</a> <a href="#">CapitalGuaranteeEarlyExitConditions</a> <a href="#">CapitalGuaranteePortfolio</a> <a href="#">PossibleMaxLoss</a> <a href="#">DescriptionPastInterval</a> <a href="#">PerformanceFeesCarriedInterestNarrative</a> <a href="#">OneOffCostPortfolioEntryCostDescription</a> <a href="#">OneOffCostPortfolioExitCostDescription</a> <a href="#">OngoingCostsPortfolioManagementCostsDescription</a> <a href="#">DoCostsDependOnInvestedAmount</a> <a href="#">CostDepenanceExplanation</a> |
| annotation | documentation<br>04 - Narratives - mandatory section for underlying options offered in German or Italian MOPs   |

element **PRIIPSType\_V20/EPTV2/AdditionalInformationRequiredForStructuredPRIIPs**

diagram

**AdditionalInformationRequired...**

07-Additional information required for structured PRIIPs: RIY Costs

**FirstPossibleCallDate**

07005 - date of the first possible call for autocallable products

**TotalCost1YearOrFirstCall**

07010-Total cost in 00060\_Share\_Class\_Currency terms in case the investor cashes in after one year, as requested in the "Costs over time" table. Rebased to 1.

**RIY\_1\_YearOrFirstCall**

07020-RIY in case the investor cashes in after one year, as requested in the "Costs over time" table.

**TotalCostHalfRHP**

07030-Total cost in 00060\_Share\_Class\_Currency terms in case the investor cashes in at the middle of the RHP, as requested in the "Costs over time" table.

**RIYHalfRHP**

07040-RIY in case the investor cashes in at the middle of the RHP, as requested in the "Costs over time" table.

**TotalCostRHP**

07050-Total cost in 00060\_Share\_Class\_Currency terms in case the investor cashes in at the RHP, as requested in the "Costs over time" table.

**RIY\_RHP**

07060-RIY in case the investor cashes in at the RHP, as requested in the "Costs over time" table.

**One-off\_costs\_Portfolio\_entry...**

07070 - The entry cost in percentage term at 1Year

**One-off\_costs\_Portfolio\_exit\_co...**

07080-The exit cost in RIY terms, as requested in the "Composition of costs" table.

**Ongoing\_costs\_Portfolio\_transa...**

07090-The portfolio transaction costs in RIY terms, as requested in the "Composition of costs" table.

**OngoingCostsManagementFee...**

07100-The other ongoing costs in RIY terms in percentage term at 1Year (or at RHP if RHP less 1 year), as requested in the narrative part of the "Composition of costs" table

**IncidentalCostsPortfolioPerfor...**

07110-The performance fees in RIY terms, as requested in the "Composition of costs" table.

|            |   |
|------------|---|
| properties | isRef 0<br>minOcc 0<br>maxOcc 1<br>content complex  |
| children   | <a href="#">FirstPossibleCallDate</a> <a href="#">TotalCost1YearOrFirstCall</a> <a href="#">RIY_1_YearOrFirstCall</a> <a href="#">TotalCostHalfRHP</a> <a href="#">RIYHalfRHP</a> <a href="#">TotalCostRHP</a> <a href="#">RIY_RHP</a> <a href="#">One-off costs Portfolio entry cost</a> <a href="#">One-off costs Portfolio exit cost</a> <a href="#">RIY Ongoing costs Portfolio transaction costs</a> <a href="#">OngoingCostsManagementFeesAndOtherAdministrativeOrOperatingCosts</a> <a href="#">IncidentalCostsPortfolioPerformanceFeesCarriedInterest</a> |
| annotation | documentation<br>07-Additional information required for structured PRIIPs: RIY Costs  |

element

**PRIIPSType\_V20/EPTV2/AdditionalInformationRequiredForStructuredPRIIPs/FirstPossibleCallDate**

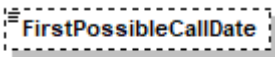
|            |  |
|------------|--|
| diagram    |  <p>07005 - date of the first possible call for autocallable products</p> |
| type       | <b>xs:date</b>   |
| properties | isRef 0<br>minOcc 0<br>maxOcc 1<br>content simple  |
| annotation | documentation<br>07005 - date of the first possible call for autocallable products   |

element

**PRIIPSType\_V20/EPTV2/AdditionalInformationRequiredForStructuredPRIIPs/TotalCost1YearOrFirstCall**

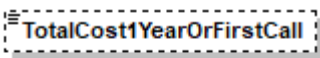
|            |   |
|------------|---|
| diagram    |  <p>07010-Total cost in 00060_Share_Class_Currency terms in case the investor cashes in after one year, as requested in the "Costs over time" table. Rebased to 1.</p> |
| type       | <b>xs:decimal</b>   |
| properties | isRef 0<br>minOcc 0<br>maxOcc 1<br>content simple   |
| annotation | documentation<br>07010-Total cost in 00060_Share_Class_Currency terms in case the investor cashes in after one year, as requested in the "Costs over time" table. Rebased to 1.   |

element

**PRIIPSType\_V20/EPTV2/AdditionalInformationRequiredForStructuredPRIIPs/RIY\_1\_YearOrFirstCall**

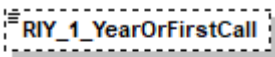
|         |  |
|---------|--|
| diagram |  <p>07020-RIY in case the investor cashes in after one year, as requested in the "Costs over time" table.</p> |
| type    | <b>xs:decimal</b>  |

|            |  |
|------------|--|
| properties | isRef 0<br>minOcc 0<br>maxOcc 1<br>content simple  |
| annotation | documentation<br>07020-RIY in case the investor cashes in after one year, as requested in the "Costs over time" table. |

element **PRIIPSType\_V20/EPTV2/AdditionalInformationRequiredForStructuredPRIIPs/TotalCostHalfRHP**

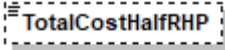
|            |   |
|------------|---|
| diagram    |  <p>07030-Total cost in 00060_Share_Class_Currency terms in case the investor cashes in at the middle of the RHP, as requested in the "Costs over time" table.</p> |
| type       | <b>xs:decimal</b>   |
| properties | isRef 0<br>minOcc 0<br>maxOcc 1<br>content simple   |
| annotation | documentation<br>07030-Total cost in 00060_Share_Class_Currency terms in case the investor cashes in at the middle of the RHP, as requested in the "Costs over time" table.   |

element **PRIIPSType\_V20/EPTV2/AdditionalInformationRequiredForStructuredPRIIPs/RIYHalfRHP**

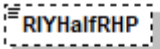
|            |  |
|------------|--|
| diagram    |  <p>07040-RIY in case the investor cashes in at the middle of the RHP, as requested in the "Costs over time" table.</p> |
| type       | <b>xs:decimal</b>  |
| properties | isRef 0<br>minOcc 0<br>maxOcc 1<br>content simple  |
| annotation | documentation<br>07040-RIY in case the investor cashes in at the middle of the RHP, as requested in the "Costs over time" table.   |

element **PRIIPSType\_V20/EPTV2/AdditionalInformationRequiredForStructuredPRIIPs/TotalCostRHP**

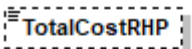
|            |   |
|------------|---|
| diagram    |  <p>07050-Total cost in 00060_Share_Class_Currency terms in case the investor cashes in at the RHP, as requested in the "Costs over time" table.</p> |
| type       | <b>xs:decimal</b>   |
| properties | isRef 0<br>minOcc 0<br>maxOcc 1<br>content simple   |



|            |   |
|------------|---|
| annotation | documentation<br>07050-Total cost in 00060_Share_Class_Currency terms in case the investor cashes in at the RHP, as requested in the "Costs over time" table. |
|------------|---|

element **PRIIPSType\_V20/EPTV2/AdditionalInformationRequiredForStructuredPRIIPs/RIY\_RHP**

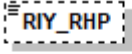
|            |  |
|------------|--|
| diagram    |  <p>07060-RIY in case the investor cashes in at the RHP, as requested in the "Costs over time" table.</p> |
| type       | <b>xs:decimal</b>  |
| properties | isRef 0<br>minOcc 0<br>maxOcc 1<br>content simple  |
| annotation | documentation<br>07060-RIY in case the investor cashes in at the RHP, as requested in the "Costs over time" table.   |

element **PRIIPSType\_V20/EPTV2/AdditionalInformationRequiredForStructuredPRIIPs/One-off\_costs\_Portfolio\_entry\_cost**

|            |   |
|------------|---|
| diagram    |  <p>07070 - The entry cost in percentage term at 1Year</p> |
| type       | <b>xs:decimal</b>   |
| properties | isRef 0<br>minOcc 0<br>maxOcc 1<br>content simple   |
| annotation | documentation<br>07070 - The entry cost in percentage term at 1Year   |

element **PRIIPSType\_V20/EPTV2/AdditionalInformationRequiredForStructuredPRIIPs/One-off\_costs\_Portfolio\_exit\_cost\_RIY**

|            |  |
|------------|--|
| diagram    |  <p>07080-The exit cost in RIY terms, as requested in the "Composition of costs" table.</p> |
| type       | <b>xs:decimal</b>  |
| properties | isRef 0<br>minOcc 0<br>maxOcc 1<br>content simple  |
| annotation | documentation<br>07080-The exit cost in RIY terms, as requested in the "Composition of costs" table.   |

element **PRIIPSType\_V20/EPTV2/AdditionalInformationRequiredForStructuredPRIIPs/Ongoing\_costs\_Portfolio\_**

### transaction\_costs

|            |   |
|------------|---|
| diagram    |  <b>Ongoing_costs_Portfolio_transa...</b><br>07090-The portfolio transaction costs in RIY terms, as requested in the "Composition of costs" table. |
| type       | <b>xs:decimal</b>   |
| properties | isRef 0<br>minOcc 0<br>maxOcc 1<br>content simple   |
| annotation | documentation<br>07090-The portfolio transaction costs in RIY terms, as requested in the "Composition of costs" table.  |

### element

#### PRIIPSType\_V20/EPTV2/AdditionalInformationRequiredForStructuredPRIIPs/OngoingCostsManagementFeesAndOtherAdministrativeOrOperatingCosts

|            |  |
|------------|--|
| diagram    |  <b>OngoingCostsManagementFee...</b><br>07100-The other ongoing costs in RIY terms in percentage term at 1Year (or at RHP if RHP less 1 year), as requested in the narrative part of the "Composition of costs" table |
| type       | <b>xs:decimal</b>  |
| properties | isRef 0<br>minOcc 0<br>maxOcc 1<br>content simple  |
| annotation | documentation<br>07100-The other ongoing costs in RIY terms in percentage term at 1Year (or at RHP if RHP less 1 year), as requested in the narrative part of the "Composition of costs" table   |

### element

#### PRIIPSType\_V20/EPTV2/AdditionalInformationRequiredForStructuredPRIIPs/IncidentalCostsPortfolioPerformanceFeesCarriedInterest

|            |  |
|------------|--|
| diagram    |  <b>IncidentalCostsPortfolioPerfor...</b><br>07110-The performance fees in RIY terms, as requested in the "Composition of costs" table. |
| type       | <b>xs:decimal</b>  |
| properties | isRef 0<br>minOcc 0<br>maxOcc 1<br>content simple  |
| annotation | documentation<br>07110-The performance fees in RIY terms, as requested in the "Composition of costs" table.  |

element **PRIIPSType\_V20/EPTV2/CountrySpecificData**

|            |   |
|------------|---|
| diagram    |   |
| properties | isRef 0<br>minOcc 0<br>maxOcc 1<br>content complex  |
| children   | <a href="#">AT</a> <a href="#">DE</a> <a href="#">DK</a> <a href="#">FR</a> <a href="#">LU</a> <a href="#">NL</a> |

element **PRIIPSType\_V20/EPTV2/CountrySpecificData/AT**

| diagram    |  |            |       |            |           |   |  |
|------------|--|------------|-------|------------|-----------|---|--|
| type       | restriction of <b>xs:string</b>  |            |       |            |           |   |  |
| properties | isRef 0<br>minOcc 0<br>maxOcc 1<br>content simple  |            |       |            |           |   |  |
| facets     | <table border="1"> <thead> <tr> <th>Kind</th> <th>Value</th> <th>annotation</th> </tr> </thead> <tbody> <tr> <td>maxLength</td> <td>0</td> <td></td> </tr> </tbody> </table> | Kind       | Value | annotation | maxLength | 0 |  |
| Kind       | Value  | annotation |       |            |           |   |  |
| maxLength  | 0  |            |       |            |           |   |  |

element **PRIIPSType\_V20/EPTV2/CountrySpecificData/DE**

|            |  |
|------------|--|
| diagram    |  |
| type       | <a href="#">PRIIPS_V2_Country_Specific_DE</a>      |
| properties | isRef 0<br>minOcc 0<br>maxOcc 1<br>content complex |

|            |   |
|------------|---|
| children   | <a href="#">Characteristics CapitalPreservation</a>                 |
| annotation | documentation<br>Specific data for German CAT IV PRIIPs (PIA model) |

element **PRIIPSType\_V20/EPTV2/CountrySpecificData/DK**

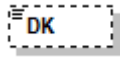
|            |   |
|------------|---|
| diagram    |  |
| type       | restriction of <b>xs:string</b>   |
| properties | isRef 0<br>minOcc 0<br>maxOcc 1<br>content simple                                 |
| facets     | Kind Value annotation<br>maxLength 0  |

element **PRIIPSType\_V20/EPTV2/CountrySpecificData/FR**

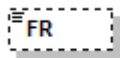
|            |   |
|------------|---|
| diagram    |  |
| type       | restriction of <b>xs:string</b>   |
| properties | isRef 0<br>minOcc 0<br>maxOcc 1<br>content simple                                 |
| facets     | Kind Value annotation<br>maxLength 0  |

element **PRIIPSType\_V20/EPTV2/CountrySpecificData/LU**

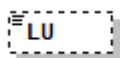
|            |   |
|------------|---|
| diagram    |  |
| type       | restriction of <b>xs:string</b>   |
| properties | isRef 0<br>minOcc 0<br>maxOcc 1<br>content simple                                   |
| facets     | Kind Value annotation<br>maxLength 0  |

element **PRIIPSType\_V20/EPTV2/CountrySpecificData/NL**

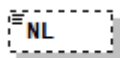
|            |   |
|------------|---|
| diagram    |  |
| type       | restriction of <b>xs:string</b>   |
| properties | isRef 0<br>minOcc 0<br>maxOcc 1<br>content simple                                   |
| facets     | Kind Value annotation<br>maxLength 0  |

element PRIIPSType\_V20/CEPTV2History

|                   |   |
|-------------------|---|
| <p>diagram</p>    | <pre> classDiagram     class CEPTV2HistoryType {         FundOrShareClassIdentifiers         DataSupplier         DataTemplateVersion         GeneralPortfolioInformation         CEPTPrices     }     class CEPTV2History     CEPTV2HistoryType -- CEPTV2History     </pre> <p><b>CEPTV2HistoryType</b></p> <ul style="list-style-type: none"> <li><b>FundOrShareClassIdentifiers</b> +<br/>Fund or share class identifiers for easy connection to other fund or share class data</li> <li><b>DataSupplier</b> +<br/>Definition of data source (investment company, vendor, ...)</li> <li><b>DataTemplateVersion</b><br/>10001_CEPT_Version<br/>This field specifies the version of the template and is used by the recipient to understand the number of fields expected, their labelling and order.</li> <li><b>GeneralPortfolioInformation</b> +</li> <li><b>CEPTPrices</b> +<br/>Price History (if not available, proxy or benchmark)</li> </ul> <p><b>CEPTV2History</b></p> |
| <p>type</p>       | <p><a href="#">CEPTV2HistoryType</a></p>  |
| <p>properties</p> | <p>isRef 0<br/>minOcc 0<br/>maxOcc 1<br/>content complex</p>  |
| <p>children</p>   | <p><a href="#">FundOrShareClassIdentifiers</a> <a href="#">DataSupplier</a> <a href="#">DataTemplateVersion</a> <a href="#">GeneralPortfolioInformation</a> <a href="#">CEPTPrices</a></p>  |

element **PRIIPSType\_V20/CEPTV2Performance**

|                   |   |
|-------------------|---|
| <p>diagram</p>    | <p><b>CEPTV2PerformanceType</b></p> <ul style="list-style-type: none"> <li><b>FundOrShareClassIdentifiers</b> (+)             <p>Fund or share class identifiers for easy connection to other fund or share class data</p> </li> <li><b>DataSupplier</b> (+)             <p>Definition of data source (investment company, vendor, ...)</p> </li> <li><b>DataTemplateVersion</b> <p>30001_CEPT_Version</p> </li> <li><b>GeneralPortfolioInformation</b> (+)</li> <li><b>CEPTRHPS</b> (+)             <p>31-32-33-34<br/>VALUES_PER_RHP is only for "comfort" delivery. This node has been established to allow PRIIP manufacturer investing in other PRIIPs (e.g., MOPs) to receive calculated figures for RHPs that may differ from the RHP of the underlying PRIIP (e.g., RHP = 5 for an UCITS share class). Therefore, it enables PRIIP manufacturer to pick the values for the related RHP that matches the RHP of the PRIIP (e.g., MOP). It is up to the underlying PRIIP manufacturer to provide such additional information, beside the calculated figures at original RHP, as they are presented in the main data sheet.</p> <p>The data file will contain calculated figures for a range of RHP from 5-30 years and each line Represents the performance scenarios for each RHP.</p> </li> </ul> |
| <p>type</p>       | <p><a href="#">CEPTV2PerformanceType</a></p>  |
| <p>properties</p> | <p>isRef 0<br/>minOcc 0<br/>maxOcc 1<br/>content complex</p>  |
| <p>children</p>   | <p><a href="#">FundOrShareClassIdentifiers</a> <a href="#">DataSupplier</a> <a href="#">DataTemplateVersion</a> <a href="#">GeneralPortfolioInformation</a> <a href="#">CEPTRHPS</a></p>  |

simpleType **PRIIPSType/PRIIPFrequencyType**

|             |  |
|-------------|--|
| <p>type</p> | <p>restriction of <code>xs:nonNegativeInteger</code></p> |
|-------------|--|

|            |   |
|------------|---|
| properties | base <a href="#">xs:nonNegativeInteger</a>  |
| used by    | elements <a href="#">PRIIPS_ReportType/EPT_BaseData/RiskAssessment/ValuationFrequency</a><br><a href="#">PRIIPSType_V20/EPTV2/RiskAssessment/ValuationFrequency</a> |
| annotation | documentation<br>Coupon Frequency: 0 other than 1 Annual, 2 Semestrial, 4 Quarterly, 12 Monthly   |

### complexType **CodificationType**

|            |  |
|------------|--|
| diagram    |  |
| children   | <a href="#">CodificationSystem</a> <a href="#">Code</a>  |
| used by    | element <a href="#">SIIPositionType/InterestRateInstrumentCharacteristics/VariableRate/IndexID</a> |
| annotation | documentation<br>CodificationSystem (non restricted list) and Code expressed in CodificationSystem |

### element **CodificationType/CodificationSystem**

|            |   |
|------------|---|
| diagram    |   |
| type       | <b>xs:string</b>                                  |
| properties | isRef 0<br>minOcc 0<br>maxOcc 1<br>content simple |
| annotation | documentation<br>Codification system used.        |

### element **CodificationType/Code**

|            |  |
|------------|--|
| diagram    |  |
| type       | <b>xs:string</b>                                     |
| properties | isRef 0<br>content simple                            |
| annotation | documentation<br>Value of code in CodificationSystem |

### complexType CodificationType\_V5

|            |  |
|------------|--|
| diagram    | <p>CodificationType_V5<br/>CodificationSystem (non restricted list) and Code expressed in CodificationSystem</p> <p>CodificationSystem<br/>Codification system used.</p> <p>Code<br/>Value of code in CodificationSystem</p> |
| children   | <a href="#">CodificationSystem</a> <a href="#">Code</a>  |
| used by    | elements <a href="#">SIIPositionType_V6/InterestRateInstrumentCharacteristics/VariableRate/IndexID</a><br><a href="#">SIIPositionType_V5/InterestRateInstrumentCharacteristics/VariableRate/IndexID</a>                      |
| annotation | documentation<br>CodificationSystem (non restricted list) and Code expressed in CodificationSystem   |

### element CodificationType\_V5/CodificationSystem

|            |   |
|------------|---|
| diagram    | <p>CodificationSystem<br/>Codification system used.</p> |
| type       | <b>xs:string</b>  |
| properties | isRef 0<br>minOcc 0<br>maxOcc 1<br>content simple       |
| annotation | documentation<br>Codification system used.              |

### element CodificationType\_V5/Code

|            |  |
|------------|--|
| diagram    | <p>Code<br/>Value of code in CodificationSystem</p>  |
| type       | <b>xs:string</b>                                     |
| properties | isRef 0<br>content simple                            |
| annotation | documentation<br>Value of code in CodificationSystem |

### complexType CodificationType\_V6

|            |  |
|------------|--|
| diagram    | <p>CodificationType_V6<br/>CodificationSystem (non restricted list) and Code expressed in CodificationSystem</p> <p>CodificationSystem<br/>Codification system used.</p> <p>Code<br/>Value of code in CodificationSystem</p> |
| children   | <a href="#">CodificationSystem</a> <a href="#">Code</a>  |
| annotation | documentation<br>CodificationSystem (non restricted list) and Code expressed in CodificationSystem   |

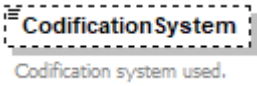

element **CodificationType\_V6/CodificationSystem**

|            |   |
|------------|---|
| diagram    |  |
| type       | <b>xs:string</b>  |
| properties | isRef 0<br>minOcc 0<br>maxOcc 1<br>content <b>simple</b>                          |
| annotation | documentation<br>Codification system used.  |

element **CodificationType\_V6/Code**

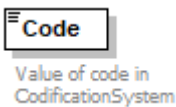
|            |   |
|------------|---|
| diagram    |  |
| type       | <b>xs:string</b>  |
| properties | isRef 0<br>content <b>simple</b>  |
| annotation | documentation<br>Value of code in CodificationSystem                              |

## complexType ContributionToSCRTYPE

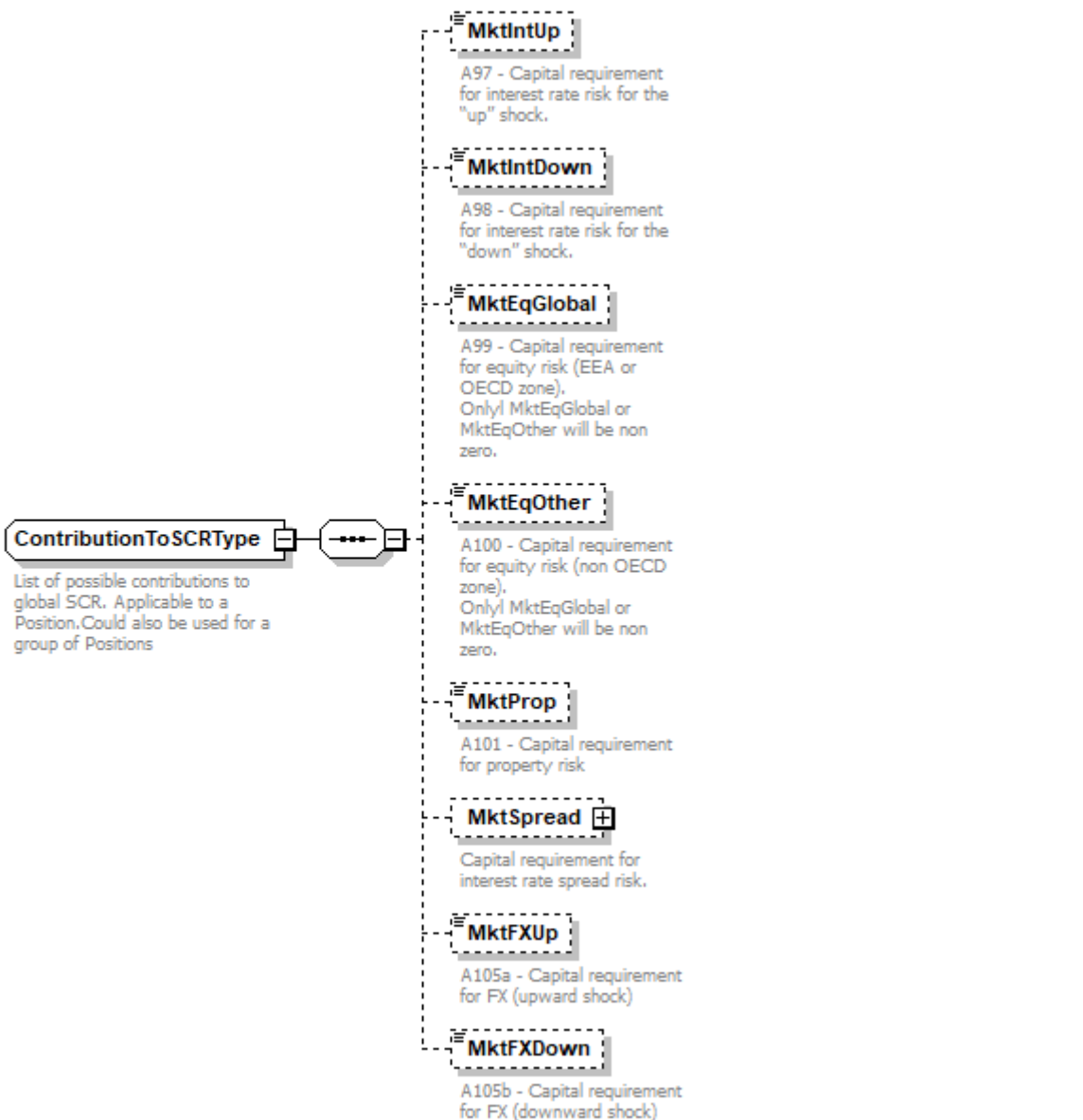
|                |  |
|----------------|--|
| <p>diagram</p> |  <p><b>ContributionToSCRTYPE</b></p> <p>List of possible contributions to global SCR. Applicable to a Position. Could also be used for a group of Positions</p> <ul style="list-style-type: none"> <li><b>MktIntUp</b><br/>A97 - Capital requirement for interest rate risk for the "up" shock.</li> <li><b>MktIntDown</b><br/>A98 - Capital requirement for interest rate risk for the "down" shock.</li> <li><b>MktEqGlobal</b><br/>A99 - Capital requirement for equity risk (EEA or OECD zone). Only MktEqGlobal or MktEqOther will be non zero.</li> <li><b>MktEqOther</b><br/>A100 - Capital requirement for equity risk (non OECD zone). Only MktEqGlobal or MktEqOther will be non zero.</li> <li><b>MktProp</b><br/>A101 - Capital requirement for property risk</li> <li><b>MktSpread</b><br/>Capital requirement for interest rate spread risk.</li> <li><b>MktFXUp</b><br/>A105a - Capital requirement for FX (upward shock)</li> <li><b>MktFXDown</b><br/>A105b - Capital requirement for FX (downward shock)</li> </ul> |
| children       | <a href="#">MktIntUp</a> <a href="#">MktIntDown</a> <a href="#">MktEqGlobal</a> <a href="#">MktEqOther</a> <a href="#">MktProp</a> <a href="#">MktSpread</a> <a href="#">MktFXUp</a> <a href="#">MktFXDown</a>   |
| used by        | elements <a href="#">SIIPositionType V6/ContributionToSCR</a> <a href="#">SIIPositionType/ContributionToSCR</a><br><a href="#">SIIPositionType V5/ContributionToSCR</a>  |
| annotation     | documentation<br>List of possible contributions to global SCR. Applicable to a Position. Could also be used for a group of Positions   |

## element ContributionToSCRTYPE/MktIntUp

|                |  |
|----------------|--|
| <p>diagram</p> |  <p><b>MktIntUp</b></p> <p>A97 - Capital requirement for interest rate risk for the "up" shock.</p> |
| type           | <b>xs:decimal</b>  |

|            |   |
|------------|---|
| properties | isRef 0<br>minOcc 0<br>maxOcc 1<br>content simple                                     |
| annotation | documentation<br>A97 - Capital requirement for interest rate risk for the "up" shock. |

element **ContributionToSCRTType/MktIntDown**

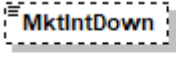
|            |   |
|------------|---|
| diagram    |  <p>A98 - Capital requirement for interest rate risk for the "down" shock.</p> |
| type       | <b>xs:decimal</b>   |
| properties | isRef 0<br>minOcc 0<br>maxOcc 1<br>content simple   |
| annotation | documentation<br>A98 - Capital requirement for interest rate risk for the "down" shock.   |

element **ContributionToSCRTType/MktEqGlobal**

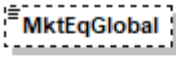
|            |  |
|------------|--|
| diagram    |  <p>A99 - Capital requirement for equity risk (EEA or OECD zone).<br/>Onlyl MktEqGlobal or MktEqOther will be non zero.</p> |
| type       | <b>xs:decimal</b>  |
| properties | isRef 0<br>minOcc 0<br>maxOcc 1<br>content simple  |
| annotation | documentation<br>A99 - Capital requirement for equity risk (EEA or OECD zone).<br>Onlyl MktEqGlobal or MktEqOther will be non zero.  |

element **ContributionToSCRTType/MktEqOther**

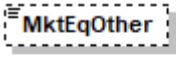
|            |  |
|------------|--|
| diagram    |  <p>A100 - Capital requirement for equity risk (non OECD zone).<br/>Onlyl MktEqGlobal or MktEqOther will be non zero.</p> |
| type       | <b>xs:decimal</b>  |
| properties | isRef 0<br>minOcc 0<br>maxOcc 1<br>content simple  |
| annotation | documentation<br>A100 - Capital requirement for equity risk (non OECD zone).<br>Onlyl MktEqGlobal or MktEqOther will be non zero.  |

element **ContributionToSCRTType/MktProp**

|            |  |
|------------|--|
| diagram    |  <p><b>MktProp</b><br/>A101 - Capital requirement for property risk</p> |
| type       | <b>xs:decimal</b>  |
| properties | isRef 0<br>minOcc 0<br>maxOcc 1<br>content simple  |
| annotation | documentation<br>A101 - Capital requirement for property risk  |

element **ContributionToSCRTType/MktSpread**

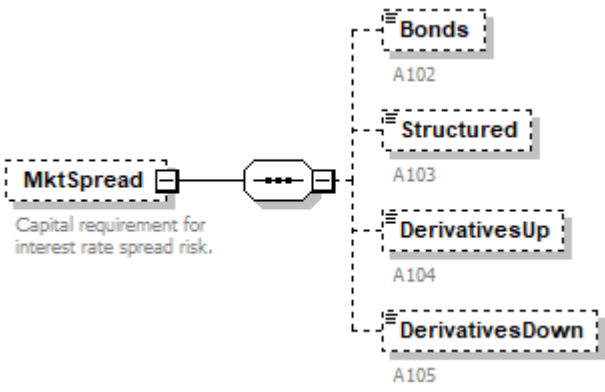
|            |  |
|------------|--|
| diagram    |  <p><b>MktSpread</b><br/>Capital requirement for interest rate spread risk.</p> <p>The diagram shows a central <b>MktSpread</b> element connected to a container element, which in turn contains four sub-elements: <b>Bonds</b> (A102), <b>Structured</b> (A103), <b>DerivativesUp</b> (A104), and <b>DerivativesDown</b> (A105).</p> |
| properties | isRef 0<br>minOcc 0<br>maxOcc 1<br>content complex   |
| children   | <a href="#">Bonds</a> <a href="#">Structured</a> <a href="#">DerivativesUp</a> <a href="#">DerivativesDown</a>   |
| annotation | documentation<br>Capital requirement for interest rate spread risk.  |

element **ContributionToSCRTType/MktSpread/Bonds**

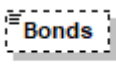
|            |  |
|------------|--|
| diagram    |  <p><b>Bonds</b><br/>A102</p> |
| type       | <b>xs:decimal</b>  |
| properties | isRef 0<br>minOcc 0<br>maxOcc 1<br>content simple  |
| annotation | documentation<br>A102  |

element **ContributionToSCRTType/MktSpread/Structured**

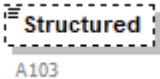
|            |   |
|------------|---|
| diagram    |  |
| type       | <b>xs:decimal</b>   |
| properties | isRef 0<br>minOcc 0<br>maxOcc 1<br>content simple                                 |
| annotation | documentation<br>A103   |

element **ContributionToSCRTType/MktSpread/DerivativesUp**

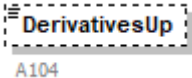
|            |   |
|------------|---|
| diagram    |  |
| type       | <b>xs:decimal</b>   |
| properties | isRef 0<br>minOcc 0<br>maxOcc 1<br>content simple                                 |
| annotation | documentation<br>A104   |

element **ContributionToSCRTType/MktSpread/DerivativesDown**

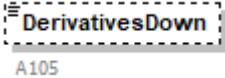
|            |   |
|------------|---|
| diagram    |  |
| type       | <b>xs:decimal</b>   |
| properties | isRef 0<br>minOcc 0<br>maxOcc 1<br>content simple                                   |
| annotation | documentation<br>A105   |

element **ContributionToSCRTType/MktFXUp**

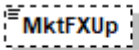
|            |   |
|------------|---|
| diagram    | <br>A105a - Capital requirement<br>for FX (upward shock) |
| type       | <b>xs:decimal</b>   |
| properties | isRef 0<br>minOcc 0<br>maxOcc 1<br>content simple   |
| annotation | documentation<br>A105a - Capital requirement for FX (upward shock)  |

element **ContributionToSCRTType/MktFXDown**

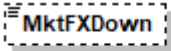
|            |  |
|------------|--|
| diagram    |  <p>A105b - Capital requirement for FX (downward shock)</p> |
| type       | <b>xs:decimal</b>  |
| properties | isRef 0<br>minOcc 0<br>maxOcc 1<br>content simple  |
| annotation | documentation<br>A105b - Capital requirement for FX (downward shock)   |

complexType **ContributionToSCRTType\_V5**

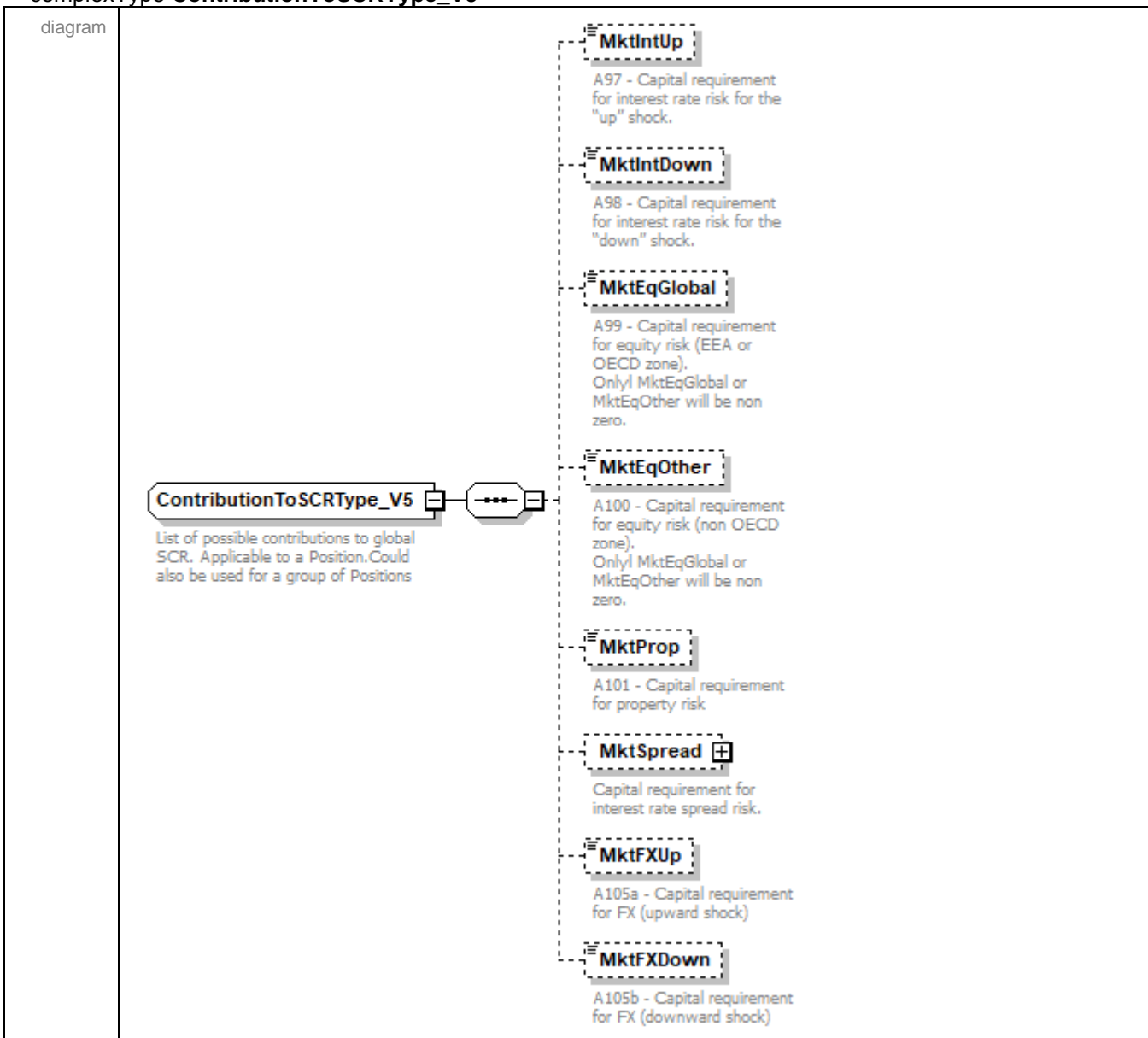

|            |  |
|------------|--|
| children   | <a href="#">MktIntUp</a> <a href="#">MktIntDown</a> <a href="#">MktEqGlobal</a> <a href="#">MktEqOther</a> <a href="#">MktProp</a> <a href="#">MktSpread</a> <a href="#">MktFXUp</a> <a href="#">MktFXDown</a> |
| annotation | documentation<br>List of possible contributions to global SCR. Applicable to a Position. Could also be used for a group of Positions   |

#### element **ContributionToSCRTType\_V5/MktIntUp**

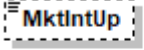
|            |   |
|------------|---|
| diagram    |  <p>A97 - Capital requirement for interest rate risk for the "up" shock.</p> |
| type       | <b>xs:decimal</b>   |
| properties | isRef 0<br>minOcc 0<br>maxOcc 1<br>content simple   |
| annotation | documentation<br>A97 - Capital requirement for interest rate risk for the "up" shock.   |

#### element **ContributionToSCRTType\_V5/MktIntDown**

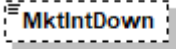
|            |   |
|------------|---|
| diagram    |  <p>A98 - Capital requirement for interest rate risk for the "down" shock.</p> |
| type       | <b>xs:decimal</b>   |
| properties | isRef 0<br>minOcc 0<br>maxOcc 1<br>content simple   |
| annotation | documentation<br>A98 - Capital requirement for interest rate risk for the "down" shock.   |

#### element **ContributionToSCRTType\_V5/MktEqGlobal**

|            |   |
|------------|---|
| diagram    |  <p>A99 - Capital requirement for equity risk (EEA or OECD zone). Only MktEqGlobal or MktEqOther will be non zero.</p> |
| type       | <b>xs:decimal</b>   |
| properties | isRef 0<br>minOcc 0<br>maxOcc 1<br>content simple   |
| annotation | documentation<br>A99 - Capital requirement for equity risk (EEA or OECD zone). Only MktEqGlobal or MktEqOther will be non zero.   |

element **ContributionToSCRTType\_V5/MktEqOther**

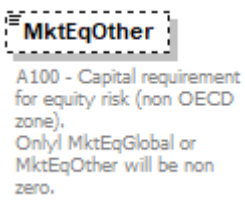
|            |  |
|------------|--|
| diagram    |   |
| type       | <b>xs:decimal</b>  |
| properties | isRef 0<br>minOcc 0<br>maxOcc 1<br>content simple  |
| annotation | documentation<br>A100 - Capital requirement for equity risk (non OECD zone).<br>Only MktEqGlobal or MktEqOther will be non zero. |

element **ContributionToSCRTType\_V5/MktProp**

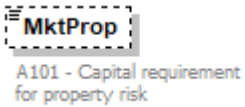
|            |   |
|------------|---|
| diagram    |  |
| type       | <b>xs:decimal</b>   |
| properties | isRef 0<br>minOcc 0<br>maxOcc 1<br>content simple                                 |
| annotation | documentation<br>A101 - Capital requirement for property risk                     |

element **ContributionToSCRTType\_V5/MktSpread**

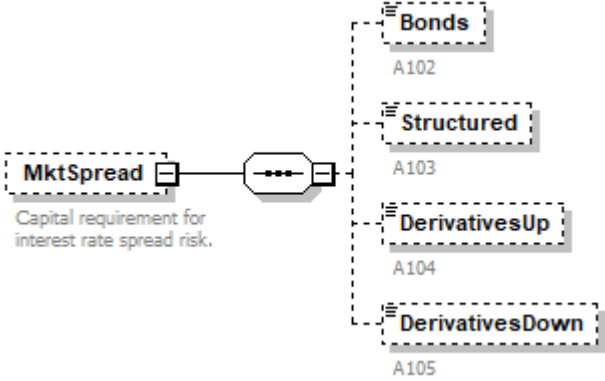
|            |  |
|------------|--|
| diagram    |                             |
| properties | isRef 0<br>minOcc 0<br>maxOcc 1<br>content complex   |
| children   | <a href="#">Bonds</a> <a href="#">Structured</a> <a href="#">DerivativesUp</a> <a href="#">DerivativesDown</a> |
| annotation | documentation<br>Capital requirement for interest rate spread risk.  |

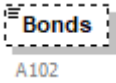

element **ContributionToSCRTType\_V5/MktSpread/Bonds**

|            |   |
|------------|---|
| diagram    |  |
| type       | <b>xs:decimal</b>   |
| properties | isRef 0<br>minOcc 0<br>maxOcc 1<br>content simple                                 |
| annotation | documentation<br>A102   |

element **ContributionToSCRTType\_V5/MktSpread/Structured**

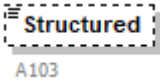
|            |   |
|------------|---|
| diagram    |  |
| type       | <b>xs:decimal</b>   |
| properties | isRef 0<br>minOcc 0<br>maxOcc 1<br>content simple                                 |
| annotation | documentation<br>A103   |

element **ContributionToSCRTType\_V5/MktSpread/DerivativesUp**

|            |   |
|------------|---|
| diagram    |  |
| type       | <b>xs:decimal</b>   |
| properties | isRef 0<br>minOcc 0<br>maxOcc 1<br>content simple                                   |
| annotation | documentation<br>A104   |

element **ContributionToSCRTType\_V5/MktSpread/DerivativesDown**

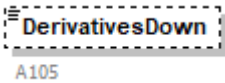
|            |   |
|------------|---|
| diagram    |  |
| type       | <b>xs:decimal</b>   |
| properties | isRef 0<br>minOcc 0<br>maxOcc 1<br>content simple                                   |
| annotation | documentation<br>A105   |

element **ContributionToSCRTType\_V5/MktFXUp**

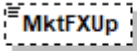
|            |  |
|------------|--|
| diagram    |  <p>A105a - Capital requirement for FX (upward shock)</p> |
| type       | <b>xs:decimal</b>  |
| properties | isRef 0<br>minOcc 0<br>maxOcc 1<br>content simple  |
| annotation | documentation<br>A105a - Capital requirement for FX (upward shock)   |

element **ContributionToSCRTType\_V5/MktFXDown**

|            |  |
|------------|--|
| diagram    |  <p>A105b - Capital requirement for FX (downward shock)</p> |
| type       | <b>xs:decimal</b>  |
| properties | isRef 0<br>minOcc 0<br>maxOcc 1<br>content simple  |
| annotation | documentation<br>A105b - Capital requirement for FX (downward shock)   |

complexType **ContributionToSCRType\_V6**

|                   |   |
|-------------------|---|
| <p>diagram</p>    | <p><b>ContributionToSCRType_V6</b></p> <p>List of possible contributions to global SCR. Applicable to a Position. Could also be used for a group of Positions</p> <ul style="list-style-type: none"> <li><b>MktIntUp</b>: A97 - Capital requirement for interest rate risk for the "up" shock.</li> <li><b>MktIntDown</b>: A98 - Capital requirement for interest rate risk for the "down" shock.</li> <li><b>MktEqGlobal</b>: A99 - Capital requirement for equity risk (EEA or OECD zone). Only MktEqGlobal or MktEqOther will be non zero.</li> <li><b>MktEqOther</b>: A100 - Capital requirement for equity risk (non OECD zone). Only MktEqGlobal or MktEqOther will be non zero.</li> <li><b>MktProp</b>: A101 - Capital requirement for property risk</li> <li><b>MktSpread</b>: Capital requirement for interest rate spread risk.</li> <li><b>MktFXUp</b>: A105a - Capital requirement for FX (upward shock)</li> <li><b>MktFXDown</b>: A105b - Capital requirement for FX (downward shock)</li> </ul> |
| <p>children</p>   | <p><a href="#">MktIntUp</a> <a href="#">MktIntDown</a> <a href="#">MktEqGlobal</a> <a href="#">MktEqOther</a> <a href="#">MktProp</a> <a href="#">MktSpread</a> <a href="#">MktFXUp</a> <a href="#">MktFXDown</a></p>   |
| <p>annotation</p> | <p>documentation<br/>List of possible contributions to global SCR. Applicable to a Position. Could also be used for a group of Positions</p>  |

element **ContributionToSCRType\_V6/MktIntUp**

|                   |  |
|-------------------|--|
| <p>diagram</p>    | <p><b>MktIntUp</b></p> <p>A97 - Capital requirement for interest rate risk for the "up" shock.</p> |
| <p>type</p>       | <p><b>xs:decimal</b></p>   |
| <p>properties</p> | <p>isRef 0<br/>minOcc 0</p>  |

|            |   |
|------------|---|
|            | maxOcc 1<br>content simple  |
| annotation | documentation<br>A97 - Capital requirement for interest rate risk for the "up" shock. |

element **ContributionToSCRTType\_V6/MktIntDown**

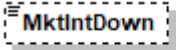
|            |   |
|------------|---|
| diagram    |  <p>A98 - Capital requirement for interest rate risk for the "down" shock.</p> |
| type       | <b>xs:decimal</b>   |
| properties | isRef 0<br>minOcc 0<br>maxOcc 1<br>content simple   |
| annotation | documentation<br>A98 - Capital requirement for interest rate risk for the "down" shock.   |

element **ContributionToSCRTType\_V6/MktEqGlobal**

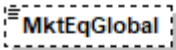
|            |  |
|------------|--|
| diagram    |  <p>A99 - Capital requirement for equity risk (EEA or OECD zone).<br/>Onlyl MktEqGlobal or MktEqOther will be non zero.</p> |
| type       | <b>xs:decimal</b>  |
| properties | isRef 0<br>minOcc 0<br>maxOcc 1<br>content simple  |
| annotation | documentation<br>A99 - Capital requirement for equity risk (EEA or OECD zone).<br>Onlyl MktEqGlobal or MktEqOther will be non zero.  |

element **ContributionToSCRTType\_V6/MktEqOther**

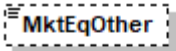
|            |  |
|------------|--|
| diagram    |  <p>A100 - Capital requirement for equity risk (non OECD zone).<br/>Onlyl MktEqGlobal or MktEqOther will be non zero.</p> |
| type       | <b>xs:decimal</b>  |
| properties | isRef 0<br>minOcc 0<br>maxOcc 1<br>content simple  |
| annotation | documentation<br>A100 - Capital requirement for equity risk (non OECD zone).<br>Onlyl MktEqGlobal or MktEqOther will be non zero.  |

element **ContributionToSCRTType\_V6/MktProp**

|            |  |
|------------|--|
| diagram    |  <p><b>MktProp</b><br/>A101 - Capital requirement for property risk</p> |
| type       | <b>xs:decimal</b>  |
| properties | isRef 0<br>minOcc 0<br>maxOcc 1<br>content simple  |
| annotation | documentation<br>A101 - Capital requirement for property risk  |

element **ContributionToSCRTType\_V6/MktSpread**

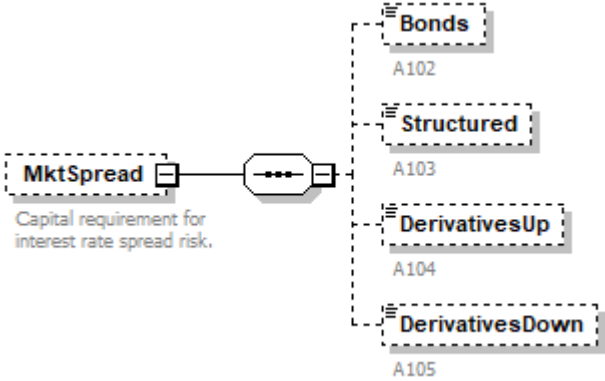
|            |  |
|------------|--|
| diagram    |  <p><b>MktSpread</b><br/>Capital requirement for interest rate spread risk.</p> <p>The diagram shows a central <b>MktSpread</b> element connected to four sub-elements: <b>Bonds</b> (A102), <b>Structured</b> (A103), <b>DerivativesUp</b> (A104), and <b>DerivativesDown</b> (A105).</p> |
| properties | isRef 0<br>minOcc 0<br>maxOcc 1<br>content complex   |
| children   | <a href="#">Bonds</a> <a href="#">Structured</a> <a href="#">DerivativesUp</a> <a href="#">DerivativesDown</a>   |
| annotation | documentation<br>Capital requirement for interest rate spread risk.  |

element **ContributionToSCRTType\_V6/MktSpread/Bonds**

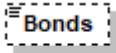
|            |  |
|------------|--|
| diagram    |  <p><b>Bonds</b><br/>A102</p> |
| type       | <b>xs:decimal</b>  |
| properties | isRef 0<br>minOcc 0<br>maxOcc 1<br>content simple  |
| annotation | documentation<br>A102  |

element **ContributionToSCRTType\_V6/MktSpread/Structured**

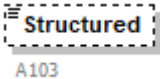
|            |   |
|------------|---|
| diagram    |  |
| type       | <b>xs:decimal</b>   |
| properties | isRef 0<br>minOcc 0<br>maxOcc 1<br>content simple                                 |
| annotation | documentation<br>A103   |

element **ContributionToSCRTType\_V6/MktSpread/DerivativesUp**

|            |   |
|------------|---|
| diagram    |  |
| type       | <b>xs:decimal</b>   |
| properties | isRef 0<br>minOcc 0<br>maxOcc 1<br>content simple                                 |
| annotation | documentation<br>A104   |

element **ContributionToSCRTType\_V6/MktSpread/DerivativesDown**

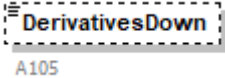
|            |   |
|------------|---|
| diagram    |  |
| type       | <b>xs:decimal</b>   |
| properties | isRef 0<br>minOcc 0<br>maxOcc 1<br>content simple                                   |
| annotation | documentation<br>A105   |

element **ContributionToSCRTType\_V6/MktFXUp**

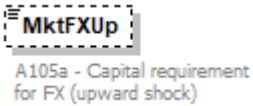
|            |   |
|------------|---|
| diagram    |  |
| type       | <b>xs:decimal</b>   |
| properties | isRef 0<br>minOcc 0<br>maxOcc 1<br>content simple                                   |
| annotation | documentation<br>A105a - Capital requirement for FX (upward shock)                  |

element **ContributionToSCRTType\_V6/MktFXDown**

|            |   |
|------------|---|
| diagram    |  <p><b>MktFXDown</b><br/>A105b - Capital requirement for FX (downward shock)</p> |
| type       | <b>xs:decimal</b>   |
| properties | isRef 0<br>minOcc 0<br>maxOcc 1<br>content simple   |
| annotation | documentation<br>A105b - Capital requirement for FX (downward shock)  |

complexType **CreditRiskDataType**

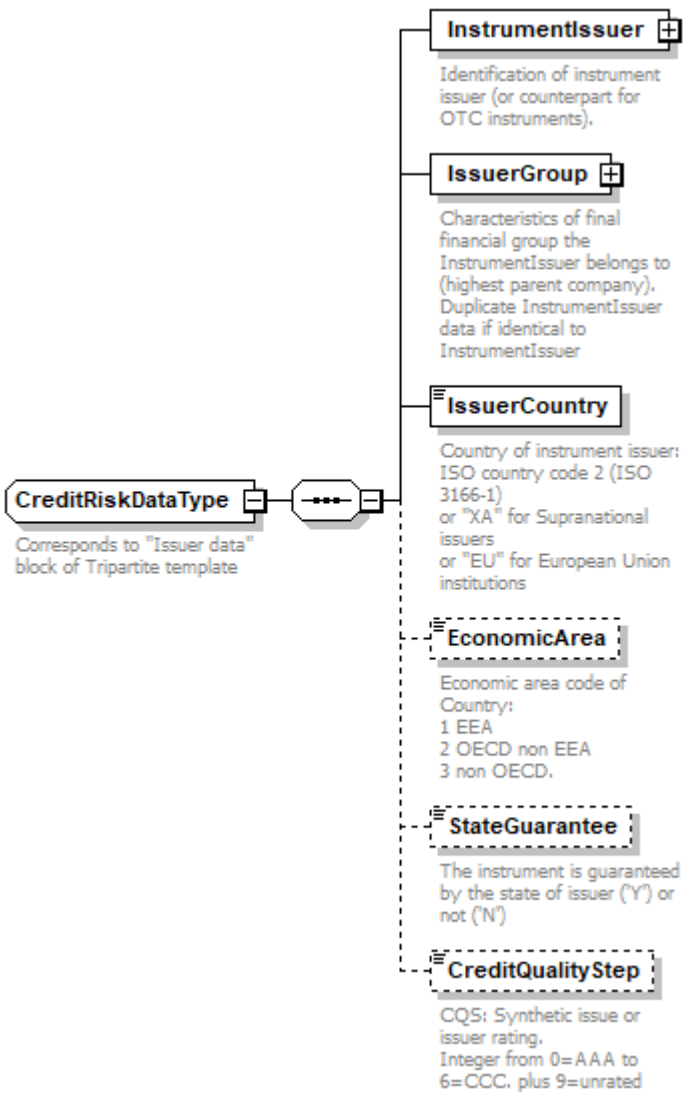
|          |  |
|----------|--|
| diagram  |  <p><b>CreditRiskDataType</b><br/>Corresponds to "Issuer data" block of Tripartite template</p> <p><b>InstrumentIssuer</b> +<br/>Identification of instrument issuer (or counterpart for OTC instruments).</p> <p><b>IssuerGroup</b> +<br/>Characteristics of final financial group the InstrumentIssuer belongs to (highest parent company). Duplicate InstrumentIssuer data if identical to InstrumentIssuer</p> <p><b>IssuerCountry</b><br/>Country of instrument issuer: ISO country code 2 (ISO 3166-1) or "XA" for Supranational issuers or "EU" for European Union institutions</p> <p><b>EconomicArea</b><br/>Economic area code of Country:<br/>1 EEA<br/>2 OECD non EEA<br/>3 non OECD.</p> <p><b>StateGuarantee</b><br/>The instrument is guaranteed by the state of issuer ('Y') or not ('N')</p> <p><b>CreditQualityStep</b><br/>CQS: Synthetic issue or issuer rating.<br/>Integer from 0=AAA to 6=CCC, plus 9=unrated</p> |
| children | <a href="#">InstrumentIssuer</a> <a href="#">IssuerGroup</a> <a href="#">IssuerCountry</a> <a href="#">EconomicArea</a> <a href="#">StateGuarantee</a> <a href="#">CreditQualityStep</a>   |
| used by  | elements <a href="#">SIIPositionType/CreditRiskData</a><br><a href="#">SIIPositionType/DerivativeOrConvertible/UnderlyingInstrument/CreditRiskData</a>   |

|            |  |
|------------|--|
| annotation | documentation<br>Corresponds to "Issuer data" block of Tripartite template |
|------------|--|

element **CreditRiskDataType/InstrumentIssuer**

|            |   |
|------------|---|
| diagram    | <p>The diagram shows the <b>InstrumentIssuer</b> element connected to the <b>SIIIssuerType_V5</b> container. The <b>InstrumentIssuer</b> element is described as "Identification of instrument issuer (or counterpart for OTC instruments)". The <b>SIIIssuerType_V5</b> container contains three elements: <b>Name</b> (Entity name), <b>Code</b> (LEI or empty), and <b>CodeType</b>.</p> |
| type       | <a href="#">SIIIssuerType_V5</a>  |
| properties | isRef 0<br>content complex  |
| children   | <a href="#">Name</a> <a href="#">Code</a> <a href="#">CodeType</a>  |
| annotation | documentation<br>Identification of instrument issuer (or counterpart for OTC instruments).  |

element **CreditRiskDataType/IssuerGroup**

|            |  |
|------------|--|
| diagram    | <p>The diagram shows the <b>IssuerGroup</b> element connected to the <b>SIIIssuerType_V5</b> container. The <b>IssuerGroup</b> element is described as "Characteristics of final financial group the InstrumentIssuer belongs to (highest parent company). Duplicate InstrumentIssuer data if identical to InstrumentIssuer". The <b>SIIIssuerType_V5</b> container contains three elements: <b>Name</b> (Entity name), <b>Code</b> (LEI or empty), and <b>CodeType</b>.</p> |
| type       | <a href="#">SIIIssuerType_V5</a>   |
| properties | isRef 0<br>content complex   |
| children   | <a href="#">Name</a> <a href="#">Code</a> <a href="#">CodeType</a>   |
| annotation | documentation<br>Characteristics of final financial group the InstrumentIssuer belongs to (highest parent company).<br>Duplicate InstrumentIssuer data if identical to InstrumentIssuer  |

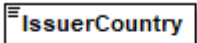

element **CreditRiskDataType/IssuerCountry**

| diagram    |  <p>Country of instrument issuer:<br/>ISO country code 2 (ISO 3166-1)<br/>or "XA" for Supranational issuers<br/>or "EU" for European Union institutions</p> |            |       |            |           |   |  |           |   |  |
|------------|--|------------|-------|------------|-----------|---|--|-----------|---|--|
| type       | <a href="#">ISOCountryCodeType</a>   |            |       |            |           |   |  |           |   |  |
| properties | isRef 0<br>content simple  |            |       |            |           |   |  |           |   |  |
| facets     | <table border="1"> <thead> <tr> <th>Kind</th> <th>Value</th> <th>annotation</th> </tr> </thead> <tbody> <tr> <td>minLength</td> <td>2</td> <td></td> </tr> <tr> <td>maxLength</td> <td>2</td> <td></td> </tr> </tbody> </table>              | Kind       | Value | annotation | minLength | 2 |  | maxLength | 2 |  |
| Kind       | Value  | annotation |       |            |           |   |  |           |   |  |
| minLength  | 2  |            |       |            |           |   |  |           |   |  |
| maxLength  | 2  |            |       |            |           |   |  |           |   |  |
| annotation | documentation<br>Country of instrument issuer:<br>ISO country code 2 (ISO 3166-1)<br>or "XA" for Supranational issuers<br>or "EU" for European Union institutions  |            |       |            |           |   |  |           |   |  |

element **CreditRiskDataType/EconomicArea**

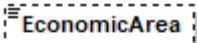
| diagram      |  <p>Economic area code of Country:<br/>1 EEA<br/>2 OECD non EEA<br/>3 non OECD.</p>  |            |       |            |              |   |  |              |   |  |
|--------------|---|------------|-------|------------|--------------|---|--|--------------|---|--|
| type         | <a href="#">EconomicArea2Type</a>   |            |       |            |              |   |  |              |   |  |
| properties   | isRef 0<br>minOcc 0<br>maxOcc 1<br>content simple   |            |       |            |              |   |  |              |   |  |
| facets       | <table border="1"> <thead> <tr> <th>Kind</th> <th>Value</th> <th>annotation</th> </tr> </thead> <tbody> <tr> <td>minInclusive</td> <td>1</td> <td></td> </tr> <tr> <td>maxInclusive</td> <td>3</td> <td></td> </tr> </tbody> </table> | Kind       | Value | annotation | minInclusive | 1 |  | maxInclusive | 3 |  |
| Kind         | Value   | annotation |       |            |              |   |  |              |   |  |
| minInclusive | 1   |            |       |            |              |   |  |              |   |  |
| maxInclusive | 3   |            |       |            |              |   |  |              |   |  |
| annotation   | documentation<br>Economic area code of Country:<br>1 EEA<br>2 OECD non EEA<br>3 non OECD.   |            |       |            |              |   |  |              |   |  |

element **CreditRiskDataType/StateGuarantee**

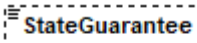
|            |   |
|------------|---|
| diagram    |  <p>The instrument is guaranteed<br/>by the state of issuer ('Y') or<br/>not ('N')</p> |
| type       | <a href="#">YesNoL1Type</a>   |
| properties | isRef 0<br>minOcc 0<br>maxOcc 1<br>content simple   |

|            |   |
|------------|---|
| facets     | Kind Value annotation<br>minLength 1<br>maxLength 1                                     |
| annotation | documentation<br>The instrument is guaranteed by the state of issuer ('Y') or not ('N') |

element **CreditRiskDataType/CreditQualityStep**

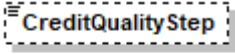
|            |   |
|------------|---|
| diagram    |  <p>CQS: Synthetic issue or issuer rating.<br/>Integer from 0=AAA to 6=CCC, plus 9=unrated</p> |
| type       | <a href="#">CQSType</a>   |
| properties | isRef 0<br>minOcc 0<br>maxOcc 1<br>content simple   |
| facets     | Kind Value annotation<br>minInclusive 0<br>maxInclusive 9   |
| annotation | documentation<br>CQS: Synthetic issue or issuer rating.<br>Integer from 0=AAA to 6=CCC, plus 9=unrated  |

complexType **CreditRiskDataType\_V5**

|                   |  |
|-------------------|--|
| <p>diagram</p>    | <p><b>CreditRiskDataType_V5</b><br/>Corresponds to "Issuer data" block of Tripartite template</p> <p><b>InstrumentIssuer</b><br/>Identification of instrument issuer (or counterpart for OTC instruments).</p> <p><b>IssuerGroup</b><br/>Characteristics of final financial group the InstrumentIssuer belongs to (highest parent company). Duplicate InstrumentIssuer data if identical to InstrumentIssuer</p> <p><b>IssuerCountry</b><br/>Country of instrument issuer: ISO country code 2 (ISO 3166-1) or "XA" for Supranational issuers or "EU" for European Union institutions</p> <p><b>EconomicArea</b><br/>Economic area code of Country:<br/>1 EEA<br/>2 OECD non EEA<br/>3 non OECD.</p> <p><b>StateGuarantee</b><br/>The instrument is guaranteed by the state of issuer ('Y') or not ('N')</p> <p><b>CreditQualityStep</b><br/>CQS: Synthetic issue or issuer rating.<br/>Integer from 0=AAA to 6=CCC, plus 9=unrated</p> |
| <p>children</p>   | <p><a href="#">InstrumentIssuer</a> <a href="#">IssuerGroup</a> <a href="#">IssuerCountry</a> <a href="#">EconomicArea</a> <a href="#">StateGuarantee</a> <a href="#">CreditQualityStep</a></p>  |
| <p>used by</p>    | <p>elements <a href="#">SIIPositionType_V6/DerivativeOrConvertible/UnderlyingInstrument/CreditRiskData</a><br/><a href="#">SIIPositionType_V5/CreditRiskData</a><br/><a href="#">SIIPositionType_V5/DerivativeOrConvertible/UnderlyingInstrument/CreditRiskData</a></p>  |
| <p>annotation</p> | <p>documentation<br/>Corresponds to "Issuer data" block of Tripartite template</p>   |

element **CreditRiskDataType\_V5/InstrumentIssuer**

|            |   |
|------------|---|
| diagram    | <p>The diagram shows the <b>InstrumentIssuer</b> element connected to a container labeled <b>SIIIssuerType_V5</b>. The <b>InstrumentIssuer</b> element is described as "Identification of instrument issuer (or counterpart for OTC instruments)". The <b>SIIIssuerType_V5</b> container contains three sub-elements: <b>Name</b> (Entity name), <b>Code</b> (LEI or empty), and <b>CodeType</b>.</p> |
| type       | <a href="#">SIIIssuerType_V5</a>  |
| properties | isRef 0<br>content complex  |
| children   | <a href="#">Name</a> <a href="#">Code</a> <a href="#">CodeType</a>  |
| annotation | documentation<br>Identification of instrument issuer (or counterpart for OTC instruments).  |

element **CreditRiskDataType\_V5/IssuerGroup**

|            |  |
|------------|--|
| diagram    | <p>The diagram shows the <b>IssuerGroup</b> element connected to a container labeled <b>SIIIssuerType_V5</b>. The <b>IssuerGroup</b> element is described as "Characteristics of final financial group the InstrumentIssuer belongs to (highest parent company). Duplicate InstrumentIssuer data if identical to InstrumentIssuer". The <b>SIIIssuerType_V5</b> container contains three sub-elements: <b>Name</b> (Entity name), <b>Code</b> (LEI or empty), and <b>CodeType</b>.</p> |
| type       | <a href="#">SIIIssuerType_V5</a>   |
| properties | isRef 0<br>content complex   |
| children   | <a href="#">Name</a> <a href="#">Code</a> <a href="#">CodeType</a>   |
| annotation | documentation<br>Characteristics of final financial group the InstrumentIssuer belongs to (highest parent company).<br>Duplicate InstrumentIssuer data if identical to InstrumentIssuer  |

element **CreditRiskDataType\_V5/IssuerCountry**

|         |  |
|---------|--|
| diagram | <p>The diagram shows the <b>IssuerCountry</b> element, described as "Country of instrument issuer: ISO country code 2 (ISO 3166-1) or 'XA' for Supranational issuers or 'EU' for European Union institutions".</p> |
|---------|--|

|            |   |
|------------|---|
| type       | <a href="#">ISOCountryCodeType</a>  |
| properties | isRef 0<br>content simple   |
| facets     | Kind Value annotation<br>minLength 2<br>maxLength 2   |
| annotation | documentation<br>Country of instrument issuer:<br>ISO country code 2 (ISO 3166-1)<br>or "XA" for Supranational issuers<br>or "EU" for European Union institutions |

element **CreditRiskDataType\_V5/EconomicArea**

|            |   |
|------------|---|
| diagram    |          |
| type       | <a href="#">EconomicArea2Type</a>   |
| properties | isRef 0<br>minOcc 0<br>maxOcc 1<br>content simple   |
| facets     | Kind Value annotation<br>minInclusive 1<br>maxInclusive 3                                 |
| annotation | documentation<br>Economic area code of Country:<br>1 EEA<br>2 OECD non EEA<br>3 non OECD. |

element **CreditRiskDataType\_V5/StateGuarantee**

|            |   |
|------------|---|
| diagram    |      |
| type       | <a href="#">YesNoL1Type</a>   |
| properties | isRef 0<br>minOcc 0<br>maxOcc 1<br>content simple                                       |
| facets     | Kind Value annotation<br>minLength 1<br>maxLength 1                                     |
| annotation | documentation<br>The instrument is guaranteed by the state of issuer ('Y') or not ('N') |

element **CreditRiskDataType\_V5/CreditQualityStep**

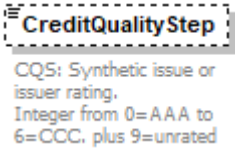
|              |   |            |       |            |              |   |  |              |   |  |
|--------------|---|------------|-------|------------|--------------|---|--|--------------|---|--|
| diagram      |  <p>CQS: Synthetic issue or issuer rating.<br/>Integer from 0=AAA to 6=CCC, plus 9=unrated</p>                     |            |       |            |              |   |  |              |   |  |
| type         | <a href="#">CQSType</a>   |            |       |            |              |   |  |              |   |  |
| properties   | <p>isRef 0<br/>minOcc 0<br/>maxOcc 1<br/>content simple</p>   |            |       |            |              |   |  |              |   |  |
| facets       | <table border="0"> <tr> <td>Kind</td> <td>Value</td> <td>annotation</td> </tr> <tr> <td>minInclusive</td> <td>0</td> <td></td> </tr> <tr> <td>maxInclusive</td> <td>9</td> <td></td> </tr> </table> | Kind       | Value | annotation | minInclusive | 0 |  | maxInclusive | 9 |  |
| Kind         | Value   | annotation |       |            |              |   |  |              |   |  |
| minInclusive | 0   |            |       |            |              |   |  |              |   |  |
| maxInclusive | 9   |            |       |            |              |   |  |              |   |  |
| annotation   | <p>documentation<br/>CQS: Synthetic issue or issuer rating.<br/>Integer from 0=AAA to 6=CCC, plus 9=unrated</p>   |            |       |            |              |   |  |              |   |  |

complexType **CreditRiskDataType\_V6**

|                   |   |
|-------------------|---|
| <p>diagram</p>    | <p><b>CreditRiskDataType_V6</b><br/>Corresponds to "Issuer data" block of Tripartite template</p> <ul style="list-style-type: none"> <li><b>InstrumentIssuer</b><br/>Identification of instrument issuer (or counterpart for OTC instruments).</li> <li><b>IssuerGroup</b><br/>Characteristics of final financial group the InstrumentIssuer belongs to (highest parent company). Duplicate InstrumentIssuer data if identical to InstrumentIssuer</li> <li><b>IssuerCountry</b><br/>Country of instrument issuer: ISO country code 2 (ISO 3166-1) or "XA" for Supranational issuers or "EU" for European Union institutions</li> <li><b>EconomicArea</b><br/>Economic area code of Country:<br/>1 EEA<br/>2 OECD non EEA<br/>3 non OECD.</li> <li><b>StateGuarantee</b><br/>The instrument is guaranteed by the state of issuer ('Y') or not ('N')</li> <li><b>CreditQualityStep</b><br/>CQS: Synthetic issue or issuer rating. Integer from 0=AAA to 6=CCC, plus 9=unrated</li> </ul> |
| <p>children</p>   | <p><a href="#">InstrumentIssuer</a> <a href="#">IssuerGroup</a> <a href="#">IssuerCountry</a> <a href="#">EconomicArea</a> <a href="#">StateGuarantee</a> <a href="#">CreditQualityStep</a></p>   |
| <p>used by</p>    | <p>element <a href="#">SIIPositionType_V6/CreditRiskData</a></p>  |
| <p>annotation</p> | <p>documentation<br/>Corresponds to "Issuer data" block of Tripartite template</p>  |

element **CreditRiskDataType\_V6/InstrumentIssuer**

|            |  |
|------------|--|
| diagram    | <p>The diagram shows the <b>InstrumentIssuer</b> element connected to the <b>SIIIssuerType_V5</b> type. <b>InstrumentIssuer</b> is described as "Identification of instrument issuer (or counterpart for OTC instruments)". <b>SIIIssuerType_V5</b> is a complex type containing three elements: <b>Name</b> (Entity name), <b>Code</b> (LEI or empty), and <b>CodeType</b>.</p> |
| type       | <a href="#">SIIIssuerType_V5</a>   |
| properties | isRef 0<br>content complex   |
| children   | <a href="#">Name</a> <a href="#">Code</a> <a href="#">CodeType</a>   |
| annotation | documentation<br>Identification of instrument issuer (or counterpart for OTC instruments).   |

element **CreditRiskDataType\_V6/IssuerGroup**

|            |   |
|------------|---|
| diagram    | <p>The diagram shows the <b>IssuerGroup</b> element connected to the <b>SIIIssuerType_V5</b> type. <b>IssuerGroup</b> is described as "Characteristics of final financial group the InstrumentIssuer belongs to (highest parent company). Duplicate InstrumentIssuer data if identical to InstrumentIssuer". <b>SIIIssuerType_V5</b> is a complex type containing three elements: <b>Name</b> (Entity name), <b>Code</b> (LEI or empty), and <b>CodeType</b>.</p> |
| type       | <a href="#">SIIIssuerType_V5</a>  |
| properties | isRef 0<br>content complex  |
| children   | <a href="#">Name</a> <a href="#">Code</a> <a href="#">CodeType</a>  |
| annotation | documentation<br>Characteristics of final financial group the InstrumentIssuer belongs to (highest parent company).<br>Duplicate InstrumentIssuer data if identical to InstrumentIssuer   |

element **CreditRiskDataType\_V6/IssuerCountry**

|         |  |
|---------|--|
| diagram | <p>The diagram shows the <b>IssuerCountry</b> element, described as "Country of instrument issuer: ISO country code 2 (ISO 3166-1) or 'XA' for Supranational issuers or 'EU' for European Union institutions".</p> |
|---------|--|



|            |   |
|------------|---|
| type       | <a href="#">ISOCountryCodeType</a>  |
| properties | isRef 0<br>content simple   |
| facets     | Kind Value annotation<br>minLength 2<br>maxLength 2   |
| annotation | documentation<br>Country of instrument issuer:<br>ISO country code 2 (ISO 3166-1)<br>or "XA" for Supranational issuers<br>or "EU" for European Union institutions |

element **CreditRiskDataType\_V6/EconomicArea**

|            |   |
|------------|---|
| diagram    |          |
| type       | <a href="#">EconomicArea2Type</a>   |
| properties | isRef 0<br>minOcc 0<br>maxOcc 1<br>content simple   |
| facets     | Kind Value annotation<br>minInclusive 1<br>maxInclusive 3                                 |
| annotation | documentation<br>Economic area code of Country:<br>1 EEA<br>2 OECD non EEA<br>3 non OECD. |

element **CreditRiskDataType\_V6/StateGuarantee**

|            |   |
|------------|---|
| diagram    |      |
| type       | <a href="#">YesNoL1Type</a>   |
| properties | isRef 0<br>minOcc 0<br>maxOcc 1<br>content simple                                       |
| facets     | Kind Value annotation<br>minLength 1<br>maxLength 1                                     |
| annotation | documentation<br>The instrument is guaranteed by the state of issuer ('Y') or not ('N') |

element **CreditRiskDataType\_V6/CreditQualityStep**

|            |  |
|------------|--|
| diagram    | <p><b>CreditQualityStep</b><br/>CQS: Synthetic issue or issuer rating.<br/>Integer from 0=AAA to 6=CCC, plus 9=unrated</p> |
| type       | <a href="#">CQSType</a>  |
| properties | isRef 0<br>minOcc 0<br>maxOcc 1<br>content simple  |
| facets     | Kind Value annotation<br>minInclusive 0<br>maxInclusive 9  |
| annotation | documentation<br>CQS: Synthetic issue or issuer rating.<br>Integer from 0=AAA to 6=CCC, plus 9=unrated                     |

complexType **RedemptionType**

|            |  |
|------------|--|
| diagram    | <p><b>RedemptionType</b><br/>Redemption information of a bond or other interest rate instrument</p> <p><b>MaturityDate</b><br/>Last redemption date 9999-12-31 for perpetual.<br/>Expiry date for options.</p> <p><b>Type</b><br/>Type of Redemption schedule:<br/>Bullet or Sinkable (constant annuity).<br/>Omitted if not applicable.</p> <p><b>Rate</b><br/>If known, redemption rate in percentage of nominal amount (A19)<br/>100%=1.0</p> |
| children   | <a href="#">MaturityDate</a> <a href="#">Type</a> <a href="#">Rate</a>   |
| used by    | elements <a href="#">SIIPositionType/InterestRateInstrumentCharacteristics/Redemption</a><br><a href="#">SIIPositionType/DerivativeOrConvertible/UnderlyingInstrument/Redemption</a>   |
| annotation | documentation<br>Redemption information of a bond or other interest rate instrument  |

element **RedemptionType/MaturityDate**

|            |  |
|------------|--|
| diagram    | <p><b>MaturityDate</b><br/>Last redemption date 9999-12-31 for perpetual.<br/>Expiry date for options.</p> |
| type       | <b>xs:date</b>   |
| properties | isRef 0<br>content simple  |
| annotation | documentation<br>Last redemption date  |

|  |   |
|--|---|
|  | 9999-12-31 for perpetual.<br>Expiry date for options. |
|--|---|

element **RedemptionType/Type**

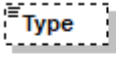
|            |   |
|------------|---|
| diagram    |  <p>Type of Redemption schedule:<br/>Bullet or Sinkable (constant annuity).<br/>Omitted if not applicable.</p>   |
| type       | restriction of <b>xs:string</b>   |
| properties | isRef 0<br>minOcc 0<br>maxOcc 1<br>content simple   |
| annotation | documentation<br>Type of Redemption schedule:<br>Bullet or Sinkable (constant annuity).<br>Omitted if not applicable.<br>appinfo<br><altova:exampleValues><br><altova:example value="Bullet"/><br><altova:example value="Sinkable"/><br></altova:exampleValues> |

element **RedemptionType/Rate**

|            |   |
|------------|---|
| diagram    |  <p>If known, redemption rate in percentage of nominal amount (A19)<br/>100%=1.0</p> |
| type       | <b>xs:decimal</b>   |
| properties | isRef 0<br>minOcc 0<br>maxOcc 1<br>content simple   |
| annotation | documentation<br>If known, redemption rate in percentage of nominal amount (A19) 100%=1.0   |

## complexType RedemptionType\_V5

|            |  |
|------------|--|
| diagram    |  |
| children   | <a href="#">MaturityDate</a> <a href="#">Type</a> <a href="#">Rate</a>   |
| used by    | elements <a href="#">SIIPositionType_V6/DerivativeOrConvertible/UnderlyingInstrument/Redemption</a><br><a href="#">SIIPositionType_V5/InterestRateInstrumentCharacteristics/Redemption</a><br><a href="#">SIIPositionType_V5/DerivativeOrConvertible/UnderlyingInstrument/Redemption</a> |
| annotation | documentation<br>Redemption information of a bond or other interest rate instrument  |

## element RedemptionType\_V5/MaturityDate

|            |  |
|------------|--|
| diagram    |  |
| type       | <b>xs:date</b>   |
| properties | isRef 0<br>content simple  |
| annotation | documentation<br>Last redemption date<br>9999-12-31 for perpetual.<br>Expiry date for options. |

## element RedemptionType\_V5/Type

|            |   |
|------------|---|
| diagram    |   |
| type       | restriction of <b>xs:string</b>                   |
| properties | isRef 0<br>minOcc 0<br>maxOcc 1<br>content simple |
| annotation | documentation                                     |

|  |   |
|--|---|
|  | <p>Type of Redemption schedule:<br/> "Bullet", "Sinkable", "defaulted" empty if non applicable,<br/> Omitted if not applicable.</p> <p>appinfo<br/> &lt;altova:exampleValues&gt;<br/> &lt;altova:example value="Bullet"/&gt;<br/> &lt;altova:example value="Sinkable"/&gt;<br/> &lt;/altova:exampleValues&gt;</p> |
|--|---|

element **RedemptionType\_V5/Rate**

|            |   |
|------------|---|
| diagram    | <p>If known, redemption rate in percentage of nominal amount (A19)<br/> 100%=1.0</p>      |
| type       | <b>xs:decimal</b>   |
| properties | isRef 0<br>minOcc 0<br>maxOcc 1<br>content simple   |
| annotation | documentation<br>If known, redemption rate in percentage of nominal amount (A19) 100%=1.0 |

complexType **RedemptionType\_V6**

|            |   |
|------------|---|
| diagram    | <p><b>RedemptionType_V6</b><br/> Redemption information of a bond or other interest rate instrument</p> <p><b>MaturityDate</b><br/> Last redemption date<br/> 9999-12-31 for perpetual.<br/> Expiry date for options.</p> <p><b>Type</b><br/> Type of Redemption schedule:<br/> "Bullet", "Sinkable",<br/> "defaulted" empty if non applicable,<br/> Omitted if not applicable.</p> <p><b>Rate</b><br/> If known, redemption rate in percentage of nominal amount (A19)<br/> 100%=1.0</p> |
| children   | <a href="#">MaturityDate</a> <a href="#">Type</a> <a href="#">Rate</a>  |
| used by    | element <a href="#">SIIPositionType_V6/InterestRateInstrumentCharacteristics/Redemption</a>   |
| annotation | documentation<br>Redemption information of a bond or other interest rate instrument   |

element **RedemptionType\_V6/MaturityDate**

|            |  |
|------------|--|
| diagram    |  <p>Last redemption date<br/>9999-12-31 for perpetual.<br/>Expiry date for options.</p> |
| type       | <b>xs:date</b>   |
| properties | isRef 0<br>content simple  |
| annotation | documentation<br>Last redemption date<br>9999-12-31 for perpetual.<br>Expiry date for options.   |

element **RedemptionType\_V6/Type**

|            |   |
|------------|---|
| diagram    |  <p>Type of Redemption<br/>schedule:<br/>"Bullet", "Sinkable",<br/>"defaulted" empty if non<br/>applicable.<br/>Omitted if not applicable.</p>   |
| type       | restriction of <b>xs:string</b>   |
| properties | isRef 0<br>minOcc 0<br>maxOcc 1<br>content simple   |
| annotation | documentation<br>Type of Redemption schedule:<br>"Bullet", "Sinkable", "defaulted" empty if non applicable,<br>Omitted if not applicable.<br>appinfo<br><altova:exampleValues><br><altova:example value="Bullet"/><br><altova:example value="Sinkable"/><br></altova:exampleValues> |

element **RedemptionType\_V6/Rate**

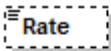
|            |   |
|------------|---|
| diagram    |  <p>If known, redemption rate in<br/>percentage<br/>of nominal amount (A19)<br/>100%=1.0</p> |
| type       | <b>xs:decimal</b>   |
| properties | isRef 0<br>minOcc 0<br>maxOcc 1<br>content simple   |
| annotation | documentation<br>If known, redemption rate in percentage<br>of nominal amount (A19) 100%=1.0  |

### complexType **SI1IssuerType**

|            |  |
|------------|--|
| diagram    |  |
| children   | <a href="#">Name</a> <a href="#">Code</a> <a href="#">CodeType</a>   |
| used by    | elements <a href="#">SolvencyIIPortfolioType/QRTPortfolioInformation/FundIssuer</a><br><a href="#">SolvencyIIPortfolioType/QRTPortfolioInformation/FundIssuerGroup</a> |
| annotation | documentation<br>Name and codification of an Issuer  |

### element **SI1IssuerType/Name**

|            |                              |
|------------|------------------------------|
| diagram    |                              |
| type       | <b>xs:string</b>             |
| properties | isRef 0<br>content simple    |
| annotation | documentation<br>Entity name |

### element **SI1IssuerType/Code**

| diagram    |   |            |       |            |           |    |  |           |    |  |         |                            |  |
|------------|---|------------|-------|------------|-----------|----|--|-----------|----|--|---------|----------------------------|--|
| type       | <a href="#">LEICodeType</a>   |            |       |            |           |    |  |           |    |  |         |                            |  |
| properties | isRef 0<br>minOcc 0<br>maxOcc 1<br>content simple   |            |       |            |           |    |  |           |    |  |         |                            |  |
| facets     | <table border="1"> <thead> <tr> <th>Kind</th> <th>Value</th> <th>annotation</th> </tr> </thead> <tbody> <tr> <td>minLength</td> <td>20</td> <td></td> </tr> <tr> <td>maxLength</td> <td>20</td> <td></td> </tr> <tr> <td>pattern</td> <td>(([0-9a-zA-Z]{18}[0-9]{2})</td> <td></td> </tr> </tbody> </table> | Kind       | Value | annotation | minLength | 20 |  | maxLength | 20 |  | pattern | (([0-9a-zA-Z]{18}[0-9]{2}) |  |
| Kind       | Value   | annotation |       |            |           |    |  |           |    |  |         |                            |  |
| minLength  | 20  |            |       |            |           |    |  |           |    |  |         |                            |  |
| maxLength  | 20  |            |       |            |           |    |  |           |    |  |         |                            |  |
| pattern    | (([0-9a-zA-Z]{18}[0-9]{2})  |            |       |            |           |    |  |           |    |  |         |                            |  |
| annotation | documentation<br>LEI or empty   |            |       |            |           |    |  |           |    |  |         |                            |  |

### element **SI1IssuerType/CodeType**

|            |                              |
|------------|------------------------------|
| diagram    |                              |
| type       | restriction of <b>xs:int</b> |
| properties | isRef 0<br>content simple    |

complexType **SIIIssuerType\_V5**

|            |  |
|------------|--|
| diagram    |  |
| children   | <a href="#">Name</a> <a href="#">Code</a> <a href="#">CodeType</a>   |
| used by    | elements <a href="#">SolvencyIIPortfolioType_V5/QRTPortfolioInformation/FundIssuer</a><br><a href="#">SolvencyIIPortfolioType_V5/QRTPortfolioInformation/FundIssuerGroup</a><br><a href="#">CreditRiskDataType_V6/InstrumentIssuer</a> <a href="#">CreditRiskDataType/InstrumentIssuer</a><br><a href="#">CreditRiskDataType_V5/InstrumentIssuer</a> <a href="#">CreditRiskDataType_V6/IssuerGroup</a><br><a href="#">CreditRiskDataType/IssuerGroup</a> <a href="#">CreditRiskDataType_V5/IssuerGroup</a> |
| annotation | documentation<br>Name and codification of an Issuer  |

element **SIIIssuerType\_V5/Name**

|            |                              |
|------------|------------------------------|
| diagram    |                              |
| type       | <b>xs:string</b>             |
| properties | isRef 0<br>content simple    |
| annotation | documentation<br>Entity name |

element **SIIIssuerType\_V5/Code**

|            |  |
|------------|--|
| diagram    |  |
| type       | <a href="#">LEICodeType</a>  |
| properties | isRef 0<br>minOcc 0<br>maxOcc 1<br>content simple  |
| facets     | Kind Value annotation<br>minLength 20<br>maxLength 20<br>pattern ([0-9a-zA-Z]{18}[0-9]{2}) |
| annotation | documentation<br>LEI or empty  |

element **SIIIssuerType\_V5/CodeType**

|         |  |
|---------|--|
| diagram |  |
|---------|--|



|            |                              |
|------------|------------------------------|
| type       | restriction of <b>xs:int</b> |
| properties | isRef 0<br>content simple    |

### complexType **SIIssuerType\_V6**

|            |  |
|------------|--|
| diagram    |  |
| children   | <a href="#">Name</a> <a href="#">Code</a> <a href="#">CodeType</a>   |
| used by    | elements <a href="#">SolvencyIIPortfolioType_V6/QRTPortfolioInformation/FundIssuer</a><br><a href="#">SolvencyIIPortfolioType_V6/QRTPortfolioInformation/FundIssuerGroup</a> |
| annotation | documentation<br>Name and codification of an Issuer  |

### element **SIIssuerType\_V6/Name**

|            |                              |
|------------|------------------------------|
| diagram    |                              |
| type       | <b>xs:string</b>             |
| properties | isRef 0<br>content simple    |
| annotation | documentation<br>Entity name |

### element **SIIssuerType\_V6/Code**

|            |  |
|------------|--|
| diagram    |  |
| type       | <a href="#">LEICodeType</a>  |
| properties | isRef 0<br>minOcc 0<br>maxOcc 1<br>content simple  |
| facets     | Kind Value annotation<br>minLength 20<br>maxLength 20<br>pattern ([0-9a-zA-Z]{18}[0-9]{2}) |
| annotation | documentation<br>LEI or empty  |

element **SIIssuerType\_V6/CodeType**

|            |  |
|------------|--|
| diagram    |  A diagram showing a rectangular box with the text "CodeType" inside. To the left of the box is a small icon consisting of three horizontal lines, representing a code list or enumeration. |
| type       | restriction of <b>xs:int</b>   |
| properties | isRef 0<br>content simple  |

complexType **SIIPositionType**

diagram

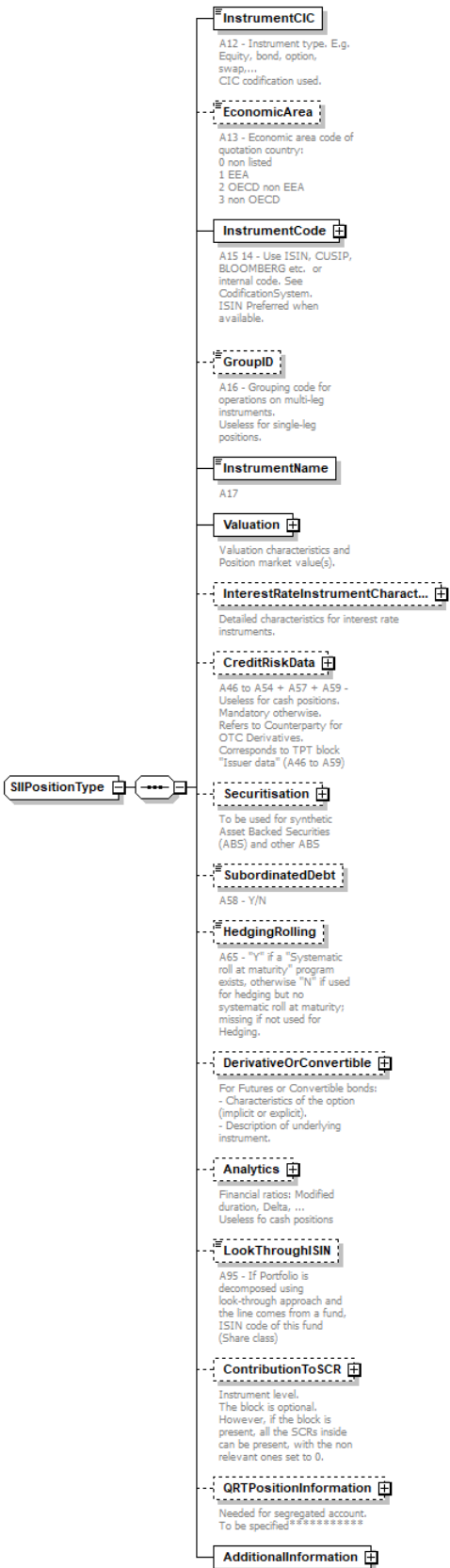

|          |   |
|----------|---|
| children | <a href="#">InstrumentCIC</a> <a href="#">EconomicArea</a> <a href="#">InstrumentCode</a> <a href="#">GroupID</a> <a href="#">InstrumentName</a> <a href="#">Valuation</a> <a href="#">InterestRateInstrumentCharacteristics</a> <a href="#">CreditRiskData</a> <a href="#">Securitisation</a> <a href="#">SubordinatedDebt</a> <a href="#">HedgingRolling</a> <a href="#">DerivativeOrConvertible</a> <a href="#">Analytics</a> <a href="#">LookThroughISIN</a> <a href="#">ContributionToSCR</a> <a href="#">QRTPositionInformation</a> <a href="#">AdditionalInformation</a> |
| used by  | element <a href="#">SolvencyIIPortfolioType/Positions/Position</a>  |

#### element [SolvencyIIPortfolioType/InstrumentCIC](#)

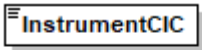
| diagram    |  <p>A12 - Instrument type. E.g. Equity, bond, option, swap, ...<br/>CIC codification used.</p>   |            |       |            |           |   |  |           |   |  |         |                                    |  |
|------------|---|------------|-------|------------|-----------|---|--|-----------|---|--|---------|------------------------------------|--|
| type       | <a href="#">CICCodeType</a>   |            |       |            |           |   |  |           |   |  |         |                                    |  |
| properties | isRef 0<br>content simple   |            |       |            |           |   |  |           |   |  |         |                                    |  |
| facets     | <table border="1"> <thead> <tr> <th>Kind</th> <th>Value</th> <th>annotation</th> </tr> </thead> <tbody> <tr> <td>minLength</td> <td>4</td> <td></td> </tr> <tr> <td>maxLength</td> <td>4</td> <td></td> </tr> <tr> <td>pattern</td> <td>([A-Z]{2}([A-F] [0-9]){1})[1-9]{1}</td> <td></td> </tr> </tbody> </table> | Kind       | Value | annotation | minLength | 4 |  | maxLength | 4 |  | pattern | ([A-Z]{2}([A-F] [0-9]){1})[1-9]{1} |  |
| Kind       | Value   | annotation |       |            |           |   |  |           |   |  |         |                                    |  |
| minLength  | 4   |            |       |            |           |   |  |           |   |  |         |                                    |  |
| maxLength  | 4   |            |       |            |           |   |  |           |   |  |         |                                    |  |
| pattern    | ([A-Z]{2}([A-F] [0-9]){1})[1-9]{1}  |            |       |            |           |   |  |           |   |  |         |                                    |  |
| annotation | documentation<br>A12 - Instrument type. E.g. Equity, bond, option, swap, ...<br>CIC codification used.  |            |       |            |           |   |  |           |   |  |         |                                    |  |

#### element [SolvencyIIPortfolioType/EconomicArea](#)

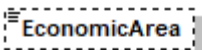
| diagram      |  <p>A13 - Economic area code of quotation country:<br/>0 non listed<br/>1 EEA<br/>2 OECD non EEA<br/>3 non OECD</p>                                |            |       |            |              |   |  |              |   |  |
|--------------|---|------------|-------|------------|--------------|---|--|--------------|---|--|
| type         | <a href="#">EconomicAreaType</a>  |            |       |            |              |   |  |              |   |  |
| properties   | isRef 0<br>minOcc 0<br>maxOcc 1<br>content simple   |            |       |            |              |   |  |              |   |  |
| facets       | <table border="1"> <thead> <tr> <th>Kind</th> <th>Value</th> <th>annotation</th> </tr> </thead> <tbody> <tr> <td>minInclusive</td> <td>0</td> <td></td> </tr> <tr> <td>maxInclusive</td> <td>3</td> <td></td> </tr> </tbody> </table> | Kind       | Value | annotation | minInclusive | 0 |  | maxInclusive | 3 |  |
| Kind         | Value   | annotation |       |            |              |   |  |              |   |  |
| minInclusive | 0   |            |       |            |              |   |  |              |   |  |
| maxInclusive | 3   |            |       |            |              |   |  |              |   |  |
| annotation   | documentation<br>A13 - Economic area code of quotation country:<br>0 non listed<br>1 EEA<br>2 OECD non EEA<br>3 non OECD  |            |       |            |              |   |  |              |   |  |

element **SIIPositionType/InstrumentCode**

|                   |  |
|-------------------|--|
| <p>diagram</p>    |  |
| <p>type</p>       | <p><a href="#">SIISecurityCodificationType</a></p>   |
| <p>properties</p> | <p>isRef 0<br/>content complex</p>   |
| <p>children</p>   | <p><a href="#">CodificationSystem</a> <a href="#">Code</a></p>   |
| <p>annotation</p> | <p>documentation<br/>A15 14 - Use ISIN, CUSIP, BLOOMBERG etc. or internal code. See CodificationSystem. ISIN Preferred when available.</p> |

element **SIIPositionType/GroupID**

|                |                         |
|----------------|-------------------------|
| <p>diagram</p> |                         |
| <p>type</p>    | <p><b>xs:string</b></p> |

|            |  |
|------------|--|
| properties | isRef 0<br>minOcc 0<br>maxOcc 1<br>content simple  |
| annotation | documentation<br>A16 - Grouping code for operations on multi-leg instruments.<br>Useless for single-leg positions. |

element **SIIPositionType/InstrumentName**

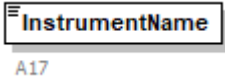
|            |   |
|------------|---|
| diagram    |  |
| type       | <b>xs:string</b>  |
| properties | isRef 0<br>content simple   |
| annotation | documentation<br>A17  |

# element SIIPositionType/Valuation

diagram

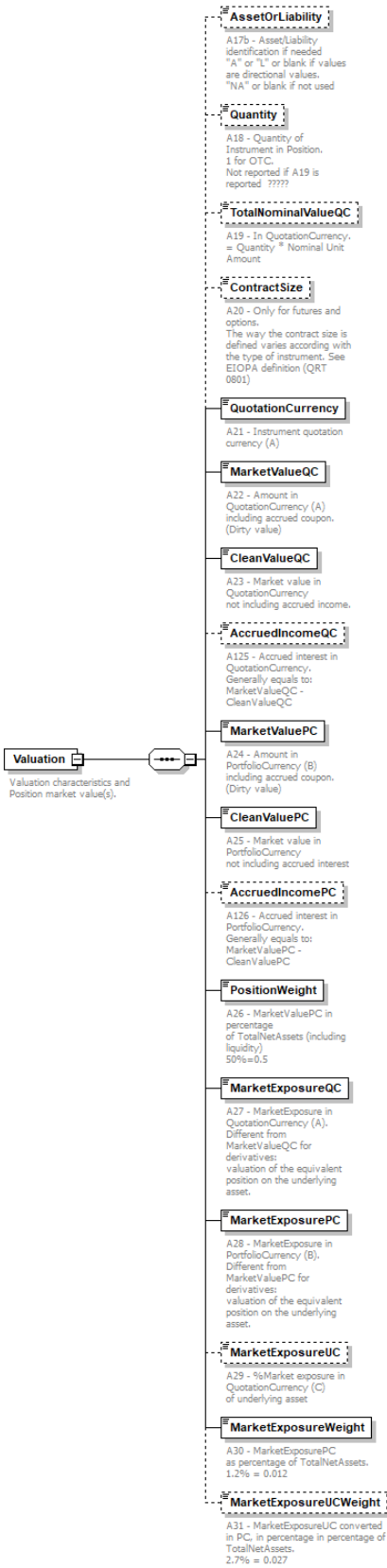



|            |  |
|------------|--|
| properties | isRef 0<br>content complex   |
| children   | <a href="#">AssetOrLiability</a> <a href="#">Quantity</a> <a href="#">TotalNominalValueQC</a> <a href="#">ContractSize</a> <a href="#">QuotationCurrency</a> <a href="#">MarketValueQC</a> <a href="#">CleanValueQC</a> <a href="#">AccruedIncomeQC</a> <a href="#">MarketValuePC</a> <a href="#">CleanValuePC</a> <a href="#">AccruedIncomePC</a> <a href="#">PositionWeight</a> <a href="#">MarketExposureQC</a> <a href="#">MarketExposurePC</a> <a href="#">MarketExposureUC</a> <a href="#">MarketExposureWeight</a> <a href="#">MarketExposureUCWeight</a> |
| annotation | documentation<br>Valuation characteristics and<br>Position market value(s).  |

element **SIIPositionType/Valuation/AssetOrLiability**

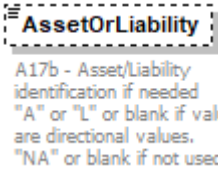
|            |  |
|------------|--|
| diagram    |   |
| type       | restriction of <b>xs:string</b>  |
| properties | isRef 0<br>minOcc 0<br>maxOcc 1<br>content simple  |
| annotation | documentation<br>A17b - Asset/Liability identification if needed<br>"A" or "L" or blank if values are directional values.<br>"NA" or blank if not used |

element **SIIPositionType/Valuation/Quantity**

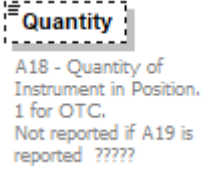
|            |   |
|------------|---|
| diagram    |                                |
| type       | <b>xs:decimal</b>   |
| properties | isRef 0<br>minOcc 0<br>maxOcc 1<br>content simple   |
| annotation | documentation<br>A18 - Quantity of Instrument in Position.<br>1 for OTC.<br>Not reported if A19 is reported ????? |

element **SIIPositionType/Valuation/TotalNominalValueQC**

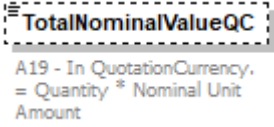
|            |   |
|------------|---|
| diagram    |  |
| type       | <b>xs:decimal</b>   |
| properties | isRef 0<br>minOcc 0<br>maxOcc 1   |

|            |  |
|------------|--|
|            | content simple   |
| annotation | documentation<br>A19 - In QuotationCurrency.<br>= Quantity * Nominal Unit Amount |

element **SIIPositionType/Valuation/ContractSize**

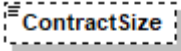
|            |   |
|------------|---|
| diagram    |  <p>A20 - Only for futures and options.<br/>The way the contract size is defined varies according with the type of instrument. See EIOPA definition (QRT 0801)</p> |
| type       | <b>xs:decimal</b>   |
| properties | isRef 0<br>minOcc 0<br>maxOcc 1<br>content simple   |
| annotation | documentation<br>A20 - Only for futures and options.<br>The way the contract size is defined varies according with the type of instrument. See EIOPA definition (QRT 0801)  |

element **SIIPositionType/Valuation/QuotationCurrency**

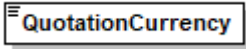
|            |   |
|------------|---|
| diagram    |  <p>A21 - Instrument quotation currency (A)</p> |
| type       | <a href="#">ISOCurrencyCodeType</a>   |
| properties | isRef 0<br>content simple   |
| facets     | Kind Value annotation<br>minLength 3<br>maxLength 3<br>pattern [A-Z]{3}   |
| annotation | documentation<br>A21 - Instrument quotation currency (A)  |

element **SIIPositionType/Valuation/MarketValueQC**

|            |  |
|------------|--|
| diagram    |  <p>A22 - Amount in QuotationCurrency (A) including accrued coupon. (Dirty value)</p> |
| type       | <b>xs:decimal</b>  |
| properties | isRef 0<br>content simple  |
| annotation | documentation<br>A22 - Amount in QuotationCurrency (A) including accrued coupon. (Dirty value)   |

element **SIIPositionType/Valuation/CleanValueQC**

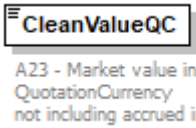
|            |  |
|------------|--|
| diagram    |  <p>A23 - Market value in QuotationCurrency not including accrued income.</p> |
| type       | <b>xs:decimal</b>  |
| properties | isRef 0<br>content simple  |
| annotation | documentation<br>A23 - Market value in QuotationCurrency not including accrued income.   |

element **SIIPositionType/Valuation/AccruedIncomeQC**

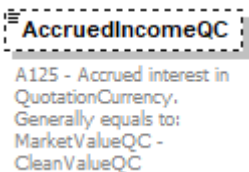
|            |  |
|------------|--|
| diagram    |  <p>A125 - Accrued interest in QuotationCurrency.<br/>Generally equals to:<br/>MarketValueQC -<br/>CleanValueQC</p> |
| type       | <b>xs:decimal</b>  |
| properties | isRef 0<br>minOcc 0<br>maxOcc 1<br>content simple  |
| annotation | documentation<br>A125 - Accrued interest in QuotationCurrency.<br>Generally equals to: MarketValueQC - CleanValueQC  |

element **SIIPositionType/Valuation/MarketValuePC**

|            |  |
|------------|--|
| diagram    |  <p>A24 - Amount in PortfolioCurrency (B) including accrued coupon.<br/>(Dirty value)</p> |
| type       | <b>xs:decimal</b>  |
| properties | isRef 0<br>content simple  |
| annotation | documentation<br>A24 - Amount in PortfolioCurrency (B) including accrued coupon.<br>(Dirty value)  |

element **SIIPositionType/Valuation/CleanValuePC**

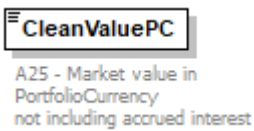
|         |   |
|---------|---|
| diagram |  <p>A25 - Market value in PortfolioCurrency not including accrued interest</p> |
| type    | <b>xs:decimal</b>   |

|            |  |
|------------|--|
| properties | isRef 0<br>content simple  |
| annotation | documentation<br>A25 - Market value in PortfolioCurrency<br>not including accrued interest |

element **SIIPositionType/Valuation/AccruedIncomePC**

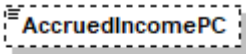
|            |  |
|------------|--|
| diagram    |  <p>A126 - Accrued interest in PortfolioCurrency.<br/>Generally equals to:<br/>MarketValuePC - CleanValuePC</p> |
| type       | <b>xs:decimal</b>  |
| properties | isRef 0<br>minOcc 0<br>maxOcc 1<br>content simple  |
| annotation | documentation<br>A126 - Accrued interest in PortfolioCurrency.<br>Generally equals to: MarketValuePC - CleanValuePC  |

element **SIIPositionType/Valuation/PositionWeight**

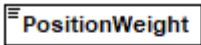
|            |   |
|------------|---|
| diagram    |  <p>A26 - MarketValuePC in percentage of TotalNetAssets (including liquidity)<br/>50%=0.5</p> |
| type       | <b>xs:decimal</b>   |
| properties | isRef 0<br>content simple   |
| annotation | documentation<br>A26 - MarketValuePC in percentage of TotalNetAssets (including liquidity)<br>50%=0.5   |

element **SIIPositionType/Valuation/MarketExposureQC**

|            |   |
|------------|---|
| diagram    |  <p>A27 - MarketExposure in QuotationCurrency (A).<br/>Different from MarketValueQC for derivatives:<br/>valuation of the equivalent position on the underlying asset.</p> |
| type       | <b>xs:decimal</b>   |
| properties | isRef 0<br>content simple   |
| annotation | documentation<br>A27 - MarketExposure in QuotationCurrency (A).<br>Different from MarketValueQC for derivatives:  |

|  |   |
|--|---|
|  | valuation of the equivalent position on the underlying asset. |
|--|---|

element **SIIPositionType/Valuation/MarketExposurePC**

|            |   |
|------------|---|
| diagram    |  <p>A28 - MarketExposure in PortfolioCurrency (B).<br/>Different from MarketValuePC for derivatives:<br/>valuation of the equivalent position on the underlying asset.</p> |
| type       | <b>xs:decimal</b>   |
| properties | isRef 0<br>content simple   |
| annotation | documentation<br>A28 - MarketExposure in PortfolioCurrency (B).<br>Different from MarketValuePC for derivatives:<br>valuation of the equivalent position on the underlying asset.   |

element **SIIPositionType/Valuation/MarketExposureUC**

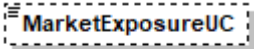
|            |  |
|------------|--|
| diagram    |  <p>A29 - %Market exposure in QuotationCurrency (C)<br/>of underlying asset</p> |
| type       | <b>xs:decimal</b>  |
| properties | isRef 0<br>minOcc 0<br>maxOcc 1<br>content simple  |
| annotation | documentation<br>A29 - %Market exposure in QuotationCurrency (C)<br>of underlying asset  |

element **SIIPositionType/Valuation/MarketExposureWeight**

|            |   |
|------------|---|
| diagram    |  <p>A30 - MarketExposurePC<br/>as percentage of TotalNetAssets.<br/>1.2% = 0.012</p> |
| type       | <b>xs:decimal</b>   |
| properties | isRef 0<br>content simple   |
| annotation | documentation<br>A30 - MarketExposurePC<br>as percentage of TotalNetAssets.<br>1.2% = 0.012   |

element **SIIPositionType/Valuation/MarketExposureUCWeight**

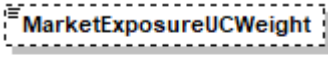
|            |  |
|------------|--|
| diagram    |  <p>A31 - MarketExposureUC converted in PC, in percentage in percentage of TotalNetAssets.<br/>2.7% = 0.027</p> |
| type       | <b>xs:decimal</b>  |
| properties | isRef 0<br>minOcc 0<br>maxOcc 1<br>content simple  |
| annotation | documentation<br>A31 - MarketExposureUC converted in PC, in percentage in percentage of TotalNetAssets.<br>2.7% = 0.027  |

element **SIIPositionType/InterestRateInstrumentCharacteristics**

|                   |   |
|-------------------|---|
| <p>diagram</p>    |   |
| <p>properties</p> | <p>isRef 0<br/> minOcc 0<br/> maxOcc 1<br/> content complex</p>   |
| <p>children</p>   | <p><a href="#">RateType</a> <a href="#">CouponRate</a> <a href="#">VariableRate</a> <a href="#">CouponFrequency</a> <a href="#">EffectiveDateOfInstrument</a> <a href="#">Redemption</a> <a href="#">EmbeddedOption</a> <a href="#">ValuationYieldCurve</a></p> |
| <p>annotation</p> | <p>documentation<br/> Detailed characteristics for interest rate instruments.</p>   |

element **SIIPositionType/InterestRateInstrumentCharacteristics/RateType**

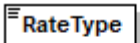
|            |   |
|------------|---|
| diagram    |  <p>A32 - Type of interest rate:<br/>"Fixed" (fixe), "Variable"<br/>(révisable), "Floating"<br/>(variable)</p> |
| type       | restriction of <b>xs:string</b>   |
| properties | isRef 0<br>content simple   |
| annotation | documentation<br>A32 - Type of interest rate:<br>"Fixed" (fixe), "Variable" (révisable), "Floating" (variable)  |

element **SIIPositionType/InterestRateInstrumentCharacteristics/CouponRate**

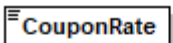
|            |   |
|------------|---|
| diagram    |  <p>A33 - Next annual coupon<br/>rate in percentage<br/>(known, or estimated for<br/>Floating).<br/>3.5% has to be written "3.5"</p> |
| type       | <a href="#">PercentageType</a>  |
| properties | isRef 0<br>content simple   |
| annotation | documentation<br>A33 - Next annual coupon rate in percentage<br>(known, or estimated for Floating).<br>3.5% has to be written "3.5"   |

element **SIIPositionType/InterestRateInstrumentCharacteristics/VariableRate**

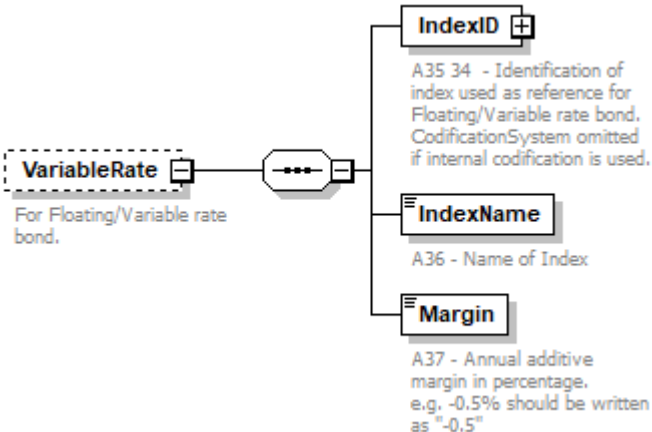
|            |  |
|------------|--|
| diagram    |  <p><b>VariableRate</b><br/>For Floating/Variable rate<br/>bond.</p> <p><b>IndexID</b><br/>A35 34 - Identification of<br/>index used as reference for<br/>Floating/Variable rate bond.<br/>CodificationSystem omitted<br/>if internal codification is used.</p> <p><b>IndexName</b><br/>A36 - Name of Index</p> <p><b>Margin</b><br/>A37 - Annual additive<br/>margin in percentage.<br/>e.g. -0.5% should be written<br/>as "-0.5"</p> |
| properties | isRef 0<br>minOcc 0<br>maxOcc 1<br>content complex   |
| children   | <a href="#">IndexID</a> <a href="#">IndexName</a> <a href="#">Margin</a>   |
| annotation | documentation<br>For Floating/Variable rate bond.  |



element **SIIPositionType/InterestRateInstrumentCharacteristics/VariableRate/IndexID**

|            |   |
|------------|---|
| diagram    | <p>The diagram illustrates the structure of the <b>IndexID</b> element. It is connected to a <b>CodificationType</b> container. Inside <b>CodificationType</b>, there are two sub-elements: <b>CodificationSystem</b> and <b>Code</b>. <b>CodificationSystem</b> is described as "Codification system used." and <b>Code</b> is described as "Value of code in CodificationSystem".</p> |
| type       | <a href="#">CodificationType</a>  |
| properties | isRef 0<br>content complex  |
| children   | <a href="#">CodificationSystem</a> <a href="#">Code</a>   |
| annotation | documentation<br>A35 34 - Identification of index used as reference for Floating/Variable rate bond. CodificationSystem omitted if internal codification is used.   |

element **SIIPositionType/InterestRateInstrumentCharacteristics/VariableRate/IndexName**

|            |   |
|------------|---|
| diagram    | <p>The diagram shows the <b>IndexName</b> element, which is a simple string type. Its documentation is "A36 - Name of Index".</p> |
| type       | <b>xs:string</b>  |
| properties | isRef 0<br>content simple   |
| annotation | documentation<br>A36 - Name of Index  |

element **SIIPositionType/InterestRateInstrumentCharacteristics/VariableRate/Margin**

|            |   |
|------------|---|
| diagram    | <p>The diagram shows the <b>Margin</b> element, which is a percentage type. Its documentation is "A37 - Annual additive margin in percentage. e.g. -0.5% should be written as "-0.5".</p> |
| type       | <a href="#">PercentageType</a>  |
| properties | isRef 0<br>content simple   |
| annotation | documentation<br>A37 - Annual additive margin in percentage. e.g. -0.5% should be written as "-0.5"   |

element **SIIPositionType/InterestRateInstrumentCharacteristics/CouponFrequency**

|            |   |
|------------|---|
| diagram    |  <p>A38 - Coupon payment frequency as number of coupons per year<br/> 0 = other case than<br/> 1= annual<br/> 2= biannual<br/> 4= quarterly<br/> 12= monthly<br/> 52= weekly</p> |
| type       | <a href="#">SIICouponFrequencyType</a>  |
| properties | isRef 0<br>content simple   |
| annotation | documentation<br>A38 - Coupon payment frequency as number of coupons per year<br>0 = other case than<br>1= annual<br>2= biannual<br>4= quarterly<br>12= monthly<br>52= weekly   |

element **SIIPositionType/InterestRateInstrumentCharacteristics/EffectiveDateOfInstrument**

|            |   |
|------------|---|
| diagram    |  <p>A63 - Start date to accrue interest.</p> |
| type       | <b>xs:date</b>  |
| properties | isRef 0<br>minOcc 0<br>maxOcc 1<br>content simple   |
| annotation | documentation<br>A63 - Start date to accrue interest.   |

element **SIIPositionType/InterestRateInstrumentCharacteristics/Redemption**

|            |  |
|------------|--|
| diagram    |  |
| type       | <a href="#">RedemptionType</a>   |
| properties | isRef 0<br>content complex   |
| children   | <a href="#">MaturityDate</a> <a href="#">Type</a> <a href="#">Rate</a> |
| annotation | documentation<br>A39 40 41 - Redemption details                        |

element **SIIPositionType/InterestRateInstrumentCharacteristics/EmbeddedOption**

|            |  |
|------------|--|
| diagram    |  |
| properties | isRef 0<br>minOcc 0<br>maxOcc 1<br>content complex |

|            |  |
|------------|--|
| children   | <a href="#">CallPutType</a> <a href="#">CallPutDate</a> <a href="#">OptionDirection</a> <a href="#">StrikePrice</a>                          |
| annotation | documentation<br>To be used only for a callable / puttable bond.<br>The embedded option is described only for the first option date to come. |

element **SIIPositionType/InterestRateInstrumentCharacteristics/EmbeddedOption/CallPutType**

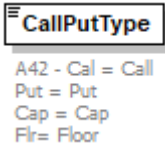
|            |   |
|------------|---|
| diagram    |  |
| type       | restriction of <b>xs:string</b>   |
| properties | isRef 0<br>content simple   |
| annotation | documentation<br>A42 - Cal = Call<br>Put = Put<br>Cap = Cap<br>Flr= Floor         |

element **SIIPositionType/InterestRateInstrumentCharacteristics/EmbeddedOption/CallPutDate**

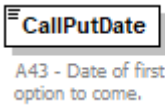
|            |  |
|------------|--|
| diagram    |  |
| type       | <b>xs:date</b>   |
| properties | isRef 0<br>content simple  |
| annotation | documentation<br>A43 - Date of first Call / Put option to come.                    |

element **SIIPositionType/InterestRateInstrumentCharacteristics/EmbeddedOption/OptionDirection**

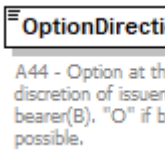
|            |  |
|------------|--|
| diagram    |                   |
| type       | restriction of <b>xs:string</b>  |
| properties | isRef 0<br>content simple  |
| facets     | Kind Value annotation<br>minLength 1<br>maxLength 1  |
| annotation | documentation<br>A44 - Option at the discretion of issuer(I) or bearer(B). "O" if both are possible. |

element **SIIPositionType/InterestRateInstrumentCharacteristics/EmbeddedOption/StrikePrice**

|            |  |
|------------|--|
| diagram    |  <p><b>StrikePrice</b></p> <p>A45 - Strike price of first optional Call / Put as a percentage of nominal amount.<br/>95%=0.95</p> |
| type       | <b>xs:decimal</b>  |
| properties | isRef 0<br>content simple  |
| annotation | documentation<br>A45 - Strike price of first optional Call / Put as a percentage of nominal amount.<br>95%=0.95  |

element **SIIPositionType/InterestRateInstrumentCharacteristics/ValuationYieldCurve**

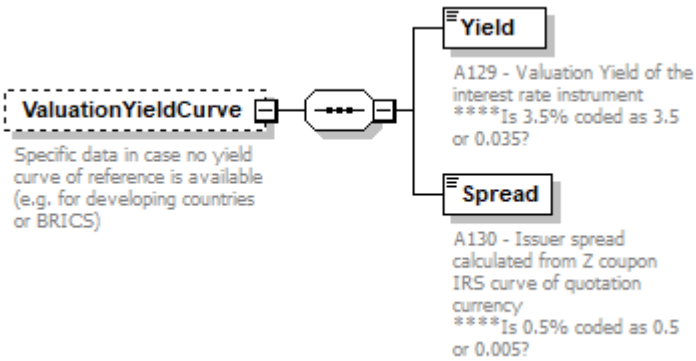
|            |   |
|------------|---|
| diagram    |  <p><b>ValuationYieldCurve</b></p> <p>Specific data in case no yield curve of reference is available (e.g. for developing countries or BRICS)</p> <p><b>Yield</b></p> <p>A129 - Valuation Yield of the interest rate instrument<br/>****Is 3.5% coded as 3.5 or 0.035?</p> <p><b>Spread</b></p> <p>A130 - Issuer spread calculated from Z coupon IRS curve of quotation currency<br/>****Is 0.5% coded as 0.5 or 0.005?</p> |
| properties | isRef 0<br>minOcc 0<br>maxOcc 1<br>content complex  |
| children   | <a href="#">Yield Spread</a>  |
| annotation | documentation<br>Specific data in case no yield curve of reference is available (e.g. for developing countries or BRICS)  |

element **SIIPositionType/InterestRateInstrumentCharacteristics/ValuationYieldCurve/Yield**

|            |  |
|------------|--|
| diagram    |  <p><b>Yield</b></p> <p>A129 - Valuation Yield of the interest rate instrument<br/>****Is 3.5% coded as 3.5 or 0.035?</p> |
| type       | <b>xs:decimal</b>  |
| properties | isRef 0<br>content simple  |
| annotation | documentation<br>A129 - Valuation Yield of the interest rate instrument<br>****Is 3.5% coded as 3.5 or 0.035?  |

element **SIIPositionType/InterestRateInstrumentCharacteristics/ValuationYieldCurve/Spread**

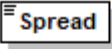
|                   |  |
|-------------------|--|
| <p>diagram</p>    |  <p>A130 - Issuer spread<br/>         calculated from Z coupon<br/>         IRS curve of quotation<br/>         currency<br/>         ****Is 0.5% coded as 0.5<br/>         or 0.005?</p> |
| <p>type</p>       | <p><b>xs:decimal</b></p>   |
| <p>properties</p> | <p>isRef 0<br/>         content simple</p>   |
| <p>annotation</p> | <p>documentation<br/>         A130 - Issuer spread calculated from Z coupon IRS curve of quotation currency<br/>         ****Is 0.5% coded as 0.5 or 0.005?</p>  |

element **SIIPositionType/CreditRiskData**

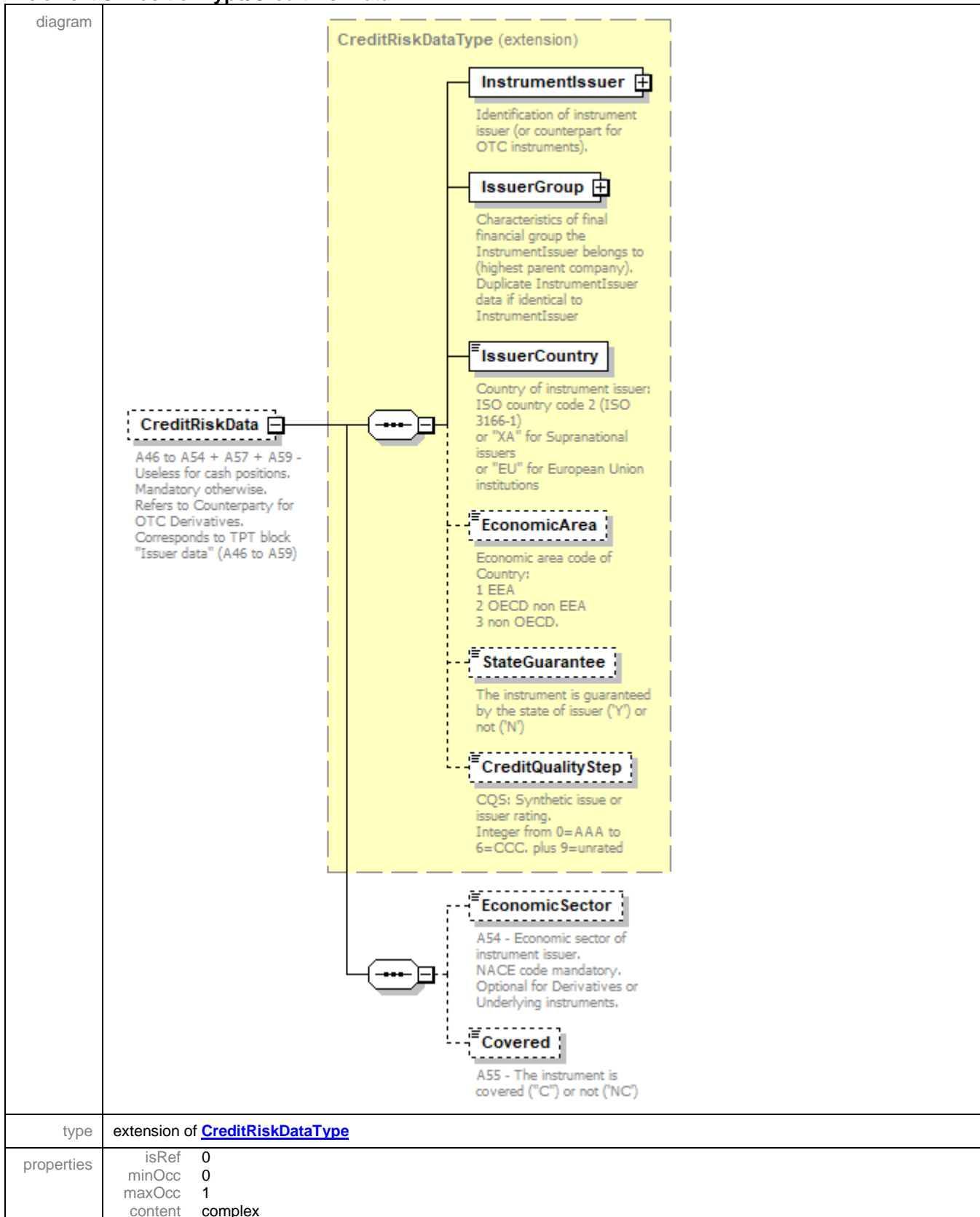

|            |   |
|------------|---|
| children   | <a href="#">InstrumentIssuer</a> <a href="#">IssuerGroup</a> <a href="#">IssuerCountry</a> <a href="#">EconomicArea</a> <a href="#">StateGuarantee</a> <a href="#">CreditQualityStep</a> <a href="#">EconomicSector</a> <a href="#">Covered</a> |
| annotation | documentation<br>A46 to A54 + A57 + A59 - Useless for cash positions.<br>Mandatory otherwise.<br>Refers to Counterparty for OTC Derivatives.<br>Corresponds to TPT block "Issuer data" (A46 to A59)   |

element **SIIPositionType/CreditRiskData/EconomicSector**

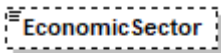
|            |   |
|------------|---|
| diagram    |  <p><b>Economic Sector</b></p> <p>A54 - Economic sector of instrument issuer.<br/>NACE code mandatory.<br/>Optional for Derivatives or Underlying instruments.</p> |
| type       | <a href="#">NACECodeType</a>  |
| properties | isRef 0<br>minOcc 0<br>maxOcc 1<br>content simple   |
| facets     | Kind Value annotation<br>minLength 1<br>maxLength 7<br>pattern ([A-Z]{1}[0-9\.\.]{0,6})   |
| annotation | documentation<br>A54 - Economic sector of instrument issuer.<br>NACE code mandatory.<br>Optional for Derivatives or Underlying instruments.   |

element **SIIPositionType/CreditRiskData/Covered**

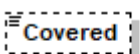
|            |  |
|------------|--|
| diagram    |  <p><b>Covered</b></p> <p>A55 - The instrument is covered ("C") or not ("NC")</p> |
| type       | restriction of <b>xs:string</b>  |
| properties | isRef 0<br>minOcc 0<br>maxOcc 1<br>content simple  |
| annotation | documentation<br>A55 - The instrument is covered ("C") or not ("NC")   |



element **SIIPositionType/Securitisation**

|            |   |
|------------|---|
| diagram    | <p><b>Securisation</b><br/>To be used for synthetic Asset Backed Securities (ABS) and other ABS</p> <p><b>Securised</b><br/>A56 - 0=No<br/>1=Securitisation type 1<br/>2=Securitisation type 2<br/>3= Re-securitisation<br/>4=Non compliant</p> <p><b>TrancheLevel</b><br/>A58b - Seniority</p> |
| properties | isRef 0<br>minOcc 0<br>maxOcc 1<br>content complex  |
| children   | <a href="#">Securised</a> <a href="#">TrancheLevel</a>  |
| annotation | documentation<br>To be used for synthetic Asset Backed Securities (ABS) and other ABS   |

element **SIIPositionType/Securitisation/Securised**

|            |   |
|------------|---|
| diagram    | <p><b>Securised</b><br/>A56 - 0=No<br/>1=Securitisation type 1<br/>2=Securitisation type 2<br/>3= Re-securitisation<br/>4=Non compliant</p> |
| type       | restriction of <b>xs:int</b>  |
| properties | isRef 0<br>content simple   |
| facets     | Kind Value annotation<br>minInclusive 0<br>maxInclusive 4   |
| annotation | documentation<br>A56 - 0=No<br>1=Securitisation type 1<br>2=Securitisation type 2<br>3= Re-securitisation<br>4=Non compliant                |

element **SIIPositionType/Securitisation/TrancheLevel**

|            |   |
|------------|---|
| diagram    | <p><b>TrancheLevel</b><br/>A58b - Seniority</p>   |
| type       | <b>xs:string</b>                                  |
| properties | isRef 0<br>minOcc 0<br>maxOcc 1<br>content simple |
| annotation | documentation<br>A58b - Seniority                 |

element **SIIPositionType/SubordinatedDebt**

|            |   |
|------------|---|
| diagram    |   |
| type       | <a href="#">YesNoL1Type</a>                         |
| properties | isRef 0<br>minOcc 0<br>maxOcc 1<br>content simple   |
| facets     | Kind Value annotation<br>minLength 1<br>maxLength 1 |
| annotation | documentation<br>A58 - Y/N                          |

element **SIIPositionType/HedgingRolling**

|            |  |
|------------|--|
| diagram    |  |
| type       | restriction of <b>xs:string</b>  |
| properties | isRef 0<br>minOcc 0<br>maxOcc 1<br>content simple  |
| annotation | documentation<br>A65 - "Y" if a "Systematic roll at maturity" program exists, otherwise "N" if used for hedging but no systematic roll at maturity; missing if not used for Hedging. |

element **SIIPositionType/DerivativeOrConvertible**

|            |  |
|------------|--|
| diagram    |  |
| properties | isRef 0<br>minOcc 0<br>maxOcc 1<br>content complex |

|            |  |
|------------|--|
| children   | <a href="#">OptionCharacteristics</a> <a href="#">UnderlyingInstrument</a> <a href="#">MaturityDate</a>  |
| annotation | documentation<br>For Futures or Convertible bonds:<br>- Characteristics of the option (implicit or explicit).<br>- Description of underlying instrument. |

element **SIIPositionType/DerivativeOrConvertible/OptionCharacteristics**

|            |   |
|------------|---|
| diagram    | <p><b>OptionCharacteristics</b></p> <p>For an Option, description of its characteristics.<br/>For a convertible bond, description of optional conversion.<br/>Useless for single futures contract.</p> <p><b>CallPutType</b></p> <p>A60 - Option type<br/>"Cal"=call<br/>"Put"=put<br/>"Cap"=cap<br/>"Flr"=floor</p> <p><b>StrikePrice</b></p> <p>A61 - Strike price of the option in same unit as price of underlying instrument.</p> <p><b>ConversionRatio</b></p> <p>A62 - Quantity of UnderlyingInstrument obtained for one "Instrument".</p> <p><b>ExerciseType</b></p> <p>A64 - Option style: AMERICAN, EUROPEAN, ASIATIC, BERMUDIAN<br/>Optional for convertibles</p> <p><b>Convertible</b></p> <p>Only for Convertible bond.<br/>For pricing using shock modelling.</p> |
| properties | isRef 0<br>minOcc 0<br>maxOcc 1<br>content complex  |
| children   | <a href="#">CallPutType</a> <a href="#">StrikePrice</a> <a href="#">ConversionRatio</a> <a href="#">ExerciseType</a> <a href="#">Convertible</a>  |
| annotation | documentation<br>For an Option, description of its characteristics.<br>For a convertible bond, description of optional conversion.<br>Useless for single futures contract.  |

element **SIIPositionType/DerivativeOrConvertible/OptionCharacteristics/CallPutType**

|            |   |
|------------|---|
| diagram    | <p><b>CallPutType</b></p> <p>A60 - Option type<br/>"Cal"=call<br/>"Put"=put<br/>"Cap"=cap<br/>"Flr"=floor</p> |
| type       | restriction of <b>xs:string</b>   |
| properties | isRef 0   |

|            |   |
|------------|---|
|            | content simple  |
| annotation | documentation<br>A60 - Option type<br>"Cal"=call<br>"Put"=put<br>"Cap"=cap<br>"Flr"=floor |

element **SIIPositionType/DerivativeOrConvertible/OptionCharacteristics/StrikePrice**

|            |   |
|------------|---|
| diagram    |  <p>A61 - Strike price of the option in same unit as price of underlying instrument.</p> |
| type       | <b>xs:decimal</b>   |
| properties | isRef 0<br>content simple   |
| annotation | documentation<br>A61 - Strike price of the option in same unit as price of underlying instrument.   |

element **SIIPositionType/DerivativeOrConvertible/OptionCharacteristics/ConversionRatio**

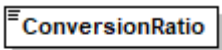
|            |  |
|------------|--|
| diagram    |  <p>A62 - Quantity of UnderlyingInstrument obtained for one "Instrument".</p> |
| type       | <b>xs:decimal</b>  |
| properties | isRef 0<br>content simple  |
| annotation | documentation<br>A62 - Quantity of UnderlyingInstrument obtained for one "Instrument".   |

element **SIIPositionType/DerivativeOrConvertible/OptionCharacteristics/ExerciseType**

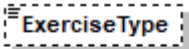
|            |   |
|------------|---|
| diagram    |  <p>A64 - Option style:<br/>AMerican, EUropean,<br/>ASiatic, BErmudian<br/>Optional for convertibles</p> |
| type       | restriction of <b>xs:string</b>   |
| properties | isRef 0<br>minOcc 0<br>maxOcc 1<br>content simple   |
| facets     | Kind Value annotation<br>minLength 2<br>maxLength 2   |
| annotation | documentation<br>A64 - Option style: American, European, Asiatic, Bermudian<br>Optional for convertibles  |

element **SIIPositionType/DerivativeOrConvertible/OptionCharacteristics/Convertible**

|            |  |
|------------|--|
| diagram    | <p><b>Convertible</b><br/>Only for Convertible bond.<br/>For pricing using shock modelling.</p> <p><b>BondFloor</b><br/>A127 - Lowest value of a convertible bond expressed in quotation currency, at current issuer spread</p> <p><b>OptionPremium</b><br/>A128 - Premium of the embedded option of a convertible bond in quotation currency.</p> |
| properties | isRef 0<br>minOcc 0<br>maxOcc 1<br>content complex   |
| children   | <a href="#">BondFloor</a> <a href="#">OptionPremium</a>  |
| annotation | documentation<br>Only for Convertible bond.<br>For pricing using shock modelling.  |

element **SIIPositionType/DerivativeOrConvertible/OptionCharacteristics/Convertible/BondFloor**

|            |   |
|------------|---|
| diagram    | <p><b>BondFloor</b><br/>A127 - Lowest value of a convertible bond expressed in quotation currency, at current issuer spread</p> |
| type       | <b>xs:decimal</b>   |
| properties | isRef 0<br>minOcc 0<br>maxOcc 1<br>content simple   |
| annotation | documentation<br>A127 - Lowest value of a convertible bond expressed in quotation currency, at current issuer spread            |

element **SIIPositionType/DerivativeOrConvertible/OptionCharacteristics/Convertible/OptionPremium**

|            |  |
|------------|--|
| diagram    | <p><b>OptionPremium</b><br/>A128 - Premium of the embedded option of a convertible bond in quotation currency.</p> |
| type       | <b>xs:decimal</b>  |
| properties | isRef 0<br>minOcc 0<br>maxOcc 1<br>content simple  |
| annotation | documentation<br>A128 - Premium of the embedded option of a convertible bond in quotation currency.                |

element **SIIPositionType/DerivativeOrConvertible/UnderlyingInstrument**

|                   |   |
|-------------------|---|
| <p>diagram</p>    | <p><b>InstrumentCIC</b><br/>A67 - Instrument type. E.g. Equity, bond, option, swap,...<br/>CIC codification.</p> <p><b>InstrumentCode</b> <br/>A69 68 - Use ISIN, CUSIP, or OtherSecurityCodes/Name(of codification system) for BLOOMBERG, TELEKURS or Internal code</p> <p><b>InstrumentName</b><br/>A70 - Name of underlying instrument.</p> <p><b>Valuation</b> </p> <p><b>Coupon</b> <br/>If underlying instrument is an interest rate instrument.</p> <p><b>Redemption</b> <br/>A77 78 79 - Redemption details.<br/>If underlying instrument is an interest rate instrument.</p> <p><b>CreditRiskData</b> <br/>A80 to A89 - Issuer of underlying instrument (or counterparty for OTC instruments).</p> |
| <p>properties</p> | <p>isRef 0<br/>content complex</p>  |
| <p>children</p>   | <p><a href="#">InstrumentCIC</a> <a href="#">InstrumentCode</a> <a href="#">InstrumentName</a> <a href="#">Valuation</a> <a href="#">Coupon</a> <a href="#">Redemption</a> <a href="#">CreditRiskData</a></p>   |

element **SIIPositionType/DerivativeOrConvertible/UnderlyingInstrument/InstrumentCIC**

|                   |   |
|-------------------|---|
| <p>diagram</p>    | <p><b>InstrumentCIC</b> <br/>A67 - Instrument type. E.g. Equity, bond, option, swap,...<br/>CIC codification.</p> |
| <p>type</p>       | <p><a href="#">CICCodeType</a></p>  |
| <p>properties</p> | <p>isRef 0<br/>content simple</p>   |
| <p>facets</p>     | <p>Kind Value annotation<br/>minLength 4<br/>maxLength 4<br/>pattern ([A-Z]{2}([A-F] [0-9]){1}[1-9]{1})</p>       |

|            |  |
|------------|--|
| annotation | documentation<br>A67 - Instrument type. E.g. Equity, bond, option, swap,...<br>CIC codification. |
|------------|--|

element **SIIPositionType/DerivativeOrConvertible/UnderlyingInstrument/InstrumentCode**

|            |  |
|------------|--|
| diagram    | <p><b>InstrumentCode</b><br/>A69 68 - Use ISIN, CUSIP, or OtherSecurityCodes/Name(of codification system) for BLOOMBERG, TELEKURS or Internal code</p> <p><b>SII Security Codification Type</b></p> <p><b>CodificationSystem</b><br/>Codification system used. Integer corresponding to the following closed list:<br/>1 - ISO 6166 for ISIN code<br/>2 - CUSIP (The Committee on Uniform Securities Identification Procedures number assigned by the CUSIP Service Bureau for U.S. and Canadian companies)<br/>3 - SEDOL (Stock Exchange Daily Official List for the London Stock Exchange)<br/>4 - WKN (Wertpapier Kenn-Nummer, the alphanumeric German identification number)<br/>5 - Bloomberg Ticker (Bloomberg letters code that identify a company's securities)<br/>6 - BBGID (The Bloomberg Global ID)<br/>7 - Reuters RIC (Reuters instrument code)<br/>8 - FIGI (Financial Instrument Global Identifier)<br/>9 - Other code by members of the Association of National Numbering Agencies<br/>99 - Code attributed by the undertaking</p> <p><b>Code</b><br/>Value of code in CodificationSystem</p> |
| type       | <a href="#">SII Security Codification Type</a>   |
| properties | isRef 0<br>content complex   |
| children   | <a href="#">CodificationSystem</a> <a href="#">Code</a>  |
| annotation | documentation<br>A69 68 - Use ISIN, CUSIP, or OtherSecurityCodes/Name(of codification system) for BLOOMBERG, TELEKURS or Internal code   |

element **SIIPositionType/DerivativeOrConvertible/UnderlyingInstrument/InstrumentName**

|         |   |
|---------|---|
| diagram | <p><b>InstrumentName</b><br/>A70 - Name of underlying instrument.</p> |
|---------|---|

|            |   |
|------------|---|
| type       | <b>xs:string</b>                                      |
| properties | isRef 0<br>content simple                             |
| annotation | documentation<br>A70 - Name of underlying instrument. |

element **SIIPositionType/DerivativeOrConvertible/UnderlyingInstrument/Valuation**

|            |   |
|------------|---|
| diagram    |   |
| properties | isRef 0<br>content complex  |
| children   | <a href="#">Currency</a> <a href="#">MarketPrice</a> <a href="#">Country</a> <a href="#">EconomicArea</a> |

element **SIIPositionType/DerivativeOrConvertible/UnderlyingInstrument/Valuation/Currency**

|            |   |
|------------|---|
| diagram    |   |
| type       | <a href="#">ISOCurrencyCodeType</a>                                     |
| properties | isRef 0<br>content simple   |
| facets     | Kind Value annotation<br>minLength 3<br>maxLength 3<br>pattern [A-Z]{3} |
| annotation | documentation<br>A71 - Quotation currency (C)                           |

element **SIIPositionType/DerivativeOrConvertible/UnderlyingInstrument/Valuation/MarketPrice**

|         |  |
|---------|--|
| diagram |  |
|---------|--|



|            |  |
|------------|--|
| type       | <b>xs:decimal</b>  |
| properties | isRef 0<br>content simple  |
| annotation | documentation<br>A72 - Last market price known, in Currency (C). |

element **SIIPositionType/DerivativeOrConvertible/UnderlyingInstrument/Valuation/Country**

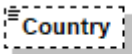
|            |   |
|------------|---|
| diagram    |  <p>A73 - Country of quotation</p> |
| type       | <a href="#">ISOCountryCodeType</a>  |
| properties | isRef 0<br>minOcc 0<br>maxOcc 1<br>content simple   |
| facets     | Kind Value annotation<br>minLength 2<br>maxLength 2   |
| annotation | documentation<br>A73 - Country of quotation   |

element **SIIPositionType/DerivativeOrConvertible/UnderlyingInstrument/Valuation/EconomicArea**

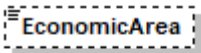
|            |   |
|------------|---|
| diagram    |  <p>A74 - Economic area code of<br/>Country of quotation:<br/>0 non listed<br/>1 EEA;<br/>2 OECD non EEA<br/>3 non OECD</p> |
| type       | <a href="#">EconomicAreaType</a>  |
| properties | isRef 0<br>minOcc 0<br>maxOcc 1<br>content simple   |
| facets     | Kind Value annotation<br>minInclusive 0<br>maxInclusive 3   |
| annotation | documentation<br>A74 - Economic area code of Country of quotation:<br>0 non listed<br>1 EEA;<br>2 OECD non EEA<br>3 non OECD  |

element **SIIPositionType/DerivativeOrConvertible/UnderlyingInstrument/Coupon**

|            |   |
|------------|---|
| diagram    |   |
| properties | isRef 0<br>minOcc 0<br>maxOcc 1<br>content complex                        |
| children   | <a href="#">CouponRate</a> <a href="#">CouponFrequency</a>                |
| annotation | documentation<br>If underlying instrument is an interest rate instrument. |

element **SIIPositionType/DerivativeOrConvertible/UnderlyingInstrument/Coupon/CouponRate**

|            |  |
|------------|--|
| diagram    |  |
| type       | <a href="#">PercentageType</a>                                       |
| properties | isRef 0<br>content simple  |
| annotation | documentation<br>A75 - Next coupon rate in percentage.<br>3.5% = 3.5 |

element **SIIPositionType/DerivativeOrConvertible/UnderlyingInstrument/Coupon/CouponFrequency**

|            |  |
|------------|--|
| diagram    |  |
| type       | <a href="#">SIICouponFrequencyType</a>   |
| properties | isRef 0<br>content simple  |
| annotation | documentation<br>A76 - Coupon payment frequency as number of coupons per year<br>0 = other case than<br>1= annual<br>2= biannual |

|  |  |
|--|--|
|  | 4= quarterly<br>12= monthly<br>52=Weekly |
|--|--|

element **SIIPositionType/DerivativeOrConvertible/UnderlyingInstrument/Redemption**

|            |  |
|------------|--|
| diagram    |  |
| type       | <a href="#">RedemptionType</a>   |
| properties | isRef 0<br>minOcc 0<br>maxOcc 1<br>content complex   |
| children   | <a href="#">MaturityDate</a> <a href="#">Type</a> <a href="#">Rate</a>                                       |
| annotation | documentation<br>A77 78 79 - Redemption details.<br>If underlying instrument is an interest rate instrument. |

element **SIIPositionType/DerivativeOrConvertible/UnderlyingInstrument/CreditRiskData**

|                   |   |
|-------------------|---|
| <p>diagram</p>    | <p><b>CreditRiskData</b><br/>A80 to A89 - Issuer of underlying instrument (or counterparty for OTC instruments).</p> <p><b>CreditRiskDataType</b></p> <ul style="list-style-type: none"> <li><b>InstrumentIssuer</b> (+)<br/>Identification of instrument issuer (or counterpart for OTC instruments).</li> <li><b>IssuerGroup</b> (+)<br/>Characteristics of final financial group the InstrumentIssuer belongs to (highest parent company). Duplicate InstrumentIssuer data if identical to InstrumentIssuer</li> <li><b>IssuerCountry</b> (≡)<br/>Country of instrument issuer: ISO country code 2 (ISO 3166-1) or "XA" for Supranational issuers or "EU" for European Union institutions</li> <li><b>EconomicArea</b> (≡)<br/>Economic area code of Country:<br/>1 EEA<br/>2 OECD non EEA<br/>3 non OECD.</li> <li><b>StateGuarantee</b> (≡)<br/>The instrument is guaranteed by the state of issuer ('Y') or not ('N')</li> <li><b>CreditQualityStep</b> (≡)<br/>CQS: Synthetic issue or issuer rating.<br/>Integer from 0=AAA to 6=CCC, plus 9=unrated</li> </ul> |
| <p>type</p>       | <p><a href="#">CreditRiskDataType</a></p>   |
| <p>properties</p> | <p>isRef 0<br/>minOcc 0<br/>maxOcc 1<br/>content complex</p>  |
| <p>children</p>   | <p><a href="#">InstrumentIssuer</a> <a href="#">IssuerGroup</a> <a href="#">IssuerCountry</a> <a href="#">EconomicArea</a> <a href="#">StateGuarantee</a> <a href="#">CreditQualityStep</a></p>   |
| <p>annotation</p> | <p>documentation<br/>A80 to A89 - Issuer of underlying instrument (or counterparty for OTC instruments).</p>  |

element **SIIPositionType/DerivativeOrConvertible/MaturityDate**

|            |   |
|------------|---|
| diagram    | <p><b>MaturityDate</b><br/>A 39 Expiry date for options.<br/>Maturity date for derivatives.</p> |
| type       | <b>xs:date</b>  |
| properties | <p>isRef 0<br/>minOcc 0<br/>maxOcc 1<br/>content simple</p>                                     |
| annotation | <p>documentation<br/>A 39 Expiry date for options. Maturity date for derivatives.</p>           |

element **SIIPositionType/Analytics**

|            |   |
|------------|---|
| diagram    | <p><b>Analytics</b><br/>Financial ratios: Modified duration, Delta, ...<br/>Useless fo cash positions</p> <ul style="list-style-type: none"> <li><b>ModifiedDurationToMaturity</b><br/>A90 - Modified duration to maturity date based on dirty price.</li> <li><b>ModifiedDurationToCall</b><br/>A91 - Modified duration to next call/put date, if any.</li> <li><b>CreditSensitivity</b><br/>A92</li> <li><b>Delta</b><br/>A93 - For Convertibles and Options. Sensitivity to the underlying asset.</li> <li><b>Convexity</b><br/>A94 - Convexity for interest rates instruments; or gamma for derivatives with optional components</li> <li><b>Vega</b><br/>A94b</li> </ul> |
| properties | <p>isRef 0<br/>minOcc 0<br/>maxOcc 1<br/>content complex</p>  |
| children   | <p><a href="#">ModifiedDurationToMaturity</a> <a href="#">ModifiedDurationToCall</a> <a href="#">CreditSensitivity</a> <a href="#">Delta</a> <a href="#">Convexity</a> <a href="#">Vega</a></p>   |
| annotation | <p>documentation<br/>Financial ratios: Modified duration, Delta, ...<br/>Useless fo cash positions</p>  |

element **SIIPositionType/Analytics/ModifiedDurationToMaturity**

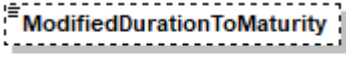
|            |   |
|------------|---|
| diagram    |  <p>A90 - Modified duration to maturity date based on dirty price.</p> |
| type       | <b>xs:decimal</b>   |
| properties | isRef 0<br>minOcc 0<br>maxOcc 1<br>content simple   |
| annotation | documentation<br>A90 - Modified duration to maturity date based on dirty price.   |

element **SIIPositionType/Analytics/ModifiedDurationToCall**

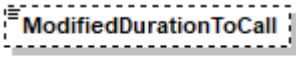
|            |   |
|------------|---|
| diagram    |  <p>A91 - Modified duration to next call/put date, if any.</p> |
| type       | <b>xs:decimal</b>   |
| properties | isRef 0<br>minOcc 0<br>maxOcc 1<br>content simple   |
| annotation | documentation<br>A91 - Modified duration to next call/put date, if any.   |

element **SIIPositionType/Analytics/CreditSensitivity**

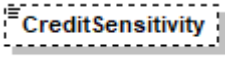
|            |  |
|------------|--|
| diagram    |  <p>A92</p> |
| type       | <b>xs:decimal</b>  |
| properties | isRef 0<br>minOcc 0<br>maxOcc 1<br>content simple  |
| annotation | documentation<br>A92   |

element **SIIPositionType/Analytics/Delta**

|            |   |
|------------|---|
| diagram    |  <p>A93 - For Convertibles and Options. Sensitivity to the underlying asset.</p> |
| type       | <b>xs:decimal</b>   |
| properties | isRef 0<br>minOcc 0<br>maxOcc 1<br>content simple   |
| annotation | documentation<br>A93 - For Convertibles and Options.  |

|  |                                      |
|--|--------------------------------------|
|  | Sensitivity to the underlying asset. |
|--|--------------------------------------|

element **SIIPositionType/Analytics/Convexity**

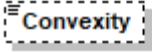
|            |  |
|------------|--|
| diagram    |  <p>A94 - Convexity for interest rates instruments; or gamma for derivatives with optional components</p> |
| type       | <b>xs:decimal</b>  |
| properties | isRef 0<br>minOcc 0<br>maxOcc 1<br>content simple  |
| annotation | documentation<br>A94 - Convexity for interest rates instruments; or gamma for derivatives with optional components   |

element **SIIPositionType/Analytics/Vega**

|            |   |
|------------|---|
| diagram    |  <p>A94b</p> |
| type       | <b>xs:decimal</b>   |
| properties | isRef 0<br>minOcc 0<br>maxOcc 1<br>content simple   |
| annotation | documentation<br>A94b   |

element **SIIPositionType/LookThroughISIN**

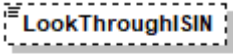
|            |  |
|------------|--|
| diagram    |  <p>A95 - If Portfolio is decomposed using look-through approach and the line comes from a fund, ISIN code of this fund (Share class)</p> |
| type       | <b>ISINType</b>  |
| properties | isRef 0<br>minOcc 0<br>maxOcc 1<br>content simple  |
| facets     | Kind Value annotation<br>length 12<br>pattern [A-Z]{2}[A-Z0-9]{9}[0-9]{1}  |
| annotation | documentation<br>A95 - If Portfolio is decomposed using look-through approach and the line comes from a fund, ISIN code of this fund (Share class)   |

element **SIIPositionType/ContributionToSCR**

|                   |  |
|-------------------|--|
| <p>diagram</p>    | <p><b>ContributionToSCR</b></p> <p>Instrument level.<br/>The block is optional.<br/>However, if the block is present, all the SCRs inside can be present, with the non relevant ones set to 0.</p> <p><b>ContributionToSCRType</b></p> <ul style="list-style-type: none"> <li><b>MktIntUp</b><br/>A97 - Capital requirement for interest rate risk for the "up" shock.</li> <li><b>MktIntDown</b><br/>A98 - Capital requirement for interest rate risk for the "down" shock.</li> <li><b>MktEqGlobal</b><br/>A99 - Capital requirement for equity risk (EEA or OECD zone). Only MktEqGlobal or MktEqOther will be non zero.</li> <li><b>MktEqOther</b><br/>A100 - Capital requirement for equity risk (non OECD zone). Only MktEqGlobal or MktEqOther will be non zero.</li> <li><b>MktProp</b><br/>A101 - Capital requirement for property risk</li> <li><b>MktSpread</b> ⊕<br/>Capital requirement for interest rate spread risk.</li> <li><b>MktFXUp</b><br/>A105a - Capital requirement for FX (upward shock)</li> <li><b>MktFXDown</b><br/>A105b - Capital requirement for FX (downward shock)</li> </ul> |
| <p>type</p>       | <p><a href="#">ContributionToSCRType</a></p>   |
| <p>properties</p> | <p>isRef 0<br/>minOcc 0<br/>maxOcc 1<br/>content complex</p>   |
| <p>children</p>   | <p><a href="#">MktIntUp</a> <a href="#">MktIntDown</a> <a href="#">MktEqGlobal</a> <a href="#">MktEqOther</a> <a href="#">MktProp</a> <a href="#">MktSpread</a> <a href="#">MktFXUp</a> <a href="#">MktFXDown</a></p>  |
| <p>annotation</p> | <p>documentation<br/>Instrument level.<br/>The block is optional. However, if the block is present, all the SCRs inside can be present, with the non relevant ones set to 0.</p>   |



element **SIIPositionType/QRTPositionInformation**

diagram

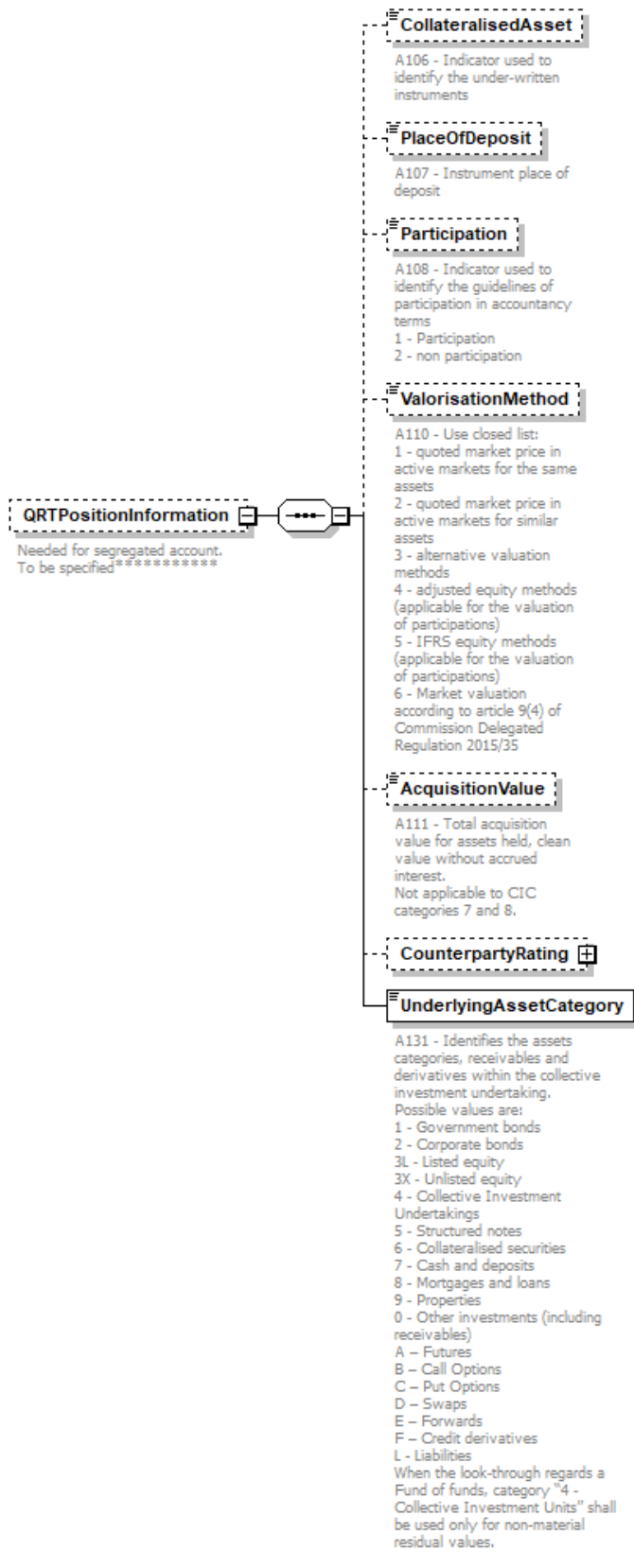

|            |   |
|------------|---|
| properties | isRef 0<br>minOcc 0<br>maxOcc 1<br>content complex  |
| children   | <a href="#">CollateralisedAsset</a> <a href="#">PlaceOfDeposit</a> <a href="#">Participation</a> <a href="#">ValorisationMethod</a> <a href="#">AcquisitionValue</a> <a href="#">CounterpartyRating</a> <a href="#">UnderlyingAssetCategory</a> |
| annotation | documentation<br>Needed for segregated account.<br>To be specified*****   |

element **SIIPositionType/QRTPositionInformation/CollateralisedAsset**

|            |   |
|------------|---|
| diagram    |  |
| type       | restriction of <b>xs:unsignedInt</b>  |
| properties | isRef 0<br>minOcc 0<br>maxOcc 1<br>content simple                                 |
| annotation | documentation<br>A106 - Indicator used to identify the under-written instruments  |

element **SIIPositionType/QRTPositionInformation/PlaceOfDeposit**

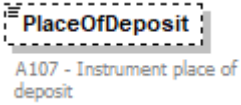
|            |   |
|------------|---|
| diagram    |  |
| type       | <b>xs:string</b>  |
| properties | isRef 0<br>minOcc 0<br>maxOcc 1<br>content simple                                   |
| annotation | documentation<br>A107 - Instrument place of deposit                                 |

element **SIIPositionType/QRTPositionInformation/Participation**

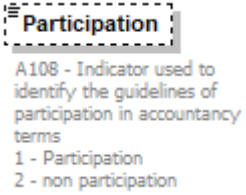
|              |   |            |       |            |              |   |  |              |   |  |
|--------------|---|------------|-------|------------|--------------|---|--|--------------|---|--|
| diagram      |    |            |       |            |              |   |  |              |   |  |
| type         | restriction of <b>xs:int</b>  |            |       |            |              |   |  |              |   |  |
| properties   | isRef 0<br>minOcc 0<br>maxOcc 1<br>content simple   |            |       |            |              |   |  |              |   |  |
| facets       | <table border="0"> <tr> <td>Kind</td> <td>Value</td> <td>annotation</td> </tr> <tr> <td>minInclusive</td> <td>1</td> <td></td> </tr> <tr> <td>maxInclusive</td> <td>2</td> <td></td> </tr> </table> | Kind       | Value | annotation | minInclusive | 1 |  | maxInclusive | 2 |  |
| Kind         | Value   | annotation |       |            |              |   |  |              |   |  |
| minInclusive | 1   |            |       |            |              |   |  |              |   |  |
| maxInclusive | 2   |            |       |            |              |   |  |              |   |  |

|            |   |
|------------|---|
| annotation | documentation<br>A108 - Indicator used to identify the guidelines of participation in accountancy terms<br>1 - Participation<br>2 - non participation |
|------------|---|

element **SIIPositionType/QRTPositionInformation/ValorisationMethod**

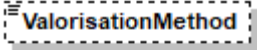
|            |   |
|------------|---|
| diagram    |  <p>A110 - Use closed list:<br/>1 - quoted market price in active markets for the same assets<br/>2 - quoted market price in active markets for similar assets<br/>3 - alternative valuation methods<br/>4 - adjusted equity methods (applicable for the valuation of participations)<br/>5 - IFRS equity methods (applicable for the valuation of participations)<br/>6 - Market valuation according to article 9(4) of Commission Delegated Regulation 2015/35</p> |
| type       | restriction of <b>xs:int</b>  |
| properties | isRef 0<br>minOcc 0<br>maxOcc 1<br>content simple   |
| facets     | Kind Value annotation<br>minInclusive 1<br>maxInclusive 6   |
| annotation | documentation<br>A110 - Use closed list:<br>1 - quoted market price in active markets for the same assets<br>2 - quoted market price in active markets for similar assets<br>3 - alternative valuation methods<br>4 - adjusted equity methods (applicable for the valuation of participations)<br>5 - IFRS equity methods (applicable for the valuation of participations)<br>6 - Market valuation according to article 9(4) of Commission Delegated Regulation 2015/35   |

element **SIIPositionType/QRTPositionInformation/AcquisitionValue**

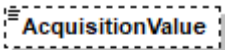
|            |  |
|------------|--|
| diagram    |  <p>A111 - Total acquisition value for assets held, clean value without accrued interest.<br/>Not applicable to CIC categories 7 and 8.</p> |
| type       | <b>xs:decimal</b>  |
| properties | isRef 0<br>minOcc 0<br>maxOcc 1<br>content simple  |
| annotation | documentation<br>A111 - Total acquisition value for assets held, clean value without accrued interest.<br>Not applicable to CIC categories 7 and 8.  |

element **SIIPositionType/QRTPositionInformation/CounterpartyRating**

|            |  |
|------------|--|
| diagram    | <p>The diagram shows a class <b>CounterpartyRating</b> (represented by a dashed box) associated with two classes: <b>RatingValue</b> and <b>RatingAgency</b>. The association is shown as a line with an open arrowhead pointing to the <b>CounterpartyRating</b> class. The <b>RatingValue</b> class has the description: "A112 - Rating of the counterparty / issuer (cf specifications QRT) (S.06.02 - old: Assets D1)". The <b>RatingAgency</b> class has the description: "A113 - Name of the rating agency (cf specification QRT) (S.06.02 - old: Assets D1)".</p> |
| properties | <p>isRef 0<br/> minOcc 0<br/> maxOcc 1<br/> content complex</p>  |
| children   | <p><a href="#">RatingValue</a> <a href="#">RatingAgency</a></p>  |

element **SIIPositionType/QRTPositionInformation/CounterpartyRating/RatingValue**

|            |  |
|------------|--|
| diagram    | <p>The diagram shows the <b>RatingValue</b> class with the description: "A112 - Rating of the counterparty / issuer (cf specifications QRT) (S.06.02 - old: Assets D1)".</p> |
| type       | <p><b>xs:string</b></p>  |
| properties | <p>isRef 0<br/> content simple</p>   |
| annotation | <p>documentation<br/> A112 - Rating of the counterparty / issuer (cf specifications QRT) (S.06.02 - old: Assets D1)</p>  |

element **SIIPositionType/QRTPositionInformation/CounterpartyRating/RatingAgency**

|            |  |
|------------|--|
| diagram    | <p>The diagram shows the <b>RatingAgency</b> class with the description: "A113 - Name of the rating agency (cf specification QRT) (S.06.02 - old: Assets D1)".</p> |
| type       | <p><b>xs:string</b></p>  |
| properties | <p>isRef 0<br/> content simple</p>   |
| annotation | <p>documentation<br/> A113 - Name of the rating agency (cf specification QRT) (S.06.02 - old: Assets D1)</p>   |

element **SIIPositionType/QRTPositionInformation/UnderlyingAssetCategory**

|                   |   |
|-------------------|---|
| <p>diagram</p>    | <div style="border: 1px solid black; padding: 5px; margin-bottom: 10px;"> <p><b>UnderlyingAssetCategory</b></p> </div> <p>A131 - Identifies the assets categories, receivables and derivatives within the collective investment undertaking.<br/>Possible values are:<br/>1 - Government bonds<br/>2 - Corporate bonds<br/>3L - Listed equity<br/>3X - Unlisted equity<br/>4 - Collective Investment Undertakings<br/>5 - Structured notes<br/>6 - Collateralised securities<br/>7 - Cash and deposits<br/>8 - Mortgages and loans<br/>9 - Properties<br/>0 - Other investments (including receivables)<br/>A - Futures<br/>B - Call Options<br/>C - Put Options<br/>D - Swaps<br/>E - Forwards<br/>F - Credit derivatives<br/>L - Liabilities<br/>When the look-through regards a Fund of funds, category "4 - Collective Investment Units" shall be used only for non-material residual values.</p> |
| <p>type</p>       | <p>restriction of <b>xs:string</b></p>  |
| <p>properties</p> | <p>isRef 0<br/>content simple</p>   |
| <p>facets</p>     | <p>Kind Value annotation<br/>minLength 1<br/>maxLength 2</p>  |
| <p>annotation</p> | <p>documentation<br/>A131 - Identifies the assets categories, receivables and derivatives within the collective investment undertaking.<br/>Possible values are:<br/>1 - Government bonds<br/>2 - Corporate bonds<br/>3L - Listed equity<br/>3X - Unlisted equity<br/>4 - Collective Investment Undertakings<br/>5 - Structured notes<br/>6 - Collateralised securities<br/>7 - Cash and deposits<br/>8 - Mortgages and loans<br/>9 - Properties<br/>0 - Other investments (including receivables)<br/>A - Futures<br/>B - Call Options<br/>C - Put Options<br/>D - Swaps<br/>E - Forwards<br/>F - Credit derivatives<br/>L - Liabilities<br/>When the look-through regards a Fund of funds, category "4 - Collective Investment Units" shall be used only for non-material residual values.</p>  |

element **SIIPositionType/AdditionalInformation**

|            |  |
|------------|--|
| diagram    | <p>A133</p> <p>A132 - Use closed list:<br/> 0 - Not assessed<br/> 1 - Debt on eligible Infrastructure project<br/> 2 - Equity on eligible infrastructure project<br/> 3 - Debt on eligible Infrastructure corporate<br/> 4 - Equity on eligible infrastructure corporate<br/> 5 - Non eligible</p> |
| properties | isRef 0<br>content complex   |
| children   | <a href="#">FundCustodianName</a> <a href="#">InfrastructureInvestment</a>   |

element **SIIPositionType/AdditionalInformation/FundCustodianName**

|            |   |
|------------|---|
| diagram    | <p>A133</p>                                       |
| type       | <b>xs:string</b>                                  |
| properties | isRef 0<br>minOcc 0<br>maxOcc 1<br>content simple |
| annotation | documentation<br>A133                             |

element **SIIPositionType/AdditionalInformation/InfrastructureInvestment**

|            |  |
|------------|--|
| diagram    | <p>A132 - Use closed list:<br/> 0 - Not assessed<br/> 1 - Debt on eligible Infrastructure project<br/> 2 - Equity on eligible infrastructure project<br/> 3 - Debt on eligible Infrastructure corporate<br/> 4 - Equity on eligible infrastructure corporate<br/> 5 - Non eligible</p> |
| type       | restriction of <b>xs:int</b>   |
| properties | isRef 0<br>minOcc 0<br>maxOcc 1<br>content simple  |
| facets     | Kind Value annotation<br>minInclusive 0<br>maxInclusive 5  |
| annotation | documentation<br>A132 - Use closed list:   |

|  |   |
|--|---|
|  | <ul style="list-style-type: none"><li>0 - Not assessed</li><li>1 - Debt on eligible Infrastructure project</li><li>2 - Equity on eligible infrastructure project</li><li>3 - Debt on eligible Infrastructure corporate</li><li>4 - Equity on eligible infrastructure corporate</li><li>5 - Non eligible</li></ul> |
|--|---|

# complexType SIIPositionType\_V5

diagram

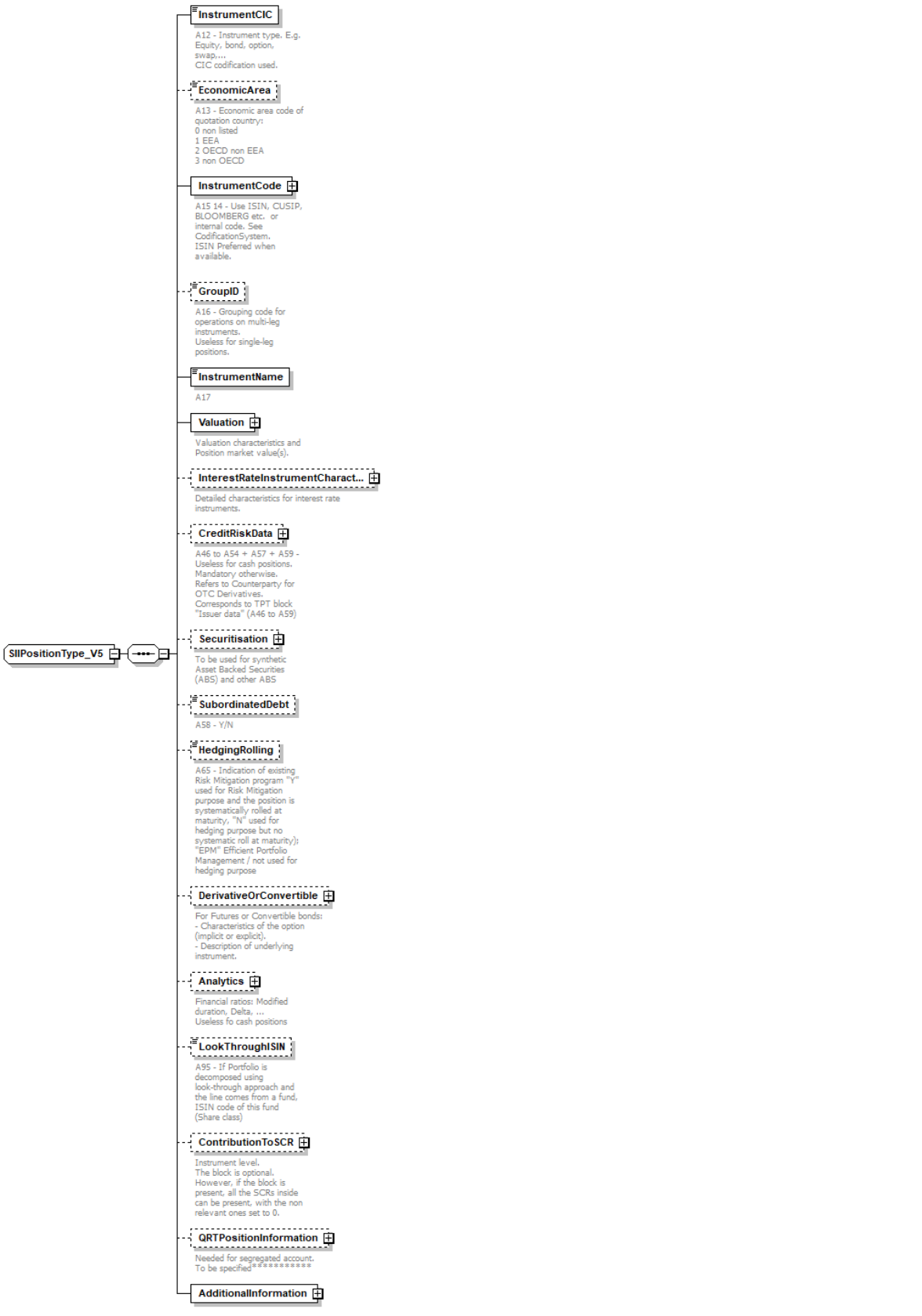



|          |   |
|----------|---|
| children | <a href="#">InstrumentCIC</a> <a href="#">EconomicArea</a> <a href="#">InstrumentCode</a> <a href="#">GroupID</a> <a href="#">InstrumentName</a> <a href="#">Valuation</a> <a href="#">InterestRateInstrumentCharacteristics</a> <a href="#">CreditRiskData</a> <a href="#">Securitisation</a> <a href="#">SubordinatedDebt</a> <a href="#">HedgingRolling</a> <a href="#">DerivativeOrConvertible</a> <a href="#">Analytics</a> <a href="#">LookThroughISIN</a> <a href="#">ContributionToSCR</a> <a href="#">QRTPositionInformation</a> <a href="#">AdditionalInformation</a> |
| used by  | element <a href="#">SolvencyIIPortfolioType_V5/Positions/Position</a>   |

element **SIIPositionType\_V5/InstrumentCIC**

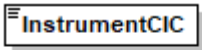
| diagram    |  <p>A12 - Instrument type. E.g. Equity, bond, option, swap, ...<br/>CIC codification used.</p>   |            |       |            |           |   |  |           |   |  |         |                                     |  |
|------------|---|------------|-------|------------|-----------|---|--|-----------|---|--|---------|-------------------------------------|--|
| type       | restriction of <a href="#">CICCodeType</a>  |            |       |            |           |   |  |           |   |  |         |                                     |  |
| properties | isRef 0<br>content simple   |            |       |            |           |   |  |           |   |  |         |                                     |  |
| facets     | <table border="1"> <thead> <tr> <th>Kind</th> <th>Value</th> <th>annotation</th> </tr> </thead> <tbody> <tr> <td>minLength</td> <td>4</td> <td></td> </tr> <tr> <td>maxLength</td> <td>4</td> <td></td> </tr> <tr> <td>pattern</td> <td> <math display="block">([A-Z]{2}([A-F][0-9]){1})[1-9]{1}</math> </td> <td></td> </tr> </tbody> </table> | Kind       | Value | annotation | minLength | 4 |  | maxLength | 4 |  | pattern | $([A-Z]{2}([A-F][0-9]){1})[1-9]{1}$ |  |
| Kind       | Value   | annotation |       |            |           |   |  |           |   |  |         |                                     |  |
| minLength  | 4   |            |       |            |           |   |  |           |   |  |         |                                     |  |
| maxLength  | 4   |            |       |            |           |   |  |           |   |  |         |                                     |  |
| pattern    | $([A-Z]{2}([A-F][0-9]){1})[1-9]{1}$   |            |       |            |           |   |  |           |   |  |         |                                     |  |
| annotation | documentation<br>A12 - Instrument type. E.g. Equity, bond, option, swap, ...<br>CIC codification used.  |            |       |            |           |   |  |           |   |  |         |                                     |  |

element **SIIPositionType\_V5/EconomicArea**

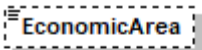
| diagram      |  <p>A13 - Economic area code of quotation country:<br/>0 non listed<br/>1 EEA<br/>2 OECD non EEA<br/>3 non OECD</p>                                |            |       |            |              |   |  |              |   |  |
|--------------|---|------------|-------|------------|--------------|---|--|--------------|---|--|
| type         | <a href="#">EconomicAreaType</a>  |            |       |            |              |   |  |              |   |  |
| properties   | isRef 0<br>minOcc 0<br>maxOcc 1<br>content simple   |            |       |            |              |   |  |              |   |  |
| facets       | <table border="1"> <thead> <tr> <th>Kind</th> <th>Value</th> <th>annotation</th> </tr> </thead> <tbody> <tr> <td>minInclusive</td> <td>0</td> <td></td> </tr> <tr> <td>maxInclusive</td> <td>3</td> <td></td> </tr> </tbody> </table> | Kind       | Value | annotation | minInclusive | 0 |  | maxInclusive | 3 |  |
| Kind         | Value   | annotation |       |            |              |   |  |              |   |  |
| minInclusive | 0   |            |       |            |              |   |  |              |   |  |
| maxInclusive | 3   |            |       |            |              |   |  |              |   |  |
| annotation   | documentation<br>A13 - Economic area code of quotation country:<br>0 non listed<br>1 EEA<br>2 OECD non EEA<br>3 non OECD  |            |       |            |              |   |  |              |   |  |

element **SIIPositionType\_V5/InstrumentCode**

|                   |  |
|-------------------|--|
| <p>diagram</p>    | <p>The diagram illustrates the structure of the <b>SIIPositionType_V5/InstrumentCode</b> element. It shows a box for <b>InstrumentCode</b> on the left, which is connected to a larger dashed box representing <b>SII Security Codification Type V5</b>. Inside this dashed box, there are two sub-elements: <b>CodificationSystem</b> and <b>Code</b>. The <b>InstrumentCode</b> box contains the text: "A15 14 - Use ISIN, CUSIP, BLOOMBERG etc. or internal code. See CodificationSystem. ISIN Preferred when available." The <b>CodificationSystem</b> box contains a list of codification systems: "Codification system used. Integer corresponding to the following closed list: 1 - ISO 6166 for ISIN code, 2 - CUSIP (The Committee on Uniform Securities Identification Procedures number assigned by the CUSIP Service Bureau for U.S. and Canadian companies), 3 - SEDOL (Stock Exchange Daily Official List for the London Stock Exchange), 4 - WKN (Wertpapier Kenn-Nummer, the alphanumeric German identification number), 5 - Bloomberg Ticker (Bloomberg letters code that identify a company's securities), 6 - BBGID (The Bloomberg Global ID), 7 - Reuters RIC (Reuters instrument code), 8 - FIGI (Financial Instrument Global Identifier), 9 - Other code by members of the Association of National Numbering Agencies, 99 - Code attributed by the undertaking." The <b>Code</b> box contains the text: "Value of code in CodificationSystem".</p> |
| <p>type</p>       | <p><a href="#">SII Security Codification Type V5</a></p>   |
| <p>properties</p> | <p>isRef 0<br/>content complex</p>   |
| <p>children</p>   | <p><a href="#">CodificationSystem</a> <a href="#">Code</a></p>   |
| <p>annotation</p> | <p>documentation<br/>A15 14 - Use ISIN, CUSIP, BLOOMBERG etc. or internal code. See CodificationSystem. ISIN Preferred when available.</p>   |

element **SIIPositionType\_V5/GroupID**

|                |   |
|----------------|---|
| <p>diagram</p> | <p>The diagram shows a box for <b>GroupID</b> with a dashed border. Below the box is the text: "A16 - Grouping code for operations on multi-leg instruments. Useless for single-leg positions."</p> |
| <p>type</p>    | <p>restriction of <b>xs:string</b></p>  |

|            |  |
|------------|--|
| properties | isRef 0<br>minOcc 0<br>maxOcc 1<br>content simple  |
| facets     | Kind Value annotation<br>maxLength 255   |
| annotation | documentation<br>A16 - Grouping code for operations on multi-leg instruments.<br>Useless for single-leg positions. |

element **SIIPositionType\_V5/InstrumentName**

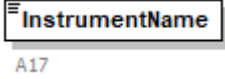
|            |   |
|------------|---|
| diagram    |  |
| type       | restriction of <b>xs:string</b>   |
| properties | isRef 0<br>content simple   |
| facets     | Kind Value annotation<br>maxLength 255  |
| annotation | documentation<br>A17  |

# element SIIPositionType\_V5/Valuation

diagram

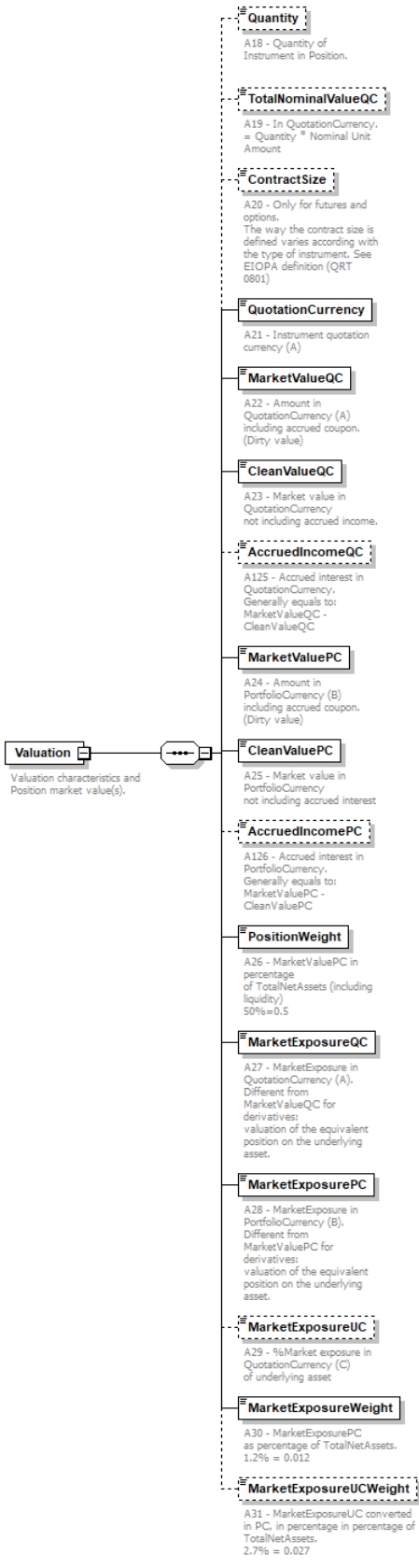

|            |   |
|------------|---|
| properties | isRef 0<br>content complex  |
| children   | <a href="#">Quantity</a> <a href="#">TotalNominalValueQC</a> <a href="#">ContractSize</a> <a href="#">QuotationCurrency</a> <a href="#">MarketValueQC</a> <a href="#">CleanValueQC</a> <a href="#">AccruedIncomeQC</a> <a href="#">MarketValuePC</a> <a href="#">CleanValuePC</a> <a href="#">AccruedIncomePC</a> <a href="#">PositionWeight</a> <a href="#">MarketExposureQC</a> <a href="#">MarketExposurePC</a> <a href="#">MarketExposureUC</a> <a href="#">MarketExposureWeight</a> <a href="#">MarketExposureUCWeight</a> |
| annotation | documentation<br>Valuation characteristics and<br>Position market value(s).   |

element **SIIPositionType\_V5/Valuation/Quantity**

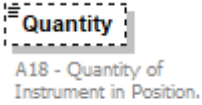
|            |   |
|------------|---|
| diagram    |  |
| type       | <b>xs:decimal</b>   |
| properties | isRef 0<br>minOcc 0<br>maxOcc 1<br>content simple                                 |
| annotation | documentation<br>A18 - Quantity of Instrument in Position.                        |

element **SIIPositionType\_V5/Valuation/TotalNominalValueQC**

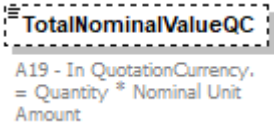
|            |   |
|------------|---|
| diagram    |  |
| type       | <b>xs:decimal</b>   |
| properties | isRef 0<br>minOcc 0<br>maxOcc 1<br>content simple                                   |
| annotation | documentation<br>A19 - In QuotationCurrency.<br>= Quantity * Nominal Unit Amount    |

element **SIIPositionType\_V5/Valuation/ContractSize**

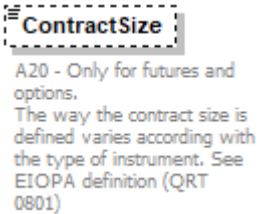
|            |   |
|------------|---|
| diagram    |  |
| type       | <b>xs:decimal</b>   |
| properties | isRef 0<br>minOcc 0<br>maxOcc 1<br>content simple                                   |

|            |  |
|------------|--|
| annotation | documentation<br>A20 - Only for futures and options.<br>The way the contract size is defined varies according with the type of instrument. See EIOPA definition (QRT 0801) |
|------------|--|

element **SIIPositionType\_V5/Valuation/QuotationCurrency**

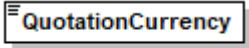
|            |  |
|------------|--|
| diagram    |  <p>A21 - Instrument quotation currency (A)</p> |
| type       | <a href="#">ISOCurrencyCodeType</a>  |
| properties | isRef 0<br>content simple  |
| facets     | Kind Value annotation<br>minLength 3<br>maxLength 3<br>pattern [A-Z]{3}  |
| annotation | documentation<br>A21 - Instrument quotation currency (A)   |

element **SIIPositionType\_V5/Valuation/MarketValueQC**

|            |  |
|------------|--|
| diagram    |  <p>A22 - Amount in QuotationCurrency (A) including accrued coupon. (Dirty value)</p> |
| type       | <b>xs:decimal</b>  |
| properties | isRef 0<br>content simple  |
| annotation | documentation<br>A22 - Amount in QuotationCurrency (A) including accrued coupon. (Dirty value)   |

element **SIIPositionType\_V5/Valuation/CleanValueQC**

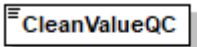
|            |  |
|------------|--|
| diagram    |  <p>A23 - Market value in QuotationCurrency not including accrued income.</p> |
| type       | <b>xs:decimal</b>  |
| properties | isRef 0<br>content simple  |
| annotation | documentation<br>A23 - Market value in QuotationCurrency not including accrued income.   |

element **SIIPositionType\_V5/Valuation/AccruedIncomeQC**

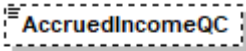
|            |  |
|------------|--|
| diagram    |  <p>A125 - Accrued interest in QuotationCurrency.<br/>Generally equals to:<br/>MarketValueQC - CleanValueQC</p> |
| type       | <b>xs:decimal</b>  |
| properties | isRef 0<br>minOcc 0<br>maxOcc 1<br>content simple  |
| annotation | documentation<br>A125 - Accrued interest in QuotationCurrency.<br>Generally equals to: MarketValueQC - CleanValueQC  |

element **SIIPositionType\_V5/Valuation/MarketValuePC**

|            |  |
|------------|--|
| diagram    |  <p>A24 - Amount in PortfolioCurrency (B) including accrued coupon.<br/>(Dirty value)</p> |
| type       | <b>xs:decimal</b>  |
| properties | isRef 0<br>content simple  |
| annotation | documentation<br>A24 - Amount in PortfolioCurrency (B) including accrued coupon.<br>(Dirty value)  |

element **SIIPositionType\_V5/Valuation/CleanValuePC**

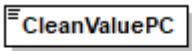
|            |   |
|------------|---|
| diagram    |  <p>A25 - Market value in PortfolioCurrency not including accrued interest</p> |
| type       | <b>xs:decimal</b>   |
| properties | isRef 0<br>content simple   |
| annotation | documentation<br>A25 - Market value in PortfolioCurrency not including accrued interest   |

element **SIIPositionType\_V5/Valuation/AccruedIncomePC**

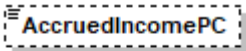
|         |  |
|---------|--|
| diagram |  <p>A126 - Accrued interest in PortfolioCurrency.<br/>Generally equals to:<br/>MarketValuePC - CleanValuePC</p> |
| type    | <b>xs:decimal</b>  |

|            |   |
|------------|---|
| properties | isRef 0<br>minOcc 0<br>maxOcc 1<br>content simple   |
| annotation | documentation<br>A126 - Accrued interest in PortfolioCurrency.<br>Generally equals to: MarketValuePC - CleanValuePC |

element **SIIPositionType\_V5/Valuation/PositionWeight**

|            |   |
|------------|---|
| diagram    | <p><b>PositionWeight</b></p> <p>A26 - MarketValuePC in percentage of TotalNetAssets (including liquidity)<br/>50%=0.5</p> |
| type       | <b>xs:decimal</b>   |
| properties | isRef 0<br>content simple   |
| annotation | documentation<br>A26 - MarketValuePC in percentage of TotalNetAssets (including liquidity)<br>50%=0.5                     |

element **SIIPositionType\_V5/Valuation/MarketExposureQC**

|            |  |
|------------|--|
| diagram    | <p><b>MarketExposureQC</b></p> <p>A27 - MarketExposure in QuotationCurrency (A).<br/>Different from MarketValueQC for derivatives:<br/>valuation of the equivalent position on the underlying asset.</p> |
| type       | <b>xs:decimal</b>  |
| properties | isRef 0<br>content simple  |
| annotation | documentation<br>A27 - MarketExposure in QuotationCurrency (A).<br>Different from MarketValueQC for derivatives:<br>valuation of the equivalent position on the underlying asset.                        |

element **SIIPositionType\_V5/Valuation/MarketExposurePC**

|            |  |
|------------|--|
| diagram    | <p><b>MarketExposurePC</b></p> <p>A28 - MarketExposure in PortfolioCurrency (B).<br/>Different from MarketValuePC for derivatives:<br/>valuation of the equivalent position on the underlying asset.</p> |
| type       | <b>xs:decimal</b>  |
| properties | isRef 0  |



|            |   |
|------------|---|
|            | content simple  |
| annotation | documentation<br>A28 - MarketExposure in PortfolioCurrency (B).<br>Different from MarketValuePC for derivatives:<br>valuation of the equivalent position on the underlying asset. |

element **SIIPositionType\_V5/Valuation/MarketExposureUC**

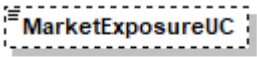
|            |  |
|------------|--|
| diagram    |  <p>A29 - %Market exposure in QuotationCurrency (C) of underlying asset</p> |
| type       | <b>xs:decimal</b>  |
| properties | isRef 0<br>minOcc 0<br>maxOcc 1<br>content simple  |
| annotation | documentation<br>A29 - %Market exposure in QuotationCurrency (C) of underlying asset   |

element **SIIPositionType\_V5/Valuation/MarketExposureWeight**

|            |   |
|------------|---|
| diagram    |  <p>A30 - MarketExposurePC as percentage of TotalNetAssets.<br/>1.2% = 0.012</p> |
| type       | <b>xs:decimal</b>   |
| properties | isRef 0<br>content simple   |
| annotation | documentation<br>A30 - MarketExposurePC as percentage of TotalNetAssets.<br>1.2% = 0.012  |

element **SIIPositionType\_V5/Valuation/MarketExposureUCWeight**

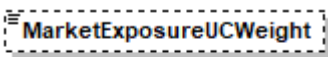
|            |  |
|------------|--|
| diagram    |  <p>A31 - MarketExposureUC converted in PC, in percentage in percentage of TotalNetAssets.<br/>2.7% = 0.027</p> |
| type       | <b>xs:decimal</b>  |
| properties | isRef 0<br>minOcc 0<br>maxOcc 1<br>content simple  |
| annotation | documentation<br>A31 - MarketExposureUC converted in PC, in percentage in percentage of TotalNetAssets.<br>2.7% = 0.027  |

element **SIIPositionType\_V5/InterestRateInstrumentCharacteristics**

|                   |  |
|-------------------|--|
| <p>diagram</p>    | <p><b>InterestRateInstrumentCharact...</b><br/>Detailed characteristics for interest rate instruments.</p> <ul style="list-style-type: none"> <li><b>RateType</b><br/>A32 - Type of interest rate: "Fixed" (fixe), "Variable" (révisable), "Floating" (variable), "Inflation_linked" (inflation linked bonds)</li> <li><b>CouponRate</b><br/>A33 - Next annual coupon rate in percentage (known, or estimated for Floating). 3.5% has to be written "3.5"</li> <li><b>VariableRate</b><br/>For Floating/Variable rate bond.</li> <li><b>CouponFrequency</b><br/>A38 - Coupon payment frequency as number of coupons per year<br/>0 = other than below options:<br/>1= annual<br/>2= biannual<br/>4= quarterly<br/>12= monthly<br/>52= weekly</li> <li><b>EffectiveDateOfInstrument</b><br/>A63 - Start date to accrue interest.</li> <li><b>Redemption</b><br/>A39 40 41 - Redemption details</li> <li><b>EmbeddedOption</b><br/>To be used only for a callable / puttable bond. The embedded option is described only for the first option date to come.</li> <li><b>ValuationYieldCurve</b><br/>Specific data in case no yield curve of reference is available (e.g. for developing countries or BRICS)</li> </ul> |
| <p>properties</p> | <p>isRef 0<br/>minOcc 0<br/>maxOcc 1<br/>content complex</p>   |
| <p>children</p>   | <p><a href="#">RateType</a> <a href="#">CouponRate</a> <a href="#">VariableRate</a> <a href="#">CouponFrequency</a> <a href="#">EffectiveDateOfInstrument</a> <a href="#">Redemption</a> <a href="#">EmbeddedOption</a> <a href="#">ValuationYieldCurve</a></p>  |
| <p>annotation</p> | <p>documentation<br/>Detailed characteristics for interest rate instruments.</p>   |

element **SIIPositionType\_V5/InterestRateInstrumentCharacteristics/RateType**

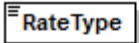
|            |   |
|------------|---|
| diagram    |  <p><b>RateType</b></p> <p>A32 - Type of interest rate:<br/> "Fixed" (fixe), "Variable" (révisable), "Floating" (variable), "Infation_linked" (inflation linked bonds)</p> |
| type       | restriction of <b>xs:string</b>   |
| properties | isRef 0<br>content simple   |
| annotation | documentation<br>A32 - Type of interest rate:<br>"Fixed" (fixe), "Variable" (révisable), "Floating" (variable), " Infation_linked" (inflation linked bonds)   |

element **SIIPositionType\_V5/InterestRateInstrumentCharacteristics/CouponRate**

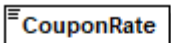
|            |   |
|------------|---|
| diagram    |  <p><b>CouponRate</b></p> <p>A33 - Next annual coupon rate in percentage (known, or estimated for Floating).<br/> 3.5% has to be written "3.5"</p> |
| type       | <a href="#">PercentageType</a>  |
| properties | isRef 0<br>content simple   |
| annotation | documentation<br>A33 - Next annual coupon rate in percentage (known, or estimated for Floating).<br>3.5% has to be written "3.5"  |

element **SIIPositionType\_V5/InterestRateInstrumentCharacteristics/VariableRate**

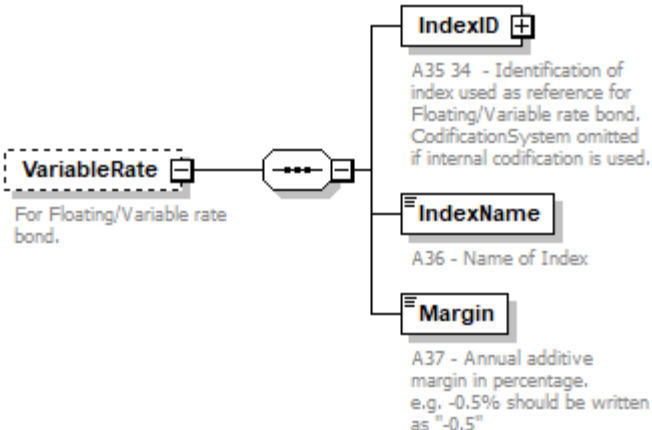
|            |  |
|------------|--|
| diagram    |  <p><b>VariableRate</b></p> <p>For Floating/Variable rate bond.</p> <p><b>IndexID</b></p> <p>A35 34 - Identification of index used as reference for Floating/Variable rate bond. CodificationSystem omitted if internal codification is used.</p> <p><b>IndexName</b></p> <p>A36 - Name of Index</p> <p><b>Margin</b></p> <p>A37 - Annual additive margin in percentage. e.g. -0.5% should be written as "-0.5"</p> |
| properties | isRef 0<br>minOcc 0<br>maxOcc 1<br>content complex   |
| children   | <a href="#">IndexID</a> <a href="#">IndexName</a> <a href="#">Margin</a>   |
| annotation | documentation<br>For Floating/Variable rate bond.  |

element **SIIPositionType\_V5/InterestRateInstrumentCharacteristics/VariableRate/IndexID**

|            |   |
|------------|---|
| diagram    | <p>The diagram illustrates the structure of the <b>IndexID</b> element. It is represented by a box with a small square icon on its right side. A line connects this box to a larger box labeled <b>CodificationType_V5</b>, which is enclosed in a dashed yellow border. Inside <b>CodificationType_V5</b>, there are two sub-elements: <b>CodificationSystem</b> (in a dashed box) and <b>Code</b> (in a solid box). A dashed line connects <b>CodificationSystem</b> to <b>Code</b>. Below <b>CodificationSystem</b> is the text "Codification system used." and below <b>Code</b> is "Value of code in CodificationSystem".</p> <p><b>IndexID</b><br/>A35 34 - Identification of index used as reference for Floating/Variable rate bond. CodificationSystem omitted if internal codification is used.</p> |
| type       | <a href="#">CodificationType_V5</a>   |
| properties | isRef 0<br>content complex  |
| children   | <a href="#">CodificationSystem</a> <a href="#">Code</a>   |
| annotation | documentation<br>A35 34 - Identification of index used as reference for Floating/Variable rate bond. CodificationSystem omitted if internal codification is used.   |

element **SIIPositionType\_V5/InterestRateInstrumentCharacteristics/VariableRate/IndexName**

|            |   |
|------------|---|
| diagram    | <p>The diagram shows a single box labeled <b>IndexName</b> with a small square icon on its right side. Below the box is the text "A36 - Name of Index".</p> |
| type       | <b>xs:string</b>  |
| properties | isRef 0<br>content simple   |
| annotation | documentation<br>A36 - Name of Index  |

element **SIIPositionType\_V5/InterestRateInstrumentCharacteristics/VariableRate/Margin**

|            |  |
|------------|--|
| diagram    | <p>The diagram shows a single box labeled <b>Margin</b> with a small square icon on its right side. Below the box is the text "A37 - Annual additive margin in percentage. e.g. -0.5% should be written as "-0.5".</p> |
| type       | <a href="#">PercentageType</a>   |
| properties | isRef 0<br>content simple  |
| annotation | documentation<br>A37 - Annual additive margin in percentage. e.g. -0.5% should be written as "-0.5"  |

element **SIIPositionType\_V5/InterestRateInstrumentCharacteristics/CouponFrequency**

|            |   |
|------------|---|
| diagram    |  <p>A38 - Coupon payment frequency as number of coupons per year<br/>0 = other than below options:<br/>1= annual<br/>2= biannual<br/>4= quarterly<br/>12= monthly<br/>52= weekly</p> |
| type       | <a href="#">SIICouponFrequencyType</a>  |
| properties | isRef 0<br>content simple   |
| annotation | documentation<br>A38 - Coupon payment frequency as number of coupons per year<br>0 = other than below options:<br>1= annual<br>2= biannual<br>4= quarterly<br>12= monthly<br>52= weekly   |

element **SIIPositionType\_V5/InterestRateInstrumentCharacteristics/EffectiveDateOfInstrument**

|            |  |
|------------|--|
| diagram    |  <p>A63 - Start date to accrue interest.</p> |
| type       | <b>xs:date</b>   |
| properties | isRef 0<br>minOcc 0<br>maxOcc 1<br>content simple  |
| annotation | documentation<br>A63 - Start date to accrue interest.  |

element **SIIPositionType\_V5/InterestRateInstrumentCharacteristics/Redemption**

|                   |   |
|-------------------|---|
| <p>diagram</p>    |   |
| <p>type</p>       | <p><a href="#">RedemptionType_V5</a></p>                                      |
| <p>properties</p> | <p>isRef 0<br/>content complex</p>  |
| <p>children</p>   | <p><a href="#">MaturityDate</a> <a href="#">Type</a> <a href="#">Rate</a></p> |
| <p>annotation</p> | <p>documentation<br/>A39 40 41 - Redemption details</p>                       |

element **SIIPositionType\_V5/InterestRateInstrumentCharacteristics/EmbeddedOption**

|                   |  |
|-------------------|--|
| <p>diagram</p>    |  |
| <p>properties</p> | <p>isRef 0<br/>minOcc 0<br/>maxOcc 1<br/>content complex</p> |

|            |  |
|------------|--|
| children   | <a href="#">CallPutType</a> <a href="#">CallPutDate</a> <a href="#">OptionDirection</a> <a href="#">StrikePrice</a>                          |
| annotation | documentation<br>To be used only for a callable / puttable bond.<br>The embedded option is described only for the first option date to come. |

element **SIIPositionType\_V5/InterestRateInstrumentCharacteristics/EmbeddedOption/CallPutType**

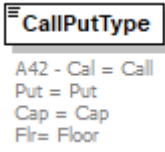
|            |   |
|------------|---|
| diagram    |  |
| type       | restriction of <b>xs:string</b>   |
| properties | isRef 0<br>content simple   |
| annotation | documentation<br>A42 - Cal = Call<br>Put = Put<br>Cap = Cap<br>Flr= Floor         |

element **SIIPositionType\_V5/InterestRateInstrumentCharacteristics/EmbeddedOption/CallPutDate**

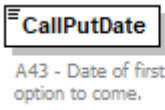
|            |  |
|------------|--|
| diagram    |  |
| type       | <b>xs:date</b>   |
| properties | isRef 0<br>content simple  |
| annotation | documentation<br>A43 - Date of first Call / Put option to come.                    |

element **SIIPositionType\_V5/InterestRateInstrumentCharacteristics/EmbeddedOption/OptionDirection**

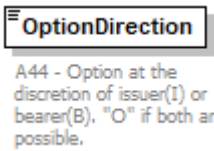
|            |  |
|------------|--|
| diagram    |                   |
| type       | restriction of <b>xs:string</b>  |
| properties | isRef 0<br>content simple  |
| facets     | Kind Value annotation<br>minLength 1<br>maxLength 1  |
| annotation | documentation<br>A44 - Option at the discretion of issuer(I) or bearer(B). "O" if both are possible. |

element **SIIPositionType\_V5/InterestRateInstrumentCharacteristics/EmbeddedOption/StrikePrice**

|            |  |
|------------|--|
| diagram    |  <p><b>StrikePrice</b></p> <p>A45 - Strike price of first optional Call / Put as a percentage of nominal amount.<br/>95%=0.95</p> |
| type       | <b>xs:decimal</b>  |
| properties | isRef 0<br>content simple  |
| annotation | documentation<br>A45 - Strike price of first optional Call / Put as a percentage of nominal amount.<br>95%=0.95  |

element **SIIPositionType\_V5/InterestRateInstrumentCharacteristics/ValuationYieldCurve**

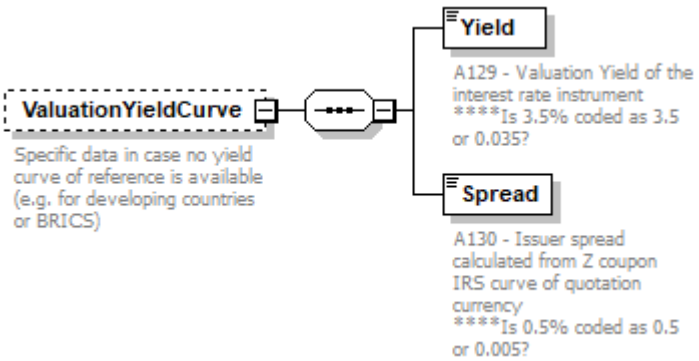
|            |   |
|------------|---|
| diagram    |  <p><b>ValuationYieldCurve</b></p> <p>Specific data in case no yield curve of reference is available (e.g. for developing countries or BRICS)</p> <p><b>Yield</b></p> <p>A129 - Valuation Yield of the interest rate instrument<br/>****Is 3.5% coded as 3.5 or 0.035?</p> <p><b>Spread</b></p> <p>A130 - Issuer spread calculated from Z coupon IRS curve of quotation currency<br/>****Is 0.5% coded as 0.5 or 0.005?</p> |
| properties | isRef 0<br>minOcc 0<br>maxOcc 1<br>content complex  |
| children   | <a href="#">Yield Spread</a>  |
| annotation | documentation<br>Specific data in case no yield curve of reference is available (e.g. for developing countries or BRICS)  |

element **SIIPositionType\_V5/InterestRateInstrumentCharacteristics/ValuationYieldCurve/Yield**

|            |  |
|------------|--|
| diagram    |  <p><b>Yield</b></p> <p>A129 - Valuation Yield of the interest rate instrument<br/>****Is 3.5% coded as 3.5 or 0.035?</p> |
| type       | <b>xs:decimal</b>  |
| properties | isRef 0<br>content simple  |
| annotation | documentation<br>A129 - Valuation Yield of the interest rate instrument<br>****Is 3.5% coded as 3.5 or 0.035?  |

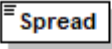

element **SIIPositionType\_V5/InterestRateInstrumentCharacteristics/ValuationYieldCurve/Spread**

|                   |  |
|-------------------|--|
| <p>diagram</p>    |  <p>A130 - Issuer spread<br/>         calculated from Z coupon<br/>         IRS curve of quotation<br/>         currency<br/>         ****Is 0.5% coded as 0.5<br/>         or 0.005?</p> |
| <p>type</p>       | <p><b>xs:decimal</b></p>   |
| <p>properties</p> | <p>isRef 0<br/>         content simple</p>   |
| <p>annotation</p> | <p>documentation<br/>         A130 - Issuer spread calculated from Z coupon IRS curve of quotation currency<br/>         ****Is 0.5% coded as 0.5 or 0.005?</p>  |

element **SIIPositionType\_V5/CreditRiskData**

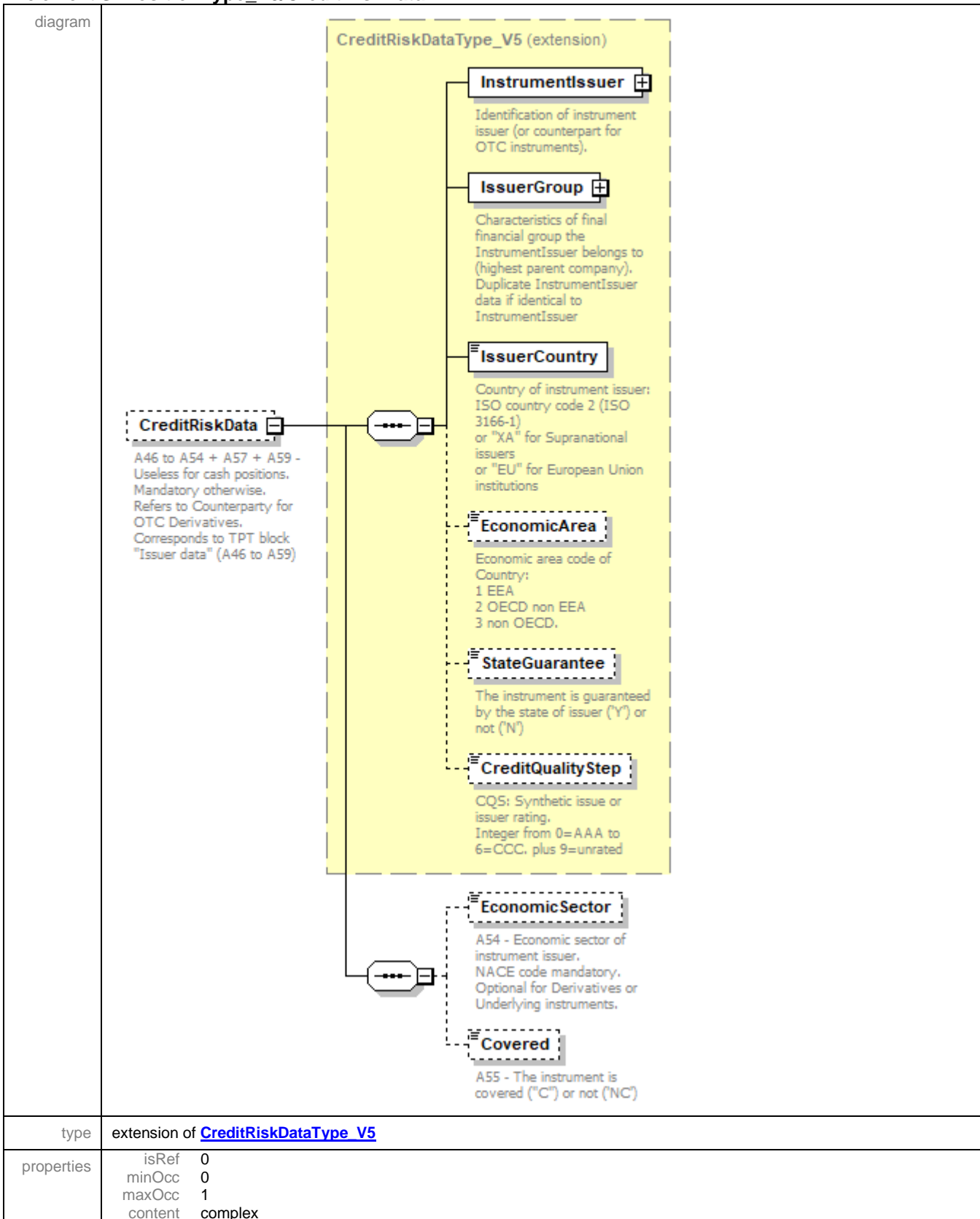

|            |   |
|------------|---|
| children   | <a href="#">InstrumentIssuer</a> <a href="#">IssuerGroup</a> <a href="#">IssuerCountry</a> <a href="#">EconomicArea</a> <a href="#">StateGuarantee</a> <a href="#">CreditQualityStep</a> <a href="#">EconomicSector Covered</a> |
| annotation | documentation<br>A46 to A54 + A57 + A59 - Useless for cash positions.<br>Mandatory otherwise.<br>Refers to Counterparty for OTC Derivatives.<br>Corresponds to TPT block "Issuer data" (A46 to A59)                             |

element **SIIPositionType\_V5/CreditRiskData/EconomicSector**

|            |   |
|------------|---|
| diagram    |    |
| type       | <a href="#">NACECodeType</a>  |
| properties | isRef 0<br>minOcc 0<br>maxOcc 1<br>content simple   |
| facets     | Kind Value annotation<br>minLength 1<br>maxLength 7<br>pattern ([A-Z]{1}[0-9\.\.]{0,6})   |
| annotation | documentation<br>A54 - Economic sector of instrument issuer.<br>NACE code mandatory.<br>Optional for Derivatives or Underlying instruments. |

element **SIIPositionType\_V5/CreditRiskData/Covered**

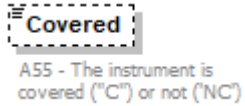
|            |   |
|------------|---|
| diagram    |  |
| type       | restriction of <b>xs:string</b>   |
| properties | isRef 0<br>minOcc 0<br>maxOcc 1<br>content simple                                   |
| annotation | documentation<br>A55 - The instrument is covered ("C") or not ("NC")                |

element **SIIPositionType\_V5/Securitisation**

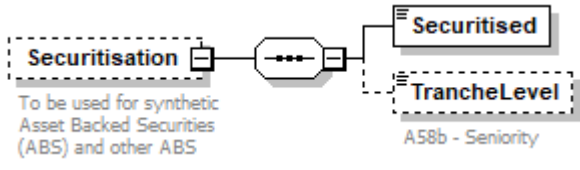
|            |   |
|------------|---|
| diagram    |  |
| properties | isRef 0<br>minOcc 0<br>maxOcc 1<br>content complex                                  |

|            |   |
|------------|---|
| children   | <a href="#">Securitised TrancheLevel</a>  |
| annotation | documentation<br>To be used for synthetic Asset Backed Securities (ABS) and other ABS |

element **SIIPositionType\_V5/Securitisation/Securitised**

|            |   |
|------------|---|
| diagram    |  |
| type       | restriction of <b>xs:string</b>   |
| properties | isRef 0<br>content simple   |

element **SIIPositionType\_V5/Securitisation/TrancheLevel**

|            |   |
|------------|---|
| diagram    |  |
| type       | <b>xs:string</b>  |
| properties | isRef 0<br>minOcc 0<br>maxOcc 1<br>content simple                                 |
| annotation | documentation<br>A58b - Seniority   |

element **SIIPositionType\_V5/SubordinatedDebt**

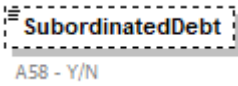
|            |   |
|------------|---|
| diagram    |  |
| type       | <a href="#">YesNoL1Type</a>   |
| properties | isRef 0<br>minOcc 0<br>maxOcc 1<br>content simple                                   |
| facets     | Kind Value annotation<br>minLength 1<br>maxLength 1                                 |
| annotation | documentation<br>A58 - Y/N  |

element **SIIPositionType\_V5/HedgingRolling**

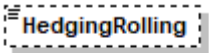
|            |  |
|------------|--|
| diagram    |  <p><b>HedgingRolling</b></p> <p>A65 - Indication of existing Risk Mitigation program "Y" used for Risk Mitigation purpose and the position is systematically rolled at maturity, "N" used for hedging purpose but no systematic roll at maturity); "EPM" Efficient Portfolio Management / not used for hedging purpose</p> |
| type       | restriction of <b>xs:string</b>  |
| properties | <p>isRef 0</p> <p>minOcc 0</p> <p>maxOcc 1</p> <p>content simple</p>   |
| annotation | <p>documentation</p> <p>A65 - Indication of existing Risk Mitigation program "Y" used for Risk Mitigation purpose and the position is systematically rolled at maturity, "N" used for hedging purpose but no systematic roll at maturity); "EPM" Efficient Portfolio Management / not used for hedging purpose</p>   |

element **SIIPositionType\_V5/DerivativeOrConvertible**

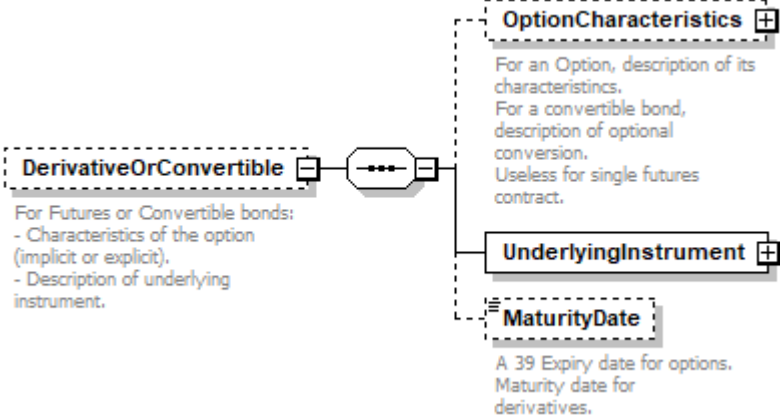
|            |  |
|------------|--|
| diagram    |  <p><b>DerivativeOrConvertible</b></p> <p>For Futures or Convertible bonds:</p> <ul style="list-style-type: none"> <li>- Characteristics of the option (implicit or explicit).</li> <li>- Description of underlying instrument.</li> </ul> <p><b>OptionCharacteristics</b></p> <p>For an Option, description of its characteristics.<br/>For a convertible bond, description of optional conversion.<br/>Useless for single futures contract.</p> <p><b>UnderlyingInstrument</b></p> <p><b>MaturityDate</b></p> <p>A 39 Expiry date for options.<br/>Maturity date for derivatives.</p> |
| properties | <p>isRef 0</p> <p>minOcc 0</p> <p>maxOcc 1</p> <p>content complex</p>  |
| children   | <a href="#">OptionCharacteristics</a> <a href="#">UnderlyingInstrument</a> <a href="#">MaturityDate</a>  |
| annotation | <p>documentation</p> <p>For Futures or Convertible bonds:</p> <ul style="list-style-type: none"> <li>- Characteristics of the option (implicit or explicit).</li> <li>- Description of underlying instrument.</li> </ul>   |

element **SIIPositionType\_V5/DerivativeOrConvertible/OptionCharacteristics**

|                   |  |
|-------------------|--|
| <p>diagram</p>    |  |
| <p>properties</p> | <p>isRef 0<br/>minOcc 0<br/>maxOcc 1<br/>content complex</p>   |
| <p>children</p>   | <p><a href="#">CallPutType</a> <a href="#">StrikePrice</a> <a href="#">ConversionRatio</a> <a href="#">ExerciseType</a> <a href="#">Convertible</a></p>                              |
| <p>annotation</p> | <p>documentation<br/>For an Option, description of its characteristics.<br/>For a convertible bond, description of optional conversion.<br/>Useless for single futures contract.</p> |

element **SIIPositionType\_V5/DerivativeOrConvertible/OptionCharacteristics/CallPutType**

|                   |   |
|-------------------|---|
| <p>diagram</p>    |   |
| <p>type</p>       | <p>restriction of <b>xs:string</b></p>  |
| <p>properties</p> | <p>isRef 0<br/>content simple</p>   |
| <p>facets</p>     | <p>Kind Value annotation<br/>length 3</p>   |
| <p>annotation</p> | <p>documentation<br/>A60 - Option type<br/>"Cal"=call<br/>"Put"=put<br/>"Cap"=cap<br/>"Flr"=floor</p> |

element **SIIPositionType\_V5/DerivativeOrConvertible/OptionCharacteristics/StrikePrice**

|            |   |
|------------|---|
| diagram    |  <p>A61 - Strike price of the option in same unit as price of underlying instrument.</p> |
| type       | <b>xs:decimal</b>   |
| properties | isRef 0<br>content simple   |
| annotation | documentation<br>A61 - Strike price of the option in same unit as price of underlying instrument.   |

element **SIIPositionType\_V5/DerivativeOrConvertible/OptionCharacteristics/ConversionRatio**

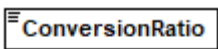
|            |  |
|------------|--|
| diagram    |  <p>A62 - Quantity of UnderlyingInstrument obtained for one "Instrument".</p> |
| type       | <b>xs:decimal</b>  |
| properties | isRef 0<br>content simple  |
| annotation | documentation<br>A62 - Quantity of UnderlyingInstrument obtained for one "Instrument".   |

element **SIIPositionType\_V5/DerivativeOrConvertible/OptionCharacteristics/ExerciseType**

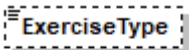
|            |   |
|------------|---|
| diagram    |  <p>A64 - Option style: American, European, Asiatic, Bermudian<br/>Optional for convertibles</p> |
| type       | restriction of <b>xs:string</b>   |
| properties | isRef 0<br>minOcc 0<br>maxOcc 1<br>content simple   |
| facets     | Kind Value annotation<br>minLength 2<br>maxLength 2   |
| annotation | documentation<br>A64 - Option style: American, European, Asiatic, Bermudian<br>Optional for convertibles  |

element **SIIPositionType\_V5/DerivativeOrConvertible/OptionCharacteristics/Convertible**

|            |  |
|------------|--|
| diagram    | <p><b>Convertible</b><br/>Only for Convertible bond.<br/>For pricing using shock modelling.</p> <p><b>BondFloor</b><br/>A127 - Lowest value of a convertible bond expressed in quotation currency, at current issuer spread</p> <p><b>OptionPremium</b><br/>A128 - Premium of the embedded option of a convertible bond in quotation currency.</p> |
| properties | isRef 0<br>minOcc 0<br>maxOcc 1<br>content complex   |
| children   | <a href="#">BondFloor</a> <a href="#">OptionPremium</a>  |
| annotation | documentation<br>Only for Convertible bond.<br>For pricing using shock modelling.  |

element **SIIPositionType\_V5/DerivativeOrConvertible/OptionCharacteristics/Convertible/BondFloor**

|            |   |
|------------|---|
| diagram    | <p><b>BondFloor</b><br/>A127 - Lowest value of a convertible bond expressed in quotation currency, at current issuer spread</p> |
| type       | <b>xs:decimal</b>   |
| properties | isRef 0<br>minOcc 0<br>maxOcc 1<br>content simple   |
| annotation | documentation<br>A127 - Lowest value of a convertible bond expressed in quotation currency, at current issuer spread            |

element **SIIPositionType\_V5/DerivativeOrConvertible/OptionCharacteristics/Convertible/OptionPremium**

|            |  |
|------------|--|
| diagram    | <p><b>OptionPremium</b><br/>A128 - Premium of the embedded option of a convertible bond in quotation currency.</p> |
| type       | <b>xs:decimal</b>  |
| properties | isRef 0<br>minOcc 0<br>maxOcc 1<br>content simple  |
| annotation | documentation<br>A128 - Premium of the embedded option of a convertible bond in quotation currency.                |



element **SIIPositionType\_V5/DerivativeOrConvertible/UnderlyingInstrument**

|                   |   |
|-------------------|---|
| <p>diagram</p>    | <p><b>InstrumentCIC</b><br/>A67 - Instrument type. E.g. Equity, bond, option, swap,...<br/>CIC codification.</p> <p><b>InstrumentCode</b> </p> <p>A69 68 - Use ISIN, CUSIP, or OtherSecurityCodes/Name(of codification system) for BLOOMBERG, TELEKURS or Internal code</p> <p><b>InstrumentName</b><br/>A70 - Name of underlying instrument.</p> <p><b>Valuation</b> </p> <p><b>Coupon</b> </p> <p>If underlying instrument is an interest rate instrument.</p> <p><b>Redemption</b> </p> <p>A77 78 79 - Redemption details.<br/>If underlying instrument is an interest rate instrument.</p> <p><b>CreditRiskData</b> </p> <p>A80 to A89 - Issuer of underlying instrument (or counterparty for OTC instruments).</p> |
| <p>properties</p> | <p>isRef 0<br/>content complex</p>  |
| <p>children</p>   | <p><a href="#">InstrumentCIC</a> <a href="#">InstrumentCode</a> <a href="#">InstrumentName</a> <a href="#">Valuation</a> <a href="#">Coupon</a> <a href="#">Redemption</a> <a href="#">CreditRiskData</a></p>   |

element **SIIPositionType\_V5/DerivativeOrConvertible/UnderlyingInstrument/InstrumentCIC**

|                   |  |
|-------------------|--|
| <p>diagram</p>    | <p><b>InstrumentCIC</b><br/>A67 - Instrument type. E.g. Equity, bond, option, swap,...<br/>CIC codification.</p> |
| <p>type</p>       | <p><a href="#">CICCodeType</a></p>   |
| <p>properties</p> | <p>isRef 0<br/>content simple</p>  |
| <p>facets</p>     | <p>Kind Value annotation<br/>minLength 4<br/>maxLength 4<br/>pattern ([A-Z]{2}([A-F] [0-9]){1}[1-9]{1})</p>      |

|            |  |
|------------|--|
| annotation | documentation<br>A67 - Instrument type. E.g. Equity, bond, option, swap,...<br>CIC codification. |
|------------|--|

element **SIIPositionType\_V5/DerivativeOrConvertible/UnderlyingInstrument/InstrumentCode**

|            |  |
|------------|--|
| diagram    | <p>The diagram illustrates the structure of the <b>SIIPositionType_V5</b> element. It shows a dashed box representing the <b>SII Security Codification Type V5</b> structure. Inside this box, there are two main components: <b>CodificationSystem</b> and <b>Code</b>. <b>CodificationSystem</b> is a list of codification systems used, with an integer value corresponding to a closed list of options. <b>Code</b> is the value of the code in the codification system. The <b>InstrumentCode</b> element is shown to the left, with a line connecting it to the <b>CodificationSystem</b> and <b>Code</b> components. The <b>InstrumentCode</b> description is: "A69 68 - Use ISIN, CUSIP, or OtherSecurityCodes/Name(of codification system) for BLOOMBERG, TELEKURS or Internal code".</p> |
| type       | <a href="#">SII Security Codification Type V5</a>  |
| properties | isRef 0<br>content complex   |
| children   | <a href="#">CodificationSystem</a> <a href="#">Code</a>  |
| annotation | documentation<br>A69 68 - Use ISIN, CUSIP, or OtherSecurityCodes/Name(of codification system) for BLOOMBERG, TELEKURS or Internal code   |

element **SIIPositionType\_V5/DerivativeOrConvertible/UnderlyingInstrument/InstrumentName**

|         |  |
|---------|--|
| diagram | <p>The diagram shows the <b>InstrumentName</b> element. It is described as: "A70 - Name of underlying instrument."</p> |
|---------|--|

|            |   |
|------------|---|
| type       | <b>xs:string</b>                                      |
| properties | isRef 0<br>content simple                             |
| annotation | documentation<br>A70 - Name of underlying instrument. |

element **SIIPositionType\_V5/DerivativeOrConvertible/UnderlyingInstrument/Valuation**

|            |  |
|------------|--|
| diagram    | <p><b>Valuation</b></p> <ul style="list-style-type: none"> <li><b>Currency</b><br/>A71 - Quotation currency (C)</li> <li><b>MarketPrice</b><br/>A72 - Last market price known, in Currency (C).</li> <li><b>Country</b><br/>A73 - Country of quotation</li> <li><b>EconomicArea</b><br/>A74 - Economic area code of Country of quotation:<br/>0 non listed<br/>1 EEA;<br/>2 OECD non EEA<br/>3 non OECD</li> </ul> |
| properties | isRef 0<br>content complex   |
| children   | <a href="#">Currency</a> <a href="#">MarketPrice</a> <a href="#">Country</a> <a href="#">EconomicArea</a>  |

element **SIIPositionType\_V5/DerivativeOrConvertible/UnderlyingInstrument/Valuation/Currency**

|            |   |
|------------|---|
| diagram    | <p><b>Currency</b><br/>A71 - Quotation currency (C)</p>                 |
| type       | <a href="#">ISOCurrencyCodeType</a>                                     |
| properties | isRef 0<br>content simple   |
| facets     | Kind Value annotation<br>minLength 3<br>maxLength 3<br>pattern [A-Z]{3} |
| annotation | documentation<br>A71 - Quotation currency (C)                           |

element **SIIPositionType\_V5/DerivativeOrConvertible/UnderlyingInstrument/Valuation/MarketPrice**

|         |   |
|---------|---|
| diagram | <p><b>MarketPrice</b><br/>A72 - Last market price known, in Currency (C).</p> |
|---------|---|

|            |  |
|------------|--|
| type       | <b>xs:decimal</b>  |
| properties | isRef 0<br>content simple  |
| annotation | documentation<br>A72 - Last market price known, in Currency (C). |

element **SIIPositionType\_V5/DerivativeOrConvertible/UnderlyingInstrument/Valuation/Country**

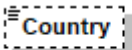
|            |   |
|------------|---|
| diagram    |  <p>A73 - Country of quotation</p> |
| type       | <a href="#">ISOCountryCodeType</a>  |
| properties | isRef 0<br>minOcc 0<br>maxOcc 1<br>content simple   |
| facets     | Kind Value annotation<br>minLength 2<br>maxLength 2   |
| annotation | documentation<br>A73 - Country of quotation   |

element **SIIPositionType\_V5/DerivativeOrConvertible/UnderlyingInstrument/Valuation/EconomicArea**

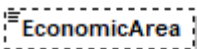
|            |   |
|------------|---|
| diagram    |  <p>A74 - Economic area code of<br/>Country of quotation:<br/>0 non listed<br/>1 EEA;<br/>2 OECD non EEA<br/>3 non OECD</p> |
| type       | <a href="#">EconomicAreaType</a>  |
| properties | isRef 0<br>minOcc 0<br>maxOcc 1<br>content simple   |
| facets     | Kind Value annotation<br>minInclusive 0<br>maxInclusive 3   |
| annotation | documentation<br>A74 - Economic area code of Country of quotation:<br>0 non listed<br>1 EEA;<br>2 OECD non EEA<br>3 non OECD  |

element **SIIPositionType\_V5/DerivativeOrConvertible/UnderlyingInstrument/Coupon**

|            |   |
|------------|---|
| diagram    | <p><b>Coupon</b><br/>If underlying instrument is an interest rate instrument.</p> <p><b>CouponRate</b><br/>A75 - Next coupon rate in percentage.<br/>3.5% = 3.5</p> <p><b>CouponFrequency</b><br/>A76 - Coupon payment frequency as "number of coupon payment per year<br/>0 = other than below<br/>options:<br/>1= annual<br/>2= biannual<br/>4= quarterly<br/>12= monthly<br/>52= weekly"</p> |
| properties | <p>isRef 0<br/>minOcc 0<br/>maxOcc 1<br/>content complex</p>  |
| children   | <a href="#">CouponRate</a> <a href="#">CouponFrequency</a>  |
| annotation | <p>documentation<br/>If underlying instrument is an interest rate instrument.</p>   |

element **SIIPositionType\_V5/DerivativeOrConvertible/UnderlyingInstrument/Coupon/CouponRate**

|            |   |
|------------|---|
| diagram    | <p><b>CouponRate</b><br/>A75 - Next coupon rate in percentage.<br/>3.5% = 3.5</p> |
| type       | <a href="#">PercentageType</a>  |
| properties | <p>isRef 0<br/>content simple</p>   |
| annotation | <p>documentation<br/>A75 - Next coupon rate in percentage.<br/>3.5% = 3.5</p>     |

element **SIIPositionType\_V5/DerivativeOrConvertible/UnderlyingInstrument/Coupon/CouponFrequency**

|            |   |
|------------|---|
| diagram    | <p><b>CouponFrequency</b><br/>A76 - Coupon payment frequency as "number of coupon payment per year<br/>0 = other than below<br/>options:<br/>1= annual<br/>2= biannual<br/>4= quarterly<br/>12= monthly<br/>52= weekly"</p> |
| type       | <a href="#">SIICouponFrequencyType</a>  |
| properties | <p>isRef 0<br/>content simple</p>   |

|            |   |
|------------|---|
| annotation | <p>documentation</p> <p>A76 - Coupon payment frequency as "number of coupon payment per year<br/> 0 = other than below options:<br/> 1= annual<br/> 2= biannual<br/> 4= quarterly<br/> 12= monthly<br/> 52= weekly"</p> |
|------------|---|

element **SIIPositionType\_V5/DerivativeOrConvertible/UnderlyingInstrument/Redemption**

|            |   |
|------------|---|
| diagram    | <p><b>Redemption</b><br/> A77 78 79 - Redemption details.<br/> If underlying instrument is an interest rate instrument.</p> <p><b>RedemptionType_V5</b></p> <ul style="list-style-type: none"> <li><b>MaturityDate</b><br/> Last redemption date 9999-12-31 for perpetual.<br/> Expiry date for options.</li> <li><b>Type</b><br/> Type of Redemption schedule:<br/> "Bullet", "Sinkable",<br/> "defaulted" empty if non applicable,<br/> Omitted if not applicable.</li> <li><b>Rate</b><br/> If known, redemption rate in percentage of nominal amount (A19)<br/> 100%=1.0</li> </ul> |
| type       | <a href="#">RedemptionType_V5</a>   |
| properties | isRef 0<br>minOcc 0<br>maxOcc 1<br>content complex  |
| children   | <a href="#">MaturityDate</a> <a href="#">Type</a> <a href="#">Rate</a>  |
| annotation | <p>documentation</p> <p>A77 78 79 - Redemption details.<br/> If underlying instrument is an interest rate instrument.</p>   |

element **SIIPositionType\_V5/DerivativeOrConvertible/UnderlyingInstrument/CreditRiskData**

|                   |  |
|-------------------|--|
| <p>diagram</p>    | <p>The diagram illustrates the structure of the <b>CreditRiskData</b> element. It is a complex type (indicated by a dashed box) that contains several child elements:</p> <ul style="list-style-type: none"> <li><b>InstrumentIssuer</b>: Identification of instrument issuer (or counterpart for OTC instruments).</li> <li><b>IssuerGroup</b>: Characteristics of final financial group the InstrumentIssuer belongs to (highest parent company). Duplicate InstrumentIssuer data if identical to InstrumentIssuer.</li> <li><b>IssuerCountry</b>: Country of instrument issuer: ISO country code 2 (ISO 3166-1) or "XA" for Supranational issuers or "EU" for European Union institutions.</li> <li><b>EconomicArea</b>: Economic area code of Country: 1 EEA, 2 OECD non EEA, 3 non OECD.</li> <li><b>StateGuarantee</b>: The instrument is guaranteed by the state of issuer ('Y') or not ('N').</li> <li><b>CreditQualityStep</b>: CQS: Synthetic issue or issuer rating. Integer from 0=AAA to 6=CCC, plus 9=unrated.</li> </ul> <p>The <b>CreditRiskData</b> element is described as: A80 to A89 - Issuer of underlying instrument (or counterpart for OTC instruments).</p> |
| <p>type</p>       | <p><a href="#">CreditRiskDataType_V5</a></p>   |
| <p>properties</p> | <p>isRef 0<br/>minOcc 0<br/>maxOcc 1<br/>content complex</p>   |
| <p>children</p>   | <p><a href="#">InstrumentIssuer</a> <a href="#">IssuerGroup</a> <a href="#">IssuerCountry</a> <a href="#">EconomicArea</a> <a href="#">StateGuarantee</a> <a href="#">CreditQualityStep</a></p>  |
| <p>annotation</p> | <p>documentation<br/>A80 to A89 - Issuer of underlying instrument (or counterpart for OTC instruments).</p>  |

element **SIIPositionType\_V5/DerivativeOrConvertible/MaturityDate**

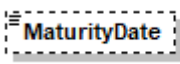
|            |  |
|------------|--|
| diagram    |  <p><b>MaturityDate</b></p> <p>A 39 Expiry date for options.<br/>Maturity date for derivatives.</p> |
| type       | <b>xs:date</b>   |
| properties | <p>isRef 0</p> <p>minOcc 0</p> <p>maxOcc 1</p> <p>content simple</p>   |
| annotation | <p>documentation</p> <p>A 39 Expiry date for options. Maturity date for derivatives.</p>   |

element **SIIPositionType\_V5/Analytics**

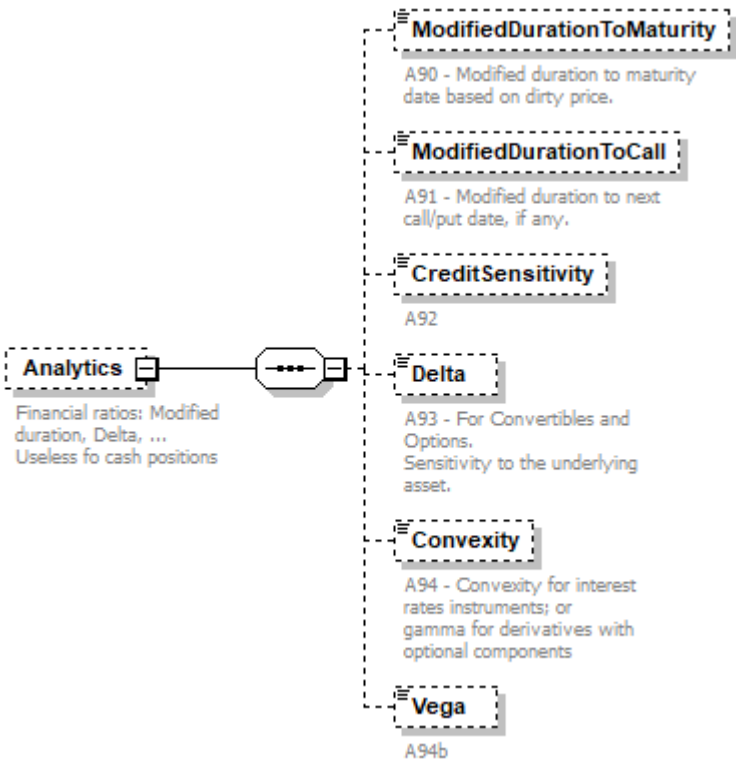
|            |   |
|------------|---|
| diagram    |  <p><b>Analytics</b></p> <p>Financial ratios: Modified duration, Delta, ...<br/>Useless fo cash positions</p> <p><b>ModifiedDurationToMaturity</b></p> <p>A90 - Modified duration to maturity date based on dirty price.</p> <p><b>ModifiedDurationToCall</b></p> <p>A91 - Modified duration to next call/put date, if any.</p> <p><b>CreditSensitivity</b></p> <p>A92</p> <p><b>Delta</b></p> <p>A93 - For Convertibles and Options.<br/>Sensitivity to the underlying asset.</p> <p><b>Convexity</b></p> <p>A94 - Convexity for interest rates instruments; or gamma for derivatives with optional components</p> <p><b>Vega</b></p> <p>A94b</p> |
| properties | <p>isRef 0</p> <p>minOcc 0</p> <p>maxOcc 1</p> <p>content complex</p>   |
| children   | <a href="#">ModifiedDurationToMaturity</a> <a href="#">ModifiedDurationToCall</a> <a href="#">CreditSensitivity</a> <a href="#">Delta</a> <a href="#">Convexity</a> <a href="#">Vega</a>  |
| annotation | <p>documentation</p> <p>Financial ratios: Modified duration, Delta, ...<br/>Useless fo cash positions</p>   |

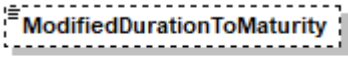

element **SIIPositionType\_V5/Analytics/ModifiedDurationToMaturity**

|            |   |
|------------|---|
| diagram    |  <p>A90 - Modified duration to maturity date based on dirty price.</p> |
| type       | <b>xs:decimal</b>   |
| properties | isRef 0<br>minOcc 0<br>maxOcc 1<br>content simple   |
| annotation | documentation<br>A90 - Modified duration to maturity date based on dirty price.   |

element **SIIPositionType\_V5/Analytics/ModifiedDurationToCall**

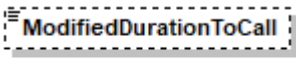
|            |   |
|------------|---|
| diagram    |  <p>A91 - Modified duration to next call/put date, if any.</p> |
| type       | <b>xs:decimal</b>   |
| properties | isRef 0<br>minOcc 0<br>maxOcc 1<br>content simple   |
| annotation | documentation<br>A91 - Modified duration to next call/put date, if any.   |

element **SIIPositionType\_V5/Analytics/CreditSensitivity**

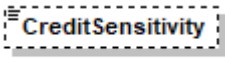
|            |  |
|------------|--|
| diagram    |  <p>A92</p> |
| type       | <b>xs:decimal</b>  |
| properties | isRef 0<br>minOcc 0<br>maxOcc 1<br>content simple  |
| annotation | documentation<br>A92   |

element **SIIPositionType\_V5/Analytics/Delta**

|            |   |
|------------|---|
| diagram    |  <p>A93 - For Convertibles and Options. Sensitivity to the underlying asset.</p> |
| type       | <b>xs:decimal</b>   |
| properties | isRef 0<br>minOcc 0<br>maxOcc 1<br>content simple   |
| annotation | documentation<br>A93 - For Convertibles and Options.  |

|  |                                      |
|--|--------------------------------------|
|  | Sensitivity to the underlying asset. |
|--|--------------------------------------|

element **SIIPositionType\_V5/Analytics/Convexity**

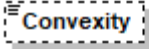
|            |  |
|------------|--|
| diagram    |  <p>A94 - Convexity for interest rates instruments; or gamma for derivatives with optional components</p> |
| type       | <b>xs:decimal</b>  |
| properties | isRef 0<br>minOcc 0<br>maxOcc 1<br>content simple  |
| annotation | documentation<br>A94 - Convexity for interest rates instruments; or gamma for derivatives with optional components   |

element **SIIPositionType\_V5/Analytics/Vega**

|            |   |
|------------|---|
| diagram    |  <p>A94b</p> |
| type       | <b>xs:decimal</b>   |
| properties | isRef 0<br>minOcc 0<br>maxOcc 1<br>content simple   |
| annotation | documentation<br>A94b   |

element **SIIPositionType\_V5/LookThroughISIN**

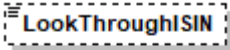
|            |  |
|------------|--|
| diagram    |  <p>A95 - If Portfolio is decomposed using look-through approach and the line comes from a fund, ISIN code of this fund (Share class)</p> |
| type       | <b>ISINType</b>  |
| properties | isRef 0<br>minOcc 0<br>maxOcc 1<br>content simple  |
| facets     | Kind Value annotation<br>length 12<br>pattern [A-Z]{2}[A-Z0-9]{9}[0-9]{1}  |
| annotation | documentation<br>A95 - If Portfolio is decomposed using look-through approach and the line comes from a fund, ISIN code of this fund (Share class)   |

element **SIIPositionType\_V5/ContributionToSCR**

|                   |  |
|-------------------|--|
| <p>diagram</p>    | <p><b>ContributionToSCR</b></p> <p>Instrument level.<br/>The block is optional.<br/>However, if the block is present, all the SCRs inside can be present, with the non relevant ones set to 0.</p> <p><b>ContributionToSCRType</b></p> <ul style="list-style-type: none"> <li><b>MktIntUp</b><br/>A97 - Capital requirement for interest rate risk for the "up" shock.</li> <li><b>MktIntDown</b><br/>A98 - Capital requirement for interest rate risk for the "down" shock.</li> <li><b>MktEqGlobal</b><br/>A99 - Capital requirement for equity risk (EEA or OECD zone). Only MktEqGlobal or MktEqOther will be non zero.</li> <li><b>MktEqOther</b><br/>A100 - Capital requirement for equity risk (non OECD zone). Only MktEqGlobal or MktEqOther will be non zero.</li> <li><b>MktProp</b><br/>A101 - Capital requirement for property risk</li> <li><b>MktSpread</b> ⊕<br/>Capital requirement for interest rate spread risk.</li> <li><b>MktFXUp</b><br/>A105a - Capital requirement for FX (upward shock)</li> <li><b>MktFXDown</b><br/>A105b - Capital requirement for FX (downward shock)</li> </ul> |
| <p>type</p>       | <p><a href="#">ContributionToSCRType</a></p>   |
| <p>properties</p> | <p>isRef 0<br/>minOcc 0<br/>maxOcc 1<br/>content complex</p>   |
| <p>children</p>   | <p><a href="#">MktIntUp</a> <a href="#">MktIntDown</a> <a href="#">MktEqGlobal</a> <a href="#">MktEqOther</a> <a href="#">MktProp</a> <a href="#">MktSpread</a> <a href="#">MktFXUp</a> <a href="#">MktFXDown</a></p>  |
| <p>annotation</p> | <p>documentation<br/>Instrument level.<br/>The block is optional. However, if the block is present, all the SCRs inside can be present, with the non relevant ones set to 0.</p>   |

element **SIIPositionType\_V5/QRTPositionInformation**

diagram

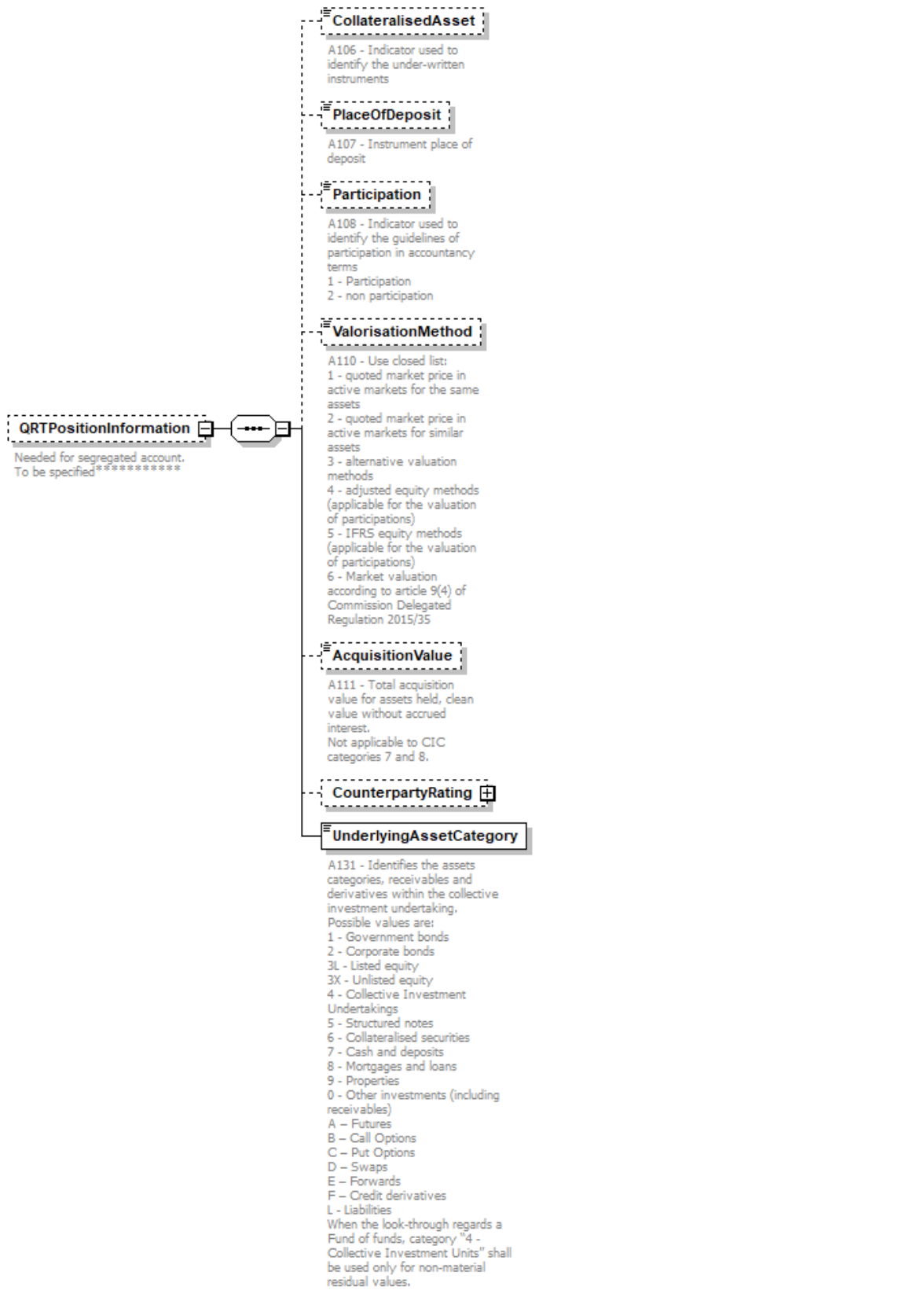

|            |   |
|------------|---|
| properties | isRef 0<br>minOcc 0<br>maxOcc 1<br>content complex  |
| children   | <a href="#">CollateralisedAsset</a> <a href="#">PlaceOfDeposit</a> <a href="#">Participation</a> <a href="#">ValorisationMethod</a> <a href="#">AcquisitionValue</a> <a href="#">CounterpartyRating</a> <a href="#">UnderlyingAssetCategory</a> |
| annotation | documentation<br>Needed for segregated account.<br>To be specified*****   |

element **SIIPositionType\_V5/QRTPositionInformation/CollateralisedAsset**

|            |  |
|------------|--|
| diagram    |  |
| type       | restriction of <b>xs:unsignedInt</b>   |
| properties | isRef 0<br>minOcc 0<br>maxOcc 1<br>content simple                                |
| annotation | documentation<br>A106 - Indicator used to identify the under-written instruments |

element **SIIPositionType\_V5/QRTPositionInformation/PlaceOfDeposit**

|            |   |
|------------|---|
| diagram    |   |
| type       | <b>xs:string</b>                                    |
| properties | isRef 0<br>minOcc 0<br>maxOcc 1<br>content simple   |
| annotation | documentation<br>A107 - Instrument place of deposit |

element **SIIPositionType\_V5/QRTPositionInformation/Participation**

|            |   |
|------------|---|
| diagram    |   |
| type       | restriction of <b>xs:int</b>                              |
| properties | isRef 0<br>minOcc 0<br>maxOcc 1<br>content simple         |
| facets     | Kind Value annotation<br>minInclusive 1<br>maxInclusive 2 |

|            |   |
|------------|---|
| annotation | documentation<br>A108 - Indicator used to identify the guidelines of participation in accountancy terms<br>1 - Participation<br>2 - non participation |
|------------|---|

element **SIIPositionType\_V5/QRTPositionInformation/ValorisationMethod**

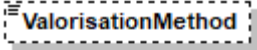
|            |   |
|------------|---|
| diagram    |  <p>A110 - Use closed list:<br/>1 - quoted market price in active markets for the same assets<br/>2 - quoted market price in active markets for similar assets<br/>3 - alternative valuation methods<br/>4 - adjusted equity methods (applicable for the valuation of participations)<br/>5 - IFRS equity methods (applicable for the valuation of participations)<br/>6 - Market valuation according to article 9(4) of Commission Delegated Regulation 2015/35</p> |
| type       | restriction of <b>xs:int</b>  |
| properties | isRef 0<br>minOcc 0<br>maxOcc 1<br>content simple   |
| facets     | Kind Value annotation<br>minInclusive 1<br>maxInclusive 6   |
| annotation | documentation<br>A110 - Use closed list:<br>1 - quoted market price in active markets for the same assets<br>2 - quoted market price in active markets for similar assets<br>3 - alternative valuation methods<br>4 - adjusted equity methods (applicable for the valuation of participations)<br>5 - IFRS equity methods (applicable for the valuation of participations)<br>6 - Market valuation according to article 9(4) of Commission Delegated Regulation 2015/35   |

element **SIIPositionType\_V5/QRTPositionInformation/AcquisitionValue**

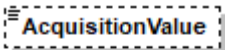
|            |  |
|------------|--|
| diagram    |  <p>A111 - Total acquisition value for assets held, clean value without accrued interest.<br/>Not applicable to CIC categories 7 and 8.</p> |
| type       | <b>xs:decimal</b>  |
| properties | isRef 0<br>minOcc 0<br>maxOcc 1<br>content simple  |
| annotation | documentation<br>A111 - Total acquisition value for assets held, clean value without accrued interest.<br>Not applicable to CIC categories 7 and 8.  |

element **SIIPositionType\_V5/QRTPositionInformation/CounterpartyRating**

|            |  |
|------------|--|
| diagram    | <p>The diagram shows a dashed box labeled 'CounterpartyRating' containing a circle with three dots. This circle is connected to a box containing two elements: 'RatingValue' and 'RatingAgency'. 'RatingValue' is described as 'A112 - Rating of the counterparty / issuer (cf specifications QRT) (S.06.02 - old: Assets D1)'. 'RatingAgency' is described as 'A113 - Name of the rating agency (cf specification QRT) (S.06.02 - old: Assets D1)'.</p> |
| properties | <p>isRef 0<br/> minOcc 0<br/> maxOcc 1<br/> content complex</p>  |
| children   | <p><a href="#">RatingValue</a> <a href="#">RatingAgency</a></p>  |

element **SIIPositionType\_V5/QRTPositionInformation/CounterpartyRating/RatingValue**

|            |  |
|------------|--|
| diagram    | <p>The diagram shows a box labeled 'RatingValue' with the text 'A112 - Rating of the counterparty / issuer (cf specifications QRT) (S.06.02 - old: Assets D1)' below it.</p> |
| type       | <p><b>xs:string</b></p>  |
| properties | <p>isRef 0<br/> content simple</p>   |
| annotation | <p>documentation<br/> A112 - Rating of the counterparty / issuer (cf specifications QRT) (S.06.02 - old: Assets D1)</p>  |

element **SIIPositionType\_V5/QRTPositionInformation/CounterpartyRating/RatingAgency**

|            |  |
|------------|--|
| diagram    | <p>The diagram shows a box labeled 'RatingAgency' with the text 'A113 - Name of the rating agency (cf specification QRT) (S.06.02 - old: Assets D1)' below it.</p> |
| type       | <p><b>xs:string</b></p>  |
| properties | <p>isRef 0<br/> content simple</p>   |
| annotation | <p>documentation<br/> A113 - Name of the rating agency (cf specification QRT) (S.06.02 - old: Assets D1)</p>   |

element **SIIPositionType\_V5/QRTPositionInformation/UnderlyingAssetCategory**

|                   |   |
|-------------------|---|
| <p>diagram</p>    | <div style="border: 1px solid black; padding: 5px; margin-bottom: 10px;"> <p><b>UnderlyingAssetCategory</b></p> </div> <p>A131 - Identifies the assets categories, receivables and derivatives within the collective investment undertaking.<br/>Possible values are:<br/>1 - Government bonds<br/>2 - Corporate bonds<br/>3L - Listed equity<br/>3X - Unlisted equity<br/>4 - Collective Investment Undertakings<br/>5 - Structured notes<br/>6 - Collateralised securities<br/>7 - Cash and deposits<br/>8 - Mortgages and loans<br/>9 - Properties<br/>0 - Other investments (including receivables)<br/>A - Futures<br/>B - Call Options<br/>C - Put Options<br/>D - Swaps<br/>E - Forwards<br/>F - Credit derivatives<br/>L - Liabilities<br/>When the look-through regards a Fund of funds, category "4 - Collective Investment Units" shall be used only for non-material residual values.</p> |
| <p>type</p>       | <p>restriction of <b>xs:string</b></p>  |
| <p>properties</p> | <p>isRef 0<br/>content simple</p>   |
| <p>facets</p>     | <p>Kind Value annotation<br/>minLength 1<br/>maxLength 2</p>  |
| <p>annotation</p> | <p>documentation<br/>A131 - Identifies the assets categories, receivables and derivatives within the collective investment undertaking.<br/>Possible values are:<br/>1 - Government bonds<br/>2 - Corporate bonds<br/>3L - Listed equity<br/>3X - Unlisted equity<br/>4 - Collective Investment Undertakings<br/>5 - Structured notes<br/>6 - Collateralised securities<br/>7 - Cash and deposits<br/>8 - Mortgages and loans<br/>9 - Properties<br/>0 - Other investments (including receivables)<br/>A - Futures<br/>B - Call Options<br/>C - Put Options<br/>D - Swaps<br/>E - Forwards<br/>F - Credit derivatives<br/>L - Liabilities<br/>When the look-through regards a Fund of funds, category "4 - Collective Investment Units" shall be used only for non-material residual values.</p>  |



element **SIIPositionType\_V5/AdditionalInformation**

diagram



|            |  |
|------------|--|
| properties | isRef 0<br>content complex   |
| children   | <a href="#">FundCustodianName</a> <a href="#">InfrastructureInvestment</a> <a href="#">Type1</a> <a href="#">private</a> <a href="#">equity</a> <a href="#">portfolio</a> <a href="#">eligibility</a> <a href="#">Type1</a> <a href="#">private</a> <a href="#">equity</a> <a href="#">issuer</a> <a href="#">beta</a> <a href="#">Counterparty</a> <a href="#">sector</a> |

element **SIIPositionType\_V5/AdditionalInformation/FundCustodianName**

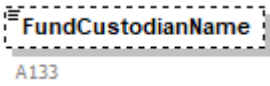
|            |   |
|------------|---|
| diagram    |  |
| type       | <b>xs:string</b>  |
| properties | isRef 0<br>minOcc 0<br>maxOcc 1<br>content simple                                 |
| annotation | documentation<br>A133   |

element **SIIPositionType\_V5/AdditionalInformation/InfrastructureInvestment**

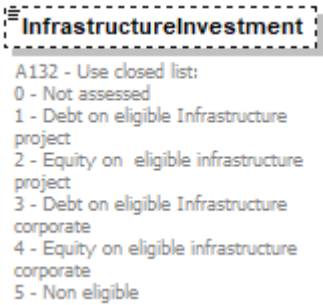
|            |  |
|------------|--|
| diagram    |    |
| type       | restriction of <b>xs:int</b>   |
| properties | isRef 0<br>minOcc 0<br>maxOcc 1<br>content simple  |
| facets     | Kind Value annotation<br>minInclusive 0<br>maxInclusive 5  |
| annotation | documentation<br>A132 - Use closed list:<br>0 - Not assessed<br>1 - Debt on eligible Infrastructure project<br>2 - Equity on eligible infrastructure project<br>3 - Debt on eligible Infrastructure corporate<br>4 - Equity on eligible infrastructure corporate<br>5 - Non eligible |

element **SIIPositionType\_V5/AdditionalInformation/Type1\_private\_equity\_portfolio\_eligibility**

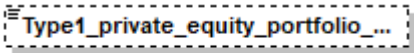
|            |  |
|------------|--|
| diagram    |  <p>A134 - Use closed list:<br/>Int (1)<br/>0 = Not assessed<br/>1= eligible for re-classification as equity type 1<br/>2 = not eligible for re-classification as equity type 1</p> |
| type       | restriction of <b>xs:int</b>   |
| properties | <p>isRef 0<br/>minOcc 0<br/>maxOcc 1<br/>content simple</p>  |
| annotation | <p>documentation<br/>A134 - Use closed list:<br/>Int (1)<br/>0 = Not assessed<br/>1= eligible for re-classification as equity type 1<br/>2 = not eligible for re-classification as equity type 1</p>   |

element **SIIPositionType\_V5/AdditionalInformation/Type1\_private\_equity\_issuer\_beta**

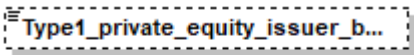
|            |  |
|------------|--|
| diagram    |  <p>A 135- Beta of the issuer of the private equity calculated according to art 168a of the regulation UE DR 2019/981</p> |
| type       | <b>xs:decimal</b>  |
| properties | <p>isRef 0<br/>minOcc 0<br/>maxOcc 1<br/>content simple</p>  |
| annotation | <p>documentation<br/>A 135- Beta of the issuer of the private equity calculated according to art 168a of the regulation UE DR 2019/981</p>   |

element **SIIPositionType\_V5/AdditionalInformation/Counterparty\_sector**

|                   |   |
|-------------------|---|
| <p>diagram</p>    | <div style="border: 1px dashed black; padding: 5px; margin-bottom: 10px;"> <p><b>Counterparty_sector</b></p> </div> <p>A137 - One of the options in the following closed list should be used for CIC category 8 and for the following CIC categories if the instrument does not have an ISIN code (i.e. if Asset ID Code and Type of code C0010 does not start with either "ISIN/" or "CAU/ISIN/");</p> <p>CIC category 1, CIC category 2, CIC category 3, CIC category 5 and CIC category 6:</p> <p>1 – central bank (ESA 2010 sector S.121)<br/>                 2 – deposit-taking corporations except the central bank (ESA 2010 sector S.122)<br/>                 3 – money market funds (ESA 2010 sector S.123)<br/>                 4 – investment funds other than money market funds (ESA 2010 sector S.124)<br/>                 5 – other financial intermediaries, except insurance corporations and pension funds (excluding financial vehicle corporations engaged in securitisation transactions) + financial auxiliaries + captive financial institutions and money lenders (ESA 2010 sector S.125 excluding FVCs + ESA 2010 sector S.126 + ESA 2010 sector S.127)<br/>                 6 – financial vehicle corporations engaged in securitisation transactions (a subdivision of ESA 2010 sector S.125)<br/>                 7 – insurance corporations (ESA 2010 sector S.128)<br/>                 8 – pension funds (ESA 2010 sector S.129)<br/>                 9 – non-financial corporations (ESA 2010 sector S.11)<br/>                 10 – general government (ESA 2010 sector S.13)<br/>                 11 – households and non-profit institutions serving households (ESA 2010 sector S.14 + ESA 2010 sector S.15)</p> <p>For CIC category 7, one of the options in the following closed list should be selected:<br/>                 12 – central bank (ESA 2010 sector S.121), deposit-taking corporations except the central bank (ESA 2010 sector S.122) and money market funds (ESA 2010 sector S.123)<br/>                 13 – non-MFIs, not included under 12</p> |
| <p>type</p>       | <p>restriction of <b>xs:int</b></p>   |
| <p>properties</p> | <p>isRef 0<br/>                 minOcc 0</p>  |

|            |   |
|------------|---|
|            | maxOcc 1<br>content simple  |
| facets     | Kind Value annotation<br>minInclusive 1<br>maxInclusive 13  |
| annotation | documentation<br>A137 - One of the options in the following closed list should be used for CIC category 8 and for the following CIC categories if the instrument does not have an ISIN code (i.e. if Asset ID Code and Type of code C0010 does not start with either "ISIN/" or "CAU/ISIN/"):<br><br>CIC category 1, CIC category 2, CIC category 3, CIC category 5 and CIC category 6:<br>1 – central bank (ESA 2010 sector S.121)<br>2 – deposit-taking corporations except the central bank (ESA 2010 sector S.122)<br>3 – money market funds (ESA 2010 sector S.123)<br>4 – investment funds other than money market funds (ESA 2010 sector S.124)<br>5 – other financial intermediaries, except insurance corporations and pension funds (excluding financial vehicle corporations engaged in securitisation transactions) + financial auxiliaries + captive financial institutions and money lenders (ESA 2010 sector S.125 excluding FVCs + ESA 2010 sector S.126 + ESA 2010 sector S.127)<br>6 – financial vehicle corporations engaged in securitisation transactions (a subdivision of ESA 2010 sector S.125)<br>7 – insurance corporations (ESA 2010 sector S.128)<br>8 – pension funds (ESA 2010 sector S.129)<br>9 – non-financial corporations (ESA 2010 sector S.11)<br>10 – general government (ESA 2010 sector S.13)<br>11 – households and non-profit institutions serving households (ESA 2010 sector S.14 + ESA 2010 sector S.15)<br><br>For CIC category 7, one of the options in the following closed list should be selected:<br>12 – central bank (ESA 2010 sector S.121), deposit-taking corporations except the central bank (ESA 2010 sector S.122) and money market funds (ESA 2010 sector S.123)<br>13 – non-MFIs, not included under 12 |

# complexType SIIPositionType\_V6

diagram

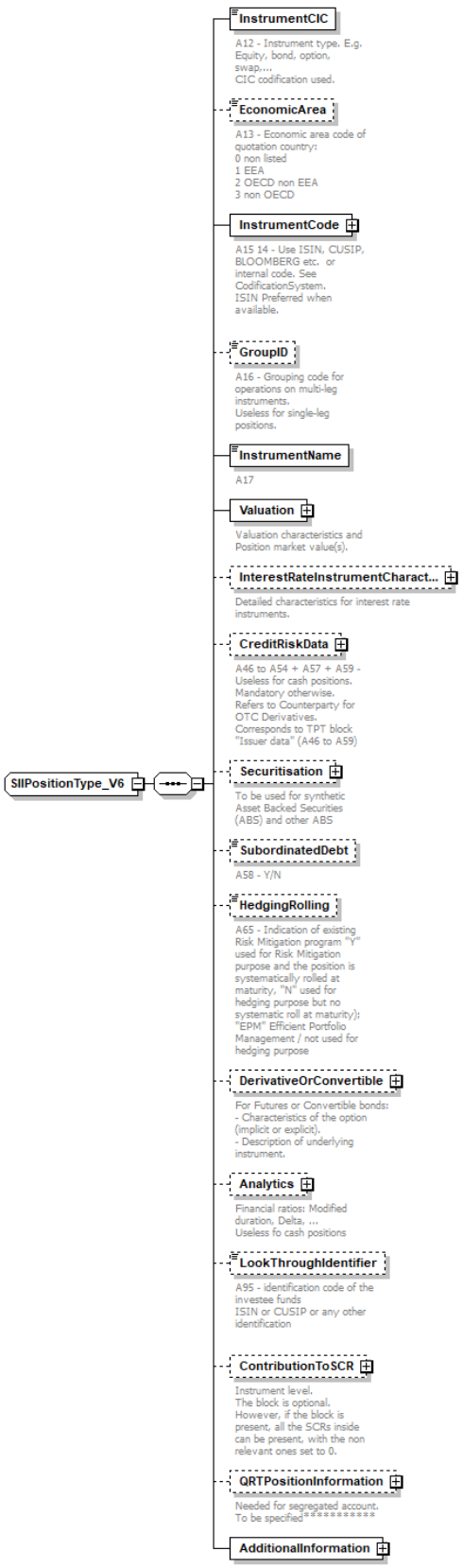

|          |   |
|----------|---|
| children | <a href="#">InstrumentCIC</a> <a href="#">EconomicArea</a> <a href="#">InstrumentCode</a> <a href="#">GroupID</a> <a href="#">InstrumentName</a> <a href="#">Valuation</a> <a href="#">InterestRateInstrumentCharacteristics</a> <a href="#">CreditRiskData</a> <a href="#">Securitisation</a> <a href="#">SubordinatedDebt</a> <a href="#">HedgingRolling</a> <a href="#">DerivativeOrConvertible</a> <a href="#">Analytics</a> <a href="#">LookThroughIdentifier</a> <a href="#">ContributionToSCR</a> <a href="#">QRTPositionInformation</a> <a href="#">AdditionalInformation</a> |
| used by  | element <a href="#">SolvencyIIPortfolioType_V6/Positions/Position</a>   |

#### element [SIIPositionType\\_V6/InstrumentCIC](#)

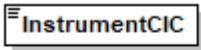
|            |   |            |       |            |           |   |  |           |   |  |         |                                    |  |
|------------|---|------------|-------|------------|-----------|---|--|-----------|---|--|---------|------------------------------------|--|
| diagram    |  <p>A12 - Instrument type. E.g. Equity, bond, option, swap, ...<br/>CIC codification used.</p>   |            |       |            |           |   |  |           |   |  |         |                                    |  |
| type       | restriction of <a href="#">CICCodeType</a>  |            |       |            |           |   |  |           |   |  |         |                                    |  |
| properties | isRef 0<br>content simple   |            |       |            |           |   |  |           |   |  |         |                                    |  |
| facets     | <table border="0"> <tr> <td>Kind</td> <td>Value</td> <td>annotation</td> </tr> <tr> <td>minLength</td> <td>4</td> <td></td> </tr> <tr> <td>maxLength</td> <td>4</td> <td></td> </tr> <tr> <td>pattern</td> <td colspan="2">([A-Z]{2}([A-F] [0-9]){1})[1-9]{1}</td> </tr> </table> | Kind       | Value | annotation | minLength | 4 |  | maxLength | 4 |  | pattern | ([A-Z]{2}([A-F] [0-9]){1})[1-9]{1} |  |
| Kind       | Value   | annotation |       |            |           |   |  |           |   |  |         |                                    |  |
| minLength  | 4   |            |       |            |           |   |  |           |   |  |         |                                    |  |
| maxLength  | 4   |            |       |            |           |   |  |           |   |  |         |                                    |  |
| pattern    | ([A-Z]{2}([A-F] [0-9]){1})[1-9]{1}  |            |       |            |           |   |  |           |   |  |         |                                    |  |
| annotation | documentation<br>A12 - Instrument type. E.g. Equity, bond, option, swap, ...<br>CIC codification used.  |            |       |            |           |   |  |           |   |  |         |                                    |  |

#### element [SIIPositionType\\_V6/EconomicArea](#)

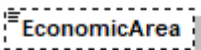
|              |  |            |       |            |              |   |  |              |   |  |
|--------------|--|------------|-------|------------|--------------|---|--|--------------|---|--|
| diagram      |  <p>A13 - Economic area code of quotation country:<br/>0 non listed<br/>1 EEA<br/>2 OECD non EEA<br/>3 non OECD</p> |            |       |            |              |   |  |              |   |  |
| type         | <a href="#">EconomicAreaType</a>   |            |       |            |              |   |  |              |   |  |
| properties   | isRef 0<br>minOcc 0<br>maxOcc 1<br>content simple  |            |       |            |              |   |  |              |   |  |
| facets       | <table border="0"> <tr> <td>Kind</td> <td>Value</td> <td>annotation</td> </tr> <tr> <td>minInclusive</td> <td>0</td> <td></td> </tr> <tr> <td>maxInclusive</td> <td>3</td> <td></td> </tr> </table>    | Kind       | Value | annotation | minInclusive | 0 |  | maxInclusive | 3 |  |
| Kind         | Value  | annotation |       |            |              |   |  |              |   |  |
| minInclusive | 0  |            |       |            |              |   |  |              |   |  |
| maxInclusive | 3  |            |       |            |              |   |  |              |   |  |
| annotation   | documentation<br>A13 - Economic area code of quotation country:<br>0 non listed<br>1 EEA<br>2 OECD non EEA<br>3 non OECD   |            |       |            |              |   |  |              |   |  |

element **SIIPositionType\_V6/InstrumentCode**

|                   |   |
|-------------------|---|
| <p>diagram</p>    | <p>The diagram illustrates the structure of the <b>SIIPositionType_V6/InstrumentCode</b> element. It shows a box for <b>InstrumentCode</b> with the text: "A15 14 - Use ISIN, CUSIP, BLOOMBERG etc. or internal code. See CodificationSystem. ISIN Preferred when available." This box is connected to a larger dashed box representing <b>SII Security Codification Type V6</b>. Inside this dashed box, there are two sub-elements: <b>CodificationSystem</b> and <b>Code</b>. <b>CodificationSystem</b> is described as: "Codification system used. Integer corresponding to the following closed list: 1 - ISO 6166 for ISIN code 2 - CUSIP (The Committee on Uniform Securities Identification Procedures number assigned by the CUSIP Service Bureau for U.S. and Canadian companies) 3 - SEDOL (Stock Exchange Daily Official List for the London Stock Exchange) 4 - WKN (Wertpapier Kenn-Nummer, the alphanumeric German identification number) 5 - Bloomberg Ticker (Bloomberg letters code that identify a company's securities) 6 - BBGID (The Bloomberg Global ID) 7 - Reuters RIC (Reuters instrument code) 8 - FIGI (Financial Instrument Global Identifier) 9 - Other code by members of the Association of National Numbering Agencies 99 - Code attributed by the undertaking". <b>Code</b> is described as: "Value of code in CodificationSystem".</p> |
| <p>type</p>       | <p><a href="#">SII Security Codification Type V6</a></p>  |
| <p>properties</p> | <p>isRef 0<br/>content complex</p>  |
| <p>children</p>   | <p><a href="#">CodificationSystem</a> <a href="#">Code</a></p>  |
| <p>annotation</p> | <p>documentation<br/>A15 14 - Use ISIN, CUSIP, BLOOMBERG etc. or internal code. See CodificationSystem. ISIN Preferred when available.</p>  |

element **SIIPositionType\_V6/GroupID**

|                |  |
|----------------|--|
| <p>diagram</p> | <p>The diagram shows the <b>GroupID</b> element, which is a dashed box containing the text: "A16 - Grouping code for operations on multi-leg instruments. Useless for single-leg positions."</p> |
| <p>type</p>    | <p>restriction of <b>xs:string</b></p>   |



|            |  |
|------------|--|
| properties | isRef 0<br>minOcc 0<br>maxOcc 1<br>content simple  |
| facets     | Kind Value annotation<br>maxLength 255   |
| annotation | documentation<br>A16 - Grouping code for operations on multi-leg instruments.<br>Useless for single-leg positions. |

element **SIIPositionType\_V6/InstrumentName**

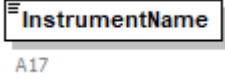
|            |   |
|------------|---|
| diagram    |  |
| type       | restriction of <b>xs:string</b>   |
| properties | isRef 0<br>content simple   |
| facets     | Kind Value annotation<br>maxLength 255  |
| annotation | documentation<br>A17  |

# element SIIPositionType\_V6/Valuation

diagram

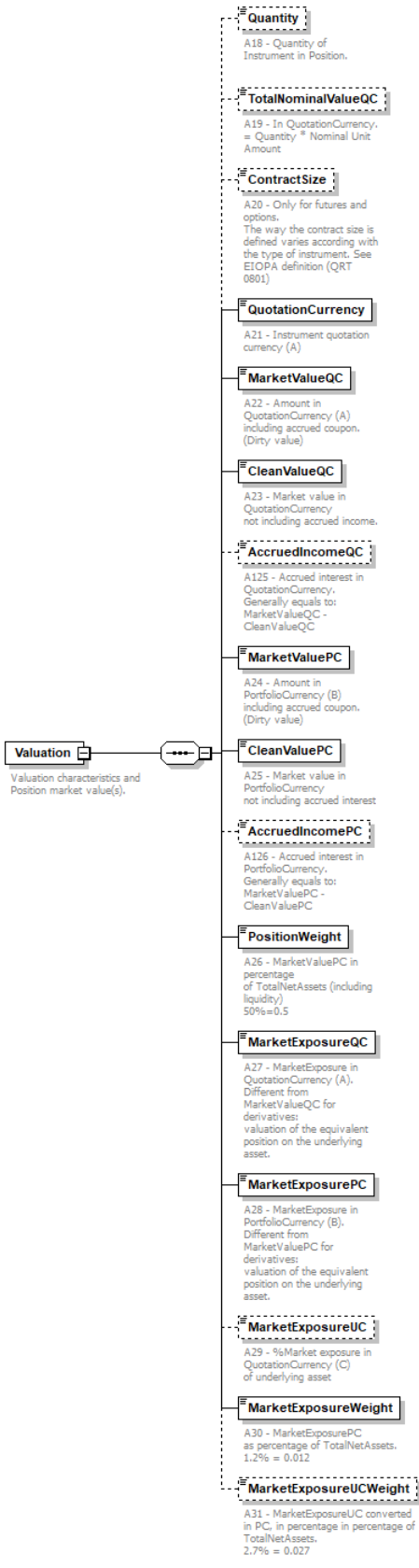

|            |   |
|------------|---|
| properties | isRef 0<br>content complex  |
| children   | <a href="#">Quantity</a> <a href="#">TotalNominalValueQC</a> <a href="#">ContractSize</a> <a href="#">QuotationCurrency</a> <a href="#">MarketValueQC</a> <a href="#">CleanValueQC</a> <a href="#">AccruedIncomeQC</a> <a href="#">MarketValuePC</a> <a href="#">CleanValuePC</a> <a href="#">AccruedIncomePC</a> <a href="#">PositionWeight</a> <a href="#">MarketExposureQC</a> <a href="#">MarketExposurePC</a> <a href="#">MarketExposureUC</a> <a href="#">MarketExposureWeight</a> <a href="#">MarketExposureUCWeight</a> |
| annotation | documentation<br>Valuation characteristics and<br>Position market value(s).   |

element **SIIPositionType\_V6/Valuation/Quantity**

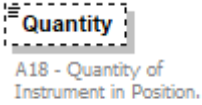
|            |   |
|------------|---|
| diagram    |  |
| type       | <b>xs:decimal</b>   |
| properties | isRef 0<br>minOcc 0<br>maxOcc 1<br>content simple                                 |
| annotation | documentation<br>A18 - Quantity of Instrument in Position.                        |

element **SIIPositionType\_V6/Valuation/TotalNominalValueQC**

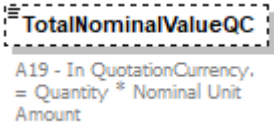
|            |   |
|------------|---|
| diagram    |  |
| type       | <b>xs:decimal</b>   |
| properties | isRef 0<br>minOcc 0<br>maxOcc 1<br>content simple                                   |
| annotation | documentation<br>A19 - In QuotationCurrency.<br>= Quantity * Nominal Unit Amount    |

element **SIIPositionType\_V6/Valuation/ContractSize**

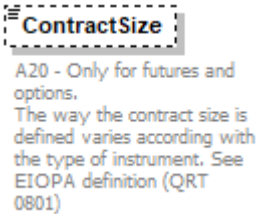
|            |   |
|------------|---|
| diagram    |  |
| type       | <b>xs:decimal</b>   |
| properties | isRef 0<br>minOcc 0<br>maxOcc 1<br>content simple                                   |

|            |  |
|------------|--|
| annotation | documentation<br>A20 - Only for futures and options.<br>The way the contract size is defined varies according with the type of instrument. See EIOPA definition (QRT 0801) |
|------------|--|

element **SIIPositionType\_V6/Valuation/QuotationCurrency**

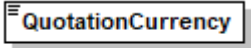
|            |  |
|------------|--|
| diagram    |  <p>A21 - Instrument quotation currency (A)</p> |
| type       | <a href="#">ISOCurrencyCodeType</a>  |
| properties | isRef 0<br>content simple  |
| facets     | Kind Value annotation<br>minLength 3<br>maxLength 3<br>pattern [A-Z]{3}  |
| annotation | documentation<br>A21 - Instrument quotation currency (A)   |

element **SIIPositionType\_V6/Valuation/MarketValueQC**

|            |  |
|------------|--|
| diagram    |  <p>A22 - Amount in QuotationCurrency (A) including accrued coupon. (Dirty value)</p> |
| type       | <b>xs:decimal</b>  |
| properties | isRef 0<br>content simple  |
| annotation | documentation<br>A22 - Amount in QuotationCurrency (A) including accrued coupon. (Dirty value)   |

element **SIIPositionType\_V6/Valuation/CleanValueQC**

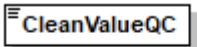
|            |  |
|------------|--|
| diagram    |  <p>A23 - Market value in QuotationCurrency not including accrued income.</p> |
| type       | <b>xs:decimal</b>  |
| properties | isRef 0<br>content simple  |
| annotation | documentation<br>A23 - Market value in QuotationCurrency not including accrued income.   |

element **SIIPositionType\_V6/Valuation/AccruedIncomeQC**

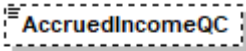
|            |  |
|------------|--|
| diagram    |  <p>A125 - Accrued interest in QuotationCurrency.<br/>Generally equals to:<br/>MarketValueQC - CleanValueQC</p> |
| type       | <b>xs:decimal</b>  |
| properties | isRef 0<br>minOcc 0<br>maxOcc 1<br>content simple  |
| annotation | documentation<br>A125 - Accrued interest in QuotationCurrency.<br>Generally equals to: MarketValueQC - CleanValueQC  |

element **SIIPositionType\_V6/Valuation/MarketValuePC**

|            |  |
|------------|--|
| diagram    |  <p>A24 - Amount in PortfolioCurrency (B) including accrued coupon.<br/>(Dirty value)</p> |
| type       | <b>xs:decimal</b>  |
| properties | isRef 0<br>content simple  |
| annotation | documentation<br>A24 - Amount in PortfolioCurrency (B) including accrued coupon.<br>(Dirty value)  |

element **SIIPositionType\_V6/Valuation/CleanValuePC**

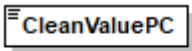
|            |   |
|------------|---|
| diagram    |  <p>A25 - Market value in PortfolioCurrency not including accrued interest</p> |
| type       | <b>xs:decimal</b>   |
| properties | isRef 0<br>content simple   |
| annotation | documentation<br>A25 - Market value in PortfolioCurrency not including accrued interest   |

element **SIIPositionType\_V6/Valuation/AccruedIncomePC**

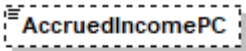
|         |  |
|---------|--|
| diagram |  <p>A126 - Accrued interest in PortfolioCurrency.<br/>Generally equals to:<br/>MarketValuePC - CleanValuePC</p> |
| type    | <b>xs:decimal</b>  |

|            |   |
|------------|---|
| properties | isRef 0<br>minOcc 0<br>maxOcc 1<br>content simple   |
| annotation | documentation<br>A126 - Accrued interest in PortfolioCurrency.<br>Generally equals to: MarketValuePC - CleanValuePC |

element **SIIPositionType\_V6/Valuation/PositionWeight**

|            |  |
|------------|--|
| diagram    |  <p><b>PositionWeight</b><br/>A26 - MarketValuePC in percentage of TotalNetAssets (including liquidity)<br/>50%=0.5</p> |
| type       | <b>xs:decimal</b>  |
| properties | isRef 0<br>content simple  |
| annotation | documentation<br>A26 - MarketValuePC in percentage of TotalNetAssets (including liquidity)<br>50%=0.5  |

element **SIIPositionType\_V6/Valuation/MarketExposureQC**

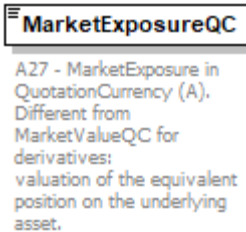
|            |  |
|------------|--|
| diagram    |  <p><b>MarketExposureQC</b><br/>A27 - MarketExposure in QuotationCurrency (A).<br/>Different from MarketValueQC for derivatives:<br/>valuation of the equivalent position on the underlying asset.</p> |
| type       | <b>xs:decimal</b>  |
| properties | isRef 0<br>content simple  |
| annotation | documentation<br>A27 - MarketExposure in QuotationCurrency (A).<br>Different from MarketValueQC for derivatives:<br>valuation of the equivalent position on the underlying asset.  |

element **SIIPositionType\_V6/Valuation/MarketExposurePC**

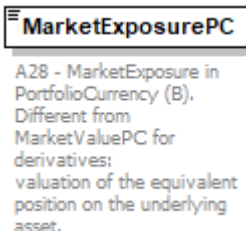
|            |   |
|------------|---|
| diagram    |  <p><b>MarketExposurePC</b><br/>A28 - MarketExposure in PortfolioCurrency (B).<br/>Different from MarketValuePC for derivatives:<br/>valuation of the equivalent position on the underlying asset.</p> |
| type       | <b>xs:decimal</b>   |
| properties | isRef 0   |

|            |   |
|------------|---|
|            | content simple  |
| annotation | documentation<br>A28 - MarketExposure in PortfolioCurrency (B).<br>Different from MarketValuePC for derivatives:<br>valuation of the equivalent position on the underlying asset. |

element **SIIPositionType\_V6/Valuation/MarketExposureUC**

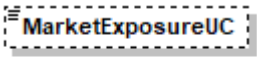
|            |  |
|------------|--|
| diagram    |  <p>A29 - %Market exposure in QuotationCurrency (C) of underlying asset</p> |
| type       | <b>xs:decimal</b>  |
| properties | isRef 0<br>minOcc 0<br>maxOcc 1<br>content simple  |
| annotation | documentation<br>A29 - %Market exposure in QuotationCurrency (C) of underlying asset   |

element **SIIPositionType\_V6/Valuation/MarketExposureWeight**

|            |   |
|------------|---|
| diagram    |  <p>A30 - MarketExposurePC as percentage of TotalNetAssets.<br/>1.2% = 0.012</p> |
| type       | <b>xs:decimal</b>   |
| properties | isRef 0<br>content simple   |
| annotation | documentation<br>A30 - MarketExposurePC as percentage of TotalNetAssets.<br>1.2% = 0.012  |

element **SIIPositionType\_V6/Valuation/MarketExposureUCWeight**

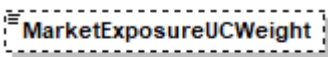
|            |  |
|------------|--|
| diagram    |  <p>A31 - MarketExposureUC converted in PC, in percentage in percentage of TotalNetAssets.<br/>2.7% = 0.027</p> |
| type       | <b>xs:decimal</b>  |
| properties | isRef 0<br>minOcc 0<br>maxOcc 1<br>content simple  |
| annotation | documentation<br>A31 - MarketExposureUC converted in PC, in percentage in percentage of TotalNetAssets.<br>2.7% = 0.027  |

element **SIIPositionType\_V6/InterestRateInstrumentCharacteristics**

|                   |  |
|-------------------|--|
| <p>diagram</p>    | <p><b>InterestRateInstrumentCharact...</b><br/>Detailed characteristics for interest rate instruments.</p> <ul style="list-style-type: none"> <li><b>RateType</b><br/>A32 - Type of interest rate: "Fixed" (fixe), "Variable" (révisable), "Floating" (variable), "Inflation_linked" (inflation linked bonds)</li> <li><b>CouponRate</b><br/>A33 - Next annual coupon rate in percentage (known, or estimated for Floating). 3.5% has to be written "3.5"</li> <li><b>VariableRate</b><br/>For Floating/Variable rate bond.</li> <li><b>CouponFrequency</b><br/>A38 - Coupon payment frequency as number of coupons per year<br/>0 = other than below options:<br/>1= annual<br/>2= biannual<br/>4= quarterly<br/>12= monthly<br/>52= weekly</li> <li><b>EffectiveDateOfInstrument</b><br/>A63 - Start date to accrue interest.</li> <li><b>Redemption</b><br/>A39 40 41 - Redemption details</li> <li><b>EmbeddedOption</b><br/>To be used only for a callable / puttable bond. The embedded option is described only for the first option date to come.</li> <li><b>ValuationYieldCurve</b><br/>Specific data in case no yield curve of reference is available (e.g. for developing countries or BRICS)</li> </ul> |
| <p>properties</p> | <p>isRef 0<br/>minOcc 0<br/>maxOcc 1<br/>content complex</p>   |
| <p>children</p>   | <p><a href="#">RateType</a> <a href="#">CouponRate</a> <a href="#">VariableRate</a> <a href="#">CouponFrequency</a> <a href="#">EffectiveDateOfInstrument</a> <a href="#">Redemption</a> <a href="#">EmbeddedOption</a> <a href="#">ValuationYieldCurve</a></p>  |
| <p>annotation</p> | <p>documentation<br/>Detailed characteristics for interest rate instruments.</p>   |

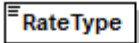

element **SIIPositionType\_V6/InterestRateInstrumentCharacteristics/RateType**

|            |   |
|------------|---|
| diagram    |  <p><b>RateType</b></p> <p>A32 - Type of interest rate:<br/> "Fixed" (fixe), "Variable" (révisable), "Floating" (variable), "Infation_linked" (inflation linked bonds)</p> |
| type       | restriction of <b>xs:string</b>   |
| properties | isRef 0<br>content simple   |
| annotation | documentation<br>A32 - Type of interest rate:<br>"Fixed" (fixe), "Variable" (révisable), "Floating" (variable), " Infation_linked" (inflation linked bonds)   |

element **SIIPositionType\_V6/InterestRateInstrumentCharacteristics/CouponRate**

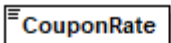
|            |   |
|------------|---|
| diagram    |  <p><b>CouponRate</b></p> <p>A33 - Next annual coupon rate in percentage (known, or estimated for Floating).<br/> 3.5% has to be written "3.5"</p> |
| type       | <a href="#">PercentageType</a>  |
| properties | isRef 0<br>content simple   |
| annotation | documentation<br>A33 - Next annual coupon rate in percentage (known, or estimated for Floating).<br>3.5% has to be written "3.5"  |

element **SIIPositionType\_V6/InterestRateInstrumentCharacteristics/VariableRate**

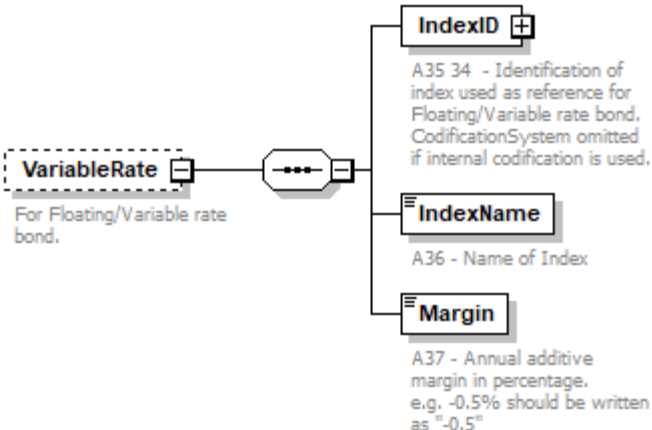
|            |  |
|------------|--|
| diagram    |  <p><b>VariableRate</b></p> <p>For Floating/Variable rate bond.</p> <p><b>IndexID</b></p> <p>A35 34 - Identification of index used as reference for Floating/Variable rate bond. CodificationSystem omitted if internal codification is used.</p> <p><b>IndexName</b></p> <p>A36 - Name of Index</p> <p><b>Margin</b></p> <p>A37 - Annual additive margin in percentage. e.g. -0.5% should be written as "-0.5"</p> |
| properties | isRef 0<br>minOcc 0<br>maxOcc 1<br>content complex   |
| children   | <a href="#">IndexID</a> <a href="#">IndexName</a> <a href="#">Margin</a>   |
| annotation | documentation<br>For Floating/Variable rate bond.  |

element **SIIPositionType\_V6/InterestRateInstrumentCharacteristics/VariableRate/IndexID**

|            |   |
|------------|---|
| diagram    | <p>The diagram illustrates the structure of the <b>IndexID</b> element. It is connected to a container element <b>CodificationType_V5</b>. Inside this container, there are two sub-elements: <b>CodificationSystem</b> and <b>Code</b>. The <b>CodificationSystem</b> element is described as "Codification system used." and the <b>Code</b> element is described as "Value of code in CodificationSystem".</p> |
| type       | <a href="#">CodificationType_V5</a>   |
| properties | isRef 0<br>content complex  |
| children   | <a href="#">CodificationSystem</a> <a href="#">Code</a>   |
| annotation | documentation<br>A35 34 - Identification of index used as reference for Floating/Variable rate bond. CodificationSystem omitted if internal codification is used.   |

element **SIIPositionType\_V6/InterestRateInstrumentCharacteristics/VariableRate/IndexName**

|            |   |
|------------|---|
| diagram    | <p>The diagram shows the <b>IndexName</b> element, which is a simple string type. Its documentation is "A36 - Name of Index".</p> |
| type       | <b>xs:string</b>  |
| properties | isRef 0<br>content simple   |
| annotation | documentation<br>A36 - Name of Index  |

element **SIIPositionType\_V6/InterestRateInstrumentCharacteristics/VariableRate/Margin**

|            |   |
|------------|---|
| diagram    | <p>The diagram shows the <b>Margin</b> element, which is a percentage type. Its documentation is "A37 - Annual additive margin in percentage. e.g. -0.5% should be written as "-0.5".</p> |
| type       | <a href="#">PercentageType</a>  |
| properties | isRef 0<br>content simple   |
| annotation | documentation<br>A37 - Annual additive margin in percentage. e.g. -0.5% should be written as "-0.5"   |

element **SIIPositionType\_V6/InterestRateInstrumentCharacteristics/CouponFrequency**

|            |   |
|------------|---|
| diagram    |  <p>A38 - Coupon payment frequency as number of coupons per year<br/> 0 = other than below options:<br/> 1= annual<br/> 2= biannual<br/> 4= quarterly<br/> 12= monthly<br/> 52= weekly</p> |
| type       | <a href="#">SIICouponFrequencyType</a>  |
| properties | isRef 0<br>content simple   |
| annotation | documentation<br>A38 - Coupon payment frequency as number of coupons per year<br>0 = other than below options:<br>1= annual<br>2= biannual<br>4= quarterly<br>12= monthly<br>52= weekly   |

element **SIIPositionType\_V6/InterestRateInstrumentCharacteristics/EffectiveDateOfInstrument**

|            |  |
|------------|--|
| diagram    |  <p>A63 - Start date to accrue interest.</p> |
| type       | <b>xs:date</b>   |
| properties | isRef 0<br>minOcc 0<br>maxOcc 1<br>content simple  |
| annotation | documentation<br>A63 - Start date to accrue interest.  |

element **SIIPositionType\_V6/InterestRateInstrumentCharacteristics/Redemption**

|                   |   |
|-------------------|---|
| <p>diagram</p>    |   |
| <p>type</p>       | <p><a href="#">RedemptionType_V6</a></p>                                      |
| <p>properties</p> | <p>isRef 0<br/>content complex</p>  |
| <p>children</p>   | <p><a href="#">MaturityDate</a> <a href="#">Type</a> <a href="#">Rate</a></p> |
| <p>annotation</p> | <p>documentation<br/>A39 40 41 - Redemption details</p>                       |

element **SIIPositionType\_V6/InterestRateInstrumentCharacteristics/EmbeddedOption**

|                   |  |
|-------------------|--|
| <p>diagram</p>    |  |
| <p>properties</p> | <p>isRef 0<br/>minOcc 0<br/>maxOcc 1<br/>content complex</p> |

|            |  |
|------------|--|
| children   | <a href="#">CallPutType</a> <a href="#">CallPutDate</a> <a href="#">OptionDirection</a> <a href="#">StrikePrice</a>                          |
| annotation | documentation<br>To be used only for a callable / puttable bond.<br>The embedded option is described only for the first option date to come. |

element **SIIPositionType\_V6/InterestRateInstrumentCharacteristics/EmbeddedOption/CallPutType**

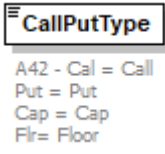
|            |   |
|------------|---|
| diagram    |  |
| type       | restriction of <b>xs:string</b>   |
| properties | isRef 0<br>content simple   |
| annotation | documentation<br>A42 - Cal = Call<br>Put = Put<br>Cap = Cap<br>Flr= Floor         |

element **SIIPositionType\_V6/InterestRateInstrumentCharacteristics/EmbeddedOption/CallPutDate**

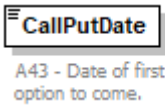
|            |  |
|------------|--|
| diagram    |  |
| type       | <b>xs:date</b>   |
| properties | isRef 0<br>content simple  |
| annotation | documentation<br>A43 - Date of first Call / Put option to come.                    |

element **SIIPositionType\_V6/InterestRateInstrumentCharacteristics/EmbeddedOption/OptionDirection**

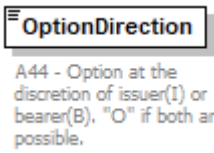
|            |  |
|------------|--|
| diagram    |                   |
| type       | restriction of <b>xs:string</b>  |
| properties | isRef 0<br>content simple  |
| facets     | Kind Value annotation<br>minLength 1<br>maxLength 1  |
| annotation | documentation<br>A44 - Option at the discretion of issuer(I) or bearer(B). "O" if both are possible. |

element **SIIPositionType\_V6/InterestRateInstrumentCharacteristics/EmbeddedOption/StrikePrice**

|            |  |
|------------|--|
| diagram    |  <p><b>StrikePrice</b></p> <p>A45 - Strike price of first optional Call / Put as a percentage of nominal amount.<br/>95%=0.95</p> |
| type       | <b>xs:decimal</b>  |
| properties | isRef 0<br>content simple  |
| annotation | documentation<br>A45 - Strike price of first optional Call / Put as a percentage of nominal amount.<br>95%=0.95  |

element **SIIPositionType\_V6/InterestRateInstrumentCharacteristics/ValuationYieldCurve**

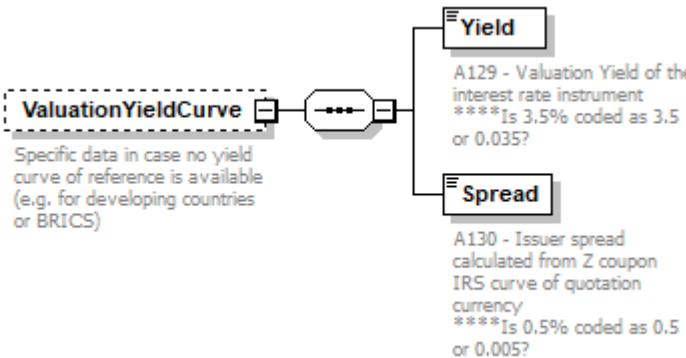
|            |   |
|------------|---|
| diagram    |  <p><b>ValuationYieldCurve</b></p> <p>Specific data in case no yield curve of reference is available (e.g. for developing countries or BRICS)</p> <p><b>Yield</b></p> <p>A129 - Valuation Yield of the interest rate instrument<br/>****Is 3.5% coded as 3.5 or 0.035?</p> <p><b>Spread</b></p> <p>A130 - Issuer spread calculated from Z coupon IRS curve of quotation currency<br/>****Is 0.5% coded as 0.5 or 0.005?</p> |
| properties | isRef 0<br>minOcc 0<br>maxOcc 1<br>content complex  |
| children   | <a href="#">Yield Spread</a>  |
| annotation | documentation<br>Specific data in case no yield curve of reference is available (e.g. for developing countries or BRICS)  |

element **SIIPositionType\_V6/InterestRateInstrumentCharacteristics/ValuationYieldCurve/Yield**

|            |  |
|------------|--|
| diagram    |  <p><b>Yield</b></p> <p>A129 - Valuation Yield of the interest rate instrument<br/>****Is 3.5% coded as 3.5 or 0.035?</p> |
| type       | <b>xs:decimal</b>  |
| properties | isRef 0<br>content simple  |
| annotation | documentation<br>A129 - Valuation Yield of the interest rate instrument<br>****Is 3.5% coded as 3.5 or 0.035?  |

element **SIIPositionType\_V6/InterestRateInstrumentCharacteristics/ValuationYieldCurve/Spread**

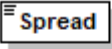
|                   |   |
|-------------------|---|
| <p>diagram</p>    |  <p>A130 - Issuer spread<br/>calculated from Z coupon<br/>IRS curve of quotation<br/>currency<br/>****Is 0.5% coded as 0.5<br/>or 0.005?</p> |
| <p>type</p>       | <p><b>xs:decimal</b></p>  |
| <p>properties</p> | <p>isRef 0<br/>content simple</p>   |
| <p>annotation</p> | <p>documentation<br/>A130 - Issuer spread calculated from Z coupon IRS curve of quotation currency<br/>****Is 0.5% coded as 0.5 or 0.005?</p>   |

element **SIIPositionType\_V6/CreditRiskData**

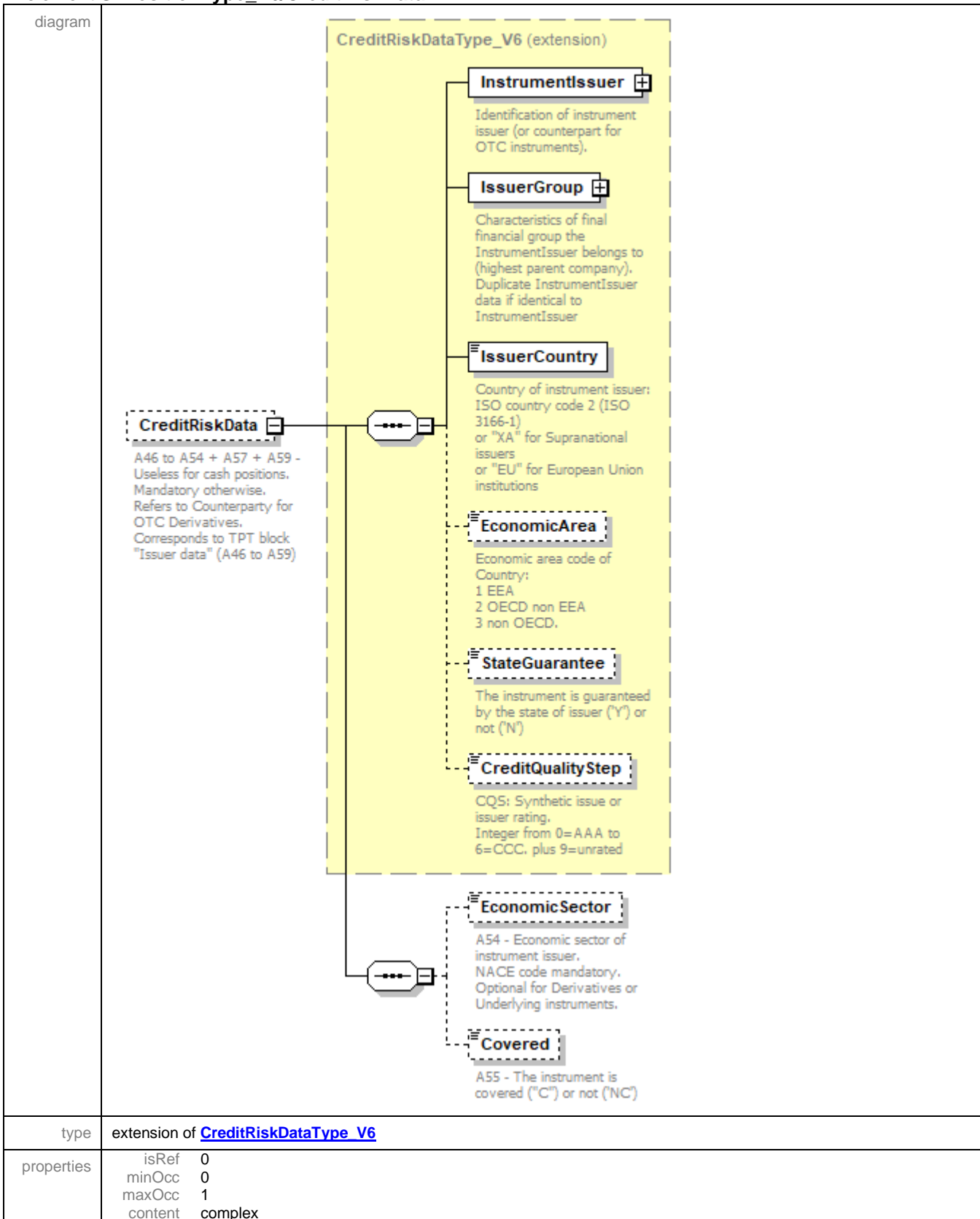



|            |   |
|------------|---|
| children   | <a href="#">InstrumentIssuer</a> <a href="#">IssuerGroup</a> <a href="#">IssuerCountry</a> <a href="#">EconomicArea</a> <a href="#">StateGuarantee</a> <a href="#">CreditQualityStep</a> <a href="#">EconomicSector</a> <a href="#">Covered</a> |
| annotation | documentation<br>A46 to A54 + A57 + A59 - Useless for cash positions.<br>Mandatory otherwise.<br>Refers to Counterparty for OTC Derivatives.<br>Corresponds to TPT block "Issuer data" (A46 to A59)   |

element **SIIPositionType\_V6/CreditRiskData/EconomicSector**

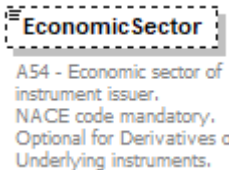
|            |   |
|------------|---|
| diagram    |    |
| type       | <a href="#">NACECodeType</a>  |
| properties | isRef 0<br>minOcc 0<br>maxOcc 1<br>content simple   |
| facets     | Kind Value annotation<br>minLength 1<br>maxLength 7<br>pattern ([A-Z]{1}[0-9\.\.]{0,6})   |
| annotation | documentation<br>A54 - Economic sector of instrument issuer.<br>NACE code mandatory.<br>Optional for Derivatives or Underlying instruments. |

element **SIIPositionType\_V6/CreditRiskData/Covered**

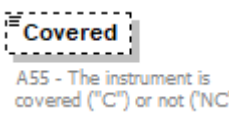
|            |   |
|------------|---|
| diagram    |  |
| type       | restriction of <b>xs:string</b>   |
| properties | isRef 0<br>minOcc 0<br>maxOcc 1<br>content simple                                   |
| annotation | documentation<br>A55 - The instrument is covered ("C") or not ("NC")                |

element **SIIPositionType\_V6/Securitisation**

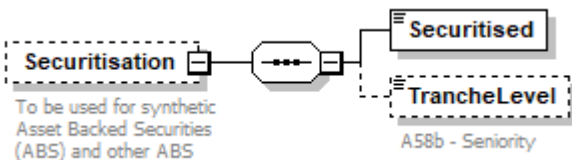
|            |   |
|------------|---|
| diagram    |  |
| properties | isRef 0<br>minOcc 0<br>maxOcc 1<br>content complex                                  |

|            |   |
|------------|---|
| children   | <a href="#">Securitised TrancheLevel</a>  |
| annotation | documentation<br>To be used for synthetic Asset Backed Securities (ABS) and other ABS |

element **SIIPositionType\_V6/Securitisation/Securitised**

|            |   |
|------------|---|
| diagram    |  |
| type       | restriction of <b>xs:string</b>   |
| properties | isRef 0<br>content simple   |

element **SIIPositionType\_V6/Securitisation/TrancheLevel**

|            |   |
|------------|---|
| diagram    |  |
| type       | <b>xs:string</b>  |
| properties | isRef 0<br>minOcc 0<br>maxOcc 1<br>content simple                                 |
| annotation | documentation<br>A58b - Seniority   |

element **SIIPositionType\_V6/SubordinatedDebt**

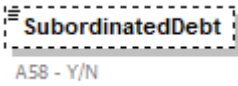
|            |   |
|------------|---|
| diagram    |  |
| type       | <a href="#">YesNoL1Type</a>   |
| properties | isRef 0<br>minOcc 0<br>maxOcc 1<br>content simple                                   |
| facets     | Kind Value annotation<br>minLength 1<br>maxLength 1                                 |
| annotation | documentation<br>A58 - Y/N  |

element **SIIPositionType\_V6/HedgingRolling**

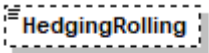
|            |  |
|------------|--|
| diagram    |  <p><b>HedgingRolling</b></p> <p>A65 - Indication of existing Risk Mitigation program "Y" used for Risk Mitigation purpose and the position is systematically rolled at maturity, "N" used for hedging purpose but no systematic roll at maturity); "EPM" Efficient Portfolio Management / not used for hedging purpose</p> |
| type       | restriction of <b>xs:string</b>  |
| properties | <p>isRef 0</p> <p>minOcc 0</p> <p>maxOcc 1</p> <p>content simple</p>   |
| annotation | <p>documentation</p> <p>A65 - Indication of existing Risk Mitigation program "Y" used for Risk Mitigation purpose and the position is systematically rolled at maturity, "N" used for hedging purpose but no systematic roll at maturity); "EPM" Efficient Portfolio Management / not used for hedging purpose</p>   |

element **SIIPositionType\_V6/DerivativeOrConvertible**

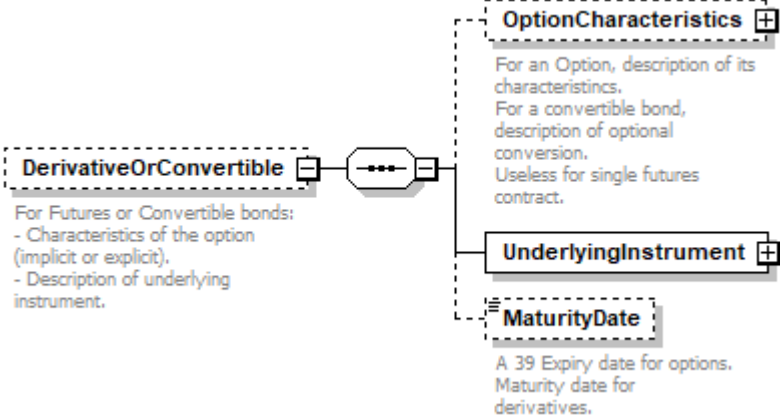
|            |  |
|------------|--|
| diagram    |  <p><b>DerivativeOrConvertible</b></p> <p>For Futures or Convertible bonds:</p> <ul style="list-style-type: none"> <li>- Characteristics of the option (implicit or explicit).</li> <li>- Description of underlying instrument.</li> </ul> <p><b>OptionCharacteristics</b></p> <p>For an Option, description of its characteristics.<br/>For a convertible bond, description of optional conversion.<br/>Useless for single futures contract.</p> <p><b>UnderlyingInstrument</b></p> <p><b>MaturityDate</b></p> <p>A 39 Expiry date for options.<br/>Maturity date for derivatives.</p> |
| properties | <p>isRef 0</p> <p>minOcc 0</p> <p>maxOcc 1</p> <p>content complex</p>  |
| children   | <a href="#">OptionCharacteristics</a> <a href="#">UnderlyingInstrument</a> <a href="#">MaturityDate</a>  |
| annotation | <p>documentation</p> <p>For Futures or Convertible bonds:</p> <ul style="list-style-type: none"> <li>- Characteristics of the option (implicit or explicit).</li> <li>- Description of underlying instrument.</li> </ul>   |

element **SIIPositionType\_V6/DerivativeOrConvertible/OptionCharacteristics**

|                   |   |
|-------------------|---|
| <p>diagram</p>    | <p><b>OptionCharacteristics</b></p> <p>For an Option, description of its characteristics.<br/>For a convertible bond, description of optional conversion.<br/>Useless for single futures contract.</p> <p><b>CallPutType</b></p> <p>A60 - Option type<br/>"Cal"=call<br/>"Put"=put<br/>"Cap"=cap<br/>"Flr"=floor</p> <p><b>StrikePrice</b></p> <p>A61 - Strike price of the option in same unit as price of underlying instrument.</p> <p><b>ConversionRatio</b></p> <p>A62 - Quantity of UnderlyingInstrument obtained for one "Instrument".</p> <p><b>ExerciseType</b></p> <p>A64 - Option style: American, European, Asiatic, Bermudian<br/>Optional for convertibles</p> <p><b>Convertible</b> +</p> <p>Only for Convertible bond.<br/>For pricing using shock modelling.</p> |
| <p>properties</p> | <p>isRef 0<br/>minOcc 0<br/>maxOcc 1<br/>content complex</p>  |
| <p>children</p>   | <p><a href="#">CallPutType</a> <a href="#">StrikePrice</a> <a href="#">ConversionRatio</a> <a href="#">ExerciseType</a> <a href="#">Convertible</a></p>   |
| <p>annotation</p> | <p>documentation<br/>For an Option, description of its characteristics.<br/>For a convertible bond, description of optional conversion.<br/>Useless for single futures contract.</p>  |

element **SIIPositionType\_V6/DerivativeOrConvertible/OptionCharacteristics/CallPutType**

|                   |   |
|-------------------|---|
| <p>diagram</p>    | <p><b>CallPutType</b></p> <p>A60 - Option type<br/>"Cal"=call<br/>"Put"=put<br/>"Cap"=cap<br/>"Flr"=floor</p> |
| <p>type</p>       | <p>restriction of <b>xs:string</b></p>  |
| <p>properties</p> | <p>isRef 0<br/>content simple</p>   |
| <p>facets</p>     | <p>Kind Value annotation<br/>length 3</p>   |
| <p>annotation</p> | <p>documentation<br/>A60 - Option type<br/>"Cal"=call<br/>"Put"=put<br/>"Cap"=cap<br/>"Flr"=floor</p>         |

element **SIIPositionType\_V6/DerivativeOrConvertible/OptionCharacteristics/StrikePrice**

|            |   |
|------------|---|
| diagram    |  <p>A61 - Strike price of the option in same unit as price of underlying instrument.</p> |
| type       | <b>xs:decimal</b>   |
| properties | isRef 0<br>content simple   |
| annotation | documentation<br>A61 - Strike price of the option in same unit as price of underlying instrument.   |

element **SIIPositionType\_V6/DerivativeOrConvertible/OptionCharacteristics/ConversionRatio**

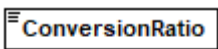
|            |  |
|------------|--|
| diagram    |  <p>A62 - Quantity of UnderlyingInstrument obtained for one "Instrument".</p> |
| type       | <b>xs:decimal</b>  |
| properties | isRef 0<br>content simple  |
| annotation | documentation<br>A62 - Quantity of UnderlyingInstrument obtained for one "Instrument".   |

element **SIIPositionType\_V6/DerivativeOrConvertible/OptionCharacteristics/ExerciseType**

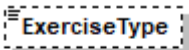
|            |   |
|------------|---|
| diagram    |  <p>A64 - Option style: American, European, Asiatic, Bermudian<br/>Optional for convertibles</p> |
| type       | restriction of <b>xs:string</b>   |
| properties | isRef 0<br>minOcc 0<br>maxOcc 1<br>content simple   |
| facets     | Kind Value annotation<br>minLength 2<br>maxLength 2   |
| annotation | documentation<br>A64 - Option style: American, European, Asiatic, Bermudian<br>Optional for convertibles  |

element **SIIPositionType\_V6/DerivativeOrConvertible/OptionCharacteristics/Convertible**

|            |  |
|------------|--|
| diagram    | <p><b>Convertible</b><br/>Only for Convertible bond.<br/>For pricing using shock modelling.</p> <p><b>BondFloor</b><br/>A127 - Lowest value of a convertible bond expressed in quotation currency, at current issuer spread</p> <p><b>OptionPremium</b><br/>A128 - Premium of the embedded option of a convertible bond in quotation currency.</p> |
| properties | isRef 0<br>minOcc 0<br>maxOcc 1<br>content complex   |
| children   | <a href="#">BondFloor</a> <a href="#">OptionPremium</a>  |
| annotation | documentation<br>Only for Convertible bond.<br>For pricing using shock modelling.  |

element **SIIPositionType\_V6/DerivativeOrConvertible/OptionCharacteristics/Convertible/BondFloor**

|            |   |
|------------|---|
| diagram    | <p><b>BondFloor</b><br/>A127 - Lowest value of a convertible bond expressed in quotation currency, at current issuer spread</p> |
| type       | <b>xs:decimal</b>   |
| properties | isRef 0<br>minOcc 0<br>maxOcc 1<br>content simple   |
| annotation | documentation<br>A127 - Lowest value of a convertible bond expressed in quotation currency, at current issuer spread            |

element **SIIPositionType\_V6/DerivativeOrConvertible/OptionCharacteristics/Convertible/OptionPremium**

|            |  |
|------------|--|
| diagram    | <p><b>OptionPremium</b><br/>A128 - Premium of the embedded option of a convertible bond in quotation currency.</p> |
| type       | <b>xs:decimal</b>  |
| properties | isRef 0<br>minOcc 0<br>maxOcc 1<br>content simple  |
| annotation | documentation<br>A128 - Premium of the embedded option of a convertible bond in quotation currency.                |

element **SIIPositionType\_V6/DerivativeOrConvertible/UnderlyingInstrument**

|                   |  |
|-------------------|--|
| <p>diagram</p>    | <p><b>UnderlyingInstrument</b> (Complex Type)</p> <ul style="list-style-type: none"> <li><b>InstrumentCIC</b> (Mandatory): A67 - Instrument type. E.g. Equity, bond, option, swap, ... CIC codification.</li> <li><b>InstrumentCode</b> (Mandatory): A69 68 - Use ISIN, CUSIP, or OtherSecurityCodes/Name(of codification system) for BLOOMBERG, TELEKURS or Internal code</li> <li><b>InstrumentName</b> (Mandatory): A70 - Name of underlying instrument.</li> <li><b>Valuation</b> (Mandatory):</li> <li><b>Coupon</b> (Optional): If underlying instrument is an interest rate instrument.</li> <li><b>Redemption</b> (Optional): A77 78 79 - Redemption details. If underlying instrument is an interest rate instrument.</li> <li><b>CreditRiskData</b> (Optional): A80 to A89 - Issuer of underlying instrument (or counterparty for OTC instruments).</li> </ul> |
| <p>properties</p> | <p>isRef 0<br/>content complex</p>   |
| <p>children</p>   | <p><a href="#">InstrumentCIC</a> <a href="#">InstrumentCode</a> <a href="#">InstrumentName</a> <a href="#">Valuation</a> <a href="#">Coupon</a> <a href="#">Redemption</a> <a href="#">CreditRiskData</a></p>  |

element **SIIPositionType\_V6/DerivativeOrConvertible/UnderlyingInstrument/InstrumentCIC**

|                   |  |
|-------------------|--|
| <p>diagram</p>    | <p><b>InstrumentCIC</b> (Simple Type)</p> <p>A67 - Instrument type. E.g. Equity, bond, option, swap, ... CIC codification.</p> |
| <p>type</p>       | <p><a href="#">CICCodeType</a></p>   |
| <p>properties</p> | <p>isRef 0<br/>content simple</p>  |
| <p>facets</p>     | <p>Kind Value annotation<br/>minLength 4<br/>maxLength 4<br/>pattern ([A-Z]{2}([A-F] [0-9]){1}[1-9]{1})</p>                    |

|            |  |
|------------|--|
| annotation | documentation<br>A67 - Instrument type. E.g. Equity, bond, option, swap,...<br>CIC codification. |
|------------|--|

element **SIIPositionType\_V6/DerivativeOrConvertible/UnderlyingInstrument/InstrumentCode**

|            |  |
|------------|--|
| diagram    | <p><b>InstrumentCode</b><br/>A69 68 - Use ISIN, CUSIP, or OtherSecurityCodes/Name(of codification system) for BLOOMBERG, TELEKURS or Internal code</p> <p><b>SII Security Codification Type V5</b></p> <p><b>Codification System</b><br/>Codification system used. Integer corresponding to the following closed list:<br/>1 - ISO 6166 for ISIN code<br/>2 - CUSIP (The Committee on Uniform Securities Identification Procedures number assigned by the CUSIP Service Bureau for U.S. and Canadian companies)<br/>3 - SEDOL (Stock Exchange Daily Official List for the London Stock Exchange)<br/>4 - WKN (Wertpapier Kenn-Nummer, the alphanumeric German identification number)<br/>5 - Bloomberg Ticker (Bloomberg letters code that identify a company's securities)<br/>6 - BBGID (The Bloomberg Global ID)<br/>7 - Reuters RIC (Reuters instrument code)<br/>8 - FIGI (Financial Instrument Global Identifier)<br/>9 - Other code by members of the Association of National Numbering Agencies<br/>99 - Code attributed by the undertaking</p> <p><b>Code</b><br/>Value of code in CodificationSystem</p> |
| type       | <a href="#">SII Security Codification Type V5</a>  |
| properties | isRef 0<br>content complex   |
| children   | <a href="#">Codification System</a> <a href="#">Code</a>   |
| annotation | documentation<br>A69 68 - Use ISIN, CUSIP, or OtherSecurityCodes/Name(of codification system) for BLOOMBERG, TELEKURS or Internal code   |

element **SIIPositionType\_V6/DerivativeOrConvertible/UnderlyingInstrument/InstrumentName**

|         |   |
|---------|---|
| diagram | <p><b>InstrumentName</b><br/>A70 - Name of underlying instrument.</p> |
|---------|---|



|            |   |
|------------|---|
| type       | <b>xs:string</b>                                      |
| properties | isRef 0<br>content simple                             |
| annotation | documentation<br>A70 - Name of underlying instrument. |

element **SIIPositionType\_V6/DerivativeOrConvertible/UnderlyingInstrument/Valuation**

|            |  |
|------------|--|
| diagram    | <p><b>Valuation</b></p> <ul style="list-style-type: none"> <li><b>Currency</b><br/>A71 - Quotation currency (C)</li> <li><b>MarketPrice</b><br/>A72 - Last market price known, in Currency (C).</li> <li><b>Country</b><br/>A73 - Country of quotation</li> <li><b>EconomicArea</b><br/>A74 - Economic area code of Country of quotation:<br/>0 non listed<br/>1 EEA;<br/>2 OECD non EEA<br/>3 non OECD</li> </ul> |
| properties | isRef 0<br>content complex   |
| children   | <a href="#">Currency</a> <a href="#">MarketPrice</a> <a href="#">Country</a> <a href="#">EconomicArea</a>  |

element **SIIPositionType\_V6/DerivativeOrConvertible/UnderlyingInstrument/Valuation/Currency**

|            |   |
|------------|---|
| diagram    | <p><b>Currency</b><br/>A71 - Quotation currency (C)</p>                 |
| type       | <a href="#">ISOCurrencyCodeType</a>                                     |
| properties | isRef 0<br>content simple   |
| facets     | Kind Value annotation<br>minLength 3<br>maxLength 3<br>pattern [A-Z]{3} |
| annotation | documentation<br>A71 - Quotation currency (C)                           |

element **SIIPositionType\_V6/DerivativeOrConvertible/UnderlyingInstrument/Valuation/MarketPrice**

|         |   |
|---------|---|
| diagram | <p><b>MarketPrice</b><br/>A72 - Last market price known, in Currency (C).</p> |
|---------|---|

|            |  |
|------------|--|
| type       | <b>xs:decimal</b>  |
| properties | isRef 0<br>content simple  |
| annotation | documentation<br>A72 - Last market price known, in Currency (C). |

element **SIIPositionType\_V6/DerivativeOrConvertible/UnderlyingInstrument/Valuation/Country**

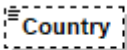
|            |   |
|------------|---|
| diagram    |  <p>A73 - Country of quotation</p> |
| type       | <a href="#">ISOCountryCodeType</a>  |
| properties | isRef 0<br>minOcc 0<br>maxOcc 1<br>content simple   |
| facets     | Kind Value annotation<br>minLength 2<br>maxLength 2   |
| annotation | documentation<br>A73 - Country of quotation   |

element **SIIPositionType\_V6/DerivativeOrConvertible/UnderlyingInstrument/Valuation/EconomicArea**

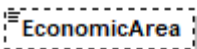
|            |   |
|------------|---|
| diagram    |  <p>A74 - Economic area code of<br/>Country of quotation:<br/>0 non listed<br/>1 EEA;<br/>2 OECD non EEA<br/>3 non OECD</p> |
| type       | <a href="#">EconomicAreaType</a>  |
| properties | isRef 0<br>minOcc 0<br>maxOcc 1<br>content simple   |
| facets     | Kind Value annotation<br>minInclusive 0<br>maxInclusive 3   |
| annotation | documentation<br>A74 - Economic area code of Country of quotation:<br>0 non listed<br>1 EEA;<br>2 OECD non EEA<br>3 non OECD  |

element **SIIPositionType\_V6/DerivativeOrConvertible/UnderlyingInstrument/Coupon**

|            |  |
|------------|--|
| diagram    |  |
| properties | <p>isRef 0<br/> minOcc 0<br/> maxOcc 1<br/> content complex</p>                    |
| children   | <p><a href="#">CouponRate</a> <a href="#">CouponFrequency</a></p>                  |
| annotation | <p>documentation<br/> If underlying instrument is an interest rate instrument.</p> |

element **SIIPositionType\_V6/DerivativeOrConvertible/UnderlyingInstrument/Coupon/CouponRate**

|            |   |
|------------|---|
| diagram    |   |
| type       | <p><a href="#">PercentageType</a></p>   |
| properties | <p>isRef 0<br/> content simple</p>  |
| annotation | <p>documentation<br/> A75 - Next coupon rate in percentage.<br/> 3.5% = 3.5</p> |

element **SIIPositionType\_V6/DerivativeOrConvertible/UnderlyingInstrument/Coupon/CouponFrequency**

|            |   |
|------------|---|
| diagram    |   |
| type       | <p><a href="#">SIICouponFrequencyType</a></p> |
| properties | <p>isRef 0<br/> content simple</p>            |

|            |   |
|------------|---|
| annotation | <p>documentation</p> <p>A76 - Coupon payment frequency as "number of coupon payment per year<br/> 0 = other than below options:<br/> 1= annual<br/> 2= biannual<br/> 4= quarterly<br/> 12= monthly<br/> 52= weekly"</p> |
|------------|---|

element **SIIPositionType\_V6/DerivativeOrConvertible/UnderlyingInstrument/Redemption**

|            |  |
|------------|--|
| diagram    | <p><b>Redemption</b><br/> A77 78 79 - Redemption details.<br/> If underlying instrument is an interest rate instrument.</p> <p><b>RedemptionType_V5</b></p> <ul style="list-style-type: none"> <li><b>MaturityDate</b><br/> Last redemption date<br/> 9999-12-31 for perpetual.<br/> Expiry date for options.</li> <li><b>Type</b><br/> Type of Redemption schedule:<br/> "Bullet", "Sinkable",<br/> "defaulted" empty if non applicable,<br/> Omitted if not applicable.</li> <li><b>Rate</b><br/> If known, redemption rate in percentage of nominal amount (A19)<br/> 100%=1.0</li> </ul> |
| type       | <a href="#">RedemptionType_V5</a>  |
| properties | isRef 0<br>minOcc 0<br>maxOcc 1<br>content complex   |
| children   | <a href="#">MaturityDate</a> <a href="#">Type</a> <a href="#">Rate</a>   |
| annotation | <p>documentation</p> <p>A77 78 79 - Redemption details.<br/> If underlying instrument is an interest rate instrument.</p>  |

element **SIIPositionType\_V6/DerivativeOrConvertible/UnderlyingInstrument/CreditRiskData**

|                   |   |
|-------------------|---|
| <p>diagram</p>    | <p>The diagram illustrates the structure of the <b>CreditRiskData</b> element. It is a complex type (indicated by a dashed box) that contains several child elements:</p> <ul style="list-style-type: none"> <li><b>InstrumentIssuer</b>: Identification of instrument issuer (or counterpart for OTC instruments).</li> <li><b>IssuerGroup</b>: Characteristics of final financial group the InstrumentIssuer belongs to (highest parent company). Duplicate InstrumentIssuer data if identical to InstrumentIssuer.</li> <li><b>IssuerCountry</b>: Country of instrument issuer: ISO country code 2 (ISO 3166-1) or "XA" for Supranational issuers or "EU" for European Union institutions.</li> <li><b>EconomicArea</b>: Economic area code of Country: 1 EEA, 2 OECD non EEA, 3 non OECD.</li> <li><b>StateGuarantee</b>: The instrument is guaranteed by the state of issuer ('Y') or not ('N').</li> <li><b>CreditQualityStep</b>: CQS: Synthetic issue or issuer rating. Integer from 0=AAA to 6=CCC, plus 9=unrated.</li> </ul> <p>The <b>CreditRiskData</b> element is described as: A80 to A89 - Issuer of underlying instrument (or counterparty for OTC instruments).</p> |
| <p>type</p>       | <p><a href="#">CreditRiskDataType_V5</a></p>  |
| <p>properties</p> | <p>isRef 0<br/>minOcc 0<br/>maxOcc 1<br/>content complex</p>  |
| <p>children</p>   | <p><a href="#">InstrumentIssuer</a> <a href="#">IssuerGroup</a> <a href="#">IssuerCountry</a> <a href="#">EconomicArea</a> <a href="#">StateGuarantee</a> <a href="#">CreditQualityStep</a></p>   |
| <p>annotation</p> | <p>documentation<br/>A80 to A89 - Issuer of underlying instrument (or counterparty for OTC instruments).</p>  |

element **SIIPositionType\_V6/DerivativeOrConvertible/MaturityDate**

|            |   |
|------------|---|
| diagram    |  <p><b>MaturityDate</b><br/>A 39 Expiry date for options.<br/>Maturity date for derivatives.</p> |
| type       | <b>xs:date</b>  |
| properties | <p>isRef 0<br/>minOcc 0<br/>maxOcc 1<br/>content simple</p>   |
| annotation | <p>documentation<br/>A 39 Expiry date for options. Maturity date for derivatives.</p>   |

element **SIIPositionType\_V6/Analytics**

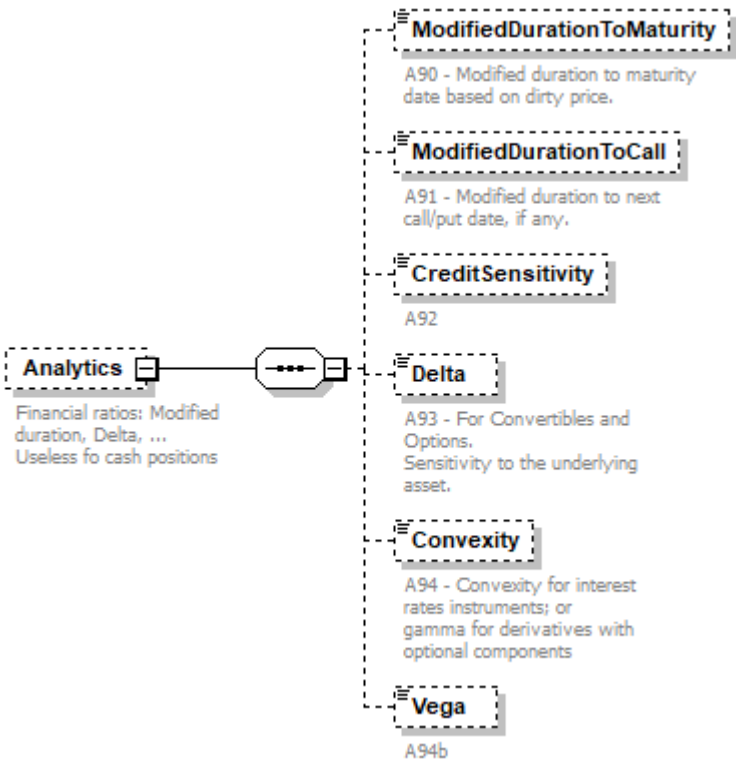
|            |  |
|------------|--|
| diagram    |  <p><b>Analytics</b><br/>Financial ratios: Modified duration, Delta, ...<br/>Useless fo cash positions</p> <p><b>ModifiedDurationToMaturity</b><br/>A90 - Modified duration to maturity date based on dirty price.</p> <p><b>ModifiedDurationToCall</b><br/>A91 - Modified duration to next call/put date, if any.</p> <p><b>CreditSensitivity</b><br/>A92</p> <p><b>Delta</b><br/>A93 - For Convertibles and Options.<br/>Sensitivity to the underlying asset.</p> <p><b>Convexity</b><br/>A94 - Convexity for interest rates instruments; or gamma for derivatives with optional components</p> <p><b>Vega</b><br/>A94b</p> |
| properties | <p>isRef 0<br/>minOcc 0<br/>maxOcc 1<br/>content complex</p>   |
| children   | <a href="#">ModifiedDurationToMaturity</a> <a href="#">ModifiedDurationToCall</a> <a href="#">CreditSensitivity</a> <a href="#">Delta</a> <a href="#">Convexity</a> <a href="#">Vega</a>   |
| annotation | <p>documentation<br/>Financial ratios: Modified duration, Delta, ...<br/>Useless fo cash positions</p>   |

element **SIIPositionType\_V6/Analytics/ModifiedDurationToMaturity**

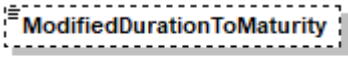
|            |   |
|------------|---|
| diagram    |  <p>A90 - Modified duration to maturity date based on dirty price.</p> |
| type       | <b>xs:decimal</b>   |
| properties | isRef 0<br>minOcc 0<br>maxOcc 1<br>content simple   |
| annotation | documentation<br>A90 - Modified duration to maturity date based on dirty price.   |

element **SIIPositionType\_V6/Analytics/ModifiedDurationToCall**

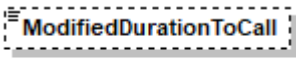
|            |   |
|------------|---|
| diagram    |  <p>A91 - Modified duration to next call/put date, if any.</p> |
| type       | <b>xs:decimal</b>   |
| properties | isRef 0<br>minOcc 0<br>maxOcc 1<br>content simple   |
| annotation | documentation<br>A91 - Modified duration to next call/put date, if any.   |

element **SIIPositionType\_V6/Analytics/CreditSensitivity**

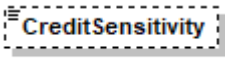
|            |  |
|------------|--|
| diagram    |  <p>A92</p> |
| type       | <b>xs:decimal</b>  |
| properties | isRef 0<br>minOcc 0<br>maxOcc 1<br>content simple  |
| annotation | documentation<br>A92   |

element **SIIPositionType\_V6/Analytics/Delta**

|            |   |
|------------|---|
| diagram    |  <p>A93 - For Convertibles and Options. Sensitivity to the underlying asset.</p> |
| type       | <b>xs:decimal</b>   |
| properties | isRef 0<br>minOcc 0<br>maxOcc 1<br>content simple   |
| annotation | documentation<br>A93 - For Convertibles and Options.  |

|  |                                      |
|--|--------------------------------------|
|  | Sensitivity to the underlying asset. |
|--|--------------------------------------|

element **SIIPositionType\_V6/Analytics/Convexity**

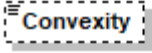
|            |  |
|------------|--|
| diagram    |  <p>A94 - Convexity for interest rates instruments; or gamma for derivatives with optional components</p> |
| type       | <b>xs:decimal</b>  |
| properties | isRef 0<br>minOcc 0<br>maxOcc 1<br>content simple  |
| annotation | documentation<br>A94 - Convexity for interest rates instruments; or gamma for derivatives with optional components   |

element **SIIPositionType\_V6/Analytics/Vega**

|            |   |
|------------|---|
| diagram    |  <p>A94b</p> |
| type       | <b>xs:decimal</b>   |
| properties | isRef 0<br>minOcc 0<br>maxOcc 1<br>content simple   |
| annotation | documentation<br>A94b   |

element **SIIPositionType\_V6/LookThroughIdentifier**

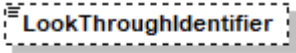
|            |  |
|------------|--|
| diagram    |  <p>A95 - identification code of the investee funds<br/>ISIN or CUSIP or any other identification</p> |
| type       | <b>ISINType</b>  |
| properties | isRef 0<br>minOcc 0<br>maxOcc 1<br>content simple  |
| facets     | Kind Value annotation<br>length 12<br>pattern [A-Z]{2}[A-Z0-9]{9}[0-9]{1}  |
| annotation | documentation<br>A95 - identification code of the investee funds<br>ISIN or CUSIP or any other identification  |



element **SIIPositionType\_V6/ContributionToSCR**

|                   |  |
|-------------------|--|
| <p>diagram</p>    | <p><b>ContributionToSCR</b></p> <p>Instrument level.<br/>The block is optional.<br/>However, if the block is present, all the SCRs inside can be present, with the non relevant ones set to 0.</p> <p><b>ContributionToSCRType</b></p> <ul style="list-style-type: none"> <li><b>MktIntUp</b><br/>A97 - Capital requirement for interest rate risk for the "up" shock.</li> <li><b>MktIntDown</b><br/>A98 - Capital requirement for interest rate risk for the "down" shock.</li> <li><b>MktEqGlobal</b><br/>A99 - Capital requirement for equity risk (EEA or OECD zone). Only MktEqGlobal or MktEqOther will be non zero.</li> <li><b>MktEqOther</b><br/>A100 - Capital requirement for equity risk (non OECD zone). Only MktEqGlobal or MktEqOther will be non zero.</li> <li><b>MktProp</b><br/>A101 - Capital requirement for property risk</li> <li><b>MktSpread</b> ⊕<br/>Capital requirement for interest rate spread risk.</li> <li><b>MktFXUp</b><br/>A105a - Capital requirement for FX (upward shock)</li> <li><b>MktFXDown</b><br/>A105b - Capital requirement for FX (downward shock)</li> </ul> |
| <p>type</p>       | <p><a href="#">ContributionToSCRType</a></p>   |
| <p>properties</p> | <p>isRef 0<br/>minOcc 0<br/>maxOcc 1<br/>content complex</p>   |
| <p>children</p>   | <p><a href="#">MktIntUp</a> <a href="#">MktIntDown</a> <a href="#">MktEqGlobal</a> <a href="#">MktEqOther</a> <a href="#">MktProp</a> <a href="#">MktSpread</a> <a href="#">MktFXUp</a> <a href="#">MktFXDown</a></p>  |
| <p>annotation</p> | <p>documentation<br/>Instrument level.<br/>The block is optional. However, if the block is present, all the SCRs inside can be present, with the non relevant ones set to 0.</p>   |

element **SIIPositionType\_V6/QRTPositionInformation**

diagram

**QRTPositionInformation**

Needed for segregated account.  
To be specified *if\*\*\*\*\**

**CollateralisedAsset**

A106 - Indicator used to identify the under-written instruments

**PlaceOfDeposit**

A107 - Instrument place of deposit

**Participation**

A108 - Indicator used to identify the guidelines of participation in accountancy terms  
1 - Participation  
2 - non participation

**ValorisationMethod**

A110 - Use closed list:  
1 - quoted market price in active markets for the same assets  
2 - quoted market price in active markets for similar assets  
3 - alternative valuation methods  
4 - adjusted equity methods (applicable for the valuation of participations)  
5 - IFRS equity methods (applicable for the valuation of participations)  
6 - Market valuation according to article 9(4) of Commission Delegated Regulation 2015/35

**AcquisitionValue**

A111 - Total acquisition value for assets held, clean value without accrued interest.  
Not applicable to CIC categories 7 and 8.

**CounterpartyRating**

**UnderlyingAssetCategory**

A131 - Identifies the assets categories, receivables and derivatives within the collective investment undertaking.  
Possible values are:  
1 - Government bonds  
2 - Corporate bonds  
3L - Listed equity  
3X - Unlisted equity  
4 - Collective Investment Undertakings  
5 - Structured notes  
6 - Collateralised securities  
7 - Cash and deposits  
8 - Mortgages and loans  
9 - Properties  
0 - Other investments (including receivables)  
A - Futures  
B - Call Options  
C - Put Options  
D - Swaps  
E - Forwards  
F - Credit derivatives  
L - Liabilities  
When the look-through regards a Fund of funds, category "4 - Collective Investment Units" shall be used only for non-material residual values.

|            |   |
|------------|---|
| properties | isRef 0<br>minOcc 0<br>maxOcc 1<br>content complex  |
| children   | <a href="#">CollateralisedAsset</a> <a href="#">PlaceOfDeposit</a> <a href="#">Participation</a> <a href="#">ValorisationMethod</a> <a href="#">AcquisitionValue</a> <a href="#">CounterpartyRating</a> <a href="#">UnderlyingAssetCategory</a> |
| annotation | documentation<br>Needed for segregated account.<br>To be specified*****   |

element **SIIPositionType\_V6/QRTPositionInformation/CollateralisedAsset**

|            |   |
|------------|---|
| diagram    |  |
| type       | restriction of <b>xs:unsignedInt</b>  |
| properties | isRef 0<br>minOcc 0<br>maxOcc 1<br>content simple                                 |
| annotation | documentation<br>A106 - Indicator used to identify the under-written instruments  |

element **SIIPositionType\_V6/QRTPositionInformation/PlaceOfDeposit**

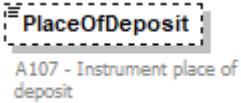
|            |   |
|------------|---|
| diagram    |  |
| type       | <b>xs:string</b>  |
| properties | isRef 0<br>minOcc 0<br>maxOcc 1<br>content simple                                   |
| annotation | documentation<br>A107 - Instrument place of deposit                                 |

element **SIIPositionType\_V6/QRTPositionInformation/Participation**

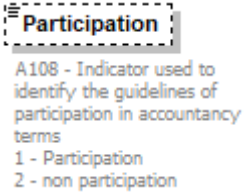
|            |   |
|------------|---|
| diagram    |  |
| type       | restriction of <b>xs:int</b>  |
| properties | isRef 0<br>minOcc 0<br>maxOcc 1<br>content simple                                   |
| facets     | Kind Value annotation<br>minInclusive 1<br>maxInclusive 2                           |

|            |   |
|------------|---|
| annotation | documentation<br>A108 - Indicator used to identify the guidelines of participation in accountancy terms<br>1 - Participation<br>2 - non participation |
|------------|---|

element **SIIPositionType\_V6/QRTPositionInformation/ValorisationMethod**

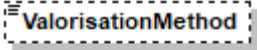
|            |   |
|------------|---|
| diagram    |  <p>A110 - Use closed list:<br/>1 - quoted market price in active markets for the same assets<br/>2 - quoted market price in active markets for similar assets<br/>3 - alternative valuation methods<br/>4 - adjusted equity methods (applicable for the valuation of participations)<br/>5 - IFRS equity methods (applicable for the valuation of participations)<br/>6 - Market valuation according to article 9(4) of Commission Delegated Regulation 2015/35</p> |
| type       | restriction of <b>xs:int</b>  |
| properties | isRef 0<br>minOcc 0<br>maxOcc 1<br>content simple   |
| facets     | Kind Value annotation<br>minInclusive 1<br>maxInclusive 6   |
| annotation | documentation<br>A110 - Use closed list:<br>1 - quoted market price in active markets for the same assets<br>2 - quoted market price in active markets for similar assets<br>3 - alternative valuation methods<br>4 - adjusted equity methods (applicable for the valuation of participations)<br>5 - IFRS equity methods (applicable for the valuation of participations)<br>6 - Market valuation according to article 9(4) of Commission Delegated Regulation 2015/35   |

element **SIIPositionType\_V6/QRTPositionInformation/AcquisitionValue**

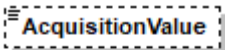
|            |  |
|------------|--|
| diagram    |  <p>A111 - Total acquisition value for assets held, clean value without accrued interest.<br/>Not applicable to CIC categories 7 and 8.</p> |
| type       | <b>xs:decimal</b>  |
| properties | isRef 0<br>minOcc 0<br>maxOcc 1<br>content simple  |
| annotation | documentation<br>A111 - Total acquisition value for assets held, clean value without accrued interest.<br>Not applicable to CIC categories 7 and 8.  |

element **SIIPositionType\_V6/QRTPositionInformation/CounterpartyRating**

|            |   |
|------------|---|
| diagram    | <p>The diagram shows a dashed box labeled 'CounterpartyRating' containing a complex structure. This structure branches into two elements: 'RatingValue' and 'RatingAgency'. 'RatingValue' is described as 'A112 - Rating of the counterparty / issuer (cf specifications QRT) (S.06.02 - old: Assets D1)'. 'RatingAgency' is described as 'A113 - Name of the rating agency (cf specification QRT) (S.06.02 - old: Assets D1)'.</p> |
| properties | <p>isRef 0<br/> minOcc 0<br/> maxOcc 1<br/> content complex</p>   |
| children   | <p><a href="#">RatingValue</a> <a href="#">RatingAgency</a></p>   |

element **SIIPositionType\_V6/QRTPositionInformation/CounterpartyRating/RatingValue**

|            |   |
|------------|---|
| diagram    | <p>The diagram shows a box labeled 'RatingValue' with the description: 'A112 - Rating of the counterparty / issuer (cf specifications QRT) (S.06.02 - old: Assets D1)'.</p> |
| type       | <p><b>xs:string</b></p>   |
| properties | <p>isRef 0<br/> content simple</p>  |
| annotation | <p>documentation<br/> A112 - Rating of the counterparty / issuer (cf specifications QRT) (S.06.02 - old: Assets D1)</p>   |

element **SIIPositionType\_V6/QRTPositionInformation/CounterpartyRating/RatingAgency**

|            |   |
|------------|---|
| diagram    | <p>The diagram shows a box labeled 'RatingAgency' with the description: 'A113 - Name of the rating agency (cf specification QRT) (S.06.02 - old: Assets D1)'.</p> |
| type       | <p><b>xs:string</b></p>   |
| properties | <p>isRef 0<br/> content simple</p>  |
| annotation | <p>documentation<br/> A113 - Name of the rating agency (cf specification QRT) (S.06.02 - old: Assets D1)</p>  |

element **SIIPositionType\_V6/QRTPositionInformation/UnderlyingAssetCategory**

|                   |   |
|-------------------|---|
| <p>diagram</p>    | <div style="border: 1px solid black; padding: 5px; margin-bottom: 10px;"> <p><b>UnderlyingAssetCategory</b></p> </div> <p>A131 - Identifies the assets categories, receivables and derivatives within the collective investment undertaking.<br/>Possible values are:<br/>1 - Government bonds<br/>2 - Corporate bonds<br/>3L - Listed equity<br/>3X - Unlisted equity<br/>4 - Collective Investment Undertakings<br/>5 - Structured notes<br/>6 - Collateralised securities<br/>7 - Cash and deposits<br/>8 - Mortgages and loans<br/>9 - Properties<br/>0 - Other investments (including receivables)<br/>A - Futures<br/>B - Call Options<br/>C - Put Options<br/>D - Swaps<br/>E - Forwards<br/>F - Credit derivatives<br/>L - Liabilities<br/>When the look-through regards a Fund of funds, category "4 - Collective Investment Units" shall be used only for non-material residual values.</p> |
| <p>type</p>       | <p>restriction of <b>xs:string</b></p>  |
| <p>properties</p> | <p>isRef 0<br/>content simple</p>   |
| <p>facets</p>     | <p>Kind Value annotation<br/>minLength 1<br/>maxLength 2</p>  |
| <p>annotation</p> | <p>documentation<br/>A131 - Identifies the assets categories, receivables and derivatives within the collective investment undertaking.<br/>Possible values are:<br/>1 - Government bonds<br/>2 - Corporate bonds<br/>3L - Listed equity<br/>3X - Unlisted equity<br/>4 - Collective Investment Undertakings<br/>5 - Structured notes<br/>6 - Collateralised securities<br/>7 - Cash and deposits<br/>8 - Mortgages and loans<br/>9 - Properties<br/>0 - Other investments (including receivables)<br/>A - Futures<br/>B - Call Options<br/>C - Put Options<br/>D - Swaps<br/>E - Forwards<br/>F - Credit derivatives<br/>L - Liabilities<br/>When the look-through regards a Fund of funds, category "4 - Collective Investment Units" shall be used only for non-material residual values.</p>  |

element **SIIPositionType\_V6/AdditionalInformation**

diagram

**AdditionalInformation**

**FundCustodianName**

A133

**InfrastructureInvestment**

A132 - Use closed list:  
0 - Not assessed  
1 - Debt on eligible Infrastructure project  
2 - Equity on eligible infrastructure project  
3 - Debt on eligible Infrastructure corporate  
4 - Equity on eligible infrastructure corporate  
5 - Non eligible

**Type1PrivateEquityPortfolioEligi...**

A134 - Use closed list:  
Int (1)  
0 = Not assessed  
1 = eligible for re-classification as equity type 1  
2 = not eligible for re-classification as equity type 1

**Type1PrivateEquityIssuerBeta**

A 135- Beta of the issuer of the private equity calculated according to art 168a of the regulation UE DR 2019/981

**Counterparty\_sector**

A137 - Classification of the issuer or counterparty according to IORP II regulation based on FINREP breakdown ( ESA 2010) and EIOPA specifications  
Alphanumeric (2)

**CollateralEligibility**

A138 - Eligibility of the collateral according to solvency regulation (RD UE 2015/35 art 176.5 and related art197, art214)

"0 - Not assessed or no collateral  
1 - Compliant with art 214 and art 197.1a and art 197 1b  
2 - Compliant with art 214 and art 197.1a  
3 - Compliant with art 214.  
4 - Not eligible"

**CollateralMarketValuationInPort...**

A139 - Market valuation of the collateral in portfolio currency number with floating decimal

|            |   |
|------------|---|
| properties | isRef 0<br>content complex  |
| children   | <a href="#">FundCustodianName</a> <a href="#">InfrastructureInvestment</a> <a href="#">Type1PrivateEquityPortfolioEligibility</a> <a href="#">Type1PrivateEquityIssuerBeta</a> <a href="#">Counterparty_sector</a> <a href="#">CollateralEligibility</a> <a href="#">CollateralMarketValuationInPortfolioCurrency</a> |

element **SIIPositionType\_V6/AdditionalInformation/FundCustodianName**

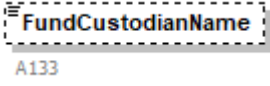
|            |   |
|------------|---|
| diagram    |  |
| type       | <b>xs:string</b>  |
| properties | isRef 0<br>minOcc 0<br>maxOcc 1<br>content simple                                 |
| annotation | documentation<br>A133   |

element **SIIPositionType\_V6/AdditionalInformation/InfrastructureInvestment**

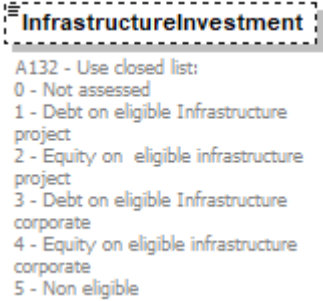
|            |  |
|------------|--|
| diagram    |    |
| type       | restriction of <b>xs:int</b>   |
| properties | isRef 0<br>minOcc 0<br>maxOcc 1<br>content simple  |
| facets     | Kind Value annotation<br>minInclusive 0<br>maxInclusive 5  |
| annotation | documentation<br>A132 - Use closed list:<br>0 - Not assessed<br>1 - Debt on eligible Infrastructure project<br>2 - Equity on eligible infrastructure project<br>3 - Debt on eligible Infrastructure corporate<br>4 - Equity on eligible infrastructure corporate<br>5 - Non eligible |

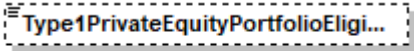

element **SIIPositionType\_V6/AdditionalInformation/Type1PrivateEquityPortfolioEligibility**

|            |  |
|------------|--|
| diagram    |  <p>A134 - Use closed list:<br/>Int (1)<br/>0 = Not assessed<br/>1= eligible for re-classification as equity type 1<br/>2 = not eligible for re-classification as equity type 1</p> |
| type       | restriction of <b>xs:int</b>   |
| properties | isRef 0<br>minOcc 0<br>maxOcc 1<br>content simple  |
| annotation | documentation<br>A134 - Use closed list:<br>Int (1)<br>0 = Not assessed<br>1= eligible for re-classification as equity type 1<br>2 = not eligible for re-classification as equity type 1   |

element **SIIPositionType\_V6/AdditionalInformation/Type1PrivateEquityIssuerBeta**

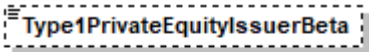
|            |  |
|------------|--|
| diagram    |  <p>A 135- Beta of the issuer of the private equity calculated according to art 168a of the regulation UE DR 2019/981</p> |
| type       | <b>xs:decimal</b>  |
| properties | isRef 0<br>minOcc 0<br>maxOcc 1<br>content simple  |
| annotation | documentation<br>A 135- Beta of the issuer of the private equity calculated according to art 168a of the regulation UE DR 2019/981   |

element **SIIPositionType\_V6/AdditionalInformation/Counterparty\_sector**

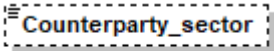
|            |  |
|------------|--|
| diagram    |  <p>A137 - Classification of the issuer or counterparty according to IORP II regulation based on FINREP breakdown ( ESA 2010) and EIOPA specifications<br/>Alphanumeric (2)</p> |
| type       | restriction of <b>xs:int</b>   |
| properties | isRef 0<br>minOcc 0<br>maxOcc 1<br>content simple  |
| facets     | Kind Value annotation<br>minInclusive 1  |

|            |   |
|------------|---|
|            | maxInclusive 13   |
| annotation | documentation<br>A137 - Classification of the issuer or counterparty according to IORP II regulation based on FINREP breakdown ( ESA 2010) and EIOPA specifications<br>Alphanumeric (2) |

element **SIIPositionType\_V6/AdditionalInformation/CollateralEligibility**

|            |   |
|------------|---|
| diagram    |  <b>CollateralEligibility</b><br>A138 - Eligibility of the collateral according to solvency regulation (RD UE 2015/35 art 176.5 and related art197, art214)<br><br>"0 - Not assessed or no collateral<br>1 - Compliant with art 214 and art 197.1a and art 197 1b<br>2 - Compliant with art 214 and art 197.1a<br>3 - Compliant with art 214.<br>4 - Not eligible" |
| type       | restriction of <b>xs:int</b>  |
| properties | isRef 0<br>minOcc 0<br>maxOcc 1<br>content simple   |
| facets     | Kind Value annotation<br>minInclusive 1<br>maxInclusive 13  |
| annotation | documentation<br>A138 - Eligibility of the collateral according to solvency regulation (RD UE 2015/35 art 176.5 and related art197, art214)<br><br>"0 - Not assessed or no collateral<br>1 - Compliant with art 214 and art 197.1a and art 197 1b<br>2 - Compliant with art 214 and art 197.1a<br>3 - Compliant with art 214.<br>4 - Not eligible"  |

element **SIIPositionType\_V6/AdditionalInformation/CollateralMarketValuationInPortfolioCurrency**

|            |  |
|------------|--|
| diagram    |  <b>CollateralMarketValuationInPort...</b><br>A139 - Market valuation of the collateral in portfolio currency<br>number with floating decimal |
| type       | <b>xs:decimal</b>  |
| properties | isRef 0<br>minOcc 0<br>maxOcc 1<br>content simple  |

|            |   |
|------------|---|
| annotation | documentation<br>A139 - Market valuation of the collateral in portfolio currency number with floating decimal |
|------------|---|

complexType **SIISecurityCodificationType**

|            |   |
|------------|---|
| diagram    | <p><b>SIISecurityCodificationType</b><br/>CodificationSystem (restricted list for Securities) and Code expressed in CodificationSystem</p> <p><b>CodificationSystem</b><br/>Codification system used. Integer corresponding to the following closed list:<br/>1 - ISO 6166 for ISIN code<br/>2 - CUSIP (The Committee on Uniform Securities Identification Procedures number assigned by the CUSIP Service Bureau for U.S. and Canadian companies)<br/>3 - SEDOL (Stock Exchange Daily Official List for the London Stock Exchange)<br/>4 - WKN (Wertpapier Kenn-Nummer, the alphanumeric German identification number)<br/>5 - Bloomberg Ticker (Bloomberg letters code that identify a company's securities)<br/>6 - BBGID (The Bloomberg Global ID)<br/>7 - Reuters RIC (Reuters instrument code)<br/>8 - FIGI (Financial Instrument Global Identifier)<br/>9 - Other code by members of the Association of National Numbering Agencies<br/>99 - Code attributed by the undertaking</p> <p><b>Code</b><br/>Value of code in CodificationSystem</p> |
| children   | <a href="#">CodificationSystem Code</a>   |
| used by    | elements <a href="#">SIISecurityCodificationType/InstrumentCode</a><br><a href="#">SIISecurityCodificationType/DerivativeOrConvertible/UnderlyingInstrument/InstrumentCode</a><br><a href="#">SIISecurityCodificationType/SolvencyIIPortfolioType/PortfolioID</a>   |
| annotation | documentation<br>CodificationSystem (restricted list for Securities) and Code expressed in CodificationSystem   |

element **SIISecurityCodificationType/CodificationSystem**

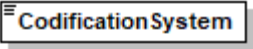
|            |   |
|------------|---|
| diagram    |  <p>Codification system used.<br/>Integer corresponding to the following closed list:<br/>1 - ISO 6166 for ISIN code<br/>2 - CUSIP (The Committee on Uniform Securities Identification Procedures number assigned by the CUSIP Service Bureau for U.S. and Canadian companies)<br/>3 - SEDOL (Stock Exchange Daily Official List for the London Stock Exchange)<br/>4 - WKN (Wertpapier Kenn-Nummer, the alphanumeric German identification number)<br/>5 - Bloomberg Ticker (Bloomberg letters code that identify a company's securities)<br/>6 - BBGID (The Bloomberg Global ID)<br/>7 - Reuters RIC (Reuters instrument code)<br/>8 - FIGI (Financial Instrument Global Identifier)<br/>9 - Other code by members of the Association of National Numbering Agencies<br/>99 - Code attributed by the undertaking</p> |
| type       | restriction of <b>xs:short</b>  |
| properties | isRef 0<br>content <b>simple</b>  |
| facets     | Kind Value annotation<br>minInclusive 1<br>maxInclusive 99  |
| annotation | documentation<br>Codification system used.<br>Integer corresponding to the following closed list:<br>1 - ISO 6166 for ISIN code<br>2 - CUSIP (The Committee on Uniform Securities Identification Procedures number assigned by the CUSIP Service Bureau for U.S. and Canadian companies)<br>3 - SEDOL (Stock Exchange Daily Official List for the London Stock Exchange)<br>4 - WKN (Wertpapier Kenn-Nummer, the alphanumeric German identification number)<br>5 - Bloomberg Ticker (Bloomberg letters code that identify a company's securities)<br>6 - BBGID (The Bloomberg Global ID)<br>7 - Reuters RIC (Reuters instrument code)<br>8 - FIGI (Financial Instrument Global Identifier)<br>9 - Other code by members of the Association of National Numbering Agencies<br>99 - Code attributed by the undertaking  |

element **SIISecurityCodificationType/Code**

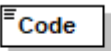
|         |  |
|---------|--|
| diagram |  <p>Value of code in CodificationSystem</p> |
| type    | <b>xs:string</b>   |

|            |  |
|------------|--|
| properties | isRef 0<br>content simple                            |
| annotation | documentation<br>Value of code in CodificationSystem |

complexType **SIISecurityCodificationType\_V5**

|            |  |
|------------|--|
| diagram    |  |
| children   | <a href="#">CodificationSystem</a> <a href="#">Code</a>  |
| used by    | elements <a href="#">SIISecurityType_V6/DerivativeOrConvertible/UnderlyingInstrument/InstrumentCode</a><br><a href="#">SIISecurityType_V5/InstrumentCode</a><br><a href="#">SIISecurityType_V5/DerivativeOrConvertible/UnderlyingInstrument/InstrumentCode</a><br><a href="#">SolvencyIIPortfolioType_V5/PortfolioID</a> |
| annotation | documentation<br>CodificationSystem (restricted list for Securities) and Code expressed in CodificationSystem  |

element **SIISecurityCodificationType\_V5/CodificationSystem**

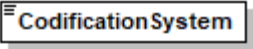
|            |   |
|------------|---|
| diagram    |  <p>Codification system used.<br/>Integer corresponding to the following closed list:<br/>1 - ISO 6166 for ISIN code<br/>2 - CUSIP (The Committee on Uniform Securities Identification Procedures number assigned by the CUSIP Service Bureau for U.S. and Canadian companies)<br/>3 - SEDOL (Stock Exchange Daily Official List for the London Stock Exchange)<br/>4 - WKN (Wertpapier Kenn-Nummer, the alphanumeric German identification number)<br/>5 - Bloomberg Ticker (Bloomberg letters code that identify a company's securities)<br/>6 - BBGID (The Bloomberg Global ID)<br/>7 - Reuters RIC (Reuters instrument code)<br/>8 - FIGI (Financial Instrument Global Identifier)<br/>9 - Other code by members of the Association of National Numbering Agencies<br/>99 - Code attributed by the undertaking</p> |
| type       | restriction of <b>xs:short</b>  |
| properties | isRef 0<br>content <b>simple</b>  |
| facets     | Kind Value annotation<br>minInclusive 1<br>maxInclusive 99  |
| annotation | documentation<br>Codification system used.<br>Integer corresponding to the following closed list:<br>1 - ISO 6166 for ISIN code<br>2 - CUSIP (The Committee on Uniform Securities Identification Procedures number assigned by the CUSIP Service Bureau for U.S. and Canadian companies)<br>3 - SEDOL (Stock Exchange Daily Official List for the London Stock Exchange)<br>4 - WKN (Wertpapier Kenn-Nummer, the alphanumeric German identification number)<br>5 - Bloomberg Ticker (Bloomberg letters code that identify a company's securities)<br>6 - BBGID (The Bloomberg Global ID)<br>7 - Reuters RIC (Reuters instrument code)<br>8 - FIGI (Financial Instrument Global Identifier)<br>9 - Other code by members of the Association of National Numbering Agencies<br>99 - Code attributed by the undertaking  |

element **SIISecurityCodificationType\_V5/Code**

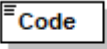
|         |  |
|---------|--|
| diagram |  <p>Value of code in CodificationSystem</p> |
| type    | <b>xs:string</b>   |

|            |  |
|------------|--|
| properties | isRef 0<br>content simple                            |
| annotation | documentation<br>Value of code in CodificationSystem |

complexType **SIISecurityCodificationType\_V6**

|            |  |
|------------|--|
| diagram    | <p><b>SIISecurityCodificationType_V6</b><br/>CodificationSystem (restricted list for Securities) and Code expressed in CodificationSystem</p> <p><b>CodificationSystem</b><br/>Codification system used. Integer corresponding to the following closed list:<br/>1 - ISO 6166 for ISIN code<br/>2 - CUSIP (The Committee on Uniform Securities Identification Procedures number assigned by the CUSIP Service Bureau for U.S. and Canadian companies)<br/>3 - SEDOL (Stock Exchange Daily Official List for the London Stock Exchange)<br/>4 - WKN (Wertpapier Kenn-Nummer, the alphanumeric German identification number)<br/>5 - Bloomberg Ticker (Bloomberg letters code that identify a company's securities)<br/>6 - BBGID (The Bloomberg Global ID)<br/>7 - Reuters RIC (Reuters instrument code)<br/>8 - FIGI (Financial Instrument Global Identifier)<br/>9 - Other code by members of the Association of National Numbering Agencies<br/>99 - Code attributed by the undertaking</p> <p><b>Code</b><br/>Value of code in CodificationSystem</p> |
| children   | <a href="#">CodificationSystem</a> <a href="#">Code</a>  |
| used by    | elements <a href="#">SIIPositionType_V6/InstrumentCode</a> <a href="#">SolvencyIIPortfolioType_V6/PortfolioID</a>  |
| annotation | documentation<br>CodificationSystem (restricted list for Securities) and Code expressed in CodificationSystem  |

element **SIISecurityCodificationType\_V6/CodificationSystem**

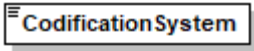
|            |   |
|------------|---|
| diagram    |  <p>Codification system used.<br/>Integer corresponding to the following closed list:<br/>1 - ISO 6166 for ISIN code<br/>2 - CUSIP (The Committee on Uniform Securities Identification Procedures number assigned by the CUSIP Service Bureau for U.S. and Canadian companies)<br/>3 - SEDOL (Stock Exchange Daily Official List for the London Stock Exchange)<br/>4 - WKN (Wertpapier Kenn-Nummer, the alphanumeric German identification number)<br/>5 - Bloomberg Ticker (Bloomberg letters code that identify a company's securities)<br/>6 - BBGID (The Bloomberg Global ID)<br/>7 - Reuters RIC (Reuters instrument code)<br/>8 - FIGI (Financial Instrument Global Identifier)<br/>9 - Other code by members of the Association of National Numbering Agencies<br/>99 - Code attributed by the undertaking</p> |
| type       | restriction of <b>xs:short</b>  |
| properties | isRef 0<br>content <b>simple</b>  |
| facets     | Kind Value annotation<br>minInclusive 1<br>maxInclusive 99  |
| annotation | documentation<br>Codification system used.<br>Integer corresponding to the following closed list:<br>1 - ISO 6166 for ISIN code<br>2 - CUSIP (The Committee on Uniform Securities Identification Procedures number assigned by the CUSIP Service Bureau for U.S. and Canadian companies)<br>3 - SEDOL (Stock Exchange Daily Official List for the London Stock Exchange)<br>4 - WKN (Wertpapier Kenn-Nummer, the alphanumeric German identification number)<br>5 - Bloomberg Ticker (Bloomberg letters code that identify a company's securities)<br>6 - BBGID (The Bloomberg Global ID)<br>7 - Reuters RIC (Reuters instrument code)<br>8 - FIGI (Financial Instrument Global Identifier)<br>9 - Other code by members of the Association of National Numbering Agencies<br>99 - Code attributed by the undertaking  |

element **SIISecurityCodificationType\_V6/Code**

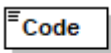
|         |  |
|---------|--|
| diagram |  <p>Value of code in CodificationSystem</p> |
| type    | <b>xs:string</b>   |



|            |  |
|------------|--|
| properties | isRef 0<br>content simple                            |
| annotation | documentation<br>Value of code in CodificationSystem |

# complexType SolvencyIIPortfolioType

diagram

**SolvencyIIPortfolioType**  
XML adaptation of "Tripartite Template"

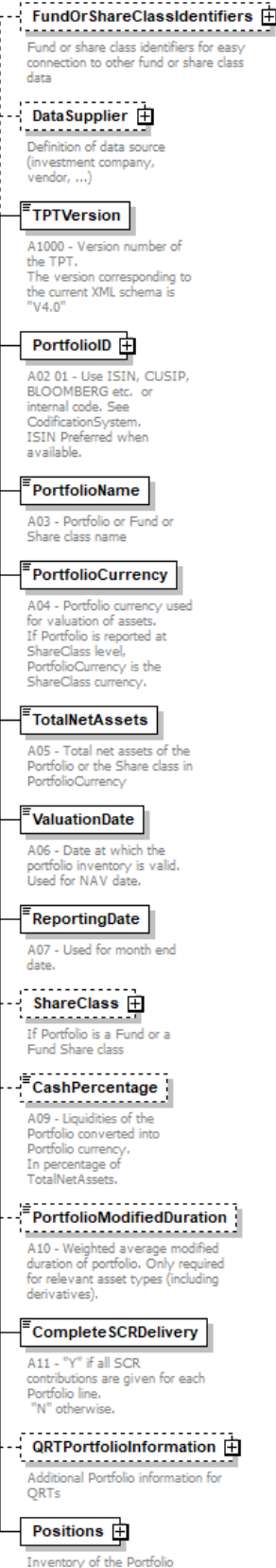

|            |  |
|------------|--|
| children   | <a href="#">FundOrShareClassIdentifiers</a> <a href="#">DataSupplier</a> <a href="#">TPTVersion</a> <a href="#">PortfolioID</a> <a href="#">PortfolioName</a> <a href="#">PortfolioCurrency</a> <a href="#">TotalNetAssets</a> <a href="#">ValuationDate</a> <a href="#">ReportingDate</a> <a href="#">ShareClass</a> <a href="#">CashPercentage</a> <a href="#">PortfolioModifiedDuration</a> <a href="#">CompleteSCRDelivery</a> <a href="#">QRTPortfolioInformation</a> <a href="#">Positions</a> |
| used by    | element <a href="#">TripartiteTemplateSolvencyIIType/Portfolio</a>   |
| annotation | documentation<br>XML adaptation of "Tripartite Template"   |

element **SolvencyIIPortfolioType/FundOrShareClassIdentifiers**

|            |  |
|------------|--|
| diagram    |  |
| type       | <a href="#">FundOrShareClassIdentifiersType</a>  |
| properties | isRef 0<br>minOcc 0<br>maxOcc 1<br>content complex   |
| children   | <a href="#">LEI</a> <a href="#">ISINs</a>  |
| annotation | documentation<br>Fund or share class identifiers for easy connection to other fund or share class data |

element **SolvencyIIPortfolioType/DataSupplier**

|         |  |
|---------|--|
| diagram |  |
|---------|--|

|            |   |
|------------|---|
| type       | <a href="#">DataSupplierType</a>  |
| properties | isRef 0<br>minOcc 0<br>maxOcc 1<br>content complex  |
| children   | <a href="#">SystemCountry</a> <a href="#">Short Name</a> <a href="#">Type</a> <a href="#">Contact</a> |
| annotation | documentation<br>Definition of data source (investment company, vendor, ...)                          |

element **SolvencyIIPortfolioType/TPTVersion**

|            |   |
|------------|---|
| diagram    |  <p>A1000 - Version number of the TPT.<br/>The version corresponding to the current XML schema is "V4.0"</p> |
| type       | restriction of <b>xs:string</b>   |
| properties | isRef 0<br>content simple<br>default V4.0   |
| annotation | documentation<br>A1000 - Version number of the TPT.<br>The version corresponding to the current XML schema is "V4.0"  |

element **SolvencyIIPortfolioType/PortfolioID**

|                   |  |
|-------------------|--|
| <p>diagram</p>    | <p><b>PortfolioID</b></p> <p>A02 01 - Use ISIN, CUSIP, BLOOMBERG etc. or internal code. See CodificationSystem. ISIN Preferred when available.</p> <p><b>SII SecurityCodificationType</b></p> <p><b>CodificationSystem</b></p> <p>Codification system used. Integer corresponding to the following closed list:<br/>     1 - ISO 6166 for ISIN code<br/>     2 - CUSIP (The Committee on Uniform Securities Identification Procedures number assigned by the CUSIP Service Bureau for U.S. and Canadian companies)<br/>     3 - SEDOL (Stock Exchange Daily Official List for the London Stock Exchange)<br/>     4 - WKN (Wertpapier Kenn-Nummer, the alphanumeric German identification number)<br/>     5 - Bloomberg Ticker (Bloomberg letters code that identify a company's securities)<br/>     6 - BBGID (The Bloomberg Global ID)<br/>     7 - Reuters RIC (Reuters instrument code)<br/>     8 - FIGI (Financial Instrument Global Identifier)<br/>     9 - Other code by members of the Association of National Numbering Agencies<br/>     99 - Code attributed by the undertaking</p> <p><b>Code</b></p> <p>Value of code in CodificationSystem</p> |
| <p>type</p>       | <p><a href="#">SII SecurityCodificationType</a></p>  |
| <p>properties</p> | <p>isRef 0<br/>content complex</p>   |
| <p>children</p>   | <p><a href="#">CodificationSystem</a> <a href="#">Code</a></p>   |
| <p>annotation</p> | <p>documentation<br/>A02 01 - Use ISIN, CUSIP, BLOOMBERG etc. or internal code. See CodificationSystem. ISIN Preferred when available.</p>   |

element **SolvencyIIPortfolioType/PortfolioName**

|                   |  |
|-------------------|--|
| <p>diagram</p>    | <p><b>PortfolioName</b></p> <p>A03 - Portfolio or Fund or Share class name</p> |
| <p>type</p>       | <p><b>xs:string</b></p>  |
| <p>properties</p> | <p>isRef 0<br/>content simple</p>  |
| <p>annotation</p> | <p>documentation<br/>A03 - Portfolio or Fund or Share class name</p>           |

element **SolvencyIIPortfolioType/PortfolioCurrency**

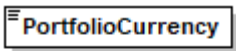
|            |   |
|------------|---|
| diagram    |  <p>A04 - Portfolio currency used for valuation of assets.<br/>If Portfolio is reported at ShareClass level, PortfolioCurrency is the ShareClass currency.</p> |
| type       | <a href="#">ISOCurrencyCodeType</a>   |
| properties | isRef 0<br>content simple   |
| facets     | Kind Value annotation<br>minLength 3<br>maxLength 3<br>pattern [A-Z]{3}   |
| annotation | documentation<br>A04 - Portfolio currency used for valuation of assets.<br>If Portfolio is reported at ShareClass level, PortfolioCurrency is the ShareClass currency.  |

element **SolvencyIIPortfolioType/TotalNetAssets**

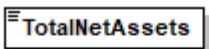
|            |  |
|------------|--|
| diagram    |  <p>A05 - Total net assets of the Portfolio or the Share class in PortfolioCurrency</p> |
| type       | <b>xs:decimal</b>  |
| properties | isRef 0<br>content simple  |
| annotation | documentation<br>A05 - Total net assets of the Portfolio or the Share class in PortfolioCurrency   |

element **SolvencyIIPortfolioType/ValuationDate**

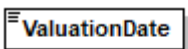
|            |   |
|------------|---|
| diagram    |  <p>A06 - Date at which the portfolio inventory is valid.<br/>Used for NAV date.</p> |
| type       | <b>xs:date</b>  |
| properties | isRef 0<br>content simple   |
| annotation | documentation<br>A06 - Date at which the portfolio inventory is valid.<br>Used for NAV date.  |

element **SolvencyIIPortfolioType/ReportingDate**

|            |   |
|------------|---|
| diagram    |  <p>A07 - Used for month end date.</p> |
| type       | <b>xs:date</b>  |
| properties | isRef 0<br>content simple   |
| annotation | documentation<br>A07 - Used for month end date.   |

element **SolvencyIIPortfolioType/ShareClass**

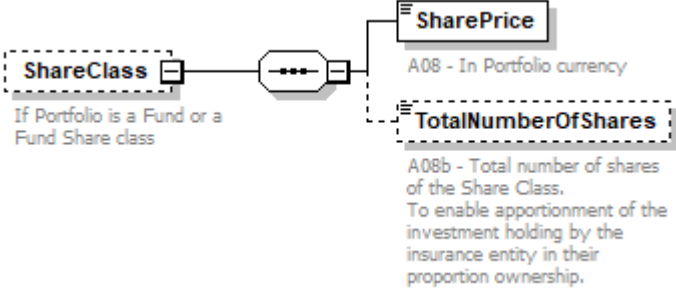
|            |   |
|------------|---|
| diagram    |  <p>If Portfolio is a Fund or a Fund Share class</p> |
| properties | isRef 0<br>minOcc 0<br>maxOcc 1<br>content complex  |
| children   | <a href="#">SharePrice</a> <a href="#">TotalNumberOfShares</a>  |
| annotation | documentation<br>If Portfolio is a Fund or a Fund Share class   |

element **SolvencyIIPortfolioType/ShareClass/SharePrice**

|            |  |
|------------|--|
| diagram    |  <p>A08 - In Portfolio currency</p> |
| type       | <b>xs:decimal</b>  |
| properties | isRef 0<br>content simple  |
| annotation | documentation<br>A08 - In Portfolio currency   |

element **SolvencyIIPortfolioType/ShareClass/TotalNumberOfShares**

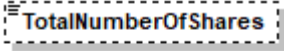
|         |   |
|---------|---|
| diagram |  <p>A08b - Total number of shares of the Share Class.<br/>To enable apportionment of the investment holding by the insurance entity in their proportion ownership.</p> |
| type    | <b>xs:decimal</b>   |

|            |  |
|------------|--|
| properties | isRef 0<br>minOcc 0<br>maxOcc 1<br>content simple  |
| annotation | documentation<br>A08b - Total number of shares of the Share Class.<br>To enable apportionment of the investment holding by the insurance entity in their proportion ownership. |

element **SolvencyIIPortfolioType/CashPercentage**

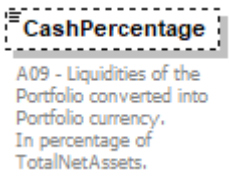
|            |  |
|------------|--|
| diagram    |   |
| type       | <b>xs:decimal</b>  |
| properties | isRef 0<br>minOcc 0<br>maxOcc 1<br>content simple  |
| annotation | documentation<br>A09 - Liquidities of the Portfolio converted into Portfolio currency.<br>In percentage of TotalNetAssets. |

element **SolvencyIIPortfolioType/PortfolioModifiedDuration**

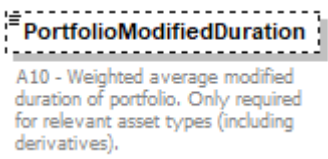
|            |   |
|------------|---|
| diagram    |    |
| type       | <b>xs:decimal</b>   |
| properties | isRef 0<br>minOcc 0<br>maxOcc 1<br>content simple   |
| annotation | documentation<br>A10 - Weighted average modified duration of portfolio. Only required for relevant asset types (including derivatives). |

element **SolvencyIIPortfolioType/CompleteSCRDelivery**

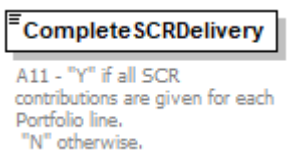
|            |  |
|------------|--|
| diagram    |     |
| type       | <a href="#">YesNoL1Type</a>  |
| properties | isRef 0<br>content simple  |
| facets     | Kind Value annotation<br>minLength 1<br>maxLength 1                                    |
| annotation | documentation<br>A11 - "Y" if all SCR contributions are given for each Portfolio line. |



"N" otherwise.

element **SolvencyIIPortfolioType/QRTPortfolioInformation**

|                   |   |
|-------------------|---|
| <p>diagram</p>    | <p><b>QRTPortfolioInformation</b><br/>Additional Portfolio information for QRTs</p> <ul style="list-style-type: none"> <li><b>FundIssuer</b> (+)<br/>A117-116-115 - Name and Code of Fund Issuer</li> <li><b>FundIssuerGroup</b> (+)<br/>A121-120-119 - Name, LEI or Pre LEI of the Group the Fund issuer belongs to.</li> <li><b>FundCIC</b><br/>A123</li> <li><b>FundCustodianCountry</b><br/>A123a</li> <li><b>PortfolioModifiedDuration</b><br/>A124 - Difference with A10?</li> <li><b>IssuerEconomicArea</b><br/>A114<br/>1=EEA<br/>2=OECD non EEA<br/>3=RoW</li> </ul> |
| <p>properties</p> | <p>isRef 0<br/>minOcc 0<br/>maxOcc 1<br/>content complex</p>  |
| <p>children</p>   | <p><a href="#">FundIssuer</a> <a href="#">FundIssuerGroup</a> <a href="#">FundCIC</a> <a href="#">FundCustodianCountry</a> <a href="#">PortfolioModifiedDuration</a> <a href="#">IssuerEconomicArea</a></p>   |
| <p>annotation</p> | <p>documentation<br/>Additional Portfolio information for QRTs</p>  |

element **SolvencyIIPortfolioType/QRTPortfoliInformation/FundIssuer**

|            |   |
|------------|---|
| diagram    |   |
| type       | extension of <a href="#">SIIIssuerType</a>  |
| properties | isRef 0<br>content complex  |
| children   | <a href="#">Name</a> <a href="#">Code</a> <a href="#">CodeType</a> <a href="#">EconomicSector</a> <a href="#">Country</a> |
| annotation | documentation<br>A117-116-115 - Name and Code of Fund Issuer  |

element **SolvencyIIPortfolioType/QRTPortfoliInformation/FundIssuer/EconomicSector**

|            |   |
|------------|---|
| diagram    |   |
| type       | <a href="#">NACECodeType</a>  |
| properties | isRef 0<br>content simple   |
| facets     | Kind Value annotation<br>minLength 1<br>maxLength 7<br>pattern ([A-Z]{1}[0-9\.\.]{0,6}) |
| annotation | documentation<br>A118 - NACE code of Issuer of Fund or Share Class                      |

element **SolvencyIIPortfolioType/QRTPortfoliInformation/FundIssuer/Country**

|            |                                    |
|------------|------------------------------------|
| diagram    |                                    |
| type       | <a href="#">ISOCountryCodeType</a> |
| properties | isRef 0<br>content simple          |
| facets     | Kind Value annotation              |

|            |                            |
|------------|----------------------------|
|            | minLength 2<br>maxLength 2 |
| annotation | documentation<br>A122      |

element **SolvencyIIPortfolioType/QRTPortfolioInformation/FundIssuerGroup**

|            |   |
|------------|---|
| diagram    |   |
| type       | <a href="#">SIIIssuerType</a>   |
| properties | isRef 0<br>content complex  |
| children   | <a href="#">Name</a> <a href="#">Code</a> <a href="#">CodeType</a>                            |
| annotation | documentation<br>A121-120-119 - Name, LEI or Pre LEI of the Group the Fund issuer belongs to. |

element **SolvencyIIPortfolioType/QRTPortfolioInformation/FundCIC**

|            |  |
|------------|--|
| diagram    |  |
| type       | <a href="#">CICCodeType</a>  |
| properties | isRef 0<br>content simple  |
| facets     | Kind Value annotation<br>minLength 4<br>maxLength 4<br>pattern $([A-Z]{2}([A-F][0-9]){1}[1-9]{1})$ |
| annotation | documentation<br>A123  |

element **SolvencyIIPortfolioType/QRTPortfolioInformation/FundCustodianCountry**

|            |                                      |
|------------|--------------------------------------|
| diagram    |                                      |
| type       | <a href="#">ISOCountryCodeType</a>   |
| properties | isRef 0<br>content simple            |
| facets     | Kind Value annotation<br>minLength 2 |

|            |                        |
|------------|------------------------|
|            | maxLength 2            |
| annotation | documentation<br>A123a |

element **SolvencyIIPortfolioType/QRTPortfolioInformation/PortfolioModifiedDuration**

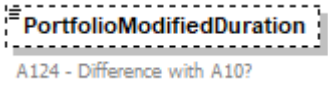
|            |   |
|------------|---|
| diagram    |  <p><b>PortfolioModifiedDuration</b><br/>A124 - Difference with A10?</p> |
| type       | <b>xs:decimal</b>   |
| properties | isRef 0<br>minOcc 0<br>maxOcc 1<br>content simple   |
| annotation | documentation<br>A124 - Difference with A10?  |

element **SolvencyIIPortfolioType/QRTPortfolioInformation/IssuerEconomicArea**

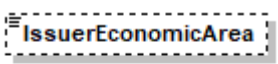
|            |  |
|------------|--|
| diagram    |  <p><b>IssuerEconomicArea</b><br/>A114<br/>1=EEA<br/>2=OECD non EEA<br/>3=RoW</p> |
| type       | <a href="#">EconomicArea2Type</a>  |
| properties | isRef 0<br>minOcc 0<br>maxOcc 1<br>content simple  |
| facets     | Kind Value annotation<br>minInclusive 1<br>maxInclusive 3  |
| annotation | documentation<br>A114<br>1=EEA<br>2=OECD non EEA<br>3=RoW  |

element **SolvencyIIPortfolioType/Positions**

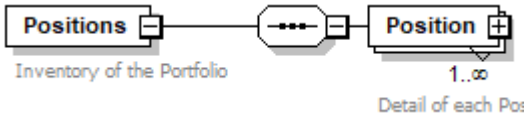
|            |   |
|------------|---|
| diagram    |  <p><b>Positions</b> Inventory of the Portfolio</p> <p><b>Position</b> 1..∞ Detail of each Position.</p> |
| properties | isRef 0<br>content complex  |
| children   | <a href="#">Position</a>  |
| annotation | documentation<br>Inventory of the Portfolio   |

# element SolvencyIIPortfolioType/Positions/Position

diagram

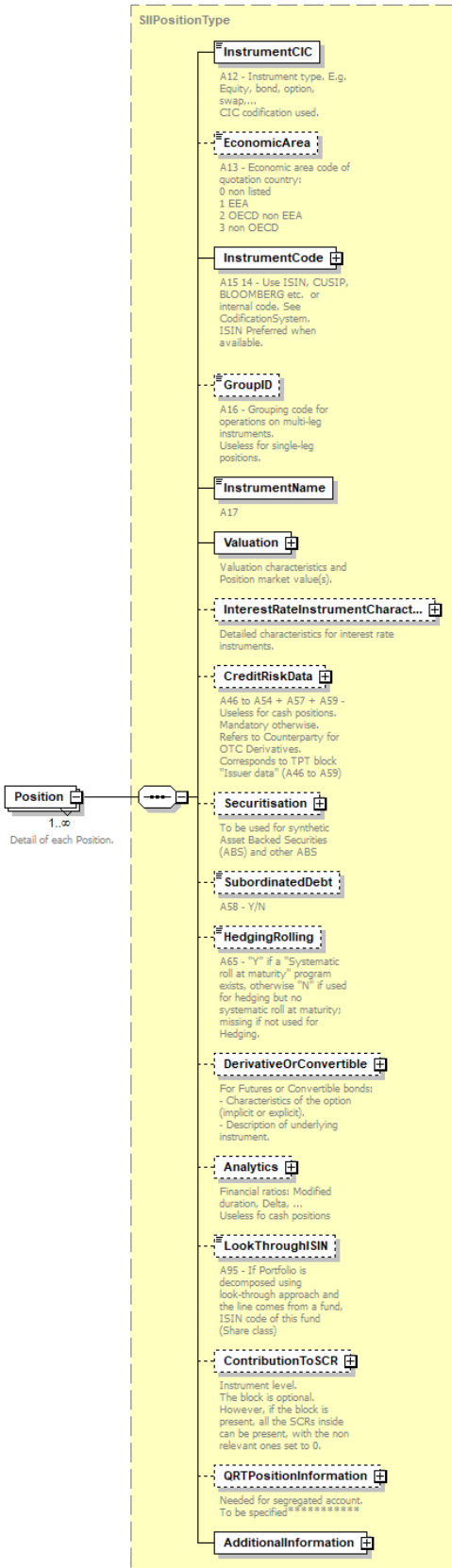

|            |  |
|------------|--|
| type       | <a href="#">SIIPositionType</a>  |
| properties | isRef 0<br>minOcc 1<br>maxOcc unbounded<br>content complex   |
| children   | <a href="#">InstrumentCIC</a> <a href="#">EconomicArea</a> <a href="#">InstrumentCode</a> <a href="#">GroupID</a> <a href="#">InstrumentName</a> <a href="#">Valuation</a><br><a href="#">InterestRateInstrumentCharacteristics</a> <a href="#">CreditRiskData</a> <a href="#">Securitisation</a> <a href="#">SubordinatedDebt</a> <a href="#">HedgingRolling</a><br><a href="#">DerivativeOrConvertible</a> <a href="#">Analytics</a> <a href="#">LookThroughISIN</a> <a href="#">ContributionToSCR</a> <a href="#">QRTPositionInformation</a><br><a href="#">AdditionalInformation</a> |
| annotation | documentation<br>Detail of each Position.  |

# complexType SolvencyIIPortfolioType\_V5

diagram

SolvencyIIPortfolioType\_V5

XML adaptation of "Tripartite Template"

## FundOrShareClassIdentifiers

Fund or share class identifiers for easy connection to other fund or share class data

## DataSupplier

Definition of data source (investment company, vendor, ...)

## TPTVersion

A1000 - Version number of the TPT. The version corresponding to the current XML schema is "V5.0"

## PortfolioID

A02 01 - Use ISIN, CUSIP, BLOOMBERG etc. or internal code. See CodificationSystem. ISIN Preferred when available.

## PortfolioName

A03 - Portfolio or Fund or Share class name

## PortfolioCurrency

A04 - Portfolio currency used for valuation of assets. If Portfolio is reported at ShareClass level, PortfolioCurrency is the ShareClass currency. Code  
ISO 4217  
CNH : 2 Chinese yuan (when traded offshore)  
- Hong Kong  
CNT: Chinese yuan (when traded offshore) -Taiwan  
GGP - Guernsey pound - Guernsey  
IMP: Isle of Man pound also Manx pound -Isle of Man  
JEP: Jersey pound - Jersey  
KID: Kiribati dollar -Kiribati  
NIS - New Israeli Shekel - Israel  
PRB - Transnistrian ruble - Transnistria (The code conflicts with ISO-4217 because PR stands for Puerto Rico, X should have been used for the first letter,)  
TVD - Tuvalu dollar- Tuvalu

## TotalNetAssets

A05 - Total net assets of the Portfolio or the Share class in PortfolioCurrency

## ValuationDate

A06 - Date at which the portfolio inventory is valid. Used for NAV data.

## ReportingDate

A07 - Date to which data refers ( end of month for example)

## ShareClass

A 06, A 06b

## CashPercentage

A09 - Liquidities of the Portfolio converted into Portfolio currency. In percentage of TotalNetAssets.

## PortfolioModifiedDuration

A10 - Weighted average modified duration of portfolio. Only required for relevant asset types (including derivatives).

## CompleteSCRDelivery

A11 - "Y" if all SCR contributions are given for each Portfolio line. "N" otherwise.

## QRTPortfolioInformation

Additional Portfolio information for QRTs

## Positions

Inventory of the Portfolio

|            |  |
|------------|--|
| children   | <a href="#">FundOrShareClassIdentifiers</a> <a href="#">DataSupplier</a> <a href="#">TPTVersion</a> <a href="#">PortfolioID</a> <a href="#">PortfolioName</a> <a href="#">PortfolioCurrency</a> <a href="#">TotalNetAssets</a> <a href="#">ValuationDate</a> <a href="#">ReportingDate</a> <a href="#">ShareClass</a> <a href="#">CashPercentage</a> <a href="#">PortfolioModifiedDuration</a> <a href="#">CompleteSCRDelivery</a> <a href="#">QRTPortfolioInformation</a> <a href="#">Positions</a> |
| used by    | element <a href="#">TripartiteTemplateSolvencyIIType_V5/Portfolio</a>  |
| annotation | documentation<br>XML adaptation of "Tripartite Template"   |

element **SolvencyIIPortfolioType\_V5/FundOrShareClassIdentifiers**

|            |  |
|------------|--|
| diagram    |  |
| type       | <a href="#">FundOrShareClassIdentifiersType</a>  |
| properties | isRef 0<br>minOcc 0<br>maxOcc 1<br>content complex   |
| children   | <a href="#">LEI</a> <a href="#">ISINs</a>  |
| annotation | documentation<br>Fund or share class identifiers for easy connection to other fund or share class data |

element **SolvencyIIPortfolioType\_V5/DataSupplier**

|         |  |
|---------|--|
| diagram |  |
|---------|--|



|            |   |
|------------|---|
| type       | <a href="#">DataSupplierType</a>  |
| properties | isRef 0<br>minOcc 0<br>maxOcc 1<br>content complex  |
| children   | <a href="#">SystemCountry</a> <a href="#">Short Name</a> <a href="#">Type</a> <a href="#">Contact</a> |
| annotation | documentation<br>Definition of data source (investment company, vendor, ...)                          |

element **SolvencyIIPortfolioType\_V5/TPTVersion**

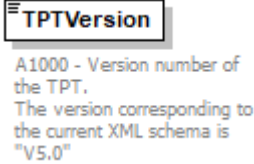
|            |  |
|------------|--|
| diagram    |                                     |
| type       | restriction of <b>xs:string</b>  |
| properties | isRef 0<br>content simple<br>default V5.0  |
| annotation | documentation<br>A1000 - Version number of the TPT.<br>The version corresponding to the current XML schema is "V5.0" |

element **SolvencyIIPortfolioType\_V5/PortfolioID**

|                   |   |
|-------------------|---|
| <p>diagram</p>    | <p><b>PortfolioID</b></p> <p>A02 01 - Use ISIN, CUSIP, BLOOMBERG etc. or internal code. See CodificationSystem. ISIN Preferred when available.</p> <p><b>SII Security Codification Type V5</b></p> <p><b>CodificationSystem</b></p> <p>Codification system used. Integer corresponding to the following closed list:<br/> 1 - ISO 6166 for ISIN code<br/> 2 - CUSIP (The Committee on Uniform Securities Identification Procedures number assigned by the CUSIP Service Bureau for U.S. and Canadian companies)<br/> 3 - SEDOL (Stock Exchange Daily Official List for the London Stock Exchange)<br/> 4 - WKN (Wertpapier Kenn-Nummer, the alphanumeric German identification number)<br/> 5 - Bloomberg Ticker (Bloomberg letters code that identify a company's securities)<br/> 6 - BBGID (The Bloomberg Global ID)<br/> 7 - Reuters RIC (Reuters instrument code)<br/> 8 - FIGI (Financial Instrument Global Identifier)<br/> 9 - Other code by members of the Association of National Numbering Agencies<br/> 99 - Code attributed by the undertaking</p> <p><b>Code</b></p> <p>Value of code in CodificationSystem</p> |
| <p>type</p>       | <p><a href="#">SII Security Codification Type V5</a></p>  |
| <p>properties</p> | <p>isRef 0<br/>content complex</p>  |
| <p>children</p>   | <p><a href="#">CodificationSystem</a> <a href="#">Code</a></p>  |
| <p>annotation</p> | <p>documentation<br/>A02 01 - Use ISIN, CUSIP, BLOOMBERG etc. or internal code. See CodificationSystem. ISIN Preferred when available.</p>  |

element **SolvencyIIPortfolioType\_V5/PortfolioName**

|                   |  |
|-------------------|--|
| <p>diagram</p>    | <p><b>PortfolioName</b></p> <p>A03 - Portfolio or Fund or Share class name</p> |
| <p>type</p>       | <p><b>xs:string</b></p>  |
| <p>properties</p> | <p>isRef 0<br/>content simple</p>  |
| <p>annotation</p> | <p>documentation<br/>A03 - Portfolio or Fund or Share class name</p>           |

element **SolvencyIIPortfolioType\_V5/PortfolioCurrency**

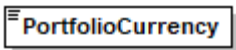
|                   |  |
|-------------------|--|
| <p>diagram</p>    |  <p>A04 - Portfolio currency used for valuation of assets.<br/>If Portfolio is reported at ShareClass level, PortfolioCurrency is the ShareClass currency.</p> <p>Code</p> <p>ISO 4217</p> <p>CNH : 2 Chinese yuan (when traded offshore) - Hong Kong</p> <p>CNT: Chinese yuan (when traded offshore) -Taiwan</p> <p>GGP – Guernsey pound - Guernsey</p> <p>IMP: Isle of Man pound also Manx pound -Isle of Man</p> <p>JEP: Jersey pound - Jersey</p> <p>KID: Kiribati dollar -Kiribati</p> <p>NIS – New Israeli Shekel - Israel</p> <p>PRB – Transnistrian ruble - Transnistria (The code conflicts with ISO-4217 because PR stands for Puerto Rico. X should have been used for the first letter.)</p> <p>TVD – Tuvalu dollar- Tuvalu</p> |
| <p>type</p>       | <p><a href="#">ISOCurrencyCodeType</a></p>   |
| <p>properties</p> | <p>isRef 0</p> <p>content simple</p>   |
| <p>facets</p>     | <p>Kind Value annotation</p> <p>minLength 3</p> <p>maxLength 3</p> <p>pattern [A-Z]{3}</p>   |
| <p>annotation</p> | <p>documentation</p> <p>A04 - Portfolio currency used for valuation of assets.<br/>If Portfolio is reported at ShareClass level, PortfolioCurrency is the ShareClass currency.</p> <p>Code ISO 4217 CNH : 2 Chinese yuan (when traded offshore) - Hong Kong</p> <p>CNT: Chinese yuan (when traded offshore) -Taiwan</p> <p>GGP – Guernsey pound - Guernsey</p> <p>IMP: Isle of Man pound also Manx pound -Isle of Man</p> <p>JEP: Jersey pound - Jersey</p> <p>KID: Kiribati dollar -Kiribati</p> <p>NIS – New Israeli Shekel - Israel</p> <p>PRB – Transnistrian ruble - Transnistria (The code conflicts with ISO-4217 because PR stands for Puerto Rico. X should have been used for the first letter.)</p> <p>TVD – Tuvalu dollar- Tuvalu</p>  |

element **SolvencyIIPortfolioType\_V5/TotalNetAssets**

|                |  |
|----------------|--|
| <p>diagram</p> |  <p>A05 - Total net assets of the Portfolio or the Share class in PortfolioCurrency</p> |
| <p>type</p>    | <p><b>xs:decimal</b></p>   |

|            |  |
|------------|--|
| properties | isRef 0<br>content simple  |
| annotation | documentation<br>A05 - Total net assets of the Portfolio or the Share class in PortfolioCurrency |

element **SolvencyIIPortfolioType\_V5/ValuationDate**

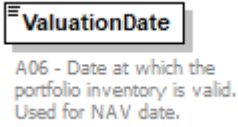
|            |   |
|------------|---|
| diagram    |          |
| type       | <b>xs:date</b>  |
| properties | isRef 0<br>content simple   |
| annotation | documentation<br>A06 - Date at which the portfolio inventory is valid. Used for NAV date. |

element **SolvencyIIPortfolioType\_V5/ReportingDate**

|            |   |
|------------|---|
| diagram    |  |
| type       | <b>xs:date</b>  |
| properties | isRef 0<br>content simple   |
| annotation | documentation<br>A07 - Date to which data refers ( end of month for example)      |

element **SolvencyIIPortfolioType\_V5/ShareClass**

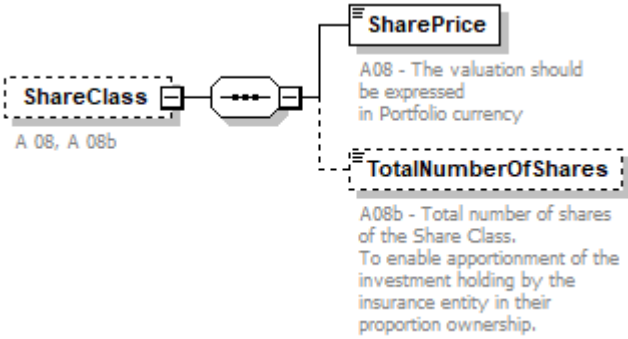
|            |   |
|------------|---|
| diagram    |  |
| properties | isRef 0<br>minOcc 0<br>maxOcc 1<br>content complex                                  |
| children   | <a href="#">SharePrice</a> <a href="#">TotalNumberOfShares</a>                      |
| annotation | documentation<br>A 08, A 08b  |

element **SolvencyIIPortfolioType\_V5/ShareClass/SharePrice**

|            |  |
|------------|--|
| diagram    |  <p>A08 - The valuation should be expressed in Portfolio currency</p> |
| type       | <b>xs:decimal</b>  |
| properties | isRef 0<br>content simple  |
| annotation | documentation<br>A08 - The valuation should be expressed in Portfolio currency   |

element **SolvencyIIPortfolioType\_V5/ShareClass/TotalNumberOfShares**

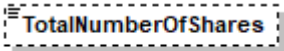
|            |   |
|------------|---|
| diagram    |  <p>A08b - Total number of shares of the Share Class.<br/>To enable apportionment of the investment holding by the insurance entity in their proportion ownership.</p> |
| type       | <b>xs:decimal</b>   |
| properties | isRef 0<br>minOcc 0<br>maxOcc 1<br>content simple   |
| annotation | documentation<br>A08b - Total number of shares of the Share Class.<br>To enable apportionment of the investment holding by the insurance entity in their proportion ownership.  |

element **SolvencyIIPortfolioType\_V5/CashPercentage**

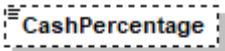
|            |   |
|------------|---|
| diagram    |  <p>A09 - Liquidities of the Portfolio converted into Portfolio currency.<br/>In percentage of TotalNetAssets.</p> |
| type       | <b>xs:decimal</b>   |
| properties | isRef 0<br>minOcc 0<br>maxOcc 1<br>content simple   |
| annotation | documentation<br>A09 - Liquidities of the Portfolio converted into Portfolio currency.<br>In percentage of TotalNetAssets.  |

element **SolvencyIIPortfolioType\_V5/PortfolioModifiedDuration**

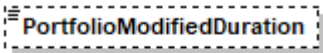
|            |   |
|------------|---|
| diagram    |  <p><b>PortfolioModifiedDuration</b></p> <p>A10 - Weighted average modified duration of portfolio. Only required for relevant asset types (including derivatives).</p> |
| type       | <b>xs:decimal</b>   |
| properties | <p>isRef 0</p> <p>minOcc 0</p> <p>maxOcc 1</p> <p>content simple</p>  |
| annotation | <p>documentation</p> <p>A10 - Weighted average modified duration of portfolio. Only required for relevant asset types (including derivatives).</p>  |

element **SolvencyIIPortfolioType\_V5/CompleteSCRDelivery**

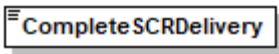
| diagram    |  <p><b>CompleteSCRDelivery</b></p> <p>A11 - "Y" if all SCR contributions are given for each Portfolio line. "N" otherwise.</p>                 |            |       |            |           |   |  |           |   |  |
|------------|---|------------|-------|------------|-----------|---|--|-----------|---|--|
| type       | <b>YesNoL1Type</b>  |            |       |            |           |   |  |           |   |  |
| properties | <p>isRef 0</p> <p>content simple</p>  |            |       |            |           |   |  |           |   |  |
| facets     | <table border="1"> <thead> <tr> <th>Kind</th> <th>Value</th> <th>annotation</th> </tr> </thead> <tbody> <tr> <td>minLength</td> <td>1</td> <td></td> </tr> <tr> <td>maxLength</td> <td>1</td> <td></td> </tr> </tbody> </table> | Kind       | Value | annotation | minLength | 1 |  | maxLength | 1 |  |
| Kind       | Value   | annotation |       |            |           |   |  |           |   |  |
| minLength  | 1   |            |       |            |           |   |  |           |   |  |
| maxLength  | 1   |            |       |            |           |   |  |           |   |  |
| annotation | <p>documentation</p> <p>A11 - "Y" if all SCR contributions are given for each Portfolio line. "N" otherwise.</p>  |            |       |            |           |   |  |           |   |  |

element **SolvencyIIPortfolioType\_V5/QRTPortfolioInformation**

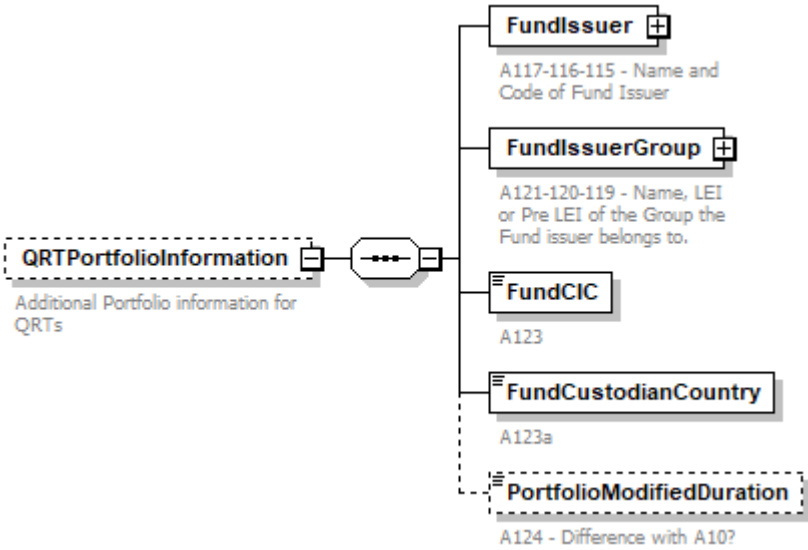
|            |  |
|------------|--|
| diagram    |  <p><b>QRTPortfolioInformation</b></p> <p>Additional Portfolio information for QRTs</p> <ul style="list-style-type: none"> <li><b>FundIssuer</b> (+) <ul style="list-style-type: none"> <li>A117-116-115 - Name and Code of Fund Issuer</li> </ul> </li> <li><b>FundIssuerGroup</b> (+) <ul style="list-style-type: none"> <li>A121-120-119 - Name, LEI or Pre LEI of the Group the Fund issuer belongs to.</li> </ul> </li> <li><b>FundCIC</b> <ul style="list-style-type: none"> <li>A123</li> </ul> </li> <li><b>FundCustodianCountry</b> <ul style="list-style-type: none"> <li>A123a</li> </ul> </li> <li><b>PortfolioModifiedDuration</b> (dashed) <ul style="list-style-type: none"> <li>A124 - Difference with A10?</li> </ul> </li> </ul> |
| properties | <p>isRef 0</p> <p>minOcc 0</p>   |

|            |   |
|------------|---|
|            | maxOcc 1<br>content complex   |
| children   | <a href="#">FundIssuer</a> <a href="#">FundIssuerGroup</a> <a href="#">FundCIC</a> <a href="#">FundCustodianCountry</a> <a href="#">PortfolioModifiedDuration</a> |
| annotation | documentation<br>Additional Portfolio information for QRTs  |

element **SolvencyIIPortfolioType\_V5/QRTPortfolioInformation/FundIssuer**

|            |   |
|------------|---|
| diagram    |   |
| type       | extension of <a href="#">SIllssuerType_V5</a>   |
| properties | isRef 0<br>content complex  |
| children   | <a href="#">Name</a> <a href="#">Code</a> <a href="#">CodeType</a> <a href="#">EconomicSector</a> <a href="#">Country</a> |
| annotation | documentation<br>A117-116-115 - Name and Code of Fund Issuer  |

element **SolvencyIIPortfolioType\_V5/QRTPortfolioInformation/FundIssuer/EconomicSector**

|            |   |
|------------|---|
| diagram    |   |
| type       | <a href="#">NACECodeType</a>  |
| properties | isRef 0<br>content simple   |
| facets     | Kind Value annotation<br>minLength 1<br>maxLength 7<br>pattern ([A-Z]{1}[0-9\.\.]{0,6}) |
| annotation | documentation<br>A118 - NACE code of Issuer of Fund or Share Class                      |

element **SolvencyIIPortfolioType\_V5/QRTPortfolioInformation/FundIssuer/Country**

|            |   |
|------------|---|
| diagram    |  <p>The diagram shows a box labeled "Country" with the annotation "A122" below it.</p> |
| type       | <a href="#">ISOCountryCodeType</a>  |
| properties | isRef 0<br>content simple   |
| facets     | Kind Value annotation<br>minLength 2<br>maxLength 2   |
| annotation | documentation<br>A122   |

element **SolvencyIIPortfolioType\_V5/QRTPortfolioInformation/FundIssuerGroup**

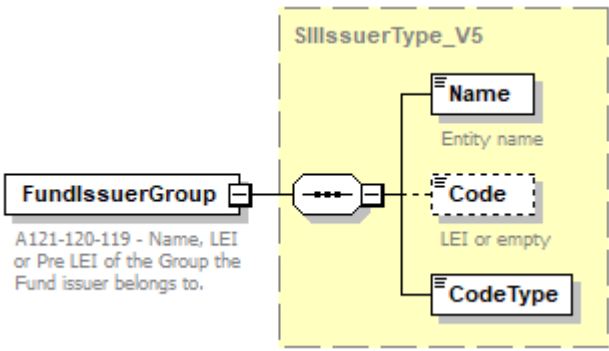
|            |  |
|------------|--|
| diagram    |  <p>The diagram shows a box labeled "FundIssuerGroup" with the annotation "A121-120-119 - Name, LEI or Pre LEI of the Group the Fund issuer belongs to." below it. To its right is a dashed box labeled "SIIIssuerType_V5" containing three elements: "Name" (Entity name), "Code" (LEI or empty), and "CodeType".</p> |
| type       | <a href="#">SIIIssuerType_V5</a>   |
| properties | isRef 0<br>content complex   |
| children   | <a href="#">Name</a> <a href="#">Code</a> <a href="#">CodeType</a>   |
| annotation | documentation<br>A121-120-119 - Name, LEI or Pre LEI of the Group the Fund issuer belongs to.  |

element **SolvencyIIPortfolioType\_V5/QRTPortfolioInformation/FundCIC**

|            |   |
|------------|---|
| diagram    |  <p>The diagram shows a box labeled "FundCIC" with the annotation "A123" below it.</p> |
| type       | <a href="#">CICCodeType</a>   |
| properties | isRef 0<br>content simple   |
| facets     | Kind Value annotation<br>minLength 4<br>maxLength 4<br>pattern ([A-Z]{2}([A-F] [0-9]){1}[1-9]{1})   |
| annotation | documentation<br>A123   |

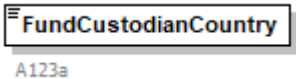

element **SolvencyIIPortfolioType\_V5/QRTPortfolioInformation/FundCustodianCountry**

|            |   |
|------------|---|
| diagram    |  <p>The diagram shows a rectangular box labeled "FundCustodianCountry" with a small icon to its left. Below the box is the text "A123a".</p> |
| type       | <a href="#">ISOCountryCodeType</a>  |
| properties | isRef 0<br>content simple   |
| facets     | Kind Value annotation<br>minLength 2<br>maxLength 2   |
| annotation | documentation<br>A123a  |

element **SolvencyIIPortfolioType\_V5/QRTPortfolioInformation/PortfolioModifiedDuration**

|            |   |
|------------|---|
| diagram    |  <p>The diagram shows a dashed rectangular box labeled "PortfolioModifiedDuration" with a small icon to its left. Below the box is the text "A124 - Difference with A10?".</p> |
| type       | <b>xs:decimal</b>   |
| properties | isRef 0<br>minOcc 0<br>maxOcc 1<br>content simple   |
| annotation | documentation<br>A124 - Difference with A10?  |

element **SolvencyIIPortfolioType\_V5/Positions**

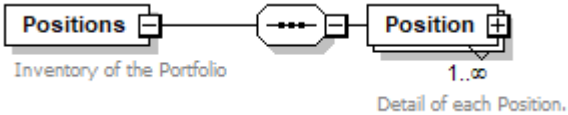
|            |   |
|------------|---|
| diagram    |  <p>The diagram shows a box labeled "Positions" with a small icon to its left. Below it is the text "Inventory of the Portfolio". A line connects this box to a larger box labeled "Position" with a small icon to its left. Below the "Position" box is the text "1..∞" and "Detail of each Position.".</p> |
| properties | isRef 0<br>content complex  |
| children   | <a href="#">Position</a>  |
| annotation | documentation<br>Inventory of the Portfolio   |

element SolvencyIIPortfolioType\_V5/Positions/Position

diagram

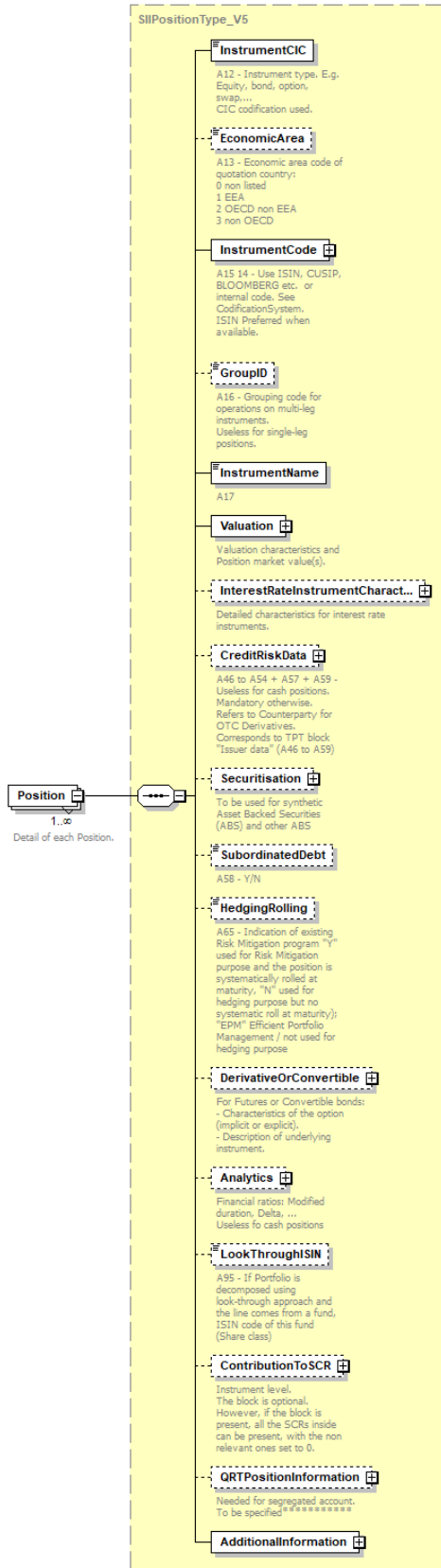

|            |  |
|------------|--|
| type       | <a href="#">SIIPositionType V5</a>   |
| properties | isRef 0<br>minOcc 1<br>maxOcc unbounded<br>content complex   |
| children   | <a href="#">InstrumentCIC</a> <a href="#">EconomicArea</a> <a href="#">InstrumentCode</a> <a href="#">GroupID</a> <a href="#">InstrumentName</a> <a href="#">Valuation</a><br><a href="#">InterestRateInstrumentCharacteristics</a> <a href="#">CreditRiskData</a> <a href="#">Securitisation</a> <a href="#">SubordinatedDebt</a> <a href="#">HedgingRolling</a><br><a href="#">DerivativeOrConvertible</a> <a href="#">Analytics</a> <a href="#">LookThroughISIN</a> <a href="#">ContributionToSCR</a> <a href="#">QRTPositionInformation</a><br><a href="#">AdditionalInformation</a> |
| annotation | documentation<br>Detail of each Position.  |

# complexType SolvencyIIPortfolioType\_V6

diagram



## FundOrShareClassIdentifiers

Fund or share class identifiers for easy connection to other fund or share class data

## DataSupplier

Definition of data source (investment company, vendor, ...)

## TPTVersion

A1000 - Version number of the TPT.  
The version corresponding to the current XML schema is "V6.0"

## PortfolioID

A02 01 - Use ISIN, CUSIP, BLOOMBERG etc. or internal code. See CodificationSystem.  
ISIN Preferred when available.

## PortfolioName

A03 - Portfolio or Fund or Share class name

## PortfolioCurrency

A04 - Portfolio currency used for valuation of assets.  
If Portfolio is reported at ShareClass level, PortfolioCurrency is the ShareClass currency.  
Code  
ISO 4217  
CNH : 2 Chinese yuan (when traded offshore)  
- Hong Kong  
CNT: Chinese yuan (when traded offshore) -Taiwan  
GGP - Guernsey pound - Guernsey  
IMP: Isle of Man pound also Manx pound -Isle of Man  
JEP: Jersey pound - Jersey  
KID: Kiribati dollar -Kiribati  
NIS - New Israeli Shekel - Israel  
PRB - Transnistrian ruble - Transnistria (The code conflicts with ISO-4217 because PR stands for Puerto Rico, X should have been used for the first letter,)  
TVD - Tuvalu dollar- Tuvalu

## TotalNetAssets

A05 - Total net assets of the Portfolio or the Share class in PortfolioCurrency

## ValuationDate

A06 - Date at which the portfolio inventory is valid. Used for NAV data.

## ReportingDate

A07 - Date to which data refers ( end of month for example)

## ShareClass

A 06, A 06b

## CashPercentage

A09 - Liquidities of the Portfolio converted into Portfolio currency.  
In percentage of TotalNetAssets.

## PortfolioModifiedDuration

A10 - Weighted average modified duration of portfolio. Only required for relevant asset types (including derivatives).

## CompleteSCRDelivery

A11 - "Y" if all SCR contributions are given for each Portfolio line.  
"N" otherwise.

## QRTPortfolioInformation

Additional Portfolio information for QRTs

## Positions

Inventory of the Portfolio

|            |  |
|------------|--|
| children   | <a href="#">FundOrShareClassIdentifiers</a> <a href="#">DataSupplier</a> <a href="#">TPTVersion</a> <a href="#">PortfolioID</a> <a href="#">PortfolioName</a> <a href="#">PortfolioCurrency</a> <a href="#">TotalNetAssets</a> <a href="#">ValuationDate</a> <a href="#">ReportingDate</a> <a href="#">ShareClass</a> <a href="#">CashPercentage</a> <a href="#">PortfolioModifiedDuration</a> <a href="#">CompleteSCRDelivery</a> <a href="#">QRTPortfolioInformation</a> <a href="#">Positions</a> |
| used by    | element <a href="#">TripartiteTemplateSolvencyIIType_V6/Portfolio</a>  |
| annotation | documentation<br>XML adaptation of "Tripartite Template"   |

element **SolvencyIIPortfolioType\_V6/FundOrShareClassIdentifiers**

|            |  |
|------------|--|
| diagram    |  |
| type       | <a href="#">FundOrShareClassIdentifiersType</a>  |
| properties | isRef 0<br>minOcc 0<br>maxOcc 1<br>content complex   |
| children   | <a href="#">LEI</a> <a href="#">ISINs</a>  |
| annotation | documentation<br>Fund or share class identifiers for easy connection to other fund or share class data |

element **SolvencyIIPortfolioType\_V6/DataSupplier**

|         |  |
|---------|--|
| diagram |  |
|---------|--|

|            |   |
|------------|---|
| type       | <a href="#">DataSupplierType</a>  |
| properties | isRef 0<br>minOcc 0<br>maxOcc 1<br>content complex  |
| children   | <a href="#">SystemCountry</a> <a href="#">Short Name</a> <a href="#">Type</a> <a href="#">Contact</a> |
| annotation | documentation<br>Definition of data source (investment company, vendor, ...)                          |

element **SolvencyIIPortfolioType\_V6/TPTVersion**

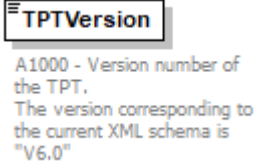
|            |   |
|------------|---|
| diagram    |  <p>A1000 - Version number of the TPT.<br/>The version corresponding to the current XML schema is "V6.0"</p> |
| type       | restriction of <b>xs:string</b>   |
| properties | isRef 0<br>content simple<br>default V6.0   |
| annotation | documentation<br>A1000 - Version number of the TPT.<br>The version corresponding to the current XML schema is "V6.0"  |

element **SolvencyIIPortfolioType\_V6/PortfolioID**

|                   |   |
|-------------------|---|
| <p>diagram</p>    | <p><b>PortfolioID</b></p> <p>A02 01 - Use ISIN, CUSIP, BLOOMBERG etc. or internal code. See CodificationSystem. ISIN Preferred when available.</p> <p><b>SII Security Codification Type V6</b></p> <p><b>CodificationSystem</b></p> <p>Codification system used. Integer corresponding to the following closed list:<br/>         1 - ISO 6166 for ISIN code<br/>         2 - CUSIP (The Committee on Uniform Securities Identification Procedures number assigned by the CUSIP Service Bureau for U.S. and Canadian companies)<br/>         3 - SEDOL (Stock Exchange Daily Official List for the London Stock Exchange)<br/>         4 - WKN (Wertpapier Kenn-Nummer, the alphanumeric German identification number)<br/>         5 - Bloomberg Ticker (Bloomberg letters code that identify a company's securities)<br/>         6 - BBGID (The Bloomberg Global ID)<br/>         7 - Reuters RIC (Reuters instrument code)<br/>         8 - FIGI (Financial Instrument Global Identifier)<br/>         9 - Other code by members of the Association of National Numbering Agencies<br/>         99 - Code attributed by the undertaking</p> <p><b>Code</b></p> <p>Value of code in CodificationSystem</p> |
| <p>type</p>       | <p><a href="#">SII Security Codification Type V6</a></p>  |
| <p>properties</p> | <p>isRef 0<br/>content complex</p>  |
| <p>children</p>   | <p><a href="#">CodificationSystem</a> <a href="#">Code</a></p>  |
| <p>annotation</p> | <p>documentation<br/>A02 01 - Use ISIN, CUSIP, BLOOMBERG etc. or internal code. See CodificationSystem. ISIN Preferred when available.</p>  |

element **SolvencyIIPortfolioType\_V6/PortfolioName**

|                   |  |
|-------------------|--|
| <p>diagram</p>    | <p><b>PortfolioName</b></p> <p>A03 - Portfolio or Fund or Share class name</p> |
| <p>type</p>       | <p><b>xs:string</b></p>  |
| <p>properties</p> | <p>isRef 0<br/>content simple</p>  |
| <p>annotation</p> | <p>documentation<br/>A03 - Portfolio or Fund or Share class name</p>           |

element **SolvencyIIPortfolioType\_V6/PortfolioCurrency**

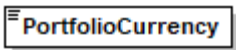
|                   |   |
|-------------------|---|
| <p>diagram</p>    |  <p>A04 - Portfolio currency used for valuation of assets.<br/>If Portfolio is reported at ShareClass level, PortfolioCurrency is the ShareClass currency.<br/>Code<br/>ISO 4217<br/>CNH : 2 Chinese yuan (when traded offshore) - Hong Kong<br/>CNT: Chinese yuan (when traded offshore) -Taiwan<br/>GGP – Guernsey pound - Guernsey<br/>IMP: Isle of Man pound also Manx pound -Isle of Man<br/>JEP: Jersey pound - Jersey<br/>KID: Kiribati dollar -Kiribati<br/>NIS – New Israeli Shekel - Israel<br/>PRB – Transnistrian ruble - Transnistria (The code conflicts with ISO-4217 because PR stands for Puerto Rico. X should have been used for the first letter.)<br/>TVD – Tuvalu dollar- Tuvalu</p> |
| <p>type</p>       | <p><a href="#">ISOCurrencyCodeType</a></p>  |
| <p>properties</p> | <p>isRef 0<br/>content simple</p>   |
| <p>facets</p>     | <p>Kind Value annotation<br/>minLength 3<br/>maxLength 3<br/>pattern [A-Z]{3}</p>   |
| <p>annotation</p> | <p>documentation<br/>A04 - Portfolio currency used for valuation of assets.<br/>If Portfolio is reported at ShareClass level, PortfolioCurrency is the ShareClass currency.<br/>Code ISO 4217 CNH : 2 Chinese yuan (when traded offshore) - Hong Kong<br/>CNT: Chinese yuan (when traded offshore) -Taiwan<br/>GGP – Guernsey pound - Guernsey<br/>IMP: Isle of Man pound also Manx pound -Isle of Man<br/>JEP: Jersey pound - Jersey<br/>KID: Kiribati dollar -Kiribati<br/>NIS – New Israeli Shekel - Israel<br/>PRB – Transnistrian ruble - Transnistria (The code conflicts with ISO-4217 because PR stands for Puerto Rico. X should have been used for the first letter.)<br/>TVD – Tuvalu dollar- Tuvalu</p>   |

element **SolvencyIIPortfolioType\_V6/TotalNetAssets**

|                |  |
|----------------|--|
| <p>diagram</p> |  <p>A05 - Total net assets of the Portfolio or the Share class in PortfolioCurrency</p> |
| <p>type</p>    | <p><b>xs:decimal</b></p>   |



|            |  |
|------------|--|
| properties | isRef 0<br>content simple  |
| annotation | documentation<br>A05 - Total net assets of the Portfolio or the Share class in PortfolioCurrency |

element **SolvencyIIPortfolioType\_V6/ValuationDate**

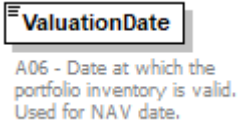
|            |   |
|------------|---|
| diagram    |          |
| type       | <b>xs:date</b>  |
| properties | isRef 0<br>content simple   |
| annotation | documentation<br>A06 - Date at which the portfolio inventory is valid. Used for NAV date. |

element **SolvencyIIPortfolioType\_V6/ReportingDate**

|            |   |
|------------|---|
| diagram    |  |
| type       | <b>xs:date</b>  |
| properties | isRef 0<br>content simple   |
| annotation | documentation<br>A07 - Date to which data refers ( end of month for example)      |

element **SolvencyIIPortfolioType\_V6/ShareClass**

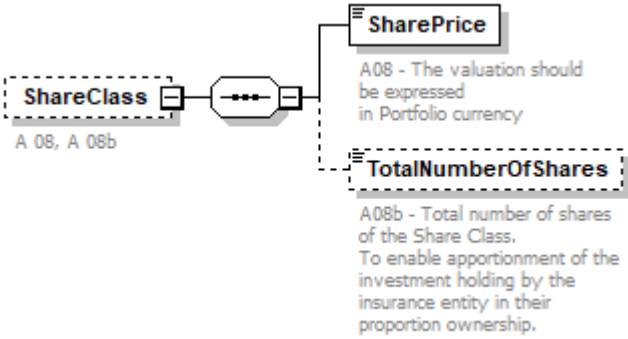
|            |   |
|------------|---|
| diagram    |  |
| properties | isRef 0<br>minOcc 0<br>maxOcc 1<br>content complex                                  |
| children   | <a href="#">SharePrice</a> <a href="#">TotalNumberOfShares</a>                      |
| annotation | documentation<br>A 08, A 08b  |

element **SolvencyIIPortfolioType\_V6/ShareClass/SharePrice**

|            |  |
|------------|--|
| diagram    |  <p>A08 - The valuation should be expressed in Portfolio currency</p> |
| type       | <b>xs:decimal</b>  |
| properties | isRef 0<br>content simple  |
| annotation | documentation<br>A08 - The valuation should be expressed in Portfolio currency   |

element **SolvencyIIPortfolioType\_V6/ShareClass/TotalNumberOfShares**

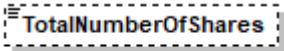
|            |   |
|------------|---|
| diagram    |  <p>A08b - Total number of shares of the Share Class.<br/>To enable apportionment of the investment holding by the insurance entity in their proportion ownership.</p> |
| type       | <b>xs:decimal</b>   |
| properties | isRef 0<br>minOcc 0<br>maxOcc 1<br>content simple   |
| annotation | documentation<br>A08b - Total number of shares of the Share Class.<br>To enable apportionment of the investment holding by the insurance entity in their proportion ownership.  |

element **SolvencyIIPortfolioType\_V6/CashPercentage**

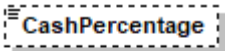
|            |   |
|------------|---|
| diagram    |  <p>A09 - Liquidities of the Portfolio converted into Portfolio currency.<br/>In percentage of TotalNetAssets.</p> |
| type       | <b>xs:decimal</b>   |
| properties | isRef 0<br>minOcc 0<br>maxOcc 1<br>content simple   |
| annotation | documentation<br>A09 - Liquidities of the Portfolio converted into Portfolio currency.<br>In percentage of TotalNetAssets.  |

element **SolvencyIIPortfolioType\_V6/PortfolioModifiedDuration**

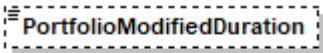
|            |   |
|------------|---|
| diagram    |  <p><b>PortfolioModifiedDuration</b></p> <p>A10 - Weighted average modified duration of portfolio. Only required for relevant asset types (including derivatives).</p> |
| type       | <b>xs:decimal</b>   |
| properties | isRef 0<br>minOcc 0<br>maxOcc 1<br>content simple   |
| annotation | documentation<br>A10 - Weighted average modified duration of portfolio. Only required for relevant asset types (including derivatives).   |

element **SolvencyIIPortfolioType\_V6/CompleteSCRDelivery**

| diagram    |  <p><b>CompleteSCRDelivery</b></p> <p>A11 - "Y" if all SCR contributions are given for each Portfolio line. "N" otherwise.</p>                 |            |       |            |           |   |  |           |   |  |
|------------|---|------------|-------|------------|-----------|---|--|-----------|---|--|
| type       | <b>YesNoL1Type</b>  |            |       |            |           |   |  |           |   |  |
| properties | isRef 0<br>content simple   |            |       |            |           |   |  |           |   |  |
| facets     | <table border="1"> <thead> <tr> <th>Kind</th> <th>Value</th> <th>annotation</th> </tr> </thead> <tbody> <tr> <td>minLength</td> <td>1</td> <td></td> </tr> <tr> <td>maxLength</td> <td>1</td> <td></td> </tr> </tbody> </table> | Kind       | Value | annotation | minLength | 1 |  | maxLength | 1 |  |
| Kind       | Value   | annotation |       |            |           |   |  |           |   |  |
| minLength  | 1   |            |       |            |           |   |  |           |   |  |
| maxLength  | 1   |            |       |            |           |   |  |           |   |  |
| annotation | documentation<br>A11 - "Y" if all SCR contributions are given for each Portfolio line. "N" otherwise.   |            |       |            |           |   |  |           |   |  |

element **SolvencyIIPortfolioType\_V6/QRTPortfolioInformation**

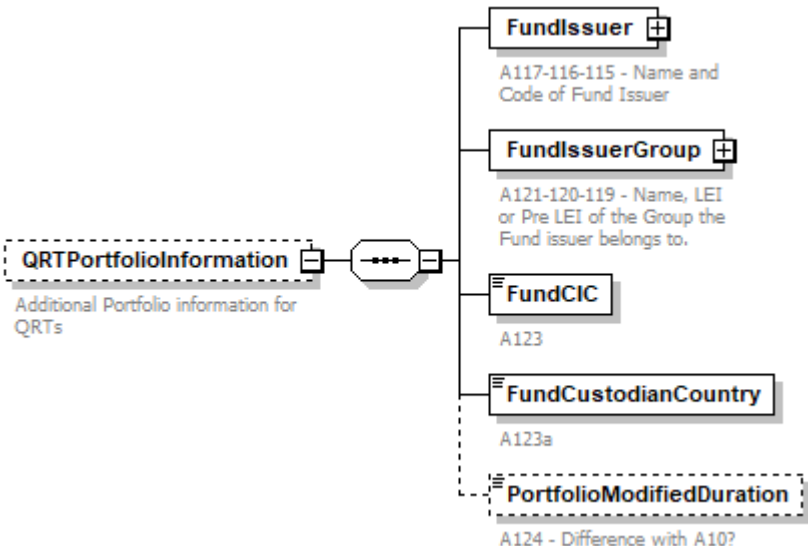
|            |   |
|------------|---|
| diagram    |  <p><b>QRTPortfolioInformation</b></p> <p>Additional Portfolio information for QRTs</p> <ul style="list-style-type: none"> <li><b>FundIssuer</b> (+)<br/>A117-116-115 - Name and Code of Fund Issuer</li> <li><b>FundIssuerGroup</b> (+)<br/>A121-120-119 - Name, LEI or Pre LEI of the Group the Fund issuer belongs to.</li> <li><b>FundCIC</b><br/>A123</li> <li><b>FundCustodianCountry</b><br/>A123a</li> <li><b>PortfolioModifiedDuration</b> (dashed)<br/>A124 - Difference with A10?</li> </ul> |
| properties | isRef 0<br>minOcc 0   |

|            |   |
|------------|---|
|            | maxOcc 1<br>content complex   |
| children   | <a href="#">FundIssuer</a> <a href="#">FundIssuerGroup</a> <a href="#">FundCIC</a> <a href="#">FundCustodianCountry</a> <a href="#">PortfolioModifiedDuration</a> |
| annotation | documentation<br>Additional Portfolio information for QRTs  |

element **SolvencyIIPortfolioType\_V6/QRTPortfolioInformation/FundIssuer**

|            |  |
|------------|--|
| diagram    | <p>The diagram illustrates the class structure for the <b>FundIssuer</b> element. It is an extension of the <b>SIIIssuerType_V6 (extension)</b> class. The base class has three attributes: <b>Name</b> (Entity name), <b>Code</b> (LEI or empty), and <b>CodeType</b>. The <b>FundIssuer</b> class extends this base class and adds two more attributes: <b>EconomicSector</b> (A118 - NACE code of Issuer of Fund or Share Class) and <b>Country</b> (A122).</p> |
| type       | extension of <a href="#">SIIIssuerType_V6</a>  |
| properties | isRef 0<br>content complex   |
| children   | <a href="#">Name</a> <a href="#">Code</a> <a href="#">CodeType</a> <a href="#">EconomicSector</a> <a href="#">Country</a>  |
| annotation | documentation<br>A117-116-115 - Name and Code of Fund Issuer   |

element **SolvencyIIPortfolioType\_V6/QRTPortfolioInformation/FundIssuer/EconomicSector**

|            |   |
|------------|---|
| diagram    | <p>The diagram shows the <b>EconomicSector</b> element as a simple type derived from <b>NACECodeType</b>. The attribute is <b>EconomicSector</b> (A118 - NACE code of Issuer of Fund or Share Class).</p> |
| type       | <a href="#">NACECodeType</a>  |
| properties | isRef 0<br>content simple   |
| facets     | Kind Value annotation<br>minLength 1<br>maxLength 7<br>pattern ([A-Z]{1}[0-9\.\.]{0,6})   |
| annotation | documentation<br>A118 - NACE code of Issuer of Fund or Share Class  |

element **SolvencyIIPortfolioType\_V6/QRTPortfolioInformation/FundIssuer/Country**

|            |   |
|------------|---|
| diagram    |  <p>A122</p> |
| type       | <a href="#">ISOCountryCodeType</a>  |
| properties | isRef 0<br>content simple   |
| facets     | Kind Value annotation<br>minLength 2<br>maxLength 2   |
| annotation | documentation<br>A122   |

element **SolvencyIIPortfolioType\_V6/QRTPortfolioInformation/FundIssuerGroup**

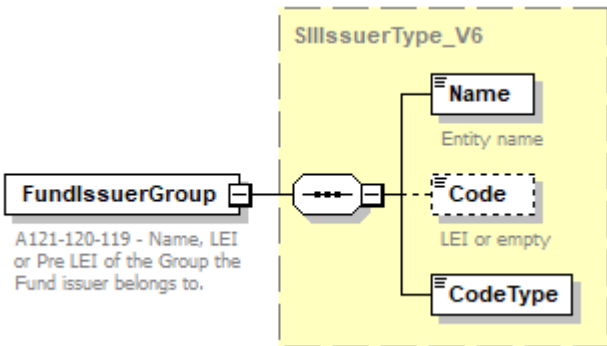
|            |  |
|------------|--|
| diagram    |  <p>A121-120-119 - Name, LEI or Pre LEI of the Group the Fund issuer belongs to.</p> |
| type       | <a href="#">SIIIssuerType_V6</a>   |
| properties | isRef 0<br>content complex   |
| children   | <a href="#">Name</a> <a href="#">Code</a> <a href="#">CodeType</a>   |
| annotation | documentation<br>A121-120-119 - Name, LEI or Pre LEI of the Group the Fund issuer belongs to.  |

element **SolvencyIIPortfolioType\_V6/QRTPortfolioInformation/FundCIC**

|            |   |
|------------|---|
| diagram    |  <p>A123</p>     |
| type       | <a href="#">CICCodeType</a>   |
| properties | isRef 0<br>content simple   |
| facets     | Kind Value annotation<br>minLength 4<br>maxLength 4<br>pattern $([A-Z]{2}([A-F] [0-9]){1}[1-9]{1})$ |
| annotation | documentation<br>A123   |

element **SolvencyIIPortfolioType\_V6/QRTPortfolioInformation/FundCustodianCountry**

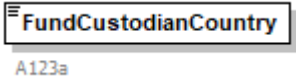
|            |  |
|------------|--|
| diagram    |  <p>A123a</p> |
| type       | <a href="#">ISOCountryCodeType</a>   |
| properties | isRef 0<br>content simple  |
| facets     | Kind Value annotation<br>minLength 2<br>maxLength 2  |
| annotation | documentation<br>A123a   |

element **SolvencyIIPortfolioType\_V6/QRTPortfolioInformation/PortfolioModifiedDuration**

|            |  |
|------------|--|
| diagram    |  <p>A124 - Difference with A10?</p> |
| type       | <b>xs:decimal</b>  |
| properties | isRef 0<br>minOcc 0<br>maxOcc 1<br>content simple  |
| annotation | documentation<br>A124 - Difference with A10?   |

element **SolvencyIIPortfolioType\_V6/Positions**

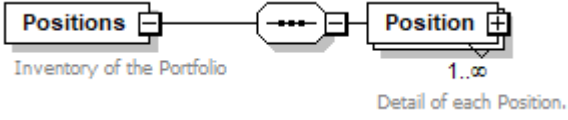
|            |  |
|------------|--|
| diagram    |  <p>Inventory of the Portfolio</p> <p>1..∞<br/>Detail of each Position.</p> |
| properties | isRef 0<br>content complex   |
| children   | <a href="#">Position</a>   |
| annotation | documentation<br>Inventory of the Portfolio  |

# element SolvencyIIPortfolioType\_V6/Positions/Position

diagram

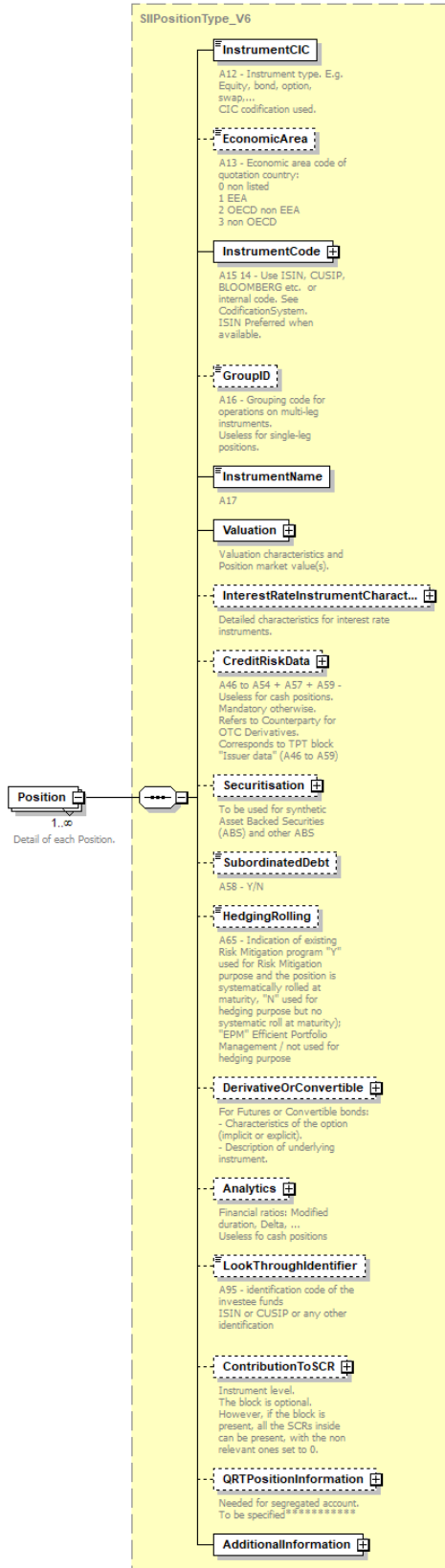

|            |  |
|------------|--|
| type       | <a href="#">SIIPositionType V6</a>   |
| properties | isRef 0<br>minOcc 1<br>maxOcc unbounded<br>content complex   |
| children   | <a href="#">InstrumentCIC</a> <a href="#">EconomicArea</a> <a href="#">InstrumentCode</a> <a href="#">GroupID</a> <a href="#">InstrumentName</a> <a href="#">Valuation</a><br><a href="#">InterestRateInstrumentCharacteristics</a> <a href="#">CreditRiskData</a> <a href="#">Securitisation</a> <a href="#">SubordinatedDebt</a> <a href="#">HedgingRolling</a><br><a href="#">DerivativeOrConvertible</a> <a href="#">Analytics</a> <a href="#">LookThroughIdentifier</a> <a href="#">ContributionToSCR</a> <a href="#">QRTPositionInformation</a><br><a href="#">AdditionalInformation</a> |
| annotation | documentation<br>Detail of each Position.  |

complexType **TripartiteTemplateSolvencyIIType**

|          |   |
|----------|---|
| diagram  | <pre> classDiagram     class TripartiteTemplateSolvencyIIType {         Portfolio 1..∞     }     </pre> <p>The Portfolio is analysed from investor's point of view. If Portfolio is a Fund with share classes, there is one Portfolio for each share class. For hedged shares, hedging instruments are included in the portfolio. References to Club AMPERE Excel "Template for Solvency 2 reporting": Ann in Annotations refers to row #nn in column A (or "NUM") of the Spreadsheet</p> |
| children | <a href="#">Portfolio</a>   |
| used by  | element <a href="#">IndirectReportingType/TripartiteTemplateSolvencyII</a>  |



# element TripartiteTemplateSolvencyIIType/Portfolio

diagram

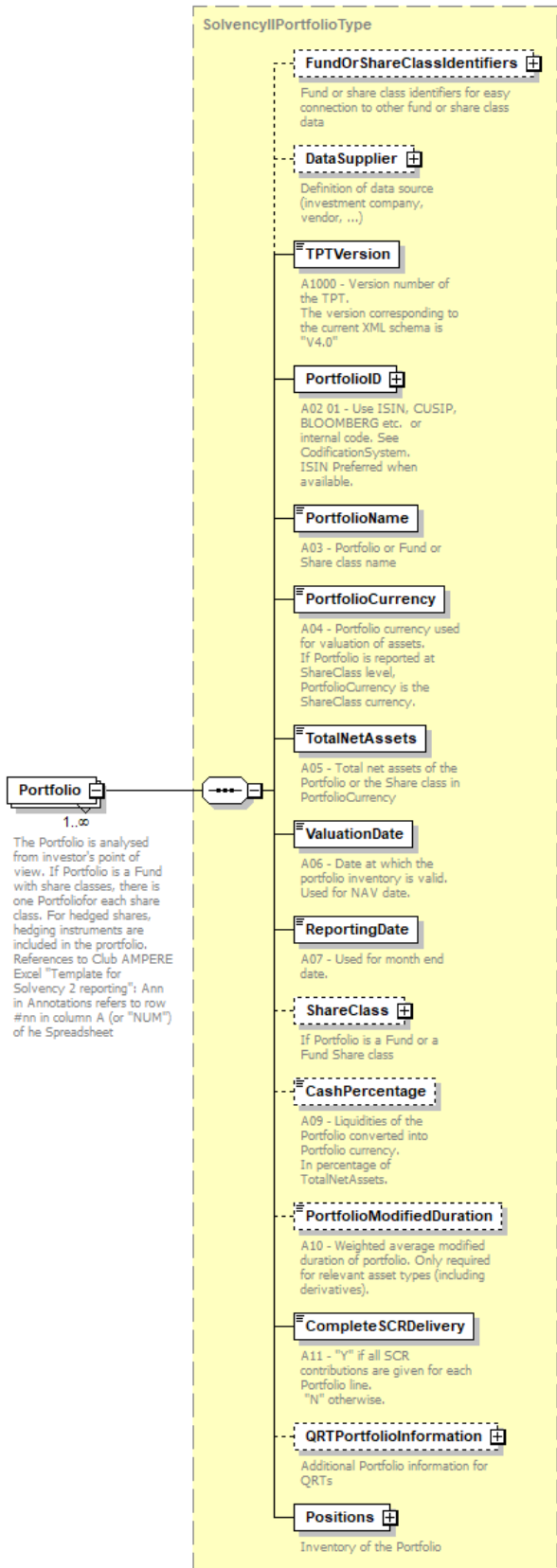

|            |  |
|------------|--|
| type       | <a href="#">SolvencyIIPortfolioType</a>  |
| properties | isRef 0<br>minOcc 1<br>maxOcc unbounded<br>content complex   |
| children   | <a href="#">FundOrShareClassIdentifiers</a> <a href="#">DataSupplier</a> <a href="#">TPTVersion</a> <a href="#">PortfolioID</a> <a href="#">PortfolioName</a> <a href="#">PortfolioCurrency</a> <a href="#">TotalNetAssets</a> <a href="#">ValuationDate</a> <a href="#">ReportingDate</a> <a href="#">ShareClass</a> <a href="#">CashPercentage</a> <a href="#">PortfolioModifiedDuration</a> <a href="#">CompleteSCRDelivery</a> <a href="#">QRTPortfolioInformation</a> <a href="#">Positions</a> |
| annotation | documentation<br>The Portfolio is analysed from investor's point of view. If Portfolio is a Fund with share classes, there is one Portfolio for each share class. For hedged shares, hedging instruments are included in the portfolio.<br>References to Club AMPERE Excel "Template for Solvency 2 reporting": Ann in Annotations refers to row #nn in column A (or "NUM") of he Spreadsheet  |

complexType **TripartiteTemplateSolvencyIIType\_V5**

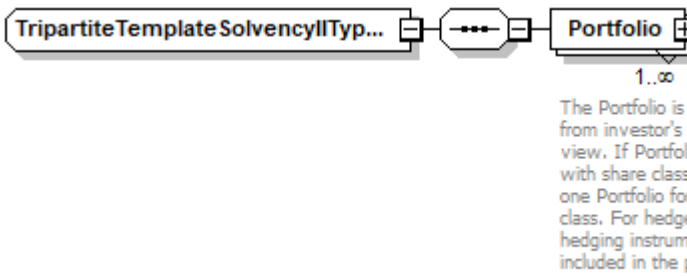
|          |   |
|----------|---|
| diagram  |  <p>The Portfolio is analysed from investor's point of view. If Portfolio is a Fund with share classes, there is one Portfolio for each share class. For hedged shares, hedging instruments are included in the portfolio.</p> |
| children | <a href="#">Portfolio</a>   |
| used by  | element <a href="#">IndirectReportingType/TripartiteTemplateSolvencyII_V5</a>   |

# element TripartiteTemplateSolvencyIIType\_V5/Portfolio

diagram

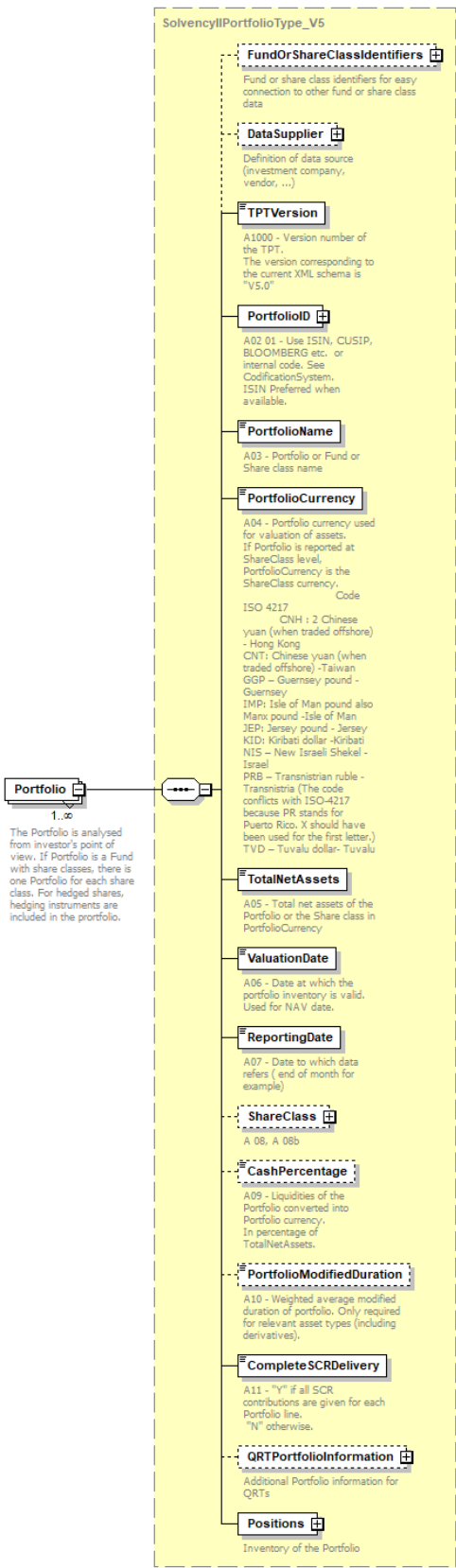

SolvencyIIPortfolioType\_V5

**FundOrShareClassIdentifiers**

Fund or share class identifiers for easy connection to other fund or share class data

**DataSupplier**

Definition of data source (investment company, vendor, ...)

**TPTVersion**

A1000 - Version number of the TPT.  
The version corresponding to the current XML schema is "V5.0"

**PortfolioID**

A02 01 - Use ISIN, CUSIP, BLOOMBERG etc. or internal code. See CodificationSystem. ISIN Preferred when available.

**PortfolioName**

A03 - Portfolio or Fund or Share class name

**PortfolioCurrency**

A04 - Portfolio currency used for valuation of assets. If Portfolio is reported at ShareClass level, PortfolioCurrency is the ShareClass currency.

Code  
ISO 4217  
CNH : 2 Chinese yuan (when traded offshore)  
- Hong Kong  
CNT: Chinese yuan (when traded offshore) -Taiwan  
GGP - Guernsey pound - Guernsey  
IMP: Isle of Man pound also Manx pound -Isle of Man  
JEP: Jersey pound - Jersey  
KID: Kiribati dollar -Kiribati  
NIS - New Israeli Shekel - Israel  
PRB - Transnistrian ruble - Transnistria (The code conflicts with ISO-4217 because PR stands for Puerto Rico. X should have been used for the first letter.)  
TVD - Tuvalu dollar- Tuvalu

**TotalNetAssets**

A05 - Total net assets of the Portfolio or the Share class in PortfolioCurrency

**ValuationDate**

A06 - Date at which the portfolio inventory is valid. Used for NAV date.

**ReportingDate**

A07 - Date to which data refers ( end of month for example)

**ShareClass**

A 08, A 08b

**CashPercentage**

A09 - Liquidities of the Portfolio converted into Portfolio currency. In percentage of TotalNetAssets.

**PortfolioModifiedDuration**

A10 - Weighted average modified duration of portfolio. Only required for relevant asset types (including derivatives).

**CompleteSCRDelivery**

A11 - "Y" if all SCR contributions are given for each Portfolio line. "N" otherwise.

**QRTPortfolioInformation**

Additional Portfolio information for QRTs

**Positions**

Inventory of the Portfolio

**Portfolio**

1..∞

The Portfolio is analyzed from investor's point of view. If Portfolio is a Fund with share classes, there is one Portfolio for each share class. For hedged shares, hedging instruments are included in the portfolio.

|            |   |
|------------|---|
| type       | <a href="#">SolvencyIIPortfolioType_V5</a>  |
| properties | isRef 0<br>minOcc 1<br>maxOcc unbounded<br>content complex  |
| children   | <a href="#">FundOrShareClassIdentifiers</a> <a href="#">DataSupplier</a> <a href="#">TPTVersion</a> <a href="#">PortfolioID</a> <a href="#">PortfolioName</a> <a href="#">PortfolioCurrency</a> <a href="#">TotalNetAssets</a> <a href="#">ValuationDate</a> <a href="#">ReportingDate</a> <a href="#">ShareClass</a> <a href="#">CashPercentage</a> <a href="#">PortfolioModifiedDuration</a> <a href="#">CompleteSCRDelivery</a> <a href="#">QRTPortfoliInformation</a> <a href="#">Positions</a> |
| annotation | documentation<br>The Portfolio is analysed from investor's point of view. If Portfolio is a Fund with share classes, there is one Portfolio for each share class. For hedged shares, hedging instruments are included in the portfolio.   |

**complexType TripartiteTemplateSolvencyIIType\_V6**

|          |   |
|----------|---|
| diagram  | <p>1..∞</p> <p>The Portfolio is analysed from investor's point of view. If Portfolio is a Fund with share classes, there is one Portfolio for each share class. For hedged shares, hedging instruments are included in the portfolio.</p> |
| children | <a href="#">Portfolio</a>   |
| used by  | element <a href="#">IndirectReportingType/TripartiteTemplateSolvencyII_V6</a>   |

# element TripartiteTemplateSolvencyIIType\_V6/Portfolio

diagram

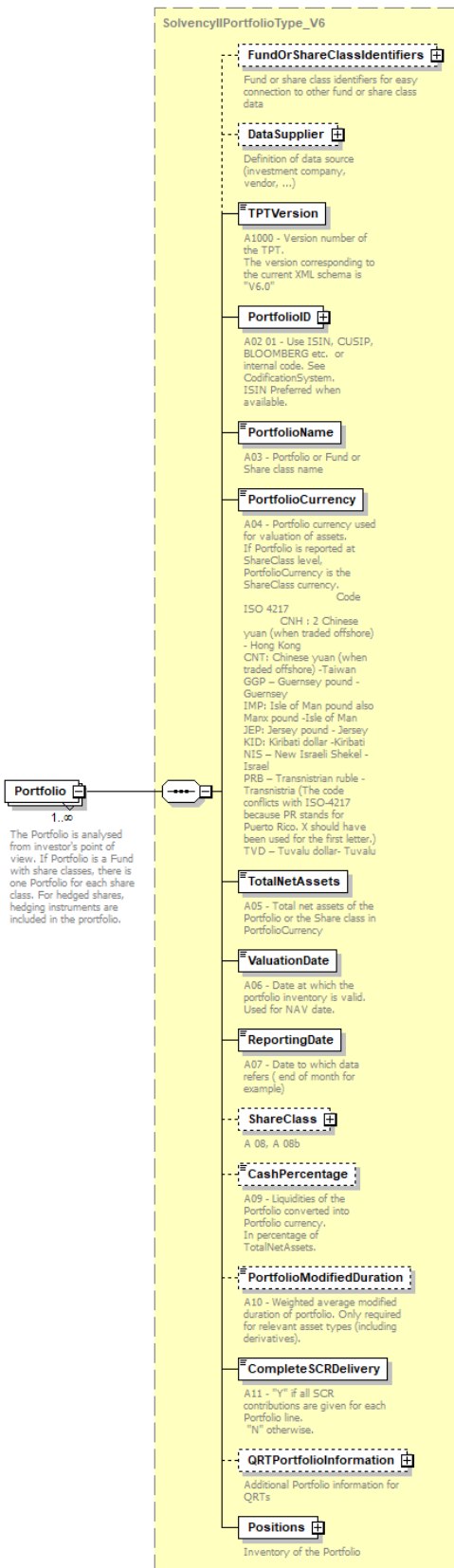

|            |  |
|------------|--|
| type       | <a href="#">SolvencyIIPortfolioType V6</a>   |
| properties | isRef 0<br>minOcc 1<br>maxOcc unbounded<br>content complex   |
| children   | <a href="#">FundOrShareClassIdentifiers</a> <a href="#">DataSupplier</a> <a href="#">TPTVersion</a> <a href="#">PortfolioID</a> <a href="#">PortfolioName</a> <a href="#">PortfolioCurrency</a> <a href="#">TotalNetAssets</a> <a href="#">ValuationDate</a> <a href="#">ReportingDate</a> <a href="#">ShareClass</a> <a href="#">CashPercentage</a> <a href="#">PortfolioModifiedDuration</a> <a href="#">CompleteSCRDelivery</a> <a href="#">QRTPortfolioInformation</a> <a href="#">Positions</a> |
| annotation | documentation<br>The Portfolio is analysed from investor's point of view. If Portfolio is a Fund with share classes, there is one Portfolio for each share class. For hedged shares, hedging instruments are included in the portfolio.  |

### simpleType **CICCodeType**

|            |  |
|------------|--|
| type       | restriction of <b>xs:string</b>  |
| properties | base <b>xs:string</b>  |
| used by    | elements <a href="#">SolvencyIIPortfolioType V6/QRTPortfolioInformation/FundCIC</a><br><a href="#">SolvencyIIPortfolioType/QRTPortfolioInformation/FundCIC</a><br><a href="#">SolvencyIIPortfolioType V5/QRTPortfolioInformation/FundCIC</a> <a href="#">SIIPositionType V6/InstrumentCIC</a><br><a href="#">SIIPositionType V6/DerivativeOrConvertible/UnderlyingInstrument/InstrumentCIC</a><br><a href="#">SIIPositionType/InstrumentCIC</a><br><a href="#">SIIPositionType/DerivativeOrConvertible/UnderlyingInstrument/InstrumentCIC</a><br><a href="#">SIIPositionType V5/InstrumentCIC</a><br><a href="#">SIIPositionType V5/DerivativeOrConvertible/UnderlyingInstrument/InstrumentCIC</a> |
| facets     | Kind Value annotation<br>minLength 4<br>maxLength 4<br>pattern <code>(([A-Z]{2})([A-F] [0-9]){1}){1-9}{1}</code>   |
| annotation | documentation<br>CIC code (4 positions) to identify a kind of security   |

### simpleType **CQSType**

|            |  |
|------------|--|
| type       | restriction of <b>xs:int</b>   |
| properties | base <b>xs:int</b>   |
| used by    | elements <a href="#">CreditRiskDataType V6/CreditQualityStep</a> <a href="#">CreditRiskDataType/CreditQualityStep</a><br><a href="#">CreditRiskDataType V5/CreditQualityStep</a> |
| facets     | Kind Value annotation<br>minInclusive 0<br>maxInclusive 9  |
| annotation | documentation<br>Credit Quality Step (Synthetic rating) 0 to 6 or 9 if no rating known.  |

### simpleType **EconomicArea2Type**

|            |   |
|------------|---|
| type       | restriction of <b>xs:int</b>  |
| properties | base <b>xs:int</b>  |
| used by    | elements <a href="#">CreditRiskDataType V6/EconomicArea</a> <a href="#">CreditRiskDataType/EconomicArea</a><br><a href="#">CreditRiskDataType V5/EconomicArea</a><br><a href="#">SolvencyIIPortfolioType/QRTPortfolioInformation/IssuerEconomicArea</a> |
| facets     | Kind Value annotation<br>minInclusive 1<br>maxInclusive 3   |

|            |   |
|------------|---|
| annotation | documentation<br>SII Economic area of a country |
|------------|---|

### simpleType **EconomicAreaType**

|            |  |
|------------|--|
| type       | restriction of <b>xs:int</b>   |
| properties | base <b>xs:int</b>   |
| used by    | elements <a href="#">SIIPositionType_V6/EconomicArea</a><br><a href="#">SIIPositionType_V6/DerivativeOrConvertible/UnderlyingInstrument/Valuation/EconomicArea</a><br><a href="#">SIIPositionType/EconomicArea</a><br><a href="#">SIIPositionType/DerivativeOrConvertible/UnderlyingInstrument/Valuation/EconomicArea</a><br><a href="#">SIIPositionType_V5/EconomicArea</a><br><a href="#">SIIPositionType_V5/DerivativeOrConvertible/UnderlyingInstrument/Valuation/EconomicArea</a> |
| facets     | Kind Value annotation<br>minInclusive 0<br>maxInclusive 3  |
| annotation | documentation<br>SII Economic area of a quotation place (including Non listed)   |

### simpleType **NACECodeType**

|            |  |
|------------|--|
| type       | restriction of <b>xs:string</b>  |
| properties | base <b>xs:string</b>  |
| used by    | elements <a href="#">SolvencyIIPortfolioType_V6/QRTPortfolioInformation/FundIssuer/EconomicSector</a><br><a href="#">SIIPositionType_V6/CreditRiskData/EconomicSector</a><br><a href="#">SolvencyIIPortfolioType/QRTPortfolioInformation/FundIssuer/EconomicSector</a><br><a href="#">SolvencyIIPortfolioType_V5/QRTPortfolioInformation/FundIssuer/EconomicSector</a><br><a href="#">SIIPositionType/CreditRiskData/EconomicSector</a> <a href="#">SIIPositionType_V5/CreditRiskData/EconomicSector</a> |
| facets     | Kind Value annotation<br>minLength 1<br>maxLength 7<br>pattern ([A-Z]{1}[0-9\.\.]{0,6})  |
| annotation | documentation<br>NACE European code (7 positions) to identify a kind of economic activity<br>appinfo<br><altova:exampleValues><br><altova:example value="A"/><br><altova:example value="C2.3.1"/><br><altova:example value="N78.1"/><br><altova:example value="N82.1.3"/><br></altova:exampleValues>   |

### simpleType **SIICouponFrequencyType**

|            |   |
|------------|---|
| type       | restriction of <b>xs:nonNegativeInteger</b>   |
| properties | base <b>xs:nonNegativeInteger</b>   |
| used by    | elements <a href="#">SIIPositionType_V6/InterestRateInstrumentCharacteristics/CouponFrequency</a><br><a href="#">SIIPositionType_V6/DerivativeOrConvertible/UnderlyingInstrument/Coupon/CouponFrequency</a><br><a href="#">SIIPositionType/InterestRateInstrumentCharacteristics/CouponFrequency</a><br><a href="#">SIIPositionType/DerivativeOrConvertible/UnderlyingInstrument/Coupon/CouponFrequency</a><br><a href="#">SIIPositionType_V5/InterestRateInstrumentCharacteristics/CouponFrequency</a><br><a href="#">SIIPositionType_V5/DerivativeOrConvertible/UnderlyingInstrument/Coupon/CouponFrequency</a> |
| annotation | documentation<br>Coupon Frequency: 0 other than 1 Annual, 2 Semestrial, 4 Quarterly, 12 Monthly   |

### simpleType **SIICouponFrequencyType\_V5**

|            |   |
|------------|---|
| type       | restriction of <b>xs:nonNegativeInteger</b>   |
| properties | base <b>xs:nonNegativeInteger</b>   |
| annotation | documentation<br>Coupon Frequency: 0 other than 1 Annual, 2 Semestrial, 4 Quarterly, 12 Monthly |

### simpleType **SIICouponFrequencyType\_V6**

|            |   |
|------------|---|
| type       | restriction of <b>xs:nonNegativeInteger</b>   |
| properties | base <b>xs:nonNegativeInteger</b>   |
| annotation | documentation<br>Coupon Frequency: 0 other than 1 Annual, 2 Semestrial, 4 Quarterly, 12 Monthly |

### simpleType **YesNoL1Type**

|            |   |
|------------|---|
| type       | restriction of <b>xs:string</b>   |
| properties | base <b>xs:string</b>   |
| used by    | elements <a href="#">SolvencyIIPortfolioType_V6/CompleteSCRDelivery</a> <a href="#">SolvencyIIPortfolioType/CompleteSCRDelivery</a> <a href="#">SolvencyIIPortfolioType_V5/CompleteSCRDelivery</a> <a href="#">CreditRiskDataType_V6/StateGuarantee</a> <a href="#">CreditRiskDataType/StateGuarantee</a> <a href="#">CreditRiskDataType_V5/StateGuarantee</a> <a href="#">SIIPositionType_V6/SubordinatedDebt</a> <a href="#">SIIPositionType/SubordinatedDebt</a> <a href="#">SIIPositionType_V5/SubordinatedDebt</a> |
| facets     | Kind Value annotation<br>minLength 1<br>maxLength 1   |
| annotation | documentation<br>Flag Y or N  |

### complexType **EFTReportType**

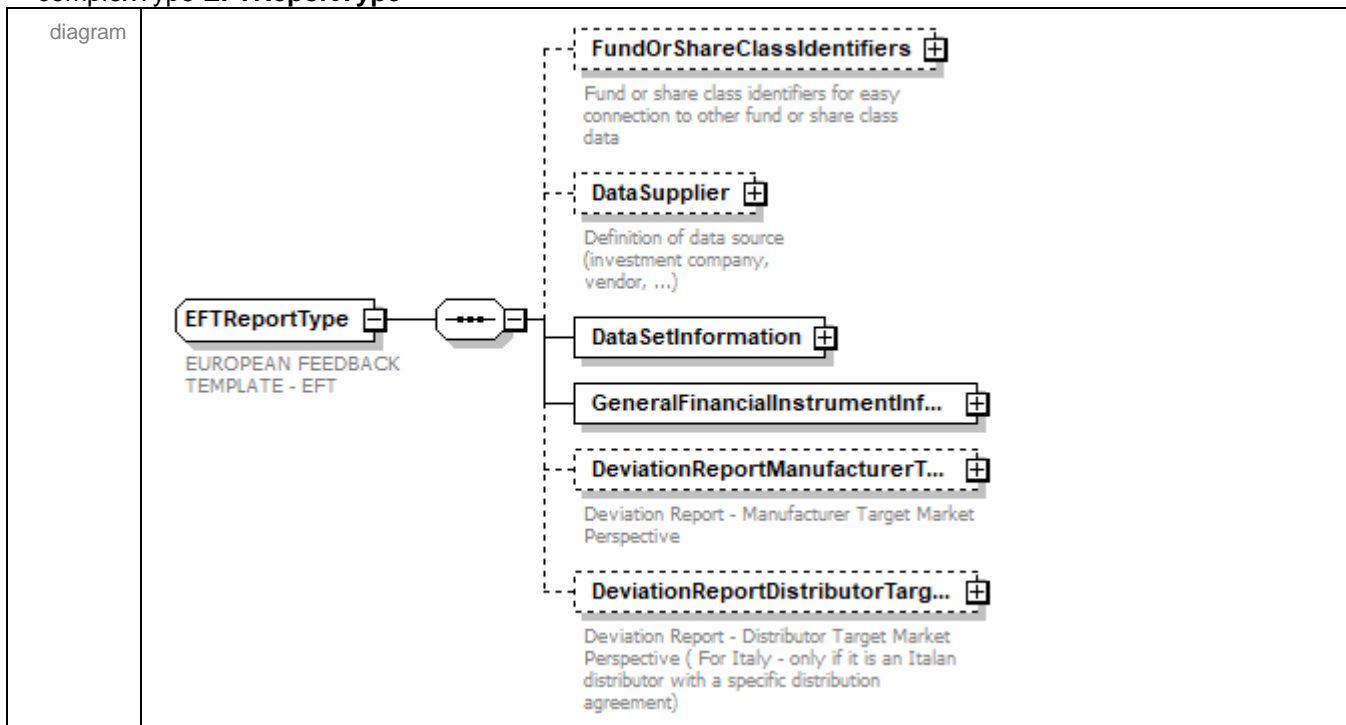



|            |   |
|------------|---|
| children   | <a href="#">FundOrShareClassIdentifiers</a> <a href="#">DataSetInformation</a> <a href="#">GeneralFinancialInstrumentInformation</a> <a href="#">DeviationReportManufacturerTargetMarketPerspective</a> <a href="#">DeviationReportDistributorTargetMarketPerspective</a> |
| used by    | element <a href="#">EFTType/EFT</a>   |
| annotation | documentation<br>EUROPEAN FEEDBACK TEMPLATE - EFT   |

element **EFTReportType/FundOrShareClassIdentifiers**

|            |  |
|------------|--|
| diagram    |  |
| type       | <a href="#">FundOrShareClassIdentifiersType</a>  |
| properties | isRef 0<br>minOcc 0<br>maxOcc 1<br>content complex   |
| children   | <a href="#">LEI</a> <a href="#">ISINs</a>  |
| annotation | documentation<br>Fund or share class identifiers for easy connection to other fund or share class data |

element **EFTReportType/DataSupplier**

|         |  |
|---------|--|
| diagram |  |
|---------|--|

|            |   |
|------------|---|
| type       | <a href="#">DataSupplierType</a>  |
| properties | isRef 0<br>minOcc 0<br>maxOcc 1<br>content complex  |
| children   | <a href="#">SystemCountry</a> <a href="#">Short Name</a> <a href="#">Type</a> <a href="#">Contact</a> |
| annotation | documentation<br>Definition of data source (investment company, vendor, ...)                          |

element **EFTReportType/DataSetInformation**

|            |  |
|------------|--|
| diagram    |  |
| properties | isRef 0<br>content complex   |
| children   | <a href="#">ReportInformationAndScope</a> <a href="#">SubmitterEntityInformation</a> <a href="#">ManufacturerEntityInformation</a> |

element **EFTReportType/DataSetInformation/ReportInformationAndScope**

|         |   |
|---------|---|
| diagram |   |
|         | <p><b>Version</b><br/>00010_EFT_Version<br/>Used Version of the EFT :<br/>V1 until further notice</p> <p><b>FileGeneration</b><br/>00020_File_Generation_Date_and_Time<br/>Date and Time of the creation of the EFT file</p> <p><b>PeriodStartData</b><br/>00030_Reporting_Period_Start_Data<br/>Date of beginning of the period under which distribution has occurred</p> <p><b>PeriodEndData</b><br/>00040_Reporting_Period_End_Data<br/>Date of end of the period under which distribution has occurred</p> <p><b>ReferenceTargetMarket</b><br/>00050_Reference_Target_Market<br/>Defines the reference Target Market to which deviations are reported<br/>M (Manufacturer) / D (Distributor) / B (Both)</p> |

|            |  |
|------------|--|
| properties | isRef 0<br>content complex   |
| children   | <a href="#">Version</a> <a href="#">FileGeneration</a> <a href="#">PeriodStartData</a> <a href="#">PeriodEndData</a> <a href="#">ReferenceTargetMarket</a> |

element **EFTReportType/DataSetInformation/ReportInformationAndScope/Version**

|            |   |
|------------|---|
| diagram    |   |
| type       | restriction of <b>xs:string</b>   |
| properties | isRef 0<br>content simple   |
| annotation | documentation<br>00010_EFT_Version<br>Used Version of the EFT : V1 until further notice |

element **EFTReportType/DataSetInformation/ReportInformationAndScope/FileGeneration**

|            |   |
|------------|---|
| diagram    |   |
| type       | <b>xs:dateTime</b>  |
| properties | isRef 0<br>content simple   |
| annotation | documentation<br>00020_File_Generation_Date_and_Time<br>Date and Time of the creation of the EFT file |

element **EFTReportType/DataSetInformation/ReportInformationAndScope/PeriodStartData**

|            |   |
|------------|---|
| diagram    |   |
| type       | <b>xs:date</b>  |
| properties | isRef 0<br>content simple   |
| annotation | documentation<br>00030_Reporting_Period_Start_Data<br>Date of beginning of the period under which distribution has occurred |

element **EFTReportType/DataSetInformation/ReportInformationAndScope/PeriodEndData**

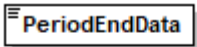
|            |  |
|------------|--|
| diagram    |  <p>00040_Reporting_Period_End_Data<br/>Date of end of the period under which distribution has occurred</p> |
| type       | <b>xs:date</b>   |
| properties | isRef 0<br>content simple  |
| annotation | documentation<br>00040_Reporting_Period_End_Data<br>Date of end of the period under which distribution has occurred  |

element **EFTReportType/DataSetInformation/ReportInformationAndScope/ReferenceTargetMarket**

|            |   |
|------------|---|
| diagram    |  <p>00050_Reference_Target_Market<br/>Defines the reference Target Market to which deviations are reported<br/>M (Manufacturer) / D (Distributor) / B (Both)</p> |
| type       | restriction of <b>xs:string</b>   |
| properties | isRef 0<br>content simple   |
| annotation | documentation<br>00050_Reference_Target_Market<br>Defines the reference Target Market to which deviations are reported<br>M (Manufacturer) / D (Distributor) / B (Both)   |

element **EFTReportType/DataSetInformation/SubmitterEntityInformation**

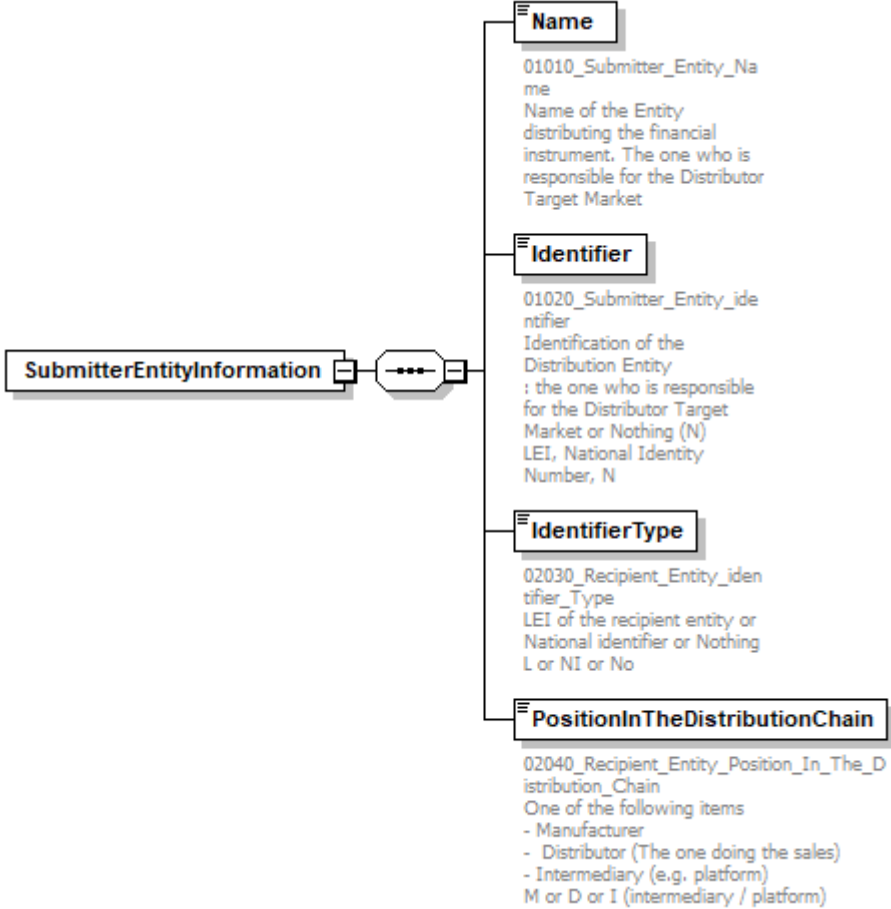
|                   |  |
|-------------------|--|
| <p>diagram</p>    |  <p>The diagram shows a box labeled <b>SubmitterEntityInformation</b> connected to four child elements:</p> <ul style="list-style-type: none"> <li><b>Name</b>: 01010_Submitter_Entity_Name. Name of the Entity distributing the financial instrument. The one who is responsible for the Distributor Target Market.</li> <li><b>Identifier</b>: 01020_Submitter_Entity_identifier. Identification of the Distribution Entity; the one who is responsible for the Distributor Target Market or Nothing (N). LEI, National Identity Number, N.</li> <li><b>IdentifierType</b>: 02030_Recipient_Entity_identifier_Type. LEI of the recipient entity or National identifier or Nothing L or NI or No.</li> <li><b>PositionInTheDistributionChain</b>: 02040_Recipient_Entity_Position_In_The_Distribution_Chain. One of the following items: <ul style="list-style-type: none"> <li>- Manufacturer</li> <li>- Distributor (The one doing the sales)</li> <li>- Intermediary (e.g. platform)</li> </ul> M or D or I (intermediary / platform) </li> </ul> |
| <p>properties</p> | <p>isRef 0<br/>content complex</p>   |
| <p>children</p>   | <p><a href="#">Name</a> <a href="#">Identifier</a> <a href="#">IdentifierType</a> <a href="#">PositionInTheDistributionChain</a></p>   |

element **EFTReportType/DataSetInformation/SubmitterEntityInformation/Name**

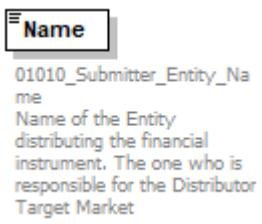
|                   |  |
|-------------------|--|
| <p>diagram</p>    |  <p>The diagram shows a box labeled <b>Name</b> with the following details:</p> <p>01010_Submitter_Entity_Name<br/>Name of the Entity distributing the financial instrument. The one who is responsible for the Distributor Target Market</p> |
| <p>type</p>       | <p>restriction of <b>xs:string</b></p>   |
| <p>properties</p> | <p>isRef 0<br/>content simple</p>  |
| <p>facets</p>     | <p>Kind Value annotation<br/>maxLength 255</p>   |
| <p>annotation</p> | <p>documentation<br/>01010_Submitter_Entity_Name<br/>Name of the Entity distributing the financial instrument. The one who is responsible for the Distributor Target Market</p>  |

element **EFTReportType/DataSetInformation/SubmitterEntityInformation/Identifier**

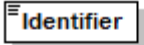
|            |  |
|------------|--|
| diagram    |  <p>01020_Submitter_Entity_ide<br/>ntifier<br/>Identification of the<br/>Distribution Entity<br/>: the one who is responsible<br/>for the Distributor Target<br/>Market or Nothing (N)<br/>LEI, National Identity<br/>Number, N</p> |
| type       | restriction of <b>xs:string</b>  |
| properties | isRef 0<br>content simple  |
| facets     | Kind Value annotation<br>maxLength 255   |
| annotation | documentation<br>01020_Submitter_Entity_identifier<br>Identification of the Distribution Entity<br>: the one who is responsible for the Distributor Target Market or Nothing (N)<br>LEI, National Identity Number, N   |

element **EFTReportType/DataSetInformation/SubmitterEntityInformation/IdentifierType**

|            |  |
|------------|--|
| diagram    |  <p>02030_Recipient_Entity_iden<br/>tifier_Type<br/>LEI of the recipient entity or<br/>National identifier or Nothing<br/>L or NI or No</p> |
| type       | restriction of <b>xs:string</b>  |
| properties | isRef 0<br>content simple  |
| annotation | documentation<br>02030_Recipient_Entity_identifier_Type<br>LEI of the recipient entity or National identifier or Nothing<br>L or NI or No  |

element  
**EFTReportType/DataSetInformation/SubmitterEntityInformation/PositionInTheDistributionChain**

|            |  |
|------------|--|
| diagram    |  <p>02040_Recipient_Entity_Position_In_The_D<br/>istribution_Chain<br/>One of the following items<br/>- Manufacturer<br/>- Distributor (The one doing the sales)<br/>- Intermediary (e.g. platform)<br/>M or D or I (intermediary / platform)</p> |
| type       | restriction of <b>xs:string</b>  |
| properties | isRef 0<br>content simple  |
| annotation | documentation<br>02040_Recipient_Entity_Position_In_The_Distribution_Chain<br>One of the following items   |

|  |   |
|--|---|
|  | <ul style="list-style-type: none"> <li>- Manufacturer</li> <li>- Distributor (The one doing the sales)</li> <li>- Intermediary (e.g. platform)</li> </ul> M or D or I (intermediary / platform) |
|--|---|

element **EFTReportType/DataSetInformation/ManufacturerEntityInformation**

|            |  |
|------------|--|
| diagram    |  |
| properties | isRef 0<br>content complex   |
| children   | <a href="#">Name</a> <a href="#">Identifier</a> <a href="#">IdentifierType</a> |

element **EFTReportType/DataSetInformation/ManufacturerEntityInformation/Name**

|            |   |
|------------|---|
| diagram    |   |
| type       | restriction of <b>xs:string</b>   |
| properties | isRef 0<br>content simple   |
| facets     | Kind Value annotation<br>maxLength 255  |
| annotation | documentation<br>03010_Manufacturer_Entity_Name<br>Name of the Entity producing the financial instrument. The one who is responsible for the Manufacturer Target Market |

element **EFTReportType/DataSetInformation/ManufacturerEntityInformation/Identifier**

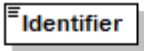
|            |  |
|------------|--|
| diagram    |  <p>03020_Manufacturer_identifi<br/>er<br/>Identification of the<br/>Manufacturer Entity<br/>LEI, National Identity<br/>Number, N</p> |
| type       | restriction of <b>xs:string</b>  |
| properties | isRef 0<br>content simple  |
| facets     | Kind Value annotation<br>maxLength 255   |
| annotation | documentation<br>03020_Manufacturer_identifier<br>Identification of the Manufacturer Entity<br>LEI, National Identity Number, N  |

element **EFTReportType/DataSetInformation/ManufacturerEntityInformation/IdentifierType**

|            |  |
|------------|--|
| diagram    |  <p>03030_Manufacturer_identifi<br/>er_Type<br/>LEI of the Manufacturer or<br/>National identifier or Nothing<br/>L or NI or No</p> |
| type       | restriction of <b>xs:string</b>  |
| properties | isRef 0<br>content simple  |
| annotation | documentation<br>03030_Manufacturer_identifier_Type<br>LEI of the Manufacturer or National identifier or Nothing<br>L or NI or No  |



element **EFTReportType/GeneralFinancialInstrumentInformation**

diagram

**GeneralFinancialInstrumentInf...**

**IdentifyingData**

04010\_Financial\_Instrument\_Identifying\_Data  
Identification of the financial instrument  
Use the following priority for identification of a specific financial instrument:  
- ISO 6166 code of ISIN when available  
- Other recognised codes (e.g.: CUSIP, Bloomberg Ticker, Reuters RIC)  
- Code attributed by the undertaking, when the options above are not available. Code must be unique and kept consistent over time.  
- blank if 04020 is set to 11

**TypeOfIdentification**

04020\_Type\_Of\_Identification\_Code\_For\_The\_Financial\_Instrument  
Codification chosen to identify the financial instrument or Aggregated Class of Products  
One of the options in the following closed list to be used:  
1 - ISO 6166 for ISIN code  
2 - CUSIP (The Committee on Uniform Securities Identification Procedures number assigned by the CUSIP Service Bureau for U.S. and Canadian companies)  
3 - SEDOL (Stock Exchange Daily Official List for the London Stock Exchange)  
4 - WKN (Wertpapier Kenn-Nummer, the alphanumeric German identification number)  
5 - Bloomberg Ticker (Bloomberg letters code that identify a company's securities)  
6 - BBGID (The Bloomberg Global ID)  
7 - Reuters RIC (Reuters instrument code)  
8 - FIGI (Financial Instrument Global Identifier)  
9 - Other code by members of the Association of National Numbering Agencies  
10 - LEI  
11 - Aggregated Class of products  
99 - Code attributed by the undertaking

**Name**

04030\_Financial\_Instrument\_Name  
Name of the financial instrument if applicable

**TotalNumberOfTransactions**

04040\_Financial\_Instrument\_Total\_Number\_Of\_Transactions  
Means total number of transactions expressed in absolute number. Includes volumes in Positive, Negative and outside of Positive.

|            |   |
|------------|---|
| properties | isRef 0<br>content complex  |
| children   | <a href="#">IdentifyingData</a> <a href="#">TypeOfIdentification</a> <a href="#">Name</a> <a href="#">TotalNumberOfTransactions</a> |

element **EFTReportType/GeneralFinancialInstrumentInformation/IdentifyingData**

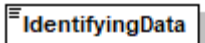
|            |   |
|------------|---|
| diagram    |  <p><b>IdentifyingData</b></p> <p>04010_Financial_Instrument_Identifying_Data<br/> Identification of the financial instrument<br/> Use the following priority for identification of a specific financial instrument:<br/> - ISO 6166 code of ISIN when available<br/> - Other recognised codes (e.g.: CUSIP, Bloomberg Ticker, Reuters RIC)<br/> - Code attributed by the undertaking, when the options above are not available. Code must be unique and kept consistent over time.<br/> - blank if 04020 is set to 11</p> |
| type       | restriction of <b>xs:string</b>   |
| properties | isRef 0<br>content simple   |
| facets     | Kind Value annotation<br>maxLength 255  |
| annotation | documentation<br><b>04010_Financial_Instrument_Identifying_Data</b><br>Identification of the financial instrument<br>Use the following priority for identification of a specific financial instrument:<br>- ISO 6166 code of ISIN when available<br>- Other recognised codes (e.g.: CUSIP, Bloomberg Ticker, Reuters RIC)<br>- Code attributed by the undertaking, when the options above are not available. Code must be unique and kept consistent over time.<br>- blank if 04020 is set to 11  |

element **EFTReportType/GeneralFinancialInstrumentInformation/TypeOfIdentification**

|                   |  |
|-------------------|--|
| <p>diagram</p>    | <div style="border: 1px solid black; padding: 2px; margin-bottom: 5px;"> <b>TypeOfIdentification</b> </div> <p>04020_Type_Of_Identification_Code_For_The_Financial_Instrument<br/> Codification chosen to identify the financial instrument or Aggregated Class of Products<br/> One of the options in the following closed list to be used:<br/> 1 - ISO 6166 for ISIN code<br/> 2 - CUSIP (The Committee on Uniform Securities Identification Procedures number assigned by the CUSIP Service Bureau for U.S. and Canadian companies)<br/> 3 - SEDOL (Stock Exchange Daily Official List for the London Stock Exchange)<br/> 4 - WKN (Wertpapier Kenn-Nummer, the alphanumeric German identification number)<br/> 5 - Bloomberg Ticker (Bloomberg letters code that identify a company's securities)<br/> 6 - BBGID (The Bloomberg Global ID)<br/> 7 - Reuters RIC (Reuters instrument code)<br/> 8 - FIGI (Financial Instrument Global Identifier)<br/> 9 - Other code by members of the Association of National Numbering Agencies<br/> 10 - LEI<br/> 11 - Aggregated Class of products<br/> 99 - Code attributed by the undertaking</p> |
| <p>type</p>       | <p>restriction of <b>xs:int</b></p>  |
| <p>properties</p> | <p>isRef 0<br/> content simple</p>   |
| <p>annotation</p> | <p>documentation<br/> 04020_Type_Of_Identification_Code_For_The_Financial_Instrument<br/> Codification chosen to identify the financial instrument or Aggregated Class of Products<br/> One of the options in the following closed list to be used:<br/> 1 - ISO 6166 for ISIN code<br/> 2 - CUSIP (The Committee on Uniform Securities Identification Procedures number assigned by the CUSIP Service Bureau for U.S. and Canadian companies)<br/> 3 - SEDOL (Stock Exchange Daily Official List for the London Stock Exchange)<br/> 4 - WKN (Wertpapier Kenn-Nummer, the alphanumeric German identification number)<br/> 5 - Bloomberg Ticker (Bloomberg letters code that identify a company's securities)<br/> 6 - BBGID (The Bloomberg Global ID)<br/> 7 - Reuters RIC (Reuters instrument code)<br/> 8 - FIGI (Financial Instrument Global Identifier)<br/> 9 - Other code by members of the Association of National Numbering Agencies<br/> 10 - LEI<br/> 11 - Aggregated Class of products<br/> 99 - Code attributed by the undertaking</p>  |

element **EFTReportType/GeneralFinancialInstrumentInformation/Name**

|            |  |
|------------|--|
| diagram    |  |
| type       | restriction of <b>xs:string</b>  |
| properties | isRef 0<br>content simple  |
| facets     | Kind Value annotation<br>maxLength 255   |
| annotation | documentation<br>04030_Financial_Instrument_Name<br>Name of the financial instrument if applicable |

element **EFTReportType/GeneralFinancialInstrumentInformation/TotalNumberOfTransactions**

|            |  |
|------------|--|
| diagram    |  |
| type       | <b>xs:int</b>  |
| properties | isRef 0<br>content simple  |
| annotation | documentation<br>04040_Financial_Instrument_Total_Number_Of_Transactions<br>Means total number of transactions expressed in absolute number. Includes volumes in Positive, Negative and outside of Positive. |

element **EFTReportType/DeviationReportManufacturerTargetMarketPerspective**

|            |  |
|------------|--|
| diagram    |  |
| properties | isRef 0<br>minOcc 0<br>maxOcc 1<br>content complex                         |
| children   | <a href="#">Sales_OTM_NTM</a> <a href="#">Widening</a>                     |
| annotation | documentation<br>Deviation Report - Manufacturer Target Market Perspective |

element **EFTReportType/DeviationReportManufacturerTargetMarketPerspective/Sales\_OTM\_NTM**

|                   |  |
|-------------------|--|
| <p>diagram</p>    | <p><b>Sales_OTM_NTM</b><br/>Sales Outside Target Market (OTM) and/or in Negative Target Market (NTM) - Reported as Number of Transactions</p> <p><b>RetailInvestorTypeAndSelfService</b><br/>05010_Retail_Investor_Type_AND_Self_Service<br/>Number of transactions reported as identified in conflict with Retail Investor Type, using MiFID services Execution Only or Self Service with Appropriateness Test<br/>If 00050 is set to M or B</p> <p><b>RetailInvestorTypeAndExecution...</b><br/>05020_Retail_Investor_Type_AND_Execution_With_Suitability_Test<br/>Number of transactions reported as identified in conflict with Retail Investor Type, using MiFID services Advice or Portfolio Management.</p> <p><b>KnowledgeAndExperienceAndS...</b><br/>05030_Knowledge_and_Experience_AND_Self_Service<br/>Number of transactions reported as identified in conflict with Knowledge and Experience, using MiFID services Execution Only or Self Service with Appropriateness Test.</p> <p><b>KnowledgeAndExperienceAndW...</b><br/>05040_Knowledge_and_Experience_AND_With_Suitability_Test<br/>Number of transactions reported as identified in conflict with Knowledge and Experience, using MiFID services Advice or Portfolio Management.</p> <p><b>AbilityToBearLossesAndWithSui...</b><br/>05050_Ability_To_Bear_Losses_AND_With_Suitability_Test_France<br/>Number of transactions reported as identified in conflict with Ability To Bear Losses, using MiFID services Advice or Portfolio Management.</p> |
| <p>properties</p> | <p>isRef 0<br/>minOcc 0<br/>maxOcc 1<br/>content complex</p>   |
| <p>children</p>   | <p><a href="#">RetailInvestorTypeAndSelfService</a> <a href="#">RetailInvestorTypeAndExecutionWithSuitabilityTest</a><br/><a href="#">KnowledgeAndExperienceAndSelfService</a> <a href="#">KnowledgeAndExperienceAndWithSuitabilityTest</a><br/><a href="#">AbilityToBearLossesAndWithSuitabilityTestFrance</a></p>  |
| <p>annotation</p> | <p>documentation<br/>Sales Outside Target Market (OTM) and/or in Negative Target Market (NTM) - Reported as Number of Transactions</p>   |

element

### EFTReportType/DeviationReportManufacturerTargetMarketPerspective/Sales\_OTM\_NTM/RetailInvestorTypeAndSelfService

|            |   |
|------------|---|
| diagram    |  <b>RetailInvestorTypeAndSelfService</b><br>05010_Retail_Investor_Type_AND_Self_Service<br>Number of transactions reported as identified in conflict with Retail Investor Type, using MiFID services Execution Only or Self Service with Appropriateness Test<br>If 00050 is set to M or B |
| type       | <b>xs:int</b>   |
| properties | isRef 0<br>minOcc 0<br>maxOcc 1<br>content simple   |
| annotation | documentation<br>05010_Retail_Investor_Type_AND_Self_Service<br>Number of transactions reported as identified in conflict with Retail Investor Type, using MiFID services Execution Only or Self Service with Appropriateness Test<br>If 00050 is set to M or B   |

element

### EFTReportType/DeviationReportManufacturerTargetMarketPerspective/Sales\_OTM\_NTM/RetailInvestorTypeAndExecutionWithSuitabilityTest

|            |  |
|------------|--|
| diagram    |  <b>RetailInvestorTypeAndExecution...</b><br>05020_Retail_Investor_Type_AND_Execution_With_Suitability_Test<br>Number of transactions reported as identified in conflict with Retail Investor Type, using MiFID services Advice or Portfolio Management. |
| type       | <b>xs:int</b>  |
| properties | isRef 0<br>minOcc 0<br>maxOcc 1<br>content simple  |
| annotation | documentation<br>05020_Retail_Investor_Type_AND_Execution_With_Suitability_Test<br>Number of transactions reported as identified in conflict with Retail Investor Type, using MiFID services Advice or Portfolio Management.   |

element

### EFTReportType/DeviationReportManufacturerTargetMarketPerspective/Sales\_OTM\_NTM/KnowledgeAndExperienceAndSelfService

|            |  |
|------------|--|
| diagram    |  <b>KnowledgeAndExperienceAndS...</b><br>05030_Knowledge_and_Experience_AND_Self_Service<br>Number of transactions reported as identified in conflict with Knowledge and Experience, using MiFID services Execution Only or Self Service with Appropriateness Test. |
| type       | <b>xs:int</b>  |
| properties | isRef 0<br>minOcc 0  |

|            |   |
|------------|---|
|            | maxOcc 1<br>content simple  |
| annotation | documentation<br>05030_Knowledge_and_Experience_AND_Self_Service<br>Number of transactions reported as identified in conflict with Knowledge and Experience, using MiFID services Execution Only or Self Service with Appropriateness Test. |

element

**EFTReportType/DeviationReportManufacturerTargetMarketPerspective/Sales\_OTM\_NTM/KnowledgeAndExperienceAndWithSuitabilityTest**

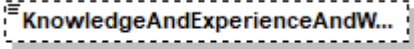

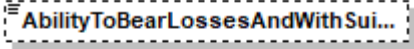

|            |   |
|------------|---|
| diagram    |  <p>05040_Knowledge_and_Experience_AND_With_Suitability_Test<br/>Number of transactions reported as identified in conflict with Knowledge and Experience, using MiFID services Advice or Portfolio Management.</p> |
| type       | <b>xs:int</b>   |
| properties | isRef 0<br>minOcc 0<br>maxOcc 1<br>content simple   |
| annotation | documentation<br>05040_Knowledge_and_Experience_AND_With_Suitability_Test<br>Number of transactions reported as identified in conflict with Knowledge and Experience, using MiFID services Advice or Portfolio Management.  |

element

**EFTReportType/DeviationReportManufacturerTargetMarketPerspective/Sales\_OTM\_NTM/AbilityToBearLossesAndWithSuitabilityTestFrance**

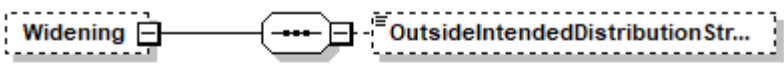
|            |  |
|------------|--|
| diagram    |  <p>05050_Ability_To_Bear_Losses_AND_With_Suitability_Test_France<br/>Number of transactions reported as identified in conflict with Ability To Bear Losses, using MiFID services Advice or Portfolio Management.</p> |
| type       | <b>xs:int</b>  |
| properties | isRef 0<br>minOcc 0<br>maxOcc 1<br>content simple  |
| annotation | documentation<br>05050_Ability_To_Bear_Losses_AND_With_Suitability_Test_France<br>Number of transactions reported as identified in conflict with Ability To Bear Losses, using MiFID services Advice or Portfolio Management.  |

element **EFTReportType/DeviationReportManufacturerTargetMarketPerspective/Widening**

|            |   |
|------------|---|
| diagram    |  <p><b>Widening</b>  —  —  <b>OutsideIntendedDistributionStr...</b></p> <p>Widening of Distribution Strategy Reporting Fields (ESMA para 51)</p> <p>06010_Outside_Intended_Distribution_Strategy_Retail_And_Self_Service<br/>In reference to ESMA Product Governance Guidelines Article 51 this field is used to disclose if the Distribution Strategy of the Distributor is widened in relation to the Distribution Strategy intended by the Manufacturer with regards to Retail Clients.</p> |
| properties | <p>isRef 0</p> <p>minOcc 0</p> <p>maxOcc 1</p> <p>content complex</p>   |
| children   | <a href="#">OutsideIntendedDistributionStrategyRetailAndSelfService</a>   |
| annotation | <p>documentation</p> <p>Widening of Distribution Strategy Reporting Fields (ESMA para 51)</p>   |

element **EFTReportType/DeviationReportManufacturerTargetMarketPerspective/Widening/OutsideIntendedDistributionStrategyRetailAndSelfService**

|            |   |
|------------|---|
| diagram    |  <p><b>OutsideIntendedDistributionStr...</b></p> <p>06010_Outside_Intended_Distribution_Strategy_Retail_And_Self_Service<br/>In reference to ESMA Product Governance Guidelines Article 51 this field is used to disclose if the Distribution Strategy of the Distributor is widened in relation to the Distribution Strategy intended by the Manufacturer with regards to Retail Clients.</p> |
| type       | restriction of <b>xs:string</b>   |
| properties | <p>isRef 0</p> <p>minOcc 0</p> <p>maxOcc 1</p> <p>content simple</p>  |
| annotation | <p>documentation</p> <p>06010_Outside_Intended_Distribution_Strategy_Retail_And_Self_Service<br/>In reference to ESMA Product Governance Guidelines Article 51 this field is used to disclose if the Distribution Strategy of the Distributor is widened in relation to the Distribution Strategy intended by the Manufacturer with regards to Retail Clients.</p>  |

element **EFTReportType/DeviationReportDistributorTargetMarketPerspective**

|            |  |
|------------|--|
| diagram    |  <p><b>DeviationReportDistributorTarg...</b>  —  —  <b>Sales_OTM_NTM</b> </p> <p>Deviation Report - Distributor Target Market Perspective ( For Italy - only if it is an Italian distributor with a specific distribution agreement)</p> |
| properties | <p>isRef 0</p> <p>minOcc 0</p> <p>maxOcc 1</p> <p>content complex</p>  |
| children   | <a href="#">Sales_OTM_NTM</a>  |
| annotation | <p>documentation</p> <p>Deviation Report - Distributor Target Market Perspective ( For Italy - only if it is an Italian distributor with a specific distribution agreement)</p>  |

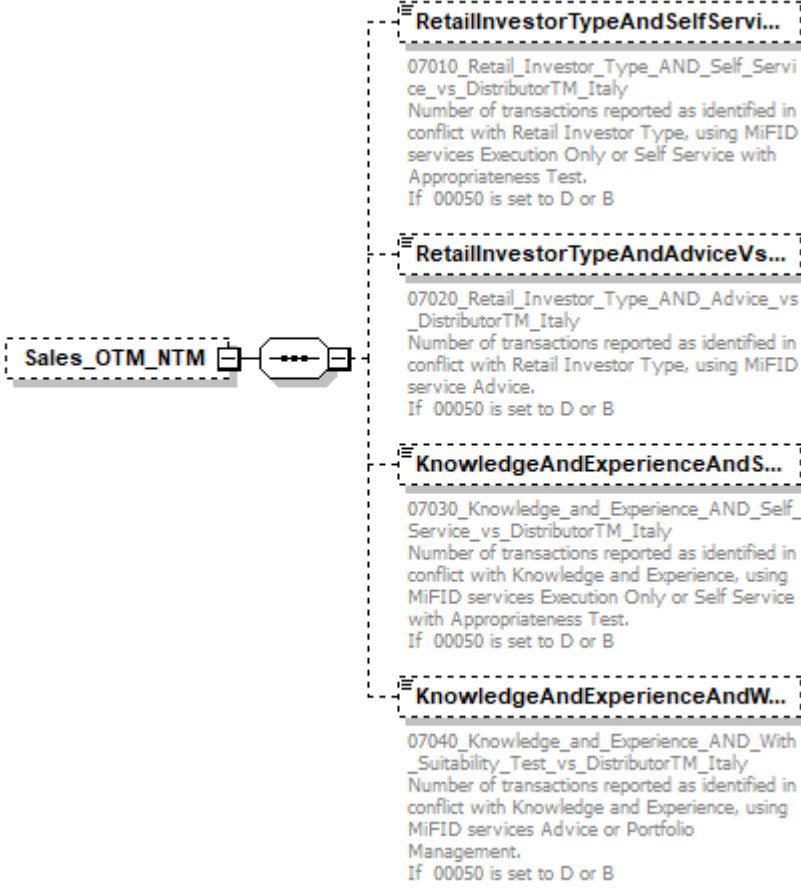

element **EFTReportType/DeviationReportDistributorTargetMarketPerspective/Sales\_OTM\_NTM**

|            |  |
|------------|--|
| diagram    |  <p><b>RetailInvestorTypeAndSelfServiceVsDistributorTM_Italy</b><br/>07010_Retail_Investor_Type_AND_Self_Service_vs_DistributorTM_Italy<br/>Number of transactions reported as identified in conflict with Retail Investor Type, using MiFID services Execution Only or Self Service with Appropriateness Test.<br/>If 00050 is set to D or B</p> <p><b>RetailInvestorTypeAndAdviceVsDistributorTM_Italy</b><br/>07020_Retail_Investor_Type_AND_Advice_vs_DistributorTM_Italy<br/>Number of transactions reported as identified in conflict with Retail Investor Type, using MiFID service Advice.<br/>If 00050 is set to D or B</p> <p><b>KnowledgeAndExperienceAndSelfServiceVsDistributorTM_Italy</b><br/>07030_Knowledge_and_Experience_AND_Self_Service_vs_DistributorTM_Italy<br/>Number of transactions reported as identified in conflict with Knowledge and Experience, using MiFID services Execution Only or Self Service with Appropriateness Test.<br/>If 00050 is set to D or B</p> <p><b>KnowledgeAndExperienceAndWithSuitabilityTestVsDistributorTM_Italy</b><br/>07040_Knowledge_and_Experience_AND_With_Suitability_Test_vs_DistributorTM_Italy<br/>Number of transactions reported as identified in conflict with Knowledge and Experience, using MiFID services Advice or Portfolio Management.<br/>If 00050 is set to D or B</p> |
| properties | <p>isRef 0<br/>minOcc 0<br/>maxOcc 1<br/>content complex</p>   |
| children   | <p><a href="#">RetailInvestorTypeAndSelfServiceVsDistributorTM_Italy</a> <a href="#">RetailInvestorTypeAndAdviceVsDistributorTM_Italy</a><br/><a href="#">KnowledgeAndExperienceAndSelfServiceVsDistributorTM_Italy</a><br/><a href="#">KnowledgeAndExperienceAndWithSuitabilityTestVsDistributorTM_Italy</a></p>  |

element **EFTReportType/DeviationReportDistributorTargetMarketPerspective/Sales\_OTM\_NTM/RetailInvestorTypeAndSelfServiceVsDistributorTM\_Italy**

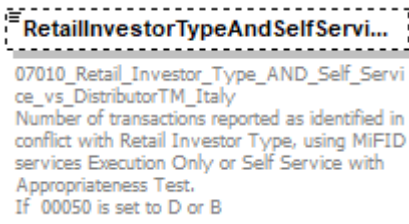
|         |  |
|---------|--|
| diagram |  <p><b>RetailInvestorTypeAndSelfServiceVsDistributorTM_Italy</b><br/>07010_Retail_Investor_Type_AND_Self_Service_vs_DistributorTM_Italy<br/>Number of transactions reported as identified in conflict with Retail Investor Type, using MiFID services Execution Only or Self Service with Appropriateness Test.<br/>If 00050 is set to D or B</p> |
| type    | <p><b>xs:int</b></p>   |

|            |   |
|------------|---|
| properties | isRef 0<br>minOcc 0<br>maxOcc 1<br>content simple   |
| annotation | documentation<br>07010_Retail_Investor_Type_AND_Self_Service_vs_DistributorTM_Italy<br>Number of transactions reported as identified in conflict with Retail Investor Type, using MiFID services Execution Only or Self Service with Appropriateness Test.<br>If 00050 is set to D or B |

element

**EFTReportType/DeviationReportDistributorTargetMarketPerspective/Sales\_OTM\_NTM/RetailInvestorTypeAndAdviceVsDistributorTM\_Italy**

|            |  |
|------------|--|
| diagram    |  <b>RetailInvestorTypeAndAdviceVs...</b><br>07020_Retail_Investor_Type_AND_Advice_vs_DistributorTM_Italy<br>Number of transactions reported as identified in conflict with Retail Investor Type, using MiFID service Advice.<br>If 00050 is set to D or B |
| type       | <b>xs:int</b>  |
| properties | isRef 0<br>minOcc 0<br>maxOcc 1<br>content simple  |
| annotation | documentation<br>07020_Retail_Investor_Type_AND_Advice_vs_DistributorTM_Italy<br>Number of transactions reported as identified in conflict with Retail Investor Type, using MiFID service Advice.<br>If 00050 is set to D or B   |

element

**EFTReportType/DeviationReportDistributorTargetMarketPerspective/Sales\_OTM\_NTM/KnowledgeAndExperienceAndSelfServiceVsDistributorTM\_Italy**

|            |  |
|------------|--|
| diagram    |  <b>KnowledgeAndExperienceAndS...</b><br>07030_Knowledge_and_Experience_AND_Self_Service_vs_DistributorTM_Italy<br>Number of transactions reported as identified in conflict with Knowledge and Experience, using MiFID services Execution Only or Self Service with Appropriateness Test.<br>If 00050 is set to D or B |
| type       | <b>xs:int</b>  |
| properties | isRef 0<br>minOcc 0<br>maxOcc 1<br>content simple  |
| annotation | documentation<br>07030_Knowledge_and_Experience_AND_Self_Service_vs_DistributorTM_Italy<br>Number of transactions reported as identified in conflict with Knowledge and Experience, using MiFID services Execution Only or Self Service with Appropriateness Test.<br>If 00050 is set to D or B  |

element

**EFTReportType/DeviationReportDistributorTargetMarketPerspective/Sales\_OTM\_NTM/KnowledgeAndExperienceAndWithSuitabilityTestVsDistributorTM\_Italy**

|            |  |
|------------|--|
| diagram    | <p>07040_Knowledge_and_Experience_AND_With_Suitability_Test_vs_DistributorTM_Italy<br/>         Number of transactions reported as identified in conflict with Knowledge and Experience, using MiFID services Advice or Portfolio Management.<br/>         If 00050 is set to D or B</p> |
| type       | <b>xs:int</b>  |
| properties | isRef 0<br>minOcc 0<br>maxOcc 1<br>content simple  |
| annotation | documentation<br>07040_Knowledge_and_Experience_AND_With_Suitability_Test_vs_DistributorTM_Italy<br>Number of transactions reported as identified in conflict with Knowledge and Experience, using MiFID services Advice or Portfolio Management.<br>If 00050 is set to D or B           |

**complexType EFTType**

|            |   |
|------------|---|
| diagram    | <p>EUROPEAN FEEDBACK TEMPLATE - EFT</p>           |
| children   | <a href="#">EFT</a>                               |
| used by    | element <a href="#">DirectReportingType/EFTs</a>  |
| annotation | documentation<br>EUROPEAN FEEDBACK TEMPLATE - EFT |

element **EFTType/EFT**

|                   |   |
|-------------------|---|
| <p>diagram</p>    | <p><b>EFTReportType</b></p> <ul style="list-style-type: none"> <li><b>FundOrShareClassIdentifiers</b> (+)             <p>Fund or share class identifiers for easy connection to other fund or share class data</p> </li> <li><b>DataSupplier</b> (+)             <p>Definition of data source (investment company, vendor, ...)</p> </li> <li><b>DataSetInformation</b> (+)</li> <li><b>GeneralFinancialInstrumentInf...</b> (+)</li> <li><b>DeviationReportManufacturerT...</b> (+)             <p>Deviation Report - Manufacturer Target Market Perspective</p> </li> <li><b>DeviationReportDistributorTarg...</b> (+)             <p>Deviation Report - Distributor Target Market Perspective ( For Italy - only if it is an Italian distributor with a specific distribution agreement)</p> </li> </ul> <p>EFT 1..∞</p> |
| <p>type</p>       | <p><a href="#">EFTReportType</a></p>  |
| <p>properties</p> | <p>isRef 0<br/>             minOcc 1<br/>             maxOcc unbounded<br/>             content complex</p>   |
| <p>children</p>   | <p><a href="#">FundOrShareClassIdentifiers</a> <a href="#">DataSupplier</a> <a href="#">DataSetInformation</a> <a href="#">GeneralFinancialInstrumentInformation</a> <a href="#">DeviationReportManufacturerTargetMarketPerspective</a> <a href="#">DeviationReportDistributorTargetMarketPerspective</a></p>   |

complexType **EETEnhancedExclusionType**

|          |  |
|----------|--|
| diagram  |  |
| children | <a href="#">Applied</a> <a href="#">ThresholdType</a> <a href="#">RelativeThreshold</a> <a href="#">PartOfValueChain</a> <a href="#">EnergyMixAbsoluteCap</a> <a href="#">EnergyMixRelativeCap</a> <a href="#">NewInfrastructure</a>   |
| used by  | elements <a href="#">EETReportType/ScreeningCriteria/SectorsBasedExclusions/CoalExclusion</a><br><a href="#">EETReportType/ScreeningCriteria/SectorsBasedExclusions/GasExclusion</a><br><a href="#">EETReportType/ScreeningCriteria/SectorsBasedExclusions/OilExclusion</a><br><a href="#">EETReportType/ScreeningCriteria/SectorsBasedExclusions/OtherFossilFuelExclusion</a> |

element **EETEnhancedExclusionType/Applied**

|            |                                    |
|------------|------------------------------------|
| diagram    |                                    |
| type       | <a href="#">EETYesNoType</a>       |
| properties | isRef 0<br>content simple          |
| facets     | Kind Value annotation<br>length 1  |
| annotation | documentation<br>Yes (Y) or No (N) |

element **EETEnhancedExclusionType/ThresholdType**

|            |   |
|------------|---|
| diagram    |   |
| type       | restriction of <b>xs:string</b>                   |
| properties | isRef 0<br>minOcc 0<br>maxOcc 1<br>content simple |

|            |   |
|------------|---|
| annotation | documentation<br>Revenue (R) or CaPEX (C) or Opex (O) |
|------------|---|

element **EETEnhancedExclusionType/RelativeThreshold**

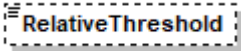
|            |   |
|------------|---|
| diagram    |  |
| type       | <b>xs:decimal</b>   |
| properties | isRef 0<br>minOcc 0<br>maxOcc 1<br>content simple                                 |

element **EETEnhancedExclusionType/PartOfValueChain**

|            |   |
|------------|---|
| diagram    |  |
| type       | restriction of <b>xs:string</b>   |
| properties | isRef 0<br>minOcc 0<br>maxOcc 1<br>content simple                                 |
| annotation | documentation<br>Upstream/Production/Downstream                                   |

element **EETEnhancedExclusionType/EnergyMixAbsoluteCap**

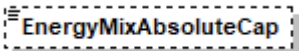
|            |   |
|------------|---|
| diagram    |  |
| type       | <b>xs:decimal</b>   |
| properties | isRef 0<br>minOcc 0<br>maxOcc 1<br>content simple                                   |

element **EETEnhancedExclusionType/EnergyMixRelativeCap**

|            |   |
|------------|---|
| diagram    |  |
| type       | <b>xs:decimal</b>   |
| properties | isRef 0<br>minOcc 0<br>maxOcc 1<br>content simple                                   |

element **EETEnhancedExclusionType/NewInfrastructure**

|            |   |
|------------|---|
| diagram    |   |
| type       | <a href="#">EETYesNoType</a>                      |
| properties | isRef 0<br>minOcc 0<br>maxOcc 1<br>content simple |
| facets     | Kind Value annotation<br>length 1                 |
| annotation | documentation<br>Yes (Y) or No (N)                |

complexType **EETEnhancedExclusionType1.1**

|          |  |
|----------|--|
| diagram  |  |
| children | <a href="#">Applied</a> <a href="#">ThresholdType</a> <a href="#">RelativeThreshold</a> <a href="#">PartOfValueChain</a> <a href="#">EnergyMixAbsoluteCap</a> <a href="#">EnergyMixRelativeCap</a> <a href="#">NewInfrastructure</a>   |
| used by  | elements <ul style="list-style-type: none"> <li><a href="#">EETReportType1.1/ScreeningCriteria/SectorsBasedExclusions/CoalExclusion</a></li> <li><a href="#">EETReportType1.1.1/ScreeningCriteria/SectorsBasedExclusions/CoalExclusion</a></li> <li><a href="#">EETReportType1.1.2/ScreeningCriteria/SectorsBasedExclusions/CoalExclusion</a></li> <li><a href="#">EETReportType1.1/ScreeningCriteria/SectorsBasedExclusions/GasExclusion</a></li> <li><a href="#">EETReportType1.1.1/ScreeningCriteria/SectorsBasedExclusions/GasExclusion</a></li> <li><a href="#">EETReportType1.1.2/ScreeningCriteria/SectorsBasedExclusions/GasExclusion</a></li> <li><a href="#">EETReportType1.1/ScreeningCriteria/SectorsBasedExclusions/OilExclusion</a></li> <li><a href="#">EETReportType1.1.1/ScreeningCriteria/SectorsBasedExclusions/OilExclusion</a></li> <li><a href="#">EETReportType1.1.2/ScreeningCriteria/SectorsBasedExclusions/OilExclusion</a></li> <li><a href="#">EETReportType1.1/ScreeningCriteria/SectorsBasedExclusions/OtherFossilFuelExclusion</a></li> <li><a href="#">EETReportType1.1.1/ScreeningCriteria/SectorsBasedExclusions/OtherFossilFuelExclusion</a></li> <li><a href="#">EETReportType1.1.2/ScreeningCriteria/SectorsBasedExclusions/OtherFossilFuelExclusion</a></li> </ul> |

element **EETEnhancedExclusionType1.1/Applied**

|            |   |
|------------|---|
| diagram    |  |
| type       | <a href="#">EETYesNoType</a>  |
| properties | isRef 0<br>content simple   |
| facets     | Kind Value annotation<br>length 1   |
| annotation | documentation<br>Yes (Y) or No (N)  |

element **EETEnhancedExclusionType1.1/ThresholdType**

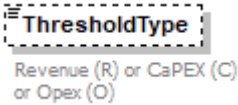
|            |   |
|------------|---|
| diagram    |  |
| type       | restriction of <b>xs:string</b>   |
| properties | isRef 0<br>minOcc 0<br>maxOcc 1<br>content simple                                 |
| annotation | documentation<br>Revenue (R) or CaPEX (C) or Opex (O)                             |

element **EETEnhancedExclusionType1.1/RelativeThreshold**

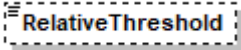
|            |   |
|------------|---|
| diagram    |  |
| type       | <b>xs:decimal</b>   |
| properties | isRef 0<br>minOcc 0<br>maxOcc 1<br>content simple                                   |

element **EETEnhancedExclusionType1.1/PartOfValueChain**

|            |   |
|------------|---|
| diagram    |  |
| type       | restriction of <b>xs:string</b>   |
| properties | isRef 0<br>minOcc 0<br>maxOcc 1<br>content simple                                   |
| annotation | documentation<br>Upstream/Production/Downstream                                     |



element **EETEnhancedExclusionType1.1/EnergyMixAbsoluteCap**

|            |   |
|------------|---|
| diagram    |   |
| type       | <b>xs:decimal</b>                                 |
| properties | isRef 0<br>minOcc 0<br>maxOcc 1<br>content simple |

element **EETEnhancedExclusionType1.1/EnergyMixRelativeCap**

|            |   |
|------------|---|
| diagram    |   |
| type       | <b>xs:decimal</b>                                 |
| properties | isRef 0<br>minOcc 0<br>maxOcc 1<br>content simple |

element **EETEnhancedExclusionType1.1/NewInfrastructure**

|            |   |
|------------|---|
| diagram    |   |
| type       | <a href="#">EETYesNoType</a>                      |
| properties | isRef 0<br>minOcc 0<br>maxOcc 1<br>content simple |
| facets     | Kind Value annotation<br>length 1                 |
| annotation | documentation<br>Yes (Y) or No (N)                |

complexType **EETExclusionType**

|          |  |
|----------|--|
| diagram  |  |
| children | <a href="#">Applied</a> <a href="#">ThresholdType</a> <a href="#">RelativeThreshold</a> <a href="#">PartOfValueChain</a> |

|         |   |
|---------|---|
| used by | elements<br><a href="#">EETReportType/ScreeningCriteria/SectorsBasedExclusions/AlcoholExclusion</a><br><a href="#">EETReportType/ScreeningCriteria/SectorsBasedExclusions/AnimalTestingExclusion</a><br><a href="#">EETReportType/ScreeningCriteria/SectorsBasedExclusions/CannabisExclusion</a><br><a href="#">EETReportType/ScreeningCriteria/SectorsBasedExclusions/ConventionalWeaponsExclusion</a><br><a href="#">EETReportType/ScreeningCriteria/SectorsBasedExclusions/FactoryFarmingExclusion</a><br><a href="#">EETReportType/ScreeningCriteria/SectorsBasedExclusions/FurExclusion</a><br><a href="#">EETReportType/ScreeningCriteria/SectorsBasedExclusions/GamblingExclusion</a><br><a href="#">EETReportType/ScreeningCriteria/SectorsBasedExclusions/GeneticallyModifiedOrganismsExclusion</a><br><a href="#">EETReportType/ScreeningCriteria/SectorsBasedExclusions/GeneticEngineeringExclusion</a><br><a href="#">EETReportType/ScreeningCriteria/SectorsBasedExclusions/NuclearEnergyExclusion</a><br><a href="#">EETReportType/ScreeningCriteria/SectorsBasedExclusions/NuclearWeaponsExclusion</a><br><a href="#">EETReportType/ScreeningCriteria/SectorsBasedExclusions/PalmOilExclusion</a><br><a href="#">EETReportType/ScreeningCriteria/SectorsBasedExclusions/PesticidesExclusion</a><br><a href="#">EETReportType/ScreeningCriteria/SectorsBasedExclusions/PornographyAdultEntertainmentServicesExclusion</a><br><a href="#">EETReportType/ScreeningCriteria/SectorsBasedExclusions/ResearchOnHumanEmbryosExclusion</a><br><a href="#">EETReportType/ScreeningCriteria/SectorsBasedExclusions/TobaccoExclusion</a><br><a href="#">EETReportType/ScreeningCriteria/SectorsBasedExclusions/UnconventionalWeaponsExclusion</a> |
|---------|---|

element **EETExclusionType/Applied**

|            |   |
|------------|---|
| diagram    |  |
| type       | <a href="#">EETYesNoType</a>  |
| properties | isRef 0<br>content simple   |
| facets     | Kind Value annotation<br>length 1   |
| annotation | documentation<br>Yes (Y) or No (N)  |

element **EETExclusionType/ThresholdType**

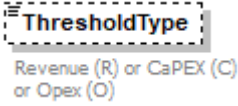
|            |   |
|------------|---|
| diagram    |  |
| type       | restriction of <b>xs:string</b>   |
| properties | isRef 0<br>minOcc 0<br>maxOcc 1<br>content simple                                   |
| annotation | documentation<br>Revenue (R) or CaPEX (C) or Opex (O)                               |

element **EETExclusionType/RelativeThreshold**

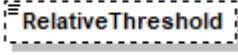
|            |   |
|------------|---|
| diagram    |  |
| type       | <b>xs:decimal</b>   |
| properties | isRef 0<br>minOcc 0<br>maxOcc 1<br>content simple                                   |

element **EETExclusionType/PartOfValueChain**

|            |   |
|------------|---|
| diagram    |   |
| type       | restriction of <b>xs:string</b>                   |
| properties | isRef 0<br>minOcc 0<br>maxOcc 1<br>content simple |
| annotation | documentation<br>Upstream/Production/Downstream   |

complexType **EETExclusionType1.1**

|          |   |
|----------|---|
| diagram  |   |
| children | <a href="#">Applied</a> <a href="#">ThresholdType</a> <a href="#">RelativeThreshold</a> <a href="#">PartOfValueChain</a>  |
| used by  | elements<br><a href="#">EETReportType1.1/ScreeningCriteria/SectorsBasedExclusions/AlcoholExclusion</a><br><a href="#">EETReportType1.2/ScreeningCriteria/SectorsBasedExclusions/AlcoholExclusion</a><br><a href="#">EETReportType1.1.1/ScreeningCriteria/SectorsBasedExclusions/AlcoholExclusion</a><br><a href="#">EETReportType1.1/ScreeningCriteria/SectorsBasedExclusions/AnimalTestingExclusion</a><br><a href="#">EETReportType1.1.2/ScreeningCriteria/SectorsBasedExclusions/AnimalTestingExclusion</a><br><a href="#">EETReportType1.1.1/ScreeningCriteria/SectorsBasedExclusions/AnimalTestingExclusion</a><br><a href="#">EETReportType1.1/ScreeningCriteria/SectorsBasedExclusions/CannabisExclusion</a><br><a href="#">EETReportType1.2/ScreeningCriteria/SectorsBasedExclusions/CannabisExclusion</a><br><a href="#">EETReportType1.1.1/ScreeningCriteria/SectorsBasedExclusions/CannabisExclusion</a><br><a href="#">EETReportType1.1/ScreeningCriteria/SectorsBasedExclusions/ConventionalWeaponsExclusion</a><br><a href="#">EETReportType1.2/ScreeningCriteria/SectorsBasedExclusions/ConventionalWeaponsExclusion</a><br><a href="#">EETReportType1.1.1/ScreeningCriteria/SectorsBasedExclusions/ConventionalWeaponsExclusion</a><br><a href="#">EETReportType1.1/ScreeningCriteria/SectorsBasedExclusions/FactoryFarmingExclusion</a><br><a href="#">EETReportType1.1.2/ScreeningCriteria/SectorsBasedExclusions/FactoryFarmingExclusion</a><br><a href="#">EETReportType1.1.1/ScreeningCriteria/SectorsBasedExclusions/FactoryFarmingExclusion</a><br><a href="#">EETReportType1.1/ScreeningCriteria/SectorsBasedExclusions/FurExclusion</a><br><a href="#">EETReportType1.2/ScreeningCriteria/SectorsBasedExclusions/FurExclusion</a><br><a href="#">EETReportType1.1.1/ScreeningCriteria/SectorsBasedExclusions/FurExclusion</a><br><a href="#">EETReportType1.1/ScreeningCriteria/SectorsBasedExclusions/GamblingExclusion</a><br><a href="#">EETReportType1.1.1/ScreeningCriteria/SectorsBasedExclusions/GamblingExclusion</a><br><a href="#">EETReportType1.1.2/ScreeningCriteria/SectorsBasedExclusions/GamblingExclusion</a><br><a href="#">EETReportType1.1/ScreeningCriteria/SectorsBasedExclusions/GeneticallyModifiedOrganismsExclusion</a><br><a href="#">EETReportType1.1.1/ScreeningCriteria/SectorsBasedExclusions/GeneticallyModifiedOrganismsExclusion</a><br><a href="#">EETReportType1.2/ScreeningCriteria/SectorsBasedExclusions/GeneticallyModifiedOrganismsExclusion</a><br><a href="#">EETReportType1.1.1/ScreeningCriteria/SectorsBasedExclusions/GeneticEngineeringExclusion</a><br><a href="#">EETReportType1.1/ScreeningCriteria/SectorsBasedExclusions/GeneticEngineeringExclusion</a><br><a href="#">EETReportType1.1.2/ScreeningCriteria/SectorsBasedExclusions/GeneticEngineeringExclusion</a><br><a href="#">EETReportType1.1/ScreeningCriteria/SectorsBasedExclusions/NuclearEnergyExclusion</a><br><a href="#">EETReportType1.2/ScreeningCriteria/SectorsBasedExclusions/NuclearEnergyExclusion</a> |

|  |  |
|--|--|
|  | <a href="#">EETReportType1.1.1/ScreeningCriteria/SectorsBasedExclusions/NuclearEnergyExclusion</a><br><a href="#">EETReportType1.1/ScreeningCriteria/SectorsBasedExclusions/NuclearWeaponsExclusion</a><br><a href="#">EETReportType1.1.1/ScreeningCriteria/SectorsBasedExclusions/NuclearWeaponsExclusion</a><br><a href="#">EETReportType1.1.2/ScreeningCriteria/SectorsBasedExclusions/NuclearWeaponsExclusion</a><br><a href="#">EETReportType1.1.1/ScreeningCriteria/SectorsBasedExclusions/PalmOilExclusion</a><br><a href="#">EETReportType1.1/ScreeningCriteria/SectorsBasedExclusions/PalmOilExclusion</a><br><a href="#">EETReportType1.1.2/ScreeningCriteria/SectorsBasedExclusions/PalmOilExclusion</a><br><a href="#">EETReportType1.1/ScreeningCriteria/SectorsBasedExclusions/PesticidesExclusion</a><br><a href="#">EETReportType1.1.2/ScreeningCriteria/SectorsBasedExclusions/PesticidesExclusion</a><br><a href="#">EETReportType1.1.2/ScreeningCriteria/SectorsBasedExclusions/PornographyAdultEntertainmentServicesExclusion</a><br><a href="#">EETReportType1.1/ScreeningCriteria/SectorsBasedExclusions/PornographyAdultEntertainmentServicesExclusion</a><br><a href="#">EETReportType1.1.1/ScreeningCriteria/SectorsBasedExclusions/PornographyAdultEntertainmentServicesExclusion</a><br><a href="#">EETReportType1.1.1/ScreeningCriteria/SectorsBasedExclusions/ResearchOnHumanEmbryosExclusion</a><br><a href="#">EETReportType1.1/ScreeningCriteria/SectorsBasedExclusions/ResearchOnHumanEmbryosExclusion</a><br><a href="#">EETReportType1.1.2/ScreeningCriteria/SectorsBasedExclusions/ResearchOnHumanEmbryosExclusion</a><br><a href="#">EETReportType1.1.1/ScreeningCriteria/SectorsBasedExclusions/TobaccoExclusion</a><br><a href="#">EETReportType1.1/ScreeningCriteria/SectorsBasedExclusions/TobaccoExclusion</a><br><a href="#">EETReportType1.1.2/ScreeningCriteria/SectorsBasedExclusions/TobaccoExclusion</a><br><a href="#">EETReportType1.1.1/ScreeningCriteria/SectorsBasedExclusions/UnconventionalWeaponsExclusion</a><br><a href="#">EETReportType1.1/ScreeningCriteria/SectorsBasedExclusions/UnconventionalWeaponsExclusion</a><br><a href="#">EETReportType1.1.2/ScreeningCriteria/SectorsBasedExclusions/UnconventionalWeaponsExclusion</a> |
|--|--|

element **EETExclusionType1.1/Applied**

|            |  |
|------------|--|
| diagram    |  <p>Yes (Y) or No (N)</p> |
| type       | <a href="#">EETYesNoType</a>   |
| properties | isRef 0<br>content simple  |
| facets     | Kind Value annotation<br>length 1  |
| annotation | documentation<br>Yes (Y) or No (N)   |

element **EETExclusionType1.1/ThresholdType**

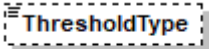
|            |   |
|------------|---|
| diagram    |  <p>Revenue (R) or CaPEX (C)<br/>or Opex (O)</p> |
| type       | restriction of <b>xs:string</b>   |
| properties | isRef 0<br>minOcc 0<br>maxOcc 1<br>content simple   |
| annotation | documentation<br>Revenue (R) or CaPEX (C) or Opex (O)   |

element **EETExclusionType1.1/RelativeThreshold**

|         |   |
|---------|---|
| diagram |  |
|---------|---|

|            |   |
|------------|---|
| type       | <b>xs:decimal</b>                                 |
| properties | isRef 0<br>minOcc 0<br>maxOcc 1<br>content simple |

element **EETExclusionType1.1/PartOfValueChain**

|            |   |
|------------|---|
| diagram    |   |
| type       | <b>restriction of xs:string</b>                           |
| properties | isRef 0<br>minOcc 0<br>maxOcc unbounded<br>content simple |
| annotation | documentation<br>Upstream/Production/Downstream           |

complexType **EETReportType**

diagram

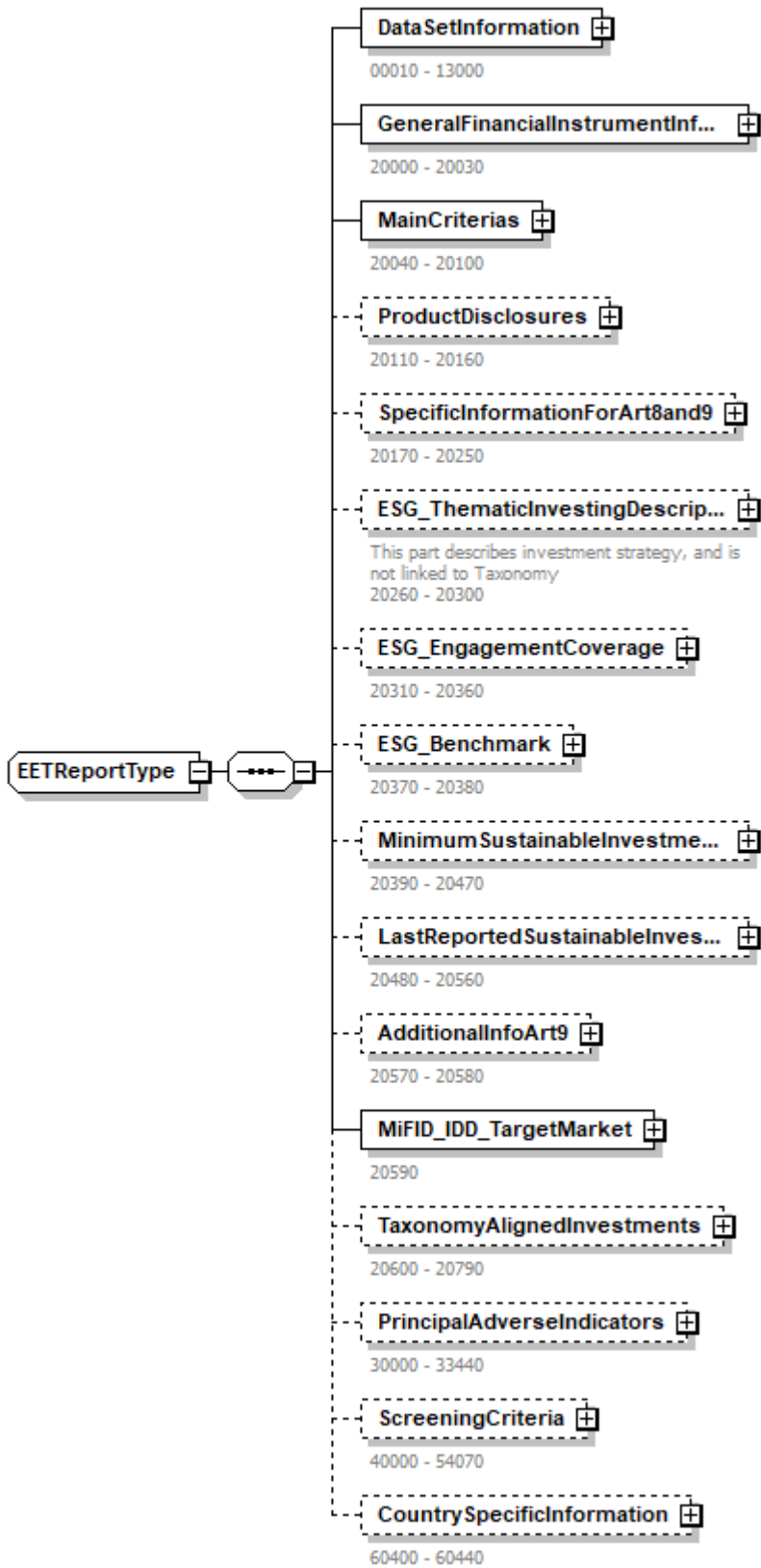

|          |   |
|----------|---|
| children | <a href="#">DataSetInformation</a> <a href="#">GeneralFinancialInstrumentInformation</a> <a href="#">MainCriteria</a> <a href="#">ProductDisclosures</a> <a href="#">SpecificInformationForArt8and9</a> <a href="#">ESG</a> <a href="#">ThematicInvestingDescription</a> <a href="#">ESG</a> <a href="#">EngagementCoverage</a> <a href="#">ESG</a> <a href="#">Benchmark</a> <a href="#">MinimumSustainableInvestments</a> <a href="#">LastReportedSustainableInvestments</a> <a href="#">AdditionalInfoArt9</a> <a href="#">MiFID</a> <a href="#">IDD</a> <a href="#">TargetMarket</a> <a href="#">TaxonomyAlignedInvestments</a> <a href="#">PrincipalAdverseIndicators</a> <a href="#">ScreeningCriteria</a> <a href="#">CountrySpecificInformation</a> |
| used by  | element <a href="#">EETsType/EET</a>  |

element **EETReportType/DataSetInformation**

|            |  |
|------------|--|
| diagram    |  |
| properties | isRef 0<br>content complex   |
| children   | <a href="#">DataSetInformation</a> <a href="#">ManufacturerInformation</a> <a href="#">ManufacturerCommitmentToResponsibleInvestment</a> <a href="#">ManufacturerStewardshipCodeSignatory</a> <a href="#">ManufacturerWebsiteInformationStewardshipAndEngagement</a> |
| annotation | documentation<br>00010 - 13000   |

element **EETReportType/DataSetInformation/DataSetInformation**

|            |   |
|------------|---|
| diagram    | <p>The diagram illustrates the structure of the <b>DataSetInformation</b> element (00010 - 00100). It is a complex container that includes four sub-elements:</p> <ul style="list-style-type: none"> <li><b>Version</b>: This field specifies the output version of the template and is used by the recipient to understand the number of fields expected, their labeling and order.</li> <li><b>Producer</b> (00020 - 00040): A complex element containing three sub-fields:             <ul style="list-style-type: none"> <li>00020_EET_Producer_Name</li> <li>00030_EET_Producer_LEI</li> <li>00040_EET_Producer_Email</li> </ul> </li> <li><b>FileGeneration</b> (00050): Contains the field 00050_EET_File_Generation_Date_And_Time, representing the Date and Time of the creation of the EET file.</li> <li><b>DataReporting</b> (00060 - 00100): A complex element.</li> </ul> |
| properties | <p>isRef 0<br/>content complex</p>  |
| children   | <p><a href="#">Version</a> <a href="#">Producer</a> <a href="#">FileGeneration</a> <a href="#">DataReporting</a></p>  |
| annotation | <p>documentation<br/>00010 - 00100</p>  |

element **EETReportType/DataSetInformation/DataSetInformation/Version**

|            |  |
|------------|--|
| diagram    | <p>The diagram shows the <b>Version</b> element. Its documentation states: "This field specifies the output version of the template and is used by the recipient to understand the number of fields expected, their labeling and order."</p> |
| type       | <p>restriction of <b>xs:string</b></p>   |
| properties | <p>isRef 0<br/>content simple</p>  |
| annotation | <p>documentation<br/>This field specifies the output version of the template and is used by the recipient to understand the number of fields expected, their labeling and order.</p>   |



element **EETReportType/DataSetInformation/DataSetInformation/Producer**

|            |  |
|------------|--|
| diagram    |  |
| properties | isRef 0<br>minOcc 0<br>maxOcc 1<br>content complex   |
| children   | <a href="#">Name</a> <a href="#">LEI</a> <a href="#">Email</a>                                 |
| annotation | documentation<br>00020_EET_Producer_Name<br>00030_EET_Producer_LEI<br>00040_EET_Producer_Email |

element **EETReportType/DataSetInformation/DataSetInformation/Producer/Name**

|            |   |
|------------|---|
| diagram    |   |
| type       | <b>xs:string</b>                                  |
| properties | isRef 0<br>minOcc 0<br>maxOcc 1<br>content simple |
| annotation | documentation<br>00020_EET_Producer_Name          |

element **EETReportType/DataSetInformation/DataSetInformation/Producer/LEI**

|            |  |            |       |            |           |    |  |           |    |  |         |                           |  |
|------------|--|------------|-------|------------|-----------|----|--|-----------|----|--|---------|---------------------------|--|
| diagram    |  |            |       |            |           |    |  |           |    |  |         |                           |  |
| type       | <a href="#">LEICodeType</a>  |            |       |            |           |    |  |           |    |  |         |                           |  |
| properties | isRef 0<br>minOcc 0<br>maxOcc 1<br>content simple  |            |       |            |           |    |  |           |    |  |         |                           |  |
| facets     | <table border="0"> <tr> <td>Kind</td> <td>Value</td> <td>annotation</td> </tr> <tr> <td>minLength</td> <td>20</td> <td></td> </tr> <tr> <td>maxLength</td> <td>20</td> <td></td> </tr> <tr> <td>pattern</td> <td>([0-9a-zA-Z]{18}[0-9]{2})</td> <td></td> </tr> </table> | Kind       | Value | annotation | minLength | 20 |  | maxLength | 20 |  | pattern | ([0-9a-zA-Z]{18}[0-9]{2}) |  |
| Kind       | Value  | annotation |       |            |           |    |  |           |    |  |         |                           |  |
| minLength  | 20   |            |       |            |           |    |  |           |    |  |         |                           |  |
| maxLength  | 20   |            |       |            |           |    |  |           |    |  |         |                           |  |
| pattern    | ([0-9a-zA-Z]{18}[0-9]{2})  |            |       |            |           |    |  |           |    |  |         |                           |  |
| annotation | documentation<br>00030_EET_Producer_LEI  |            |       |            |           |    |  |           |    |  |         |                           |  |

element **EETReportType/DataSetInformation/DataSetInformation/Producer/Email**

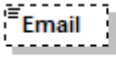
|            |   |
|------------|---|
| diagram    |  <p>00040_EET_Producer_Email</p> |
| type       | <b>xs:string</b>  |
| properties | isRef 0<br>minOcc 0<br>maxOcc 1<br>content simple   |
| annotation | documentation<br>00040_EET_Producer_Email   |

element **EETReportType/DataSetInformation/DataSetInformation/FileGeneration**

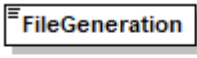
|            |   |
|------------|---|
| diagram    |  <p>00050_EET_File_Generation<br/>_Date_And_Time<br/>Date and Time of the<br/>creation of the EET file</p> |
| type       | <b>xs:dateTime</b>  |
| properties | isRef 0<br>content simple   |
| annotation | documentation<br>00050_EET_File_Generation_Date_And_Time<br>Date and Time of the creation of the EET file   |

element **EETReportType/DataSetInformation/DataSetInformation/DataReporting**

|            |   |
|------------|---|
| diagram    | <pre> classDiagram     class DataReporting {         00060 - 00100     }     class SFDR_PreContractual {         00060_EET_Data_Reporting_SFDR_Pre_Contractual         Implementation date of SFDR pre-contractual (1/7/2022 TBC)     }     class SFDR_Periodic {         00070_EET_Data_Reporting_SFDR_Periodic         First period of SFDR periodic reporting (2022? TBD)     }     class SFDR_EntityLevel {         00080_EET_Data_Reporting_SFDR_Entity_Level         Date of first PAI statement at entity level (31/12/2022? TBC)     }     class MiFID {         00090_EET_Data_Reporting_Mifid         Implementation date of MIFID2 (2/8/22) and SFDR L2 (1/7/22 TBC)     }     class IDD {         00100_EET_Data_Reporting_IDD         MiFID/IDD Sustainability preferences (2/8/2022)     }     DataReporting -- SFDR_PreContractual     DataReporting -- SFDR_Periodic     DataReporting -- SFDR_EntityLevel     DataReporting -- MiFID     DataReporting -- IDD         </pre> |
| properties | isRef 0<br>content complex  |
| children   | <a href="#">SFDR_PreContractual</a> <a href="#">SFDR_Periodic</a> <a href="#">SFDR_EntityLevel</a> <a href="#">MiFID</a> <a href="#">IDD</a>  |
| annotation | documentation<br>00060 - 00100  |

element **EETReportType/DataSetInformation/DataSetInformation/DataReporting/SFDR\_PreContractual**

|            |  |
|------------|--|
| diagram    | <pre> classDiagram     class SFDR_PreContractual {         00060_EET_Data_Reporting_SFDR_Pre_Contractual         Implementation date of SFDR pre-contractual (1/7/2022 TBC)     }         </pre> |
| type       | <a href="#">EETYesNoType</a>   |
| properties | isRef 0<br>content simple  |
| facets     | Kind Value annotation<br>length 1  |
| annotation | documentation<br>00060_EET_Data_Reporting_SFDR_Pre_Contractual<br>Implementation date of SFDR pre-contractual (1/7/2022 TBC)   |

element **EETReportType/DataSetInformation/DataSetInformation/DataReporting/SFDR\_Periodic**

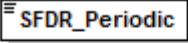
|            |   |
|------------|---|
| diagram    |  <p>00070_EET_Data_Reporting_SFDR_Periodic<br/>First period of SFDR periodic reporting (2022? TBD)</p> |
| type       | <a href="#">EETYesNoType</a>  |
| properties | isRef 0<br>content simple   |
| facets     | Kind Value annotation<br>length 1   |
| annotation | documentation<br>00070_EET_Data_Reporting_SFDR_Periodic<br>First period of SFDR periodic reporting (2022? TBD)  |

element **EETReportType/DataSetInformation/DataSetInformation/DataReporting/SFDR\_EntityLevel**

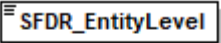
|            |   |
|------------|---|
| diagram    |  <p>00080_EET_Data_Reporting_SFDR_Entity_Level<br/>Date of first PAI statement at entity level (31/12/2022? TBC)</p> |
| type       | <a href="#">EETYesNoType</a>  |
| properties | isRef 0<br>content simple   |
| facets     | Kind Value annotation<br>length 1   |
| annotation | documentation<br>00080_EET_Data_Reporting_SFDR_Entity_Level<br>Date of first PAI statement at entity level (31/12/2022? TBC)  |

element **EETReportType/DataSetInformation/DataSetInformation/DataReporting/MiFID**

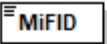
|            |   |
|------------|---|
| diagram    |  <p>00090_EET_Data_Reporting_Mifid<br/>Implementation date of MIFID2 (2/8/22) and SFDR L2 (1/7/22 TBC)</p> |
| type       | <a href="#">EETYesNoType</a>  |
| properties | isRef 0<br>content simple   |
| facets     | Kind Value annotation<br>length 1   |
| annotation | documentation<br>00090_EET_Data_Reporting_Mifid<br>Implementation date of MIFID2 (2/8/22) and SFDR L2 (1/7/22 TBC)  |

element **EETReportType/DataSetInformation/DataSetInformation/DataReporting/IDD**

|            |  |
|------------|--|
| diagram    | <p><b>IDD</b><br/>00100_EET_Data_Reporting_IDD<br/>MiFID/IDD Sustainability preferences (2/8/2022)</p> |
| type       | <a href="#">EETYesNoType</a>   |
| properties | isRef 0<br>content simple  |
| facets     | Kind Value annotation<br>length 1  |
| annotation | documentation<br>00100_EET_Data_Reporting_IDD<br>MiFID/IDD Sustainability preferences (2/8/2022)       |

element **EETReportType/DataSetInformation/ManufacturerInformation**

|            |  |
|------------|--|
| diagram    | <p><b>ManufacturerInformation</b><br/>10000 - 10040</p> <ul style="list-style-type: none"> <li><b>Name</b><br/>10000_Manufacturer_Name<br/>Name of the Manufacturer</li> <li><b>CodeType</b><br/>10010_Manufacturer_Code_Type<br/>Type<br/>Codification used to determine the identification code. Either LEI or None.</li> <li><b>Code</b><br/>10020_Manufacturer_Code<br/>Identification code of the Manufacturer</li> <li><b>Email</b><br/>10030_Manufacturer_Email<br/>Contact entry point for distributors for content question</li> <li><b>GeneralReferenceDate</b><br/>10040_General_Reference_Date<br/>Date to which the general data refer</li> </ul> |
| properties | isRef 0<br>content complex   |
| children   | <a href="#">Name</a> <a href="#">CodeType</a> <a href="#">Code</a> <a href="#">Email</a> <a href="#">GeneralReferenceDate</a>  |
| annotation | documentation<br>10000 - 10040   |

element **EETReportType/DataSetInformation/ManufacturerInformation/Name**

|         |   |
|---------|---|
| diagram | <p><b>Name</b><br/>10000_Manufacturer_Name<br/>Name of the Manufacturer</p> |
|---------|---|

|            |  |
|------------|--|
| type       | restriction of <b>xs:string</b>                                      |
| properties | isRef 0<br>content simple  |
| facets     | Kind Value annotation<br>maxLength 255                               |
| annotation | documentation<br>10000_Manufacturer_Name<br>Name of the Manufacturer |

element **EETReportType/DataSetInformation/ManufacturerInformation/CodeType**

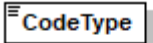
|            |   |
|------------|---|
| diagram    |  <p>10010_Manufacturer_Code_Type<br/>Codification used to determine the identification code. Either LEI or None.</p> |
| type       | restriction of <b>xs:string</b>   |
| properties | isRef 0<br>content simple   |
| annotation | documentation<br>10010_Manufacturer_Code_Type<br>Codification used to determine the identification code. Either LEI or None.  |

element **EETReportType/DataSetInformation/ManufacturerInformation/Code**

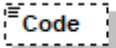
|            |  |
|------------|--|
| diagram    |  <p>10020_Manufacturer_Code<br/>Identification code of the Manufacturer</p> |
| type       | restriction of <b>xs:string</b>  |
| properties | isRef 0<br>minOcc 0<br>maxOcc 1<br>content simple  |
| facets     | Kind Value annotation<br>maxLength 255   |
| annotation | documentation<br>10020_Manufacturer_Code<br>Identification code of the Manufacturer  |

element **EETReportType/DataSetInformation/ManufacturerInformation/Email**

|            |   |
|------------|---|
| diagram    |  <p>10030_Manufacturer_Email<br/>Contact entry point for distributors for content question</p> |
| type       | <b>xs:string</b>  |
| properties | isRef 0<br>minOcc 0<br>maxOcc 1<br>content simple   |

|            |  |
|------------|--|
| annotation | documentation<br>10030_Manufacturer_Email<br>Contact entry point for distributors for content question |
|------------|--|

element **EETReportType/DataSetInformation/ManufacturerInformation/GeneralReferenceDate**

|            |   |
|------------|---|
| diagram    |   |
| type       | <b>xs:date</b>  |
| properties | isRef 0<br>content simple   |
| annotation | documentation<br>10040_General_Reference_Date<br>Date to which the general data refer |

element **EETReportType/DataSetInformation/ManufacturerCommitmentToResponsibleInvestment**

|            |   |
|------------|---|
| diagram    |   |
| properties | isRef 0<br>minOcc 0<br>maxOcc 1<br>content complex  |
| children   | <a href="#">PRI_Or_PRB_Signatory</a> <a href="#">PRI_Notation</a> <a href="#">PRI_Or_PRB_Compliant</a> <a href="#">PRI_Or_PRB_Like</a> <a href="#">OtherCommitments</a> |

|            |                                |
|------------|--------------------------------|
| annotation | documentation<br>11000 - 11040 |
|------------|--------------------------------|

element

**EETReportType/DataSetInformation/ManufacturerCommitmentToResponsibleInvestment/PRI\_Or\_PRB\_Signatory**

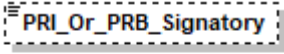
|            |  |
|------------|--|
| diagram    |  <p>11000_Manufacturer_PRI_Or_P<br/>RB_Signatory<br/>Has the Manufacturer signed<br/>the Principle for Responsible<br/>Investment ?</p> |
| type       | <a href="#">EETYesNoType</a>   |
| properties | isRef 0<br>minOcc 0<br>maxOcc 1<br>content simple  |
| facets     | Kind Value annotation<br>length 1  |
| annotation | documentation<br>11000_Manufacturer_PRI_Or_PRB_Signatory<br>Has the Manufacturer signed the Principle for Responsible Investment ?   |

element

**EETReportType/DataSetInformation/ManufacturerCommitmentToResponsibleInvestment/PRI\_Notation**

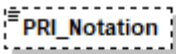
|            |   |
|------------|---|
| diagram    |  <p>11010_Manufacturer_PRI_N<br/>otation<br/>Notation of the Manufacturer<br/>by the PRI on the<br/>"governance and strategy"<br/>pillar</p> |
| type       | <b>xs:string</b>  |
| properties | isRef 0<br>minOcc 0<br>maxOcc 1<br>content simple   |
| annotation | documentation<br>11010_Manufacturer_PRI_Notation<br>Notation of the Manufacturer by the PRI on the "governance and strategy" pillar   |

element

**EETReportType/DataSetInformation/ManufacturerCommitmentToResponsibleInvestment/PRI\_Or\_PRB\_Compliant**

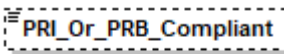
|         |  |
|---------|--|
| diagram |  <p>11020_Manufacturer_PRI_Or_P<br/>RB_Compliant<br/>The manufacturer is a subsidiary<br/>of a PRI/PRB entity</p> |
| type    | <a href="#">EETYesNoType</a>   |



|            |  |
|------------|--|
| properties | isRef 0<br>minOcc 0<br>maxOcc 1<br>content simple  |
| facets     | Kind Value annotation<br>length 1  |
| annotation | documentation<br>11020_Manufacturer_PRI_Or_PRB_Compliant<br>The manufacturer is a subsidiary of a PRI/PRB entity |

element

**EETReportType/DataSetInformation/ManufacturerCommitmentToResponsibleInvestment/PRI\_Or\_PRB\_Like**

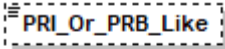
|            |  |
|------------|--|
| diagram    |  <p>11030_Manufacturer_PRI_Or_PRB_Like<br/>The Manufacturer is not a PRI/PRB signatory but considers it follows PRI/PRB rules</p> |
| type       | <a href="#">EETYesNoType</a>   |
| properties | isRef 0<br>minOcc 0<br>maxOcc 1<br>content simple  |
| facets     | Kind Value annotation<br>length 1  |
| annotation | documentation<br>11030_Manufacturer_PRI_Or_PRB_Like<br>The Manufacturer is not a PRI/PRB signatory but considers it follows PRI/PRB rules  |

element

**EETReportType/DataSetInformation/ManufacturerCommitmentToResponsibleInvestment/OtherCommitments**

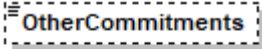
|            |  |
|------------|--|
| diagram    |  <p>11040_Manufacturer_Other_Commitments<br/>Other Commitments by Manufacturers</p> |
| type       | <b>xs:string</b>   |
| properties | isRef 0<br>minOcc 0<br>maxOcc 1<br>content simple  |
| annotation | documentation<br>11040_Manufacturer_Other_Commitments<br>Other Commitments by Manufacturers  |

element **EETReportType/DataSetInformation/ManufacturerStewardshipCodeSignatory**

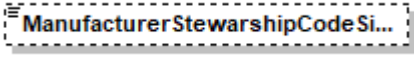
|            |  |
|------------|--|
| diagram    |  <p>12000_Manufacturer_Stewardship_Code_Signatory<br/>Disclosure of the applicable Stewardship Code</p> |
| type       | <b>xs:string</b>   |
| properties | <p>isRef 0<br/>minOcc 0<br/>maxOcc 1<br/>content simple</p>  |
| annotation | <p>documentation<br/>12000_Manufacturer_Stewardship_Code_Signatory<br/>Disclosure of the applicable Stewardship Code</p>   |

element **EETReportType/DataSetInformation/ManufacturerWebsiteInformationStewardshipAndEngagement**

|            |   |
|------------|---|
| diagram    |  <p>13000_Manufacturer_Website_Information_Stewardship_And_Engagement<br/>Internet adress where the client can find all relevant informations regarding stewardship and engagement of the manufacturer</p> |
| type       | <b>xs:string</b>  |
| properties | <p>isRef 0<br/>content simple</p>   |
| annotation | <p>documentation<br/>13000_Manufacturer_Website_Information_Stewardship_And_Engagement<br/>Internet adress where the client can find all relevant informations regarding stewardship and engagement of the manufacturer</p>   |

element **EETReportType/GeneralFinancialInstrumentInformation**

diagram

**GeneralFinancialInstrumentInf...**

20000 - 20030

**IdentifyingData**

20000\_Financial\_Instrument\_Identifying\_Data

Use the following priority:  
- ISO 6166 code of ISIN when available  
- Other recognised codes (e.g.: CUSIP, Bloomberg Ticker, Reuters RIC)  
- Code attributed by the undertaking, when the options above are not available. Code must be unique and kept consistent over time

**TypeOfIdentification**

20010\_Financial\_Instrument\_Type\_Of\_Identification\_Code

One of the options in the following closed list to be used:  
1 - ISO 6166 for ISIN code  
2 - CUSIP (The Committee on Uniform Securities Identification Procedures number assigned by the CUSIP Service Bureau for U.S. and Canadian companies)  
3 - SEDOL (Stock Exchange Daily Official List for the London Stock Exchange)  
4 - WKN (Wertpapier Kenn-Nummer, the alphanumeric German identification number)  
5 - Bloomberg Ticker (Bloomberg letters code that identify a company's securities)  
6 - BBGID (The Bloomberg Global ID)  
7 - Reuters RIC (Reuters instrument code)  
8 - FIGI (Financial Instrument Global Identifier)  
9 - Other code by members of the Association of National Numbering Agencies  
10 - LEI  
99 - Code attributed by the undertaking

**Name**

20020\_Financial\_Instrument\_Name

Name of the financial instrument

**Currency**

20030\_Financial\_Instrument\_Currency

Denomination Currency of the Financial Instrument

|            |  |
|------------|--|
| properties | isRef 0<br>content complex   |
| children   | <a href="#">IdentifyingData</a> <a href="#">TypeOfIdentification</a> <a href="#">Name</a> <a href="#">Currency</a> |
| annotation | documentation<br>20000 - 20030   |

element **EETReportType/GeneralFinancialInstrumentInformation/IdentifyingData**

|            |   |
|------------|---|
| diagram    |  <p>20000_Financial_Instrument_Identifying_Data<br/>Use the following priority:<br/>- ISO 6166 code of ISIN when available<br/>- Other recognised codes (e.g.: CUSIP, Bloomberg Ticker, Reuters RIC)<br/>- Code attributed by the undertaking, when the options above are not available. Code must be unique and kept consistent over time</p> |
| type       | restriction of <b>xs:string</b>   |
| properties | isRef 0<br>content simple   |
| facets     | Kind Value annotation<br><b>maxLength</b> 255   |
| annotation | documentation<br>20000_Financial_Instrument_Identifying_Data<br>Use the following priority:<br>- ISO 6166 code of ISIN when available<br>- Other recognised codes (e.g.: CUSIP, Bloomberg Ticker, Reuters RIC)<br>- Code attributed by the undertaking, when the options above are not available. Code must be unique and kept consistent over time   |

element **EETReportType/GeneralFinancialInstrumentInformation/TypeOfIdentification**

|                   |  |
|-------------------|--|
| <p>diagram</p>    | <div style="border: 1px solid black; padding: 5px; margin-bottom: 10px;"> <p><b>TypeOfIdentification</b></p> </div> <p>20010_Financial_Instrument_Type_Of_Identification_Code</p> <p>One of the options in the following closed list to be used:</p> <ul style="list-style-type: none"> <li>1 - ISO 6166 for ISIN code</li> <li>2 - CUSIP (The Committee on Uniform Securities Identification Procedures number assigned by the CUSIP Service Bureau for U.S. and Canadian companies)</li> <li>3 - SEDOL (Stock Exchange Daily Official List for the London Stock Exchange)</li> <li>4 - WKN (Wertpapier Kenn-Nummer, the alphanumeric German identification number)</li> <li>5 - Bloomberg Ticker (Bloomberg letters code that identify a company's securities)</li> <li>6 - BBGID (The Bloomberg Global ID)</li> <li>7 - Reuters RIC (Reuters instrument code)</li> <li>8 - FIGI (Financial_Instrument Global Identifier)</li> <li>9 - Other code by members of the Association of National Numbering Agencies</li> <li>10 - LEI</li> <li>99 - Code attributed by the undertaking</li> </ul> |
| <p>type</p>       | <p>restriction of <b>xs:int</b></p>  |
| <p>properties</p> | <p>isRef 0<br/>content simple</p>  |
| <p>annotation</p> | <p>documentation</p> <p>20010_Financial_Instrument_Type_Of_Identification_Code</p> <p>One of the options in the following closed list to be used:</p> <ul style="list-style-type: none"> <li>1 - ISO 6166 for ISIN code</li> <li>2 - CUSIP (The Committee on Uniform Securities Identification Procedures number assigned by the CUSIP Service Bureau for U.S. and Canadian companies)</li> <li>3 - SEDOL (Stock Exchange Daily Official List for the London Stock Exchange)</li> <li>4 - WKN (Wertpapier Kenn-Nummer, the alphanumeric German identification number)</li> <li>5 - Bloomberg Ticker (Bloomberg letters code that identify a company's securities)</li> <li>6 - BBGID (The Bloomberg Global ID)</li> <li>7 - Reuters RIC (Reuters instrument code)</li> <li>8 - FIGI (Financial_Instrument Global Identifier)</li> <li>9 - Other code by members of the Association of National Numbering Agencies</li> <li>10 - LEI</li> <li>99 - Code attributed by the undertaking</li> </ul>  |

element **EETReportType/GeneralFinancialInstrumentInformation/Name**

|            |  |
|------------|--|
| diagram    |  |
| type       | restriction of <b>xs:string</b>  |
| properties | isRef 0<br>content simple  |
| facets     | Kind Value annotation<br>maxLength 255   |
| annotation | documentation<br>20020_Financial_Instrument_Name<br>Name of the financial instrument |

element **EETReportType/GeneralFinancialInstrumentInformation/Currency**

|            |   |
|------------|---|
| diagram    |   |
| type       | <a href="#"><b>ISOCurrencyCodeType</b></a>  |
| properties | isRef 0<br>content simple   |
| facets     | Kind Value annotation<br>minLength 3<br>maxLength 3<br>pattern [A-Z]{3}                                   |
| annotation | documentation<br>20030_Financial_Instrument_Currency<br>Denomination Currency of the Financial Instrument |

element **EETReportType/MainCriteria**s

|                   |   |
|-------------------|---|
| <p>diagram</p>    | <p><b>MainCriteria</b><br/>20040 - 20100</p> <ul style="list-style-type: none"> <li><b>SFDR_ProductType</b><br/>20040_Financial_Instrument_SFDR_Product_Type<br/>Reference of the article of SFDR european regulation applying to the product (art 6, art 8 or art 9)<br/>6= no product acc. to Art. 8/9<br/>8= Art. 8 SFDR Product (ESG characteristics)<br/>9= Art. 9 SFDR product (ESG objective)</li> <li><b>SFDR_ProductTypeEligible</b><br/>20050_Financial_Instrument_SFDR_Product_Type_Eligible<br/>Funds not being in SFDR scope and structured products. Art 8 like, art 9 like</li> <li><b>ESG_LabelOrStandard</b><br/>20060_Financial_Instrument_ESG_Label_Or_Standard<br/>Disclosure of applicable ESG Label/s</li> <li><b>Minimum_SFDR_Art_8_Funds</b><br/>20070_Financial_Instrument_%_Of_Minimum_SFDR_Art_8_Funds<br/>Proportion in look through of art 8 sub invested funds. Nav based</li> <li><b>Minimum_SFDR_Art_9_Funds</b><br/>20080_Financial_Instrument_%_Of_Minimum_SFDR_Art_9_Funds<br/>Proportion in look through of art 9 sub invested funds. Nav based</li> <li><b>Main_ESG_Focus</b><br/>20090_Financial_Instrument_Main_ESG_Focus<br/>Indication of the "main focus" of the Financial_Instrument ( for example E for green bonds...), E or S or G.</li> <li><b>ConsidersPrincipleAdverseImp...</b><br/>20100_Financial_Instrument_Does_This_Product_Consider_Principle_Adverse_Impact_In_Their_Investment</li> </ul> |
| <p>properties</p> | <p>isRef 0<br/>content complex</p>  |
| <p>children</p>   | <p><a href="#">SFDR_ProductType</a> <a href="#">SFDR_ProductTypeEligible</a> <a href="#">ESG_LabelOrStandard</a> <a href="#">Minimum_SFDR_Art_8_Funds</a> <a href="#">Minimum_SFDR_Art_9_Funds</a> <a href="#">Main_ESG_Focus</a> <a href="#">ConsidersPrincipleAdverseImpact</a></p>   |
| <p>annotation</p> | <p>documentation<br/>20040 - 20100</p>  |

element **EETReportType/MainCriterias/SFDR\_ProductType**

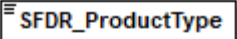
|            |  |
|------------|--|
| diagram    |  <p><b>SFDR_ProductType</b></p> <p>20040_Financial_Instrument_SFDR_Product_Type<br/>Reference of the article of SFDR european regulation applying to the product (art 6, art 8 or art 9)<br/>6= no product acc. to Art. 8/9<br/>8= Art. 8 SFDR Product (ESG characteristics)<br/>9= Art. 9 SFDR product (ESG objective)</p> |
| type       | restriction of <b>xs:string</b>  |
| properties | isRef 0<br>content simple  |
| annotation | documentation<br>20040_Financial_Instrument_SFDR_Product_Type<br>Reference of the article of SFDR european regulation applying to the product (art 6, art 8 or art 9)<br>6= no product acc. to Art. 8/9<br>8= Art. 8 SFDR Product (ESG characteristics)<br>9= Art. 9 SFDR product (ESG objective)  |

element **EETReportType/MainCriterias/SFDR\_ProductTypeEligible**

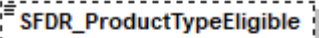
|            |   |
|------------|---|
| diagram    |  <p><b>SFDR_ProductTypeEligible</b></p> <p>20050_Financial_Instrument_SFDR_Product_Type_Eligible<br/>Funds not being in SFDR scope and structured products. Art 8 like, art 9 like</p> |
| type       | restriction of <b>xs:string</b>   |
| properties | isRef 0<br>minOcc 0<br>maxOcc 1<br>content simple   |
| annotation | documentation<br>20050_Financial_Instrument_SFDR_Product_Type_Eligible<br>Funds not being in SFDR scope and structured products. Art 8 like, art 9 like   |

element **EETReportType/MainCriterias/ESG\_LabelOrStandard**

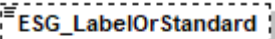
|            |  |
|------------|--|
| diagram    |  <p><b>ESG_LabelOrStandard</b></p> <p>20060_Financial_Instrument_ESG_Label_Or_Standard<br/>Disclosure of applicable ESG Label/s</p> |
| type       | <b>xs:string</b>   |
| properties | isRef 0<br>minOcc 0<br>maxOcc 1<br>content simple  |
| annotation | documentation<br>20060_Financial_Instrument_ESG_Label_Or_Standard<br>Disclosure of applicable ESG Label/s  |

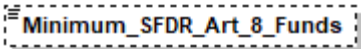

element **EETReportType/MainCriterias/Minimum\_SFDR\_Art\_8\_Funds**

|            |   |
|------------|---|
| diagram    |  <p>20070_Financial_Instrument_%_Of_Minimum_SFDR_Art_8_Funds<br/>Proportion in look through of art 8 sub invested funds. Nav based</p> |
| type       | <b>xs:decimal</b>   |
| properties | isRef 0<br>minOcc 0<br>maxOcc 1<br>content simple   |
| annotation | documentation<br>20070_Financial_Instrument_%_Of_Minimum_SFDR_Art_8_Funds<br>Proportion in look through of art 8 sub invested funds. Nav based  |

element **EETReportType/MainCriterias/Minimum\_SFDR\_Art\_9\_Funds**

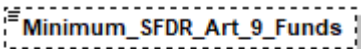
|            |   |
|------------|---|
| diagram    |  <p>20080_Financial_Instrument_%_Of_Minimum_SFDR_Art_9_Funds<br/>Proportion in look through of art 9 sub invested funds. Nav based</p> |
| type       | <b>xs:decimal</b>   |
| properties | isRef 0<br>minOcc 0<br>maxOcc 1<br>content simple   |
| annotation | documentation<br>20080_Financial_Instrument_%_Of_Minimum_SFDR_Art_9_Funds<br>Proportion in look through of art 9 sub invested funds. Nav based  |

element **EETReportType/MainCriterias/Main\_ESG\_Focus**

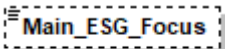
|            |   |
|------------|---|
| diagram    |  <p>20090_Financial_Instrument_Main_ESG_Focus<br/>Indication of the "main focus" of the Financial Instrument ( for example E for green bonds...), E or S or G.</p> |
| type       | restriction of <b>xs:string</b>   |
| properties | isRef 0<br>minOcc 0<br>maxOcc 1<br>content simple   |
| annotation | documentation<br>20090_Financial_Instrument_Main_ESG_Focus<br>Indication of the "main focus" of the Financial_Instrument ( for example E for green bonds...), E or S or G.  |

element **EETReportType/MainCriteria/ConsidersPrincipleAdverseImpact**

|            |   |
|------------|---|
| diagram    |                                    |
| type       | <a href="#">EETYesNoType</a>  |
| properties | isRef 0<br>content simple   |
| facets     | Kind Value annotation<br>length 1   |
| annotation | documentation<br>20100_Financial_Instrument_Does_This_Product_Consider_Principle_Adverse_Impact_In_Their_Investment |

element **EETReportType/ProductDisclosures**

|                   |  |
|-------------------|--|
| <p>diagram</p>    | <p><b>ProductDisclosures</b><br/>20110 - 20160</p> <p><b>Languages</b><br/>20110_Financial_Instrument_Languages<br/>Each insurance company needs to have the documents translated and published in the language of the countries of distribution. This field allows to list the languages in which the annexes documents are translated</p> <p><b>Link_To_PCDFP_For_MOP</b><br/>20120_Financial_Instrument_Link_To_PCDFP_For_MOP<br/>Pre Contractual Disclosure for Financial Products referred to in Article 8(1) and 9(1), (2) and (3) (EU) 2019/2088 as stand alone document PDF for underlying investment options in Multi Option Products. Annex I, Annex II (EU) 2019/2088.</p> <p><b>ProductionDate_PCDFP</b><br/>20130_Financial_Instrument_Production_Date_PCDFP<br/>Date of production of PCDFP</p> <p><b>Link_To_PDFP_for_MOP</b><br/>20140_Financial_Instrument_Link_To_PDFP_for_MOP<br/>Periodic Disclosure for Financial Products referred to in Article 8(1) and 9(1), (2) and (3) (EU) 2019/2088 as stand alone document PDF for underlying investment options in Multi Option Products. Annex III, Annex IV (EU) 2019/2088.</p> <p><b>EndDateOfReportingPeriod_PDFP</b><br/>20150_Financial_Instrument_End_Date_Of_Reporting_Period_PDFP<br/>End Date Of Reporting Period PDFP (based on 12 months reporting report market usage)</p> <p><b>LinkTo_SFDR_WebsiteProductDi...</b><br/>20160_Financial_Instrument_Link_To_SFDR_Website_Product_Disclosures<br/>Art 10 SFDR - 33 RTS and 46 RTS</p> |
| <p>properties</p> | <p>isRef 0<br/>minOcc 0<br/>maxOcc 1<br/>content complex</p>   |
| <p>children</p>   | <p><a href="#">Languages</a> <a href="#">Link_To_PCDFP_For_MOP</a> <a href="#">ProductionDate_PCDFP</a> <a href="#">Link_To_PDFP_for_MOP</a> <a href="#">EndDateOfReportingPeriod_PDFP</a> <a href="#">LinkTo_SFDR_WebsiteProductDisclosures</a></p>   |
| <p>annotation</p> | <p>documentation<br/>20110 - 20160</p>   |

element **EETReportType/ProductDisclosures/Languages**

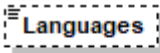
|            |   |
|------------|---|
| diagram    |  <p>20110_Financial_Instrument_Languages<br/>Each insurance company needs to have the documents translated and published in the language of the countries of distribution. This field allows to list the languages in which the annexes documents are translated</p> |
| type       | <b>xs:string</b>  |
| properties | <p>isRef 0<br/>minOcc 0<br/>maxOcc 1<br/>content simple</p>   |
| annotation | <p>documentation<br/>20110_Financial_Instrument_Languages<br/>Each insurance company needs to have the documents translated and published in the language of the countries of distribution. This field allows to list the languages in which the annexes documents are translated</p>   |

element **EETReportType/ProductDisclosures/Link\_To\_PCDFP\_For\_MOP**

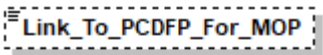
|            |  |
|------------|--|
| diagram    |  <p>20120_Financial_Instrument_Link_To_PCDFP_For_MOP<br/>Pre Contractual Disclosure for Financial Products referred to in Article 8(1) and 9(1), (2) and (3) (EU) 2019/2088 as stand alone document PDF for underlying investment options in Multi Option Products. Annex I, Annex II (EU) 2019/2088.</p> |
| type       | <b>xs:anyURI</b>   |
| properties | <p>isRef 0<br/>minOcc 0<br/>maxOcc 1<br/>content simple</p>  |
| annotation | <p>documentation<br/>20120_Financial_Instrument_Link_To_PCDFP_For_MOP<br/>Pre Contractual Disclosure for Financial Products referred to in Article 8(1) and 9(1), (2) and (3) (EU) 2019/2088 as stand alone document PDF for underlying investment options in Multi Option Products. Annex I, Annex II (EU) 2019/2088.</p>   |

element **EETReportType/ProductDisclosures/ProductionDate\_PCDFP**

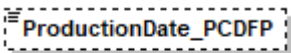
|            |   |
|------------|---|
| diagram    |  <p>20130_Financial_Instrument_Production_Date_PCDFP<br/>Date of production of PCDFP</p> |
| type       | <b>xs:date</b>  |
| properties | <p>isRef 0<br/>minOcc 0<br/>maxOcc 1<br/>content simple</p>   |

|            |  |
|------------|--|
| annotation | documentation<br>20130_Financial_Instrument_Production_Date_PCDFP<br>Date of production of PCDFP |
|------------|--|

element **EETReportType/ProductDisclosures/Link\_To\_PDFP\_for\_MOP**

|            |   |
|------------|---|
| diagram    |  <b>Link_To_PDFP_for_MOP</b><br>20140_Financial_Instrument_Link_To_PDFP_for_MOP<br>Periodic Disclosure for Financial Products referred to in Article 8(1) and 9(1), (2) and (3) (EU) 2019/2088 as stand alone document PDF for underlying investment options in Multi Option Products. Annex III, Annex IV (EU) 2019/2088. |
| type       | <b>xs:anyURI</b>  |
| properties | isRef 0<br>minOcc 0<br>maxOcc 1<br>content simple   |
| annotation | documentation<br>20140_Financial_Instrument_Link_To_PDFP_for_MOP<br>Periodic Disclosure for Financial Products referred to in Article 8(1) and 9(1), (2) and (3) (EU) 2019/2088 as stand alone document PDF for underlying investment options in Multi Option Products. Annex III, Annex IV (EU) 2019/2088.   |

element **EETReportType/ProductDisclosures/EndDateOfReportingPeriod\_PDFP**

|            |  |
|------------|--|
| diagram    |  <b>EndDateOfReportingPeriod_PDFP</b><br>20150_Financial_Instrument_End_Date_Of_Reporting_Period_PDFP<br>End Date Of Reporting Period PDFP (based on 12 months reporting report market usage) |
| type       | <b>xs:date</b>   |
| properties | isRef 0<br>minOcc 0<br>maxOcc 1<br>content simple  |
| annotation | documentation<br>20150_Financial_Instrument_End_Date_Of_Reporting_Period_PDFP<br>End Date Of Reporting Period PDFP (based on 12 months reporting report market usage)  |

element **EETReportType/ProductDisclosures/LinkTo\_SFDR\_WebsiteProductDisclosures**

|            |  |
|------------|--|
| diagram    |  <b>LinkTo_SFDR_WebsiteProductDi...</b><br>20160_Financial_Instrument_Link_To_SFDR_Website_Product_Disclosures<br>Art 10 SFDR - 33 RTS and 46 RTS |
| type       | <b>xs:anyURI</b>   |
| properties | isRef 0<br>minOcc 0<br>maxOcc 1<br>content simple  |
| annotation | documentation<br>20160_Financial_Instrument_Link_To_SFDR_Website_Product_Disclosures   |



element **EETReportType/SpecificInformationForArt8and9**

|                   |  |
|-------------------|--|
| <p>diagram</p>    |  <p><b>SpecificInformationForArt8and9</b><br/>20170 - 20250</p> <ul style="list-style-type: none"> <li><b>SustainableInvestmentsArt8</b><br/>20170_Financial_Instrument_Sustainable_Investments_Art.8</li> <li><b>MinimalProportionOfSustainabl...</b><br/>20180_Financial_Instrument_Products_Minimal_Proportion_Of_Sustainable_Investments_Art.8</li> <li><b>SustainableInvestmentEUTaxon...</b><br/>20190_Financial_Instrument_Sustainable_Investment_EU_Taxonomy_Art.8<br/>Does the minimum specified in field 20170 include EU Taxonomy sustainable investment?</li> <li><b>SustainableInvestmentEnviron...</b><br/>20200_Financial_Instrument_Sustainable_Investment_Environmental_Not_EU_Taxonomy_Art.8<br/>Does the minimum specified in field 20170 include Non EU Taxonomy Environmental sustainable investment?</li> <li><b>SustainableInvestmentSocialObj...</b><br/>20210_Financial_Instrument_Sustainable_Investment_Social_Objective_Art.8<br/>Does the minimum specified in field 20170 include include sustainable investment with social objective?</li> <li><b>SustainableInvestmentWithEnvi...</b><br/>20220_Financial_Instrument_Minimum_Sustainable_Investment_With_Environmental_Objective_Art.9<br/>For art 9 products, the minimum proportion of sustainable investments.</li> <li><b>EnvironmentallySustainableInve...</b><br/>20230_Financial_Instrument_Environmentally_Sustainable_Investment_EU_Taxonomy_Art.9<br/>Does the minimum specified in field 20210 include EU Taxonomy Environmental sustainable investment?</li> <li><b>EnvironmentallySustainableInve...</b><br/>20240_Financial_Instrument_Environmentally_Sustainable_Investment_Not_EU_Taxonomy_Art.9<br/>Does the minimum specified in field 20210 include Non EU Taxonomy Environmental sustainable investment?</li> <li><b>MinimumSustainableInvestmen...</b><br/>20250_Financial_Instrument_Minimum_Sustainable_Investment_Social_Objective_Art.9<br/>Does the minimum specified in field 20210 include sustainable investments with social objectives.</li> </ul> |
| <p>properties</p> | <p>isRef 0<br/>minOcc 0</p>  |

|            |  |
|------------|--|
|            | maxOcc 1<br>content complex  |
| children   | <a href="#">SustainableInvestmentsArt8_MinimalProportionOfSustainableInvestmentsArt8</a><br><a href="#">SustainableInvestmentEUTaxonomyArt8</a> <a href="#">SustainableInvestmentEnvironmentalNotEUTaxonomyArt8</a><br><a href="#">SustainableInvestmentSocialObjectiveArt8</a> <a href="#">SustainableInvestmentWithEnvironmentalObjectiveArt9</a><br><a href="#">EnvironmentallySustainableInvestmentEUTaxonomyArt9</a><br><a href="#">EnvironmentallySustainableInvestmentNotEUTaxonomyArt9</a> <a href="#">MinimumSustainableInvestmentSocialObjectiveArt9</a> |
| annotation | documentation<br>20170 - 20250   |

element **EETReportType/SpecificInformationForArt8and9/SustainableInvestmentsArt8**

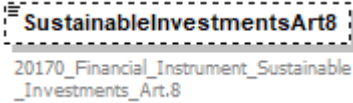
|            |   |
|------------|---|
| diagram    |  |
| type       | <a href="#">EETYesNoType</a>  |
| properties | isRef 0<br>minOcc 0<br>maxOcc 1<br>content simple                                 |
| facets     | Kind Value annotation<br>length 1   |
| annotation | documentation<br>20170_Financial_Instrument_Sustainable_Investments_Art.8         |

element

**EETReportType/SpecificInformationForArt8and9/MinimalProportionOfSustainableInvestmentsArt8**

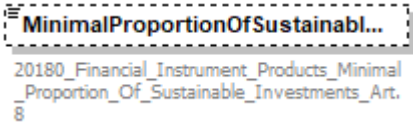
|            |  |
|------------|--|
| diagram    |                       |
| type       | <b>xs:decimal</b>  |
| properties | isRef 0<br>minOcc 0<br>maxOcc 1<br>content simple  |
| annotation | documentation<br>20180_Financial_Instrument_Products_Minimal_Proportion_Of_Sustainable_Investments_Art.8 |

element **EETReportType/SpecificInformationForArt8and9/SustainableInvestmentEUTaxonomyArt8**

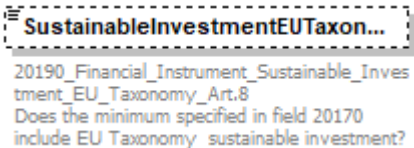
|            |   |
|------------|---|
| diagram    |  |
| type       | <a href="#">EETYesNoType</a>  |
| properties | isRef 0<br>minOcc 0<br>maxOcc 1<br>content simple                                   |
| facets     | Kind Value annotation   |



|            |   |
|------------|---|
|            | length 1  |
| annotation | documentation<br>20190_Financial_Instrument_Sustainable_Investment_EU_Taxonomy_Art.8<br>Does the minimum specified in field 20170 include EU Taxonomy sustainable investment? |

element

**EETReportType/SpecificInformationForArt8and9/SustainableInvestmentEnvironmentalNotEUTaxonomyArt8**

|            |  |
|------------|--|
| diagram    |  <p>20200_Financial_Instrument_Sustainable_Investment_Environmental_Not_EU_Taxonomy_Art.8<br/>Does the minimum specified in field 20170 include Non EU Taxonomy Environmental sustainable investment?</p> |
| type       | <a href="#">EETYesNoType</a>   |
| properties | isRef 0<br>minOcc 0<br>maxOcc 1<br>content simple  |
| facets     | Kind Value annotation<br>length 1  |
| annotation | documentation<br>20200_Financial_Instrument_Sustainable_Investment_Environmental_Not_EU_Taxonomy_Art.8<br>Does the minimum specified in field 20170 include Non EU Taxonomy Environmental sustainable investment?  |

**element EETReportType/SpecificInformationForArt8and9/SustainableInvestmentSocialObjectiveArt8**

|            |   |
|------------|---|
| diagram    |  <p>20210_Financial_Instrument_Sustainable_Investment_Social_Objective_Art.8<br/>Does the minimum specified in field 20170 include include sustainable investment with social objective?</p> |
| type       | <a href="#">EETYesNoType</a>  |
| properties | isRef 0<br>minOcc 0<br>maxOcc 1<br>content simple   |
| facets     | Kind Value annotation<br>length 1   |
| annotation | documentation<br>20210_Financial_Instrument_Sustainable_Investment_Social_Objective_Art.8<br>Does the minimum specified in field 20170 include include sustainable investment with social objective?  |

element

### EETReportType/SpecificInformationForArt8and9/SustainableInvestmentWithEnvironmentalObjectiveArt9

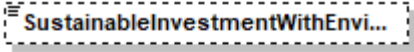
|            |  |
|------------|--|
| diagram    |  <p>20220_Financial_Instrument_Minimum_Sustainable_Investment_With_Environmental_Objective_Art.9<br/>For art 9 products, the minimum proportion of sustainable investments.</p> |
| type       | <b>xs:decimal</b>  |
| properties | isRef 0<br>minOcc 0<br>maxOcc 1<br>content simple  |
| annotation | documentation<br>20220_Financial_Instrument_Minimum_Sustainable_Investment_With_Environmental_Objective_Art.9<br>For art 9 products, the minimum proportion of sustainable investments.  |

element

### EETReportType/SpecificInformationForArt8and9/EnvironmentallySustainableInvestmentEUTaxonomyArt9

|            |  |
|------------|--|
| diagram    |  <p>20230_Financial_Instrument_Environmentally_Sustainable_Investment_EU_Taxonomy_Art.9<br/>Does the minimum specified in field 20210 include EU Taxonomy Environmental sustainable investment?</p> |
| type       | <a href="#">EETYesNoType</a>   |
| properties | isRef 0<br>minOcc 0<br>maxOcc 1<br>content simple  |
| facets     | Kind Value annotation<br>length 1  |
| annotation | documentation<br>20230_Financial_Instrument_Environmentally_Sustainable_Investment_EU_Taxonomy_Art.9<br>Does the minimum specified in field 20210 include EU Taxonomy Environmental sustainable investment?  |

element

### EETReportType/SpecificInformationForArt8and9/EnvironmentallySustainableInvestmentNotEUTaxonomyArt9

|            |  |
|------------|--|
| diagram    |  <p>20240_Financial_Instrument_Environmentally_Sustainable_Investment_Not_EU_Taxonomy_Art.9<br/>Does the minimum specified in field 20210 include Non EU Taxonomy Environmental sustainable investment?</p> |
| type       | <a href="#">EETYesNoType</a>   |
| properties | isRef 0<br>minOcc 0<br>maxOcc 1<br>content simple  |

|            |   |
|------------|---|
| facets     | Kind Value annotation<br>length 1   |
| annotation | documentation<br>20240_Financial_Instrument_Environmentally_Sustainable_Investment_Not_EU_Taxonomy_Art.9<br>Does the minimum specified in field 20210 include Non EU Taxonomy Environmental sustainable investment? |

element

**EETReportType/SpecificInformationForArt8and9/MinimumSustainableInvestmentSocialObjectiveArt9**

|            |   |
|------------|---|
| diagram    |  <p>20250_Financial_Instrument_Minimum_Sustainable_Investment_Social_Objective_Art.9<br/>Does the minimum specified in field 20210 include sustainable investments with social objectives.</p> |
| type       | <b>xs:decimal</b>   |
| properties | isRef 0<br>minOcc 0<br>maxOcc 1<br>content simple   |
| annotation | documentation<br>20250_Financial_Instrument_Minimum_Sustainable_Investment_Social_Objective_Art.9<br>Does the minimum specified in field 20210 include sustainable investments with social objectives.  |

element **EETReportType/ESG\_ThematicInvestingDescription**

diagram

**ESG\_ThematicInvestingDescrip...**

This part describes investment strategy, and is not linked to Taxonomy  
20260 - 20300

**ESG\_ExistingThematic**

20260\_Financial\_Instrument\_ESG\_Existing\_Thematic  
Does this Financial\_Instrument incorporate ESG factors through ESG thematic approach ?

**EnvironmentalThematic**

20270\_Financial\_Instrument\_Environmental\_Thematic  
Description of the product environment thematic investment strategy, according to SFDR art 2(17). Multiple answers fields.  
A - energy  
B - renewable energy  
C - raw materials  
D - water and land  
E - waste  
F - greenhouse gas emissions  
G - biodiversity  
H - circular economy  
I - environment other  
J - none

**SocialThematic**

20280\_Financial\_Instrument\_Social\_Thematic  
Description of the product social thematic investment strategy, according to SFDR art 2(17)  
Multiple answers fields.  
A - inequality  
B - social cohesion,  
C - social integration  
D - labour relations  
E - investment in human capital  
F - economically or socially disadvantaged communities  
G - social other  
H - none

**GovernanceThematic**

20290\_Financial\_Instrument\_Governance\_Thematic  
Description of the product thematic investment strategy, according to SFDR art 2(17)  
Multiple answers field  
A - sound management structures  
B - employee relations  
C - remuneration of staff  
D - tax compliance  
E - governance other  
F - none

**SustainableDevelopmentGoals**

20300\_Financial\_Instrument\_Alignment\_With\_Sustainable\_Development\_Goals  
Alignment with SDG means that SDG are used in the investment process (screening) or targeted by the fund. Multiple answers field.  
1 - No Poverty  
2 - Zero Hunger  
3 - Good Health and Well-Being  
4 - Quality Education  
5 - Gender Equality  
6 - Clean Water and Sanitation  
7 - Affordable and Clean Energy  
8 - Decent Work and Economic Growth  
9 - Industry, Innovation and Infrastructure  
10 - Reduced Inequality  
11 - Sustainable Cities and Communities  
12 - Responsible Consumption and Production  
13 - Climate Action  
14 - Life Below Water  
15 - Life on Land  
16 - Peace and Justice, Strong Institutions  
17 - Partnerships to achieve to Goal

|            |  |
|------------|--|
| properties | isRef 0<br>minOcc 0<br>maxOcc 1<br>content complex   |
| children   | <a href="#">ESG_ExistingThematic</a> <a href="#">EnvironmentalThematic</a> <a href="#">SocialThematic</a> <a href="#">GovernanceThematic</a> <a href="#">SustainableDevelopmentGoals</a> |
| annotation | documentation<br>This part describes investment strategy, and is not linked to Taxonomy<br>20260 - 20300   |

element **EETReportType/ESG\_ThematicInvestingDescription/ESG\_ExistingThematic**

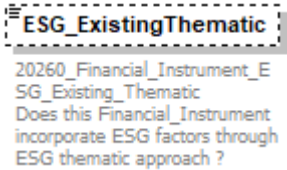
|            |  |
|------------|--|
| diagram    |  <pre> ESG_ExistingThematic 20260_Financial_Instrument_ESG_Existing_Thematic SG_Existing_Thematic Does this Financial_Instrument incorporate ESG factors through ESG thematic approach ? </pre> |
| type       | <a href="#">EETYesNoType</a>   |
| properties | isRef 0<br>minOcc 0<br>maxOcc 1<br>content simple  |
| facets     | Kind Value annotation<br>length 1  |
| annotation | documentation<br>20260_Financial_Instrument_ESG_Existing_Thematic<br>Does this Financial_Instrument incorporate ESG factors through ESG thematic approach ?  |

element **EETReportType/ESG\_ThematicInvestingDescription/EnvironmentalThematic**

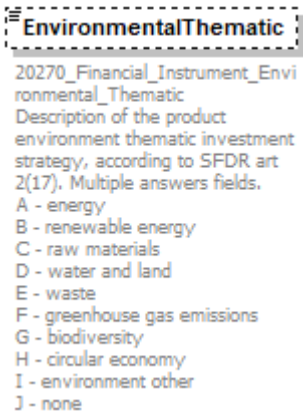
|            |  |
|------------|--|
| diagram    |  <pre> EnvironmentalThematic 20270_Financial_Instrument_Environmental_Thematic Description of the product environment thematic investment strategy, according to SFDR art 2(17). Multiple answers fields. A - energy B - renewable energy C - raw materials D - water and land E - waste F - greenhouse gas emissions G - biodiversity H - circular economy I - environment other J - none </pre> |
| type       | <b>xs:string</b>   |
| properties | isRef 0<br>minOcc 0<br>maxOcc 1<br>content simple  |
| annotation | documentation<br>20270_Financial_Instrument_Environmental_Thematic<br>Description of the product environment thematic investment strategy, according to SFDR art 2(17). Multiple answers fields.<br>A - energy<br>B - renewable energy<br>C - raw materials  |

|  |  |
|--|--|
|  | D - water and land<br>E - waste<br>F - greenhouse gas emissions<br>G - biodiversity<br>H - circular economy<br>I - environment other<br>J - none |
|--|--|

element **EETReportType/ESG\_ThematicInvestingDescription/SocialThematic**

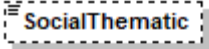
|            |   |
|------------|---|
| diagram    |  <p>20280_Financial_Instrument_Social_Thematic<br/> Description of the product social thematic investment strategy, according to SFDR art 2(17)<br/> Multiple answers fields.<br/> A - inequality<br/> B - social cohesion,<br/> C - social integration<br/> D - labour relations<br/> E - investment in human capital<br/> F - economically or socially disadvantaged communities<br/> G - social other<br/> H - none</p> |
| type       | <b>xs:string</b>  |
| properties | isRef 0<br>minOcc 0<br>maxOcc 1<br>content simple   |
| annotation | documentation<br>20280_Financial_Instrument_Social_Thematic<br>Description of the product social thematic investment strategy, according to SFDR art 2(17)<br>Multiple answers fields.<br>A - inequality<br>B - social cohesion,<br>C - social integration<br>D - labour relations<br>E - investment in human capital<br>F - economically or socially disadvantaged communities<br>G - social other<br>H - none   |

element **EETReportType/ESG\_ThematicInvestingDescription/GovernanceThematic**

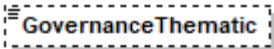
|         |   |
|---------|---|
| diagram |  <p>20290_Financial_Instrument_Governance_Thematic<br/> Description of the product thematic investment strategy, according to SFDR art 2(17)<br/> Multiple answers field<br/> A - sound management structures<br/> B - employee relations<br/> C - remuneration of staff<br/> D - tax compliance<br/> E - governance other<br/> F - none</p> |
| type    | <b>xs:string</b>  |

|            |   |
|------------|---|
| properties | isRef 0<br>minOcc 0<br>maxOcc 1<br>content simple   |
| annotation | documentation<br>20290_Financial_Instrument_Governance_Thematic<br>Description of the product thematic investment strategy, according to SFDR art 2(17)<br>Multiple answers field<br>A - sound management structures<br>B - employee relations<br>C - remuneration of staff<br>D - tax compliance<br>E - governance other<br>F - none |

element **EETReportType/ESG\_ThematicInvestingDescription/SustainableDevelopmentGoals**

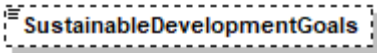
|            |   |
|------------|---|
| diagram    |  <p><b>SustainableDevelopmentGoals</b></p> 20300_Financial_Instrument_Alignment_With_Sustainable_Development_Goals<br>Alignment with SDG means that SDG are used in the investment process (screening) or targeted by the fund. Multiple answers field.<br>1 - No Poverty<br>2 - Zero Hunger<br>3 - Good Health and Well-Being<br>4 - Quality Education<br>5 - Gender Equality<br>6 - Clean Water and Sanitaion<br>7 - Affordable and Clean Energy<br>8 - Decent Work and Economic Growth<br>9 - Industry, Innovation and Infrastructure<br>10 - Reduced Inequality<br>11 - Sustainable Cities and Communities<br>12 - Responsible Consumption and Production<br>13 - Climate Action<br>14 - Life Below Water<br>15 - Life on Land<br>16 - Peace and Justice, Strong Institutions<br>17 - Partnerships to achive to Goal |
| type       | <b>xs:string</b>  |
| properties | isRef 0<br>minOcc 0<br>maxOcc 1<br>content simple   |
| annotation | documentation<br>20300_Financial_Instrument_Alignment_With_Sustainable_Development_Goals<br>Alignment with SDG means that SDG are used in the investment process (screening) or targeted by the fund. Multiple answers field.<br>1 - No Poverty<br>2 - Zero Hunger<br>3 - Good Health and Well-Being<br>4 - Quality Education<br>5 - Gender Equality<br>6 - Clean Water and Sanitaion<br>7 - Affordable and Clean Energy<br>8 - Decent Work and Economic Growth<br>9 - Industry, Innovation and Infrastructure<br>10 - Reduced Inequality<br>11 - Sustainable Cities and Communities<br>12 - Responsible Consumption and Production<br>13 - Climate Action<br>14 - Life Below Water<br>15 - Life on Land<br>16 - Peace and Justice, Strong Institutions   |

element **EETReportType/ESG\_EngagementCoverage**

|            |  |
|------------|--|
| diagram    |  |
| properties | <p>isRef 0<br/> minOcc 0<br/> maxOcc 1<br/> content complex</p>  |
| children   | <p><a href="#">EligibleIssuers</a> <a href="#">ESG_CoveredIssuers</a> <a href="#">EngagedIssuers</a></p> |
| annotation | <p>documentation<br/> 20310 - 20360</p>  |

element **EETReportType/ESG\_EngagementCoverage/EligibleIssuers**

|            |  |
|------------|--|
| diagram    |  |
| type       | <p><a href="#">EETWeightNumberType</a></p>   |
| properties | <p>isRef 0<br/> minOcc 0<br/> maxOcc 1<br/> content complex</p>  |
| children   | <p><a href="#">Weight</a> <a href="#">Number</a></p>   |
| annotation | <p>documentation<br/> 20310_Financial_Instrument_Weight_Of_Eligible_Issuers<br/> 20320_Financial_Instrument_Number_Of_Eligible_Issuers</p> |



element **EETReportType/ESG\_EngagementCoverage/ESG\_CoveredIssuers**

|            |  |
|------------|--|
| diagram    | <p>20330_Financial_Instrument_Weight_Of_ESG_Covered_Issuers<br/>20340_Financial_Instrument_Number_Of_ESG_Covered_Issuers</p>                   |
| type       | <a href="#">EETWeightNumberType</a>  |
| properties | <p>isRef 0<br/>minOcc 0<br/>maxOcc 1<br/>content complex</p>   |
| children   | <a href="#">Weight</a> <a href="#">Number</a>  |
| annotation | <p>documentation<br/>20330_Financial_Instrument_Weight_Of_ESG_Covered_Issuers<br/>20340_Financial_Instrument_Number_Of_ESG_Covered_Issuers</p> |

element **EETReportType/ESG\_EngagementCoverage/EngagedIssuers**

|            |  |
|------------|--|
| diagram    | <p>20350_Financial_Instrument_Weight_Of_Engaged_Issuers<br/>20360_Financial_Instrument_Number_Of_Engaged_Issuers</p>                   |
| type       | <a href="#">EETWeightNumberType</a>  |
| properties | <p>isRef 0<br/>minOcc 0<br/>maxOcc 1<br/>content complex</p>   |
| children   | <a href="#">Weight</a> <a href="#">Number</a>  |
| annotation | <p>documentation<br/>20350_Financial_Instrument_Weight_Of_Engaged_Issuers<br/>20360_Financial_Instrument_Number_Of_Engaged_Issuers</p> |

element **EETReportType/ESG\_Benchmark**

|            |  |
|------------|--|
| diagram    |  |
| properties | isRef 0<br>minOcc 0<br>maxOcc 1<br>content complex                       |
| children   | <a href="#">HasReference_ESG_Benchmark</a> <a href="#">BenchmarkName</a> |
| annotation | documentation<br>20370 - 20380   |

element **EETReportType/ESG\_Benchmark/HasReference\_ESG\_Benchmark**

|            |  |
|------------|--|
| diagram    |  |
| type       | <a href="#">EETYesNoType</a>   |
| properties | isRef 0<br>content simple  |
| facets     | Kind Value annotation<br>length 1  |
| annotation | documentation<br>20370_Financial_Instrument_Has_A_Reference_ESG_Benchmark<br>Has a reference benchmark been designated for the purpose of attaining the environmental or social characteristics promoted by the financial product? |

element **EETReportType/ESG\_Benchmark/BenchmarkName**

|            |   |
|------------|---|
| diagram    |   |
| type       | <b>xs:string</b>  |
| properties | isRef 0<br>minOcc 0<br>maxOcc 1<br>content simple   |
| annotation | documentation<br>20380_Financial_Instrument_Benchmark_Name<br>Identification of benchmark |

element **EETReportType/MinimumSustainableInvestments**

|                   |  |
|-------------------|--|
| <p>diagram</p>    | <p><b>Minimum Sustainable Investme...</b><br/>20390 - 20470</p> <ul style="list-style-type: none"> <li><b>MinimumAssetAllocationDate</b><br/>20390_Financial_Instrument_Minimum_Or_Planned_Asset_Allocation_Date<br/>The date to which the disclosure refer</li> <li><b>MinimumInvestmentsWithEnvir...</b><br/>20400_Financial_Instrument_EU_SFDR_Minimum_Or_Planned_Investments_With_Environmental_Or_Social_Characteristics</li> <li><b>MethodologyForSustainableInve...</b><br/>20410_Financial_Instrument_EU_SFDR_Methodology_For_Sustainable_Investments_Calculation<br/>Revenue(R), Capex(C), Opex(O), other approach(A)</li> <li><b>MinimumInvestmentsSustainab...</b><br/>20420_Financial_Instrument_EU_SFDR_Minimum_Or_Planned_Investments_Sustainable_Investments</li> <li><b>MinimumOtherInvestmentsWith...</b><br/>20430_Financial_Instrument_EU_SFDR_Minimum_Or_Planned_Other_Investments_With_Environmental_Or_Social_Characteristics</li> <li><b>MinimumInvestmentsSustainab...</b><br/>20440_Financial_Instrument_EU_SFDR_Minimum_Or_Planned_Investments_Sustainable_Investments_Environmental</li> <li><b>MinimumInvestmentsSustainab...</b><br/>20450_Financial_Instrument_EU_SFDR_Minimum_Or_Planned_Investments_Sustainable_Investments_Taxonomy_Aligned</li> <li><b>MinimumInvestmentsSustainab...</b><br/>20460_Financial_Instrument_EU_SFDR_Minimum_Or_Planned_Investments_Sustainable_Investments_Other_Environmental</li> <li><b>MinimumInvestmentsSustainab...</b><br/>20470_Financial_Instrument_EU_SFDR_Minimum_Or_Planned_Investments_Sustainable_Investments_Social</li> </ul> |
| <p>properties</p> | <p>isRef 0<br/>minOcc 0<br/>maxOcc 1<br/>content complex</p>   |
| <p>children</p>   | <p><a href="#">MinimumAssetAllocationDate</a> <a href="#">MinimumInvestmentsWithEnvironmentalOrSocialCharacteristics</a> <a href="#">MethodologyForSustainableInvestmentsCalculation</a> <a href="#">MinimumInvestmentsSustainableInvestments</a> <a href="#">MinimumOtherInvestmentsWithEnvironmentalOrSocialCharacteristics</a> <a href="#">MinimumInvestmentsSustainableInvestmentsEnvironmental</a> <a href="#">MinimumInvestmentsSustainableInvestmentsTaxonomyAligned</a> <a href="#">MinimumInvestmentsSustainableInvestmentsOtherEnvironmental</a> <a href="#">MinimumInvestmentsSustainableInvestmentsSocial</a></p>  |

|            |                                |
|------------|--------------------------------|
| annotation | documentation<br>20390 - 20470 |
|------------|--------------------------------|

element **EETReportType/MinimumSustainableInvestments/MinimumAssetAllocationDate**

|            |   |
|------------|---|
| diagram    |  <p>20390_Financial_Instrument_Minimum_Or_Planned_Asset_Allocation_Date<br/>The date to which the disclosure refer</p> |
| type       | <b>xs:date</b>  |
| properties | isRef 0<br>content simple   |
| annotation | documentation<br>20390_Financial_Instrument_Minimum_Or_Planned_Asset_Allocation_Date<br>The date to which the disclosure refer  |

element **EETReportType/MinimumSustainableInvestments/MinimumInvestmentsWithEnvironmentalOrSocialCharacteristics**

|            |   |
|------------|---|
| diagram    |  <p>20400_Financial_Instrument_EU_SFDR_Minimum_Or_Planned_Investments_With_Environmental_Or_Social_Characteristics</p> |
| type       | <b>xs:decimal</b>   |
| properties | isRef 0<br>minOcc 0<br>maxOcc 1<br>content simple   |
| annotation | documentation<br>20400_Financial_Instrument_EU_SFDR_Minimum_Or_Planned_Investments_With_Environmental_Or_Social_Characteristics   |

element **EETReportType/MinimumSustainableInvestments/MethodologyForSustainableInvestmentsCalculation**

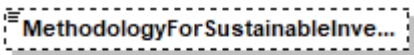
|            |  |
|------------|--|
| diagram    |  <p>20410_Financial_Instrument_EU_SFDR_Methodology_For_Sustainable_Investments_Calculation<br/>Revenue(R), Capex(C), Opex(O), other approach(A)</p> |
| type       | restriction of <b>xs:string</b>  |
| properties | isRef 0<br>minOcc 0<br>maxOcc 1<br>content simple  |
| annotation | documentation<br>20410_Financial_Instrument_EU_SFDR_Methodology_For_Sustainable_Investments_Calculation<br>Revenue(R), Capex(C), Opex(O), other approach(A)  |

element

### EETReportType/MinimumSustainableInvestments/MinimumInvestmentsSustainableInvestments

|            |  |
|------------|--|
| diagram    |  <b>MinimumInvestmentsSustainab...</b><br>20420_Financial_Instrument_EU_SFDR_Minimum_Or_Planned_Investments_Sustainable_Investments |
| type       | <b>xs:decimal</b>  |
| properties | isRef 0<br>minOcc 0<br>maxOcc 1<br>content simple  |
| annotation | documentation<br>20420_Financial_Instrument_EU_SFDR_Minimum_Or_Planned_Investments_Sustainable_Investments   |

element

### EETReportType/MinimumSustainableInvestments/MinimumOtherInvestmentsWithEnvironmentalOrSocialCharacteristics

|            |   |
|------------|---|
| diagram    |  <b>MinimumOtherInvestmentsWith...</b><br>20430_Financial_Instrument_EU_SFDR_Minimum_Or_Planned_Other_Investments_With_Environmental_Or_Social_Characteristics |
| type       | <b>xs:decimal</b>   |
| properties | isRef 0<br>minOcc 0<br>maxOcc 1<br>content simple   |
| annotation | documentation<br>20430_Financial_Instrument_EU_SFDR_Minimum_Or_Planned_Other_Investments_With_Environmental_Or_Social_Characteristics   |

element

### EETReportType/MinimumSustainableInvestments/MinimumInvestmentsSustainableInvestmentsEnvironmental

|            |  |
|------------|--|
| diagram    |  <b>MinimumInvestmentsSustainab...</b><br>20440_Financial_Instrument_EU_SFDR_Minimum_Or_Planned_Investments_Sustainable_Investments_Environmental |
| type       | <b>xs:decimal</b>  |
| properties | isRef 0<br>minOcc 0<br>maxOcc 1<br>content simple  |
| annotation | documentation<br>20440_Financial_Instrument_EU_SFDR_Minimum_Or_Planned_Investments_Sustainable_Investments_Environmental   |

element

**EETReportType/MinimumSustainableInvestments/MinimumInvestmentsSustainableInvestmentsTaxonomyAligned**

|            |   |
|------------|---|
| diagram    |  <b>MinimumInvestmentsSustainab...</b><br>20450_Financial_Instrument_EU_SFDR_Minimum_Or_Planned_Investments_Sustainable_Investments_Taxonomy_Aligned |
| type       | <b>xs:decimal</b>   |
| properties | isRef 0<br>minOcc 0<br>maxOcc 1<br>content simple   |
| annotation | documentation<br>20450_Financial_Instrument_EU_SFDR_Minimum_Or_Planned_Investments_Sustainable_Investments_Taxonomy_Aligned   |

element

**EETReportType/MinimumSustainableInvestments/MinimumInvestmentsSustainableInvestmentsOtherEnvironmental**

|            |  |
|------------|--|
| diagram    |  <b>MinimumInvestmentsSustainab...</b><br>20460_Financial_Instrument_EU_SFDR_Minimum_Or_Planned_Investments_Sustainable_Investments_Other_Environmental |
| type       | <b>xs:decimal</b>  |
| properties | isRef 0<br>minOcc 0<br>maxOcc 1<br>content simple  |
| annotation | documentation<br>20460_Financial_Instrument_EU_SFDR_Minimum_Or_Planned_Investments_Sustainable_Investments_Other_Environmental   |

element

**EETReportType/MinimumSustainableInvestments/MinimumInvestmentsSustainableInvestmentsSocial**

|            |   |
|------------|---|
| diagram    |  <b>MinimumInvestmentsSustainab...</b><br>20470_Financial_Instrument_EU_SFDR_Minimum_Or_Planned_Investments_Sustainable_Investments_Social |
| type       | <b>xs:decimal</b>   |
| properties | isRef 0<br>minOcc 0<br>maxOcc 1<br>content simple   |
| annotation | documentation<br>20470_Financial_Instrument_EU_SFDR_Minimum_Or_Planned_Investments_Sustainable_Investments_Social   |

element **EETReportType/LastReportedSustainableInvestments**

|                   |   |
|-------------------|---|
| <p>diagram</p>    | <p><b>LastReportedSustainableInves...</b><br/>20480 - 20560</p> <ul style="list-style-type: none"> <li><b>LastReportedAssetAllocationDate</b><br/>20480_Financial_Instrument_Last_Reported_Asset_Allocation_Date<br/>The date to which the disclosure refer</li> <li><b>LastReportedInvestmentsWithE...</b><br/>20490_Financial_Instrument_EU_SFDR_Last_Reported_Investments_With_Environmental_Or_Social_Characteristics</li> <li><b>LastReportedInvestmentsNotSu...</b><br/>20500_Financial_Instrument_EU_SFDR_Last_Reported_Investments_Not_Sustainable_Other</li> <li><b>LastReportedInvestments Susta...</b><br/>20510_Financial_Instrument_EU_SFDR_Last_Reported_Investments_Are_Sustainable_Investments</li> <li><b>LastReportedOtherInvestments...</b><br/>20520_Financial_Instrument_EU_SFDR_Last_Reported_Other_Investments_With_Environmental_Or_Social_Characteristics</li> <li><b>LastReportedInvestments Susta...</b><br/>20530_Financial_Instrument_EU_SFDR_Last_Reported_Investments_Are_Sustainable_Investments_Environmental</li> <li><b>LastReportedInvestments Susta...</b><br/>20540_Financial_Instrument_EU_SFDR_Last_Reported_Investments_Are_Sustainable_Investments_Taxonomy_Aligned</li> <li><b>LastReportedInvestments Susta...</b><br/>20550_Financial_Instrument_EU_SFDR_Last_Reported_Investments_Are_Sustainable_Investments_Other_Environmental</li> <li><b>LastReportedInvestments Susta...</b><br/>20560_Financial_Instrument_EU_SFDR_Last_Reported_Investments_Are_Sustainable_Investments_Social</li> </ul> |
| <p>properties</p> | <p>isRef 0<br/>minOcc 0<br/>maxOcc 1<br/>content complex</p>  |
| <p>children</p>   | <p><a href="#">LastReportedAssetAllocationDate</a> <a href="#">LastReportedInvestmentsWithEnvironmentalOrSocialCharacteristics</a> <a href="#">LastReportedInvestmentsNotSustainableOther</a> <a href="#">LastReportedInvestmentsSustainableInvestments</a> <a href="#">LastReportedOtherInvestmentsWithEnvironmentalOrSocialCharacteristics</a> <a href="#">LastReportedInvestmentsSustainableInvestmentsEnvironmental</a> <a href="#">LastReportedInvestmentsSustainableInvestmentsTaxonomyAligned</a> <a href="#">LastReportedInvestmentsSustainableInvestmentsOtherEnvironmental</a> <a href="#">LastReportedInvestmentsSustainableInvestmentsSocial</a></p>  |
| <p>annotation</p> | <p>documentation<br/>20480 - 20560</p>  |

element **EETReportType/LastReportedSustainableInvestments/LastReportedAssetAllocationDate**

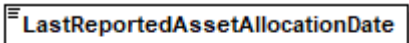
|            |  |
|------------|--|
| diagram    |  <p>20480_Financial_Instrument_Last_Reported_Asset_Allocation_Date<br/>The date to which the disclosure refer</p> |
| type       | <b>xs:date</b>   |
| properties | isRef 0<br>content simple  |
| annotation | documentation<br>20480_Financial_Instrument_Last_Reported_Asset_Allocation_Date<br>The date to which the disclosure refer  |

element **EETReportType/LastReportedSustainableInvestments/LastReportedInvestmentsWithEnvironmentalOrSocialCharacteristics**

|            |  |
|------------|--|
| diagram    |  <p>20490_Financial_Instrument_EU_SFDR_Last_Reported_Investments_With_Environmental_Or_Social_Characteristics</p> |
| type       | <b>xs:decimal</b>  |
| properties | isRef 0<br>minOcc 0<br>maxOcc 1<br>content simple  |
| annotation | documentation<br>20490_Financial_Instrument_EU_SFDR_Last_Reported_Investments_With_Environmental_Or_Social_Characteristics   |

element **EETReportType/LastReportedSustainableInvestments/LastReportedInvestmentsNotSustainableOther**

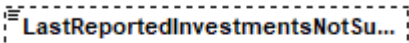
|            |   |
|------------|---|
| diagram    |  <p>20500_Financial_Instrument_EU_SFDR_Last_Reported_Investments_Not_Sustainable_Other</p> |
| type       | <b>xs:decimal</b>   |
| properties | isRef 0<br>minOcc 0<br>maxOcc 1<br>content simple   |
| annotation | documentation<br>20500_Financial_Instrument_EU_SFDR_Last_Reported_Investments_Not_Sustainable_Other   |

element **EETReportType/LastReportedSustainableInvestments/LastReportedInvestmentsSustainableInvestments**

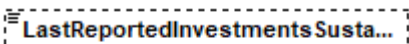
|         |   |
|---------|---|
| diagram |  <p>20510_Financial_Instrument_EU_SFDR_Last_Reported_Investments_Are_Sustainable_Investments</p> |
|---------|---|



|            |   |
|------------|---|
| type       | <b>xs:decimal</b>   |
| properties | isRef 0<br>minOcc 0<br>maxOcc 1<br>content simple   |
| annotation | documentation<br>20510_Financial_Instrument_EU_SFDR_Last_Reported_Investments_Are_Sustainable_Investments |

element

**EETReportType/LastReportedSustainableInvestments/LastReportedOtherInvestmentsWithEnvironmentalOrSocialCharacteristics**

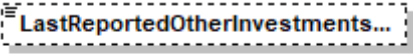
|            |  |
|------------|--|
| diagram    |  <p>20520_Financial_Instrument_EU_SFDR_Last_Reported_Other_Investments_With_Environmental_Or_Social_Characteristics</p> |
| type       | <b>xs:decimal</b>  |
| properties | isRef 0<br>minOcc 0<br>maxOcc 1<br>content simple  |
| annotation | documentation<br>20520_Financial_Instrument_EU_SFDR_Last_Reported_Other_Investments_With_Environmental_Or_Social_Characteristics   |

element

**EETReportType/LastReportedSustainableInvestments/LastReportedInvestmentsSustainableInvestmentsEnvironmental**

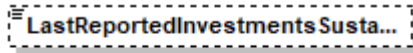
|            |   |
|------------|---|
| diagram    |  <p>20530_Financial_Instrument_EU_SFDR_Last_Reported_Investments_Are_Sustainable_Investments_Environmental</p> |
| type       | <b>xs:decimal</b>   |
| properties | isRef 0<br>minOcc 0<br>maxOcc 1<br>content simple   |
| annotation | documentation<br>20530_Financial_Instrument_EU_SFDR_Last_Reported_Investments_Are_Sustainable_Investments_Environmental   |

element

**EETReportType/LastReportedSustainableInvestments/LastReportedInvestmentsSustainableInvestmentsTaxonomyAligned**

|            |  |
|------------|--|
| diagram    |  <p>20540_Financial_Instrument_EU_SFDR_Last_Reported_Investments_Are_Sustainable_Investments_Taxonomy_Aligned</p> |
| type       | <b>xs:decimal</b>  |
| properties | isRef 0<br>minOcc 0<br>maxOcc 1  |

|            |  |
|------------|--|
|            | content simple   |
| annotation | documentation<br>20540_Financial_Instrument_EU_SFDR_Last_Reported_Investments_Are_Sustainable_Investments_Taxonomy_Aligned |

element

**EETReportType/LastReportedSustainableInvestments/LastReportedInvestmentsSustainableInvestment  
sOtherEnvironmental**

|            |   |
|------------|---|
| diagram    |   |
| type       | <b>xs:decimal</b>   |
| properties | isRef 0<br>minOcc 0<br>maxOcc 1<br>content simple   |
| annotation | documentation<br>20550_Financial_Instrument_EU_SFDR_Last_Reported_Investments_Are_Sustainable_Investments_Other_Environmental |

element

**EETReportType/LastReportedSustainableInvestments/LastReportedInvestmentsSustainableInvestment  
sSocial**

|            |  |
|------------|--|
| diagram    |  |
| type       | <b>xs:decimal</b>  |
| properties | isRef 0<br>minOcc 0<br>maxOcc 1<br>content simple  |
| annotation | documentation<br>20560_Financial_Instrument_EU_SFDR_Last_Reported_Investments_Are_Sustainable_Investments_Social |

element **EETReportType/AdditionalInfoArt9**

|            |   |
|------------|---|
| diagram    |   |
| properties | isRef 0<br>minOcc 0<br>maxOcc 1<br>content complex  |
| children   | <a href="#">ObjectiveReductionInCarbonEmissions</a> <a href="#">AlignedWithParisAgreement</a> |

|            |                                |
|------------|--------------------------------|
| annotation | documentation<br>20570 - 20580 |
|------------|--------------------------------|

element **EETReportType/AdditionalInfoArt9/ObjectiveReductionInCarbonEmissions**

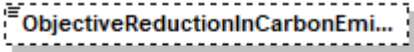
|            |  |
|------------|--|
| diagram    |  <p>20570_Financial_Instrument_With_Objective_Of_A_Reduction_In_Carbon_Emissions<br/>Does the Financial Instrument have the objective of reduction in carbon emissions?</p> |
| type       | <a href="#">EETYesNoType</a>   |
| properties | isRef 0<br>minOcc 0<br>maxOcc 1<br>content simple  |
| facets     | Kind Value annotation<br>length 1  |
| annotation | documentation<br>20570_Financial_Instrument_With_Objective_Of_A_Reduction_In_Carbon_Emissions<br>Does the Financial Instrument have the objective of reduction in carbon emissions?  |

element **EETReportType/AdditionalInfoArt9/AlignedWithParisAgreement**

|            |  |
|------------|--|
| diagram    |  <p>20580_Financial_Instrument_Aligned_With_Paris_Agreement<br/>Is the Financial Instrument Aligned with the Paris Agreement?</p> |
| type       | <a href="#">EETYesNoType</a>   |
| properties | isRef 0<br>minOcc 0<br>maxOcc 1<br>content simple  |
| facets     | Kind Value annotation<br>length 1  |
| annotation | documentation<br>20580_Financial_Instrument_Aligned_With_Paris_Agreement<br>Is the Financial Instrument Aligned with the Paris Agreement?  |

element **EETReportType/MiFID\_IDD\_TargetMarket**

|            |   |
|------------|---|
| diagram    |  <p>20590<br/>20590_Does_This_Financial_Instrument_Consider_End_Client_Sustainability_Preferences</p> |
| properties | isRef 0<br>content complex  |
| children   | <a href="#">End Client Sustainability Preferences Considered</a>  |
| annotation | documentation<br>20590  |

element **EETReportType/MiFID\_IDD\_TargetMarket/End\_Client\_Sustainability\_Preferences\_Considered**

|            |  |
|------------|--|
| diagram    |  <p>20590_Does_This_Financial_Instrument_Consider_End_Client_Sustainability_Preferences</p> |
| type       | <a href="#">EETYesNeutralType</a>  |
| properties | isRef 0<br>content simple  |
| facets     | Kind Value annotation<br>minLength 1<br>maxLength 7  |
| annotation | documentation<br>20590_Does_This_Financial_Instrument_Consider_End_Client_Sustainability_Preferences   |

element **EETReportType/TaxonomyAlignedInvestments**

diagram



|            |   |
|------------|---|
| properties | isRef 0<br>minOcc 0<br>maxOcc 1<br>content complex  |
| children   | <a href="#">MinimumInvestments EU Taxonomy InclSovereignBonds</a><br><a href="#">MinimumInvestments EU Taxonomy ExclSovereignBonds SubjectToExternalReviewByThirdParty</a><br><a href="#">MethodologyUsedForAlignmentCalculationWith EU Taxonomy MinimumShareOfTransitionalActivities</a><br><a href="#">MinimumShareOfEnablingActivities TaxonomyAlignedInclSovereignRevenue TaxonomyAlignedInclSovereignCapex</a><br><a href="#">TaxonomyAlignedInclSovereignOpex TaxonomyAlignedExclSovereignRevenue</a><br><a href="#">TaxonomyAlignedExclSovereignCapex TaxonomyAlignedExclSovereignOpex ClimateChangeMitigation</a><br><a href="#">ClimateChangeAdaptation SustainableUseAndProtectionOfWaterAndMarineResources</a><br><a href="#">TransitionToCircularEconomy PollutionPreventionAndControl</a><br><a href="#">ProtectionAndRestorationOfBiodiversityAndEcosystems ShareOfTransitionalActivities ShareOfEnablingActivities</a> |
| annotation | documentation<br>20600 - 20790  |

element

**EETReportType/TaxonomyAlignedInvestments/MinimumInvestments\_EU\_Taxonomy\_InclSovereignBonds**

|            |  |
|------------|--|
| diagram    |  <b>MinimumInvestments_EU_Taxo...</b><br>20600_Financial_Instrument_Minimum_Percentage_Investments_Aligned_EU_Taxonomy_Incl_Sovereign_Bonds |
| type       | <b>xs:decimal</b>  |
| properties | isRef 0<br>minOcc 0<br>maxOcc 1<br>content simple  |
| annotation | documentation<br>20600_Financial_Instrument_Minimum_Percentage_Investments_Aligned_EU_Taxonomy_Incl_Sovereign_Bonds  |

element

**EETReportType/TaxonomyAlignedInvestments/MinimumInvestments\_EU\_Taxonomy\_ExclSovereignBonds**

|            |  |
|------------|--|
| diagram    |  <b>MinimumInvestments_EU_Taxo...</b><br>20610_Financial_Instrument_Minimum_Percentage_Investments_Aligned_EU_Taxonomy_Excl_Sovereign_Bonds |
| type       | <b>xs:decimal</b>  |
| properties | isRef 0<br>minOcc 0<br>maxOcc 1<br>content simple  |
| annotation | documentation<br>20610_Financial_Instrument_Minimum_Percentage_Investments_Aligned_EU_Taxonomy_Excl_Sovereign_Bonds  |

element **EETReportType/TaxonomyAlignedInvestments/SubjectToExternalReviewByThirdParty**

|         |   |
|---------|---|
| diagram |  <b>SubjectToExternalReviewByThir...</b><br>20620_Financial_Instrument_Was_This_Statement_Subject_To_An_External_Review_By_Third_Party |
|---------|---|

|            |   |
|------------|---|
| type       | <a href="#">EETYesNoType</a>  |
| properties | isRef 0<br>minOcc 0<br>maxOcc 1<br>content simple   |
| facets     | Kind Value annotation<br>length 1   |
| annotation | documentation<br>20620_Financial_Instrument_Was_This_Statement_Subject_To_An_External_Review_By_Third_Party |

element

**EETReportType/TaxonomyAlignedInvestments/MethodologyUsedForAlignmentCalculationWith\_EU\_Taxonomy**

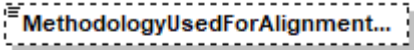
|            |   |
|------------|---|
| diagram    |  <p>20630_Financial_Instrument_Methodology_Used_For_Alignment_Calculation_With_EU_Taxonomy<br/>Discloses the methodology used for alignment calculation with the EU Taxonomy, defined as either Revenue (R), CapEx (C) or OpEx (O)</p> |
| type       | restriction of <b>xs:string</b>   |
| properties | isRef 0<br>minOcc 0<br>maxOcc 1<br>content simple   |
| annotation | documentation<br>20630_Financial_Instrument_Methodology_Used_For_Alignment_Calculation_With_EU_Taxonomy<br>Discloses the methodology used for alignment calculation with the EU Taxonomy, defined as either Revenue (R), CapEx (C) or OpEx (O)  |

element **EETReportType/TaxonomyAlignedInvestments/MinimumShareOfTransitionalActivities**

|            |  |
|------------|--|
| diagram    |  <p>20640_Financial_Instrument_Minimum_Share_Of_Transitional_Activities</p> |
| type       | <b>xs:decimal</b>  |
| properties | isRef 0<br>minOcc 0<br>maxOcc 1<br>content simple  |
| annotation | documentation<br>20640_Financial_Instrument_Minimum_Share_Of_Transitional_Activities   |

element **EETReportType/TaxonomyAlignedInvestments/MinimumShareOfEnablingActivities**

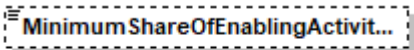
|            |  |
|------------|--|
| diagram    |  <p>20650_Financial_Instrument_Minimum_Share_Of_Enabling_Activities</p> |
| type       | <b>xs:decimal</b>  |
| properties | isRef 0<br>minOcc 0<br>maxOcc 1  |

|            |  |
|------------|--|
|            | content simple   |
| annotation | documentation<br>20650_Financial_Instrument_Minimum_Share_Of_Enabling_Activities |

element **EETReportType/TaxonomyAlignedInvestments/TaxonomyAlignedInclSovereignRevenue**

|            |   |
|------------|---|
| diagram    |  <b>TaxonomyAlignedInclSovereign...</b><br>20660_Financial_Instrument_Percentage_Taxonomy_Aligned_Incl_Sovereign_Revenue |
| type       | <b>xs:decimal</b>   |
| properties | isRef 0<br>minOcc 0<br>maxOcc 1<br>content simple   |
| annotation | documentation<br>20660_Financial_Instrument_Percentage_Taxonomy_Aligned_Incl_Sovereign_Revenue  |

element **EETReportType/TaxonomyAlignedInvestments/TaxonomyAlignedInclSovereignCapex**

|            |   |
|------------|---|
| diagram    |  <b>TaxonomyAlignedInclSovereign...</b><br>20670_Financial_Instrument_Percentage_Taxonomy_Aligned_Incl_Sovereign_Capex |
| type       | <b>xs:decimal</b>   |
| properties | isRef 0<br>minOcc 0<br>maxOcc 1<br>content simple   |
| annotation | documentation<br>20670_Financial_Instrument_Percentage_Taxonomy_Aligned_Incl_Sovereign_Capex  |

element **EETReportType/TaxonomyAlignedInvestments/TaxonomyAlignedInclSovereignOpex**

|            |  |
|------------|--|
| diagram    |  <b>TaxonomyAlignedInclSovereign...</b><br>20680_Financial_Instrument_Percentage_Taxonomy_Aligned_Incl_Sovereign_Opex |
| type       | <b>xs:decimal</b>  |
| properties | isRef 0<br>minOcc 0<br>maxOcc 1<br>content simple  |
| annotation | documentation<br>20680_Financial_Instrument_Percentage_Taxonomy_Aligned_Incl_Sovereign_Opex  |

element **EETReportType/TaxonomyAlignedInvestments/TaxonomyAlignedExclSovereignRevenue**

|         |   |
|---------|---|
| diagram |  <b>TaxonomyAlignedExclSovereign...</b><br>20690_Financial_Instrument_Percentage_Taxonomy_Aligned_Excl_Sovereign_Revenue |
| type    | <b>xs:decimal</b>   |



|            |  |
|------------|--|
| properties | isRef 0<br>minOcc 0<br>maxOcc 1<br>content simple  |
| annotation | documentation<br>20690_Financial_Instrument_Percentage_Taxonomy_Aligned_Excl_Sovereign_Revenue |

element **EETReportType/TaxonomyAlignedInvestments/TaxonomyAlignedExclSovereignCapex**

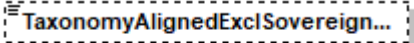
|            |  |
|------------|--|
| diagram    | <br>20700_Financial_Instrument_Percentage_Taxonomy_Aligned_Excl_Sovereign_Capex |
| type       | <b>xs:decimal</b>  |
| properties | isRef 0<br>minOcc 0<br>maxOcc 1<br>content simple  |
| annotation | documentation<br>20700_Financial_Instrument_Percentage_Taxonomy_Aligned_Excl_Sovereign_Capex   |

element **EETReportType/TaxonomyAlignedInvestments/TaxonomyAlignedExclSovereignOpex**

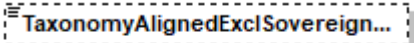
|            |   |
|------------|---|
| diagram    | <br>20710_Financial_Instrument_Percentage_Taxonomy_Aligned_Excl_Sovereign_Opex |
| type       | <b>xs:decimal</b>   |
| properties | isRef 0<br>minOcc 0<br>maxOcc 1<br>content simple   |
| annotation | documentation<br>20710_Financial_Instrument_Percentage_Taxonomy_Aligned_Excl_Sovereign_Opex   |

element **EETReportType/TaxonomyAlignedInvestments/ClimateChangeMitigation**

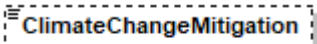
|            |   |
|------------|---|
| diagram    | <br>20720_Financial_Instrument_Climate_Change_Mitigation |
| type       | <a href="#">EETYesNoType</a>  |
| properties | isRef 0<br>minOcc 0<br>maxOcc 1<br>content simple   |
| facets     | Kind Value annotation<br>length 1   |
| annotation | documentation<br>20720_Financial_Instrument_Climate_Change_Mitigation   |

element **EETReportType/TaxonomyAlignedInvestments/ClimateChangeAdaptation**

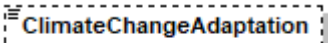
|            |   |
|------------|---|
| diagram    |  <p>20730_Financial_Instrument_Climate_Change_Adaptation</p> |
| type       | <a href="#">EETYesNoType</a>  |
| properties | isRef 0<br>minOcc 0<br>maxOcc 1<br>content simple   |
| facets     | Kind Value annotation<br>length 1   |
| annotation | documentation<br>20730_Financial_Instrument_Climate_Change_Adaptation   |

element

**EETReportType/TaxonomyAlignedInvestments/SustainableUseAndProtectionOfWaterAndMarineResources**

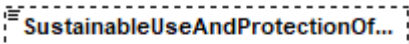
|            |  |
|------------|--|
| diagram    |  <p>20740_Financial_Instrument_Sustainable_Use_And_Protection_Of_Water_And_Marine_Resources</p> |
| type       | <a href="#">EETYesNoType</a>   |
| properties | isRef 0<br>minOcc 0<br>maxOcc 1<br>content simple  |
| facets     | Kind Value annotation<br>length 1  |
| annotation | documentation<br>20740_Financial_Instrument_Sustainable_Use_And_Protection_Of_Water_And_Marine_Resources   |

element **EETReportType/TaxonomyAlignedInvestments/TransitionToCircularEconomy**

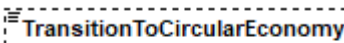
|            |  |
|------------|--|
| diagram    |  <p>20750_Financial_Instrument_Transition_To_A_Circular_Economy</p> |
| type       | <a href="#">EETYesNoType</a>   |
| properties | isRef 0<br>minOcc 0<br>maxOcc 1<br>content simple  |
| facets     | Kind Value annotation<br>length 1  |
| annotation | documentation<br>20750_Financial_Instrument_Transition_To_A_Circular_Economy   |

element **EETReportType/TaxonomyAlignedInvestments/PollutionPreventionAndControl**

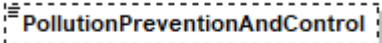
|            |   |
|------------|---|
| diagram    |  <p><b>PollutionPreventionAndControl</b><br/>20760_Financial_Instrument_Pollution_Prevention_And_Control</p> |
| type       | <a href="#">EETYesNoType</a>  |
| properties | isRef 0<br>minOcc 0<br>maxOcc 1<br>content simple   |
| facets     | Kind Value annotation<br>length 1   |
| annotation | documentation<br>20760_Financial_Instrument_Pollution_Prevention_And_Control  |

element

**EETReportType/TaxonomyAlignedInvestments/ProtectionAndRestorationOfBiodiversityAndEcosystems**

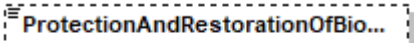
|            |   |
|------------|---|
| diagram    |  <p><b>ProtectionAndRestorationOfBio...</b><br/>20770_Financial_Instrument_Protection_And_Restoration_Of_Biodiversity_And_Ecosystems</p> |
| type       | <a href="#">EETYesNoType</a>  |
| properties | isRef 0<br>minOcc 0<br>maxOcc 1<br>content simple   |
| facets     | Kind Value annotation<br>length 1   |
| annotation | documentation<br>20770_Financial_Instrument_Protection_And_Restoration_Of_Biodiversity_And_Ecosystems   |

element **EETReportType/TaxonomyAlignedInvestments/ShareOfTransitionalActivities**

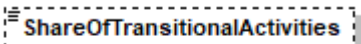
|            |   |
|------------|---|
| diagram    |  <p><b>ShareOfTransitionalActivities</b><br/>20780_Financial_Instrument_Share_Of_Transitional_Activities</p> |
| type       | <b>xs:decimal</b>   |
| properties | isRef 0<br>minOcc 0<br>maxOcc 1<br>content simple   |
| annotation | documentation<br>20780_Financial_Instrument_Share_Of_Transitional_Activities  |

element **EETReportType/TaxonomyAlignedInvestments/ShareOfEnablingActivities**

|         |   |
|---------|---|
| diagram |  <p><b>ShareOfEnablingActivities</b><br/>20790_Financial_Instrument_Share_Of_Enabling_Activities</p> |
| type    | <b>xs:decimal</b>   |

|            |  |
|------------|--|
| properties | isRef 0<br>minOcc 0<br>maxOcc 1<br>content simple                        |
| annotation | documentation<br>20790_Financial_Instrument_Share_Of_Enabling_Activities |

element **EETReportType/PrincipalAdverseIndicators**

|            |  |
|------------|--|
| diagram    |  |
| properties | isRef 0<br>minOcc 0<br>maxOcc 1<br>content complex   |
| children   | <a href="#">BeginningOfReferencePeriod</a> <a href="#">EndOfReferencePeriod</a> <a href="#">ClimateAndEnvironmentRelatedIndicators</a> <a href="#">SocialAndEmployeeMatters</a> <a href="#">SovereignAndSupranationalInvestments</a> <a href="#">RealEstateInvestments</a> <a href="#">MoreClimateAndEnvironmentRelatedIndicators</a> <a href="#">MoreSocialAndEmployeeMatters</a> |
| annotation | documentation<br>30000 - 33440   |

element **EETReportType/PrincipalAdverseIndicators/BeginningOfReferencePeriod**

|            |                           |
|------------|---------------------------|
| diagram    |                           |
| type       | <b>xs:date</b>            |
| properties | isRef 0<br>content simple |

|            |  |
|------------|--|
| annotation | documentation<br>30000_PAI_Beginning_Of_Reference_Period |
|------------|--|

element **EETReportType/PrincipalAdverseIndicators/EndOfReferencePeriod**

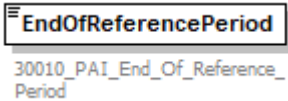
|            |   |
|------------|---|
| diagram    |  |
| type       | <b>xs:date</b>  |
| properties | isRef 0<br>content simple   |
| annotation | documentation<br>30010_PAI_End_Of_Reference_Period                                |

element **EETReportType/PrincipalAdverseIndicators/ClimateAndEnvironmentRelatedIndicators**

|                   |  |
|-------------------|--|
| <p>diagram</p>    |  |
| <p>properties</p> | <p>isRef 0<br/>minOcc 0<br/>maxOcc 1<br/>content complex</p>   |
| <p>children</p>   | <p><a href="#">GreenhousegasEmissions</a> <a href="#">CarbonFootprintScope12</a> <a href="#">CarbonFootprintScope123</a><br/><a href="#">GHG_IntensityOfInvesteeCompaniesScope12</a> <a href="#">GHG_IntensityOfInvesteeCompaniesScope123</a><br/><a href="#">ExposureToCompaniesActiveInTheFossilFuelSector</a> <a href="#">EnergyConsumptionFromNonRenewableSources</a><br/><a href="#">EnergyProductionFromNonRenewableSources</a> <a href="#">EnergyConsumptionIntensityPerHighImpactClimateSector</a><br/><a href="#">ActivitiesNegativelyAffectingBiodiversitySensitiveAreas</a> <a href="#">WaterEmissions</a> <a href="#">HazardousWaste</a></p> |
| <p>annotation</p> | <p>documentation<br/>30020 - 30970</p>   |

element

**EETReportType/PrincipalAdverseIndicators/ClimateAndEnvironmentRelatedIndicators/Greenhousegas Emissions**

|                   |  |
|-------------------|--|
| <p>diagram</p>    |  |
| <p>properties</p> | <p>isRef 0<br/>minOcc 0<br/>maxOcc 1<br/>content complex</p>   |
| <p>children</p>   | <p><a href="#">Scope1</a> <a href="#">Scope2</a> <a href="#">Scope3</a> <a href="#">TotalScope12</a> <a href="#">TotalScope123</a></p> |
| <p>annotation</p> | <p>documentation<br/>30020 - 30210</p>   |

element

**EETReportType/PrincipalAdverseIndicators/ClimateAndEnvironmentRelatedIndicators/Greenhousegas Emissions/Scope1**

|                   |  |
|-------------------|--|
| <p>diagram</p>    |  |
| <p>type</p>       | <p><a href="#">ValueStrategyCoverageType</a></p> |
| <p>properties</p> | <p>isRef 0</p>                                   |

|            |  |
|------------|--|
|            | minOcc 0<br>maxOcc 1<br>content complex  |
| children   | <a href="#">Value</a> <a href="#">ConsideredInInvestmentStrategy</a> <a href="#">Coverage</a> <a href="#">EligibleAssets</a> |
| annotation | documentation<br>30020 - 30050   |

element

**EETReportType/PrincipalAdverseIndicators/ClimateAndEnvironmentRelatedIndicators/Greenhousegas Emissions/Scope2**

|            |  |
|------------|--|
| diagram    |  |
| type       | <a href="#">ValueStrategyCoverageType</a>  |
| properties | isRef 0<br>minOcc 0<br>maxOcc 1<br>content complex   |
| children   | <a href="#">Value</a> <a href="#">ConsideredInInvestmentStrategy</a> <a href="#">Coverage</a> <a href="#">EligibleAssets</a> |
| annotation | documentation<br>30060 - 30090   |



element

**EETReportType/PrincipalAdverseIndicators/ClimateAndEnvironmentRelatedIndicators/Greenhousegas Emissions/Scope3**

|                   |   |
|-------------------|---|
| <p>diagram</p>    |   |
| <p>type</p>       | <p><a href="#">ValueStrategyCoverageType</a></p>  |
| <p>properties</p> | <p>isRef 0<br/>minOcc 0<br/>maxOcc 1<br/>content complex</p>  |
| <p>children</p>   | <p><a href="#">Value</a> <a href="#">ConsideredInInvestmentStrategy</a> <a href="#">Coverage</a> <a href="#">EligibleAssets</a></p> |
| <p>annotation</p> | <p>documentation<br/>30100 - 30130</p>  |

element

**EETReportType/PrincipalAdverseIndicators/ClimateAndEnvironmentRelatedIndicators/Greenhousegas Emissions/TotalScope12**

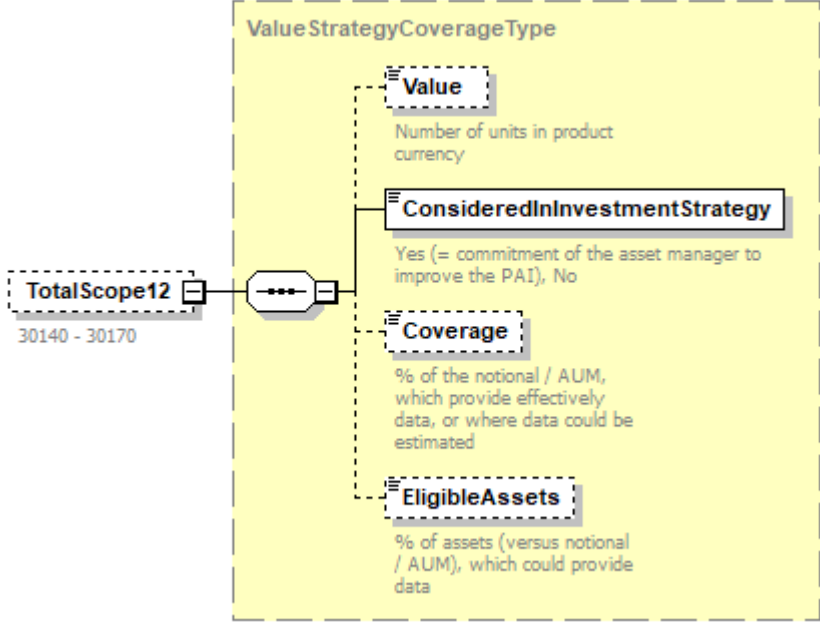
|            |   |
|------------|---|
| diagram    |  <p>The diagram illustrates the structure of the <b>ValueStrategyCoverageType</b> element. It is a complex type containing four sub-elements: <b>Value</b>, <b>ConsideredInInvestmentStrategy</b>, <b>Coverage</b>, and <b>EligibleAssets</b>. The <b>Value</b> element is described as the "Number of units in product currency". The <b>ConsideredInInvestmentStrategy</b> element is a boolean type with the description "Yes (= commitment of the asset manager to improve the PAI), No". The <b>Coverage</b> element is described as "% of the notional / AUM, which provide effectively data, or where data could be estimated". The <b>EligibleAssets</b> element is described as "% of assets (versus notional / AUM), which could provide data". The entire structure is enclosed in a dashed box labeled <b>ValueStrategyCoverageType</b>. To the left, a separate dashed box labeled <b>TotalScope12</b> with the range "30140 - 30170" is connected to the main structure by a line with a central circle and arrows, indicating a relationship or reference.</p> |
| type       | <a href="#">ValueStrategyCoverageType</a>   |
| properties | isRef 0<br>minOcc 0<br>maxOcc 1<br>content complex  |
| children   | <a href="#">Value</a> <a href="#">ConsideredInInvestmentStrategy</a> <a href="#">Coverage</a> <a href="#">EligibleAssets</a>  |
| annotation | documentation<br>30140 - 30170  |

element

**EETReportType/PrincipalAdverseIndicators/ClimateAndEnvironmentRelatedIndicators/Greenhousegas Emissions/TotalScope123**

|                   |   |
|-------------------|---|
| <p>diagram</p>    |   |
| <p>type</p>       | <p><a href="#">ValueStrategyCoverageType</a></p>  |
| <p>properties</p> | <p>isRef 0<br/>minOcc 0<br/>maxOcc 1<br/>content complex</p>  |
| <p>children</p>   | <p><a href="#">Value</a> <a href="#">ConsideredInInvestmentStrategy</a> <a href="#">Coverage</a> <a href="#">EligibleAssets</a></p> |
| <p>annotation</p> | <p>documentation<br/>30180 - 30210</p>  |

element

**EETReportType/PrincipalAdverseIndicators/ClimateAndEnvironmentRelatedIndicators/CarbonFootprintScope12**

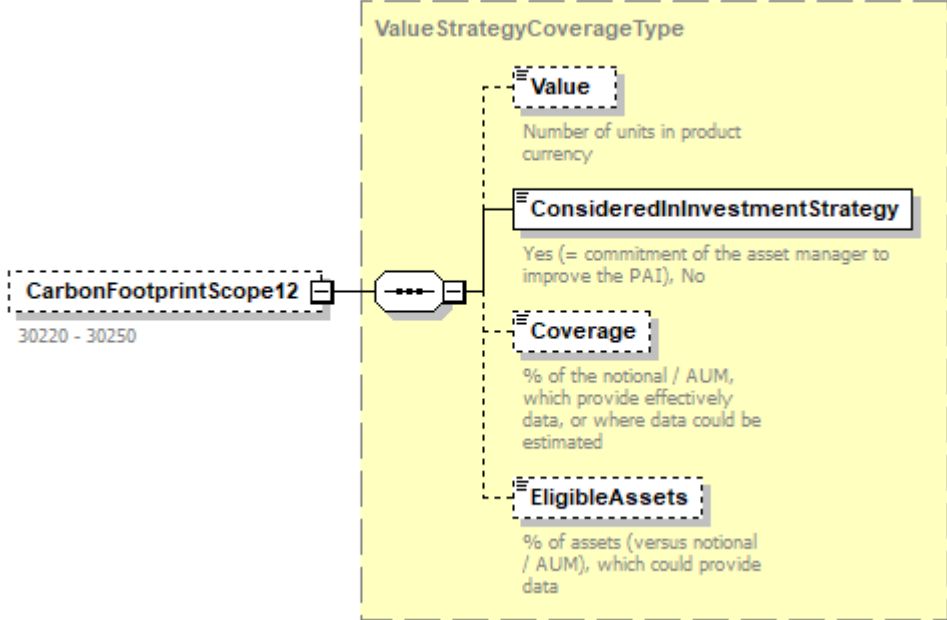
|                   |  |
|-------------------|--|
| <p>diagram</p>    |  <pre> classDiagram     class CarbonFootprintScope12 {         30220 - 30250     }     class ValueStrategyCoverageType {         Value         ConsideredInvestmentStrategy         Coverage         EligibleAssets     }     CarbonFootprintScope12 -- ValueStrategyCoverageType         </pre> |
| <p>type</p>       | <p><a href="#">ValueStrategyCoverageType</a></p>   |
| <p>properties</p> | <p>isRef 0<br/>minOcc 0<br/>maxOcc 1<br/>content complex</p>   |
| <p>children</p>   | <p><a href="#">Value</a> <a href="#">ConsideredInvestmentStrategy</a> <a href="#">Coverage</a> <a href="#">EligibleAssets</a></p>  |
| <p>annotation</p> | <p>documentation<br/>30220 - 30250</p>   |

element

**EETReportType/PrincipalAdverseIndicators/ClimateAndEnvironmentRelatedIndicators/CarbonFootprintScope123**

|            |  |
|------------|--|
| diagram    | <pre>classDiagram     class CarbonFootprintScope123["CarbonFootprintScope123 (30260 - 30290)"]     class ValueStrategyCoverageType["ValueStrategyCoverageType"]     CarbonFootprintScope123 --&gt; ValueStrategyCoverageType</pre> <p><b>ValueStrategyCoverageType</b></p> <ul style="list-style-type: none"><li><b>Value</b><br/>Number of units in product currency</li><li><b>ConsideredInInvestmentStrategy</b><br/>Yes (= commitment of the asset manager to improve the PAI), No</li><li><b>Coverage</b><br/>% of the notional / AUM, which provide effectively data, or where data could be estimated</li><li><b>EligibleAssets</b><br/>% of assets (versus notional / AUM), which could provide data</li></ul> |
| type       | <a href="#">ValueStrategyCoverageType</a>  |
| properties | isRef 0<br>minOcc 0<br>maxOcc 1<br>content complex   |
| children   | <a href="#">Value</a> <a href="#">ConsideredInInvestmentStrategy</a> <a href="#">Coverage</a> <a href="#">EligibleAssets</a>   |
| annotation | documentation<br>30260 - 30290   |

element

**EETReportType/PrincipalAdverseIndicators/ClimateAndEnvironmentRelatedIndicators/GHG\_IntensityOfInvesteeCompaniesScope12**

|                   |   |
|-------------------|---|
| <p>diagram</p>    | <pre> classDiagram     class GHG_IntensityOfInvesteeComp... {         30300 - 30330     }     class ValueStrategyCoverageType {         Value         ConsideredInInvestmentStrategy         Coverage         EligibleAssets     }     GHG_IntensityOfInvesteeComp... -- ValueStrategyCoverageType     </pre> |
| <p>type</p>       | <p><a href="#">ValueStrategyCoverageType</a></p>  |
| <p>properties</p> | <p>isRef 0<br/>minOcc 0<br/>maxOcc 1<br/>content complex</p>  |
| <p>children</p>   | <p><a href="#">Value</a> <a href="#">ConsideredInInvestmentStrategy</a> <a href="#">Coverage</a> <a href="#">EligibleAssets</a></p>   |
| <p>annotation</p> | <p>documentation<br/>30300 - 30330</p>  |

element

**EETReportType/PrincipalAdverseIndicators/ClimateAndEnvironmentRelatedIndicators/GHG\_IntensityOfInvesteeCompaniesScope123**

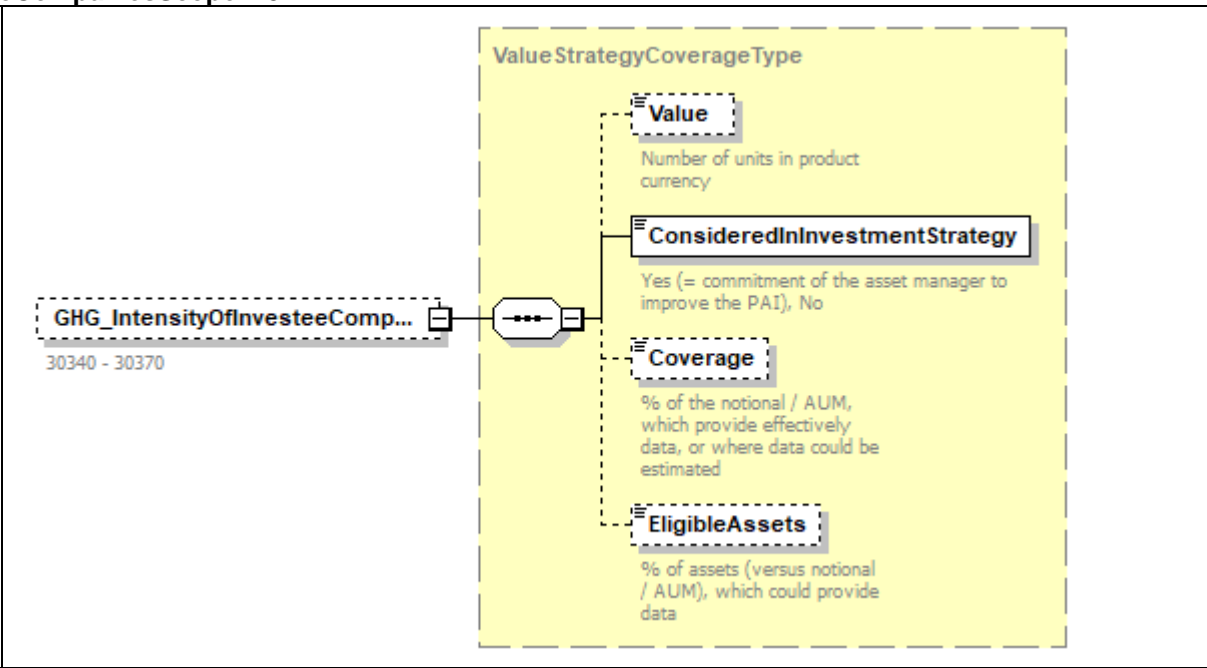
|            |  |
|------------|--|
| diagram    |  <p>The diagram shows a class <b>GHG_IntensityOfInvesteeComp...</b> (ID 30340 - 30370) connected to a class <b>ValueStrategyCoverageType</b> (ID 30340 - 30370). The <b>ValueStrategyCoverageType</b> class has four attributes:</p> <ul style="list-style-type: none"><li><b>Value</b>: Number of units in product currency</li><li><b>ConsideredInInvestmentStrategy</b>: Yes (= commitment of the asset manager to improve the PAI), No</li><li><b>Coverage</b>: % of the notional / AUM, which provide effectively data, or where data could be estimated</li><li><b>EligibleAssets</b>: % of assets (versus notional / AUM), which could provide data</li></ul> |
| type       | <a href="#">ValueStrategyCoverageType</a>  |
| properties | isRef 0<br>minOcc 0<br>maxOcc 1<br>content complex   |
| children   | <a href="#">Value</a> <a href="#">ConsideredInInvestmentStrategy</a> <a href="#">Coverage</a> <a href="#">EligibleAssets</a>   |
| annotation | documentation<br>30340 - 30370   |

element

**EETReportType/PrincipalAdverseIndicators/ClimateAndEnvironmentRelatedIndicators/ExposureToCompaniesActiveInTheFossilFuelSector**

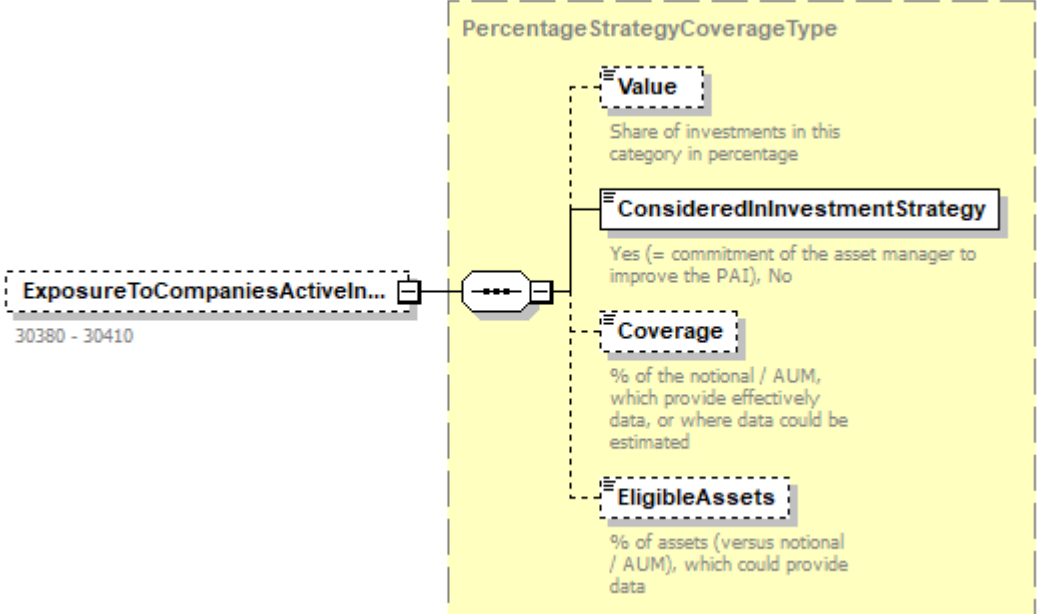
|                   |   |
|-------------------|---|
| <p>diagram</p>    |   |
| <p>type</p>       | <p><a href="#">PercentageStrategyCoverageType</a></p>   |
| <p>properties</p> | <p>isRef 0<br/>minOcc 0<br/>maxOcc 1<br/>content complex</p>  |
| <p>children</p>   | <p><a href="#">Value</a> <a href="#">ConsideredInInvestmentStrategy</a> <a href="#">Coverage</a> <a href="#">EligibleAssets</a></p> |
| <p>annotation</p> | <p>documentation<br/>30380 - 30410</p>  |



element

**EETReportType/PrincipalAdverseIndicators/ClimateAndEnvironmentRelatedIndicators/EnergyConsumptionFromNonRenewableSources**

|                   |   |
|-------------------|---|
| <p>diagram</p>    |   |
| <p>type</p>       | <p><a href="#">PercentageStrategyCoverageType</a></p>   |
| <p>properties</p> | <p>isRef 0<br/>minOcc 0<br/>maxOcc 1<br/>content complex</p>  |
| <p>children</p>   | <p><a href="#">Value</a> <a href="#">ConsideredInInvestmentStrategy</a> <a href="#">Coverage</a> <a href="#">EligibleAssets</a></p> |
| <p>annotation</p> | <p>documentation<br/>30420 - 30450</p>  |

element

**EETReportType/PrincipalAdverseIndicators/ClimateAndEnvironmentRelatedIndicators/EnergyProductionFromNonRenewableSources**

|                   |   |
|-------------------|---|
| <p>diagram</p>    |   |
| <p>type</p>       | <p><a href="#">PercentageStrategyCoverageType</a></p>   |
| <p>properties</p> | <p>isRef 0<br/>minOcc 0<br/>maxOcc 1<br/>content complex</p>  |
| <p>children</p>   | <p><a href="#">Value</a> <a href="#">ConsideredInInvestmentStrategy</a> <a href="#">Coverage</a> <a href="#">EligibleAssets</a></p> |
| <p>annotation</p> | <p>documentation<br/>30460 - 30490</p>  |

element

**EETReportType/PrincipalAdverseIndicators/ClimateAndEnvironmentRelatedIndicators/EnergyConsumptionIntensityPerHighImpactClimateSector**

|                   |  |
|-------------------|--|
| <p>diagram</p>    |  |
| <p>properties</p> | <p>isRef 0<br/>minOcc 0<br/>maxOcc 1<br/>content complex</p> |
| <p>children</p>   | <p><a href="#">NACE Values</a></p>                           |
| <p>annotation</p> | <p>documentation<br/>30500 - 30850</p>                       |

element

**EETReportType/PrincipalAdverseIndicators/ClimateAndEnvironmentRelatedIndicators/EnergyConsumptionIntensityPerHighImpactClimateSector/NACE\_Values**

|            |   |
|------------|---|
| diagram    |   |
| properties | <p>isRef 0<br/> minOcc 1<br/> maxOcc 9<br/> content complex</p> |
| children   | <p><a href="#">NACE_Category</a> <a href="#">Values</a></p>     |

element

**EETReportType/PrincipalAdverseIndicators/ClimateAndEnvironmentRelatedIndicators/EnergyConsumptionIntensityPerHighImpactClimateSector/NACE\_Values/NACE\_Category**

|            |  |
|------------|--|
| diagram    |  |
| type       | <p>restriction of <code>xs:string</code></p> |
| properties | <p>isRef 0<br/> content simple</p>           |

element

**EETReportType/PrincipalAdverseIndicators/ClimateAndEnvironmentRelatedIndicators/EnergyConsumptionIntensityPerHighImpactClimateSector/NACE\_Values/Values**

|            |   |
|------------|---|
| diagram    |   |
| type       | <p><a href="#">ValueStrategyCoverageType</a></p>  |
| properties | <p>isRef 0<br/> content complex</p>   |
| children   | <p><a href="#">Value</a> <a href="#">ConsideredInInvestmentStrategy</a> <a href="#">Coverage</a> <a href="#">EligibleAssets</a></p> |

element

**EETReportType/PrincipalAdverseIndicators/ClimateAndEnvironmentRelatedIndicators/ActivitiesNegativelyAffectingBiodiversitySensitiveAreas**

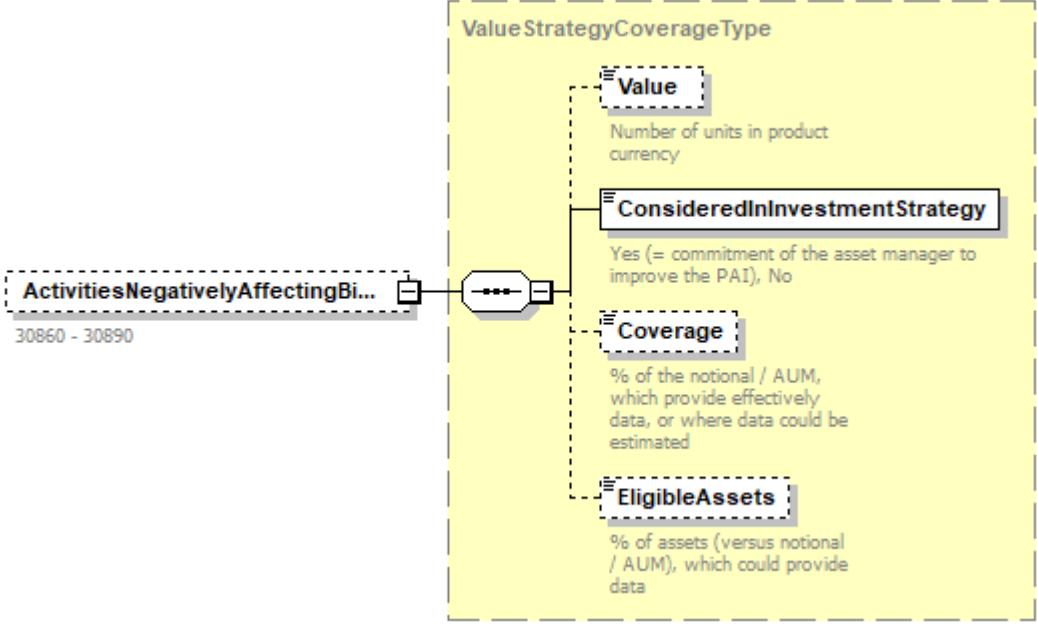
|                   |  |
|-------------------|--|
| <p>diagram</p>    |  <pre> classDiagram     class ActivitiesNegativelyAffectingBi... {         30860 - 30890     }     class ValueStrategyCoverageType {         Value         ConsideredInInvestmentStrategy         Coverage         EligibleAssets     }     ActivitiesNegativelyAffectingBi... -- ValueStrategyCoverageType     </pre> |
| <p>type</p>       | <p><a href="#">ValueStrategyCoverageType</a></p>   |
| <p>properties</p> | <p>isRef 0<br/>minOcc 0<br/>maxOcc 1<br/>content complex</p>   |
| <p>children</p>   | <p><a href="#">Value</a> <a href="#">ConsideredInInvestmentStrategy</a> <a href="#">Coverage</a> <a href="#">EligibleAssets</a></p>  |
| <p>annotation</p> | <p>documentation<br/>30860 - 30890</p>   |

element

**EETReportType/PrincipalAdverseIndicators/ClimateAndEnvironmentRelatedIndicators/WaterEmissions**

|                   |   |
|-------------------|---|
| <p>diagram</p>    |   |
| <p>type</p>       | <p><a href="#">ValueStrategyCoverageType</a></p>  |
| <p>properties</p> | <p>isRef 0<br/>minOcc 0<br/>maxOcc 1<br/>content complex</p>  |
| <p>children</p>   | <p><a href="#">Value</a> <a href="#">ConsideredInInvestmentStrategy</a> <a href="#">Coverage</a> <a href="#">EligibleAssets</a></p> |
| <p>annotation</p> | <p>documentation<br/>30900 - 30930</p>  |

element  
**EETReportType/PrincipalAdverseIndicators/ClimateAndEnvironmentRelatedIndicators/HazardousWaste**

|                   |  |
|-------------------|--|
| <p>diagram</p>    | <pre> classDiagram     class HazardousWaste {         30940 - 30970     }     class ValueStrategyCoverageType {         30940 - 30970         Value : Number of units in product currency         ConsideredInInvestmentStrategy : Yes (= commitment of the asset manager to improve the PAI), No         Coverage : % of the notional / AUM, which provide effectively data, or where data could be estimated         EligibleAssets : % of assets (versus notional / AUM), which could provide data     }     HazardousWaste -- ValueStrategyCoverageType     </pre> |
| <p>type</p>       | <p><a href="#">ValueStrategyCoverageType</a></p>   |
| <p>properties</p> | <p>isRef 0<br/> minOcc 0<br/> maxOcc 1<br/> content complex</p>  |
| <p>children</p>   | <p><a href="#">Value</a> <a href="#">ConsideredInInvestmentStrategy</a> <a href="#">Coverage</a> <a href="#">EligibleAssets</a></p>  |
| <p>annotation</p> | <p>documentation<br/> 30940 - 30970</p>  |

element **EETReportType/PrincipalAdverseIndicators/SocialAndEmployeeMatters**

|                   |   |
|-------------------|---|
| <p>diagram</p>    | <p><b>SocialAndEmployeeMatters</b> 30980 - 31160</p> <ul style="list-style-type: none"> <li><b>CompaniesInvolvedInViolation...</b> Companies_Involved_In_Violation_Of_UN_Global_Compact_Principles_And_OECD_Guidelines_For_Multinational_Enterprises (30980 - 31010)</li> <li><b>CompaniesWithoutMonitoring...</b> Share_Of_Companies_Without_Policies_To_Monitor_Compliance_With_UNGCP_And_OECD_Guidelines_For_Multinational_Enterprises (31020 - 31045)</li> <li><b>UnadjustedGenderPayGap</b> Unadjusted_Gender_Pay_Gap (31050 - 31080)</li> <li><b>BoardGenderDiversity</b> Board_Gender_Diversity (31090 - 31120)</li> <li><b>InvestmentsInvolvedInControv...</b> Investments_Involved_In_Controversial_Weapons (31130 - 31160)</li> </ul> |
| <p>properties</p> | <p>isRef 0<br/>minOcc 0<br/>maxOcc 1<br/>content complex</p>  |
| <p>children</p>   | <p><a href="#">CompaniesInvolvedInViolation UN GCP Or OECD ME Guidelines</a><br/><a href="#">CompaniesWithoutMonitoringCompliance UN GCP Or OECD ME Guidelines</a> <a href="#">UnadjustedGenderPayGap</a><br/><a href="#">BoardGenderDiversity</a> <a href="#">InvestmentsInvolvedInControversialWeapons</a></p>  |
| <p>annotation</p> | <p>documentation<br/>30980 - 31160</p>  |

element

**EETReportType/PrincipalAdverseIndicators/SocialAndEmployeeMatters/CompaniesInvolvedInViolation  
UN\_GCP\_Or\_OECD\_ME\_Guidelines**

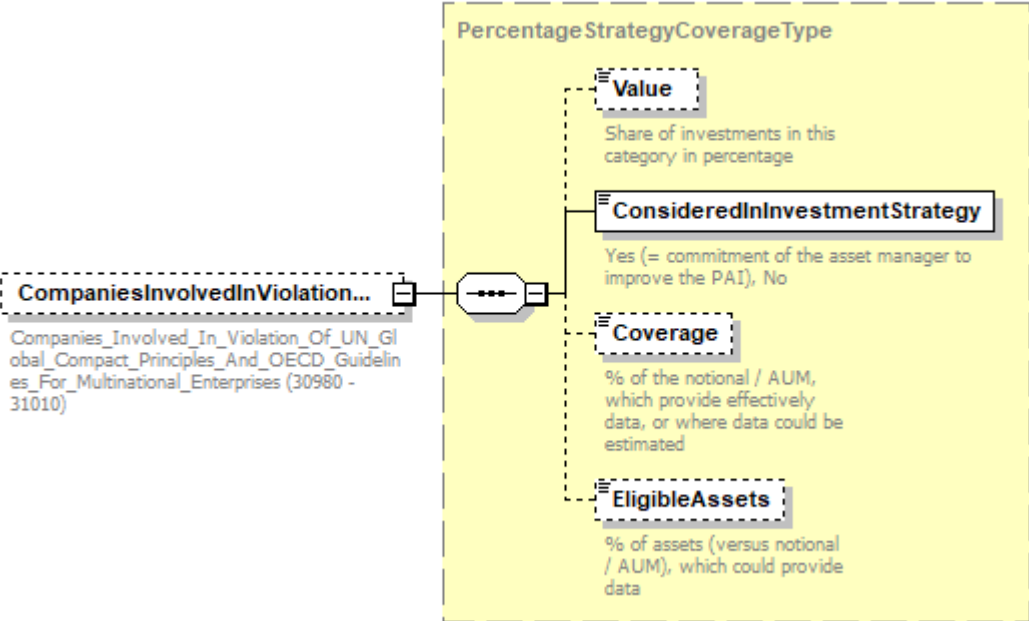
|                   |   |
|-------------------|---|
| <p>diagram</p>    |  <pre> classDiagram     class CompaniesInvolvedInViolation {         &lt;&lt;documentation&gt;&gt;         Companies_Involved_In_Violation_Of_UN_Global_Compact_Principles_And_OECD_Guidelines_For_Multinational_Enterprises (30980 - 31010)     }     class PercentageStrategyCoverageType {         Value         ConsideredInInvestmentStrategy         Coverage         EligibleAssets     }     CompaniesInvolvedInViolation "1" *-- "1" PercentageStrategyCoverageType     </pre> |
| <p>type</p>       | <p><a href="#">PercentageStrategyCoverageType</a></p>   |
| <p>properties</p> | <p>isRef 0<br/>minOcc 0<br/>maxOcc 1<br/>content complex</p>  |
| <p>children</p>   | <p><a href="#">Value</a> <a href="#">ConsideredInInvestmentStrategy</a> <a href="#">Coverage</a> <a href="#">EligibleAssets</a></p>   |
| <p>annotation</p> | <p>documentation<br/>Companies_Involved_In_Violation_Of_UN_Global_Compact_Principles_And_OECD_Guidelines_For_Multinational_Enterprises (30980 - 31010)</p>  |



element

**EETReportType/PrincipalAdverseIndicators/SocialAndEmployeeMatters/CompaniesWithoutMonitoring Compliance\_UN\_GCP\_Or\_OECD\_ME\_Guidelines**

|                   |   |
|-------------------|---|
| <p>diagram</p>    | <pre> classDiagram     class CompaniesWithoutMonitoring {         Share_Of_Companies_Without_Policies_To_Monitor_Compliance_With_UNGCP_And_OECD_Guidelines_For_Multinational_Enterprises (31020 - 31045)     }     class PercentageStrategyCoverageType {         Value         ConsideredInInvestmentStrategy         Coverage         EligibleAssets     }     CompaniesWithoutMonitoring "1" *-- "1" PercentageStrategyCoverageType     </pre> |
| <p>type</p>       | <p><a href="#">PercentageStrategyCoverageType</a></p>   |
| <p>properties</p> | <p>isRef 0<br/>minOcc 0<br/>maxOcc 1<br/>content complex</p>  |
| <p>children</p>   | <p><a href="#">Value</a> <a href="#">ConsideredInInvestmentStrategy</a> <a href="#">Coverage</a> <a href="#">EligibleAssets</a></p>   |
| <p>annotation</p> | <p>documentation<br/>Share_Of_Companies_Without_Policies_To_Monitor_Compliance_With_UNGCP_And_OECD_Guidelines_For_Multinational_Enterprises (31020 - 31045)</p>   |

element

**EETReportType/PrincipalAdverseIndicators/SocialAndEmployeeMatters/UnadjustedGenderPayGap**

|                   |   |
|-------------------|---|
| <p>diagram</p>    | <pre> classDiagram     class UnadjustedGenderPayGap {         Unadjusted_Gender_Pay_Gap (31050 - 31080)     }     class PercentageStrategyCoverageType {         Value         ConsideredInInvestmentStrategy         Coverage         EligibleAssets     }     UnadjustedGenderPayGap --&gt; PercentageStrategyCoverageType     </pre> |
| <p>type</p>       | <p><a href="#">PercentageStrategyCoverageType</a></p>   |
| <p>properties</p> | <p>isRef 0<br/>minOcc 0<br/>maxOcc 1<br/>content complex</p>  |
| <p>children</p>   | <p><a href="#">Value</a> <a href="#">ConsideredInInvestmentStrategy</a> <a href="#">Coverage</a> <a href="#">EligibleAssets</a></p>   |
| <p>annotation</p> | <p>documentation<br/>Unadjusted_Gender_Pay_Gap (31050 - 31080)</p>  |

element **EETReportType/PrincipalAdverseIndicators/SocialAndEmployeeMatters/BoardGenderDiversity**

|                   |  |
|-------------------|--|
| <p>diagram</p>    | <p>The diagram illustrates the structure of the <b>BoardGenderDiversity</b> element. It is associated with the <b>ValueStrategyCoverageType</b> class. The <b>ValueStrategyCoverageType</b> class contains four attributes:</p> <ul style="list-style-type: none"> <li><b>Value</b>: Number of units in product currency</li> <li><b>ConsideredInInvestmentStrategy</b>: Yes (= commitment of the asset manager to improve the PAI), No</li> <li><b>Coverage</b>: % of the notional / AUM, which provide effectively data, or where data could be estimated</li> <li><b>EligibleAssets</b>: % of assets (versus notional / AUM), which could provide data</li> </ul> |
| <p>type</p>       | <p><a href="#">ValueStrategyCoverageType</a></p>   |
| <p>properties</p> | <p>isRef 0<br/>minOcc 0<br/>maxOcc 1<br/>content complex</p>   |
| <p>children</p>   | <p><a href="#">Value</a> <a href="#">ConsideredInInvestmentStrategy</a> <a href="#">Coverage</a> <a href="#">EligibleAssets</a></p>  |
| <p>annotation</p> | <p>documentation<br/>Board_Gender_Diversity (31090 - 31120)</p>  |

element

**EETReportType/PrincipalAdverseIndicators/SocialAndEmployeeMatters/InvestmentsInvolvedInControversialWeapons**

|            |  |
|------------|--|
| diagram    |  |
| type       | <a href="#">PercentageStrategyCoverageType</a>   |
| properties | isRef 0<br>minOcc 0<br>maxOcc 1<br>content complex   |
| children   | <a href="#">Value</a> <a href="#">ConsideredInInvestmentStrategy</a> <a href="#">Coverage</a> <a href="#">EligibleAssets</a> |
| annotation | documentation<br>Investments_Involved_In_Controversial_Weapons (31130 - 31160)   |

element **EETReportType/PrincipalAdverseIndicators/SovereignAndSupranationalInvestments**

|            |   |
|------------|---|
| diagram    |   |
| properties | isRef 0<br>minOcc 0<br>maxOcc 1<br>content complex  |
| children   | <a href="#">GreenhouseGasIntensity</a> <a href="#">NumberOfCountriesSubjectToSocialViolations</a> <a href="#">PercentOfCountriesSubjectToSocialViolations</a> |
| annotation | documentation<br>31170 - 31280  |

element  
**EETReportType/PrincipalAdverseIndicators/SovereignAndSupranationalInvestments/GreenhouseGasIntensity**

|                   |   |
|-------------------|---|
| <p>diagram</p>    |   |
| <p>type</p>       | <p><a href="#">ValueStrategyCoverageType</a></p>  |
| <p>properties</p> | <p>isRef 0<br/> minOcc 0<br/> maxOcc 1<br/> content complex</p>   |
| <p>children</p>   | <p><a href="#">Value</a> <a href="#">ConsideredInInvestmentStrategy</a> <a href="#">Coverage</a> <a href="#">EligibleAssets</a></p> |
| <p>annotation</p> | <p>documentation<br/> GHG_Intesity (31170 - 31200)</p>  |

element

**EETReportType/PrincipalAdverseIndicators/SovereignAndSupranationalInvestments/NumberOfCountriesSubjectToSocialViolations**

|                   |   |
|-------------------|---|
| <p>diagram</p>    | <p>The diagram illustrates the structure of the <b>ValueStrategyCoverageType</b> element. On the left, a dashed box represents the <b>NumberOfCountriesSubjectToSocialViolations (31210 - 31240)</b> element. This element is connected to the <b>ValueStrategyCoverageType</b> element, which is shown in a yellow box. The <b>ValueStrategyCoverageType</b> element contains four sub-elements: <b>Value</b> (Number of units in product currency), <b>ConsideredInInvestmentStrategy</b> (Yes (= commitment of the asset manager to improve the PAI), No), <b>Coverage</b> (% of the notional / AUM, which provide effectively data, or where data could be estimated), and <b>EligibleAssets</b> (% of assets (versus notional / AUM), which could provide data).</p> |
| <p>type</p>       | <p><a href="#">ValueStrategyCoverageType</a></p>  |
| <p>properties</p> | <p>isRef 0<br/>minOcc 0<br/>maxOcc 1<br/>content complex</p>  |
| <p>children</p>   | <p><a href="#">Value</a> <a href="#">ConsideredInInvestmentStrategy</a> <a href="#">Coverage</a> <a href="#">EligibleAssets</a></p>   |
| <p>annotation</p> | <p>documentation<br/>Number_Of_Countries_Subject_To_Social_Violations (31210 - 31240)</p>   |

element

**EETReportType/PrincipalAdverseIndicators/SovereignAndSupranationalInvestments/PercentOfCountriesSubjectToSocialViolations**

|            |  |
|------------|--|
| diagram    |  |
| type       | <a href="#">PercentageStrategyCoverageType</a>   |
| properties | isRef 0<br>minOcc 0<br>maxOcc 1<br>content complex   |
| children   | <a href="#">Value</a> <a href="#">ConsideredInInvestmentStrategy</a> <a href="#">Coverage</a> <a href="#">EligibleAssets</a> |
| annotation | documentation<br>Percent_Of_Countries_Subject_To_Social_Violations (31250 - 31280)   |

element **EETReportType/PrincipalAdverseIndicators/RealEstateInvestments**

|            |  |
|------------|--|
| diagram    |  |
| properties | isRef 0<br>minOcc 0<br>maxOcc 1<br>content complex   |
| children   | <a href="#">FossilFuelsExtractionStorageTransportManufacture</a> <a href="#">EnergyEfficientRealEstateAssets</a> |
| annotation | documentation<br>31290 - 31360   |

element

**EETReportType/PrincipalAdverseIndicators/RealEstateInvestments/FossilFuelsExtractionStorageTransportManufacture**

|                   |   |
|-------------------|---|
| <p>diagram</p>    |   |
| <p>type</p>       | <p><a href="#">PercentageStrategyCoverageType</a></p>   |
| <p>properties</p> | <p>isRef 0<br/>minOcc 0<br/>maxOcc 1<br/>content complex</p>  |
| <p>children</p>   | <p><a href="#">Value</a> <a href="#">ConsideredInInvestmentStrategy</a> <a href="#">Coverage</a> <a href="#">EligibleAssets</a></p> |
| <p>annotation</p> | <p>documentation<br/>Exposure_To_Fossil_Fuels_Extraction_Storage_Transport_Manufacture (31290 - 31320)</p>                          |



element

**EETReportType/PrincipalAdverseIndicators/RealEstateInvestments/EnergyEfficientRealEstateAssets**

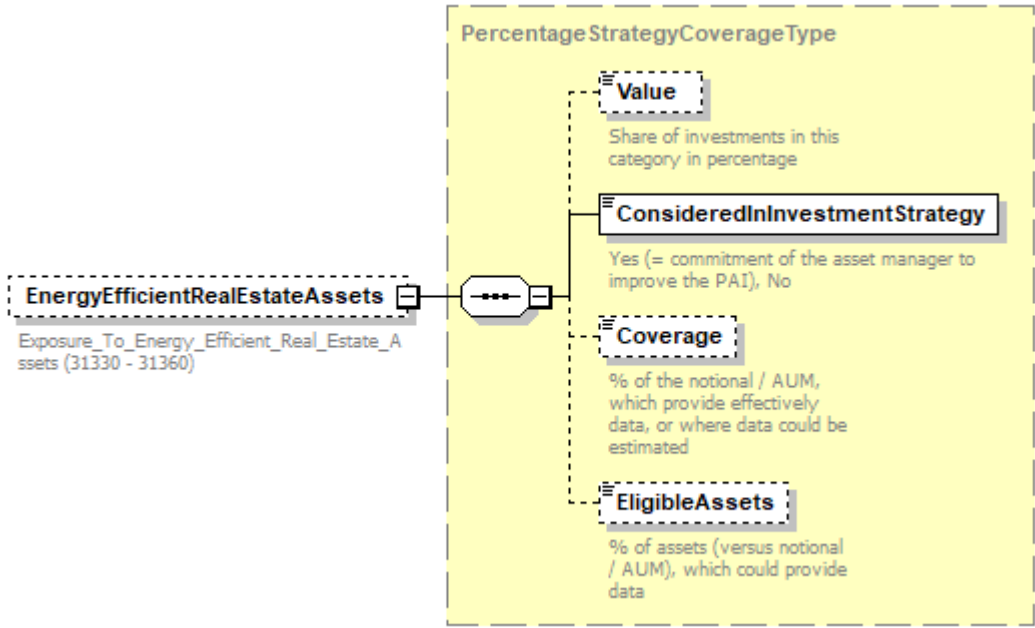
|                   |   |
|-------------------|---|
| <p>diagram</p>    |   |
| <p>type</p>       | <p><a href="#">PercentageStrategyCoverageType</a></p>   |
| <p>properties</p> | <p>isRef 0<br/>minOcc 0<br/>maxOcc 1<br/>content complex</p>  |
| <p>children</p>   | <p><a href="#">Value</a> <a href="#">ConsideredInInvestmentStrategy</a> <a href="#">Coverage</a> <a href="#">EligibleAssets</a></p> |
| <p>annotation</p> | <p>documentation<br/>Exposure_To_Energy_Efficient_Real_Estate_Assets (31330 - 31360)</p>  |

element **EETReportType/PrincipalAdverseIndicators/MoreClimateAndEnvironmentRelatedIndicators**

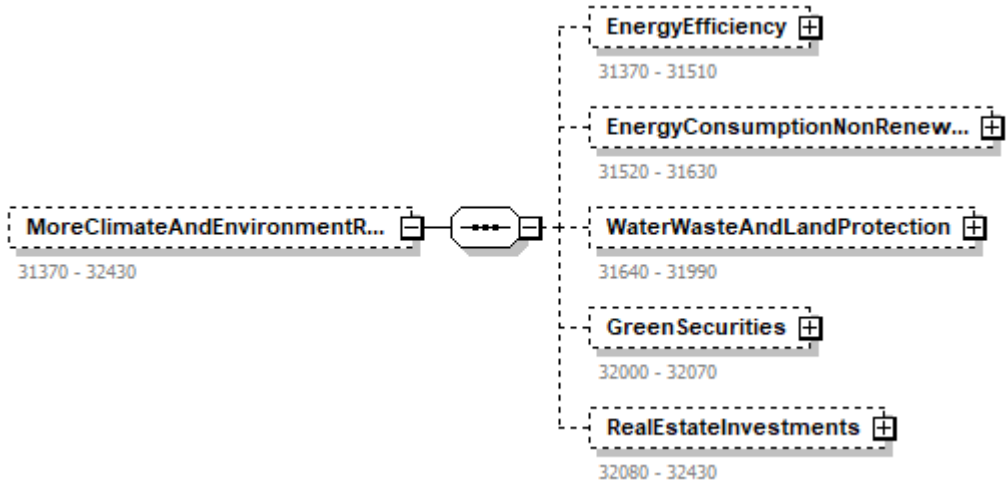
|                   |  |
|-------------------|--|
| <p>diagram</p>    |  |
| <p>properties</p> | <p>isRef 0<br/>minOcc 0<br/>maxOcc 1<br/>content complex</p>                         |

|            |  |
|------------|--|
| children   | <a href="#">EnergyEfficiency</a> <a href="#">EnergyConsumptionNonRenewable</a> <a href="#">WaterWasteAndLandProtection</a> <a href="#">GreenSecurities</a> <a href="#">RealEstateInvestments</a> |
| annotation | documentation<br>31370 - 32430   |

element

**EETReportType/PrincipalAdverseIndicators/MoreClimateAndEnvironmentRelatedIndicators/EnergyEfficiency**

|            |  |
|------------|--|
| diagram    | <pre> classDiagram     class EnergyEfficiency {         31370 - 31510     }     class EmissionsOfInorganicPollutants {         31370 - 31400     }     class EmissionsOfAirPollutants {         31410 - 31440     }     class EmissionsOfOzoneDepletionSubstances {         31450 - 31480     }     class CompaniesWithoutCarbonEmissionReductionInitiatives {         31490 - 31510     }     EnergyEfficiency &lt; -- EmissionsOfInorganicPollutants     EnergyEfficiency &lt; -- EmissionsOfAirPollutants     EnergyEfficiency &lt; -- EmissionsOfOzoneDepletionSubstances     EnergyEfficiency &lt; -- CompaniesWithoutCarbonEmissionReductionInitiatives </pre> |
| properties | isRef 0<br>minOcc 0<br>maxOcc 1<br>content complex   |
| children   | <a href="#">EmissionsOfInorganicPollutants</a> <a href="#">EmissionsOfAirPollutants</a> <a href="#">EmissionsOfOzoneDepletionSubstances</a> <a href="#">CompaniesWithoutCarbonEmissionReductionInitiatives</a>   |
| annotation | documentation<br>31370 - 31510   |

element

**EETReportType/PrincipalAdverseIndicators/MoreClimateAndEnvironmentRelatedIndicators/EnergyEfficiency/EmissionsOfInorganicPollutants**

|                   |   |
|-------------------|---|
| <p>diagram</p>    | <pre> classDiagram     class EmissionsOfInorganicPollutants {         Emissions_Of_Inorganic_Pollutants (31370 - 31400)     }     class ValueStrategyCoverageType {         Value         ConsideredInInvestmentStrategy         Coverage         EligibleAssets     }     EmissionsOfInorganicPollutants -- ValueStrategyCoverageType         </pre> |
| <p>type</p>       | <p><a href="#">ValueStrategyCoverageType</a></p>  |
| <p>properties</p> | <p>isRef 0<br/>minOcc 0<br/>maxOcc 1<br/>content complex</p>  |
| <p>children</p>   | <p><a href="#">Value</a> <a href="#">ConsideredInInvestmentStrategy</a> <a href="#">Coverage</a> <a href="#">EligibleAssets</a></p>   |
| <p>annotation</p> | <p>documentation<br/>Emissions_Of_Inorganic_Pollutants (31370 - 31400)</p>  |

element

**EETReportType/PrincipalAdverseIndicators/MoreClimateAndEnvironmentRelatedIndicators/EnergyEfficiency/EmissionsOfAirPollutants**

|                   |   |
|-------------------|---|
| <p>diagram</p>    | <pre> classDiagram     class EmissionsOfAirPollutants {         Emissions_Of_Air_Pollutants (31410 - 31440)     }     class ValueStrategyCoverageType {         Value         ConsideredInInvestmentStrategy         Coverage         EligibleAssets     }     EmissionsOfAirPollutants -- ValueStrategyCoverageType     </pre> <p>The diagram illustrates the structure of the <b>EmissionsOfAirPollutants</b> element. It is associated with the <b>ValueStrategyCoverageType</b> container. The container includes four sub-elements: <b>Value</b> (Number of units in product currency), <b>ConsideredInInvestmentStrategy</b> (Yes/No commitment), <b>Coverage</b> (% of notional/AUM with data), and <b>EligibleAssets</b> (% of assets that could provide data).</p> |
| <p>type</p>       | <p><a href="#">ValueStrategyCoverageType</a></p>  |
| <p>properties</p> | <p>isRef 0<br/>minOcc 0<br/>maxOcc 1<br/>content complex</p>  |
| <p>children</p>   | <p><a href="#">Value</a> <a href="#">ConsideredInInvestmentStrategy</a> <a href="#">Coverage</a> <a href="#">EligibleAssets</a></p>   |
| <p>annotation</p> | <p>documentation<br/>Emissions_Of_Air_Pollutants (31410 - 31440)</p>  |

element

**EETReportType/PrincipalAdverseIndicators/MoreClimateAndEnvironmentRelatedIndicators/EnergyEfficiency/EmissionsOfOzoneDepletionSubstances**

|                   |   |
|-------------------|---|
| <p>diagram</p>    | <p>The diagram illustrates the structure of the <b>EmissionsOfOzoneDepletionSubstances</b> (31450 - 31480) element. It is associated with the <b>ValueStrategyCoverageType</b>, which is a complex type. The <b>ValueStrategyCoverageType</b> contains four sub-elements: <b>Value</b> (Number of units in product currency), <b>ConsideredInInvestmentStrategy</b> (Yes (= commitment of the asset manager to improve the PAI), No), <b>Coverage</b> (% of the notional / AUM, which provide effectively data, or where data could be estimated), and <b>EligibleAssets</b> (% of assets (versus notional / AUM), which could provide data).</p> |
| <p>type</p>       | <p><a href="#">ValueStrategyCoverageType</a></p>  |
| <p>properties</p> | <p>isRef 0<br/>minOcc 0<br/>maxOcc 1<br/>content complex</p>  |
| <p>children</p>   | <p><a href="#">Value</a> <a href="#">ConsideredInInvestmentStrategy</a> <a href="#">Coverage</a> <a href="#">EligibleAssets</a></p>   |
| <p>annotation</p> | <p>documentation<br/>Emissions_Of_Ozone_Depletion_Substances (31450 - 31480)</p>  |

element

**EETReportType/PrincipalAdverseIndicators/MoreClimateAndEnvironmentRelatedIndicators/EnergyEfficiency/CompaniesWithoutCarbonEmissionReductionInitiatives**

|                   |  |
|-------------------|--|
| <p>diagram</p>    | <p><b>CompaniesWithoutCarbonEmission...</b><br/>Investing_In_Companies_Without_Carbon_Emission_Reduction_Initiatives_Investment_Weight (31490 - 31510)</p> <p><b>PercentageStrategyCoverageType</b></p> <ul style="list-style-type: none"> <li><b>Value</b><br/>Share of investments in this category in percentage</li> <li><b>ConsideredInInvestmentStrategy</b><br/>Yes (= commitment of the asset manager to improve the PAI), No</li> <li><b>Coverage</b><br/>% of the notional / AUM, which provide effectively data, or where data could be estimated</li> <li><b>EligibleAssets</b><br/>% of assets (versus notional / AUM), which could provide data</li> </ul> |
| <p>type</p>       | <p><a href="#">PercentageStrategyCoverageType</a></p>  |
| <p>properties</p> | <p>isRef 0<br/>minOcc 0<br/>maxOcc 1<br/>content complex</p>   |
| <p>children</p>   | <p><a href="#">Value</a> <a href="#">ConsideredInInvestmentStrategy</a> <a href="#">Coverage</a> <a href="#">EligibleAssets</a></p>  |
| <p>annotation</p> | <p>documentation<br/>Investing_In_Companies_Without_Carbon_Emission_Reduction_Initiatives_Investment_Weight (31490 - 31510)</p>  |

element

**EETReportType/PrincipalAdverseIndicators/MoreClimateAndEnvironmentRelatedIndicators/EnergyConsumptionNonRenewable**

|                |  |
|----------------|--|
| <p>diagram</p> | <p><b>EnergyConsumptionNonRenew...</b><br/>Breakdown_Of_Energy_Consumption_By_Type_Of_Non-renewable_Sources_Of_Energy (31520 - 31630)</p> <ul style="list-style-type: none"> <li><b>Oil</b><br/>Breakdown_Of_Energy_Consumption_By_Type_Of_Non-renewable_Sources_Of_Energy_Oil (31520 - 31550)</li> <li><b>NaturalGas</b><br/>Breakdown_Of_Energy_Consumption_By_Type_Of_Non-renewable_Sources_Of_Energy_Natural_Gas (31560 - 31590)</li> <li><b>Coal</b><br/>Breakdown_Of_Energy_Consumption_By_Type_Of_Non-renewable_Sources_Of_Energy_Coal (31600 - 31630)</li> </ul> |
|----------------|--|

|            |   |
|------------|---|
| properties | isRef 0<br>minOcc 0<br>maxOcc 1<br>content complex                  |
| children   | <a href="#">Oil</a> <a href="#">NaturalGas</a> <a href="#">Coal</a> |
| annotation | documentation<br>31520 - 31630                                      |

element

**EETReportType/PrincipalAdverseIndicators/MoreClimateAndEnvironmentRelatedIndicators/EnergyConsumptionNonRenewable/Oil**

|            |  |
|------------|--|
| diagram    |  |
| type       | <a href="#">PercentageStrategyCoverageType</a>   |
| properties | isRef 0<br>minOcc 0<br>maxOcc 1<br>content complex   |
| children   | <a href="#">Value</a> <a href="#">ConsideredInInvestmentStrategy</a> <a href="#">Coverage</a> <a href="#">EligibleAssets</a> |
| annotation | documentation<br>Breakdown_Of_Energy_Consumption_By_Type_Of_Non-renewable_Sources_Of_Energy_Oil (31520 - 31550)              |

element

**EETReportType/PrincipalAdverseIndicators/MoreClimateAndEnvironmentRelatedIndicators/EnergyConsumptionNonRenewable/NaturalGas**

|                   |   |
|-------------------|---|
| <p>diagram</p>    | <p><b>NaturalGas</b><br/>Breakdown_Of_Energy_Consumption_By_Type_Of_Non-renewable_Sources_Of_Energy_Natural_Gas (31560 - 31590)</p> <p><b>PercentageStrategyCoverageType</b></p> <ul style="list-style-type: none"> <li><b>Value</b><br/>Share of investments in this category in percentage</li> <li><b>ConsideredInInvestmentStrategy</b><br/>Yes (= commitment of the asset manager to improve the PAI), No</li> <li><b>Coverage</b><br/>% of the notional / AUM, which provide effectively data, or where data could be estimated</li> <li><b>EligibleAssets</b><br/>% of assets (versus notional / AUM), which could provide data</li> </ul> |
| <p>type</p>       | <p><a href="#">PercentageStrategyCoverageType</a></p>   |
| <p>properties</p> | <p>isRef 0<br/>minOcc 0<br/>maxOcc 1<br/>content complex</p>  |
| <p>children</p>   | <p><a href="#">Value</a> <a href="#">ConsideredInInvestmentStrategy</a> <a href="#">Coverage</a> <a href="#">EligibleAssets</a></p>   |
| <p>annotation</p> | <p>documentation<br/>Breakdown_Of_Energy_Consumption_By_Type_Of_Non-renewable_Sources_Of_Energy_Natural_Gas (31560 - 31590)</p>   |



element

**EETReportType/PrincipalAdverseIndicators/MoreClimateAndEnvironmentRelatedIndicators/EnergyConsumptionNonRenewable/Coal**

|                   |   |
|-------------------|---|
| <p>diagram</p>    |   |
| <p>type</p>       | <p><a href="#">PercentageStrategyCoverageType</a></p>   |
| <p>properties</p> | <p>isRef 0<br/>minOcc 0<br/>maxOcc 1<br/>content complex</p>  |
| <p>children</p>   | <p><a href="#">Value</a> <a href="#">ConsideredInInvestmentStrategy</a> <a href="#">Coverage</a> <a href="#">EligibleAssets</a></p> |
| <p>annotation</p> | <p>documentation<br/>Breakdown_Of_Energy_Consumption_By_Type_Of_Non-renewable_Sources_Of_Energy_Coal (31600 - 31630)</p>            |

element

**EETReportType/PrincipalAdverseIndicators/MoreClimateAndEnvironmentRelatedIndicators/WaterWasteAndLandProtection**

diagram

**WaterWasteAndLandProtection**

31640 - 31990

**WaterUsageAndRecyclingAmo...**

Water\_Usage\_And\_Recycling\_Average\_Amount (31640 - 31670)

**WaterUsageAndRecyclingPerce...**

Water\_Usage\_And\_Recycling\_Average\_Percentage (31640 - 31670)

**CompaniesWithoutWaterMana...**

Investing\_In\_Companies\_Without\_Water\_Management\_Policies\_Weight (31680 - 31710)

**AreasOfHighWaterStress**

Exposure\_To\_Areas\_Of\_High\_Water\_Stress (31720 - 31750)

**CompaniesProducingChemicals**

Exposure\_To\_Companies\_Producing\_Chemicals (31760 - 31790)

**CompaniesCausingLandDegra...**

Exposure\_To\_Companies\_Causing\_Land\_Degradation\_Desertification\_Or\_Soil\_Sealing (31800 - 31830)

**CompaniesWithoutSustainable...**

Exposure\_To\_Companies\_Without\_Sustainable\_Land\_Or\_Agriculture\_Practices\_Policies (31840 - 31870)

**CompaniesWithoutSustainable...**

Share\_Of\_Investments\_In\_Companies\_Without\_Sustainable\_Oceans\_Or\_Seas\_Practices (31871 - 31874)

**NonRecycledWasteRatio**

Non\_Recycled\_Waste\_Ratio (31875 - 31878)

**CompaniesWhoseOperationsA...**

Share\_Of\_Investments\_In\_Investee\_Companies\_Whose\_Operations\_Affect\_Threatened\_Species (31880 - 31910)

**CompaniesWithoutBiodiversity...**

Share\_Of\_Investments\_In\_Investee\_Companies\_Without\_A\_Biodiversity\_Protection\_Policy\_Covering\_Operational\_Sites\_Owned\_Leased\_Managed\_In\_Or\_Adjacent\_To\_A\_Protected\_Area\_Or\_An\_Area\_Of\_High\_Biodiversity\_Value\_Outside\_Protected\_Areas (31920 - 31950)

**CompaniesWithoutDeforestat...**

Share\_Of\_Investee\_Companies\_Without\_Deforestation\_Policy (31960 - 31990)

properties

isRef 0  
minOcc 0

|            |  |
|------------|--|
|            | maxOcc 1<br>content complex  |
| children   | <a href="#">WaterUsageAndRecyclingAmount</a> <a href="#">WaterUsageAndRecyclingPercentage</a> <a href="#">CompaniesWithoutWaterManagement</a> <a href="#">AreasOfHighWaterStress</a> <a href="#">CompaniesProducingChemicals</a> <a href="#">CompaniesCausingLandDegradationDesertificationSoilSealing</a> <a href="#">CompaniesWithoutSustainableLandOrAgriculturePractices</a> <a href="#">CompaniesWithoutSustainableOceansSeasPractices</a> <a href="#">NonRecycledWasteRatio</a> <a href="#">CompaniesWhoseOperationsAffectThreatenedSpecies</a> <a href="#">CompaniesWithoutBiodiversityProtection</a> <a href="#">CompaniesWithoutDeforestationPolicy</a> |
| annotation | documentation<br>31640 - 31990   |

element

**EETReportType/PrincipalAdverseIndicators/MoreClimateAndEnvironmentRelatedIndicators/WaterWasteAndLandProtection/WaterUsageAndRecyclingAmount**

|            |  |
|------------|--|
| diagram    | <p>The diagram shows a class <b>WaterUsageAndRecyclingAmount</b> (indicated by a dashed border) with the text "Water_Usage_And_Recycling_Average_Amount (31640 - 31670)" below it. This class is connected to a larger class <b>ValueStrategyCoverageType</b> (indicated by a yellow dashed border). Inside the <b>ValueStrategyCoverageType</b> class, there are four attributes:     <ul style="list-style-type: none"> <li><b>Value</b>: Number of units in product currency</li> <li><b>ConsideredInInvestmentStrategy</b>: Yes (= commitment of the asset manager to improve the PAI), No</li> <li><b>Coverage</b>: % of the notional / AUM, which provide effectively data, or where data could be estimated</li> <li><b>EligibleAssets</b>: % of assets (versus notional / AUM), which could provide data</li> </ul> </p> |
| type       | <a href="#">ValueStrategyCoverageType</a>  |
| properties | isRef 0<br>minOcc 0<br>maxOcc 1<br>content complex   |
| children   | <a href="#">Value</a> <a href="#">ConsideredInInvestmentStrategy</a> <a href="#">Coverage</a> <a href="#">EligibleAssets</a>   |
| annotation | documentation<br>Water_Usage_And_Recycling_Average_Amount (31640 - 31670)  |

element

**EETReportType/PrincipalAdverseIndicators/MoreClimateAndEnvironmentRelatedIndicators/WaterWasteAndLandProtection/WaterUsageAndRecyclingPercentage**

|                   |  |
|-------------------|--|
| <p>diagram</p>    | <p>The diagram illustrates the structure of the <b>WaterUsageAndRecyclingPercentage</b> element. It is a complex type with four children:</p> <ul style="list-style-type: none"> <li><b>Value</b>: Share of investments in this category in percentage</li> <li><b>ConsideredInInvestmentStrategy</b>: Yes (= commitment of the asset manager to improve the PAI), No</li> <li><b>Coverage</b>: % of the notional / AUM, which provide effectively data, or where data could be estimated</li> <li><b>EligibleAssets</b>: % of assets (versus notional / AUM), which could provide data</li> </ul> |
| <p>type</p>       | <p><a href="#">PercentageStrategyCoverageType</a></p>  |
| <p>properties</p> | <p>isRef 0<br/>minOcc 0<br/>maxOcc 1<br/>content complex</p>   |
| <p>children</p>   | <p><a href="#">Value</a> <a href="#">ConsideredInInvestmentStrategy</a> <a href="#">Coverage</a> <a href="#">EligibleAssets</a></p>  |
| <p>annotation</p> | <p>documentation<br/>Water_Usage_And_Recycling_Average_Percentage (31640 - 31670)</p>  |

element

**EETReportType/PrincipalAdverseIndicators/MoreClimateAndEnvironmentRelatedIndicators/WaterWasteAndLandProtection/CompaniesWithoutWaterManagement**

|                   |  |
|-------------------|--|
| <p>diagram</p>    | <p><b>PercentageStrategyCoverageType</b></p> <ul style="list-style-type: none"> <li><b>Value</b><br/>Share of investments in this category in percentage</li> <li><b>ConsideredInInvestmentStrategy</b><br/>Yes (= commitment of the asset manager to improve the PAI), No</li> <li><b>Coverage</b><br/>% of the notional / AUM, which provide effectively data, or where data could be estimated</li> <li><b>EligibleAssets</b><br/>% of assets (versus notional / AUM), which could provide data</li> </ul> <p><b>CompaniesWithoutWaterMana...</b><br/>Investing_In_Companies_Without_Water_Management_Policies_Weight (31680 - 31710)</p> |
| <p>type</p>       | <p><a href="#">PercentageStrategyCoverageType</a></p>  |
| <p>properties</p> | <p>isRef 0<br/>minOcc 0<br/>maxOcc 1<br/>content complex</p>   |
| <p>children</p>   | <p><a href="#">Value</a> <a href="#">ConsideredInInvestmentStrategy</a> <a href="#">Coverage</a> <a href="#">EligibleAssets</a></p>  |
| <p>annotation</p> | <p>documentation<br/>Investing_In_Companies_Without_Water_Management_Policies_Weight (31680 - 31710)</p>   |

element

**EETReportType/PrincipalAdverseIndicators/MoreClimateAndEnvironmentRelatedIndicators/WaterWasteAndLandProtection/AreasOfHighWaterStress**

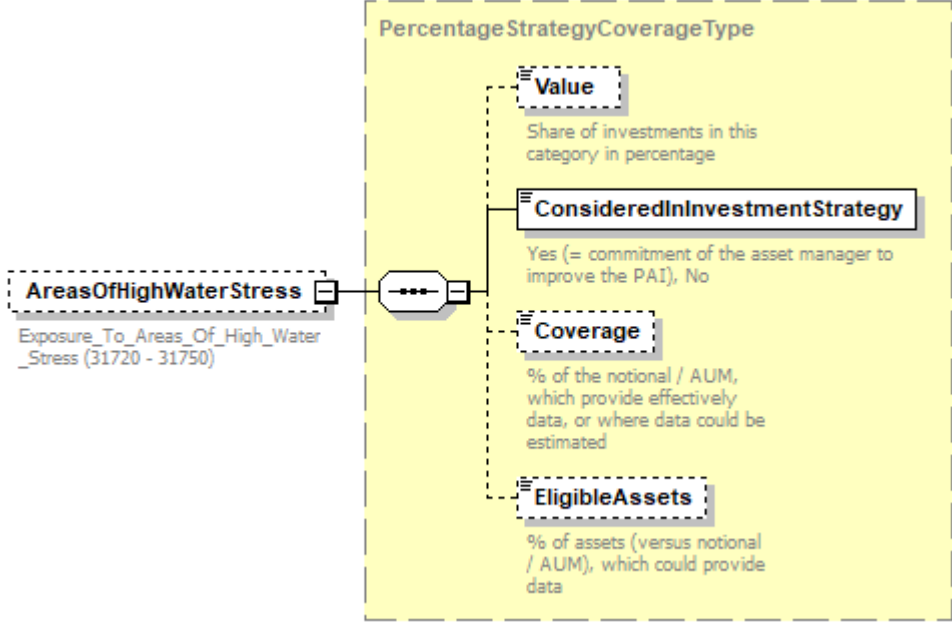
|                   |   |
|-------------------|---|
| <p>diagram</p>    |  <pre> classDiagram     class AreasOfHighWaterStress {         Exposure_To_Areas_Of_High_Water_Stress (31720 - 31750)     }     class PercentageStrategyCoverageType {         Value         ConsideredInInvestmentStrategy         Coverage         EligibleAssets     }     AreasOfHighWaterStress -- PercentageStrategyCoverageType     </pre> |
| <p>type</p>       | <p><a href="#">PercentageStrategyCoverageType</a></p>   |
| <p>properties</p> | <p>isRef 0<br/>minOcc 0<br/>maxOcc 1<br/>content complex</p>  |
| <p>children</p>   | <p><a href="#">Value</a> <a href="#">ConsideredInInvestmentStrategy</a> <a href="#">Coverage</a> <a href="#">EligibleAssets</a></p>   |
| <p>annotation</p> | <p>documentation<br/>Exposure_To_Areas_Of_High_Water_Stress (31720 - 31750)</p>   |

element

**EETReportType/PrincipalAdverseIndicators/MoreClimateAndEnvironmentRelatedIndicators/WaterWasteAndLandProtection/CompaniesProducingChemicals**

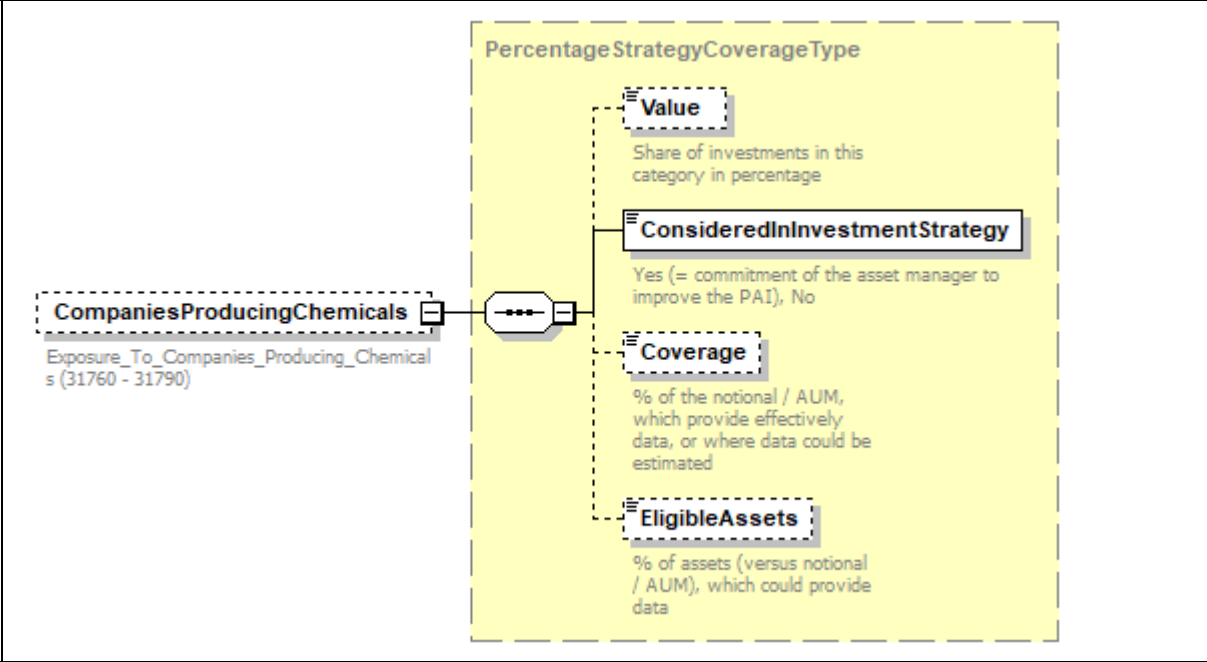
|                   |   |
|-------------------|---|
| <p>diagram</p>    |   |
| <p>type</p>       | <p><a href="#">PercentageStrategyCoverageType</a></p>   |
| <p>properties</p> | <p>isRef 0<br/>minOcc 0<br/>maxOcc 1<br/>content complex</p>  |
| <p>children</p>   | <p><a href="#">Value</a> <a href="#">ConsideredInInvestmentStrategy</a> <a href="#">Coverage</a> <a href="#">EligibleAssets</a></p> |
| <p>annotation</p> | <p>documentation<br/>Exposure_To_Companies_Producing_Chemicals (31760 - 31790)</p>  |



element

**EETReportType/PrincipalAdverseIndicators/MoreClimateAndEnvironmentRelatedIndicators/WaterWasteAndLandProtection/CompaniesCausingLandDegradationDesertificationSoilSealing**

|                   |   |
|-------------------|---|
| <p>diagram</p>    |   |
| <p>type</p>       | <p><a href="#">PercentageStrategyCoverageType</a></p>   |
| <p>properties</p> | <p>isRef 0<br/>minOcc 0<br/>maxOcc 1<br/>content complex</p>  |
| <p>children</p>   | <p><a href="#">Value</a> <a href="#">ConsideredInInvestmentStrategy</a> <a href="#">Coverage</a> <a href="#">EligibleAssets</a></p> |
| <p>annotation</p> | <p>documentation<br/>Exposure_To_Companies_Causing_Land_Degradation_Desertification_Or_Soil_Sealing (31800 - 31830)</p>             |

element

**EETReportType/PrincipalAdverseIndicators/MoreClimateAndEnvironmentRelatedIndicators/WaterWasteAndLandProtection/CompaniesWithoutSustainableLandOrAgriculturePractices**

|                   |   |
|-------------------|---|
| <p>diagram</p>    |   |
| <p>type</p>       | <p><a href="#">PercentageStrategyCoverageType</a></p>   |
| <p>properties</p> | <p>isRef 0<br/>minOcc 0<br/>maxOcc 1<br/>content complex</p>  |
| <p>children</p>   | <p><a href="#">Value</a> <a href="#">ConsideredInInvestmentStrategy</a> <a href="#">Coverage</a> <a href="#">EligibleAssets</a></p> |
| <p>annotation</p> | <p>documentation<br/>Exposure_To_Companies_Without_Sustainable_Land_Or_Agriculture_Practices_Policies (31840 - 31870)</p>           |

element

**EETReportType/PrincipalAdverseIndicators/MoreClimateAndEnvironmentRelatedIndicators/WaterWasteAndLandProtection/CompaniesWithoutSustainableOceansSeasPractices**

|                   |   |
|-------------------|---|
| <p>diagram</p>    |   |
| <p>type</p>       | <p><a href="#">PercentageStrategyCoverageType</a></p>   |
| <p>properties</p> | <p>isRef 0<br/>minOcc 0<br/>maxOcc 1<br/>content complex</p>  |
| <p>children</p>   | <p><a href="#">Value</a> <a href="#">ConsideredInInvestmentStrategy</a> <a href="#">Coverage</a> <a href="#">EligibleAssets</a></p> |
| <p>annotation</p> | <p>documentation<br/>Share_Of_Investments_In_Companies_Without_Sustainable_Oceans_Or_Seas_Practices (31871 - 31874)</p>             |

element

**EETReportType/PrincipalAdverseIndicators/MoreClimateAndEnvironmentRelatedIndicators/WaterWasteAndLandProtection/NonRecycledWasteRatio**

|                   |   |
|-------------------|---|
| <p>diagram</p>    | <pre> classDiagram     class NonRecycledWasteRatio {         Non_Recycled_Waste_Ratio (31875 - 31878)     }     class ValueStrategyCoverageType {         Value         ConsideredInInvestmentStrategy         Coverage         EligibleAssets     }     NonRecycledWasteRatio "1" *-- "1" ValueStrategyCoverageType     </pre> |
| <p>type</p>       | <p><a href="#">ValueStrategyCoverageType</a></p>  |
| <p>properties</p> | <p>isRef 0<br/>minOcc 0<br/>maxOcc 1<br/>content complex</p>  |
| <p>children</p>   | <p><a href="#">Value</a> <a href="#">ConsideredInInvestmentStrategy</a> <a href="#">Coverage</a> <a href="#">EligibleAssets</a></p>   |
| <p>annotation</p> | <p>documentation<br/>Non_Recycled_Waste_Ratio (31875 - 31878)</p>   |

element

**EETReportType/PrincipalAdverseIndicators/MoreClimateAndEnvironmentRelatedIndicators/WaterWasteAndLandProtection/CompaniesWhoseOperationsAffectThreatenedSpecies**

|                   |   |
|-------------------|---|
| <p>diagram</p>    |   |
| <p>type</p>       | <p><a href="#">PercentageStrategyCoverageType</a></p>   |
| <p>properties</p> | <p>isRef 0<br/>minOcc 0<br/>maxOcc 1<br/>content complex</p>  |
| <p>children</p>   | <p><a href="#">Value</a> <a href="#">ConsideredInInvestmentStrategy</a> <a href="#">Coverage</a> <a href="#">EligibleAssets</a></p> |
| <p>annotation</p> | <p>documentation<br/>Share_Of_Investments_In_Investee_Companies_Whose_Operations_Affect_Threatened_Species (31880 - 31910)</p>      |

element

**EETReportType/PrincipalAdverseIndicators/MoreClimateAndEnvironmentRelatedIndicators/WaterWasteAndLandProtection/CompaniesWithoutBiodiversityProtection**

|                   |   |
|-------------------|---|
| <p>diagram</p>    |   |
| <p>type</p>       | <p><a href="#">PercentageStrategyCoverageType</a></p>   |
| <p>properties</p> | <p>isRef 0<br/>minOcc 0<br/>maxOcc 1<br/>content complex</p>  |
| <p>children</p>   | <p><a href="#">Value</a> <a href="#">ConsideredInvestmentStrategy</a> <a href="#">Coverage</a> <a href="#">EligibleAssets</a></p>   |
| <p>annotation</p> | <p>documentation<br/>Share_Of_Investments_In_Investee_Companies_Without_A_Biodiversity_Protection_Policy_Covering_Operational_Sites_Owned_Leased_Managed_In_Or_Adjacent_To_A_Protected_Area_Or_An_Area_Of_High_Biodiversity_Value_Outside_Protected_Areas (31920 - 31950)</p> |

element

**EETReportType/PrincipalAdverseIndicators/MoreClimateAndEnvironmentRelatedIndicators/WaterWasteAndLandProtection/CompaniesWithoutDeforestationPolicy**

|            |  |
|------------|--|
| diagram    |  |
| type       | <a href="#">PercentageStrategyCoverageType</a>   |
| properties | isRef 0<br>minOcc 0<br>maxOcc 1<br>content complex   |
| children   | <a href="#">Value</a> <a href="#">ConsideredInInvestmentStrategy</a> <a href="#">Coverage</a> <a href="#">EligibleAssets</a> |
| annotation | documentation<br>Share_Of_Investee_Companies_Without_Deforestation_Policy (31960 - 31990)                                    |

element

**EETReportType/PrincipalAdverseIndicators/MoreClimateAndEnvironmentRelatedIndicators/GreenSecurities**

|            |  |
|------------|--|
| diagram    |  |
| properties | isRef 0<br>minOcc 0<br>maxOcc 1<br>content complex                                 |
| children   | <a href="#">SecuritiesNotCertifiedGreen</a> <a href="#">BondsNotCertifiedGreen</a> |
| annotation | documentation<br>32000 - 32070   |

element

**EETReportType/PrincipalAdverseIndicators/MoreClimateAndEnvironmentRelatedIndicators/GreenSecurities/SecuritiesNotCertifiedGreen**

|                   |   |
|-------------------|---|
| <p>diagram</p>    |   |
| <p>type</p>       | <p><a href="#">PercentageStrategyCoverageType</a></p>   |
| <p>properties</p> | <p>isRef 0<br/>minOcc 0<br/>maxOcc 1<br/>content complex</p>  |
| <p>children</p>   | <p><a href="#">Value</a> <a href="#">ConsideredInInvestmentStrategy</a> <a href="#">Coverage</a> <a href="#">EligibleAssets</a></p> |
| <p>annotation</p> | <p>documentation<br/>Share_Of_Securities_Not_Certified_Green (32000 - 32030)</p>  |



element

**EETReportType/PrincipalAdverseIndicators/MoreClimateAndEnvironmentRelatedIndicators/GreenSecurities/BondsNotCertifiedGreen**

|                   |   |
|-------------------|---|
| <p>diagram</p>    | <p><b>BondsNotCertifiedGreen</b><br/>Share_Of_Bonds_Non_Certified_Green (32040 - 32070)</p> <p><b>PercentageStrategyCoverageType</b></p> <ul style="list-style-type: none"> <li><b>Value</b><br/>Share of investments in this category in percentage</li> <li><b>ConsideredInInvestmentStrategy</b><br/>Yes (= commitment of the asset manager to improve the PAI), No</li> <li><b>Coverage</b><br/>% of the notional / AUM, which provide effectively data, or where data could be estimated</li> <li><b>EligibleAssets</b><br/>% of assets (versus notional / AUM), which could provide data</li> </ul> |
| <p>type</p>       | <p><a href="#">PercentageStrategyCoverageType</a></p>   |
| <p>properties</p> | <p>isRef 0<br/>minOcc 0<br/>maxOcc 1<br/>content complex</p>  |
| <p>children</p>   | <p><a href="#">Value</a> <a href="#">ConsideredInInvestmentStrategy</a> <a href="#">Coverage</a> <a href="#">EligibleAssets</a></p>   |
| <p>annotation</p> | <p>documentation<br/>Share_Of_Bonds_Non_Certified_Green (32040 - 32070)</p>   |

element

**EETReportType/PrincipalAdverseIndicators/MoreClimateAndEnvironmentRelatedIndicators/RealEstateInvestments**

|                   |   |
|-------------------|---|
| <p>diagram</p>    | <p>The diagram illustrates the structure of the <b>RealEstateInvestments</b> element (ID 32080 - 32430). It is a complex type containing five sub-elements, each represented by a dashed box with a plus icon:</p> <ul style="list-style-type: none"> <li><b>GreenhouseGasEmissions</b> (32270): GHG_Emissions_Real_Estate (32080 - 32270)</li> <li><b>EnergyConsumptionIntensity</b> (32310): Energy_Consumption_Intensity (32280 - 32310)</li> <li><b>WasteProductionInOperations</b> (32350): Waste_Production_In_Operations (32320 - 32350)</li> <li><b>RawMaterialConsumptionForNewConstructionAndMajorRenovations</b> (32390): Raw_Material_Consumption_For_New_Construction_And_Major_Renovations (32360 - 32390)</li> <li><b>LandArtificialisation</b> (32430): Land_Artificialisation (32400 - 32430)</li> </ul> |
| <p>properties</p> | <p>isRef 0<br/>minOcc 0<br/>maxOcc 1<br/>content complex</p>  |
| <p>children</p>   | <p><a href="#">GreenhouseGasEmissions</a> <a href="#">EnergyConsumptionIntensity</a> <a href="#">WasteProductionInOperations</a> <a href="#">RawMaterialConsumptionForNewConstructionAndMajorRenovations</a> <a href="#">LandArtificialisation</a></p>  |
| <p>annotation</p> | <p>documentation<br/>32080 - 32430</p>  |

element

**EETReportType/PrincipalAdverseIndicators/MoreClimateAndEnvironmentRelatedIndicators/RealEstateInvestments/GreenhouseGasEmissions**

|                   |  |
|-------------------|--|
| <p>diagram</p>    | <p>The diagram illustrates the structure of the <b>GreenhouseGasEmissions</b> element (ID 32270). It is a complex type containing five sub-elements, each represented by a dashed box with a plus icon:</p> <ul style="list-style-type: none"> <li><b>Scope1</b></li> <li><b>Scope2</b></li> <li><b>Scope3</b></li> <li><b>TotalScope12</b></li> <li><b>TotalScope123</b></li> </ul> |
| <p>properties</p> | <p>isRef 0<br/>minOcc 0<br/>maxOcc 1<br/>content complex</p>   |
| <p>children</p>   | <p><a href="#">Scope1</a> <a href="#">Scope2</a> <a href="#">Scope3</a> <a href="#">TotalScope12</a> <a href="#">TotalScope123</a></p>   |
| <p>annotation</p> | <p>documentation<br/>GHG_Emissions_Real_Estate (32080 - 32270)</p>   |

element

**EETReportType/PrincipalAdverseIndicators/MoreClimateAndEnvironmentRelatedIndicators/RealEstateInvestments/GreenhouseGasEmissions/Scope1**

|                   |   |
|-------------------|---|
| <p>diagram</p>    | <pre> classDiagram     class ValueStrategyCoverageType {         Value         ConsideredInInvestmentStrategy         Coverage         EligibleAssets     }     class Scope1     ValueStrategyCoverageType --&gt; Scope1     </pre> |
| <p>type</p>       | <p><a href="#">ValueStrategyCoverageType</a></p>  |
| <p>properties</p> | <p>isRef 0<br/> minOcc 0<br/> maxOcc 1<br/> content complex</p>   |
| <p>children</p>   | <p><a href="#">Value</a> <a href="#">ConsideredInInvestmentStrategy</a> <a href="#">Coverage</a> <a href="#">EligibleAssets</a></p>   |

element

**EETReportType/PrincipalAdverseIndicators/MoreClimateAndEnvironmentRelatedIndicators/RealEstateInvestments/GreenhouseGasEmissions/Scope2**

|            |  |
|------------|--|
| diagram    | <pre>classDiagram     class ValueStrategyCoverageType {         Value         ConsideredInInvestmentStrategy         Coverage         EligibleAssets     }     class Scope2     ValueStrategyCoverageType o-- Scope2</pre> |
| type       | <a href="#">ValueStrategyCoverageType</a>  |
| properties | isRef 0<br>minOcc 0<br>maxOcc 1<br>content complex   |
| children   | <a href="#">Value</a> <a href="#">ConsideredInInvestmentStrategy</a> <a href="#">Coverage</a> <a href="#">EligibleAssets</a>   |

element

**EETReportType/PrincipalAdverseIndicators/MoreClimateAndEnvironmentRelatedIndicators/RealEstateInvestments/GreenhouseGasEmissions/Scope3**

|                   |  |
|-------------------|--|
| <p>diagram</p>    | <pre> classDiagram     class ValueStrategyCoverageType {         Value         ConsideredInInvestmentStrategy         Coverage         EligibleAssets     }     class Scope3     ValueStrategyCoverageType o-- Scope3     </pre> |
| <p>type</p>       | <p><a href="#">ValueStrategyCoverageType</a></p>   |
| <p>properties</p> | <p>isRef 0<br/> minOcc 0<br/> maxOcc 1<br/> content complex</p>  |
| <p>children</p>   | <p><a href="#">Value</a> <a href="#">ConsideredInInvestmentStrategy</a> <a href="#">Coverage</a> <a href="#">EligibleAssets</a></p>  |

element

**EETReportType/PrincipalAdverseIndicators/MoreClimateAndEnvironmentRelatedIndicators/RealEstateInvestments/GreenhouseGasEmissions/TotalScope12**

|            |  |
|------------|--|
| diagram    | <pre>classDiagram     class ValueStrategyCoverageType {         Value         ConsideredInInvestmentStrategy         Coverage         EligibleAssets     }     TotalScope12 ..&gt; ValueStrategyCoverageType</pre> |
| type       | <a href="#">ValueStrategyCoverageType</a>  |
| properties | isRef 0<br>minOcc 0<br>maxOcc 1<br>content complex   |
| children   | <a href="#">Value</a> <a href="#">ConsideredInInvestmentStrategy</a> <a href="#">Coverage</a> <a href="#">EligibleAssets</a>   |

element

**EETReportType/PrincipalAdverseIndicators/MoreClimateAndEnvironmentRelatedIndicators/RealEstateInvestments/GreenhouseGasEmissions/TotalScope123**

|                   |   |
|-------------------|---|
| <p>diagram</p>    | <pre> classDiagram     class ValueStrategyCoverageType {         Value         ConsideredInInvestmentStrategy         Coverage         EligibleAssets     }     class TotalScope123     TotalScope123 --&gt; ValueStrategyCoverageType     </pre> |
| <p>type</p>       | <p><a href="#">ValueStrategyCoverageType</a></p>  |
| <p>properties</p> | <p>isRef 0<br/>minOcc 0<br/>maxOcc 1<br/>content complex</p>  |
| <p>children</p>   | <p><a href="#">Value</a> <a href="#">ConsideredInInvestmentStrategy</a> <a href="#">Coverage</a> <a href="#">EligibleAssets</a></p>   |

element

**EETReportType/PrincipalAdverseIndicators/MoreClimateAndEnvironmentRelatedIndicators/RealEstateInvestments/EnergyConsumptionIntensity**

|                   |  |
|-------------------|--|
| <p>diagram</p>    | <pre> classDiagram     class EnergyConsumptionIntensity {         Energy_Consumption_Intensity (32280 - 32310)     }     class ValueStrategyCoverageType {         Value         ConsideredInInvestmentStrategy         Coverage         EligibleAssets     }     EnergyConsumptionIntensity -- ValueStrategyCoverageType     </pre> <p>The diagram illustrates the structure of the <b>EnergyConsumptionIntensity</b> element. It is associated with the <b>ValueStrategyCoverageType</b> class. The <b>ValueStrategyCoverageType</b> class contains four attributes: <b>Value</b> (Number of units in product currency), <b>ConsideredInInvestmentStrategy</b> (Yes (= commitment of the asset manager to improve the PAI), No), <b>Coverage</b> (% of the notional / AUM, which provide effectively data, or where data could be estimated), and <b>EligibleAssets</b> (% of assets (versus notional / AUM), which could provide data).</p> |
| <p>type</p>       | <p><a href="#">ValueStrategyCoverageType</a></p>   |
| <p>properties</p> | <p>isRef 0<br/>minOcc 0<br/>maxOcc 1<br/>content complex</p>   |
| <p>children</p>   | <p><a href="#">Value</a> <a href="#">ConsideredInInvestmentStrategy</a> <a href="#">Coverage</a> <a href="#">EligibleAssets</a></p>  |
| <p>annotation</p> | <p>documentation<br/>Energy_Consumption_Intensity (32280 - 32310)</p>  |



element

**EETReportType/PrincipalAdverseIndicators/MoreClimateAndEnvironmentRelatedIndicators/RealEstateInvestments/WasteProductionInOperations**

|                   |   |
|-------------------|---|
| <p>diagram</p>    | <pre> classDiagram     class WasteProductionInOperations {         Waste_Production_In_Operations (32320 - 32350)     }     class PercentageStrategyCoverageType {         Value         ConsideredInInvestmentStrategy         Coverage         EligibleAssets     }     WasteProductionInOperations -- PercentageStrategyCoverageType     </pre> <p>The diagram illustrates the structure of the <b>WasteProductionInOperations</b> element. It is associated with the <b>PercentageStrategyCoverageType</b> container. The container includes the following attributes:</p> <ul style="list-style-type: none"> <li><b>Value</b>: Share of investments in this category in percentage</li> <li><b>ConsideredInInvestmentStrategy</b>: Yes (= commitment of the asset manager to improve the PAI), No</li> <li><b>Coverage</b>: % of the notional / AUM, which provide effectively data, or where data could be estimated</li> <li><b>EligibleAssets</b>: % of assets (versus notional / AUM), which could provide data</li> </ul> |
| <p>type</p>       | <p><a href="#">PercentageStrategyCoverageType</a></p>   |
| <p>properties</p> | <p>isRef 0<br/>minOcc 0<br/>maxOcc 1<br/>content complex</p>  |
| <p>children</p>   | <p><a href="#">Value</a> <a href="#">ConsideredInInvestmentStrategy</a> <a href="#">Coverage</a> <a href="#">EligibleAssets</a></p>   |
| <p>annotation</p> | <p>documentation<br/>Waste_Production_In_Operations (32320 - 32350)</p>   |

element

**EETReportType/PrincipalAdverseIndicators/MoreClimateAndEnvironmentRelatedIndicators/RealEstateInvestments/RawMaterialConsumptionForNewConstructionAndMajorRenovations**

|                   |  |
|-------------------|--|
| <p>diagram</p>    | <p>The diagram illustrates the structure of the <b>RawMaterialConsumptionForNewConstructionAndMajorRenovations</b> element. It is a complex type that contains four child elements: <b>Value</b>, <b>ConsideredInInvestmentStrategy</b>, <b>Coverage</b>, and <b>EligibleAssets</b>. The <b>Value</b> element is described as 'Share of investments in this category in percentage'. The <b>ConsideredInInvestmentStrategy</b> element is described as 'Yes (= commitment of the asset manager to improve the PAI), No'. The <b>Coverage</b> element is described as '% of the notional / AUM, which provide effectively data, or where data could be estimated'. The <b>EligibleAssets</b> element is described as '% of assets (versus notional / AUM), which could provide data'.</p> |
| <p>type</p>       | <p><a href="#">PercentageStrategyCoverageType</a></p>  |
| <p>properties</p> | <p>isRef 0<br/>minOcc 0<br/>maxOcc 1<br/>content complex</p>   |
| <p>children</p>   | <p><a href="#">Value</a> <a href="#">ConsideredInInvestmentStrategy</a> <a href="#">Coverage</a> <a href="#">EligibleAssets</a></p>  |
| <p>annotation</p> | <p>documentation<br/>Raw_Material_Consumption_For_New_Construction_And_Major_Renovations (32360 - 32390)</p>   |

element

**EETReportType/PrincipalAdverseIndicators/MoreClimateAndEnvironmentRelatedIndicators/RealEstateInvestments/LandArtificialisation**

|                   |  |
|-------------------|--|
| <p>diagram</p>    | <p>The diagram illustrates the structure of the <b>LandArtificialisation</b> element (code range 32400 - 32430). It is connected to a complex structure titled <b>PercentageStrategyCoverageType</b>. This structure contains four sub-elements:         <ul style="list-style-type: none"> <li><b>Value</b>: Share of investments in this category in percentage.</li> <li><b>ConsideredInInvestmentStrategy</b>: Yes (= commitment of the asset manager to improve the PAI), No.</li> <li><b>Coverage</b>: % of the notional / AUM, which provide effectively data, or where data could be estimated.</li> <li><b>EligibleAssets</b>: % of assets (versus notional / AUM), which could provide data.</li> </ul> </p> |
| <p>type</p>       | <p><a href="#">PercentageStrategyCoverageType</a></p>  |
| <p>properties</p> | <p>isRef 0<br/>minOcc 0<br/>maxOcc 1<br/>content complex</p>   |
| <p>children</p>   | <p><a href="#">Value</a> <a href="#">ConsideredInInvestmentStrategy</a> <a href="#">Coverage</a> <a href="#">EligibleAssets</a></p>  |
| <p>annotation</p> | <p>documentation<br/>Land_Artificialisation (32400 - 32430)</p>  |

element **EETReportType/PrincipalAdverseIndicators/MoreSocialAndEmployeeMatters**

|                   |  |
|-------------------|--|
| <p>diagram</p>    | <p>The diagram illustrates the structure of the <b>MoreSocialAndEmployeeMatters</b> element (code range 32440 - 33440). It is connected to a complex structure containing four sub-elements:         <ul style="list-style-type: none"> <li><b>EmployeeMatters</b> (32440 - 32830)</li> <li><b>HumanRightsMatters</b> (32840 - 33070)</li> <li><b>CorruptionAndBribery</b> (33080 - 33180)</li> <li><b>SovereignAndSupranationalInv...</b> (33190 - 33440)</li> </ul> </p> |
| <p>properties</p> | <p>isRef 0<br/>minOcc 0<br/>maxOcc 1<br/>content complex</p>   |
| <p>children</p>   | <p><a href="#">EmployeeMatters</a> <a href="#">HumanRightsMatters</a> <a href="#">CorruptionAndBribery</a> <a href="#">SovereignAndSupranationalInvestments</a></p>  |
| <p>annotation</p> | <p>documentation<br/>32440 - 33440</p>   |

element **EETReportType/PrincipalAdverseIndicators/MoreSocialAndEmployeeMatters/EmployeeMatters**

|                   |  |
|-------------------|--|
| <p>diagram</p>    | <p><b>EmployeeMatters</b> (32440 - 32830)</p> <ul style="list-style-type: none"> <li><b>CompaniesWithoutWorkplaceAccidentPreventionPolicy</b> (32440 - 32470)<br/>Exposure_To_Companies_Without_Workplace_Accident_Prevention_Policy (32440 - 32470)</li> <li><b>RateOfAccidents</b> (32480 - 32510)<br/>Rate_Of_Accidents (32480 - 32510)</li> <li><b>NumberOfDaysLostForInjuriesAccidentsFatalitiesIllness</b> (32520 - 32550)<br/>Number_Of_Days_Lost_For_Injuries_Accidents_Fatalities_Illness (32520 - 32550)</li> <li><b>CompaniesWithoutAnySupplierCodeOfConductAgainstUnsafeWorkingConditionsPrecariousWorkChildLabourAndForcedLabour</b> (32560 - 32590)<br/>Share_Of_Investments_In_Investee_Companies_Without_Any_Supplier_Code_Of_Conduct_Against_Unsafe_Working_Conditions_Precarious_Work_Child_Labour_And_Forced_Labour (32560 - 32590)</li> <li><b>CompaniesWithoutAnyGrievanceOrComplaintsHandlingMechanism</b> (32640 - 32670)<br/>Share_Of_Investments_In_Investee_Companies_Without_Any_Grievance_Or_Complaints_Handling_Mechanism (32640 - 32670)</li> <li><b>CompaniesWithInsufficientWhistleblowerProtection</b> (32680 - 32710)<br/>Share_Of_Investee_Companies_With_Insufficient_Whistleblower_Protection (32680 - 32710)</li> <li><b>NumberOfIncidentsOfDiscriminationReportedInInvesteeCompanies</b> (32720 - 32750)<br/>Number_Of_Incidents_Of_Discrimination_Reported_In_Investee_Companies (32720 - 32750)</li> <li><b>NumberOfIncidentsOfDiscriminationLeadingToSanctionsInInvesteeCompanies</b> (32760 - 32790)<br/>Number_Of_Incidents_Of_Discrimination_Leading_To_Sanctions_In_Investee_Companies (32760 - 32790)</li> <li><b>ExcessiveCEOPayRatio</b> (32800 - 32830)<br/>Excessive_CEO_Pay_Ratio (32800 - 32830)</li> </ul> |
| <p>properties</p> | <p>isRef 0<br/>minOcc 0<br/>maxOcc 1<br/>content complex</p>   |
| <p>children</p>   | <p><a href="#">CompaniesWithoutWorkplaceAccidentPreventionPolicy</a> <a href="#">RateOfAccidents</a> <a href="#">NumberOfDaysLostForInjuriesAccidentsFatalitiesIllness</a> <a href="#">CompaniesWithoutAnySupplierCodeOfConductAgainstUnsafeWorkingConditions</a> <a href="#">CompaniesWithoutAnyGrievanceOrComplaintsHandlingMechanism</a> <a href="#">CompaniesWithInsufficientWhistleblowerProtection</a> <a href="#">NumberOfIncidentsOfDiscriminationReported</a> <a href="#">NumberOfIncidentsOfDiscriminationLeadingToSanctions</a> <a href="#">ExcessiveCEOPayRatio</a></p>  |
| <p>annotation</p> | <p>documentation<br/>32440 - 32830</p>   |

element

**EETReportType/PrincipalAdverseIndicators/MoreSocialAndEmployeeMatters/EmployeeMatters/CompaniesWithoutWorkplaceAccidentPreventionPolicy**

|                   |  |
|-------------------|--|
| <p>diagram</p>    | <p>The diagram illustrates the structure of the <b>CompaniesWithoutWorkplaceAccidentPreventionPolicy</b> element. It is a complex type that contains four sub-elements:</p> <ul style="list-style-type: none"> <li><b>Value</b>: Share of investments in this category in percentage</li> <li><b>ConsideredInInvestmentStrategy</b>: Yes (= commitment of the asset manager to improve the PAI), No</li> <li><b>Coverage</b>: % of the notional / AUM, which provide effectively data, or where data could be estimated</li> <li><b>EligibleAssets</b>: % of assets (versus notional / AUM), which could provide data</li> </ul> |
| <p>type</p>       | <p><a href="#">PercentageStrategyCoverageType</a></p>  |
| <p>properties</p> | <p>isRef 0<br/>minOcc 0<br/>maxOcc 1<br/>content complex</p>   |
| <p>children</p>   | <p><a href="#">Value</a> <a href="#">ConsideredInInvestmentStrategy</a> <a href="#">Coverage</a> <a href="#">EligibleAssets</a></p>  |
| <p>annotation</p> | <p>documentation<br/>Exposure_To_Companies_Without_Workplace_Accident_Prevention_Policy (32440 - 32470)</p>  |

element

**EETReportType/PrincipalAdverseIndicators/MoreSocialAndEmployeeMatters/EmployeeMatters/RateOf Accidents**

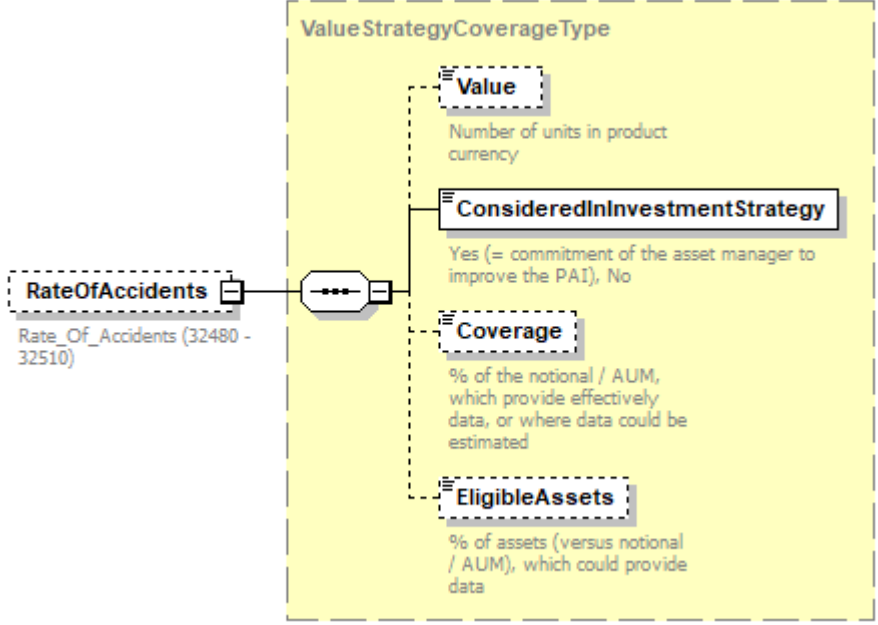
|                   |  |
|-------------------|--|
| <p>diagram</p>    |  <pre> classDiagram     class RateOfAccidents {         Rate_Of_Accidents (32480 - 32510)     }     class ValueStrategyCoverageType {         Value         ConsideredInInvestmentStrategy         Coverage         EligibleAssets     }     RateOfAccidents -- ValueStrategyCoverageType     </pre> |
| <p>type</p>       | <p><a href="#">ValueStrategyCoverageType</a></p>   |
| <p>properties</p> | <p>isRef 0<br/>minOcc 0<br/>maxOcc 1<br/>content complex</p>   |
| <p>children</p>   | <p><a href="#">Value</a> <a href="#">ConsideredInInvestmentStrategy</a> <a href="#">Coverage</a> <a href="#">EligibleAssets</a></p>  |
| <p>annotation</p> | <p>documentation<br/>Rate_Of_Accidents (32480 - 32510)</p>   |

element

**EETReportType/PrincipalAdverseIndicators/MoreSocialAndEmployeeMatters/EmployeeMatters/Number  
OfDaysLostForInjuriesAccidentsFatalitiesIllness**

|                   |  |
|-------------------|--|
| <p>diagram</p>    | <pre> classDiagram     class NumberOfDaysLostForInjuries... {         Number_Of_Days_Lost_For_Injuries_Accidents_Fatalities_Illness (32520 - 32550)     }     class ValueStrategyCoverageType {         Value         ConsideredInInvestmentStrategy         Coverage         EligibleAssets     }     NumberOfDaysLostForInjuries... "1" *-- "1" ValueStrategyCoverageType     </pre> |
| <p>type</p>       | <p><a href="#">ValueStrategyCoverageType</a></p>   |
| <p>properties</p> | <p>isRef 0<br/>minOcc 0<br/>maxOcc 1<br/>content complex</p>   |
| <p>children</p>   | <p><a href="#">Value</a> <a href="#">ConsideredInInvestmentStrategy</a> <a href="#">Coverage</a> <a href="#">EligibleAssets</a></p>  |
| <p>annotation</p> | <p>documentation<br/>Number_Of_Days_Lost_For_Injuries_Accidents_Fatalities_Illness (32520 - 32550)</p>   |

element

**EETReportType/PrincipalAdverseIndicators/MoreSocialAndEmployeeMatters/EmployeeMatters/CompaniesWithoutAnySupplierCodeOfConductAgainstUnsafeWorkingConditions**

|                   |  |
|-------------------|--|
| <p>diagram</p>    | <pre> classDiagram     class CompaniesWithoutAnySupplier... {         Share_Of_Investments_In_Investee_Companies_Without_Any_Supplier_Code_Of_Conduct_Against_Unsafe_Working_Conditions_Precarious_Work_Child_Labour_And_Forced_Labour (32560 - 32590)     }     class PercentageStrategyCoverageType {         Value         ConsideredInInvestmentStrategy         Coverage         EligibleAssets     }     CompaniesWithoutAnySupplier... -- PercentageStrategyCoverageType     </pre> <p><b>CompaniesWithoutAnySupplier...</b><br/>Share_Of_Investments_In_Investee_Companies_Without_Any_Supplier_Code_Of_Conduct_Against_Unsafe_Working_Conditions_Precarious_Work_Child_Labour_And_Forced_Labour (32560 - 32590)</p> <p><b>PercentageStrategyCoverageType</b></p> <ul style="list-style-type: none"> <li><b>Value</b>: Share of investments in this category in percentage</li> <li><b>ConsideredInInvestmentStrategy</b>: Yes (= commitment of the asset manager to improve the PAI), No</li> <li><b>Coverage</b>: % of the notional / AUM, which provide effectively data, or where data could be estimated</li> <li><b>EligibleAssets</b>: % of assets (versus notional / AUM), which could provide data</li> </ul> |
| <p>type</p>       | <p><a href="#">PercentageStrategyCoverageType</a></p>  |
| <p>properties</p> | <p>isRef 0<br/>minOcc 0<br/>maxOcc 1<br/>content complex</p>   |
| <p>children</p>   | <p><a href="#">Value</a> <a href="#">ConsideredInInvestmentStrategy</a> <a href="#">Coverage</a> <a href="#">EligibleAssets</a></p>  |
| <p>annotation</p> | <p>documentation<br/>Share_Of_Investments_In_Investee_Companies_Without_Any_Supplier_Code_Of_Conduct_Against_Unsafe_Working_Conditions_Precarious_Work_Child_Labour_And_Forced_Labour (32560 - 32590)</p>  |



element

**EETReportType/PrincipalAdverseIndicators/MoreSocialAndEmployeeMatters/EmployeeMatters/CompaniesWithoutAnyGrievanceOrComplaintsHandlingMechanism**

|                   |  |
|-------------------|--|
| <p>diagram</p>    |  |
| <p>type</p>       | <p><a href="#">PercentageStrategyCoverageType</a></p>  |
| <p>properties</p> | <p>isRef 0<br/>minOcc 0<br/>maxOcc 1<br/>content complex</p>   |
| <p>children</p>   | <p><a href="#">Value</a> <a href="#">ConsideredInInvestmentStrategy</a> <a href="#">Coverage</a> <a href="#">EligibleAssets</a></p>        |
| <p>annotation</p> | <p>documentation<br/>Share_Of_Investments_In_Investee_Companies_Without_Any_Grievance_Or_Complaints_Handling_Mechanism (32640 - 32670)</p> |

element

**EETReportType/PrincipalAdverseIndicators/MoreSocialAndEmployeeMatters/EmployeeMatters/CompaniesWithInsufficientWhistleblowerProtection**

|                   |   |
|-------------------|---|
| <p>diagram</p>    |   |
| <p>type</p>       | <p><a href="#">PercentageStrategyCoverageType</a></p>   |
| <p>properties</p> | <p>isRef 0<br/>minOcc 0<br/>maxOcc 1<br/>content complex</p>  |
| <p>children</p>   | <p><a href="#">Value</a> <a href="#">ConsideredInInvestmentStrategy</a> <a href="#">Coverage</a> <a href="#">EligibleAssets</a></p> |
| <p>annotation</p> | <p>documentation<br/>Share_Of_Investee_Companies_With_Insufficient_Whistleblower_Protection (32680 - 32710)</p>                     |

element

**EETReportType/PrincipalAdverseIndicators/MoreSocialAndEmployeeMatters/EmployeeMatters/Number  
OfIncidentsOfDiscriminationReported**

|                   |   |
|-------------------|---|
| <p>diagram</p>    | <p>The diagram illustrates the structure of the <b>Number Of Incidents Of Discrimination Reported</b> element. It is a complex type that contains four child elements:</p> <ul style="list-style-type: none"> <li><b>Value</b>: Number of units in product currency</li> <li><b>ConsideredInInvestmentStrategy</b>: Yes (= commitment of the asset manager to improve the PAI), No</li> <li><b>Coverage</b>: % of the notional / AUM, which provide effectively data, or where data could be estimated</li> <li><b>EligibleAssets</b>: % of assets (versus notional / AUM), which could provide data</li> </ul> |
| <p>type</p>       | <p><a href="#">ValueStrategyCoverageType</a></p>  |
| <p>properties</p> | <p>isRef 0<br/>minOcc 0<br/>maxOcc 1<br/>content complex</p>  |
| <p>children</p>   | <p><a href="#">Value</a> <a href="#">ConsideredInInvestmentStrategy</a> <a href="#">Coverage</a> <a href="#">EligibleAssets</a></p>   |
| <p>annotation</p> | <p>documentation<br/>Number_Of_Incidents_Of_Discrimination_Reported_In_Investee_Companies (32720 - 32750)</p>   |

element

**EETReportType/PrincipalAdverseIndicators/MoreSocialAndEmployeeMatters/EmployeeMatters/Number  
OfIncidentsOfDiscriminationLeadingToSanctions**

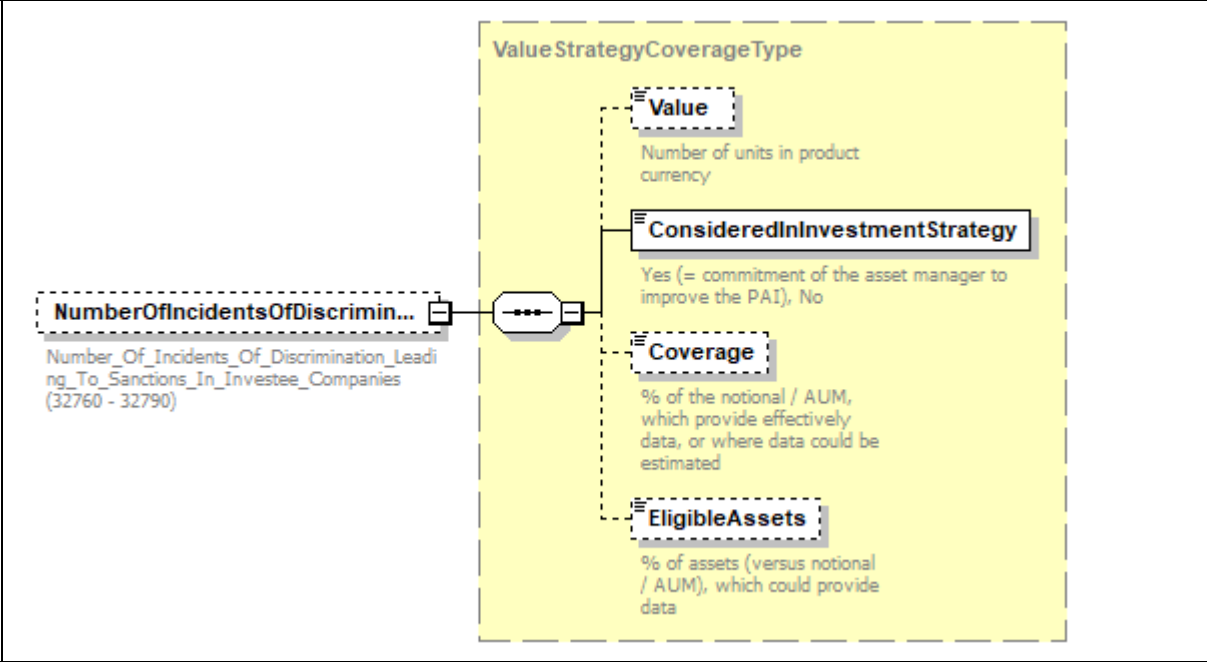
|                   |   |
|-------------------|---|
| <p>diagram</p>    |   |
| <p>type</p>       | <p><a href="#">ValueStrategyCoverageType</a></p>  |
| <p>properties</p> | <p>isRef 0<br/>minOcc 0<br/>maxOcc 1<br/>content complex</p>  |
| <p>children</p>   | <p><a href="#">Value</a> <a href="#">ConsideredInInvestmentStrategy</a> <a href="#">Coverage</a> <a href="#">EligibleAssets</a></p> |
| <p>annotation</p> | <p>documentation<br/>Number_Of_Incidents_Of_Discrimination_Leading_To_Sanctions_In_Investee_Companies (32760 - 32790)</p>           |

element

**EETReportType/PrincipalAdverseIndicators/MoreSocialAndEmployeeMatters/EmployeeMatters/ExcessiveCEOPayRatio**

|                   |   |
|-------------------|---|
| <p>diagram</p>    | <pre> classDiagram     class ExcessiveCEOPayRatio {         Excessive_CEO_Pay_Ratio (32800 - 32830)     }     class ValueStrategyCoverageType {         Value         ConsideredInInvestmentStrategy         Coverage         EligibleAssets     }     ExcessiveCEOPayRatio -- ValueStrategyCoverageType     </pre> |
| <p>type</p>       | <p><a href="#">ValueStrategyCoverageType</a></p>  |
| <p>properties</p> | <p>isRef 0<br/>minOcc 0<br/>maxOcc 1<br/>content complex</p>  |
| <p>children</p>   | <p><a href="#">Value</a> <a href="#">ConsideredInInvestmentStrategy</a> <a href="#">Coverage</a> <a href="#">EligibleAssets</a></p>   |
| <p>annotation</p> | <p>documentation<br/>Excessive_CEO_Pay_Ratio (32800 - 32830)</p>  |

element

**EETReportType/PrincipalAdverseIndicators/MoreSocialAndEmployeeMatters/HumanRightsMatters**

|                   |  |
|-------------------|--|
| <p>diagram</p>    | <pre> classDiagram     class HumanRightsMatters {         32840 - 33070     }     class CompaniesWithoutHumanRightPolicy {         Exposure_To_Companies_Without_Human_Right_Policy (32840 - 32870)     }     class CompaniesWithLackOfDueDiligence {         Exposure_To_Companies_With_Lack_Of_Due_Diligence (32880 - 32910)     }     class CompaniesWithoutSufficientHumanTraffickingPrevention {         Exposure_To_Companies_With_Lack_Of_Processes_And_Measures_For_Preventing_Trafficking_In_Human_Beings_Local (32920 - 32950)     }     class CompaniesOperationsSuppliersSignificantRiskChildLabour {         Exposure_To_Compagnies_With_Operations_And_Suppliers_At_Significant_Risk_Of_Incidents_Of_Child_Labour (32960 - 32990)     }     class CompaniesOperationsSuppliersSignificantRiskForcedLabour {         Exposure_To_Companies_With_Operations_And_Suppliers_At_Significant_Risk_Of_Incidents_Of_Forced_Or_Compulsory_Labour (33000 - 33030)     }     class NumberOfCasesOfSevereHumanRightsIssues {         Number_Of_Identified_Cases_of_Severe_Human_Rights_Issues_And_Incidents (33040 - 33070)     }     HumanRightsMatters &lt; -- CompaniesWithoutHumanRightPolicy     HumanRightsMatters &lt; -- CompaniesWithLackOfDueDiligence     HumanRightsMatters &lt; -- CompaniesWithoutSufficientHumanTraffickingPrevention     HumanRightsMatters &lt; -- CompaniesOperationsSuppliersSignificantRiskChildLabour     HumanRightsMatters &lt; -- CompaniesOperationsSuppliersSignificantRiskForcedLabour     HumanRightsMatters &lt; -- NumberOfCasesOfSevereHumanRightsIssues         </pre> |
| <p>properties</p> | <p>isRef 0<br/> minOcc 0<br/> maxOcc 1<br/> content complex</p>  |
| <p>children</p>   | <p><a href="#">CompaniesWithoutHumanRightPolicy</a> <a href="#">CompaniesWithLackOfDueDiligence</a><br/> <a href="#">CompaniesWithoutSufficientHumanTraffickingPrevention</a><br/> <a href="#">CompaniesOperationsSuppliersSignificantRiskChildLabour</a><br/> <a href="#">CompaniesOperationsSuppliersSignificantRiskForcedLabour</a> <a href="#">NumberOfCasesOfSevereHumanRightsIssues</a></p>  |
| <p>annotation</p> | <p>documentation<br/> 32840 - 33070</p>  |

element

**EETReportType/PrincipalAdverseIndicators/MoreSocialAndEmployeeMatters/HumanRightsMatters/CompaniesWithoutHumanRightPolicy**

|                   |   |
|-------------------|---|
| <p>diagram</p>    | <p>The diagram illustrates the structure of the <b>CompaniesWithoutHumanRightPolicy</b> element. It is a complex type that contains four sub-elements:</p> <ul style="list-style-type: none"> <li><b>Value</b>: Share of investments in this category in percentage</li> <li><b>ConsideredInInvestmentStrategy</b>: Yes (= commitment of the asset manager to improve the PAI), No</li> <li><b>Coverage</b>: % of the notional / AUM, which provide effectively data, or where data could be estimated</li> <li><b>EligibleAssets</b>: % of assets (versus notional / AUM), which could provide data</li> </ul> |
| <p>type</p>       | <p><a href="#">PercentageStrategyCoverageType</a></p>   |
| <p>properties</p> | <p>isRef 0<br/>minOcc 0<br/>maxOcc 1<br/>content complex</p>  |
| <p>children</p>   | <p><a href="#">Value</a> <a href="#">ConsideredInInvestmentStrategy</a> <a href="#">Coverage</a> <a href="#">EligibleAssets</a></p>   |
| <p>annotation</p> | <p>documentation<br/>Exposure_To_Companies_Without_Human_Right_Policy (32840 - 32870)</p>   |

element

**EETReportType/PrincipalAdverseIndicators/MoreSocialAndEmployeeMatters/HumanRightsMatters/CompaniesWithLackOfDueDiligence**

|                   |   |
|-------------------|---|
| <p>diagram</p>    |   |
| <p>type</p>       | <p><a href="#">PercentageStrategyCoverageType</a></p>   |
| <p>properties</p> | <p>isRef 0<br/>minOcc 0<br/>maxOcc 1<br/>content complex</p>  |
| <p>children</p>   | <p><a href="#">Value</a> <a href="#">ConsideredInInvestmentStrategy</a> <a href="#">Coverage</a> <a href="#">EligibleAssets</a></p> |
| <p>annotation</p> | <p>documentation<br/>Exposure_To_Companies_With_Lack_Of_Due_Diligence (32880 - 32910)</p>   |



element

**EETReportType/PrincipalAdverseIndicators/MoreSocialAndEmployeeMatters/HumanRightsMatters/CompaniesWithoutSufficientHumanTraffickingPrevention**

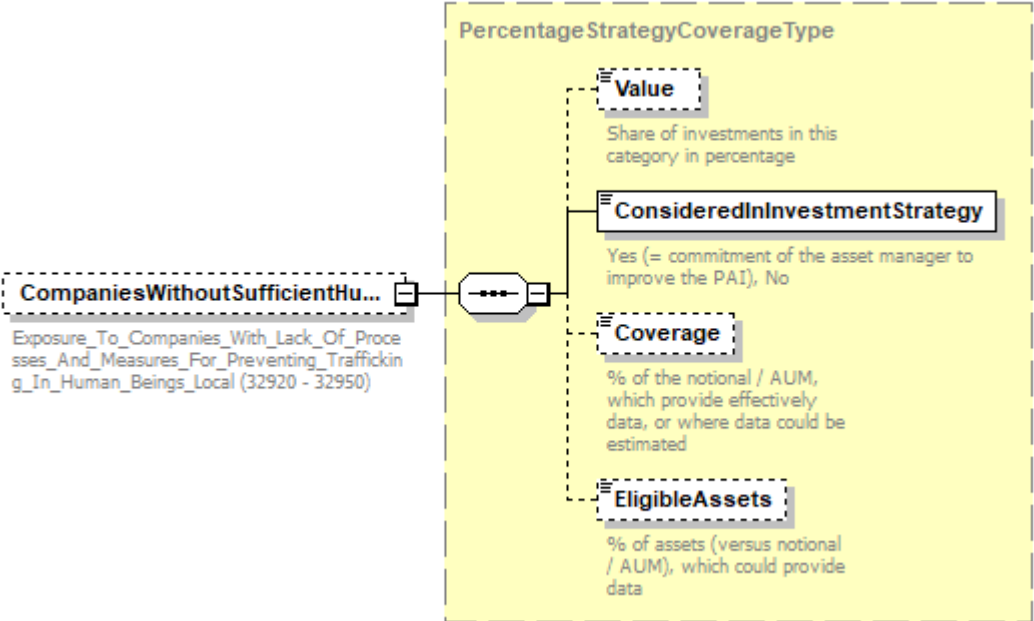
|                   |  |
|-------------------|--|
| <p>diagram</p>    |    |
| <p>type</p>       | <p><a href="#">PercentageStrategyCoverageType</a></p>  |
| <p>properties</p> | <p>isRef 0<br/>minOcc 0<br/>maxOcc 1<br/>content complex</p>   |
| <p>children</p>   | <p><a href="#">Value</a> <a href="#">ConsideredInInvestmentStrategy</a> <a href="#">Coverage</a> <a href="#">EligibleAssets</a></p>                |
| <p>annotation</p> | <p>documentation<br/>Exposure_To_Companies_With_Lack_Of_Proceses_And_Measures_For_Preventing_Trafficking_In_Human_Beings_Local (32920 - 32950)</p> |

element

**EETReportType/PrincipalAdverseIndicators/MoreSocialAndEmployeeMatters/HumanRightsMatters/CompaniesOperationsSuppliersSignificantRiskChildLabour**

|                   |  |
|-------------------|--|
| <p>diagram</p>    |  |
| <p>type</p>       | <p><a href="#">PercentageStrategyCoverageType</a></p>  |
| <p>properties</p> | <p>isRef 0<br/>minOcc 0<br/>maxOcc 1<br/>content complex</p>   |
| <p>children</p>   | <p><a href="#">Value</a> <a href="#">ConsideredInInvestmentStrategy</a> <a href="#">Coverage</a> <a href="#">EligibleAssets</a></p>            |
| <p>annotation</p> | <p>documentation<br/>Exposure_To_Compagnies_With_Operations_And_Suppliers_At_Significant_Risk_Of_Incidents_Of_Child_Labour (32960 - 32990)</p> |

element

**EETReportType/PrincipalAdverseIndicators/MoreSocialAndEmployeeMatters/HumanRightsMatters/CompaniesOperationsSuppliersSignificantRiskForcedLabour**

|                   |   |
|-------------------|---|
| <p>diagram</p>    |   |
| <p>type</p>       | <p><a href="#">PercentageStrategyCoverageType</a></p>   |
| <p>properties</p> | <p>isRef 0<br/>minOcc 0<br/>maxOcc 1<br/>content complex</p>  |
| <p>children</p>   | <p><a href="#">Value</a> <a href="#">ConsideredInInvestmentStrategy</a> <a href="#">Coverage</a> <a href="#">EligibleAssets</a></p>                           |
| <p>annotation</p> | <p>documentation<br/>Exposure_To_Compagnies_With_Operations_And_Suppliers_At_Significant_Risk_Of_Incidents_Of_Forced_Or_Compulsory_Labour (33000 - 33030)</p> |

element

**EETReportType/PrincipalAdverseIndicators/MoreSocialAndEmployeeMatters/HumanRightsMatters/NumberOfCasesOfSevereHumanRightsIssues**

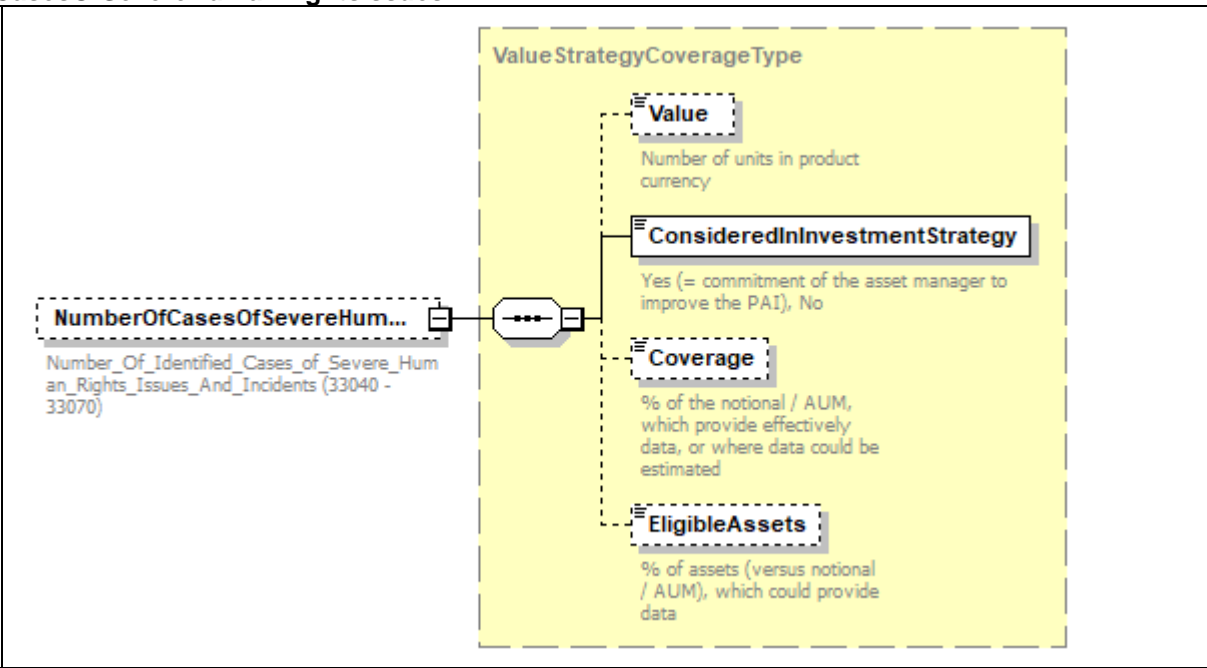
|                   |   |
|-------------------|---|
| <p>diagram</p>    |   |
| <p>type</p>       | <p><a href="#">ValueStrategyCoverageType</a></p>  |
| <p>properties</p> | <p>isRef 0<br/>minOcc 0<br/>maxOcc 1<br/>content complex</p>  |
| <p>children</p>   | <p><a href="#">Value</a> <a href="#">ConsideredInInvestmentStrategy</a> <a href="#">Coverage</a> <a href="#">EligibleAssets</a></p> |
| <p>annotation</p> | <p>documentation<br/>Number_Of_Identified_Cases_of_Severe_Human_Rights_Issues_And_Incidents (33040 - 33070)</p>                     |

element

**EETReportType/PrincipalAdverseIndicators/MoreSocialAndEmployeeMatters/CorruptionAndBribery**

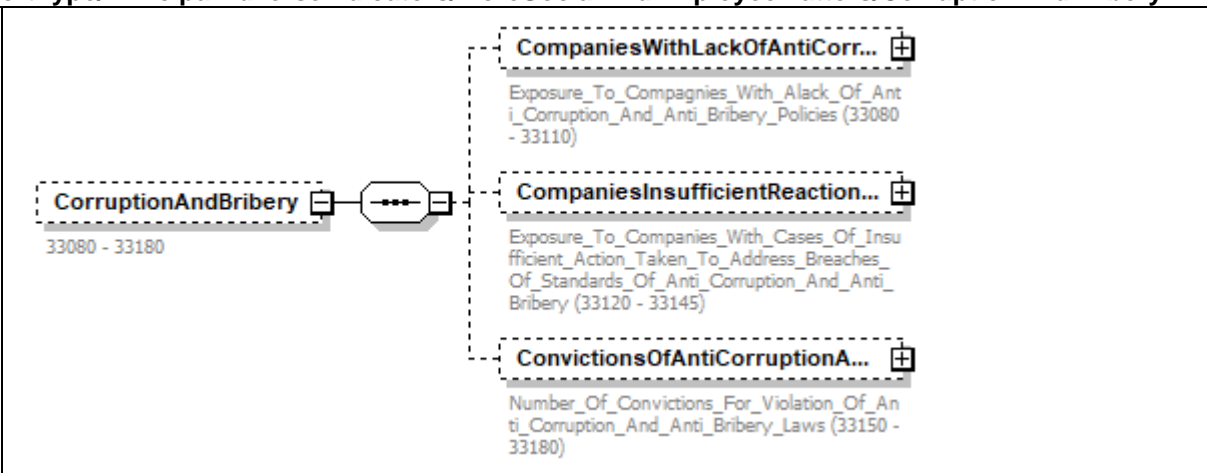
|                   |  |
|-------------------|--|
| <p>diagram</p>    |  |
| <p>properties</p> | <p>isRef 0<br/>minOcc 0<br/>maxOcc 1<br/>content complex</p>                         |

|            |   |
|------------|---|
| children   | <a href="#">CompaniesWithLackOfAntiCorruptionAndAntiBriberyPolicies</a><br><a href="#">CompaniesInsufficientReactionsOnCorruptionAndBribery</a> <a href="#">ConvictionsOfAntiCorruptionAndAntiBriberyLaws</a> |
| annotation | documentation<br>33080 - 33180  |

element

**EETReportType/PrincipalAdverseIndicators/MoreSocialAndEmployeeMatters/CorruptionAndBribery/CompaniesWithLackOfAntiCorruptionAndAntiBriberyPolicies**

|            |  |
|------------|--|
| diagram    |  |
| type       | <a href="#">PercentageStrategyCoverageType</a>   |
| properties | isRef 0<br>minOcc 0<br>maxOcc 1<br>content complex   |
| children   | <a href="#">Value</a> <a href="#">ConsideredInInvestmentStrategy</a> <a href="#">Coverage</a> <a href="#">EligibleAssets</a> |
| annotation | documentation<br>Exposure_To_Compagnies_With_Alack_Of_Anti_Corruption_And_Anti_Bribery_Policies (33080 - 33110)              |

element

**EETReportType/PrincipalAdverseIndicators/MoreSocialAndEmployeeMatters/CorruptionAndBribery/CompaniesInsufficientReactionsOnCorruptionAndBribery**

|                   |   |
|-------------------|---|
| <p>diagram</p>    |   |
| <p>type</p>       | <p><a href="#">PercentageStrategyCoverageType</a></p>   |
| <p>properties</p> | <p>isRef 0<br/>minOcc 0<br/>maxOcc 1<br/>content complex</p>  |
| <p>children</p>   | <p><a href="#">Value</a> <a href="#">ConsideredInInvestmentStrategy</a> <a href="#">Coverage</a> <a href="#">EligibleAssets</a></p>   |
| <p>annotation</p> | <p>documentation<br/>Exposure_To_Companies_With_Cases_Of_Insufficient_Action_Taken_To_Address_Breaches_Of_Standards_Of_Anti_Corruption_And_Anti_Bribery (33120 - 33145)</p> |

element

**EETReportType/PrincipalAdverseIndicators/MoreSocialAndEmployeeMatters/CorruptionAndBribery/ConvictionsOfAntiCorruptionAndAntiBriberyLaws**

|                   |   |
|-------------------|---|
| <p>diagram</p>    |   |
| <p>type</p>       | <p><a href="#">ValueStrategyCoverageType</a></p>  |
| <p>properties</p> | <p>isRef 0<br/>minOcc 0<br/>maxOcc 1<br/>content complex</p>  |
| <p>children</p>   | <p><a href="#">Value</a> <a href="#">ConsideredInInvestmentStrategy</a> <a href="#">Coverage</a> <a href="#">EligibleAssets</a></p> |
| <p>annotation</p> | <p>documentation<br/>Number_Of_Convictions_For_Violation_Of_Anti_Corruption_And_Anti_Bribery_Laws (33150 - 33180)</p>               |

element

**EETReportType/PrincipalAdverseIndicators/MoreSocialAndEmployeeMatters/SovereignAndSupranationalInvestments**

|                   |   |
|-------------------|---|
| <p>diagram</p>    | <p>The diagram shows a class <b>SovereignAndSupranationalInv...</b> (ID 33190 - 33440) connected to a collection of seven subclasses:</p> <ul style="list-style-type: none"> <li><b>AverageIncomeInequalityScore</b> (ID 33190 - 33220)</li> <li><b>AverageFreedomOfExpression...</b> (ID 33230 - 33260)</li> <li><b>AverageHumanRightsPerforma...</b> (ID 33265 - 33290)</li> <li><b>AverageCorruptionScore</b> (ID 33295 - 33320)</li> <li><b>NonCooperativeTaxJurisdictions</b> (ID 33330 - 33360)</li> <li><b>AveragePoliticalStabilityScore</b> (ID 33370 - 33400)</li> <li><b>AverageRuleOfLawScore</b> (ID 33410 - 33440)</li> </ul> |
| <p>properties</p> | <p>isRef 0<br/>minOcc 0<br/>maxOcc 1<br/>content complex</p>  |
| <p>children</p>   | <p><a href="#">AverageIncomeInequalityScore</a> <a href="#">AverageFreedomOfExpressionScore</a> <a href="#">AverageHumanRightsPerformance</a><br/><a href="#">AverageCorruptionScore</a> <a href="#">NonCooperativeTaxJurisdictions</a> <a href="#">AveragePoliticalStabilityScore</a> <a href="#">AverageRuleOfLawScore</a></p>  |
| <p>annotation</p> | <p>documentation<br/>33190 - 33440</p>  |



element

**EETReportType/PrincipalAdverseIndicators/MoreSocialAndEmployeeMatters/SovereignAndSupranationalInvestments/AverageIncomeInequalityScore**

|                   |   |
|-------------------|---|
| <p>diagram</p>    | <pre> classDiagram     class AverageIncomeInequalityScore {         Average_Income_Inequality_Score (33190 - 33220)     }     class ValueStrategyCoverageType {         Value         ConsideredInvestmentStrategy         Coverage         EligibleAssets     }     AverageIncomeInequalityScore -- ValueStrategyCoverageType     </pre> <p>The diagram illustrates the relationship between the <b>AverageIncomeInequalityScore</b> and the <b>ValueStrategyCoverageType</b>. The <b>AverageIncomeInequalityScore</b> is represented by a dashed box containing the text "Average_Income_Inequality_Score (33190 - 33220)". It is connected to the <b>ValueStrategyCoverageType</b> class, which is shown in a yellow dashed box. The <b>ValueStrategyCoverageType</b> class has four attributes: <b>Value</b> (Number of units in product currency), <b>ConsideredInvestmentStrategy</b> (Yes (= commitment of the asset manager to improve the PAI), No), <b>Coverage</b> (% of the notional / AUM, which provide effectively data, or where data could be estimated), and <b>EligibleAssets</b> (% of assets (versus notional / AUM), which could provide data).</p> |
| <p>type</p>       | <p><a href="#">ValueStrategyCoverageType</a></p>  |
| <p>properties</p> | <p>isRef 0<br/>minOcc 0<br/>maxOcc 1<br/>content complex</p>  |
| <p>children</p>   | <p><a href="#">Value</a> <a href="#">ConsideredInvestmentStrategy</a> <a href="#">Coverage</a> <a href="#">EligibleAssets</a></p>   |
| <p>annotation</p> | <p>documentation<br/>Average_Income_Inequality_Score (33190 - 33220)</p>  |

element

**EETReportType/PrincipalAdverseIndicators/MoreSocialAndEmployeeMatters/SovereignAndSupranationalInvestments/AverageFreedomOfExpressionScore**

|                   |  |
|-------------------|--|
| <p>diagram</p>    | <pre> classDiagram     class AverageFreedomOfExpressionScore {         Average_Freedom_of_Expression_Score (33230 - 33260)     }     class ValueStrategyCoverageType {         Value         ConsideredInInvestmentStrategy         Coverage         EligibleAssets     }     AverageFreedomOfExpressionScore -- ValueStrategyCoverageType         </pre> <p>The diagram illustrates the relationship between the <b>AverageFreedomOfExpressionScore</b> (ID: 33230 - 33260) and the <b>ValueStrategyCoverageType</b>. The <b>ValueStrategyCoverageType</b> is a complex type containing four elements: <b>Value</b> (Number of units in product currency), <b>ConsideredInInvestmentStrategy</b> (Yes/No commitment), <b>Coverage</b> (% of notional/AUM with data), and <b>EligibleAssets</b> (% of assets that could provide data).</p> |
| <p>type</p>       | <p><a href="#">ValueStrategyCoverageType</a></p>   |
| <p>properties</p> | <p>isRef 0<br/>minOcc 0<br/>maxOcc 1<br/>content complex</p>   |
| <p>children</p>   | <p><a href="#">Value</a> <a href="#">ConsideredInInvestmentStrategy</a> <a href="#">Coverage</a> <a href="#">EligibleAssets</a></p>  |
| <p>annotation</p> | <p>documentation<br/>Average_Freedom_of_Expression_Score (33230 - 33260)</p>   |

element

**EETReportType/PrincipalAdverseIndicators/MoreSocialAndEmployeeMatters/SovereignAndSupranationalInvestments/AverageHumanRightsPerformance**

|                   |  |
|-------------------|--|
| <p>diagram</p>    | <pre> classDiagram     class AverageHumanRightsPerformance {         Average_Human_Rights_Performance (33265 - 33290)     }     class ValueStrategyCoverageType {         Value         ConsideredInInvestmentStrategy         Coverage         EligibleAssets     }     AverageHumanRightsPerformance -- ValueStrategyCoverageType     </pre> <p>The diagram illustrates the relationship between the <b>AverageHumanRightsPerformance</b> class and the <b>ValueStrategyCoverageType</b> class. The <b>AverageHumanRightsPerformance</b> class is shown on the left with the identifier <code>Average_Human_Rights_Performance (33265 - 33290)</code>. It is connected to the <b>ValueStrategyCoverageType</b> class on the right. The <b>ValueStrategyCoverageType</b> class is highlighted in yellow and contains four attributes: <b>Value</b> (Number of units in product currency), <b>ConsideredInInvestmentStrategy</b> (Yes (= commitment of the asset manager to improve the PAI), No), <b>Coverage</b> (% of the notional / AUM, which provide effectively data, or where data could be estimated), and <b>EligibleAssets</b> (% of assets (versus notional / AUM), which could provide data).</p> |
| <p>type</p>       | <p><a href="#">ValueStrategyCoverageType</a></p>   |
| <p>properties</p> | <p>isRef 0<br/>minOcc 0<br/>maxOcc 1<br/>content complex</p>   |
| <p>children</p>   | <p><a href="#">Value</a> <a href="#">ConsideredInInvestmentStrategy</a> <a href="#">Coverage</a> <a href="#">EligibleAssets</a></p>  |
| <p>annotation</p> | <p>documentation<br/>Average_Human_Rights_Performance (33265 - 33290)</p>  |

element

**EETReportType/PrincipalAdverseIndicators/MoreSocialAndEmployeeMatters/SovereignAndSupranationalInvestments/AverageCorruptionScore**

|                   |   |
|-------------------|---|
| <p>diagram</p>    | <pre> classDiagram     class AverageCorruptionScore {         Average_Corruption_Score (33295 - 33320)     }     class ValueStrategyCoverageType {         Value         ConsideredInInvestmentStrategy         Coverage         EligibleAssets     }     AverageCorruptionScore -- ValueStrategyCoverageType     </pre> <p>The diagram illustrates the relationship between the <b>AverageCorruptionScore</b> class and the <b>ValueStrategyCoverageType</b> class. The <b>AverageCorruptionScore</b> class is shown on the left with the attribute <code>Average_Corruption_Score (33295 - 33320)</code>. It is connected to the <b>ValueStrategyCoverageType</b> class, which is highlighted in yellow and contains four attributes: <b>Value</b> (Number of units in product currency), <b>ConsideredInInvestmentStrategy</b> (Yes (= commitment of the asset manager to improve the PAI), No), <b>Coverage</b> (% of the notional / AUM, which provide effectively data, or where data could be estimated), and <b>EligibleAssets</b> (% of assets (versus notional / AUM), which could provide data).</p> |
| <p>type</p>       | <p><a href="#">ValueStrategyCoverageType</a></p>  |
| <p>properties</p> | <p>isRef 0<br/>minOcc 0<br/>maxOcc 1<br/>content complex</p>  |
| <p>children</p>   | <p><a href="#">Value</a> <a href="#">ConsideredInInvestmentStrategy</a> <a href="#">Coverage</a> <a href="#">EligibleAssets</a></p>   |
| <p>annotation</p> | <p>documentation<br/>Average_Corruption_Score (33295 - 33320)</p>   |

element

**EETReportType/PrincipalAdverseIndicators/MoreSocialAndEmployeeMatters/SovereignAndSupranationalInvestments/NonCooperativeTaxJurisdictions**

|                   |  |
|-------------------|--|
| <p>diagram</p>    | <pre> classDiagram     class NonCooperativeTaxJurisdictions {         Non_Cooperative_Tax_Jurisdictions (33330 - 33360)     }     class ValueStrategyCoverageType {         Value         ConsideredInInvestmentStrategy         Coverage         EligibleAssets     }     NonCooperativeTaxJurisdictions "1" -- "1" ValueStrategyCoverageType     </pre> <p>The diagram illustrates the relationship between <b>NonCooperativeTaxJurisdictions</b> (code 33330 - 33360) and the <b>ValueStrategyCoverageType</b>. The <b>ValueStrategyCoverageType</b> class is highlighted in yellow and contains four attributes: <b>Value</b> (Number of units in product currency), <b>ConsideredInInvestmentStrategy</b> (Yes (= commitment of the asset manager to improve the PAI), No), <b>Coverage</b> (% of the notional / AUM, which provide effectively data, or where data could be estimated), and <b>EligibleAssets</b> (% of assets (versus notional / AUM), which could provide data). A solid line with an open arrowhead connects the <b>NonCooperativeTaxJurisdictions</b> class to the <b>ValueStrategyCoverageType</b> class.</p> |
| <p>type</p>       | <p><a href="#">ValueStrategyCoverageType</a></p>   |
| <p>properties</p> | <p>isRef 0<br/>minOcc 0<br/>maxOcc 1<br/>content complex</p>   |
| <p>children</p>   | <p><a href="#">Value</a> <a href="#">ConsideredInInvestmentStrategy</a> <a href="#">Coverage</a> <a href="#">EligibleAssets</a></p>  |
| <p>annotation</p> | <p>documentation<br/>Non_Cooperative_Tax_Jurisdictions (33330 - 33360)</p>   |

element

**EETReportType/PrincipalAdverseIndicators/MoreSocialAndEmployeeMatters/SovereignAndSupranationalInvestments/AveragePoliticalStabilityScore**

|                   |  |
|-------------------|--|
| <p>diagram</p>    | <pre> classDiagram     class AveragePoliticalStabilityScore {         Average_Political_Stability_Score (33370 - 33400)     }     class ValueStrategyCoverageType {         Value         ConsideredInInvestmentStrategy         Coverage         EligibleAssets     }     AveragePoliticalStabilityScore -- ValueStrategyCoverageType         </pre> <p>The diagram illustrates the relationship between the <b>AveragePoliticalStabilityScore</b> and the <b>ValueStrategyCoverageType</b>. The <b>AveragePoliticalStabilityScore</b> is represented by a dashed box containing the text "Average_Political_Stability_Score (33370 - 33400)". It is connected to the <b>ValueStrategyCoverageType</b> class, which is enclosed in a yellow dashed box. The <b>ValueStrategyCoverageType</b> class has four attributes: <b>Value</b> (Number of units in product currency), <b>ConsideredInInvestmentStrategy</b> (Yes (= commitment of the asset manager to improve the PAI), No), <b>Coverage</b> (% of the notional / AUM, which provide effectively data, or where data could be estimated), and <b>EligibleAssets</b> (% of assets (versus notional / AUM), which could provide data).</p> |
| <p>type</p>       | <p><a href="#">ValueStrategyCoverageType</a></p>   |
| <p>properties</p> | <p>isRef 0<br/>minOcc 0<br/>maxOcc 1<br/>content complex</p>   |
| <p>children</p>   | <p><a href="#">Value</a> <a href="#">ConsideredInInvestmentStrategy</a> <a href="#">Coverage</a> <a href="#">EligibleAssets</a></p>  |
| <p>annotation</p> | <p>documentation<br/>Average_Political_Stability_Score (33370 - 33400)</p>   |

element

**EETReportType/PrincipalAdverseIndicators/MoreSocialAndEmployeeMatters/SovereignAndSupranationalInvestments/AverageRuleOfLawScore**

|                   |  |
|-------------------|--|
| <p>diagram</p>    | <pre> classDiagram     class AverageRuleOfLawScore {         Average_Rule_Of_Law_Score (33410 - 33440)     }     class ValueStrategyCoverageType {         Value         ConsideredInInvestmentStrategy         Coverage         EligibleAssets     }     AverageRuleOfLawScore -- ValueStrategyCoverageType     </pre> <p>The diagram illustrates the structure of the <b>AverageRuleOfLawScore</b> element. It is associated with the <b>ValueStrategyCoverageType</b> container. The <b>ValueStrategyCoverageType</b> contains four sub-elements: <b>Value</b> (Number of units in product currency), <b>ConsideredInInvestmentStrategy</b> (Yes (= commitment of the asset manager to improve the PAI), No), <b>Coverage</b> (% of the notional / AUM, which provide effectively data, or where data could be estimated), and <b>EligibleAssets</b> (% of assets (versus notional / AUM), which could provide data).</p> |
| <p>type</p>       | <p><a href="#">ValueStrategyCoverageType</a></p>   |
| <p>properties</p> | <p>isRef 0<br/>minOcc 0<br/>maxOcc 1<br/>content complex</p>   |
| <p>children</p>   | <p><a href="#">Value</a> <a href="#">ConsideredInInvestmentStrategy</a> <a href="#">Coverage</a> <a href="#">EligibleAssets</a></p>  |
| <p>annotation</p> | <p>documentation<br/>Average_Rule_Of_Law_Score (33410 - 33440)</p>   |

element **EETReportType/ScreeningCriteria**

|            |   |
|------------|---|
| diagram    |   |
| properties | isRef 0<br>minOcc 0<br>maxOcc 1<br>content complex  |
| children   | <a href="#">ExistingNegativeScreeningStrategy</a> <a href="#">LinkToExclusionPolicyAndCriteria</a> <a href="#">SectorsBasedExclusions</a> <a href="#">NormBasedExclusions</a> <a href="#">SovereignLevelExclusions</a> <a href="#">RealEstateExclusions</a> |
| annotation | documentation<br>40000 - 54070  |

element **EETReportType/ScreeningCriteria/ExistingNegativeScreeningStrategy**

|            |  |
|------------|--|
| diagram    |  |
| type       | <a href="#">EETYesNoType</a>   |
| properties | isRef 0<br>content simple  |
| facets     | Kind Value annotation<br>length 1  |
| annotation | documentation<br>40000_Financial_Instrument_Existing_Negative_Screening_Strategy |

element **EETReportType/ScreeningCriteria/LinkToExclusionPolicyAndCriteria**

|            |                     |
|------------|---------------------|
| diagram    |                     |
| type       | <b>xs:anyURI</b>    |
| properties | isRef 0<br>minOcc 0 |



|            |   |
|------------|---|
|            | maxOcc 1<br>content simple  |
| annotation | documentation<br>40010_Financial_Instrument_Link_To_Exclusion_Policy_And_Criteria |

element **EETReportType/ScreeningCriteria/SectorsBasedExclusions**

diagram



|            |   |
|------------|---|
| properties | isRef 0<br>minOcc 0<br>maxOcc 1<br>content complex  |
| children   | <a href="#">PornographyAdultEntertainmentServicesExclusion</a> <a href="#">AlcoholExclusion</a> <a href="#">AnimalTestingExclusion</a> <a href="#">CannabisExclusion</a> <a href="#">ConventionalWeaponsExclusion</a> <a href="#">CoalExclusion</a> <a href="#">FactoryFarmingExclusion</a> <a href="#">FurExclusion</a> <a href="#">GamblingExclusion</a> <a href="#">GasExclusion</a> <a href="#">GeneticEngineeringExclusion</a> <a href="#">GeneticallyModifiedOrganismsExclusion</a> <a href="#">NuclearEnergyExclusion</a> <a href="#">NuclearWeaponsExclusion</a> <a href="#">OilExclusion</a> <a href="#">OtherFossilFuelExclusion</a> <a href="#">PalmOilExclusion</a> <a href="#">PesticidesExclusion</a> <a href="#">ResearchOnHumanEmbryosExclusion</a> <a href="#">TobaccoExclusion</a> <a href="#">UnconventionalWeaponsExclusion</a> |
| annotation | documentation<br>50100 - 52130  |

element

**EETReportType/ScreeningCriteria/SectorsBasedExclusions/PornographyAdultEntertainmentServicesExclusion**

|            |  |
|------------|--|
| diagram    | <p>The diagram shows a class <b>PornographyAdultEntertainment...</b> (ID: 50100 - 50130) associated with the <b>EETExclusionType</b> class. The <b>EETExclusionType</b> class has the following attributes:</p> <ul style="list-style-type: none"> <li><b>Applied</b>: Yes (Y) or No (N)</li> <li><b>ThresholdType</b>: Revenue (R) or CaPEX (C) or Opex (O)</li> <li><b>RelativeThreshold</b></li> <li><b>PartOfValueChain</b>: Upstream/Production/Downstream</li> </ul> |
| type       | <a href="#">EETExclusionType</a>   |
| properties | isRef 0<br>minOcc 0<br>maxOcc 1<br>content complex   |
| children   | <a href="#">Applied</a> <a href="#">ThresholdType</a> <a href="#">RelativeThreshold</a> <a href="#">PartOfValueChain</a>   |
| annotation | documentation<br>50100 - 50130   |

element **EETReportType/ScreeningCriteria/SectorsBasedExclusions/AlcoholExclusion**

|            |  |
|------------|--|
| diagram    |  |
| type       | <a href="#">EETExclusionType</a>   |
| properties | isRef 0<br>minOcc 0<br>maxOcc 1<br>content complex   |
| children   | <a href="#">Applied</a> <a href="#">ThresholdType</a> <a href="#">RelativeThreshold</a> <a href="#">PartOfValueChain</a> |
| annotation | documentation<br>50200 - 50230   |

element **EETReportType/ScreeningCriteria/SectorsBasedExclusions/AnimalTestingExclusion**

|            |  |
|------------|--|
| diagram    |  |
| type       | <a href="#">EETExclusionType</a>   |
| properties | isRef 0<br>minOcc 0<br>maxOcc 1<br>content complex   |
| children   | <a href="#">Applied</a> <a href="#">ThresholdType</a> <a href="#">RelativeThreshold</a> <a href="#">PartOfValueChain</a> |
| annotation | documentation<br>50300 - 50330   |

element **EETReportType/ScreeningCriteria/SectorsBasedExclusions/CannabisExclusion**

|            |  |
|------------|--|
| diagram    |  |
| type       | <a href="#">EETExclusionType</a>   |
| properties | <p>isRef 0<br/> minOcc 0<br/> maxOcc 1<br/> content complex</p>  |
| children   | <a href="#">Applied</a> <a href="#">ThresholdType</a> <a href="#">RelativeThreshold</a> <a href="#">PartOfValueChain</a> |
| annotation | documentation<br>50400 - 50430   |

element **EETReportType/ScreeningCriteria/SectorsBasedExclusions/ConventionalWeaponsExclusion**

|            |  |
|------------|--|
| diagram    |  |
| type       | <a href="#">EETExclusionType</a>   |
| properties | <p>isRef 0<br/> minOcc 0<br/> maxOcc 1<br/> content complex</p>  |
| children   | <a href="#">Applied</a> <a href="#">ThresholdType</a> <a href="#">RelativeThreshold</a> <a href="#">PartOfValueChain</a> |
| annotation | documentation<br>50500 - 50530   |

element **EETReportType/ScreeningCriteria/SectorsBasedExclusions/CoalExclusion**

|                   |   |
|-------------------|---|
| <p>diagram</p>    | <p>The diagram illustrates the structure of the <b>CoalExclusion</b> element. It is a specialization of the <b>EETEnhancedExclusionType</b>. The <b>EETEnhancedExclusionType</b> class includes the following attributes:</p> <ul style="list-style-type: none"> <li><b>Applied</b>: Yes (Y) or No (N)</li> <li><b>ThresholdType</b>: Revenue (R) or CaPEX (C) or Opex (O)</li> <li><b>RelativeThreshold</b></li> <li><b>PartOfValueChain</b>: Upstream/Production/Downs tream</li> <li><b>EnergyMixAbsoluteCap</b></li> <li><b>EnergyMixRelativeCap</b></li> <li><b>NewInfrastructure</b>: Yes (Y) or No (N)</li> </ul> <p>The <b>CoalExclusion</b> class (with ID 50600 - 50660) inherits from <b>EETEnhancedExclusionType</b>.</p> |
| <p>type</p>       | <p><a href="#">EETEnhancedExclusionType</a></p>   |
| <p>properties</p> | <p>isRef 0<br/>minOcc 0<br/>maxOcc 1<br/>content complex</p>  |
| <p>children</p>   | <p><a href="#">Applied</a> <a href="#">ThresholdType</a> <a href="#">RelativeThreshold</a> <a href="#">PartOfValueChain</a> <a href="#">EnergyMixAbsoluteCap</a> <a href="#">EnergyMixRelativeCap</a> <a href="#">NewInfrastructure</a></p>   |
| <p>annotation</p> | <p>documentation<br/>50600 - 50660</p>  |

element **EETReportType/ScreeningCriteria/SectorsBasedExclusions/FactoryFarmingExclusion**

|            |   |
|------------|---|
| diagram    | <p>The diagram illustrates the structure of the <b>FactoryFarmingExclusion</b> element. It is a dashed box containing the text "FactoryFarmingExclusion" and the range "50700 - 50730". A line connects this box to a central octagonal connector. From this connector, a line leads to a larger dashed box labeled "EETExclusionType". Inside this box, four sub-elements are listed: "Applied" (Yes (Y) or No (N)), "ThresholdType" (Revenue (R) or CaPEX (C) or Opex (O)), "RelativeThreshold", and "PartOfValueChain" (Upstream/Production/Downstream).</p> |
| type       | <a href="#">EETExclusionType</a>  |
| properties | isRef 0<br>minOcc 0<br>maxOcc 1<br>content complex  |
| children   | <a href="#">Applied</a> <a href="#">ThresholdType</a> <a href="#">RelativeThreshold</a> <a href="#">PartOfValueChain</a>  |
| annotation | documentation<br>50700 - 50730  |

element **EETReportType/ScreeningCriteria/SectorsBasedExclusions/FurExclusion**

|            |   |
|------------|---|
| diagram    | <p>The diagram illustrates the structure of the <b>FurExclusion</b> element. It is a dashed box containing the text "FurExclusion" and the range "50800 - 50830". A line connects this box to a central octagonal connector. From this connector, a line leads to a larger dashed box labeled "EETExclusionType". Inside this box, four sub-elements are listed: "Applied" (Yes (Y) or No (N)), "ThresholdType" (Revenue (R) or CaPEX (C) or Opex (O)), "RelativeThreshold", and "PartOfValueChain" (Upstream/Production/Downstream).</p> |
| type       | <a href="#">EETExclusionType</a>  |
| properties | isRef 0<br>minOcc 0<br>maxOcc 1<br>content complex  |
| children   | <a href="#">Applied</a> <a href="#">ThresholdType</a> <a href="#">RelativeThreshold</a> <a href="#">PartOfValueChain</a>  |
| annotation | documentation<br>50800 - 50830  |



element **EETReportType/ScreeningCriteria/SectorsBasedExclusions/GamblingExclusion**

|            |  |
|------------|--|
| diagram    |  |
| type       | <a href="#">EETExclusionType</a>   |
| properties | <p>isRef 0<br/> minOcc 0<br/> maxOcc 1<br/> content complex</p>  |
| children   | <a href="#">Applied</a> <a href="#">ThresholdType</a> <a href="#">RelativeThreshold</a> <a href="#">PartOfValueChain</a> |
| annotation | <p>documentation<br/> 50900 - 50930</p>  |

element **EETReportType/ScreeningCriteria/SectorsBasedExclusions/GasExclusion**

|            |  |
|------------|--|
| diagram    |  |
| type       | <a href="#">EETEnhancedExclusionType</a>   |
| properties | <p>isRef 0<br/> minOcc 0<br/> maxOcc 1<br/> content complex</p>  |
| children   | <a href="#">Applied</a> <a href="#">ThresholdType</a> <a href="#">RelativeThreshold</a> <a href="#">PartOfValueChain</a> <a href="#">EnergyMixAbsoluteCap</a> <a href="#">EnergyMixRelativeCap</a> <a href="#">NewInfrastructure</a> |
| annotation | <p>documentation<br/> 51000 - 51060</p>  |

|            |  |
|------------|--|
| type       | <a href="#">EETEnhancedExclusionType</a>   |
| properties | isRef 0<br>minOcc 0<br>maxOcc 1<br>content complex   |
| children   | <a href="#">Applied</a> <a href="#">ThresholdType</a> <a href="#">RelativeThreshold</a> <a href="#">PartOfValueChain</a> <a href="#">EnergyMixAbsoluteCap</a> <a href="#">EnergyMixRelativeCap</a> <a href="#">NewInfrastructure</a> |
| annotation | documentation<br>51000 - 51060   |

element **EETReportType/ScreeningCriteria/SectorsBasedExclusions/GeneticEngineeringExclusion**

|            |   |
|------------|---|
| diagram    | <p>The diagram illustrates the class hierarchy for Genetic Engineering Exclusion. GeneticEngineeringExclusion (ID: 51100 - 51130) is a specialization of EETExclusionType. EETExclusionType is a base class with four subclasses: Applied (Yes (Y) or No (N)), ThresholdType (Revenue (R) or CaPEX (C) or Opex (O)), RelativeThreshold, and PartOfValueChain (Upstream/Production/Downs tream).</p> |
| type       | <a href="#">EETExclusionType</a>  |
| properties | isRef 0<br>minOcc 0<br>maxOcc 1<br>content complex  |
| children   | <a href="#">Applied</a> <a href="#">ThresholdType</a> <a href="#">RelativeThreshold</a> <a href="#">PartOfValueChain</a>  |
| annotation | documentation<br>51100 - 51130  |

element

**EETReportType/ScreeningCriteria/SectorsBasedExclusions/GeneticallyModifiedOrganismsExclusion**

|            |  |
|------------|--|
| diagram    |  |
| type       | <a href="#">EETExclusionType</a>   |
| properties | isRef 0<br>minOcc 0<br>maxOcc 1<br>content complex   |
| children   | <a href="#">Applied</a> <a href="#">ThresholdType</a> <a href="#">RelativeThreshold</a> <a href="#">PartOfValueChain</a> |
| annotation | documentation<br>51200 - 51230   |

element **EETReportType/ScreeningCriteria/SectorsBasedExclusions/NuclearEnergyExclusion**

|            |  |
|------------|--|
| diagram    |  |
| type       | <a href="#">EETExclusionType</a>   |
| properties | isRef 0<br>minOcc 0<br>maxOcc 1<br>content complex   |
| children   | <a href="#">Applied</a> <a href="#">ThresholdType</a> <a href="#">RelativeThreshold</a> <a href="#">PartOfValueChain</a> |
| annotation | documentation<br>51300 - 51330   |

element **EETReportType/ScreeningCriteria/SectorsBasedExclusions/NuclearWeaponsExclusion**

|                   |   |
|-------------------|---|
| <p>diagram</p>    |   |
| <p>type</p>       | <p><a href="#">EETExclusionType</a></p>   |
| <p>properties</p> | <p>isRef 0<br/>minOcc 0<br/>maxOcc 1<br/>content complex</p>  |
| <p>children</p>   | <p><a href="#">Applied</a> <a href="#">ThresholdType</a> <a href="#">RelativeThreshold</a> <a href="#">PartOfValueChain</a></p> |
| <p>annotation</p> | <p>documentation<br/>51400 - 51430</p>  |

element **EETReportType/ScreeningCriteria/SectorsBasedExclusions/OilExclusion**

|                |  |
|----------------|--|
| <p>diagram</p> |  |
|----------------|--|

|            |  |
|------------|--|
| type       | <a href="#">EETEnhancedExclusionType</a>   |
| properties | isRef 0<br>minOcc 0<br>maxOcc 1<br>content complex   |
| children   | <a href="#">Applied</a> <a href="#">ThresholdType</a> <a href="#">RelativeThreshold</a> <a href="#">PartOfValueChain</a> <a href="#">EnergyMixAbsoluteCap</a> <a href="#">EnergyMixRelativeCap</a> <a href="#">NewInfrastructure</a> |
| annotation | documentation<br>51500 - 51560   |

element [EETReportType/ScreeningCriteria/SectorsBasedExclusions/OtherFossilFuelExclusion](#)

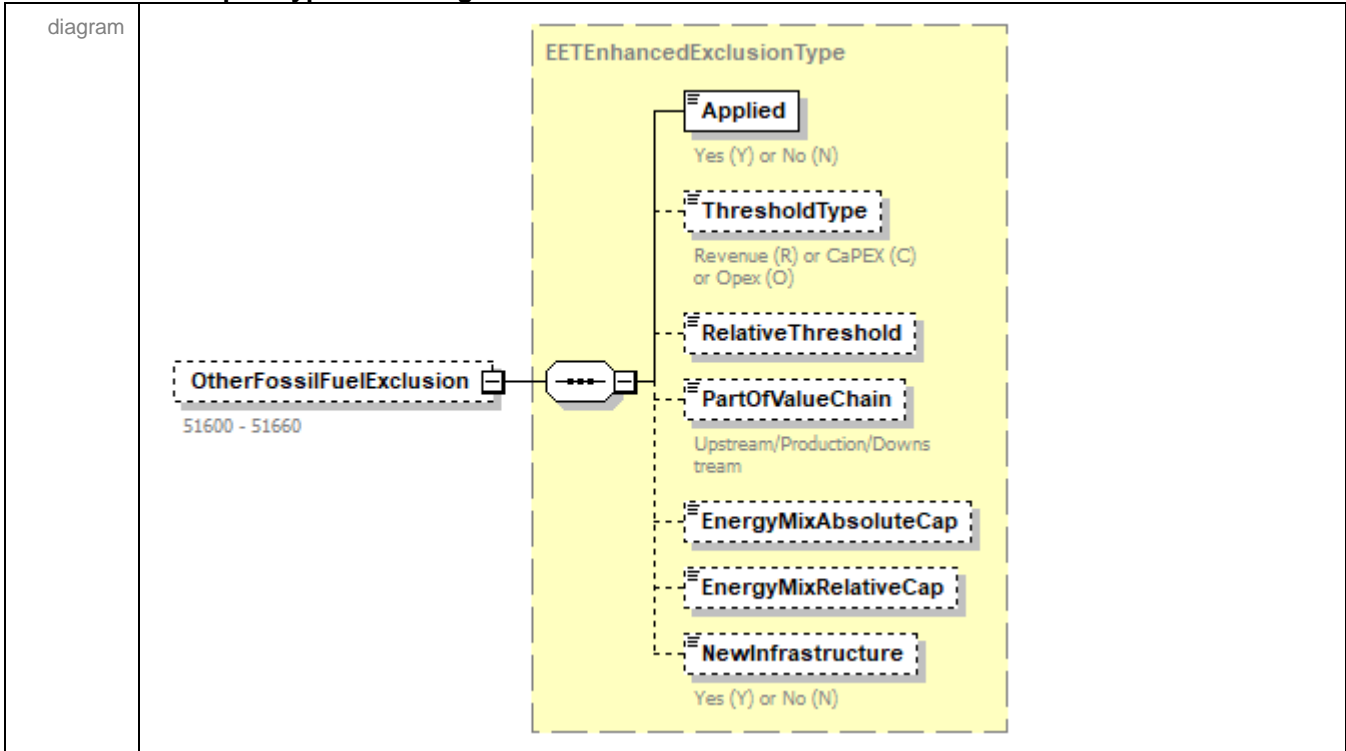

|            |  |
|------------|--|
| type       | <a href="#">EETEnhancedExclusionType</a>   |
| properties | isRef 0<br>minOcc 0<br>maxOcc 1<br>content complex   |
| children   | <a href="#">Applied</a> <a href="#">ThresholdType</a> <a href="#">RelativeThreshold</a> <a href="#">PartOfValueChain</a> <a href="#">EnergyMixAbsoluteCap</a> <a href="#">EnergyMixRelativeCap</a> <a href="#">NewInfrastructure</a> |
| annotation | documentation<br>51600 - 51660   |

element **EETReportType/ScreeningCriteria/SectorsBasedExclusions/PalmOilExclusion**

|            |   |
|------------|---|
| diagram    | <p>The diagram illustrates the structure of the <b>PalmOilExclusion</b> element. It is a dashed box containing the text <b>PalmOilExclusion</b> and the range <b>51700 - 51730</b>. A line connects it to a central hexagonal connector, which in turn connects to a larger dashed box labeled <b>EETExclusionType</b>. This box contains four sub-elements: <b>Applied</b> (Yes (Y) or No (N)), <b>ThresholdType</b> (Revenue (R) or CaPEX (C) or Opex (O)), <b>RelativeThreshold</b>, and <b>PartOfValueChain</b> (Upstream/Production/Downstream).</p> |
| type       | <a href="#">EETExclusionType</a>  |
| properties | <ul style="list-style-type: none"> <li>isRef 0</li> <li>minOcc 0</li> <li>maxOcc 1</li> <li>content complex</li> </ul>  |
| children   | <a href="#">Applied</a> <a href="#">ThresholdType</a> <a href="#">RelativeThreshold</a> <a href="#">PartOfValueChain</a>  |
| annotation | documentation<br>51700 - 51730  |

element **EETReportType/ScreeningCriteria/SectorsBasedExclusions/PesticidesExclusion**

|            |   |
|------------|---|
| diagram    | <p>The diagram illustrates the structure of the <b>PesticidesExclusion</b> element. It is a dashed box containing the text <b>PesticidesExclusion</b> and the range <b>51800 - 51830</b>. A line connects it to a central hexagonal connector, which in turn connects to a larger dashed box labeled <b>EETExclusionType</b>. This box contains four sub-elements: <b>Applied</b> (Yes (Y) or No (N)), <b>ThresholdType</b> (Revenue (R) or CaPEX (C) or Opex (O)), <b>RelativeThreshold</b>, and <b>PartOfValueChain</b> (Upstream/Production/Downstream).</p> |
| type       | <a href="#">EETExclusionType</a>  |
| properties | <ul style="list-style-type: none"> <li>isRef 0</li> <li>minOcc 0</li> <li>maxOcc 1</li> <li>content complex</li> </ul>  |
| children   | <a href="#">Applied</a> <a href="#">ThresholdType</a> <a href="#">RelativeThreshold</a> <a href="#">PartOfValueChain</a>  |
| annotation | documentation<br>51800 - 51830  |

element

**EETReportType/ScreeningCriteria/SectorsBasedExclusions/ResearchOnHumanEmbryosExclusion**

|            |  |
|------------|--|
| diagram    |  |
| type       | <a href="#">EETExclusionType</a>   |
| properties | <p>isRef 0<br/> minOcc 0<br/> maxOcc 1<br/> content complex</p>  |
| children   | <a href="#">Applied</a> <a href="#">ThresholdType</a> <a href="#">RelativeThreshold</a> <a href="#">PartOfValueChain</a> |
| annotation | <p>documentation<br/> 51900 - 51930</p>  |

element **EETReportType/ScreeningCriteria/SectorsBasedExclusions/TobaccoExclusion**

|            |  |
|------------|--|
| diagram    |  |
| type       | <a href="#">EETExclusionType</a>   |
| properties | <p>isRef 0<br/> minOcc 0<br/> maxOcc 1<br/> content complex</p>  |
| children   | <a href="#">Applied</a> <a href="#">ThresholdType</a> <a href="#">RelativeThreshold</a> <a href="#">PartOfValueChain</a> |
| annotation | <p>documentation<br/> 52000 - 52030</p>  |

element **EETReportType/ScreeningCriteria/SectorsBasedExclusions/UnconventionalWeaponsExclusion**

|            |  |
|------------|--|
| diagram    |  |
| type       | <a href="#">EETExclusionType</a>   |
| properties | isRef 0<br>minOcc 0<br>maxOcc 1<br>content complex   |
| children   | <a href="#">Applied</a> <a href="#">ThresholdType</a> <a href="#">RelativeThreshold</a> <a href="#">PartOfValueChain</a> |
| annotation | documentation<br>52100 - 52130   |

element **EETReportType/ScreeningCriteria/NormBasedExclusions**

|            |  |
|------------|--|
| diagram    |  |
| properties | isRef 0<br>minOcc 0<br>maxOcc 1<br>content complex   |
| children   | <a href="#">UNGC_Exclusion</a> <a href="#">OECD_Guidelines_Exclusion</a> <a href="#">ILO_Exclusion</a> |
| annotation | documentation<br>52200 - 52220   |

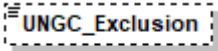

element **EETReportType/ScreeningCriteria/NormBasedExclusions/UNGC\_Exclusion**

|            |  |
|------------|--|
| diagram    | <br>52200_Financial_Instrument<br>_UNGC_Exclusion |
| type       | <a href="#">EETYesNoType</a>   |
| properties | isRef 0<br>minOcc 0<br>maxOcc 1<br>content simple  |
| facets     | Kind Value annotation<br>length 1  |
| annotation | documentation<br>52200_Financial_Instrument_UNGC_Exclusion   |

element **EETReportType/ScreeningCriteria/NormBasedExclusions/OECD\_Guidelines\_Exclusion**

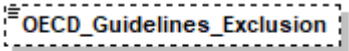
|            |   |
|------------|---|
| diagram    | <br>52210_Financial_Instrument_OECD_G<br>uidelines_Exclusion |
| type       | <a href="#">EETYesNoType</a>  |
| properties | isRef 0<br>minOcc 0<br>maxOcc 1<br>content simple   |
| facets     | Kind Value annotation<br>length 1   |
| annotation | documentation<br>52210_Financial_Instrument_OECD_Guidelines_Exclusion   |

element **EETReportType/ScreeningCriteria/NormBasedExclusions/ILO\_Exclusion**

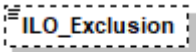
|            |   |
|------------|---|
| diagram    | <br>52220_Financial_Instrument<br>_ILO_Exclusion |
| type       | <a href="#">EETYesNoType</a>  |
| properties | isRef 0<br>minOcc 0<br>maxOcc 1<br>content simple   |
| facets     | Kind Value annotation<br>length 1   |
| annotation | documentation<br>52220_Financial_Instrument_ILO_Exclusion   |

element **EETReportType/ScreeningCriteria/SovereignLevelExclusions**

|            |  |
|------------|--|
| diagram    | <p>The diagram shows a central box for <b>SovereignLevelExclusions</b> (53000 - 53060) connected to seven sub-exclusions:</p> <ul style="list-style-type: none"> <li><b>NuclearWeaponsExclusion</b> (53000_Financial_Instrument_Nuclear_Weapons_Exclusion)</li> <li><b>NonProliferationTreatyOfNuclear...</b> (53010_Financial_Instrument_Non-proliferation_Treaty_Of_Nuclear_Weapons)</li> <li><b>QualitativeExclusionOfCountries</b> (53020_Financial_Instrument_Qualitative_Exc_lusion_Of_Countries: A - Freedomhouse, I - Internal method, N - None)</li> <li><b>CorruptionExclusion</b> (53030_Financial_Instrument_Corruption_Exclusion)</li> <li><b>DeathSentenceExclusion</b> (53040_Financial_Instrument_Death_Sentence_Exclusion)</li> <li><b>WarExclusion</b> (53050_Financial_Instrument_War_Exclusion)</li> <li><b>NonRatificationOfParisAgreeme...</b> (53060_Financial_Instrument_Non_Ratification_Of_Paris_Agreement_Exclusion)</li> </ul> |
| properties | <p>isRef 0<br/> minOcc 0<br/> maxOcc 1<br/> content complex</p>  |
| children   | <p><a href="#">NuclearWeaponsExclusion</a> <a href="#">NonProliferationTreatyOfNuclearWeapons</a> <a href="#">QualitativeExclusionOfCountries</a> <a href="#">CorruptionExclusion</a> <a href="#">DeathSentenceExclusion</a> <a href="#">WarExclusion</a> <a href="#">NonRatificationOfParisAgreementExclusion</a></p>   |
| annotation | <p>documentation<br/> 53000 - 53060</p>  |

element **EETReportType/ScreeningCriteria/SovereignLevelExclusions/NuclearWeaponsExclusion**

|            |  |
|------------|--|
| diagram    | <p>The diagram shows a single box for <b>NuclearWeaponsExclusion</b> (53000_Financial_Instrument_Nuclear_Weapons_Exclusion).</p> |
| type       | <p><a href="#">EETYesNoType</a></p>  |
| properties | <p>isRef 0<br/> minOcc 0<br/> maxOcc 1<br/> content simple</p>   |
| facets     | <p>Kind Value annotation<br/> length 1</p>   |
| annotation | <p>documentation<br/> 53000_Financial_Instrument_Nuclear_Weapons_Exclusion</p>   |

element

**EETReportType/ScreeningCriteria/SovereignLevelExclusions/NonProliferationTreatyOfNuclearWeapons**

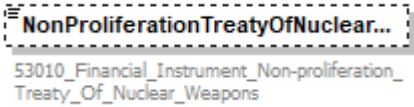
|            |   |
|------------|---|
| diagram    |  <p>53010_Financial_Instrument_Non-proliferation_Treaty_Of_Nuclear_Weapons</p> |
| type       | <a href="#">EETYesNoType</a>  |
| properties | isRef 0<br>minOcc 0<br>maxOcc 1<br>content simple   |
| facets     | Kind Value annotation<br>length 1   |
| annotation | documentation<br>53010_Financial_Instrument_Non-proliferation_Treaty_Of_Nuclear_Weapons   |

element **EETReportType/ScreeningCriteria/SovereignLevelExclusions/QualitativeExclusionOfCountries**

|            |   |
|------------|---|
| diagram    |  <p>53020_Financial_Instrument_Qualitative_Exclusion_Of_Countries:<br/>A- Freedomhouse<br/>I - Internal method<br/>N - None</p> |
| type       | restriction of <b>xs:string</b>   |
| properties | isRef 0<br>minOcc 0<br>maxOcc 1<br>content simple   |
| annotation | documentation<br>53020_Financial_Instrument_Qualitative_Exclusion_Of_Countries:<br>A- Freedomhouse<br>I - Internal method<br>N - None   |

element **EETReportType/ScreeningCriteria/SovereignLevelExclusions/CorruptionExclusion**

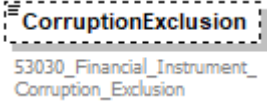
|            |  |
|------------|--|
| diagram    |  <p>53030_Financial_Instrument_Corruption_Exclusion</p> |
| type       | <a href="#">EETYesNoType</a>   |
| properties | isRef 0<br>minOcc 0<br>maxOcc 1<br>content simple  |
| facets     | Kind Value annotation<br>length 1  |
| annotation | documentation<br>53030_Financial_Instrument_Corruption_Exclusion   |

element **EETReportType/ScreeningCriteria/SovereignLevelExclusions/DeathSentenceExclusion**

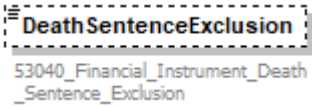
|            |  |
|------------|--|
| diagram    |  <p><b>DeathSentenceExclusion</b><br/>53040_Financial_Instrument_Death_Sentence_Exclusion</p> |
| type       | <a href="#">EETYesNoType</a>   |
| properties | isRef 0<br>minOcc 0<br>maxOcc 1<br>content simple  |
| facets     | Kind Value annotation<br>length 1  |
| annotation | documentation<br>53040_Financial_Instrument_Death_Sentence_Exclusion   |

element **EETReportType/ScreeningCriteria/SovereignLevelExclusions/WarExclusion**

|            |   |
|------------|---|
| diagram    |  <p><b>WarExclusion</b><br/>53050_Financial_Instrument_War_Exclusion</p> |
| type       | <a href="#">EETYesNoType</a>  |
| properties | isRef 0<br>minOcc 0<br>maxOcc 1<br>content simple   |
| facets     | Kind Value annotation<br>length 1   |
| annotation | documentation<br>53050_Financial_Instrument_War_Exclusion   |

element **EETReportType/ScreeningCriteria/SovereignLevelExclusions/NonRatificationOfParisAgreementExclusion**

|            |   |
|------------|---|
| diagram    |  <p><b>NonRatificationOfParisAgreeme...</b><br/>53060_Financial_Instrument_Non_Ratification_Of_Paris_Agreement_Exclusion</p> |
| type       | <a href="#">EETYesNoType</a>  |
| properties | isRef 0<br>minOcc 0<br>maxOcc 1<br>content simple   |
| facets     | Kind Value annotation<br>length 1   |
| annotation | documentation<br>53060_Financial_Instrument_Non_Ratification_Of_Paris_Agreement_Exclusion   |

element **EETReportType/ScreeningCriteria/RealEstateExclusions**

|                   |   |
|-------------------|---|
| <p>diagram</p>    | <p>The diagram shows a central box for <b>RealEstateExclusions</b> (ID: 54000 - 54070) connected to seven other boxes, each representing a monitoring criterion. The connections are as follows:</p> <ul style="list-style-type: none"> <li><b>EnergyConsumptionMonitoring</b> (54000_Financial_Instrument_ESG_Energy_Consumption_Monitoring)</li> <li><b>GreenhouseGasEmissionMonitoring</b> (54010_Financial_Instrument_ESG_GHG_Emission_Monitoring)</li> <li><b>WaterConsumptionMonitoring</b> (54020_Financial_Instrument_ESG_Water_Consumption_Monitoring)</li> <li><b>WasteFinancialInstrumentationMonitoring</b> (54030_Financial_Instrument_ESG_Waste_Financial_Instrumentation_Monitoring)</li> <li><b>EnvironmentalHealthMonitoring</b> (54040_Financial_Instrument_ESG_Environmental_Health_Monitoring)</li> <li><b>SupplierMonitoring</b> (54050_Financial_Instrument_ESG_Supplier_Monitoring)</li> <li><b>SafetyMonitoring</b> (54060_Financial_Instrument_ESG_Safety_Monitoring)</li> <li><b>BiodiversityMonitoring</b> (54070_Financial_Instrument_ESG_Biodiversity_Monitoring)</li> </ul> |
| <p>properties</p> | <p>isRef 0<br/>minOcc 0<br/>maxOcc 1<br/>content complex</p>  |
| <p>children</p>   | <p><a href="#">EnergyConsumptionMonitoring</a> <a href="#">GreenhouseGasEmissionMonitoring</a> <a href="#">WaterConsumptionMonitoring</a> <a href="#">WasteFinancialInstrumentationMonitoring</a> <a href="#">EnvironmentalHealthMonitoring</a> <a href="#">SupplierMonitoring</a> <a href="#">SafetyMonitoring</a> <a href="#">BiodiversityMonitoring</a></p>  |
| <p>annotation</p> | <p>documentation<br/>54000 - 54070</p>  |

element **EETReportType/ScreeningCriteria/RealEstateExclusions/EnergyConsumptionMonitoring**

|                   |  |
|-------------------|--|
| <p>diagram</p>    | <p>The diagram shows a single box for <b>EnergyConsumptionMonitoring</b> (ID: 54000_Financial_Instrument_ESG_Energy_Consumption_Monitoring).</p> |
| <p>type</p>       | <p><a href="#">EETYesNoType</a></p>  |
| <p>properties</p> | <p>isRef 0<br/>minOcc 0<br/>maxOcc 1<br/>content simple</p>  |
| <p>facets</p>     | <p>Kind Value annotation<br/>length 1</p>  |

|            |   |
|------------|---|
| annotation | documentation<br>54000_Financial_Instrument_ESG_Energy_Consumption_Monitoring |
|------------|---|

element **EETReportType/ScreeningCriteria/RealEstateExclusions/GreenhouseGasEmissionMonitoring**

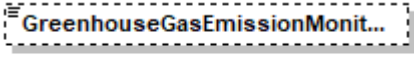
|            |   |
|------------|---|
| diagram    |  <p><b>GreenhouseGasEmissionMonit...</b><br/>54010_Financial_Instrument_ESG_GHG_Emissi<br/>on_Monitoring</p> |
| type       | <a href="#">EETYesNoType</a>  |
| properties | isRef 0<br>minOcc 0<br>maxOcc 1<br>content simple   |
| facets     | Kind Value annotation<br>length 1   |
| annotation | documentation<br>54010_Financial_Instrument_ESG_GHG_Emission_Monitoring   |

element **EETReportType/ScreeningCriteria/RealEstateExclusions/WaterConsumptionMonitoring**

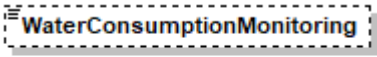
|            |   |
|------------|---|
| diagram    |  <p><b>WaterConsumptionMonitoring</b><br/>54020_Financial_Instrument_ESG_Water_<br/>Consumption_Monitoring</p> |
| type       | <a href="#">EETYesNoType</a>  |
| properties | isRef 0<br>minOcc 0<br>maxOcc 1<br>content simple   |
| facets     | Kind Value annotation<br>length 1   |
| annotation | documentation<br>54020_Financial_Instrument_ESG_Water_Consumption_Monitoring  |

element **EETReportType/ScreeningCriteria/RealEstateExclusions/WasteFinancialInstrumentationMonitoring**

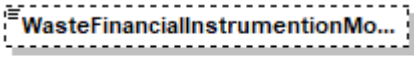
|            |   |
|------------|---|
| diagram    |  <p><b>WasteFinancialInstrumentationMo...</b><br/>54030_Financial_Instrument_ESG_Waste_Fina<br/>ncial_Instrumentation_Monitoring</p> |
| type       | <a href="#">EETYesNoType</a>  |
| properties | isRef 0<br>minOcc 0<br>maxOcc 1<br>content simple   |
| facets     | Kind Value annotation<br>length 1   |
| annotation | documentation<br>54030_Financial_Instrument_ESG_Waste_Financial_Instrumentation_Monitoring  |

element **EETReportType/ScreeningCriteria/RealEstateExclusions/EnvironmentalHealthMonitoring**

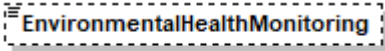
|            |  |
|------------|--|
| diagram    |  <p><b>EnvironmentalHealthMonitoring</b><br/>54040_Financial_Instrument_ESG_Environmental_Health_Monitoring</p> |
| type       | <a href="#">EETYesNoType</a>   |
| properties | isRef 0<br>minOcc 0<br>maxOcc 1<br>content simple  |
| facets     | Kind Value annotation<br>length 1  |
| annotation | documentation<br>54040_Financial_Instrument_ESG_Environmental_Health_Monitoring  |

element **EETReportType/ScreeningCriteria/RealEstateExclusions/SupplierMonitoring**

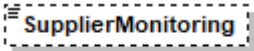
|            |   |
|------------|---|
| diagram    |  <p><b>SupplierMonitoring</b><br/>54050_Financial_Instrument_ESG_Supplier_Monitoring</p> |
| type       | <a href="#">EETYesNoType</a>  |
| properties | isRef 0<br>minOcc 0<br>maxOcc 1<br>content simple   |
| facets     | Kind Value annotation<br>length 1   |
| annotation | documentation<br>54050_Financial_Instrument_ESG_Supplier_Monitoring   |

element **EETReportType/ScreeningCriteria/RealEstateExclusions/SafetyMonitoring**

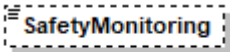
|            |   |
|------------|---|
| diagram    |  <p><b>SafetyMonitoring</b><br/>54060_Financial_Instrument_ESG_Safety_Monitoring</p> |
| type       | <a href="#">EETYesNoType</a>  |
| properties | isRef 0<br>minOcc 0<br>maxOcc 1<br>content simple   |
| facets     | Kind Value annotation<br>length 1   |
| annotation | documentation<br>54060_Financial_Instrument_ESG_Safety_Monitoring   |

element **EETReportType/ScreeningCriteria/RealEstateExclusions/BiodiversityMonitoring**

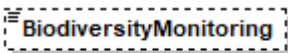
|         |   |
|---------|---|
| diagram |  <p><b>BiodiversityMonitoring</b><br/>54070_Financial_Instrument_ESG_Biodiversity_Monitoring</p> |
| type    | <a href="#">EETYesNoType</a>  |

|            |   |
|------------|---|
| properties | isRef 0<br>minOcc 0<br>maxOcc 1<br>content simple                       |
| facets     | Kind Value annotation<br>length 1                                       |
| annotation | documentation<br>54070_Financial_Instrument_ESG_Biodiversity_Monitoring |

element **EETReportType/CountrySpecificInformation**

|            |   |
|------------|---|
| diagram    | <p>The diagram illustrates the structure of the <b>CountrySpecificInformation</b> element. It is represented by a dashed box containing the text "CountrySpecificInformation" and the range "60400 - 60440". This element is connected via a line with a central circle and three dots to a container element (a rectangle with a double-line border). This container has two children, each in a dashed box: "France" with the range "60400 - 60430" and "Germany" with the range "60440". Both child boxes have a small square icon with a plus sign in the top right corner.</p> |
| properties | isRef 0<br>minOcc 0<br>maxOcc 1<br>content complex  |
| children   | <a href="#">France</a> <a href="#">Germany</a>  |
| annotation | documentation<br>60400 - 60440  |

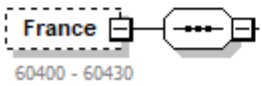

element **EETReportType/CountrySpecificInformation/France**

|  |   |
|--|---|
| <p>diagram</p>  | <p><b>FrenchAMFDoctrineApproach</b></p> <p>60400_French_AMF_Doctrine_Approach:<br/>Which approach of the AMF position/recommendation 2020-03 does your fund comply with?<br/>1: Approach based on a significantly engaging methodology<br/>2: Non-significantly engaging methodology approach<br/>3: Approach not meeting central or limited communication standards</p> <p><b>EnvironmentalTopicOrConsideredIndicatorsForFrenchMiFIDMarket</b></p> <p>60410_Financial_Instrument_Environmental_Topic_Or_Considered_Indicators_For_French_MiFID_Market:<br/>Description of the Environmental topics integrated in the investment process of the fund,<br/>Multiple answers field.<br/>A - Transition to low carbon economy<br/>B - Natural resources preservation or consumption<br/>C - Land and Ocean preservation<br/>D - Waste<br/>E - Biodiversity preservation<br/>F - none</p> <p><b>SocialTopicOrConsideredIndicatorsForFrenchMiFIDMarket</b></p> <p>60420_Financial_Instrument_Social_Topic_Or_Considered_Indicators_For_French_MiFID_Market:<br/>Description of the social topics integrated in the investment strategy,<br/>Multiple answers fields.<br/>A - Social and human rights<br/>B - labour relations<br/>C - investment in human capital (including health)<br/>D - none</p> <p><b>GovernanceTopicOrConsideredIndicatorsForFrenchMiFIDMarket</b></p> <p>60430_Financial_Instrument_Governance_Topic_Or_Considered_Indicators_For_French_MiFID_Market:<br/>Description of the governance topic integrated in the investment strategy,<br/>Multiple answers field<br/>A - anti bribery and corruption<br/>B - governance other<br/>C - none</p> |
| <p>properties</p>  | <p>isRef 0<br/>minOcc 0<br/>maxOcc 1<br/>content complex</p>  |
| <p>children</p>  | <p><a href="#">FrenchAMFDoctrineApproach</a> <a href="#">EnvironmentalTopicOrConsideredIndicatorsForFrenchMiFIDMarket</a> <a href="#">SocialTopicOrConsideredIndicatorsForFrenchMiFIDMarket</a> <a href="#">GovernanceTopicOrConsideredIndicatorsForFrenchMiFIDMarket</a></p>   |
| <p>annotation</p>  | <p>documentation<br/>60400 - 60430</p>  |

element **EETReportType/CountrySpecificInformation/France/FrenchAMFDoctrineApproach**

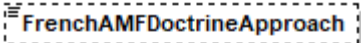
|            |  |
|------------|--|
| diagram    |  <p>60400_French_AMF_Doctrine_Approach:<br/>Which approach of the AMF position/recommendation 2020-03 does your fund comply with?<br/>1: Approach based on a significantly engaging methodology<br/>2: Non-significantly engaging methodology approach<br/>3: Approach not meeting central or limited communication standards</p> |
| type       | restriction of <b>xs:string</b>  |
| properties | <p>isRef 0<br/>minOcc 0<br/>maxOcc 1<br/>content simple</p>  |
| annotation | <p>documentation<br/>60400_French_AMF_Doctrine_Approach:<br/>Which approach of the AMF position/recommendation 2020-03 does your fund comply with?<br/>1: Approach based on a significantly engaging methodology<br/>2: Non-significantly engaging methodology approach<br/>3: Approach not meeting central or limited communication standards</p>   |

element

**EETReportType/CountrySpecificInformation/France/EnvironmentalTopicOrConsideredIndicatorsForFrenchMiFIDMarket**

|            |   |
|------------|---|
| diagram    |  <p>60410_Financial_Instrument_Environmental_Topic_Or_Considered_Indicators_For_French_MiFID_Market:<br/>Description of the Environmental topics integrated in the investment process of the fund,<br/>Multiple answers field.<br/>A - Transition to low carbon economy<br/>B - Natural resources preservation or consumption<br/>C - Land and Ocean preservation<br/>D - Waste<br/>E - Biodiversity preservation<br/>F - none</p> |
| type       | restriction of <b>xs:string</b>   |
| properties | <p>isRef 0<br/>minOcc 0<br/>maxOcc 1<br/>content simple</p>   |
| annotation | <p>documentation<br/>60410_Financial_Instrument_Environmental_Topic_Or_Considered_Indicators_For_French_MiFID_Market:<br/>Description of the Environmental topics integrated in the investment process of the fund,<br/>Multiple answers field.<br/>A - Transition to low carbon economy<br/>B - Natural resources preservation or consumption<br/>C - Land and Ocean preservation<br/>D - Waste<br/>E - Biodiversity preservation<br/>F - none</p>   |

element

**EETReportType/CountrySpecificInformation/France/SocialTopicOrConsideredIndicatorsForFrenchMiFIDMarket**

|            |  |
|------------|--|
| diagram    | <p>60420_Financial_Instrument_Social_Topic_Or_Considered_Indicators_For_French_MiFID_Market:<br/>         Description of the social topics integrated in the investment strategy,<br/>         Multiple answers fields.<br/>         A - Social and human rights<br/>         B - labour relations<br/>         C - investment in human capital (including health)<br/>         D - none</p> |
| type       | restriction of <b>xs:string</b>  |
| properties | isRef 0<br>minOcc 0<br>maxOcc 1<br>content simple  |
| annotation | documentation<br>60420_Financial_Instrument_Social_Topic_Or_Considered_Indicators_For_French_MiFID_Market:<br>Description of the social topics integrated in the investment strategy,<br>Multiple answers fields.<br>A - Social and human rights<br>B - labour relations<br>C - investment in human capital (including health)<br>D - none   |

element

**EETReportType/CountrySpecificInformation/France/GovernanceTopicOrConsideredIndicatorsForFrenchMiFIDMarket**

|            |   |
|------------|---|
| diagram    | <p>60430_Financial_Instrument_Governance_Topic_Or_Considered_Indicators_For_French_MiFID_Market:<br/>         Description of the governance topic integrated in the investment strategy,<br/>         Multiple answers field<br/>         A - anti bribery and corruption<br/>         B - governance other<br/>         C - none</p> |
| type       | restriction of <b>xs:string</b>   |
| properties | isRef 0<br>minOcc 0<br>maxOcc 1<br>content simple   |
| annotation | documentation<br>60430_Financial_Instrument_Governance_Topic_Or_Considered_Indicators_For_French_MiFID_Market:<br>Description of the governance topic integrated in the investment strategy,<br>Multiple answers field<br>A - anti bribery and corruption<br>B - governance other<br>C - none   |

element **EETReportType/CountrySpecificInformation/Germany**

|            |   |
|------------|---|
| diagram    |   |
| properties | isRef 0<br>minOcc 0<br>maxOcc 1<br>content complex        |
| children   | <a href="#">SustainableIndicatorsForGermanMiFIDMarket</a> |
| annotation | documentation<br>60440                                    |

element

**EETReportType/CountrySpecificInformation/Germany/SustainableIndicatorsForGermanMiFIDMarket**

|            |   |
|------------|---|
| diagram    |   |
| type       | restriction of <b>xs:string</b>   |
| properties | isRef 0<br>minOcc 0<br>maxOcc 1<br>content simple   |
| annotation | documentation<br>60440_Financial_Instrument_Sustainable_Indicators_For_German_MiFID_Market:<br>O, B, E, P, Q, R, S, T, U or V |

complexType EETReportType1.1

diagram

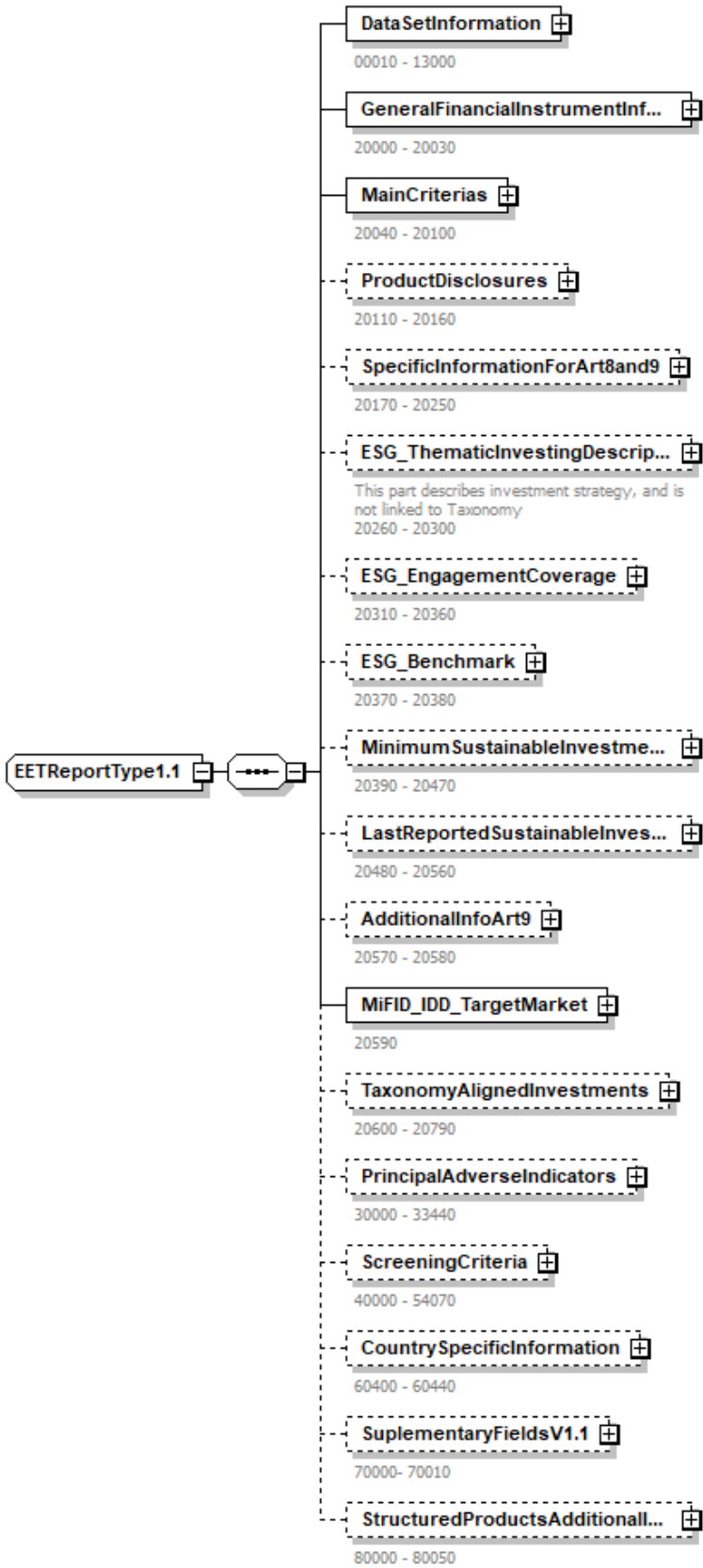

|          |   |
|----------|---|
| children | <a href="#">DataSetInformation</a> <a href="#">GeneralFinancialInstrumentInformation</a> <a href="#">MainCriteria</a> <a href="#">ProductDisclosures</a> <a href="#">SpecificInformationForArt8and9</a> <a href="#">ESG</a> <a href="#">ThematicInvestingDescription</a> <a href="#">ESG</a> <a href="#">EngagementCoverage</a> <a href="#">ESG</a> <a href="#">Benchmark</a> <a href="#">MinimumSustainableInvestments</a> <a href="#">LastReportedSustainableInvestments</a> <a href="#">AdditionalInfoArt9</a> <a href="#">MiFID</a> <a href="#">IDD</a> <a href="#">TargetMarket</a> <a href="#">TaxonomyAlignedInvestments</a> <a href="#">PrincipalAdverseIndicators</a> <a href="#">ScreeningCriteria</a> <a href="#">CountrySpecificInformation</a> <a href="#">SupplementaryFieldsV1.1</a> <a href="#">StructuredProductsAdditionalInformation</a> |
| used by  | element <a href="#">EETsType1.1/EET1.1</a>  |

element [EETReportType1.1/DataSetInformation](#)

|            |   |
|------------|---|
| diagram    | <p><b>DataSetInformation</b><br/>00010 - 13000</p> <ul style="list-style-type: none"> <li><b>DataSetInformation</b><br/>00010 - 00100</li> <li><b>ManufacturerInformation</b><br/>10000 - 10040</li> <li><b>ManufacturerCommitmentToResponsibleInvestment</b><br/>11000 - 11040</li> <li><b>ManufacturerStewardshipCodeSignatory</b><br/>12000_Manufacturer_Stewardship_Code_Signatory<br/>Disclosure of the applicable Stewardship Code</li> <li><b>ManufacturerWebsiteInformationStewardshipAndEngagement</b><br/>13000_Manufacturer_Website_Information_Stewardship_And_Engagement<br/>Internet adress where the client can find all relevant informations regarding stewardship and engagement of the manufacturer</li> </ul> |
| properties | isRef 0<br>content complex  |
| children   | <a href="#">DataSetInformation</a> <a href="#">ManufacturerInformation</a> <a href="#">ManufacturerCommitmentToResponsibleInvestment</a> <a href="#">ManufacturerStewardshipCodeSignatory</a> <a href="#">ManufacturerWebsiteInformationStewardshipAndEngagement</a>  |
| annotation | documentation<br>00010 - 13000  |

element **EETReportType1.1/DataSetInformation/DataSetInformation**

|            |   |
|------------|---|
| diagram    | <p><b>DataSetInformation</b><br/>00010 - 00100</p> <p><b>Version</b><br/>This field specifies the output version of the template and is used by the recipient to understand the number of fields expected, their labeling and order.</p> <p><b>Producer</b> +<br/>00020_EET_Producer_Name<br/>00030_EET_Producer_LEI<br/>00040_EET_Producer_Email</p> <p><b>FileGeneration</b><br/>00050_EET_File_Generation<br/>_Date_And_Time<br/>Date and Time of the creation of the EET file</p> <p><b>DataReporting</b> +<br/>00060 - 00100</p> |
| properties | isRef 0<br>content complex  |
| children   | <a href="#">Version</a> <a href="#">Producer</a> <a href="#">FileGeneration</a> <a href="#">DataReporting</a>   |
| annotation | documentation<br>00010 - 00100  |

element **EETReportType1.1/DataSetInformation/DataSetInformation/Version**

|            |   |
|------------|---|
| diagram    | <p><b>Version</b><br/>This field specifies the output version of the template and is used by the recipient to understand the number of fields expected, their labeling and order.</p> |
| type       | restriction of <b>xs:string</b>   |
| properties | isRef 0<br>content simple   |
| annotation | documentation<br>This field specifies the output version of the template and is used by the recipient to understand the number of fields expected, their labeling and order.          |

element **EETReportType1.1/DataSetInformation/DataSetInformation/Producer**

|            |  |
|------------|--|
| diagram    |  |
| properties | isRef 0<br>minOcc 0<br>maxOcc 1<br>content complex   |
| children   | <a href="#">Name</a> <a href="#">LEI</a> <a href="#">Email</a>                                 |
| annotation | documentation<br>00020_EET_Producer_Name<br>00030_EET_Producer_LEI<br>00040_EET_Producer_Email |

element **EETReportType1.1/DataSetInformation/DataSetInformation/Producer/Name**

|            |   |
|------------|---|
| diagram    |   |
| type       | <b>xs:string</b>                                  |
| properties | isRef 0<br>minOcc 0<br>maxOcc 1<br>content simple |
| annotation | documentation<br>00020_EET_Producer_Name          |

element **EETReportType1.1/DataSetInformation/DataSetInformation/Producer/LEI**

|            |  |            |       |            |           |    |  |           |    |  |         |                           |  |
|------------|--|------------|-------|------------|-----------|----|--|-----------|----|--|---------|---------------------------|--|
| diagram    |  |            |       |            |           |    |  |           |    |  |         |                           |  |
| type       | <a href="#">LEICodeType</a>  |            |       |            |           |    |  |           |    |  |         |                           |  |
| properties | isRef 0<br>minOcc 0<br>maxOcc 1<br>content simple  |            |       |            |           |    |  |           |    |  |         |                           |  |
| facets     | <table border="0"> <tr> <td>Kind</td> <td>Value</td> <td>annotation</td> </tr> <tr> <td>minLength</td> <td>20</td> <td></td> </tr> <tr> <td>maxLength</td> <td>20</td> <td></td> </tr> <tr> <td>pattern</td> <td>                     ([0-9a-zA-Z]{18}[0-9]{2})                 </td> <td></td> </tr> </table> | Kind       | Value | annotation | minLength | 20 |  | maxLength | 20 |  | pattern | ([0-9a-zA-Z]{18}[0-9]{2}) |  |
| Kind       | Value  | annotation |       |            |           |    |  |           |    |  |         |                           |  |
| minLength  | 20   |            |       |            |           |    |  |           |    |  |         |                           |  |
| maxLength  | 20   |            |       |            |           |    |  |           |    |  |         |                           |  |
| pattern    | ([0-9a-zA-Z]{18}[0-9]{2})  |            |       |            |           |    |  |           |    |  |         |                           |  |
| annotation | documentation<br>00030_EET_Producer_LEI  |            |       |            |           |    |  |           |    |  |         |                           |  |

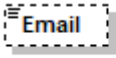

element **EETReportType1.1/DataSetInformation/DataSetInformation/Producer/Email**

|            |   |
|------------|---|
| diagram    |  <p>00040_EET_Producer_Email</p> |
| type       | <b>xs:string</b>  |
| properties | isRef 0<br>minOcc 0<br>maxOcc 1<br>content simple   |
| annotation | documentation<br>00040_EET_Producer_Email   |

element **EETReportType1.1/DataSetInformation/DataSetInformation/FileGeneration**

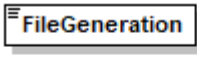
|            |   |
|------------|---|
| diagram    |  <p>00050_EET_File_Generation<br/>_Date_And_Time<br/>Date and Time of the<br/>creation of the EET file</p> |
| type       | <b>xs:dateTime</b>  |
| properties | isRef 0<br>content simple   |
| annotation | documentation<br>00050_EET_File_Generation_Date_And_Time<br>Date and Time of the creation of the EET file   |

element **EETReportType1.1/DataSetInformation/DataSetInformation/DataReporting**

|            |  |
|------------|--|
| diagram    |  |
| properties | isRef 0<br>content complex   |
| children   | <a href="#">SFDR_PreContractual</a> <a href="#">SFDR_Periodic</a> <a href="#">SFDR_EntityLevel</a> <a href="#">MiFID</a> <a href="#">IDD</a> |
| annotation | documentation<br>00060 - 00100   |

element **EETReportType1.1/DataSetInformation/DataSetInformation/DataReporting/SFDR\_PreContractual**

|            |  |
|------------|--|
| diagram    |  |
| type       | <a href="#">EETYesNoType</a>                                   |
| properties | isRef 0<br>content simple                                      |
| facets     | Kind Value annotation<br>length 1                              |
| annotation | documentation<br>00060_EET_Data_Reporting_SFDR_Pre_Contractual |

element **EETReportType1.1/DataSetInformation/DataSetInformation/DataReporting/SFDR\_Periodic**

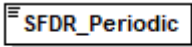
|            |   |
|------------|---|
| diagram    |  <p>00070_EET_Data_Reporting_SFDR_Periodic<br/>No means that there is not yet a periodic reporting. The M related fields have not to be fulfilled"</p> |
| type       | <a href="#">EETYesNoType</a>  |
| properties | isRef 0<br>content simple   |
| facets     | Kind Value annotation<br>length 1   |
| annotation | documentation<br>00070_EET_Data_Reporting_SFDR_Periodic<br>No means that there is not yet a periodic reporting. The M related fields have not to be fulfilled"  |

element **EETReportType1.1/DataSetInformation/DataSetInformation/DataReporting/SFDR\_EntityLevel**

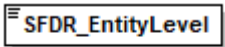
|            |   |
|------------|---|
| diagram    |  <p>00080_EET_Data_Reporting_SFDR_Entity_Level</p> |
| type       | <a href="#">EETYesNoType</a>  |
| properties | isRef 0<br>content simple   |
| facets     | Kind Value annotation<br>length 1   |
| annotation | documentation<br>00080_EET_Data_Reporting_SFDR_Entity_Level   |

element **EETReportType1.1/DataSetInformation/DataSetInformation/DataReporting/MiFID**

|            |   |
|------------|---|
| diagram    |  <p>00090_EET_Data_Reporting_Mifid</p> |
| type       | <a href="#">EETYesNoType</a>  |
| properties | isRef 0<br>content simple   |
| facets     | Kind Value annotation<br>length 1   |
| annotation | documentation<br>00090_EET_Data_Reporting_Mifid   |

element **EETReportType1.1/DataSetInformation/DataSetInformation/DataReporting/IDD**

|            |  |
|------------|--|
| diagram    | <p><b>IDD</b><br/>00100_EET_Data_Reporting_IDD</p> |
| type       | <a href="#">EETYesNoType</a>                       |
| properties | isRef 0<br>content simple                          |
| facets     | Kind Value annotation<br>length 1                  |
| annotation | documentation<br>00100_EET_Data_Reporting_IDD      |

element **EETReportType1.1/DataSetInformation/ManufacturerInformation**

|            |  |
|------------|--|
| diagram    | <p><b>ManufacturerInformation</b><br/>10000 - 10040</p> <ul style="list-style-type: none"> <li><b>Name</b><br/>10000_Manufacturer_Name<br/>Name of the Manufacturer</li> <li><b>CodeType</b><br/>10010_Manufacturer_Code_Type<br/>Type<br/>Codification used to determine the identification code. Either LEI or None.</li> <li><b>Code</b><br/>10020_Manufacturer_Code<br/>Identification code of the Manufacturer</li> <li><b>Email</b><br/>10030_Manufacturer_Email<br/>Contact entry point for distributors for content question</li> <li><b>GeneralReferenceDate</b><br/>10040_General_Reference_Date<br/>Date to which the general data refer</li> </ul> |
| properties | isRef 0<br>content complex   |
| children   | <a href="#">Name</a> <a href="#">CodeType</a> <a href="#">Code</a> <a href="#">Email</a> <a href="#">GeneralReferenceDate</a>  |
| annotation | documentation<br>10000 - 10040   |

element **EETReportType1.1/DataSetInformation/ManufacturerInformation/Name**

|         |   |
|---------|---|
| diagram | <p><b>Name</b><br/>10000_Manufacturer_Name<br/>Name of the Manufacturer</p> |
|---------|---|

|            |  |
|------------|--|
| type       | restriction of <b>xs:string</b>                                      |
| properties | isRef 0<br>content simple  |
| facets     | Kind Value annotation<br>maxLength 255                               |
| annotation | documentation<br>10000_Manufacturer_Name<br>Name of the Manufacturer |

element **EETReportType1.1/DataSetInformation/ManufacturerInformation/CodeType**

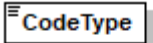
|            |   |
|------------|---|
| diagram    |  <p>10010_Manufacturer_Code_Type<br/>Codification used to determine the identification code. Either LEI or None.</p> |
| type       | restriction of <b>xs:string</b>   |
| properties | isRef 0<br>content simple   |
| annotation | documentation<br>10010_Manufacturer_Code_Type<br>Codification used to determine the identification code. Either LEI or None.  |

element **EETReportType1.1/DataSetInformation/ManufacturerInformation/Code**

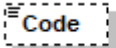
|            |  |
|------------|--|
| diagram    |  <p>10020_Manufacturer_Code<br/>Identification code of the Manufacturer</p> |
| type       | restriction of <b>xs:string</b>  |
| properties | isRef 0<br>minOcc 0<br>maxOcc 1<br>content simple  |
| facets     | Kind Value annotation<br>maxLength 255   |
| annotation | documentation<br>10020_Manufacturer_Code<br>Identification code of the Manufacturer  |

element **EETReportType1.1/DataSetInformation/ManufacturerInformation/Email**

|            |   |
|------------|---|
| diagram    |  <p>10030_Manufacturer_Email<br/>Contact entry point for distributors for content question</p> |
| type       | <b>xs:string</b>  |
| properties | isRef 0<br>minOcc 0<br>maxOcc 1<br>content simple   |

|            |  |
|------------|--|
| annotation | documentation<br>10030_Manufacturer_Email<br>Contact entry point for distributors for content question |
|------------|--|

element **EETReportType1.1/DataSetInformation/ManufacturerInformation/GeneralReferenceDate**

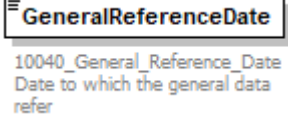
|            |  |
|------------|--|
| diagram    |  <p><b>GeneralReferenceDate</b><br/>10040_General_Reference_Date<br/>Date to which the general data refer</p> |
| type       | <b>xs:date</b>   |
| properties | isRef 0<br>content simple  |
| annotation | documentation<br>10040_General_Reference_Date<br>Date to which the general data refer  |

element **EETReportType1.1/DataSetInformation/ManufacturerCommitmentToResponsibleInvestment**

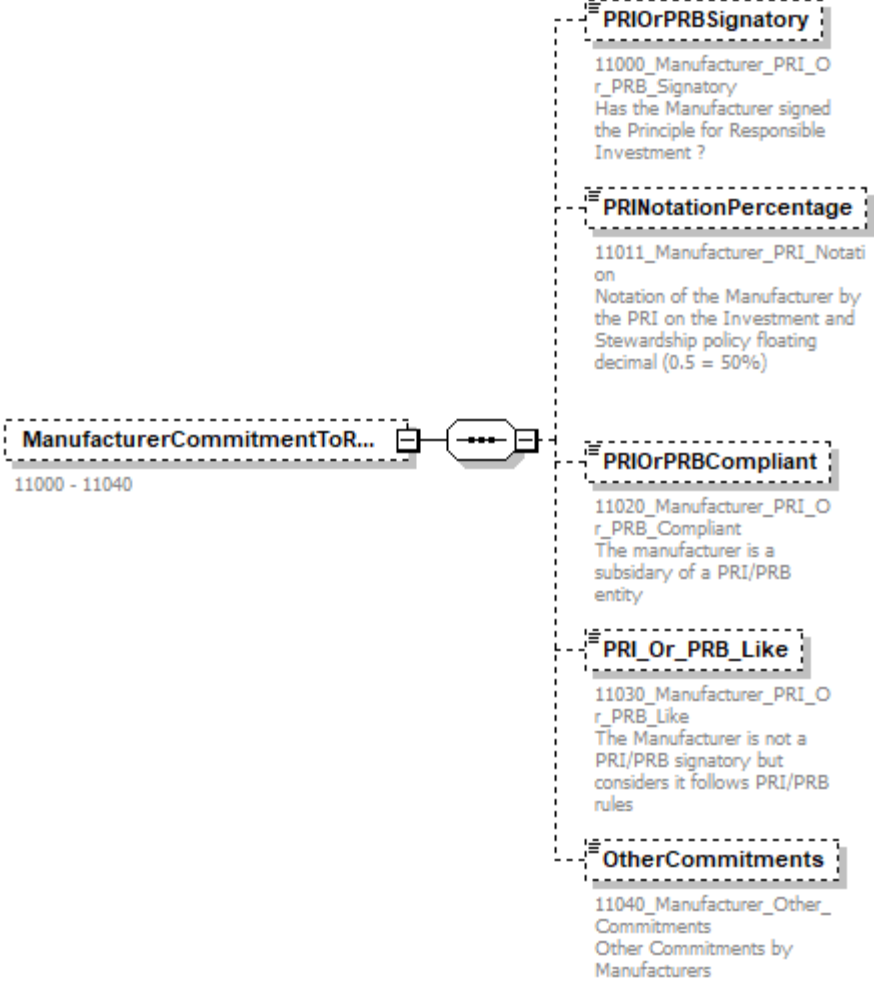
|            |  |
|------------|--|
| diagram    |  <p><b>ManufacturerCommitmentToResponsibleInvestment</b><br/>11000 - 11040</p> <ul style="list-style-type: none"> <li><b>PRIOrPRBSignatory</b><br/>11000_Manufacturer_PRI_O<br/>r_PRB_Signatory<br/>Has the Manufacturer signed<br/>the Principle for Responsible<br/>Investment ?</li> <li><b>PRINotationPercentage</b><br/>11011_Manufacturer_PRI_Notati<br/>on<br/>Notation of the Manufacturer by<br/>the PRI on the Investment and<br/>Stewardship policy floating<br/>decimal (0.5 = 50%)</li> <li><b>PRIOrPRBCompliant</b><br/>11020_Manufacturer_PRI_O<br/>r_PRB_Compliant<br/>The manufacturer is a<br/>subsidiary of a PRI/PRB<br/>entity</li> <li><b>PRI_Or_PRB_Like</b><br/>11030_Manufacturer_PRI_O<br/>r_PRB_Like<br/>The Manufacturer is not a<br/>PRI/PRB signatory but<br/>considers it follows PRI/PRB<br/>rules</li> <li><b>OtherCommitments</b><br/>11040_Manufacturer_Other_<br/>Commitments<br/>Other Commitments by<br/>Manufacturers</li> </ul> |
| properties | isRef 0<br>minOcc 0<br>maxOcc 1  |

|            |  |
|------------|--|
|            | content complex  |
| children   | <a href="#">PRIOrPRBSignatory</a> <a href="#">PRINotationPercentage</a> <a href="#">PRIOrPRBCompliant</a> <a href="#">PRI_Or_PRB_Like</a> <a href="#">OtherCommitments</a> |
| annotation | documentation<br>11000 - 11040   |

element

**EETReportType1.1/DataSetInformation/ManufacturerCommitmentToResponsibleInvestment/PRIOrPRB Signatory**

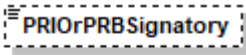
|            |   |
|------------|---|
| diagram    |  <p>11000_Manufacturer_PRI_Or_PRB_Signatory<br/>Has the Manufacturer signed the Principle for Responsible Investment ?</p> |
| type       | <a href="#">EETYesNoType</a>  |
| properties | isRef 0<br>minOcc 0<br>maxOcc 1<br>content simple   |
| facets     | Kind Value annotation<br>length 1   |
| annotation | documentation<br>11000_Manufacturer_PRI_Or_PRB_Signatory<br>Has the Manufacturer signed the Principle for Responsible Investment ?  |

element

**EETReportType1.1/DataSetInformation/ManufacturerCommitmentToResponsibleInvestment/PRINotationPercentage**

|            |  |
|------------|--|
| diagram    |  <p>11011_Manufacturer_PRI_Notation<br/>Notation of the Manufacturer by the PRI on the Investment and Stewardship policy floating decimal (0.5 = 50%)</p> |
| type       | <b>xs:decimal</b>  |
| properties | isRef 0<br>minOcc 0<br>maxOcc 1<br>content simple  |
| annotation | documentation<br>11011_Manufacturer_PRI_Notation<br>Notation of the Manufacturer by the PRI on the Investment and Stewardship policy floating decimal (0.5 = 50%)  |

element

### EETReportType1.1/DataSetInformation/ManufacturerCommitmentToResponsibleInvestment/PRIOrPRB Compliant

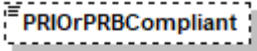
|            |   |
|------------|---|
| diagram    |  <p>11020_Manufacturer_PRI_Or_PRB_Compliant<br/>The manufacturer is a subsidiary of a PRI/PRB entity</p> |
| type       | <a href="#">EETYesNoType</a>  |
| properties | isRef 0<br>minOcc 0<br>maxOcc 1<br>content simple   |
| facets     | Kind Value annotation<br>length 1   |
| annotation | documentation<br>11020_Manufacturer_PRI_Or_PRB_Compliant<br>The manufacturer is a subsidiary of a PRI/PRB entity  |

element

### EETReportType1.1/DataSetInformation/ManufacturerCommitmentToResponsibleInvestment/PRI\_Or\_PR B\_Like

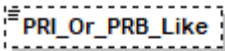
|            |  |
|------------|--|
| diagram    |  <p>11030_Manufacturer_PRI_Or_PRB_Like<br/>The Manufacturer is not a PRI/PRB signatory but considers it follows PRI/PRB rules</p> |
| type       | <a href="#">EETYesNoType</a>   |
| properties | isRef 0<br>minOcc 0<br>maxOcc 1<br>content simple  |
| facets     | Kind Value annotation<br>length 1  |
| annotation | documentation<br>11030_Manufacturer_PRI_Or_PRB_Like<br>The Manufacturer is not a PRI/PRB signatory but considers it follows PRI/PRB rules  |

element

### EETReportType1.1/DataSetInformation/ManufacturerCommitmentToResponsibleInvestment/Other Commitments

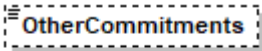
|            |  |
|------------|--|
| diagram    |  <p>11040_Manufacturer_Other_Commitments<br/>Other Commitments by Manufacturers</p> |
| type       | <b>xs:string</b>   |
| properties | isRef 0<br>minOcc 0  |



|            |   |
|------------|---|
|            | maxOcc 1<br>content simple  |
| annotation | documentation<br>11040_Manufacturer_Other_Commitments<br>Other Commitments by Manufacturers |

element **EETReportType1.1/DataSetInformation/ManufacturerStewardshipCodeSignatory**

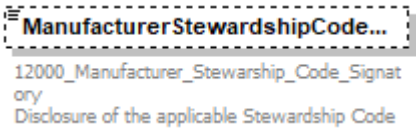
|            |   |
|------------|---|
| diagram    |                                |
| type       | <b>xs:string</b>  |
| properties | isRef 0<br>minOcc 0<br>maxOcc 1<br>content simple   |
| annotation | documentation<br>12000_Manufacturer_Stewardship_Code_Signatory<br>Disclosure of the applicable Stewardship Code |

element

**EETReportType1.1/DataSetInformation/ManufacturerWebsiteInformationStewardshipAndEngagement**

|            |  |
|------------|--|
| diagram    |    |
| type       | <b>xs:string</b>   |
| properties | isRef 0<br>content simple  |
| annotation | documentation<br>13000_Manufacturer_Website_Information_Stewardship_And_Engagement<br>Internet adress where the client can find all relevant informations regarding stewardship and engagement of the manufacturer |

element **EETReportType1.1/GeneralFinancialInstrumentInformation**

diagram

**GeneralFinancialInstrumentInf...**

20000 - 20030

**IdentifyingData**

20000\_Financial\_Instrument\_Identifying\_Data  
 Use the following priority:  
 - ISO 6166 code of ISIN when available  
 - Other recognised codes (e.g.: CUSIP, Bloomberg Ticker, Reuters RIC)  
 - Code attributed by the undertaking, when the options above are not available. Code must be unique and kept consistent over time

**TypeOfIdentification**

20010\_Financial\_Instrument\_Type\_Of\_Identification\_Code  
 One of the options in the following closed list to be used:  
 1 - ISO 6166 for ISIN code  
 2 - CUSIP (The Committee on Uniform Securities Identification Procedures number assigned by the CUSIP Service Bureau for U.S. and Canadian companies)  
 3 - SEDOL (Stock Exchange Daily Official List for the London Stock Exchange)  
 4 - WKN (Wertpapier Kenn-Nummer, the alphanumeric German identification number)  
 5 - Bloomberg Ticker (Bloomberg letters code that identify a company's securities)  
 6 - BBGID (The Bloomberg Global ID)  
 7 - Reuters RIC (Reuters instrument code)  
 8 - FIGI (Financial Instrument Global Identifier)  
 9 - Other code by members of the Association of National Numbering Agencies  
 10 - LEI  
 99 - Code attributed by the undertaking

**Name**

20020\_Financial\_Instrument\_Name  
 Name of the financial instrument

**Currency**

20030\_Financial\_Instrument\_Currency  
 Denomination Currency of the Financial Instrument

|            |  |
|------------|--|
| properties | isRef 0<br>content complex   |
| children   | <a href="#">IdentifyingData</a> <a href="#">TypeOfIdentification</a> <a href="#">Name</a> <a href="#">Currency</a> |
| annotation | documentation<br>20000 - 20030   |

element **EETReportType1.1/GeneralFinancialInstrumentInformation/IdentifyingData**

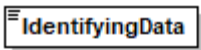
|            |   |
|------------|---|
| diagram    |  <p>20000_Financial_Instrument_Identifying_Data<br/>Use the following priority:<br/>- ISO 6166 code of ISIN when available<br/>- Other recognised codes (e.g.: CUSIP, Bloomberg Ticker, Reuters RIC)<br/>- Code attributed by the undertaking, when the options above are not available. Code must be unique and kept consistent over time</p> |
| type       | restriction of <b>xs:string</b>   |
| properties | isRef 0<br>content simple   |
| facets     | Kind Value annotation<br><b>maxLength</b> 255   |
| annotation | documentation<br>20000_Financial_Instrument_Identifying_Data<br>Use the following priority:<br>- ISO 6166 code of ISIN when available<br>- Other recognised codes (e.g.: CUSIP, Bloomberg Ticker, Reuters RIC)<br>- Code attributed by the undertaking, when the options above are not available. Code must be unique and kept consistent over time   |

element **EETReportType1.1/GeneralFinancialInstrumentInformation/TypeOfIdentification**

|                   |   |
|-------------------|---|
| <p>diagram</p>    | <div style="border: 1px solid black; padding: 5px; margin-bottom: 10px;"> <p><b>TypeOfIdentification</b></p> </div> <p>20010_Financial_Instrument<br/>_Type_Of_Identification_Code</p> <p>One of the options in the following closed list to be used:</p> <ul style="list-style-type: none"> <li>1 - ISO 6166 for ISIN code</li> <li>2 - CUSIP (The Committee on Uniform Securities Identification Procedures number assigned by the CUSIP Service Bureau for U.S. and Canadian companies)</li> <li>3 - SEDOL (Stock Exchange Daily Official List for the London Stock Exchange)</li> <li>4 - WKN (Wertpapier Kenn-Nummer, the alphanumeric German identification number)</li> <li>5 - Bloomberg Ticker (Bloomberg letters code that identify a company's securities)</li> <li>6 - BBGID (The Bloomberg Global ID)</li> <li>7 - Reuters RIC (Reuters instrument code)</li> <li>8 - FIGI (Financial_Instrument Global Identifier)</li> <li>9 - Other code by members of the Association of National Numbering Agencies</li> <li>10 - LEI</li> <li>99 - Code attributed by the undertaking</li> </ul> |
| <p>type</p>       | <p>restriction of <b>xs:int</b></p>   |
| <p>properties</p> | <p>isRef 0<br/>content simple</p>   |
| <p>annotation</p> | <p>documentation</p> <p>20010_Financial_Instrument_Type_Of_Identification_Code</p> <p>One of the options in the following closed list to be used:</p> <ul style="list-style-type: none"> <li>1 - ISO 6166 for ISIN code</li> <li>2 - CUSIP (The Committee on Uniform Securities Identification Procedures number assigned by the CUSIP Service Bureau for U.S. and Canadian companies)</li> <li>3 - SEDOL (Stock Exchange Daily Official List for the London Stock Exchange)</li> <li>4 - WKN (Wertpapier Kenn-Nummer, the alphanumeric German identification number)</li> <li>5 - Bloomberg Ticker (Bloomberg letters code that identify a company's securities)</li> <li>6 - BBGID (The Bloomberg Global ID)</li> <li>7 - Reuters RIC (Reuters instrument code)</li> <li>8 - FIGI (Financial_Instrument Global Identifier)</li> <li>9 - Other code by members of the Association of National Numbering Agencies</li> <li>10 - LEI</li> <li>99 - Code attributed by the undertaking</li> </ul>   |

element **EETReportType1.1/GeneralFinancialInstrumentInformation/Name**

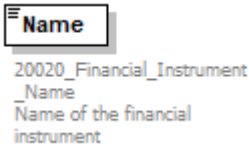
|            |  |
|------------|--|
| diagram    |     |
| type       | restriction of <b>xs:string</b>  |
| properties | isRef 0<br>content simple  |
| facets     | Kind Value annotation<br>maxLength 255   |
| annotation | documentation<br>20020_Financial_Instrument_Name<br>Name of the financial instrument |

element **EETReportType1.1/GeneralFinancialInstrumentInformation/Currency**

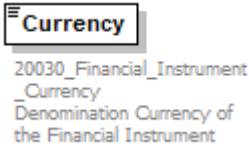
|            |   |
|------------|---|
| diagram    |                          |
| type       | <a href="#">ISOCurrencyCodeType</a>   |
| properties | isRef 0<br>content simple   |
| facets     | Kind Value annotation<br>minLength 3<br>maxLength 3<br>pattern [A-Z]{3}                                   |
| annotation | documentation<br>20030_Financial_Instrument_Currency<br>Denomination Currency of the Financial Instrument |

element **EETReportType1.1/MainCriteria**

|                   |   |
|-------------------|---|
| <p>diagram</p>    | <p><b>MainCriteria</b><br/>20040 - 20100</p> <ul style="list-style-type: none"> <li><b>SFDRProductType</b><br/>20040_Financial_Instrument_SFDR_Product_Type<br/>Reference of the article of SFDR european regulation applying to the product (art 6, art 8 or art 9)<br/>6= no product acc. to Art. 8/9<br/>8= Art. 8 SFDR Product (ESG characteristics)<br/>9= Art. 9 SFDR product (ESG objective)</li> <li><b>SFDRProductTypeEligible</b><br/>20050_Financial_Instrument_SFDR_Product_Type_Eligible<br/>Funds not being in SFDR scope and structured products. Art 8 like, art 9 like</li> <li><b>ESGLabelOrStandard</b><br/>20060_Financial_Instrument_ESG_Label_Or_Standard<br/>Disclosure of applicable ESG Label/s</li> <li><b>PercentageMinimumSFDRArt8F...</b><br/>20070_Financial_Instrument_Percentage_Of_Minimum_SFDR_Art_8_Funds<br/>Proportion in look through of art 8 sub invested funds for funds of funds Nav based</li> <li><b>PercentageMinimumSFDRArt9F...</b><br/>20080_Financial_Instrument_Percentage_Of_Minimum_SFDR_Art_9_Funds<br/>Proportion in look through of art 9 sub invested funds for funds of funds Nav based</li> <li><b>MainESGFocus</b><br/>20090_Financial_Instrument_Main_ESG_Focus<br/>Indication of the "main focus" of the Financial Instrument ( for example E for green bonds...), E or S or G or MF (Multi focus) or Blank (if no focus at all)</li> <li><b>ConsidersPrincipleAdverseImp...</b><br/>20100_Financial_Instrument_Does_This_Product_Consider_Principle_Adverse_Impact_In_Their_Investment</li> </ul> |
| <p>properties</p> | <p>isRef 0<br/>content complex</p>  |
| <p>children</p>   | <p><a href="#">SFDRProductType</a> <a href="#">SFDRProductTypeEligible</a> <a href="#">ESGLabelOrStandard</a> <a href="#">PercentageMinimumSFDRArt8Funds</a> <a href="#">PercentageMinimumSFDRArt9Funds</a> <a href="#">MainESGFocus</a> <a href="#">ConsidersPrincipleAdverseImpact</a></p>  |

|            |                                |
|------------|--------------------------------|
| annotation | documentation<br>20040 - 20100 |
|------------|--------------------------------|

element **EETReportType1.1/MainCriteria/SFDRProductType**

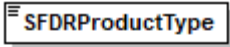
|            |   |
|------------|---|
| diagram    |  <p>20040_Financial_Instrument_SFDR_Product_Type<br/>Reference of the article of SFDR european regulation applying to the product (art 6, art 8 or art 9)<br/>6= no product acc. to Art. 8/9<br/>8= Art. 8 SFDR Product (ESG characteristics)<br/>9= Art. 9 SFDR product (ESG objective)</p> |
| type       | restriction of <b>xs:string</b>   |
| properties | isRef 0<br>content simple   |
| annotation | documentation<br>20040_Financial_Instrument_SFDR_Product_Type<br>Reference of the article of SFDR european regulation applying to the product (art 6, art 8 or art 9)<br>6= no product acc. to Art. 8/9<br>8= Art. 8 SFDR Product (ESG characteristics)<br>9= Art. 9 SFDR product (ESG objective)   |

element **EETReportType1.1/MainCriteria/SFDRProductTypeEligible**

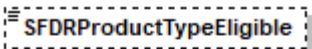
|            |  |
|------------|--|
| diagram    |  <p>20050_Financial_Instrument_SFDR_Product_Type_Eligible<br/>Funds not being in SFDR scope and structured products. Art 8 like, art 9 like</p> |
| type       | restriction of <b>xs:string</b>  |
| properties | isRef 0<br>minOcc 0<br>maxOcc 1<br>content simple  |
| annotation | documentation<br>20050_Financial_Instrument_SFDR_Product_Type_Eligible<br>Funds not being in SFDR scope and structured products. Art 8 like, art 9 like  |

element **EETReportType1.1/MainCriteria/ESGLabelOrStandard**

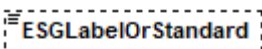
|            |  |
|------------|--|
| diagram    |  <p>20060_Financial_Instrument_ESG_Label_Or_Standard<br/>Disclosure of applicable ESG Label/s</p> |
| type       | <b>xs:string</b>   |
| properties | isRef 0<br>minOcc 0<br>maxOcc 1<br>content simple  |

|            |   |
|------------|---|
| annotation | documentation<br>20060_Financial_Instrument_ESG_Label_Or_Standard<br>Disclosure of applicable ESG Label/s |
|------------|---|

element **EETReportType1.1/MainCriterias/PercentageMinimumSFDRArt8Funds**

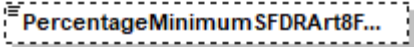
|            |  |
|------------|--|
| diagram    |  <p>20070_Financial_Instrument_Percentage_Of_Minimum_SFDR_Art_8_Funds<br/>Proportion in look through of art 8 sub invested funds for funds of funds Nav based</p> |
| type       | <b>xs:decimal</b>  |
| properties | isRef 0<br>minOcc 0<br>maxOcc 1<br>content simple  |
| annotation | documentation<br>20070_Financial_Instrument_Percentage_Of_Minimum_SFDR_Art_8_Funds<br>Proportion in look through of art 8 sub invested funds for funds of funds Nav based  |

element **EETReportType1.1/MainCriterias/PercentageMinimumSFDRArt9Funds**

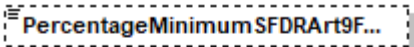
|            |  |
|------------|--|
| diagram    |  <p>20080_Financial_Instrument_Percentage_Of_Minimum_SFDR_Art_9_Funds<br/>Proportion in look through of art 9 sub invested funds for funds of funds Nav based</p> |
| type       | <b>xs:decimal</b>  |
| properties | isRef 0<br>minOcc 0<br>maxOcc 1<br>content simple  |
| annotation | documentation<br>20080_Financial_Instrument_Percentage_Of_Minimum_SFDR_Art_9_Funds<br>Proportion in look through of art 9 sub invested funds for funds of funds Nav based  |

element **EETReportType1.1/MainCriterias/MainESGFocus**

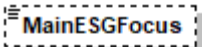
|            |  |
|------------|--|
| diagram    |  <p>20090_Financial_Instrument_Main_ESG_Focus<br/>Indication of the "main focus" of the Financial_Instrument ( for example E for green bonds...), E or S or G or MF (Multi focus) or Blank (if no focus at all)</p> |
| type       | restriction of <b>xs:string</b>  |
| properties | isRef 0  |



|            |   |
|------------|---|
|            | minOcc 0<br>maxOcc 1<br>content simple  |
| annotation | documentation<br>20090_Financial_Instrument_Main_ESG_Focus<br>Indication of the "main focus" of the Financial_Instrument ( for example E for green bonds...). E or S or G or MF (Multi focus) or Blank (if no focus at all) |

element **EETReportType1.1/MainCriterias/ConsidersPrincipleAdverseImpact**

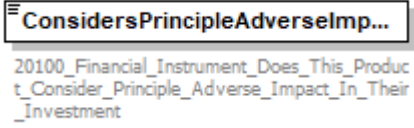
|            |   |
|------------|---|
| diagram    |                                    |
| type       | <a href="#">EETYesNoType</a>  |
| properties | isRef 0<br>content simple   |
| facets     | Kind Value annotation<br>length 1   |
| annotation | documentation<br>20100_Financial_Instrument_Does_This_Product_Consider_Principle_Adverse_Impact_In_Their_Investment |

element **EETReportType1.1/ProductDisclosures**

|                   |  |
|-------------------|--|
| <p>diagram</p>    | <p><b>ProductDisclosures</b><br/>20110 - 20160</p> <p><b>Languages</b><br/>20110_Financial_Instrument_Languages<br/>Each insurance company needs to have the documents translated and published in the language of the countries of distribution. This field allows to list the languages in which the annexes documents are translated</p> <p><b>Link_To_PCDFP_For_MOP</b><br/>20120_Financial_Instrument_Link_To_PCDFP_For_MOP<br/>Pre Contractual Disclosure for Financial Products referred to in Article 8(1) and 9(1), (2) and (3) (EU) 2019/2088 as stand alone document PDF for underlying investment options in Multi Option Products. Annex I, Annex II (EU) 2019/2088.</p> <p><b>ProductionDate_PCDFP</b><br/>20130_Financial_Instrument_Production_Date_PCDFP<br/>Date of production of PCDFP</p> <p><b>Link_To_PDFP_for_MOP</b><br/>20140_Financial_Instrument_Link_To_PDFP_for_MOP<br/>Periodic Disclosure for Financial Products referred to in Article 8(1) and 9(1), (2) and (3) (EU) 2019/2088 as stand alone document PDF for underlying investment options in Multi Option Products. Annex III, Annex IV (EU) 2019/2088.</p> <p><b>EndDateOfReportingPeriod_PDFP</b><br/>20150_Financial_Instrument_End_Date_Of_Reporting_Period_PDFP<br/>End Date Of Reporting Period PDFP (based on 12 months reporting report market usage)</p> <p><b>LinkTo_SFDR_WebsiteProductDi...</b><br/>20160_Financial_Instrument_Link_To_SFDR_Website_Product_Disclosures Art 10 SFDR - 24 RTS u 37 RTS</p> |
| <p>properties</p> | <p>isRef 0<br/>minOcc 0<br/>maxOcc 1<br/>content complex</p>   |
| <p>children</p>   | <p><a href="#">Languages</a> <a href="#">Link_To_PCDFP_For_MOP</a> <a href="#">ProductionDate_PCDFP</a> <a href="#">Link_To_PDFP_for_MOP</a> <a href="#">EndDateOfReportingPeriod_PDFP</a> <a href="#">LinkTo_SFDR_WebsiteProductDisclosures</a></p>   |
| <p>annotation</p> | <p>documentation<br/>20110 - 20160</p>   |

element **EETReportType1.1/ProductDisclosures/Languages**

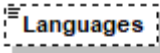
|            |   |
|------------|---|
| diagram    |  <p>20110_Financial_Instrument_Languages<br/>Each insurance company needs to have the documents translated and published in the language of the countries of distribution. This field allows to list the languages in which the annexes documents are translated</p> |
| type       | <b>xs:string</b>  |
| properties | <p>isRef 0<br/>minOcc 0<br/>maxOcc 1<br/>content simple</p>   |
| annotation | <p>documentation<br/>20110_Financial_Instrument_Languages<br/>Each insurance company needs to have the documents translated and published in the language of the countries of distribution. This field allows to list the languages in which the annexes documents are translated</p>   |

element **EETReportType1.1/ProductDisclosures/Link\_To\_PCDFP\_For\_MOP**

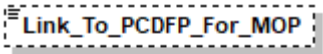
|            |   |
|------------|---|
| diagram    |  <p>20120_Financial_Instrument_Link_To_PCDFP_For_MOP<br/>Pre Contractual Disclosure for Financial Products referred to in Article 8(1) and 9(1), (2) and (3) (EU) 2019/2088 as stand alone document PDF for underlying investment options in Multi Option Products. Annex I, Annex II (EU) 2019/2088.</p> |
| type       | <b>xs:anyURI</b>  |
| properties | <p>isRef 0<br/>minOcc 0<br/>maxOcc 1<br/>content simple</p>   |
| annotation | <p>documentation<br/>20120_Financial_Instrument_Link_To_PCDFP_For_MOP<br/>Pre Contractual Disclosure for Financial Products referred to in Article 8(1) and 9(1), (2) and (3) (EU) 2019/2088 as stand alone document PDF for underlying investment options in Multi Option Products. Annex I, Annex II (EU) 2019/2088.</p>  |

element **EETReportType1.1/ProductDisclosures/ProductionDate\_PCDFP**

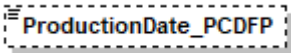
|            |   |
|------------|---|
| diagram    |  <p>20130_Financial_Instrument_Production_Date_PCDFP<br/>Date of production of PCDFP</p> |
| type       | <b>xs:date</b>  |
| properties | <p>isRef 0<br/>minOcc 0<br/>maxOcc 1</p>  |

|            |  |
|------------|--|
|            | content simple   |
| annotation | documentation<br>20130_Financial_Instrument_Production_Date_PCDFP<br>Date of production of PCDFP |

element **EETReportType1.1/ProductDisclosures/Link\_To\_PDFP\_for\_MOP**

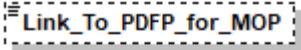
|            |  |
|------------|--|
| diagram    |  <p>20140_Financial_Instrument_Link_To_PDFP_for_MOP<br/>Periodic Disclosure for Financial Products referred to in Article 8(1) and 9(1), (2) and (3) (EU) 2019/2088 as stand alone document PDF for underlying investment options in Multi Option Products. Annex III, Annex IV (EU) 2019/2088.</p> |
| type       | <b>xs:anyURI</b>   |
| properties | isRef 0<br>minOcc 0<br>maxOcc 1<br>content simple  |
| annotation | documentation<br>20140_Financial_Instrument_Link_To_PDFP_for_MOP<br>Periodic Disclosure for Financial Products referred to in Article 8(1) and 9(1), (2) and (3) (EU) 2019/2088 as stand alone document PDF for underlying investment options in Multi Option Products. Annex III, Annex IV (EU) 2019/2088.  |

element **EETReportType1.1/ProductDisclosures/EndDateOfReportingPeriod\_PDFP**

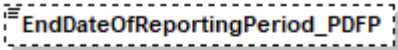
|            |  |
|------------|--|
| diagram    |  <p>20150_Financial_Instrument_End_Date_Of_Reporting_Period_PDFP<br/>End Date Of Reporting Period PDFP (based on 12 months reporting report market usage)</p> |
| type       | <b>xs:date</b>   |
| properties | isRef 0<br>minOcc 0<br>maxOcc 1<br>content simple  |
| annotation | documentation<br>20150_Financial_Instrument_End_Date_Of_Reporting_Period_PDFP<br>End Date Of Reporting Period PDFP (based on 12 months reporting report market usage)  |

element **EETReportType1.1/ProductDisclosures/LinkTo\_SFDR\_WebsiteProductDisclosures**

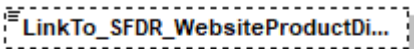
|            |  |
|------------|--|
| diagram    |  <p>20160_Financial_Instrument_Link_To_SFDR_Website_Product_Disclosures Art 10 SFDR - 24 RTS u 37 RTS</p> |
| type       | <b>xs:anyURI</b>   |
| properties | isRef 0<br>minOcc 0<br>maxOcc 1<br>content simple  |

annotation

documentation  
20160\_Financial\_Instrument\_Link\_To\_SFDR\_Website\_Product\_Disclosures Art 10 SFDR - 24 RTS u 37 RTS

element **EETReportType1.1/SpecificInformationForArt8and9**

diagram

**SpecificInformationForArt8and9**

20170 - 20250

**SustainableInvestmentsArt8**

20170\_Financial\_Instrument\_Sustainable\_Investments\_Art.8 Does the art 8 product invest in sustainable investment?

**MinimalProportionOfSustainabl...**

20180\_Financial\_Instrument\_Products\_Minimal\_Proportion\_Of\_Sustainable\_Investments\_Art.8

**SustainableInvestmentEUTaxon...**

20190\_Financial\_Instrument\_Sustainable\_Investment\_EU\_Taxonomy\_Art.8 Does the minimum specified in field 20170 include EU Taxonomy sustainable investment?

**SustainableInvestmentEnviron...**

20200\_Financial\_Instrument\_Sustainable\_Investment\_Environmental\_Not\_EU\_Taxonomy\_Art.8 Does the minimum specified in field 20170 include Non EU Taxonomy Environmental sustainable investment?

**SustainableInvestmentSocialObj...**

20210\_Financial\_Instrument\_Sustainable\_Investment\_Social\_Objective\_Art.8 Does the minimum specified in field 20170 include include sustainable investment with social objective?

**SustainableInvestmentWithEnvi...**

20220\_Financial\_Instrument\_Minimum\_Sustainable\_Investment\_With\_Environmental\_Objective\_Art.9 For art 9 products, the minimum proportion of sustainable investments.

**EnvironmentallySustainableInve...**

20230\_Financial\_Instrument\_Environmentally\_Sustainable\_Investment\_EU\_Taxonomy\_Art.9 Does the minimum specified in field 20220 include EU Taxonomy Environmental sustainable investment?

**EnvironmentallySustainableInve...**

20240\_Financial\_Instrument\_Environmentally\_Sustainable\_Investment\_Not\_EU\_Taxonomy\_Art.9 Does the minimum specified in field 20210 include Non EU Taxonomy Environmental sustainable investment?

**MinimumSustainableInvestmen...**

20250\_Financial\_Instrument\_Minimum\_Sustainable\_Investment\_Social\_Objective\_Art.9 Does the minimum specified in field 20210 include sustainable investments with social objectives.

|            |  |
|------------|--|
| properties | isRef 0<br>minOcc 0<br>maxOcc 1<br>content complex   |
| children   | <a href="#">SustainableInvestmentsArt8</a> <a href="#">MinimalProportionOfSustainableInvestmentsArt8</a> <a href="#">SustainableInvestmentEUTaxonomyArt8</a> <a href="#">SustainableInvestmentEnvironmentalNotEUTaxonomyArt8</a> <a href="#">SustainableInvestmentSocialObjectiveArt8</a> <a href="#">SustainableInvestmentWithEnvironmentalObjectiveArt9</a> <a href="#">EnvironmentallySustainableInvestmentEUTaxonomyArt9</a> <a href="#">EnvironmentallySustainableInvestmentNotEUTaxonomyArt9</a> <a href="#">MinimumSustainableInvestmentSocialObjectiveArt9</a> |
| annotation | documentation<br>20170 - 20250   |

element **EETReportType1.1/SpecificInformationForArt8and9/SustainableInvestmentsArt8**

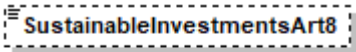
|            |  |
|------------|--|
| diagram    | <br>20170_Financial_Instrument_Sustainable_Investments_Art.8 Does the art 8 product invest in sustainable investment? |
| type       | <a href="#">EETYesNoType</a>   |
| properties | isRef 0<br>minOcc 0<br>maxOcc 1<br>content simple  |
| facets     | Kind Value annotation<br>length 1  |
| annotation | documentation<br>20170_Financial_Instrument_Sustainable_Investments_Art.8 Does the art 8 product invest in sustainable investment?   |

element **EETReportType1.1/SpecificInformationForArt8and9/MinimalProportionOfSustainableInvestmentsArt8**

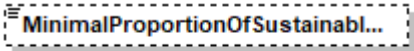
|            |  |
|------------|--|
| diagram    | <br>20180_Financial_Instrument_Products_Minimal_Proportion_Of_Sustainable_Investments_Art.8 |
| type       | <b>xs:decimal</b>  |
| properties | isRef 0<br>minOcc 0<br>maxOcc 1<br>content simple  |
| annotation | documentation<br>20180_Financial_Instrument_Products_Minimal_Proportion_Of_Sustainable_Investments_Art.8   |

element **EETReportType1.1/SpecificInformationForArt8and9/SustainableInvestmentEUTaxonomyArt8**

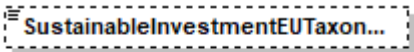
|         |   |
|---------|---|
| diagram | <br>20190_Financial_Instrument_Sustainable_Investment_EU_Taxonomy_Art.8<br>Does the minimum specified in field 20170 include EU Taxonomy sustainable investment? |
|---------|---|

|            |   |
|------------|---|
| type       | <a href="#">EETYesNoType</a>  |
| properties | isRef 0<br>minOcc 0<br>maxOcc 1<br>content simple   |
| facets     | Kind Value annotation<br>length 1   |
| annotation | documentation<br>20190_Financial_Instrument_Sustainable_Investment_EU_Taxonomy_Art.8<br>Does the minimum specified in field 20170 include EU Taxonomy sustainable investment? |

element

**EETReportType1.1/SpecificInformationForArt8and9/SustainableInvestmentEnvironmentalNotEUTaxonomyArt8**

|            |  |
|------------|--|
| diagram    |  <p>20200_Financial_Instrument_Sustainable_Investment_Environmental_Not_EU_Taxonomy_Art.8<br/>Does the minimum specified in field 20170 include Non EU Taxonomy Environmental sustainable investment?</p> |
| type       | <a href="#">EETYesNoType</a>   |
| properties | isRef 0<br>minOcc 0<br>maxOcc 1<br>content simple  |
| facets     | Kind Value annotation<br>length 1  |
| annotation | documentation<br>20200_Financial_Instrument_Sustainable_Investment_Environmental_Not_EU_Taxonomy_Art.8<br>Does the minimum specified in field 20170 include Non EU Taxonomy Environmental sustainable investment?  |

element **EETReportType1.1/SpecificInformationForArt8and9/SustainableInvestmentSocialObjectiveArt8**

|            |   |
|------------|---|
| diagram    |  <p>20210_Financial_Instrument_Sustainable_Investment_Social_Objective_Art.8<br/>Does the minimum specified in field 20170 include include sustainable investment with social objective?</p> |
| type       | <a href="#">EETYesNoType</a>  |
| properties | isRef 0<br>minOcc 0<br>maxOcc 1<br>content simple   |
| facets     | Kind Value annotation<br>length 1   |
| annotation | documentation<br>20210_Financial_Instrument_Sustainable_Investment_Social_Objective_Art.8<br>Does the minimum specified in field 20170 include include sustainable investment with social objective?  |



element

### EETReportType1.1/SpecificInformationForArt8and9/SustainableInvestmentWithEnvironmentalObjectiveArt9

|            |   |
|------------|---|
| diagram    |  <b>SustainableInvestmentWithEnvi...</b><br>20220_Financial_Instrument_Minimum_Sustainable_Investment_With_Environmental_Objective_Art.9<br>For art 9 products, the minimum proportion of sustainable investments. |
| type       | <b>xs:decimal</b>   |
| properties | isRef 0<br>minOcc 0<br>maxOcc 1<br>content simple   |
| annotation | documentation<br>20220_Financial_Instrument_Minimum_Sustainable_Investment_With_Environmental_Objective_Art.9<br>For art 9 products, the minimum proportion of sustainable investments.   |

element

### EETReportType1.1/SpecificInformationForArt8and9/EnvironmentallySustainableInvestmentEUTaxonomyArt9

|            |  |
|------------|--|
| diagram    |  <b>EnvironmentallySustainableInve...</b><br>20230_Financial_Instrument_Environmentally_Sustainable_Investment_EU_Taxonomy_Art.9<br>Does the minimum specified in field 20220 include EU Taxonomy Environmental sustainable investment? |
| type       | <a href="#">EETYesNoType</a>   |
| properties | isRef 0<br>minOcc 0<br>maxOcc 1<br>content simple  |
| facets     | Kind Value annotation<br>length 1  |
| annotation | documentation<br>20230_Financial_Instrument_Environmentally_Sustainable_Investment_EU_Taxonomy_Art.9<br>Does the minimum specified in field 20220 include EU Taxonomy Environmental sustainable investment?  |

element

### EETReportType1.1/SpecificInformationForArt8and9/EnvironmentallySustainableInvestmentNotEUTaxonomyArt9

|            |  |
|------------|--|
| diagram    |  <b>EnvironmentallySustainableInve...</b><br>20240_Financial_Instrument_Environmentally_Sustainable_Investment_Not_EU_Taxonomy_Art.9<br>Does the minimum specified in field 20210 include Non EU Taxonomy Environmental sustainable investment? |
| type       | <a href="#">EETYesNoType</a>   |
| properties | isRef 0<br>minOcc 0  |

|            |   |
|------------|---|
|            | maxOcc 1<br>content simple  |
| facets     | Kind Value annotation<br>length 1   |
| annotation | documentation<br>20240_Financial_Instrument_Environmentally_Sustainable_Investment_Not_EU_Taxonomy_Art.9<br>Does the minimum specified in field 20210 include Non EU Taxonomy Environmental sustainable investment? |

element

**EETReportType1.1/SpecificInformationForArt8and9/MinimumSustainableInvestmentSocialObjectiveArt 9**

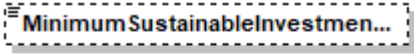
|            |   |
|------------|---|
| diagram    |  <p>20250_Financial_Instrument_Minimum_Sustainable_Investment_Social_Objective_Art.9<br/>Does the minimum specified in field 20210 include sustainable investments with social objectives.</p> |
| type       | <a href="#">PercentageType</a>  |
| properties | isRef 0<br>minOcc 0<br>maxOcc 1<br>content simple   |
| annotation | documentation<br>20250_Financial_Instrument_Minimum_Sustainable_Investment_Social_Objective_Art.9<br>Does the minimum specified in field 20210 include sustainable investments with social objectives.  |

element **EETReportType1.1/ESG\_ThematicInvestingDescription**

diagram

### ESG\_ThematicInvestingDescrip...

This part describes investment strategy, and is not linked to Taxonomy  
20260 - 20300

### ESGExistingThematicCharacteri...

20260\_Financial\_Instrument\_ESG\_Existing\_Thematic  
Does this Financial\_Instrument incorporate ESG factors through ESG thematic approach ?

### EnvironmentalThematicCharact...

20270\_Financial\_Instrument\_Environmental\_Thematic  
Description of the product environment thematic investment strategy, according to SFDR art 2(17). Multiple answers fields.  
A - energy  
B - renewable energy  
C - raw materials  
D - water and land  
E - waste  
F - greenhouse gas emissions  
G - biodiversity  
H - circular economy  
I - environment other  
J - none

### SocialThematicCharacteristics

20280\_Financial\_Instrument\_Social\_Thematic  
Description of the product social thematic investment strategy, according to SFDR art 2(17)  
Multiple answers fields.  
A - inequality  
B - social cohesion,  
C - social integration  
D - labour relations  
E - investment in human capital  
F - economically or socially disadvantaged communities  
G - social other  
H - none

### GovernanceThematicCharacteri...

20290\_Financial\_Instrument\_Governance\_Thematic  
Description of the product thematic investment strategy, according to SFDR art 2(17)  
Multiple answers field  
A - sound management structures  
B - employee relations  
C - remuneration of staff  
D - tax compliance  
E - governance other  
F - none

### SustainableDevelopmentGoals

20300\_Financial\_Instrument\_Alignment\_With\_Sustainable\_Development\_Goals  
Alignment with SDG means that SDG are used in the investment process (screening) or targeted by the fund. Multiple answers field.  
1 - No Poverty  
2 - Zero Hunger  
3 - Good Health and Well-Being  
4 - Quality Education  
5 - Gender Equality  
6 - Clean Water and Sanitation  
7 - Affordable and Clean Energy  
8 - Decent Work and Economic Growth  
9 - Industry, Innovation and Infrastructure  
10 - Reduced Inequality  
11 - Sustainable Cities and Communities  
12 - Responsible Consumption and Production  
13 - Climate Action  
14 - Life Below Water  
15 - Life on Land  
16 - Peace and Justice, Strong Institutions  
17 - Partnerships to achieve to Goal

|            |  |
|------------|--|
| properties | isRef 0<br>minOcc 0<br>maxOcc 1<br>content complex   |
| children   | <a href="#">ESGExistingThematicCharacteristics</a> <a href="#">EnvironmentalThematicCharacteristics</a> <a href="#">SocialThematicCharacteristics</a><br><a href="#">GovernanceThematicCharacteristics</a> <a href="#">SustainableDevelopmentGoals</a> |
| annotation | documentation<br>This part describes investment strategy, and is not linked to Taxonomy<br>20260 - 20300   |

element **EETReportType1.1/ESG\_ThematicInvestingDescription/ESGExistingThematicCharacteristics**

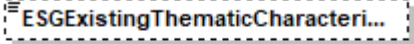
|            |  |
|------------|--|
| diagram    |  <p>20260_Financial_Instrument_ESG_Existing_Thematic<br/>Does this Financial_Instrument incorporate ESG factors through ESG thematic approach ?</p> |
| type       | <a href="#">EETYesNoType</a>   |
| properties | isRef 0<br>minOcc 0<br>maxOcc 1<br>content simple  |
| facets     | Kind Value annotation<br>length 1  |
| annotation | documentation<br>20260_Financial_Instrument_ESG_Existing_Thematic<br>Does this Financial_Instrument incorporate ESG factors through ESG thematic approach ?  |

element **EETReportType1.1/ESG\_ThematicInvestingDescription/EnvironmentalThematicCharacteristics**

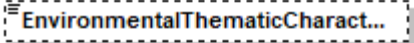
|            |  |
|------------|--|
| diagram    |  <p>20270_Financial_Instrument_Environmental_Thematic<br/>Description of the product environment thematic investment strategy, according to SFDR art 2(17). Multiple answers fields.<br/>A - energy<br/>B - renewable energy<br/>C - raw materials<br/>D - water and land<br/>E - waste<br/>F - greenhouse gas emissions<br/>G - biodiversity<br/>H - circular economy<br/>I - environment other<br/>J - none</p> |
| type       | <b>xs:string</b>   |
| properties | isRef 0<br>minOcc 0<br>maxOcc 1<br>content simple  |
| annotation | documentation<br>20270_Financial_Instrument_Environmental_Thematic<br>Description of the product environment thematic investment strategy, according to SFDR art 2(17). Multiple answers fields.<br>A - energy<br>B - renewable energy<br>C - raw materials<br>D - water and land<br>E - waste   |

|  |   |
|--|---|
|  | F - greenhouse gas emissions<br>G - biodiversity<br>H - circular economy<br>I - environment other<br>J - none |
|--|---|

element **EETReportType1.1/ESG\_ThematicInvestingDescription/SocialThematicCharacteristics**

|            |  |
|------------|--|
| diagram    |  <b>SocialThematicCharacteristics</b><br>20280_Financial_Instrument_Social_Thematic<br>Description of the product social thematic investment strategy, according to SFDR art 2(17)<br>Multiple answers fields.<br>A - inequality<br>B - social cohesion,<br>C - social integration<br>D - labour relations<br>E - investment in human capital<br>F - economically or socially disadvantaged communities<br>G - social other<br>H - none |
| type       | <b>xs:string</b>   |
| properties | isRef 0<br>minOcc 0<br>maxOcc 1<br>content simple  |
| annotation | documentation<br>20280_Financial_Instrument_Social_Thematic<br>Description of the product social thematic investment strategy, according to SFDR art 2(17)<br>Multiple answers fields.<br>A - inequality<br>B - social cohesion,<br>C - social integration<br>D - labour relations<br>E - investment in human capital<br>F - economically or socially disadvantaged communities<br>G - social other<br>H - none  |

element **EETReportType1.1/ESG\_ThematicInvestingDescription/GovernanceThematicCharacteristics**

|            |  |
|------------|--|
| diagram    |  <b>GovernanceThematicCharacteri...</b><br>20290_Financial_Instrument_Governance_Thematic<br>Description of the product thematic investment strategy, according to SFDR art 2(17)<br>Multiple answers field<br>A - sound management structures<br>B - employee relations<br>C - remuneration of staff<br>D - tax compliance<br>E - governance other<br>F - none |
| type       | <b>xs:string</b>   |
| properties | isRef 0<br>minOcc 0<br>maxOcc 1<br>content simple  |

|            |   |
|------------|---|
| annotation | documentation<br>20290_Financial_Instrument_Governance_Thematic<br>Description of the product thematic investment strategy, according to SFDR art 2(17)<br>Multiple answers field<br>A - sound management structures<br>B - employee relations<br>C - remuneration of staff<br>D - tax compliance<br>E - governance other<br>F - none |
|------------|---|

element **EETReportType1.1/ESG\_ThematicInvestingDescription/SustainableDevelopmentGoals**

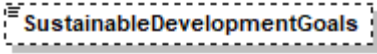
|            |   |
|------------|---|
| diagram    |  <p>20300_Financial_Instrument_Alignment_With_Sustainable_Development_Goals<br/> Alignment with SDG means that SDG are used in the investment process (screening) or targeted by the fund. Multiple answers field.</p> <ul style="list-style-type: none"> <li>1 - No Poverty</li> <li>2 - Zero Hunger</li> <li>3 - Good Health and Well-Being</li> <li>4 - Quality Education</li> <li>5 - Gender Equality</li> <li>6 - Clean Water and Sanitation</li> <li>7 - Affordable and Clean Energy</li> <li>8 - Decent Work and Economic Growth</li> <li>9 - Industry, Innovation and Infrastructure</li> <li>10 - Reduced Inequality</li> <li>11 - Sustainable Cities and Communities</li> <li>12 - Responsible Consumption and Production</li> <li>13 - Climate Action</li> <li>14 - Life Below Water</li> <li>15 - Life on Land</li> <li>16 - Peace and Justice, Strong Institutions</li> <li>17 - Partnerships to achieve to Goal</li> </ul> |
| type       | <b>xs:string</b>  |
| properties | isRef 0<br>minOcc 0<br>maxOcc 1<br>content simple   |
| annotation | documentation<br>20300_Financial_Instrument_Alignment_With_Sustainable_Development_Goals<br>Alignment with SDG means that SDG are used in the investment process (screening) or targeted by the fund. Multiple answers field. <ul style="list-style-type: none"> <li>1 - No Poverty</li> <li>2 - Zero Hunger</li> <li>3 - Good Health and Well-Being</li> <li>4 - Quality Education</li> <li>5 - Gender Equality</li> <li>6 - Clean Water and Sanitation</li> <li>7 - Affordable and Clean Energy</li> <li>8 - Decent Work and Economic Growth</li> <li>9 - Industry, Innovation and Infrastructure</li> <li>10 - Reduced Inequality</li> <li>11 - Sustainable Cities and Communities</li> <li>12 - Responsible Consumption and Production</li> <li>13 - Climate Action</li> <li>14 - Life Below Water</li> <li>15 - Life on Land</li> <li>16 - Peace and Justice, Strong Institutions</li> <li>17 - Partnerships to achieve to Goal</li> </ul>   |

element **EETReportType1.1/ESG\_EngagementCoverage**

|            |  |
|------------|--|
| diagram    | <p><b>EligibleIssuers</b> +</p> <p>20310_Financial_Instrument_Weight_Of_Eligible_Issuers<br/>20320_Financial_Instrument_Number_Of_Eligible_Issuers</p> <p><b>ESG_CoveredIssuers</b> +</p> <p>20330_Financial_Instrument_Weight_Of_ESG_Covered_Issuers<br/>20340_Financial_Instrument_Number_Of_ESG_Covered_Issuers</p> <p><b>EngagedIssuers</b> +</p> <p>20350_Financial_Instrument_Weight_Of_Engaged_Issuers<br/>20360_Financial_Instrument_Number_Of_Engaged_Issuers</p> |
| properties | <p>isRef 0<br/>minOcc 0<br/>maxOcc 1<br/>content complex</p>   |
| children   | <p><a href="#">EligibleIssuers</a> <a href="#">ESG_CoveredIssuers</a> <a href="#">EngagedIssuers</a></p>   |
| annotation | <p>documentation<br/>20310 - 20360</p>   |

element **EETReportType1.1/ESG\_EngagementCoverage/EligibleIssuers**

|            |   |
|------------|---|
| diagram    | <p><b>EligibleIssuers</b> +</p> <p>20310_Financial_Instrument_Weight_Of_Eligible_Issuers<br/>20320_Financial_Instrument_Number_Of_Eligible_Issuers</p> <p><b>EETWeightNumberType1.1</b></p> <p><b>Weight</b></p> <p><b>Number</b></p> |
| type       | <p><a href="#">EETWeightNumberType1.1</a></p>   |
| properties | <p>isRef 0<br/>minOcc 0<br/>maxOcc 1<br/>content complex</p>  |
| children   | <p><a href="#">Weight</a> <a href="#">Number</a></p>  |
| annotation | <p>documentation<br/>20310_Financial_Instrument_Weight_Of_Eligible_Issuers<br/>20320_Financial_Instrument_Number_Of_Eligible_Issuers</p>  |



element **EETReportType1.1/ESG\_EngagementCoverage/ESG\_CoveredIssuers**

|            |   |
|------------|---|
| diagram    | <p>20330_Financial_Instrument_Weight_Of_ESG_Covered_Issuers<br/>20340_Financial_Instrument_Number_Of_ESG_Covered_Issuers</p>          |
| type       | <a href="#">EETWeightNumberType1.1</a>  |
| properties | isRef 0<br>minOcc 0<br>maxOcc 1<br>content complex  |
| children   | <a href="#">Weight</a> <a href="#">Number</a>   |
| annotation | documentation<br>20330_Financial_Instrument_Weight_Of_ESG_Covered_Issuers<br>20340_Financial_Instrument_Number_Of_ESG_Covered_Issuers |

element **EETReportType1.1/ESG\_EngagementCoverage/EngagedIssuers**

|            |   |
|------------|---|
| diagram    | <p>20350_Financial_Instrument_Weight_Of_Engaged_Issuers<br/>20360_Financial_Instrument_Number_Of_Engaged_Issuers</p>          |
| type       | <a href="#">EETWeightNumberType1.1</a>  |
| properties | isRef 0<br>minOcc 0<br>maxOcc 1<br>content complex  |
| children   | <a href="#">Weight</a> <a href="#">Number</a>   |
| annotation | documentation<br>20350_Financial_Instrument_Weight_Of_Engaged_Issuers<br>20360_Financial_Instrument_Number_Of_Engaged_Issuers |

element **EETReportType1.1/ESG\_Benchmark**

|            |   |
|------------|---|
| diagram    | <p>The diagram illustrates the structure of the <b>ESG_Benchmark</b> element. It consists of a dashed box labeled <b>ESG_Benchmark</b> (20370 - 20380) containing a solid box labeled <b>HasReference_ESG_Benchmark</b> (20370_Financial_Instrument_Has_A_Reference_ESG_Benchmark). The <b>HasReference_ESG_Benchmark</b> box contains the text: "Has a reference benchmark been designated for the purpose of attaining the environmental or social characteristics promoted by the financial product?". Below this box is another dashed box labeled <b>BenchmarkName</b> (20380_Financial_Instrument_Benchmark_Name) containing the text: "Identification of benchmark".</p> |
| properties | <p>isRef 0<br/> minOcc 0<br/> maxOcc 1<br/> content complex</p>   |
| children   | <a href="#">HasReference_ESG_Benchmark</a> <a href="#">BenchmarkName</a>  |
| annotation | <p>documentation<br/> 20370 - 20380</p>   |

element **EETReportType1.1/ESG\_Benchmark/HasReference\_ESG\_Benchmark**

|            |   |
|------------|---|
| diagram    | <p>The diagram shows the <b>HasReference_ESG_Benchmark</b> element (20370_Financial_Instrument_Has_A_Reference_ESG_Benchmark) with the text: "Has a reference benchmark been designated for the purpose of attaining the environmental or social characteristics promoted by the financial product?".</p> |
| type       | <a href="#">EETYesNoType</a>  |
| properties | <p>isRef 0<br/> content simple</p>  |
| facets     | <p>Kind Value annotation<br/> length 1</p>  |
| annotation | <p>documentation<br/> 20370_Financial_Instrument_Has_A_Reference_ESG_Benchmark<br/> Has a reference benchmark been designated for the purpose of attaining the environmental or social characteristics promoted by the financial product?</p>   |

element **EETReportType1.1/ESG\_Benchmark/BenchmarkName**

|            |   |
|------------|---|
| diagram    | <p>The diagram shows the <b>BenchmarkName</b> element (20380_Financial_Instrument_Benchmark_Name) with the text: "Identification of benchmark".</p> |
| type       | <b>xs:string</b>  |
| properties | <p>isRef 0<br/> minOcc 0<br/> maxOcc 1<br/> content simple</p>  |
| annotation | <p>documentation<br/> 20380_Financial_Instrument_Benchmark_Name<br/> Identification of benchmark</p>  |

element **EETReportType1.1/MinimumSustainableInvestments**

|                   |  |
|-------------------|--|
| <p>diagram</p>    | <p><b>Minimum Sustainable Investme...</b><br/>20390 - 20470</p> <ul style="list-style-type: none"> <li><b>MinimumAssetAllocationDate</b><br/>20390_Financial_Instrument_Minimum_Or_Planned_Asset_Allocation_Date<br/>The date to which the disclosure refer</li> <li><b>MinimumInvestmentsWithEnvir...</b><br/>20400_Financial_Instrument_EU_SFDR_Minimum_Or_Planned_Investments_With_Environmental_Or_Social_Characteristics</li> <li><b>MethodologyForSustainableInve...</b><br/>20410_Financial_Instrument_EU_SFDR_Methodology_For_Sustainable_Investments_Calculation<br/>Revenue(R), Capex(C), Opex(O), other approach(A)</li> <li><b>MinimumInvestmentsSustainab...</b><br/>20420_Financial_Instrument_EU_SFDR_Minimum_Or_Planned_Investments_Sustainable_Investments</li> <li><b>MinimumOtherInvestmentsWith...</b><br/>20430_Financial_Instrument_EU_SFDR_Minimum_Or_Planned_Other_Investments_With_Environmental_Or_Social_Characteristics</li> <li><b>MinimumInvestmentsSustainab...</b><br/>20440_Financial_Instrument_EU_SFDR_Minimum_Or_Planned_Investments_Sustainable_Investments_Environmental</li> <li><b>MinimumInvestmentsSustainab...</b><br/>20450_Financial_Instrument_EU_SFDR_Minimum_Or_Planned_Investments_Sustainable_Investments_Taxonomy_Aligned</li> <li><b>MinimumInvestmentsSustainab...</b><br/>20460_Financial_Instrument_EU_SFDR_Minimum_Or_Planned_Investments_Sustainable_Investments_Other_Environmental</li> <li><b>MinimumInvestmentsSustainab...</b><br/>20470_Financial_Instrument_EU_SFDR_Minimum_Or_Planned_Investments_Sustainable_Investments_Social</li> </ul> |
| <p>properties</p> | <p>isRef 0<br/>minOcc 0<br/>maxOcc 1<br/>content complex</p>   |
| <p>children</p>   | <p><a href="#">MinimumAssetAllocationDate</a> <a href="#">MinimumInvestmentsWithEnvironmentalOrSocialCharacteristics</a> <a href="#">MethodologyForSustainableInvestmentsCalculation</a> <a href="#">MinimumInvestmentsSustainableInvestments</a> <a href="#">MinimumOtherInvestmentsWithEnvironmentalOrSocialCharacteristics</a> <a href="#">MinimumInvestmentsSustainableInvestmentsEnvironmental</a> <a href="#">MinimumInvestmentsSustainableInvestmentsTaxonomyAligned</a> <a href="#">MinimumInvestmentsSustainableInvestmentsOtherEnvironmental</a> <a href="#">MinimumInvestmentsSustainableInvestmentsSocial</a></p>  |

|            |                                |
|------------|--------------------------------|
| annotation | documentation<br>20390 - 20470 |
|------------|--------------------------------|

element **EETReportType1.1/MinimumSustainableInvestments/MinimumAssetAllocationDate**

|            |   |
|------------|---|
| diagram    |  <p>20390_Financial_Instrument_Minimum_Or_Planned_Asset_Allocation_Date<br/>The date to which the disclosure refer</p> |
| type       | <b>xs:date</b>  |
| properties | isRef 0<br>content simple   |
| annotation | documentation<br>20390_Financial_Instrument_Minimum_Or_Planned_Asset_Allocation_Date<br>The date to which the disclosure refer  |

element **EETReportType1.1/MinimumSustainableInvestments/MinimumInvestmentsWithEnvironmentalOrSocialCharacteristics**

|            |   |
|------------|---|
| diagram    |  <p>20400_Financial_Instrument_EU_SFDR_Minimum_Or_Planned_Investments_With_Environmental_Or_Social_Characteristics</p> |
| type       | <a href="#">PercentageType</a>  |
| properties | isRef 0<br>minOcc 0<br>maxOcc 1<br>content simple   |
| annotation | documentation<br>20400_Financial_Instrument_EU_SFDR_Minimum_Or_Planned_Investments_With_Environmental_Or_Social_Characteristics   |

element **EETReportType1.1/MinimumSustainableInvestments/MethodologyForSustainableInvestmentsCalculation**

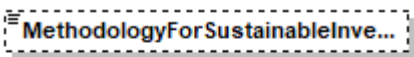
|            |  |
|------------|--|
| diagram    |  <p>20410_Financial_Instrument_EU_SFDR_Methodology_For_Sustainable_Investments_Calculation<br/>Revenue(R), Capex(C), Opex(O), other approach(A)</p> |
| type       | restriction of <b>xs:string</b>  |
| properties | isRef 0<br>minOcc 0<br>maxOcc 1<br>content simple  |
| annotation | documentation<br>20410_Financial_Instrument_EU_SFDR_Methodology_For_Sustainable_Investments_Calculation<br>Revenue(R), Capex(C), Opex(O), other approach(A)  |

element

**EETReportType1.1/MinimumSustainableInvestments/MinimumInvestmentsSustainableInvestments**

|            |  |
|------------|--|
| diagram    |  <b>MinimumInvestmentsSustainab...</b><br>20420_Financial_Instrument_EU_SFDR_Minimum_Or_Planned_Investments_Sustainable_Investments |
| type       | <a href="#">PercentageType</a>   |
| properties | isRef 0<br>minOcc 0<br>maxOcc 1<br>content simple  |
| annotation | documentation<br>20420_Financial_Instrument_EU_SFDR_Minimum_Or_Planned_Investments_Sustainable_Investments   |

element

**EETReportType1.1/MinimumSustainableInvestments/MinimumOtherInvestmentsWithEnvironmentalOrSocialCharacteristics**

|            |   |
|------------|---|
| diagram    |  <b>MinimumOtherInvestmentsWith...</b><br>20430_Financial_Instrument_EU_SFDR_Minimum_Or_Planned_Other_Investments_With_Environmental_Or_Social_Characteristics |
| type       | <a href="#">PercentageType</a>  |
| properties | isRef 0<br>minOcc 0<br>maxOcc 1<br>content simple   |
| annotation | documentation<br>20430_Financial_Instrument_EU_SFDR_Minimum_Or_Planned_Other_Investments_With_Environmental_Or_Social_Characteristics   |

element

**EETReportType1.1/MinimumSustainableInvestments/MinimumInvestmentsSustainableInvestmentsEnvironmental**

|            |  |
|------------|--|
| diagram    |  <b>MinimumInvestmentsSustainab...</b><br>20440_Financial_Instrument_EU_SFDR_Minimum_Or_Planned_Investments_Sustainable_Investments_Environmental |
| type       | <a href="#">PercentageType</a>   |
| properties | isRef 0<br>minOcc 0<br>maxOcc 1<br>content simple  |
| annotation | documentation<br>20440_Financial_Instrument_EU_SFDR_Minimum_Or_Planned_Investments_Sustainable_Investments_Environmental   |

element

**EETReportType1.1/MinimumSustainableInvestments/MinimumInvestmentsSustainableInvestmentsTaxonomyAligned**

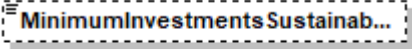
|            |   |
|------------|---|
| diagram    | <br>20450_Financial_Instrument_EU_SFDR_Minimum_Or_Planned_Investments_Sustainable_Investments_Taxonomy_Aligned |
| type       | <a href="#">PercentageType</a>  |
| properties | isRef 0<br>minOcc 0<br>maxOcc 1<br>content simple   |
| annotation | documentation<br>20450_Financial_Instrument_EU_SFDR_Minimum_Or_Planned_Investments_Sustainable_Investments_Taxonomy_Aligned   |

element

**EETReportType1.1/MinimumSustainableInvestments/MinimumInvestmentsSustainableInvestmentsOtherEnvironmental**

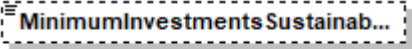
|            |  |
|------------|--|
| diagram    | <br>20460_Financial_Instrument_EU_SFDR_Minimum_Or_Planned_Investments_Sustainable_Investments_Other_Environmental |
| type       | <a href="#">PercentageType</a>   |
| properties | isRef 0<br>minOcc 0<br>maxOcc 1<br>content simple  |
| annotation | documentation<br>20460_Financial_Instrument_EU_SFDR_Minimum_Or_Planned_Investments_Sustainable_Investments_Other_Environmental   |

element

**EETReportType1.1/MinimumSustainableInvestments/MinimumInvestmentsSustainableInvestmentsSocial**

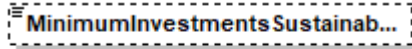
|            |   |
|------------|---|
| diagram    | <br>20470_Financial_Instrument_EU_SFDR_Minimum_Or_Planned_Investments_Sustainable_Investments_Social |
| type       | <a href="#">PercentageType</a>  |
| properties | isRef 0<br>minOcc 0<br>maxOcc 1<br>content simple   |
| annotation | documentation<br>20470_Financial_Instrument_EU_SFDR_Minimum_Or_Planned_Investments_Sustainable_Investments_Social   |

element **EETReportType1.1/LastReportedSustainableInvestments**

|                   |   |
|-------------------|---|
| <p>diagram</p>    | <p><b>LastReportedSustainableInves...</b><br/>20480 - 20560</p> <ul style="list-style-type: none"> <li><b>LastReportedAssetAllocationDate</b><br/>20480_Financial_Instrument_Last_Reported_Asset_Allocation_Date<br/>The date to which the disclosure refer</li> <li><b>LastReportedInvestmentsWithE...</b><br/>20490_Financial_Instrument_EU_SFDR_Last_Reported_Investments_With_Environmental_Or_Social_Characteristics</li> <li><b>LastReportedInvestmentsNotSu...</b><br/>20500_Financial_Instrument_EU_SFDR_Last_Reported_Investments_Not_Sustainable_Other</li> <li><b>LastReportedInvestments Susta...</b><br/>20510_Financial_Instrument_EU_SFDR_Last_Reported_Investments_Are_Sustainable_Investments</li> <li><b>LastReportedOtherInvestments...</b><br/>20520_Financial_Instrument_EU_SFDR_Last_Reported_Other_Investments_With_Environmental_Or_Social_Characteristics</li> <li><b>LastReportedInvestments Susta...</b><br/>20530_Financial_Instrument_EU_SFDR_Last_Reported_Investments_Are_Sustainable_Investments_Environmental</li> <li><b>LastReportedInvestments Susta...</b><br/>20540_Financial_Instrument_EU_SFDR_Last_Reported_Investments_Are_Sustainable_Investments_Taxonomy_Aligned</li> <li><b>LastReportedInvestments Susta...</b><br/>20550_Financial_Instrument_EU_SFDR_Last_Reported_Investments_Are_Sustainable_Investments_Other_Environmental</li> <li><b>LastReportedInvestments Susta...</b><br/>20560_Financial_Instrument_EU_SFDR_Last_Reported_Investments_Are_Sustainable_Investments_Social</li> </ul> |
| <p>properties</p> | <p>isRef 0<br/>minOcc 0<br/>maxOcc 1<br/>content complex</p>  |
| <p>children</p>   | <p><a href="#">LastReportedAssetAllocationDate</a> <a href="#">LastReportedInvestmentsWithEnvironmentalOrSocialCharacteristics</a><br/> <a href="#">LastReportedInvestmentsNotSustainableOther</a> <a href="#">LastReportedInvestmentsSustainableInvestments</a><br/> <a href="#">LastReportedOtherInvestmentsWithEnvironmentalOrSocialCharacteristics</a><br/> <a href="#">LastReportedInvestmentsSustainableInvestmentsEnvironmental</a><br/> <a href="#">LastReportedInvestmentsSustainableInvestmentsTaxonomyAligned</a><br/> <a href="#">LastReportedInvestmentsSustainableInvestmentsOtherEnvironmental</a><br/> <a href="#">LastReportedInvestmentsSustainableInvestmentsSocial</a></p>  |
| <p>annotation</p> | <p>documentation<br/>20480 - 20560</p>  |

element **EETReportType1.1/LastReportedSustainableInvestments/LastReportedAssetAllocationDate**

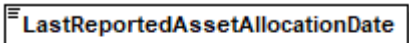
|            |  |
|------------|--|
| diagram    |  <p>20480_Financial_Instrument_Last_Reported_Asset_Allocation_Date<br/>The date to which the disclosure refer</p> |
| type       | <b>xs:date</b>   |
| properties | isRef 0<br>content simple  |
| annotation | documentation<br>20480_Financial_Instrument_Last_Reported_Asset_Allocation_Date<br>The date to which the disclosure refer  |

element **EETReportType1.1/LastReportedSustainableInvestments/LastReportedInvestmentsWithEnvironmentalOrSocialCharacteristics**

|            |  |
|------------|--|
| diagram    |  <p>20490_Financial_Instrument_EU_SFDR_Last_Reported_Investments_With_Environmental_Or_Social_Characteristics</p> |
| type       | <a href="#">PercentageType</a>   |
| properties | isRef 0<br>minOcc 0<br>maxOcc 1<br>content simple  |
| annotation | documentation<br>20490_Financial_Instrument_EU_SFDR_Last_Reported_Investments_With_Environmental_Or_Social_Characteristics   |

element **EETReportType1.1/LastReportedSustainableInvestments/LastReportedInvestmentsNotSustainableOther**

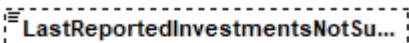
|            |   |
|------------|---|
| diagram    |  <p>20500_Financial_Instrument_EU_SFDR_Last_Reported_Investments_Not_Sustainable_Other</p> |
| type       | <a href="#">PercentageType</a>  |
| properties | isRef 0<br>minOcc 0<br>maxOcc 1<br>content simple   |
| annotation | documentation<br>20500_Financial_Instrument_EU_SFDR_Last_Reported_Investments_Not_Sustainable_Other   |



element

**EETReportType1.1/LastReportedSustainableInvestments/LastReportedInvestmentsSustainableInvestments**

|            |   |
|------------|---|
| diagram    |  <b>LastReportedInvestments Susta...</b><br>20510_Financial_Instrument_EU_SFDR_Last_Reported_Investments_Are_Sustainable_Investments |
| type       | <a href="#">PercentageType</a>  |
| properties | isRef 0<br>minOcc 0<br>maxOcc 1<br>content simple   |
| annotation | documentation<br>20510_Financial_Instrument_EU_SFDR_Last_Reported_Investments_Are_Sustainable_Investments   |

element

**EETReportType1.1/LastReportedSustainableInvestments/LastReportedOtherInvestmentsWithEnvironmentalOrSocialCharacteristics**

|            |   |
|------------|---|
| diagram    |  <b>LastReportedOtherInvestments...</b><br>20520_Financial_Instrument_EU_SFDR_Last_Reported_Other_Investments_With_Environmental_Or_Social_Characteristics |
| type       | <a href="#">PercentageType</a>  |
| properties | isRef 0<br>minOcc 0<br>maxOcc 1<br>content simple   |
| annotation | documentation<br>20520_Financial_Instrument_EU_SFDR_Last_Reported_Other_Investments_With_Environmental_Or_Social_Characteristics  |

element

**EETReportType1.1/LastReportedSustainableInvestments/LastReportedInvestmentsSustainableInvestmentsEnvironmental**

|            |   |
|------------|---|
| diagram    |  <b>LastReportedInvestments Susta...</b><br>20530_Financial_Instrument_EU_SFDR_Last_Reported_Investments_Are_Sustainable_Investments_Environmental |
| type       | <a href="#">PercentageType</a>  |
| properties | isRef 0<br>minOcc 0<br>maxOcc 1<br>content simple   |
| annotation | documentation<br>20530_Financial_Instrument_EU_SFDR_Last_Reported_Investments_Are_Sustainable_Investments_Environmental   |

element

**EETReportType1.1/LastReportedSustainableInvestments/LastReportedInvestmentsSustainableInvestmentsTaxonomyAligned**

|            |  |
|------------|--|
| diagram    |  <b>LastReportedInvestments Susta...</b><br>20540_Financial_Instrument_EU_SFDR_Last_Reported_Investments_Are_Sustainable_Investments_Taxonomy_Aligned |
| type       | <a href="#">PercentageType</a>   |
| properties | isRef 0<br>minOcc 0<br>maxOcc 1<br>content simple  |
| annotation | documentation<br>20540_Financial_Instrument_EU_SFDR_Last_Reported_Investments_Are_Sustainable_Investments_Taxonomy_Aligned   |

element

**EETReportType1.1/LastReportedSustainableInvestments/LastReportedInvestmentsSustainableInvestmentsOtherEnvironmental**

|            |   |
|------------|---|
| diagram    |  <b>LastReportedInvestments Susta...</b><br>20550_Financial_Instrument_EU_SFDR_Last_Reported_Investments_Are_Sustainable_Investments_Other_Environmental |
| type       | <a href="#">PercentageType</a>  |
| properties | isRef 0<br>minOcc 0<br>maxOcc 1<br>content simple   |
| annotation | documentation<br>20550_Financial_Instrument_EU_SFDR_Last_Reported_Investments_Are_Sustainable_Investments_Other_Environmental   |

element

**EETReportType1.1/LastReportedSustainableInvestments/LastReportedInvestmentsSustainableInvestmentsSocial**

|            |  |
|------------|--|
| diagram    |  <b>LastReportedInvestments Susta...</b><br>20560_Financial_Instrument_EU_SFDR_Last_Reported_Investments_Are_Sustainable_Investments_Social |
| type       | <a href="#">PercentageType</a>   |
| properties | isRef 0<br>minOcc 0<br>maxOcc 1<br>content simple  |
| annotation | documentation<br>20560_Financial_Instrument_EU_SFDR_Last_Reported_Investments_Are_Sustainable_Investments_Social   |

element **EETReportType1.1/AdditionalInfoArt9**

|            |   |
|------------|---|
| diagram    |   |
| properties | isRef 0<br>minOcc 0<br>maxOcc 1<br>content complex  |
| children   | <a href="#">ObjectiveReductionInCarbonEmissions</a> <a href="#">AlignedWithParisAgreement</a> |
| annotation | documentation<br>20570 - 20580  |

element **EETReportType1.1/AdditionalInfoArt9/ObjectiveReductionInCarbonEmissions**

|            |   |
|------------|---|
| diagram    |   |
| type       | <a href="#">EETYesNoType</a>  |
| properties | isRef 0<br>minOcc 0<br>maxOcc 1<br>content simple   |
| facets     | Kind Value annotation<br>length 1   |
| annotation | documentation<br>20570_Financial_Instrument_With_Objective_Of_A_Reduction_In_Carbon_Emissions<br>Does the Financial Instrument have the objective of reduction in carbon emissions? |

element **EETReportType1.1/AdditionalInfoArt9/AlignedWithParisAgreement**

|            |   |
|------------|---|
| diagram    |   |
| type       | <a href="#">EETYesNoType</a>  |
| properties | isRef 0<br>minOcc 0<br>maxOcc 1<br>content simple   |
| facets     | Kind Value annotation<br>length 1   |
| annotation | documentation<br>20580_Financial_Instrument_Aligned_With_Paris_Agreement<br>Is the Financial Instrument Aligned with the Paris Agreement? |

element **EETReportType1.1/MiFID\_IDD\_TargetMarket**

|            |  |
|------------|--|
| diagram    | <p>MiFID_IDD_TargetMarket 20590</p> <p>End_Client_Sustainability_Prefe...</p> <p>MIFID: COMMISSION DELEGATED REGULATION (EU) 2021/1253 Art. 1<br/>IDD: COMMISSION DELEGATED DIRECTIVE (EU) 2021/1257 Art. 2</p> <p>answer = Yes or Neutral</p> |
| properties | isRef 0<br>content complex   |
| children   | <a href="#">End Client Sustainability Preferences Considered</a>   |
| annotation | documentation<br>20590   |

element

**EETReportType1.1/MiFID\_IDD\_TargetMarket/End\_Client\_Sustainability\_Preferences\_Considered**

| diagram    | <p>End_Client_Sustainability_Prefe...</p> <p>MIFID: COMMISSION DELEGATED REGULATION (EU) 2021/1253 Art. 1<br/>IDD: COMMISSION DELEGATED DIRECTIVE (EU) 2021/1257 Art. 2</p> <p>answer = Yes or Neutral</p>                      |            |       |            |           |   |  |           |   |  |
|------------|---|------------|-------|------------|-----------|---|--|-----------|---|--|
| type       | <a href="#">EETYesNeutralType</a>   |            |       |            |           |   |  |           |   |  |
| properties | isRef 0<br>content simple   |            |       |            |           |   |  |           |   |  |
| facets     | <table border="1"> <thead> <tr> <th>Kind</th> <th>Value</th> <th>annotation</th> </tr> </thead> <tbody> <tr> <td>minLength</td> <td>1</td> <td></td> </tr> <tr> <td>maxLength</td> <td>7</td> <td></td> </tr> </tbody> </table> | Kind       | Value | annotation | minLength | 1 |  | maxLength | 7 |  |
| Kind       | Value   | annotation |       |            |           |   |  |           |   |  |
| minLength  | 1   |            |       |            |           |   |  |           |   |  |
| maxLength  | 7   |            |       |            |           |   |  |           |   |  |
| annotation | documentation<br>MIFID: COMMISSION DELEGATED REGULATION (EU) 2021/1253 Art. 1<br>IDD: COMMISSION DELEGATED DIRECTIVE (EU) 2021/1257 Art. 2  |            |       |            |           |   |  |           |   |  |
|            | answer = Yes or Neutral   |            |       |            |           |   |  |           |   |  |

element **EETReportType1.1/TaxonomyAlignedInvestments**

diagram

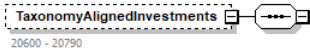

- MinimumInvestmentsEUTaxono...**

20600\_Financial\_Instrument\_Minimum\_Percentage\_Investments\_Aligned\_EU\_Taxonomy\_Incl\_Sovereign\_Bonds
- MinimumInvestmentsEUTaxono...**

20610\_Financial\_Instrument\_Minimum\_Percentage\_Investments\_Aligned\_EU\_Taxonomy\_Excl\_Sovereign\_Bonds
- SubjectToExternalReviewByThir...**

20620\_Financial\_Instrument\_Was\_This\_Statement\_Subject\_To\_An\_External\_Review\_By\_Third\_Party
- MethodologyUsedForAlignment...**

20630\_Financial\_Instrument\_Methodology\_Used\_For\_Alignment\_Calculation\_With\_EU\_Taxonomy

Discusses the methodology used for alignment calculation with the EU Taxonomy, defined as either Revenue (R), CapEx (C) or OpEx (O)
- MinimumShareOfTransitionalAc...**

20640\_Financial\_Instrument\_Minimum\_Share\_Of\_Transitional\_Activities
- MinimumShareOfEnablingActivit...**

20650\_Financial\_Instrument\_Minimum\_Share\_Of\_Enabling\_Activities
- TaxonomyAlignedInclSovereign...**

20660\_Financial\_Instrument\_Percentage\_Taxonomy\_Aligned\_Incl\_Sovereign\_Revenue
- TaxonomyAlignedInclSovereign...**

20670\_Financial\_Instrument\_Percentage\_Taxonomy\_Aligned\_Incl\_Sovereign\_Capex
- TaxonomyAlignedInclSovereign...**

20680\_Financial\_Instrument\_Percentage\_Taxonomy\_Aligned\_Incl\_Sovereign\_Opex
- TaxonomyAlignedExclSovereign...**

20690\_Financial\_Instrument\_Percentage\_Taxonomy\_Aligned\_Excl\_Sovereign\_Revenue
- TaxonomyAlignedExclSovereign...**

20700\_Financial\_Instrument\_Percentage\_Taxonomy\_Aligned\_Excl\_Sovereign\_Capex
- TaxonomyAlignedExclSovereign...**

20710\_Financial\_Instrument\_Percentage\_Taxonomy\_Aligned\_Excl\_Sovereign\_Opex
- ClimateChangeMitigationPercen...**

20721\_Financial\_Instrument\_Climate\_Change\_Mitigation of Art 55 paragraph 1a
- ClimateChangeAdaptationPerce...**

20731\_Financial\_Instrument\_Climate\_Change\_Adaptation of Art 55 paragraph 1a
- SustainableUseAndProtectionOf...**

20741\_Financial\_Instrument\_Sustainable\_Use\_And\_Protection\_Of\_Water\_And\_Marine\_Resources of Art 55 paragraph 1a
- TransitionToCircularEconomyPe...**

20751\_Financial\_Instrument\_Transition\_To\_A\_Circular\_Economy of Art 55 paragraph 1a
- PollutionPreventionAndControl...**

20761\_Financial\_Instrument\_Pollution\_Prevention\_And\_Control of Art 55 paragraph 1a
- ProtectionAndRestorationOfBio...**

20771\_Financial\_Instrument\_Protection\_And\_Restoration\_Of\_Biodiversity\_And\_Ecosystems of Art 55 paragraph 1a
- ShareOfTransitionalActivities**

20780\_Financial\_Instrument\_Share\_Of\_Transitional\_Activities
- ShareOfEnablingActivities**

20790\_Financial\_Instrument\_Share\_Of\_Enabling\_Activities

|            |   |
|------------|---|
| properties | isRef 0<br>minOcc 0<br>maxOcc 1<br>content complex  |
| children   | <a href="#">MinimumInvestmentsEUTaxonomy_InclSovereignBonds</a> <a href="#">MinimumInvestmentsEUTaxonomy_ExclSovereignBonds</a> <a href="#">SubjectToExternalReviewByThirdParty_MethodologyUsedForAlignmentCalculationWith_EU_Taxonomy_MinimumShareOfTransitionalActivities_MinimumShareOfEnablingActivities</a> <a href="#">TaxonomyAlignedInclSovereignRevenue</a> <a href="#">TaxonomyAlignedInclSovereignCapex</a> <a href="#">TaxonomyAlignedInclSovereignOpex</a> <a href="#">TaxonomyAlignedExclSovereignRevenue</a> <a href="#">TaxonomyAlignedExclSovereignCapex</a> <a href="#">TaxonomyAlignedExclSovereignOpex</a> <a href="#">ClimateChangeMitigationPercentage</a> <a href="#">ClimateChangeAdaptationPercentage</a> <a href="#">SustainableUseAndProtectionOfWaterAndMarineResourcesPercentage</a> <a href="#">TransitionToCircularEconomyPercentage</a> <a href="#">PollutionPreventionAndControlPercentage</a> <a href="#">ProtectionAndRestorationOfBiodiversityAndEcosystemsPercentage</a> <a href="#">ShareOfTransitionalActivities</a> <a href="#">ShareOfEnablingActivities</a> |
| annotation | documentation<br>20600 - 20790  |

element

**EETReportType1.1/TaxonomyAlignedInvestments/MinimumInvestmentsEUTaxonomy\_InclSovereignBonds**

|            |  |
|------------|--|
| diagram    |  <b>MinimumInvestmentsEUTaxono...</b><br>20600_Financial_Instrument_Minimum_Percentage_Investments_Aligned_EU_Taxonomy_Incl_Sovereign_Bonds |
| type       | <b>xs:decimal</b>  |
| properties | isRef 0<br>minOcc 0<br>maxOcc 1<br>content simple  |
| annotation | documentation<br>20600_Financial_Instrument_Minimum_Percentage_Investments_Aligned_EU_Taxonomy_Incl_Sovereign_Bonds  |

element

**EETReportType1.1/TaxonomyAlignedInvestments/MinimumInvestmentsEUTaxonomy\_ExclSovereignBonds**

|            |  |
|------------|--|
| diagram    |  <b>MinimumInvestmentsEUTaxono...</b><br>20610_Financial_Instrument_Minimum_Percentage_Investments_Aligned_EU_Taxonomy_Excl_Sovereign_Bonds |
| type       | <b>xs:decimal</b>  |
| properties | isRef 0<br>minOcc 0<br>maxOcc 1<br>content simple  |
| annotation | documentation<br>20610_Financial_Instrument_Minimum_Percentage_Investments_Aligned_EU_Taxonomy_Excl_Sovereign_Bonds  |

element **EETReportType1.1/TaxonomyAlignedInvestments/SubjectToExternalReviewByThirdParty**

|            |   |
|------------|---|
| diagram    |   |
| type       | <b>EETYesNoType</b>   |
| properties | isRef 0<br>minOcc 0<br>maxOcc 1<br>content simple   |
| facets     | Kind Value annotation<br>length 1   |
| annotation | documentation<br>20620_Financial_Instrument_Was_This_Statement_Subject_To_An_External_Review_By_Third_Party |

element **EETReportType1.1/TaxonomyAlignedInvestments/MethodologyUsedForAlignmentCalculationWith\_EU\_Taxonomy**

|            |  |
|------------|--|
| diagram    |  |
| type       | restriction of <b>xs:string</b>  |
| properties | isRef 0<br>minOcc 0<br>maxOcc 1<br>content simple  |
| annotation | documentation<br>20630_Financial_Instrument_Methodology_Used_For_Alignment_Calculation_With_EU_Taxonomy<br>Discloses the methodology used for alignment calculation with the EU Taxonomy, defined as either Revenue (R), CapEx (C) or OpEx (O) |

element **EETReportType1.1/TaxonomyAlignedInvestments/MinimumShareOfTransitionalActivities**

|            |  |
|------------|--|
| diagram    |  |
| type       | <b>xs:decimal</b>  |
| properties | isRef 0<br>minOcc 0<br>maxOcc 1<br>content simple                                    |
| annotation | documentation<br>20640_Financial_Instrument_Minimum_Share_Of_Transitional_Activities |

element **EETReportType1.1/TaxonomyAlignedInvestments/MinimumShareOfEnablingActivities**

|            |   |
|------------|---|
| diagram    |  <b>Minimum ShareOfEnablingActivit...</b><br>20650_Financial_Instrument_Minimum_Share_Of_Enabling_Activities |
| type       | <b>xs:decimal</b>   |
| properties | isRef 0<br>minOcc 0<br>maxOcc 1<br>content simple   |
| annotation | documentation<br>20650_Financial_Instrument_Minimum_Share_Of_Enabling_Activities  |

element **EETReportType1.1/TaxonomyAlignedInvestments/TaxonomyAlignedInclSovereignRevenue**

|            |   |
|------------|---|
| diagram    |  <b>TaxonomyAlignedInclSovereign...</b><br>20660_Financial_Instrument_Percentage_Taxonomy_Aligned_Incl_Sovereign_Revenue |
| type       | <b>xs:decimal</b>   |
| properties | isRef 0<br>minOcc 0<br>maxOcc 1<br>content simple   |
| annotation | documentation<br>20660_Financial_Instrument_Percentage_Taxonomy_Aligned_Incl_Sovereign_Revenue  |

element **EETReportType1.1/TaxonomyAlignedInvestments/TaxonomyAlignedInclSovereignCapex**

|            |   |
|------------|---|
| diagram    |  <b>TaxonomyAlignedInclSovereign...</b><br>20670_Financial_Instrument_Percentage_Taxonomy_Aligned_Incl_Sovereign_Capex |
| type       | <b>xs:decimal</b>   |
| properties | isRef 0<br>minOcc 0<br>maxOcc 1<br>content simple   |
| annotation | documentation<br>20670_Financial_Instrument_Percentage_Taxonomy_Aligned_Incl_Sovereign_Capex  |

element **EETReportType1.1/TaxonomyAlignedInvestments/TaxonomyAlignedInclSovereignOpex**

|            |  |
|------------|--|
| diagram    |  <b>TaxonomyAlignedInclSovereign...</b><br>20680_Financial_Instrument_Percentage_Taxonomy_Aligned_Incl_Sovereign_Opex |
| type       | <b>xs:decimal</b>  |
| properties | isRef 0<br>minOcc 0<br>maxOcc 1<br>content simple  |
| annotation | documentation<br>20680_Financial_Instrument_Percentage_Taxonomy_Aligned_Incl_Sovereign_Opex  |



element **EETReportType1.1/TaxonomyAlignedInvestments/TaxonomyAlignedExclSovereignRevenue**

|            |   |
|------------|---|
| diagram    |  <b>TaxonomyAlignedExclSovereign...</b><br>20690_Financial_Instrument_Percentage_Taxonomy_Aligned_Excl_Sovereign_Revenue |
| type       | <b>xs:decimal</b>   |
| properties | isRef 0<br>minOcc 0<br>maxOcc 1<br>content simple   |
| annotation | documentation<br>20690_Financial_Instrument_Percentage_Taxonomy_Aligned_Excl_Sovereign_Revenue  |

element **EETReportType1.1/TaxonomyAlignedInvestments/TaxonomyAlignedExclSovereignCapex**

|            |   |
|------------|---|
| diagram    |  <b>TaxonomyAlignedExclSovereign...</b><br>20700_Financial_Instrument_Percentage_Taxonomy_Aligned_Excl_Sovereign_Capex |
| type       | <b>xs:decimal</b>   |
| properties | isRef 0<br>minOcc 0<br>maxOcc 1<br>content simple   |
| annotation | documentation<br>20700_Financial_Instrument_Percentage_Taxonomy_Aligned_Excl_Sovereign_Capex  |

element **EETReportType1.1/TaxonomyAlignedInvestments/TaxonomyAlignedExclSovereignOpex**

|            |  |
|------------|--|
| diagram    |  <b>TaxonomyAlignedExclSovereign...</b><br>20710_Financial_Instrument_Percentage_Taxonomy_Aligned_Excl_Sovereign_Opex |
| type       | <b>xs:decimal</b>  |
| properties | isRef 0<br>minOcc 0<br>maxOcc 1<br>content simple  |
| annotation | documentation<br>20710_Financial_Instrument_Percentage_Taxonomy_Aligned_Excl_Sovereign_Opex  |

element **EETReportType1.1/TaxonomyAlignedInvestments/ClimateChangeMitigationPercentage**

|            |  |
|------------|--|
| diagram    |  <b>ClimateChangeMitigationPercen...</b><br>20721_Financial_Instrument_Climate_Change_Mitigation_of_Art_55_paragraph_1a |
| type       | <b>EETYesNoType</b>  |
| properties | isRef 0<br>minOcc 0<br>maxOcc 1<br>content simple  |

|            |  |
|------------|--|
| facets     | Kind Value annotation<br>length 1  |
| annotation | documentation<br>20721_Financial_Instrument_Climate_Change_Mitigation of Art 55 paragraph 1a |

element **EETReportType1.1/TaxonomyAlignedInvestments/ClimateChangeAdaptationPercentage**

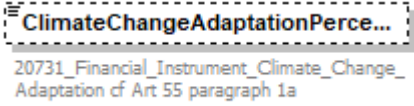
|            |  |
|------------|--|
| diagram    |             |
| type       | <a href="#">EETYesNoType</a>   |
| properties | isRef 0<br>minOcc 0<br>maxOcc 1<br>content simple  |
| facets     | Kind Value annotation<br>length 1  |
| annotation | documentation<br>20731_Financial_Instrument_Climate_Change_Adaptation of Art 55 paragraph 1a |

element

**EETReportType1.1/TaxonomyAlignedInvestments/SustainableUseAndProtectionOfWaterAndMarineResourcesPercentage**

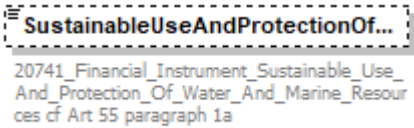
|            |   |
|------------|---|
| diagram    |    |
| type       | <a href="#">EETYesNoType</a>  |
| properties | isRef 0<br>minOcc 0<br>maxOcc 1<br>content simple   |
| facets     | Kind Value annotation<br>length 1   |
| annotation | documentation<br>20741_Financial_Instrument_Sustainable_Use_And_Protection_Of_Water_And_Marine_Resources of Art 55 paragraph 1a |

element **EETReportType1.1/TaxonomyAlignedInvestments/TransitionToCircularEconomyPercentage**

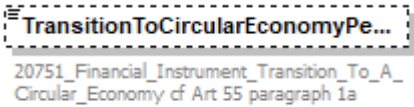
|         |   |
|---------|---|
| diagram |  |
| type    | <a href="#">EETYesNoType</a>  |

|            |   |
|------------|---|
| properties | isRef 0<br>minOcc 0<br>maxOcc 1<br>content simple   |
| facets     | Kind Value annotation<br>length 1   |
| annotation | documentation<br>20751_Financial_Instrument_Transition_To_A_Circular_Economy of Art 55 paragraph 1a |

element **EETReportType1.1/TaxonomyAlignedInvestments/PollutionPreventionAndControlPercentage**

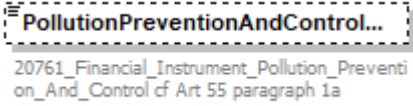
|            |   |
|------------|---|
| diagram    |                    |
| type       | <a href="#">EETYesNoType</a>  |
| properties | isRef 0<br>minOcc 0<br>maxOcc 1<br>content simple   |
| facets     | Kind Value annotation<br>length 1   |
| annotation | documentation<br>20761_Financial_Instrument_Pollution_Prevention_And_Control of Art 55 paragraph 1a |

element

**EETReportType1.1/TaxonomyAlignedInvestments/ProtectionAndRestorationOfBiodiversityAndEcosystemsPercentage**

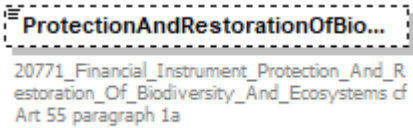
|            |  |
|------------|--|
| diagram    |   |
| type       | <a href="#">EETYesNoType</a>   |
| properties | isRef 0<br>minOcc 0<br>maxOcc 1<br>content simple  |
| facets     | Kind Value annotation<br>length 1  |
| annotation | documentation<br>20771_Financial_Instrument_Protection_And_Restoration_Of_Biodiversity_And_Ecosystems of Art 55 paragraph 1a |

element **EETReportType1.1/TaxonomyAlignedInvestments/ShareOfTransitionalActivities**

|         |   |
|---------|---|
| diagram |  |
|---------|---|

|            |  |
|------------|--|
| type       | <b>xs:decimal</b>  |
| properties | isRef 0<br>minOcc 0<br>maxOcc 1<br>content simple                            |
| annotation | documentation<br>20780_Financial_Instrument_Share_Of_Transitional_Activities |

element **EETReportType1.1/TaxonomyAlignedInvestments/ShareOfEnablingActivities**

|            |  |
|------------|--|
| diagram    |  |
| type       | <b>xs:decimal</b>  |
| properties | isRef 0<br>minOcc 0<br>maxOcc 1<br>content simple                        |
| annotation | documentation<br>20790_Financial_Instrument_Share_Of_Enabling_Activities |

element **EETReportType1.1/PrincipalAdverseIndicators**



|            |  |
|------------|--|
| properties | isRef 0<br>minOcc 0<br>maxOcc 1<br>content complex   |
| children   | <a href="#">PAI PAIReferencDate ClimateAndEnvironmentRelatedIndicators SocialAndEmployeeMatters SovereignAndSupranationalInvestments RealEstateInvestments MoreClimateAndEnvironmentRelatedIndicators MoreSocialAndEmployeeMatters</a> |
| annotation | documentation<br>30000 - 33440   |

element **EETReportType1.1/PrincipalAdverseIndicators/PAI**

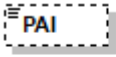
|            |   |
|------------|---|
| diagram    |  <p>30000_ this field is no more used dont fill in</p> |
| type       | <b>xs:date</b>  |
| properties | isRef 0<br>minOcc 0<br>maxOcc 1<br>content simple   |
| annotation | documentation<br>30000_ this field is no more used dont fill in   |

element **EETReportType1.1/PrincipalAdverseIndicators/PAIReferencDate**

|            |   |
|------------|---|
| diagram    |  <p>30010_PA I_ Reference_ Date<br/>Date to which data refer</p> |
| type       | <b>xs:date</b>  |
| properties | isRef 0<br>content simple   |
| annotation | documentation<br>30010_PA I_ Reference_ Date<br>Date to which data refer  |

element **EETReportType1.1/PrincipalAdverseIndicators/ClimateAndEnvironmentRelatedIndicators**

|                   |  |
|-------------------|--|
| <p>diagram</p>    |  |
| <p>properties</p> | <p>isRef 0<br/>minOcc 0<br/>maxOcc 1<br/>content complex</p>   |
| <p>children</p>   | <p><a href="#">GreenhousegasEmissions</a> <a href="#">CarbonFootprintScope12</a> <a href="#">CarbonFootprintScope123</a><br/><a href="#">GHG_IntensityOfInvesteeCompaniesScope12</a> <a href="#">GHG_IntensityOfInvesteeCompaniesScope123</a><br/><a href="#">ExposureToCompaniesActiveInTheFossilFuelSector</a> <a href="#">EnergyConsumptionFromNonRenewableSources</a><br/><a href="#">EnergyProductionFromNonRenewableSources</a> <a href="#">EnergyConsumptionIntensityPerHighImpactClimateSector</a><br/><a href="#">ActivitiesNegativelyAffectingBiodiversitySensitiveAreas</a> <a href="#">WaterEmissions</a> <a href="#">HazardousWaste</a></p> |
| <p>annotation</p> | <p>documentation<br/>30020 - 30970</p>   |

element

**EETReportType1.1/PrincipalAdverseIndicators/ClimateAndEnvironmentRelatedIndicators/GreenhousegasEmissions**

|            |  |
|------------|--|
| diagram    |  |
| properties | <p>isRef 0<br/> minOcc 0<br/> maxOcc 1<br/> content complex</p>  |
| children   | <p><a href="#">Scope1</a> <a href="#">Scope2</a> <a href="#">Scope3</a> <a href="#">TotalScope12</a> <a href="#">TotalScope123</a></p> |
| annotation | <p>documentation<br/> 30020 - 30210</p>  |

element

**EETReportType1.1/PrincipalAdverseIndicators/ClimateAndEnvironmentRelatedIndicators/GreenhousegasEmissions/Scope1**

|            |   |
|------------|---|
| diagram    |   |
| type       | <p><a href="#">ValueStrategyCoverageType1.1</a></p>             |
| properties | <p>isRef 0<br/> minOcc 0<br/> maxOcc 1<br/> content complex</p> |

|            |  |
|------------|--|
| children   | <a href="#">Value</a> <a href="#">ConsideredInInvestmentStrategy</a> <a href="#">Coverage</a> <a href="#">EligibleAssets</a> |
| annotation | documentation<br>30020 - 30050   |

element

**EETReportType1.1/PrincipalAdverseIndicators/ClimateAndEnvironmentRelatedIndicators/GreenhousegasEmissions/Scope2**

|            |  |
|------------|--|
| diagram    |  |
| type       | <a href="#">ValueStrategyCoverageType1.1</a>   |
| properties | isRef 0<br>minOcc 0<br>maxOcc 1<br>content complex   |
| children   | <a href="#">Value</a> <a href="#">ConsideredInInvestmentStrategy</a> <a href="#">Coverage</a> <a href="#">EligibleAssets</a> |
| annotation | documentation<br>30060 - 30090   |



element

### EETReportType1.1/PrincipalAdverseIndicators/ClimateAndEnvironmentRelatedIndicators/GreenhousegasEmissions/Scope3

|            |  |
|------------|--|
| diagram    |  |
| type       | <a href="#">ValueStrategyCoverageType1.1</a>   |
| properties | isRef 0<br>minOcc 0<br>maxOcc 1<br>content complex   |
| children   | <a href="#">Value</a> <a href="#">ConsideredInInvestmentStrategy</a> <a href="#">Coverage</a> <a href="#">EligibleAssets</a> |
| annotation | documentation<br>30100 - 30130   |

element

### EETReportType1.1/PrincipalAdverseIndicators/ClimateAndEnvironmentRelatedIndicators/GreenhousegasEmissions/TotalScope12

|         |  |
|---------|--|
| diagram |  |
|---------|--|

|            |  |
|------------|--|
| type       | <a href="#">ValueStrategyCoverageType1.1</a>   |
| properties | isRef 0<br>minOcc 0<br>maxOcc 1<br>content complex   |
| children   | <a href="#">Value</a> <a href="#">ConsideredInInvestmentStrategy</a> <a href="#">Coverage</a> <a href="#">EligibleAssets</a> |
| annotation | documentation<br>30140 - 30170   |

element

**EETReportType1.1/PrincipalAdverseIndicators/ClimateAndEnvironmentRelatedIndicators/GreenhousegasEmissions/TotalScope123**

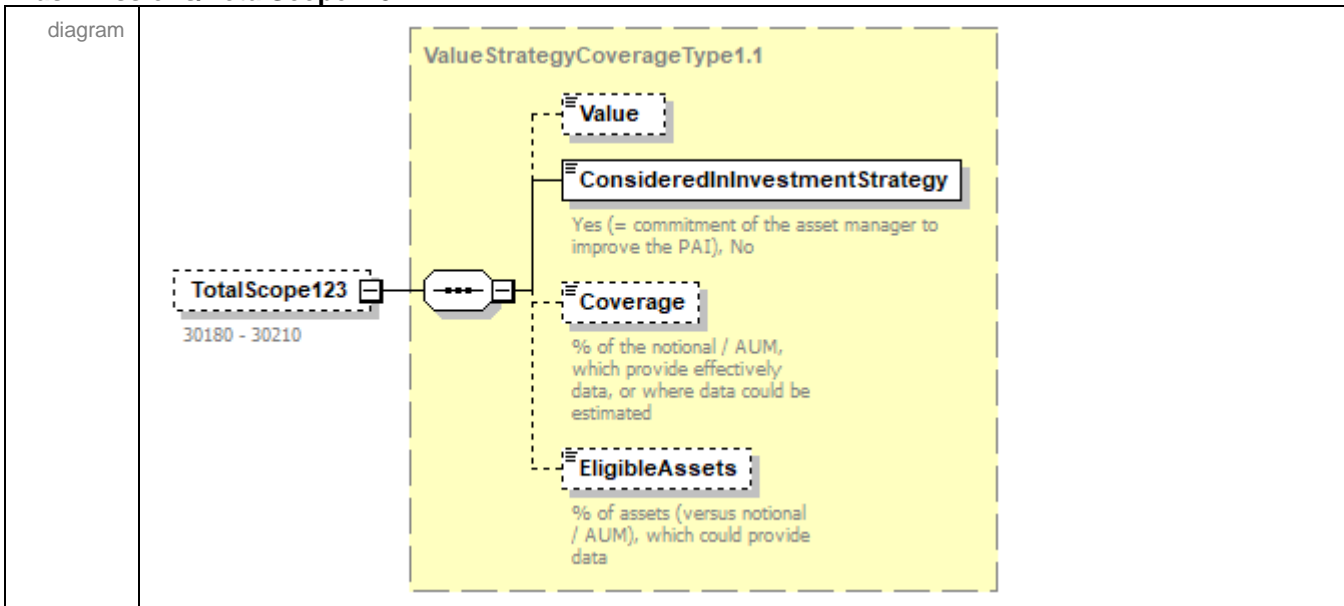

|            |  |
|------------|--|
| type       | <a href="#">ValueStrategyCoverageType1.1</a>   |
| properties | isRef 0<br>minOcc 0<br>maxOcc 1<br>content complex   |
| children   | <a href="#">Value</a> <a href="#">ConsideredInInvestmentStrategy</a> <a href="#">Coverage</a> <a href="#">EligibleAssets</a> |
| annotation | documentation<br>30180 - 30210   |

element

### EETReportType1.1/PrincipalAdverseIndicators/ClimateAndEnvironmentRelatedIndicators/CarbonFootprintScope12

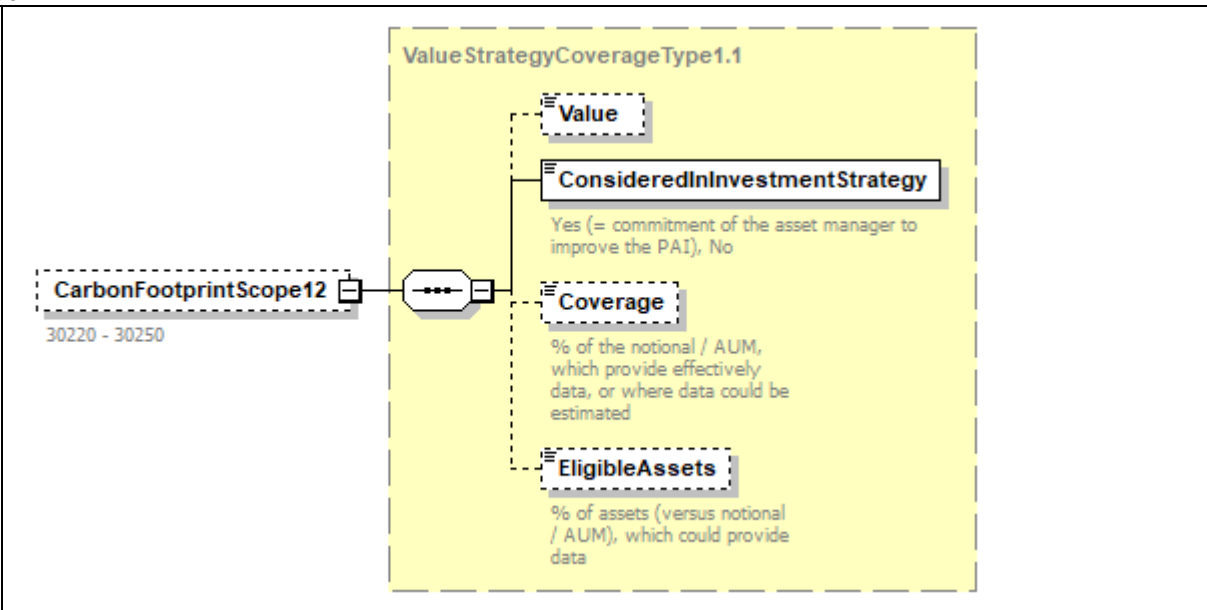
|            |  |
|------------|--|
| diagram    |    |
| type       | <a href="#">ValueStrategyCoverageType1.1</a>   |
| properties | isRef 0<br>minOcc 0<br>maxOcc 1<br>content complex   |
| children   | <a href="#">Value</a> <a href="#">ConsideredInInvestmentStrategy</a> <a href="#">Coverage</a> <a href="#">EligibleAssets</a> |
| annotation | documentation<br>30220 - 30250   |

element

### EETReportType1.1/PrincipalAdverseIndicators/ClimateAndEnvironmentRelatedIndicators/CarbonFootprintScope123

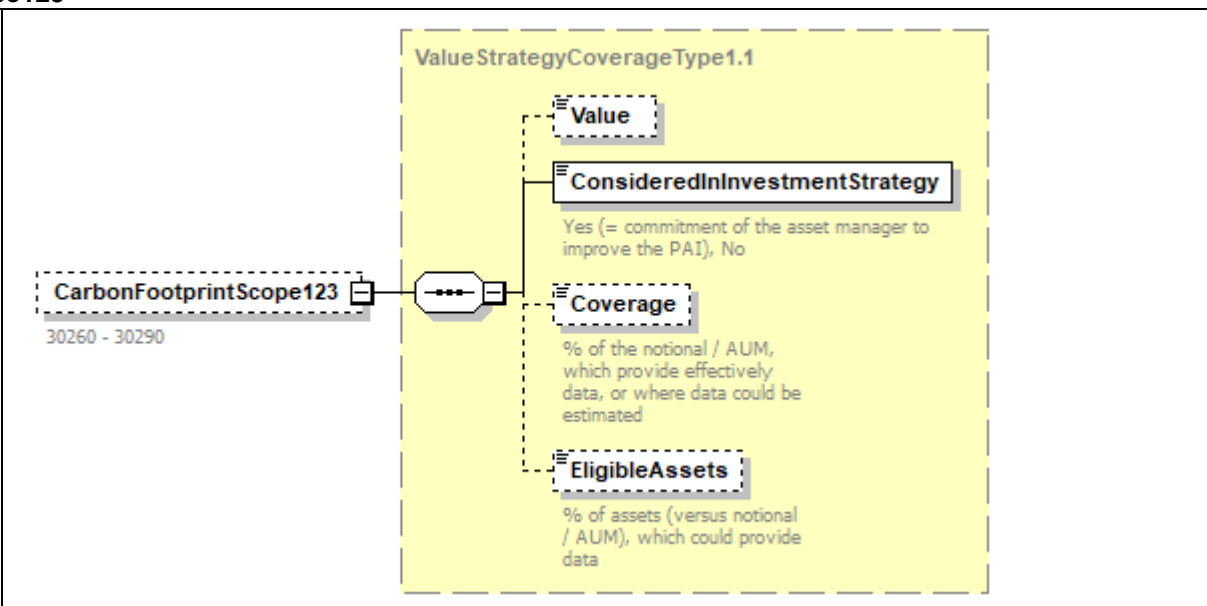
|         |  |
|---------|--|
| diagram |  |
|---------|--|

|            |  |
|------------|--|
| type       | <a href="#">ValueStrategyCoverageType1.1</a>   |
| properties | isRef 0<br>minOcc 0<br>maxOcc 1<br>content complex   |
| children   | <a href="#">Value</a> <a href="#">ConsideredInInvestmentStrategy</a> <a href="#">Coverage</a> <a href="#">EligibleAssets</a> |
| annotation | documentation<br>30260 - 30290   |

element

**EETReportType1.1/PrincipalAdverseIndicators/ClimateAndEnvironmentRelatedIndicators/GHG\_IntensityOfInvesteeCompaniesScope12**

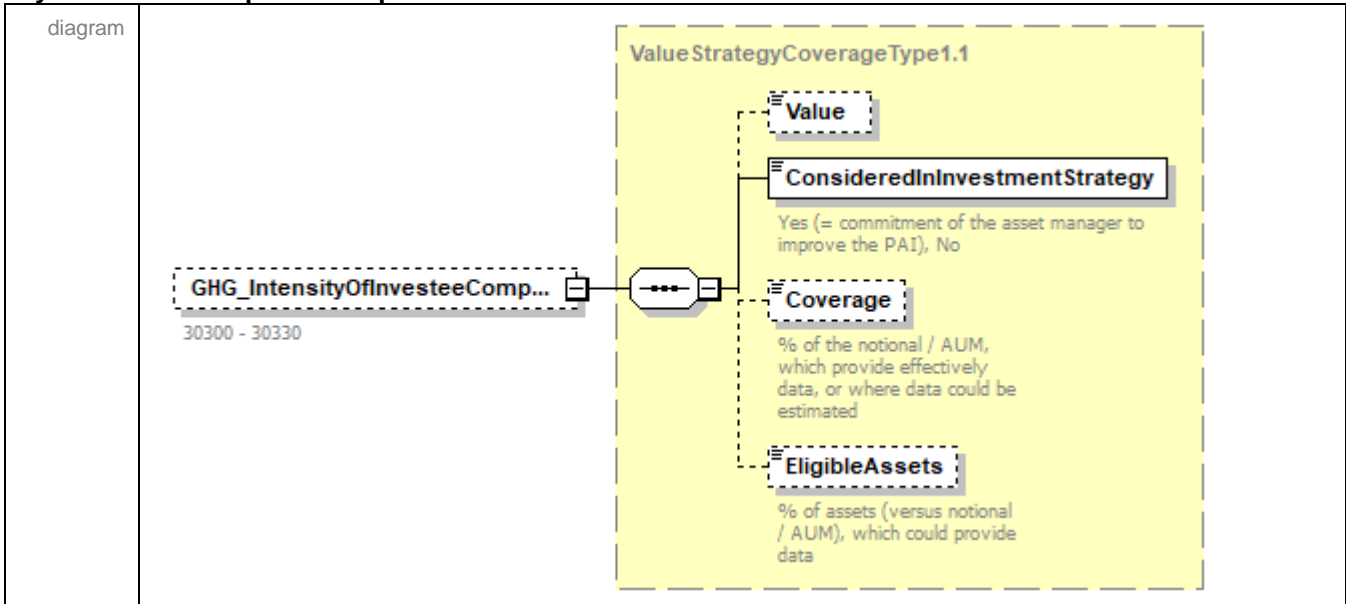

|            |  |
|------------|--|
| type       | <a href="#">ValueStrategyCoverageType1.1</a>   |
| properties | isRef 0<br>minOcc 0<br>maxOcc 1<br>content complex   |
| children   | <a href="#">Value</a> <a href="#">ConsideredInInvestmentStrategy</a> <a href="#">Coverage</a> <a href="#">EligibleAssets</a> |
| annotation | documentation<br>30300 - 30330   |

element

**EETReportType1.1/PrincipalAdverseIndicators/ClimateAndEnvironmentRelatedIndicators/GHG\_IntensityOfInvesteeCompaniesScope123**

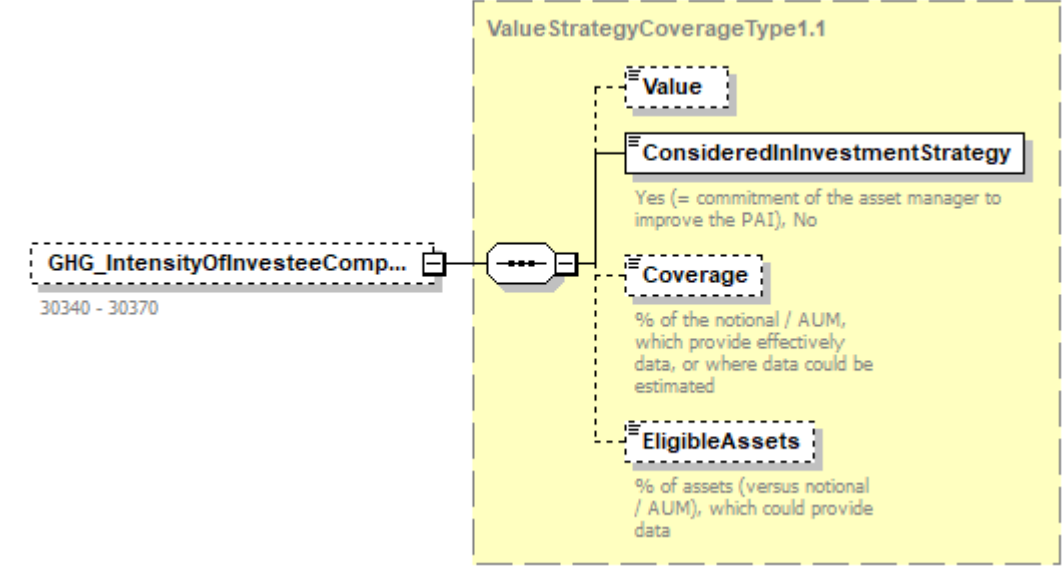
|            |  |
|------------|--|
| diagram    |  <p>The diagram shows a dashed box on the left labeled "GHG_IntensityOfInvesteeComp..." with the range "30340 - 30370". This box is connected to a central connector box, which in turn connects to a larger dashed box on the right labeled "ValueStrategyCoverageType1.1". Inside this larger box, there are three sub-sections: "Value", "ConsideredInInvestmentStrategy" (with a description: "Yes (= commitment of the asset manager to improve the PAI), No"), "Coverage" (with a description: "% of the notional / AUM, which provide effectively data, or where data could be estimated"), and "EligibleAssets" (with a description: "% of assets (versus notional / AUM), which could provide data").</p> |
| type       | <a href="#">ValueStrategyCoverageType1.1</a>   |
| properties | isRef 0<br>minOcc 0<br>maxOcc 1<br>content complex   |
| children   | <a href="#">Value</a> <a href="#">ConsideredInInvestmentStrategy</a> <a href="#">Coverage</a> <a href="#">EligibleAssets</a>   |
| annotation | documentation<br>30340 - 30370   |

element

**EETReportType1.1/PrincipalAdverseIndicators/ClimateAndEnvironmentRelatedIndicators/ExposureToCompaniesActiveInTheFossilFuelSector**

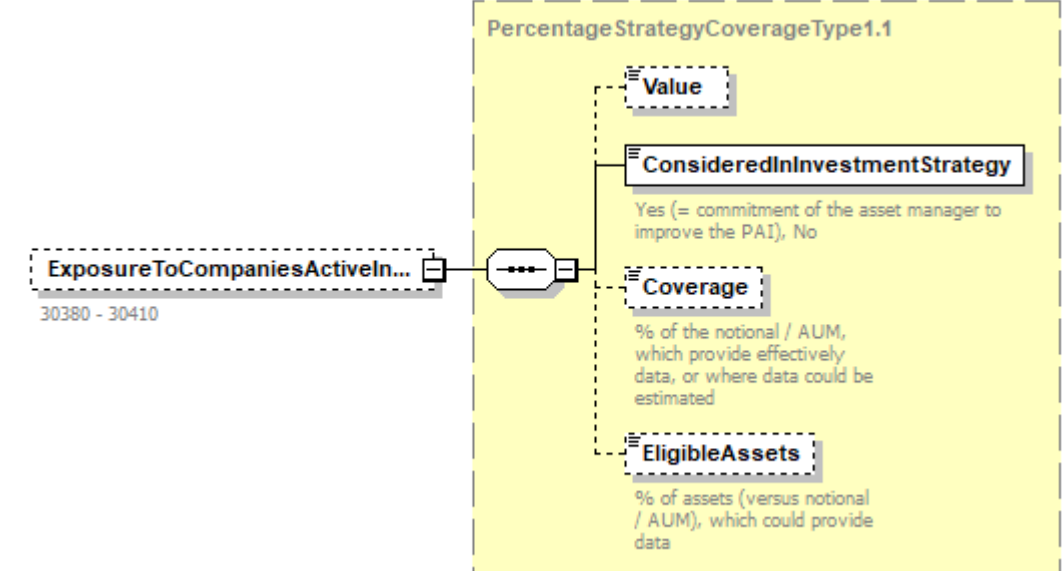
|         |   |
|---------|---|
| diagram |  <p>The diagram shows a dashed box on the left labeled "ExposureToCompaniesActiveIn..." with the range "30380 - 30410". This box is connected to a central connector box, which in turn connects to a larger dashed box on the right labeled "PercentageStrategyCoverageType1.1". Inside this larger box, there are three sub-sections: "Value", "ConsideredInInvestmentStrategy" (with a description: "Yes (= commitment of the asset manager to improve the PAI), No"), "Coverage" (with a description: "% of the notional / AUM, which provide effectively data, or where data could be estimated"), and "EligibleAssets" (with a description: "% of assets (versus notional / AUM), which could provide data").</p> |
|---------|---|

|            |  |
|------------|--|
| type       | <a href="#">PercentageStrategyCoverageType1.1</a>  |
| properties | isRef 0<br>minOcc 0<br>maxOcc 1<br>content complex   |
| children   | <a href="#">Value</a> <a href="#">ConsideredInInvestmentStrategy</a> <a href="#">Coverage</a> <a href="#">EligibleAssets</a> |
| annotation | documentation<br>30380 - 30410   |

element

**EETReportType1.1/PrincipalAdverseIndicators/ClimateAndEnvironmentRelatedIndicators/EnergyConsumptionFromNonRenewableSources**

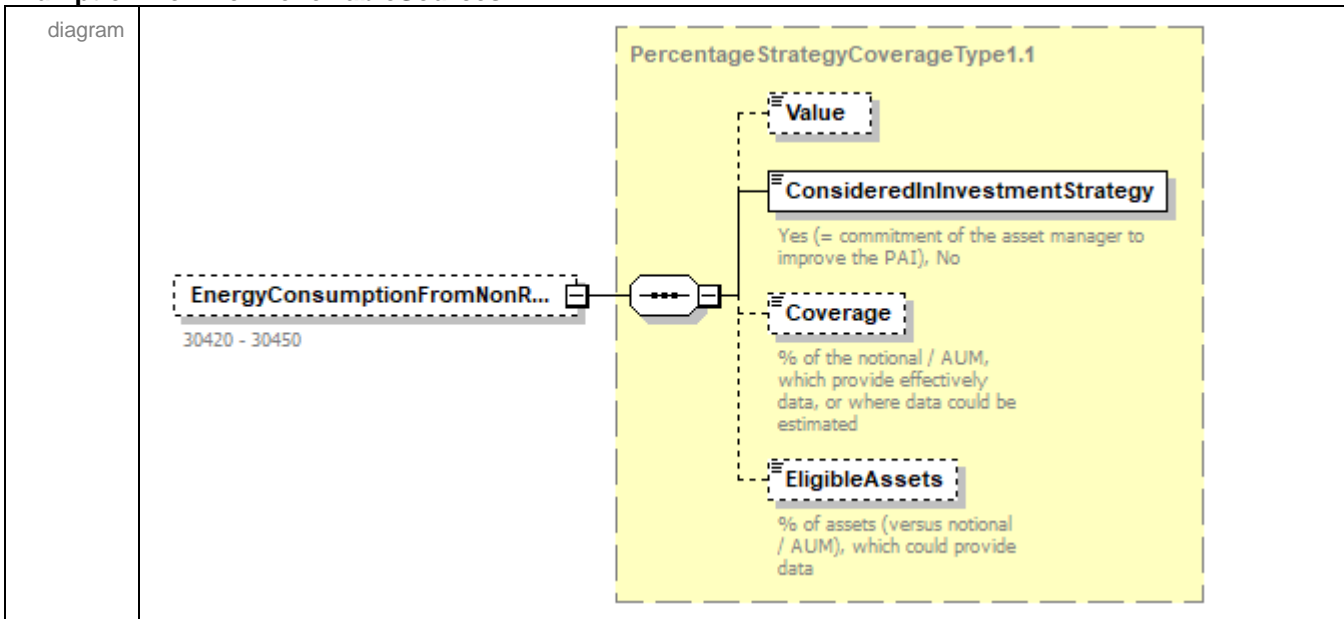

|            |  |
|------------|--|
| type       | <a href="#">PercentageStrategyCoverageType1.1</a>  |
| properties | isRef 0<br>minOcc 0<br>maxOcc 1<br>content complex   |
| children   | <a href="#">Value</a> <a href="#">ConsideredInInvestmentStrategy</a> <a href="#">Coverage</a> <a href="#">EligibleAssets</a> |
| annotation | documentation<br>30420 - 30450   |

element

**EETReportType1.1/PrincipalAdverseIndicators/ClimateAndEnvironmentRelatedIndicators/EnergyProductionFromNonRenewableSources**

|                   |   |
|-------------------|---|
| <p>diagram</p>    |   |
| <p>type</p>       | <p><a href="#">PercentageStrategyCoverageType1.1</a></p>  |
| <p>properties</p> | <p>isRef 0<br/>minOcc 0<br/>maxOcc 1<br/>content complex</p>  |
| <p>children</p>   | <p><a href="#">Value</a> <a href="#">ConsideredInInvestmentStrategy</a> <a href="#">Coverage</a> <a href="#">EligibleAssets</a></p> |
| <p>annotation</p> | <p>documentation<br/>30460 - 30490</p>  |

element

**EETReportType1.1/PrincipalAdverseIndicators/ClimateAndEnvironmentRelatedIndicators/EnergyConsumptionIntensityPerHighImpactClimateSector**

|                   |  |
|-------------------|--|
| <p>diagram</p>    |  |
| <p>properties</p> | <p>isRef 0<br/>minOcc 0<br/>maxOcc 1<br/>content complex</p> |
| <p>children</p>   | <p><a href="#">NACE_Values</a></p>                           |
| <p>annotation</p> | <p>documentation<br/>30500 - 30850</p>                       |

element

**EETReportType1.1/PrincipalAdverseIndicators/ClimateAndEnvironmentRelatedIndicators/EnergyConsumptionIntensityPerHighImpactClimateSector/NACE\_Values**

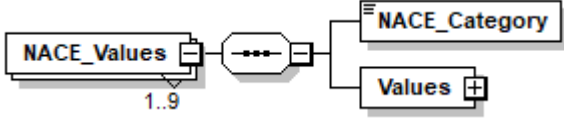
|            |   |
|------------|---|
| diagram    |  <p>The diagram shows a box labeled 'NACE_Values' with a multiplicity of '1..9'. This box is connected to a container box containing two sub-elements: 'NACE_Category' and 'Values'.</p> |
| properties | isRef 0<br>minOcc 1<br>maxOcc 9<br>content complex  |
| children   | <a href="#">NACE_Category</a> <a href="#">Values</a>  |

element

**EETReportType1.1/PrincipalAdverseIndicators/ClimateAndEnvironmentRelatedIndicators/EnergyConsumptionIntensityPerHighImpactClimateSector/NACE\_Values/NACE\_Category**

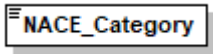
|            |  |
|------------|--|
| diagram    |  <p>The diagram shows a single box labeled 'NACE_Category'.</p> |
| type       | restriction of xs:string   |
| properties | isRef 0<br>content simple  |

element

**EETReportType1.1/PrincipalAdverseIndicators/ClimateAndEnvironmentRelatedIndicators/EnergyConsumptionIntensityPerHighImpactClimateSector/NACE\_Values/Values**

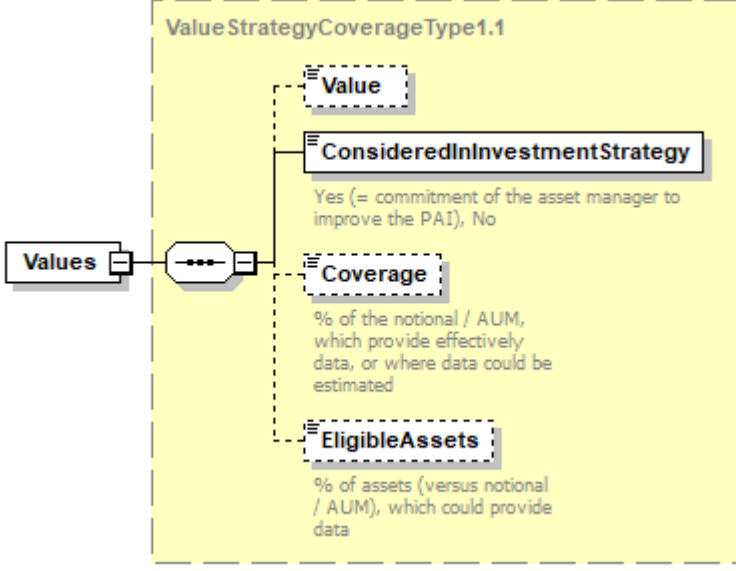
|            |   |
|------------|---|
| diagram    |  <p>The diagram shows a box labeled 'Values' connected to a container box. The container box is titled 'Value Strategy Coverage Type 1.1' and contains four sub-elements: 'Value', 'ConsideredInInvestmentStrategy', 'Coverage', and 'EligibleAssets'.<br/>- 'Value' is a simple text field.<br/>- 'ConsideredInInvestmentStrategy' is a text field with the description: 'Yes (= commitment of the asset manager to improve the PAI), No'.<br/>- 'Coverage' is a text field with the description: '% of the notional / AUM, which provide effectively data, or where data could be estimated'.<br/>- 'EligibleAssets' is a text field with the description: '% of assets (versus notional / AUM), which could provide data'.</p> |
| type       | <a href="#">ValueStrategyCoverageType1.1</a>  |
| properties | isRef 0<br>content complex  |
| children   | <a href="#">Value</a> <a href="#">ConsideredInInvestmentStrategy</a> <a href="#">Coverage</a> <a href="#">EligibleAssets</a>  |



element

**EETReportType1.1/PrincipalAdverseIndicators/ClimateAndEnvironmentRelatedIndicators/ActivitiesNegativelyAffectingBiodiversitySensitiveAreas**

|                   |   |
|-------------------|---|
| <p>diagram</p>    | <p>The diagram illustrates the structure of the <b>ValueStrategyCoverageType1.1</b> element. It features a dashed box on the left labeled <b>ActivitiesNegativelyAffectingBi...</b> with the range <b>30860 - 30890</b>. This box is connected to a central connector (a circle with three dots). From this connector, four dashed lines lead to sub-elements:         <ul style="list-style-type: none"> <li><b>Value</b>: A simple text field.</li> <li><b>ConsideredInInvestmentStrategy</b>: A text field with a description: "Yes (= commitment of the asset manager to improve the PAI), No".</li> <li><b>Coverage</b>: A text field with a description: "% of the notional / AUM, which provide effectively data, or where data could be estimated".</li> <li><b>EligibleAssets</b>: A text field with a description: "% of assets (versus notional / AUM), which could provide data".</li> </ul> </p> |
| <p>type</p>       | <p><a href="#">ValueStrategyCoverageType1.1</a></p>   |
| <p>properties</p> | <p>isRef 0<br/>minOcc 0<br/>maxOcc 1<br/>content complex</p>  |
| <p>children</p>   | <p><a href="#">Value</a> <a href="#">ConsideredInInvestmentStrategy</a> <a href="#">Coverage</a> <a href="#">EligibleAssets</a></p>   |
| <p>annotation</p> | <p>documentation<br/>30860 - 30890</p>  |

element

### EETReportType1.1/PrincipalAdverseIndicators/ClimateAndEnvironmentRelatedIndicators/WaterEmissions

|            |  |
|------------|--|
| diagram    | <p>The diagram shows a dashed box labeled 'ValueStrategyCoverageType1.1'. Inside, there are four sub-elements: 'Value', 'ConsideredInInvestmentStrategy', 'Coverage', and 'EligibleAssets'. 'ConsideredInInvestmentStrategy' is a solid box with the text 'Yes (= commitment of the asset manager to improve the PAI), No'. 'Coverage' is a dashed box with the text '% of the notional / AUM, which provide effectively data, or where data could be estimated'. 'EligibleAssets' is a dashed box with the text '% of assets (versus notional / AUM), which could provide data'. To the left of the dashed box is a dashed box labeled 'WaterEmissions' with the range '30900 - 30930'. A line with a connector symbol connects 'WaterEmissions' to the dashed box.</p> |
| type       | <a href="#">ValueStrategyCoverageType1.1</a>   |
| properties | isRef 0<br>minOcc 0<br>maxOcc 1<br>content complex   |
| children   | <a href="#">Value</a> <a href="#">ConsideredInInvestmentStrategy</a> <a href="#">Coverage</a> <a href="#">EligibleAssets</a>   |
| annotation | documentation<br>30900 - 30930   |

element

### EETReportType1.1/PrincipalAdverseIndicators/ClimateAndEnvironmentRelatedIndicators/HazardousWaste

|         |  |
|---------|--|
| diagram | <p>The diagram shows a dashed box labeled 'ValueStrategyCoverageType1.1'. Inside, there are four sub-elements: 'Value', 'ConsideredInInvestmentStrategy', 'Coverage', and 'EligibleAssets'. 'ConsideredInInvestmentStrategy' is a solid box with the text 'Yes (= commitment of the asset manager to improve the PAI), No'. 'Coverage' is a dashed box with the text '% of the notional / AUM, which provide effectively data, or where data could be estimated'. 'EligibleAssets' is a dashed box with the text '% of assets (versus notional / AUM), which could provide data'. To the left of the dashed box is a dashed box labeled 'HazardousWaste' with the range '30940 - 30970'. A line with a connector symbol connects 'HazardousWaste' to the dashed box.</p> |
|---------|--|

|            |  |
|------------|--|
| type       | <a href="#">ValueStrategyCoverageType1.1</a>                                 |
| properties | isRef 0<br>minOcc 0<br>maxOcc 1<br>content complex                           |
| children   | <a href="#">Value ConsideredInInvestmentStrategy Coverage EligibleAssets</a> |
| annotation | documentation<br>30940 - 30970   |

element **EETReportType1.1/PrincipalAdverseIndicators/SocialAndEmployeeMatters**

|            |   |
|------------|---|
| diagram    | <p>The diagram shows a class <b>SocialAndEmployeeMatters</b> (ID: 30980 - 31160) with a composition relationship (indicated by a solid line with a filled square at the SocialAndEmployeeMatters end and an open square at the other end) to a collection of five subclasses, each in a dashed box:</p> <ul style="list-style-type: none"> <li><b>CompaniesInvolvedInViolation...</b> (ID: 30980 - 31010): Companies_Involved_In_Violation_Of_UN_Global_Compact_Principles_And_OECD_Guidelines_For_Multinational_Enterprises</li> <li><b>CompaniesWithoutMonitoring...</b> (ID: 31020 - 31045): Share_Of_Companies_Without_Policies_To_Monitor_Compliance_With_UNGCP_And_OECD_Guidelines_For_Multinational_Enterprises</li> <li><b>UnadjustedGenderPayGap</b> (ID: 31050 - 31080): Unadjusted_Gender_Pay_Gap</li> <li><b>BoardGenderDiversity</b> (ID: 31090 - 31120): Board_Gender_Diversity</li> <li><b>InvestmentsInvolvedInControv...</b> (ID: 31130 - 31160): Investments_Involved_In_Controversial_Weapons</li> </ul> |
| properties | isRef 0<br>minOcc 0<br>maxOcc 1<br>content complex  |
| children   | <a href="#">CompaniesInvolvedInViolation UN GCP Or OECD ME Guidelines</a><br><a href="#">CompaniesWithoutMonitoringCompliance UN GCP Or OECD ME Guidelines</a><br><a href="#">UnadjustedGenderPayGap</a><br><a href="#">BoardGenderDiversity</a><br><a href="#">InvestmentsInvolvedInControversialWeapons</a>   |
| annotation | documentation<br>30980 - 31160  |

element

**EETReportType1.1/PrincipalAdverseIndicators/SocialAndEmployeeMatters/CompaniesInvolvedInViolation UN\_GCP\_Or\_OECD\_ME\_Guidelines**

|                   |  |
|-------------------|--|
| <p>diagram</p>    | <pre> classDiagram     class CompaniesInvolvedInViolation {         Companies_Involved_In_Violation_Of_UN_Global_Compact_Principles_And_OECD_Guidelines_For_Multinational_Enterprises (30980 - 31010)     }     class PercentageStrategyCoverageType1_1 {         Value         ConsideredInInvestmentStrategy         Coverage         EligibleAssets     }     CompaniesInvolvedInViolation "1" -- "*" PercentageStrategyCoverageType1_1     </pre> <p><b>PercentageStrategyCoverageType1.1</b></p> <ul style="list-style-type: none"> <li><b>Value</b></li> <li><b>ConsideredInInvestmentStrategy</b><br/>Yes (= commitment of the asset manager to improve the PAI), No</li> <li><b>Coverage</b><br/>% of the notional / AUM, which provide effectively data, or where data could be estimated</li> <li><b>EligibleAssets</b><br/>% of assets (versus notional / AUM), which could provide data</li> </ul> <p><b>CompaniesInvolvedInViolation...</b><br/>Companies_Involved_In_Violation_Of_UN_Global_Compact_Principles_And_OECD_Guidelines_For_Multinational_Enterprises (30980 - 31010)</p> |
| <p>type</p>       | <p><a href="#">PercentageStrategyCoverageType1.1</a></p>   |
| <p>properties</p> | <p>isRef 0<br/>minOcc 0<br/>maxOcc 1<br/>content complex</p>   |
| <p>children</p>   | <p><a href="#">Value</a> <a href="#">ConsideredInInvestmentStrategy</a> <a href="#">Coverage</a> <a href="#">EligibleAssets</a></p>  |
| <p>annotation</p> | <p>documentation<br/>Companies_Involved_In_Violation_Of_UN_Global_Compact_Principles_And_OECD_Guidelines_For_Multinational_Enterprises (30980 - 31010)</p>   |

element

**EETReportType1.1/PrincipalAdverseIndicators/SocialAndEmployeeMatters/CompaniesWithoutMonitoringCompliance\_UN\_GCP\_Or\_OECD\_ME\_Guidelines**

|                   |  |
|-------------------|--|
| <p>diagram</p>    | <p>The diagram illustrates the structure of the <b>PercentageStrategyCoverageType1.1</b> element. On the left, a dashed box represents the <b>CompaniesWithoutMonitoring...</b> element, which is linked to the main structure. Below it is the text: "Share_Of_Companies_Without_Policies_To_Monitor_Compliance_With_UNGCP_And_OECD_Guidelines_For_Multinational_Enterprises (31020 - 31045)". The main structure is a yellow box titled <b>PercentageStrategyCoverageType1.1</b>. It contains four sub-elements: <b>Value</b>, <b>ConsideredInInvestmentStrategy</b> (with a description: "Yes (= commitment of the asset manager to improve the PAI), No"), <b>Coverage</b> (with a description: "% of the notional / AUM, which provide effectively data, or where data could be estimated"), and <b>EligibleAssets</b> (with a description: "% of assets (versus notional / AUM), which could provide data").</p> |
| <p>type</p>       | <p><a href="#">PercentageStrategyCoverageType1.1</a></p>   |
| <p>properties</p> | <p>isRef 0<br/>minOcc 0<br/>maxOcc 1<br/>content complex</p>   |
| <p>children</p>   | <p><a href="#">Value</a> <a href="#">ConsideredInInvestmentStrategy</a> <a href="#">Coverage</a> <a href="#">EligibleAssets</a></p>  |
| <p>annotation</p> | <p>documentation<br/>Share_Of_Companies_Without_Policies_To_Monitor_Compliance_With_UNGCP_And_OECD_Guidelines_For_Multinational_Enterprises (31020 - 31045)</p>  |

element

**EETReportType1.1/PrincipalAdverseIndicators/SocialAndEmployeeMatters/UnadjustedGenderPayGap**

|            |   |
|------------|---|
| diagram    | <p>The diagram shows the structure of the <b>UnadjustedGenderPayGap</b> element. It is a dashed box containing the text "UnadjustedGenderPayGap" and "Unadjusted_Gender_Pay_Gap (31050 - 31080)". A line connects this element to a central connector box. From this connector, three lines branch out to three sub-elements: <b>Value</b>, <b>ConsideredInInvestmentStrategy</b>, and <b>Coverage</b>. The <b>ConsideredInInvestmentStrategy</b> element is a solid box with the text "Yes (= commitment of the asset manager to improve the PAI), No". The <b>Coverage</b> element is a dashed box with the text "% of the notional / AUM, which provide effectively data, or where data could be estimated". The <b>EligibleAssets</b> element is a dashed box with the text "% of assets (versus notional / AUM), which could provide data". The entire structure is enclosed in a yellow dashed box labeled "PercentageStrategyCoverageType1.1".</p> |
| type       | <a href="#">PercentageStrategyCoverageType1.1</a>   |
| properties | isRef 0<br>minOcc 0<br>maxOcc 1<br>content complex  |
| children   | <a href="#">Value</a> <a href="#">ConsideredInInvestmentStrategy</a> <a href="#">Coverage</a> <a href="#">EligibleAssets</a>  |
| annotation | documentation<br>Unadjusted_Gender_Pay_Gap (31050 - 31080)  |

element

**EETReportType1.1/PrincipalAdverseIndicators/SocialAndEmployeeMatters/BoardGenderDiversity**

|         |   |
|---------|---|
| diagram | <p>The diagram shows the structure of the <b>BoardGenderDiversity</b> element. It is a dashed box containing the text "BoardGenderDiversity" and "Board_Gender_Diversity (31090 - 31120)". A line connects this element to a central connector box. From this connector, three lines branch out to three sub-elements: <b>Value</b>, <b>ConsideredInInvestmentStrategy</b>, and <b>Coverage</b>. The <b>ConsideredInInvestmentStrategy</b> element is a solid box with the text "Yes (= commitment of the asset manager to improve the PAI), No". The <b>Coverage</b> element is a dashed box with the text "% of the notional / AUM, which provide effectively data, or where data could be estimated". The <b>EligibleAssets</b> element is a dashed box with the text "% of assets (versus notional / AUM), which could provide data". The entire structure is enclosed in a yellow dashed box labeled "ValueStrategyCoverageType1.1".</p> |
| type    | <a href="#">ValueStrategyCoverageType1.1</a>  |

|            |  |
|------------|--|
| properties | isRef 0<br>minOcc 0<br>maxOcc 1<br>content complex   |
| children   | <a href="#">Value</a> <a href="#">ConsideredInInvestmentStrategy</a> <a href="#">Coverage</a> <a href="#">EligibleAssets</a> |
| annotation | documentation<br>Board_Gender_Diversity (31090 - 31120)  |

element

**EETReportType1.1/PrincipalAdverseIndicators/SocialAndEmployeeMatters/InvestmentsInvolvedInControversialWeapons**

|            |  |
|------------|--|
| diagram    | <p><b>PercentageStrategyCoverageType1.1</b></p> <ul style="list-style-type: none"> <li><b>Value</b></li> <li><b>ConsideredInInvestmentStrategy</b><br/>Yes (= commitment of the asset manager to improve the PAI), No</li> <li><b>Coverage</b><br/>% of the notional / AUM, which provide effectively data, or where data could be estimated</li> <li><b>EligibleAssets</b><br/>% of assets (versus notional / AUM), which could provide data</li> </ul> <p><b>InvestmentsInvolvedInControversialWeapons</b><br/>Investments_Involved_In_Controversial_Weapons (31130 - 31160)</p> |
| type       | <a href="#">PercentageStrategyCoverageType1.1</a>  |
| properties | isRef 0<br>minOcc 0<br>maxOcc 1<br>content complex   |
| children   | <a href="#">Value</a> <a href="#">ConsideredInInvestmentStrategy</a> <a href="#">Coverage</a> <a href="#">EligibleAssets</a>   |
| annotation | documentation<br>Investments_Involved_In_Controversial_Weapons (31130 - 31160)   |

element **EETReportType1.1/PrincipalAdverseIndicators/SovereignAndSupranationalInvestments**

|         |   |
|---------|---|
| diagram | <p><b>SovereignAndSupranationalInvestments</b><br/>31170 - 31280</p> <ul style="list-style-type: none"> <li><b>GreenhouseGasIntensity</b><br/>GHG_Intesity (31170 - 31200)</li> <li><b>NumberOfCountriesSubjectToSocialViolations</b><br/>Number_Of_Countries_Subject_To_Social_Violations (31210 - 31240)</li> <li><b>PercentOfCountriesSubjectToSocialViolations</b><br/>Percent_Of_Countries_Subject_To_Social_Violations (31250 - 31280)</li> </ul> |
|---------|---|

|            |  |
|------------|--|
| properties | isRef 0<br>minOcc 0<br>maxOcc 1<br>content complex   |
| children   | <a href="#">GreenhouseGasIntensity</a> <a href="#">NumberOfCountriesSubjectToSocialViolations</a><br><a href="#">PercentOfCountriesSubjectToSocialViolations</a> |
| annotation | documentation<br>31170 - 31280   |

element

**EETReportType1.1/PrincipalAdverseIndicators/SovereignAndSupranationalInvestments/GreenhouseGasIntensity**

|            |  |
|------------|--|
| diagram    | <p>The diagram illustrates the composition of the <b>GreenhouseGasIntensity</b> element. It is composed of the <b>ValueStrategyCoverageType1.1</b> type. The <b>GreenhouseGasIntensity</b> element is associated with the <b>ValueStrategyCoverageType1.1</b> type via a composition relationship (indicated by a solid line with a hollow diamond at the <b>GreenhouseGasIntensity</b> end). The <b>ValueStrategyCoverageType1.1</b> type is composed of four elements: <b>Value</b>, <b>ConsideredInInvestmentStrategy</b>, <b>Coverage</b>, and <b>EligibleAssets</b>. The <b>ConsideredInInvestmentStrategy</b> element has a description: "Yes (= commitment of the asset manager to improve the PAI), No". The <b>Coverage</b> element has a description: "% of the notional / AUM, which provide effectively data, or where data could be estimated". The <b>EligibleAssets</b> element has a description: "% of assets (versus notional / AUM), which could provide data".</p> |
| type       | <a href="#">ValueStrategyCoverageType1.1</a>   |
| properties | isRef 0<br>minOcc 0<br>maxOcc 1<br>content complex   |
| children   | <a href="#">Value</a> <a href="#">ConsideredInInvestmentStrategy</a> <a href="#">Coverage</a> <a href="#">EligibleAssets</a>   |
| annotation | documentation<br>GHG_Intesity (31170 - 31200)  |



element

### EETReportType1.1/PrincipalAdverseIndicators/SovereignAndSupranationalInvestments/NumberOfCountriesSubjectToSocialViolations

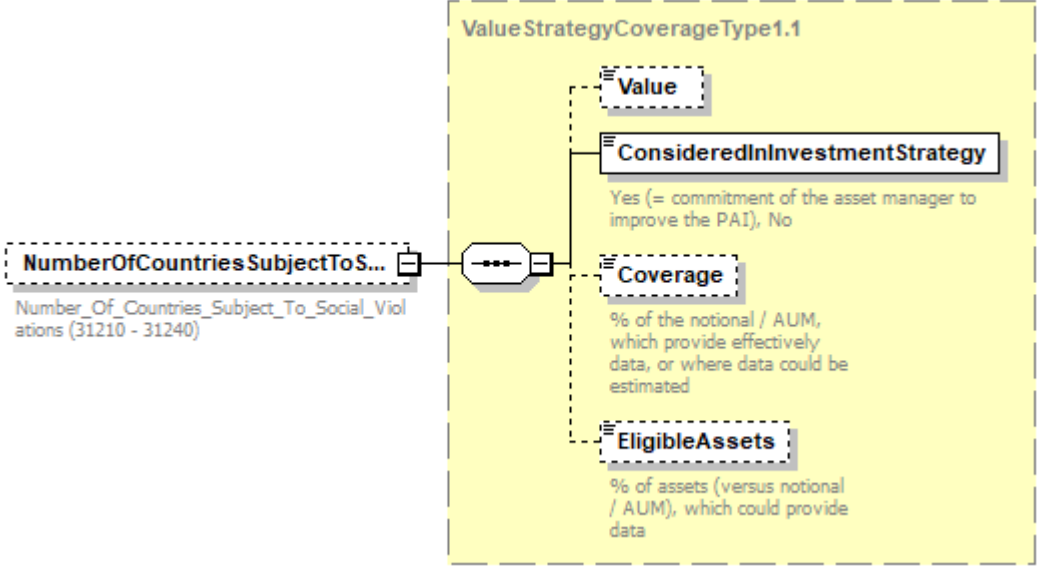
|            |  |
|------------|--|
| diagram    |  <p>The diagram shows a dashed box labeled "ValueStrategyCoverageType1.1" containing four sub-elements: "Value", "ConsideredInInvestmentStrategy", "Coverage", and "EligibleAssets". Each sub-element has a brief description: "Value" (no description), "ConsideredInInvestmentStrategy" (Yes (= commitment of the asset manager to improve the PAI), No), "Coverage" (% of the notional / AUM, which provide effectively data, or where data could be estimated), and "EligibleAssets" (% of assets (versus notional / AUM), which could provide data). To the left of this box is a dashed box labeled "NumberOfCountriesSubjectToS..." with the text "Number_Of_Countries_Subject_To_Social_Violations (31210 - 31240)". A line with a connector symbol connects this box to the "ValueStrategyCoverageType1.1" box.</p> |
| type       | <a href="#">ValueStrategyCoverageType1.1</a>   |
| properties | isRef 0<br>minOcc 0<br>maxOcc 1<br>content complex   |
| children   | <a href="#">Value</a> <a href="#">ConsideredInInvestmentStrategy</a> <a href="#">Coverage</a> <a href="#">EligibleAssets</a>   |
| annotation | documentation<br>Number_Of_Countries_Subject_To_Social_Violations (31210 - 31240)  |

element

### EETReportType1.1/PrincipalAdverseIndicators/SovereignAndSupranationalInvestments/PercentOfCountriesSubjectToSocialViolations

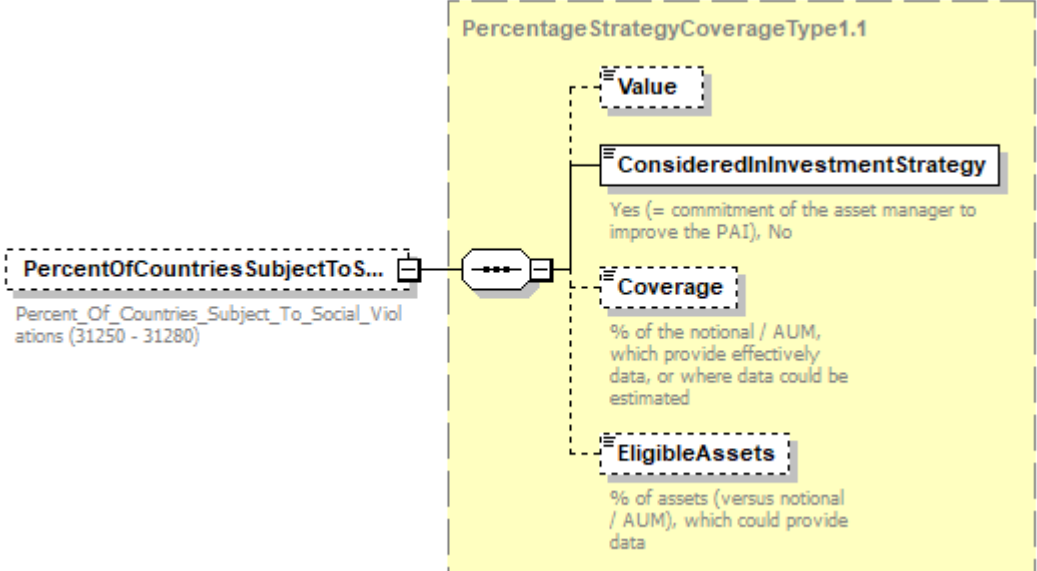
|         |  |
|---------|--|
| diagram |  <p>The diagram shows a dashed box labeled "PercentageStrategyCoverageType1.1" containing four sub-elements: "Value", "ConsideredInInvestmentStrategy", "Coverage", and "EligibleAssets". Each sub-element has a brief description: "Value" (no description), "ConsideredInInvestmentStrategy" (Yes (= commitment of the asset manager to improve the PAI), No), "Coverage" (% of the notional / AUM, which provide effectively data, or where data could be estimated), and "EligibleAssets" (% of assets (versus notional / AUM), which could provide data). To the left of this box is a dashed box labeled "PercentOfCountriesSubjectToS..." with the text "Percent_Of_Countries_Subject_To_Social_Violations (31250 - 31280)". A line with a connector symbol connects this box to the "PercentageStrategyCoverageType1.1" box.</p> |
|---------|--|

|            |  |
|------------|--|
| type       | <a href="#">PercentageStrategyCoverageType1.1</a>  |
| properties | isRef 0<br>minOcc 0<br>maxOcc 1<br>content complex   |
| children   | <a href="#">Value</a> <a href="#">ConsideredInInvestmentStrategy</a> <a href="#">Coverage</a> <a href="#">EligibleAssets</a> |
| annotation | documentation<br>Percent_Of_Countries_Subject_To_Social_Violations (31250 - 31280)   |

element **EETReportType1.1/PrincipalAdverseIndicators/RealEstateInvestments**

|            |  |
|------------|--|
| diagram    |  |
| properties | isRef 0<br>minOcc 0<br>maxOcc 1<br>content complex   |
| children   | <a href="#">FossilFuelsExtractionStorageTransportManufacture</a> <a href="#">EnergyEfficientRealEstateAssets</a> |
| annotation | documentation<br>31290 - 31360   |

element **EETReportType1.1/PrincipalAdverseIndicators/RealEstateInvestments/FossilFuelsExtractionStorageTransportManufacture**

|            |   |
|------------|---|
| diagram    |   |
| type       | <a href="#">PercentageStrategyCoverageType1.1</a> |
| properties | isRef 0<br>minOcc 0<br>maxOcc 1                   |

|            |  |
|------------|--|
|            | content complex  |
| children   | <a href="#">Value</a> <a href="#">ConsideredInInvestmentStrategy</a> <a href="#">Coverage</a> <a href="#">EligibleAssets</a> |
| annotation | documentation<br>Exposure_To_Fossil_Fuels_Extraction_Storage_Transport_Manufacture (31290 - 31320)                           |

element

**EETReportType1.1/PrincipalAdverseIndicators/RealEstateInvestments/EnergyEfficientRealEstateAssets**

|            |  |
|------------|--|
| diagram    | <pre> classDiagram     class EnergyEfficientRealEstateAssets {         Exposure_To_Energy_Efficient_Real_Estate_Assets (31330 - 31360)     }     class PercentageStrategyCoverageType1_1 {         Value         ConsideredInInvestmentStrategy         Coverage         EligibleAssets     }     EnergyEfficientRealEstateAssets "1" *-- "1" PercentageStrategyCoverageType1_1     </pre> |
| type       | <a href="#">PercentageStrategyCoverageType1.1</a>  |
| properties | isRef 0<br>minOcc 0<br>maxOcc 1<br>content complex   |
| children   | <a href="#">Value</a> <a href="#">ConsideredInInvestmentStrategy</a> <a href="#">Coverage</a> <a href="#">EligibleAssets</a>   |
| annotation | documentation<br>Exposure_To_Energy_Efficient_Real_Estate_Assets (31330 - 31360)   |

element **EETReportType1.1/PrincipalAdverseIndicators/MoreClimateAndEnvironmentRelatedIndicators**

|            |  |
|------------|--|
| diagram    |  |
| properties | isRef 0<br>minOcc 0<br>maxOcc 1<br>content complex   |
| children   | <a href="#">EnergyEfficiency</a> <a href="#">EnergyConsumptionNonRenewable</a> <a href="#">WaterWasteAndLandProtection</a> <a href="#">GreenSecurities</a> <a href="#">RealEstateInvestments</a> |
| annotation | documentation<br>31370 - 32430   |

element **EETReportType1.1/PrincipalAdverseIndicators/MoreClimateAndEnvironmentRelatedIndicators/EnergyEfficiency**

|            |  |
|------------|--|
| diagram    |  |
| properties | isRef 0<br>minOcc 0<br>maxOcc 1<br>content complex   |
| children   | <a href="#">EmissionsOfInorganicPollutants</a> <a href="#">EmissionsOfAirPollutants</a> <a href="#">EmissionsOfOzoneDepletionSubstances</a> <a href="#">CompaniesWithoutCarbonEmissionReductionInitiatives</a> |
| annotation | documentation<br>31370 - 31510   |

element

**EETReportType1.1/PrincipalAdverseIndicators/MoreClimateAndEnvironmentRelatedIndicators/EnergyEfficiency/EmissionsOfInorganicPollutants**

|                   |   |
|-------------------|---|
| <p>diagram</p>    |   |
| <p>type</p>       | <p><a href="#">ValueStrategyCoverageType1.1</a></p>   |
| <p>properties</p> | <p>isRef 0<br/>minOcc 0<br/>maxOcc 1<br/>content complex</p>  |
| <p>children</p>   | <p><a href="#">Value</a> <a href="#">ConsideredInInvestmentStrategy</a> <a href="#">Coverage</a> <a href="#">EligibleAssets</a></p> |
| <p>annotation</p> | <p>documentation<br/>Emissions_Of_Inorganic_Pollutants (31370 - 31400)</p>  |

element

### EETReportType1.1/PrincipalAdverseIndicators/MoreClimateAndEnvironmentRelatedIndicators/EnergyEfficiency/EmissionsOfAirPollutants

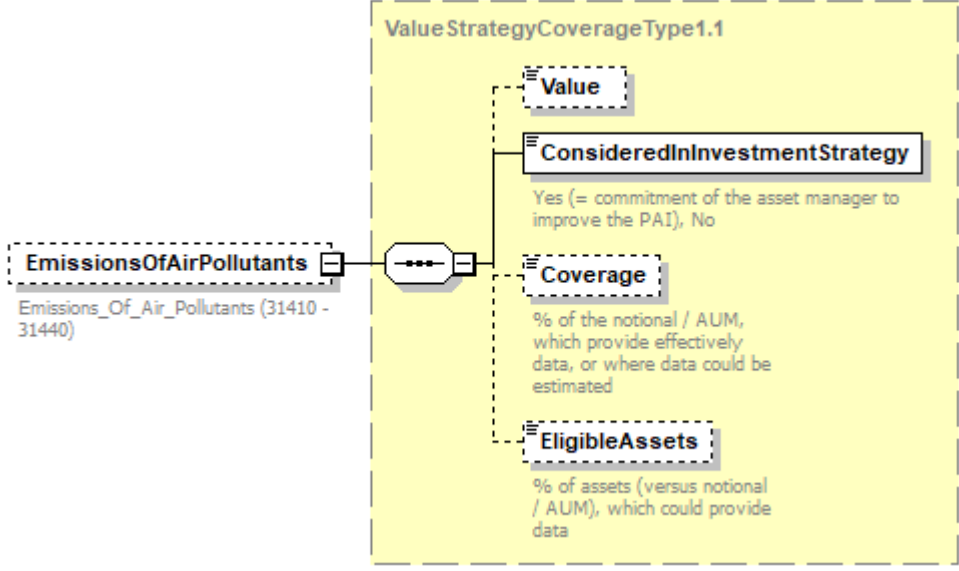
|            |  |
|------------|--|
| diagram    |    |
| type       | <a href="#">ValueStrategyCoverageType1.1</a>   |
| properties | isRef 0<br>minOcc 0<br>maxOcc 1<br>content complex   |
| children   | <a href="#">Value</a> <a href="#">ConsideredInInvestmentStrategy</a> <a href="#">Coverage</a> <a href="#">EligibleAssets</a> |
| annotation | documentation<br>Emissions_Of_Air_Pollutants (31410 - 31440)   |

element

### EETReportType1.1/PrincipalAdverseIndicators/MoreClimateAndEnvironmentRelatedIndicators/EnergyEfficiency/EmissionsOfOzoneDepletionSubstances

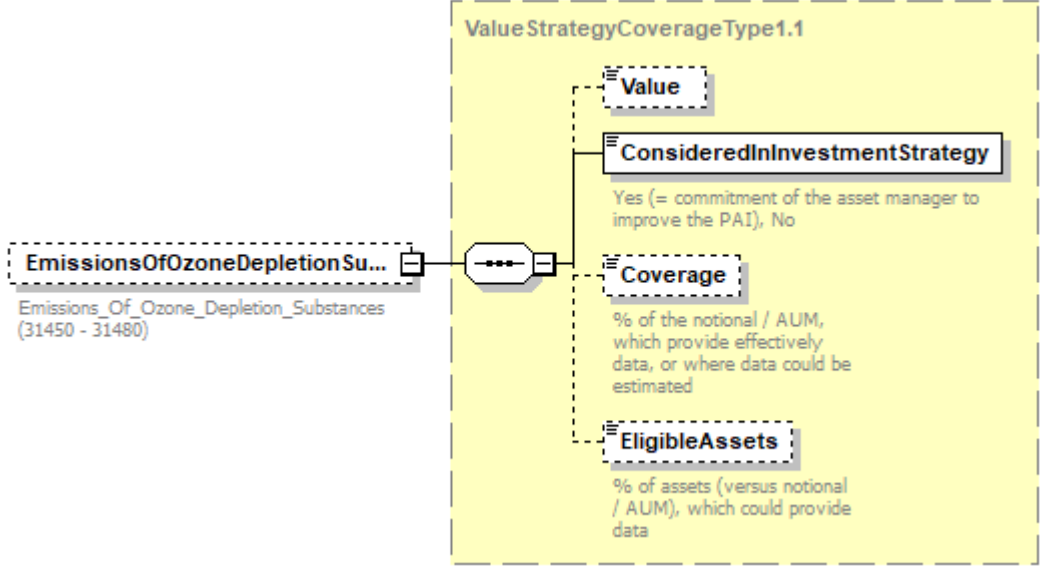
|         |  |
|---------|--|
| diagram |  |
|---------|--|

|            |  |
|------------|--|
| type       | <a href="#">ValueStrategyCoverageType1.1</a>   |
| properties | isRef 0<br>minOcc 0<br>maxOcc 1<br>content complex   |
| children   | <a href="#">Value</a> <a href="#">ConsideredInInvestmentStrategy</a> <a href="#">Coverage</a> <a href="#">EligibleAssets</a> |
| annotation | documentation<br>Emissions_Of_Ozone_Depletion_Substances (31450 - 31480)   |

element

**EETReportType1.1/PrincipalAdverseIndicators/MoreClimateAndEnvironmentRelatedIndicators/EnergyEfficiency/CompaniesWithoutCarbonEmissionReductionInitiatives**

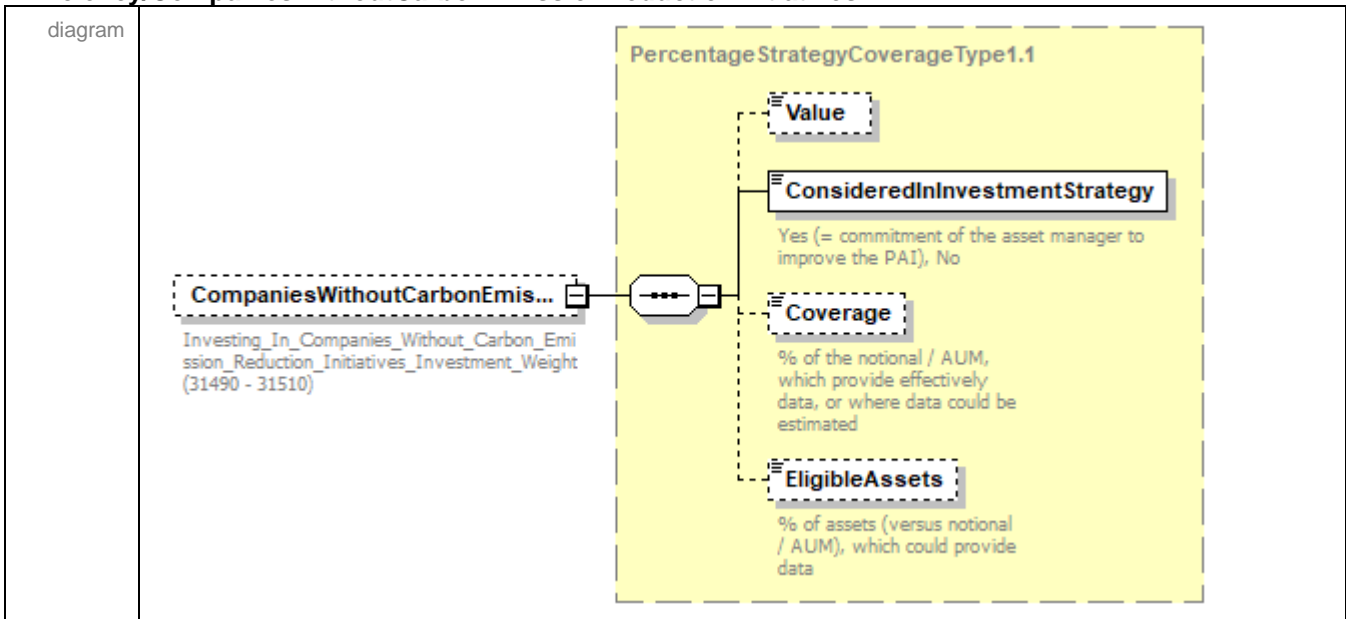

|            |  |
|------------|--|
| type       | <a href="#">PercentageStrategyCoverageType1.1</a>  |
| properties | isRef 0<br>minOcc 0<br>maxOcc 1<br>content complex   |
| children   | <a href="#">Value</a> <a href="#">ConsideredInInvestmentStrategy</a> <a href="#">Coverage</a> <a href="#">EligibleAssets</a> |
| annotation | documentation<br>Investing_In_Companies_Without_Carbon_Emission_Reduction_Initiatives_Investment_Weight (31490 - 31510)      |

element

**EETReportType1.1/PrincipalAdverseIndicators/MoreClimateAndEnvironmentRelatedIndicators/Energy ConsumptionNonRenewable**

|                   |   |
|-------------------|---|
| <p>diagram</p>    | <pre> classDiagram     class EnergyConsumptionNonRenewable {         31520 - 31630     }     class Oil {         Breakdown_Of_Energy_Consumption_By_Type_Of_Non-renewable_Sources_Of_Energy_Oil (31520 - 31550)     }     class NaturalGas {         Breakdown_Of_Energy_Consumption_By_Type_Of_Non-renewable_Sources_Of_Energy_Natural_Gas (31560 - 31590)     }     class Coal {         Breakdown_Of_Energy_Consumption_By_Type_Of_Non-renewable_Sources_Of_Energy_Coal (31600 - 31630)     }     EnergyConsumptionNonRenewable &lt; -- Oil     EnergyConsumptionNonRenewable &lt; -- NaturalGas     EnergyConsumptionNonRenewable &lt; -- Coal         </pre> |
| <p>properties</p> | <p>isRef 0<br/>minOcc 0<br/>maxOcc 1<br/>content complex</p>  |
| <p>children</p>   | <p><a href="#">Oil</a> <a href="#">NaturalGas</a> <a href="#">Coal</a></p>  |
| <p>annotation</p> | <p>documentation<br/>31520 - 31630</p>  |

element

**EETReportType1.1/PrincipalAdverseIndicators/MoreClimateAndEnvironmentRelatedIndicators/Energy ConsumptionNonRenewable/Oil**

|                   |   |
|-------------------|---|
| <p>diagram</p>    | <pre> classDiagram     class Oil {         Breakdown_Of_Energy_Consumption_By_Type_Of_Non-renewable_Sources_Of_Energy_Oil (31520 - 31550)     }     class PercentageStrategyCoverageType1_1 {         Value         ConsideredInInvestmentStrategy         Coverage         EligibleAssets     }     Oil &lt; -- PercentageStrategyCoverageType1_1         </pre> |
| <p>type</p>       | <p><a href="#">PercentageStrategyCoverageType1.1</a></p>  |
| <p>properties</p> | <p>isRef 0<br/>minOcc 0</p>   |



|            |  |
|------------|--|
|            | maxOcc 1<br>content complex  |
| children   | <a href="#">Value</a> <a href="#">ConsideredInInvestmentStrategy</a> <a href="#">Coverage</a> <a href="#">EligibleAssets</a> |
| annotation | documentation<br>Breakdown_Of_Energy_Consumption_By_Type_Of_Non-renewable_Sources_Of_Energy_Oil (31520 - 31550)              |

element

**EETReportType1.1/PrincipalAdverseIndicators/MoreClimateAndEnvironmentRelatedIndicators/Energy ConsumptionNonRenewable/NaturalGas**

|            |  |
|------------|--|
| diagram    | <p><b>PercentageStrategyCoverageType1.1</b></p> <ul style="list-style-type: none"> <li><b>Value</b></li> <li><b>ConsideredInInvestmentStrategy</b><br/>Yes (= commitment of the asset manager to improve the PAI), No</li> <li><b>Coverage</b><br/>% of the notional / AUM, which provide effectively data, or where data could be estimated</li> <li><b>EligibleAssets</b><br/>% of assets (versus notional / AUM), which could provide data</li> </ul> <p><b>NaturalGas</b><br/>Breakdown_Of_Energy_Consumption_By_Type_Of_Non-renewable_Sources_Of_Energy_Natural_Gas (31560 - 31590)</p> |
| type       | <a href="#">PercentageStrategyCoverageType1.1</a>  |
| properties | isRef 0<br>minOcc 0<br>maxOcc 1<br>content complex   |
| children   | <a href="#">Value</a> <a href="#">ConsideredInInvestmentStrategy</a> <a href="#">Coverage</a> <a href="#">EligibleAssets</a>   |
| annotation | documentation<br>Breakdown_Of_Energy_Consumption_By_Type_Of_Non-renewable_Sources_Of_Energy_Natural_Gas (31560 - 31590)  |

element

**EETReportType1.1/PrincipalAdverseIndicators/MoreClimateAndEnvironmentRelatedIndicators/Energy ConsumptionNonRenewable/Coal**

|                   |   |
|-------------------|---|
| <p>diagram</p>    |   |
| <p>type</p>       | <p><a href="#">PercentageStrategyCoverageType1.1</a></p>  |
| <p>properties</p> | <p>isRef 0<br/>minOcc 0<br/>maxOcc 1<br/>content complex</p>  |
| <p>children</p>   | <p><a href="#">Value</a> <a href="#">ConsideredInInvestmentStrategy</a> <a href="#">Coverage</a> <a href="#">EligibleAssets</a></p> |
| <p>annotation</p> | <p>documentation<br/>Breakdown_Of_Energy_Consumption_By_Type_Of_Non-renewable_Sources_Of_Energy_Coal (31600 - 31630)</p>            |

element

**EETReportType1.1/PrincipalAdverseIndicators/MoreClimateAndEnvironmentRelatedIndicators/WaterWasteAndLandProtection**

diagram

**WaterWasteAndLandProtection**

31640 - 31990

**WaterUsageAndRecyclingAmo...**

Water\_Usage\_And\_Recycling\_Average\_Amount (31640 - 31670)

**WaterUsageAndRecyclingPerce...**

Water\_Usage\_And\_Recycling\_Average\_Percentage (31640 - 31670)

**CompaniesWithoutWaterMana...**

Investing\_In\_Companies\_Without\_Water\_Management\_Policies\_Weight (31680 - 31710)

**AreasOfHighWaterStress**

Exposure\_To\_Areas\_Of\_High\_Water\_Stress (31720 - 31750)

**CompaniesProducingChemicals**

Exposure\_To\_Companies\_Producing\_Chemicals (31760 - 31790)

**CompaniesCausingLandDegra...**

Exposure\_To\_Companies\_Causing\_Land\_Degradation\_Desertification\_Or\_Soil\_Sealing (31800 - 31830)

**CompaniesWithoutSustainable...**

Exposure\_To\_Companies\_Without\_Sustainable\_Land\_Or\_Agriculture\_Practices\_Policies (31840 - 31870)

**CompaniesWithoutSustainable...**

Share\_Of\_Investments\_In\_Companies\_Without\_Sustainable\_Oceans\_Or\_Seas\_Practices (31871 - 31874)

**NonRecycledWasteRatio**

Non\_Recycled\_Waste\_Ratio (31875 - 31878)

**CompaniesWhoseOperationsA...**

Share\_Of\_Investments\_In\_Investee\_Companies\_Whose\_Operations\_Affect\_Threatened\_Species (31880 - 31910)

**CompaniesWithoutBiodiversity...**

Share\_Of\_Investments\_In\_Investee\_Companies\_Without\_A\_Biodiversity\_Protection\_Policy\_Covering\_Operational\_Sites\_Owned\_Leased\_Managed\_In\_Or\_Adjacent\_To\_A\_Protected\_Area\_Or\_An\_Area\_Of\_High\_Biodiversity\_Value\_Outside\_Protected\_Areas (31920 - 31950)

**CompaniesWithoutDeforestat...**

Share\_Of\_Investee\_Companies\_Without\_Deforestation\_Policy (31960 - 31990)

properties

isRef 0  
minOcc 0

|            |  |
|------------|--|
|            | maxOcc 1<br>content complex  |
| children   | <a href="#">WaterUsageAndRecyclingAmount</a> <a href="#">WaterUsageAndRecyclingPercentage</a> <a href="#">CompaniesWithoutWaterManagement</a> <a href="#">AreasOfHighWaterStress</a> <a href="#">CompaniesProducingChemicals</a> <a href="#">CompaniesCausingLandDegradationDesertificationSoilSealing</a> <a href="#">CompaniesWithoutSustainableLandOrAgriculturePractices</a> <a href="#">CompaniesWithoutSustainableOceansSeasPractices</a> <a href="#">NonRecycledWasteRatio</a> <a href="#">CompaniesWhoseOperationsAffectThreatenedSpecies</a> <a href="#">CompaniesWithoutBiodiversityProtection</a> <a href="#">CompaniesWithoutDeforestationPolicy</a> |
| annotation | documentation<br>31640 - 31990   |

element

**EETReportType1.1/PrincipalAdverseIndicators/MoreClimateAndEnvironmentRelatedIndicators/WaterWasteAndLandProtection/WaterUsageAndRecyclingAmount**

|            |  |
|------------|--|
| diagram    |  |
| type       | <a href="#">ValueStrategyCoverageType1.1</a>   |
| properties | isRef 0<br>minOcc 0<br>maxOcc 1<br>content complex   |
| children   | <a href="#">Value</a> <a href="#">ConsideredInInvestmentStrategy</a> <a href="#">Coverage</a> <a href="#">EligibleAssets</a> |
| annotation | documentation<br>Water_Usage_And_Recycling_Average_Amount (31640 - 31670)  |

element

**EETReportType1.1/PrincipalAdverseIndicators/MoreClimateAndEnvironmentRelatedIndicators/WaterWasteAndLandProtection/WaterUsageAndRecyclingPercentage**

|                   |   |
|-------------------|---|
| <p>diagram</p>    |   |
| <p>type</p>       | <p><a href="#">PercentageStrategyCoverageType1.1</a></p>  |
| <p>properties</p> | <p>isRef 0<br/>minOcc 0<br/>maxOcc 1<br/>content complex</p>  |
| <p>children</p>   | <p><a href="#">Value</a> <a href="#">ConsideredInInvestmentStrategy</a> <a href="#">Coverage</a> <a href="#">EligibleAssets</a></p> |
| <p>annotation</p> | <p>documentation<br/>Water_Usage_And_Recycling_Average_Percentage (31640 - 31670)</p>   |

element

**EETReportType1.1/PrincipalAdverseIndicators/MoreClimateAndEnvironmentRelatedIndicators/WaterWasteAndLandProtection/CompaniesWithoutWaterManagement**

|                   |   |
|-------------------|---|
| <p>diagram</p>    |   |
| <p>type</p>       | <p><a href="#">PercentageStrategyCoverageType1.1</a></p>  |
| <p>properties</p> | <p>isRef 0<br/>minOcc 0<br/>maxOcc 1<br/>content complex</p>  |
| <p>children</p>   | <p><a href="#">Value</a> <a href="#">ConsideredInInvestmentStrategy</a> <a href="#">Coverage</a> <a href="#">EligibleAssets</a></p> |
| <p>annotation</p> | <p>documentation<br/>Investing_In_Companies_Without_Water_Management_Policies_Weight (31680 - 31710)</p>                            |

element

**EETReportType1.1/PrincipalAdverseIndicators/MoreClimateAndEnvironmentRelatedIndicators/WaterWasteAndLandProtection/AreasOfHighWaterStress**

|                   |   |
|-------------------|---|
| <p>diagram</p>    |   |
| <p>type</p>       | <p><a href="#">PercentageStrategyCoverageType1.1</a></p>  |
| <p>properties</p> | <p>isRef 0<br/>minOcc 0<br/>maxOcc 1<br/>content complex</p>  |
| <p>children</p>   | <p><a href="#">Value</a> <a href="#">ConsideredInInvestmentStrategy</a> <a href="#">Coverage</a> <a href="#">EligibleAssets</a></p> |
| <p>annotation</p> | <p>documentation<br/>Exposure_To_Areas_Of_High_Water_Stress (31720 - 31750)</p>   |



element

**EETReportType1.1/PrincipalAdverseIndicators/MoreClimateAndEnvironmentRelatedIndicators/WaterWasteAndLandProtection/CompaniesProducingChemicals**

|                   |   |
|-------------------|---|
| <p>diagram</p>    |   |
| <p>type</p>       | <p><a href="#">PercentageStrategyCoverageType1.1</a></p>  |
| <p>properties</p> | <p>isRef 0<br/>minOcc 0<br/>maxOcc 1<br/>content complex</p>  |
| <p>children</p>   | <p><a href="#">Value</a> <a href="#">ConsideredInInvestmentStrategy</a> <a href="#">Coverage</a> <a href="#">EligibleAssets</a></p> |
| <p>annotation</p> | <p>documentation<br/>Exposure_To_Companies_Producing_Chemicals (31760 - 31790)</p>  |

element

**EETReportType1.1/PrincipalAdverseIndicators/MoreClimateAndEnvironmentRelatedIndicators/WaterWasteAndLandProtection/CompaniesCausingLandDegradationDesertificationSoilSealing**

|                   |   |
|-------------------|---|
| <p>diagram</p>    |   |
| <p>type</p>       | <p><a href="#">PercentageStrategyCoverageType1.1</a></p>  |
| <p>properties</p> | <p>isRef 0<br/>minOcc 0<br/>maxOcc 1<br/>content complex</p>  |
| <p>children</p>   | <p><a href="#">Value</a> <a href="#">ConsideredInInvestmentStrategy</a> <a href="#">Coverage</a> <a href="#">EligibleAssets</a></p> |
| <p>annotation</p> | <p>documentation<br/>Exposure_To_Companies_Causing_Land_Degradation_Desertification_Or_Soil_Sealing (31800 - 31830)</p>             |

element

**EETReportType1.1/PrincipalAdverseIndicators/MoreClimateAndEnvironmentRelatedIndicators/WaterWasteAndLandProtection/CompaniesWithoutSustainableLandOrAgriculturePractices**

|                   |   |
|-------------------|---|
| <p>diagram</p>    | <p>The diagram illustrates the structure of the <b>PercentageStrategyCoverageType1.1</b> element. On the left, a dashed box represents the parent element <b>CompaniesWithoutSustainable...</b>, with the description: "Exposure_To_Companies_Without_Sustainable_Land_Or_Agriculture_Practices_Policies (31840 - 31870)". This element is connected to a central connector box, which in turn connects to a large yellow dashed box representing the <b>PercentageStrategyCoverageType1.1</b> element. Inside this yellow box, four sub-elements are listed: <b>Value</b>, <b>ConsideredInInvestmentStrategy</b> (with the description: "Yes (= commitment of the asset manager to improve the PAI), No"), <b>Coverage</b> (with the description: "% of the notional / AUM, which provide effectively data, or where data could be estimated"), and <b>EligibleAssets</b> (with the description: "% of assets (versus notional / AUM), which could provide data").</p> |
| <p>type</p>       | <p><a href="#">PercentageStrategyCoverageType1.1</a></p>  |
| <p>properties</p> | <p>isRef 0<br/>minOcc 0<br/>maxOcc 1<br/>content complex</p>  |
| <p>children</p>   | <p><a href="#">Value</a> <a href="#">ConsideredInInvestmentStrategy</a> <a href="#">Coverage</a> <a href="#">EligibleAssets</a></p>   |
| <p>annotation</p> | <p>documentation<br/>Exposure_To_Companies_Without_Sustainable_Land_Or_Agriculture_Practices_Policies (31840 - 31870)</p>   |

element

### EETReportType1.1/PrincipalAdverseIndicators/MoreClimateAndEnvironmentRelatedIndicators/WaterWasteAndLandProtection/CompaniesWithoutSustainableOceansSeasPractices

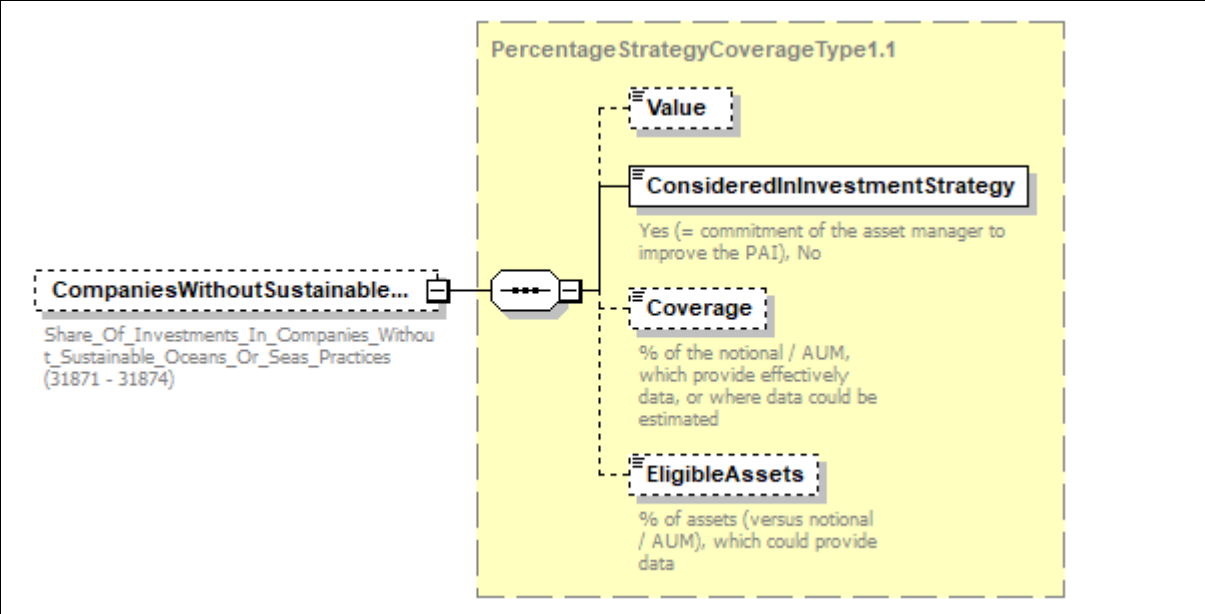
|            |   |
|------------|---|
| diagram    |  <p>The diagram shows a tree structure for the element <b>CompaniesWithoutSustainable...</b> (Share_Of_Investments_In_Companies_Without_Sustainable_Oceans_Or_Seas_Practices (31871 - 31874)). This element is connected to a central node, which then branches into four sub-elements: <b>Value</b>, <b>ConsideredInInvestmentStrategy</b>, <b>Coverage</b>, and <b>EligibleAssets</b>. The <b>ConsideredInInvestmentStrategy</b> sub-element has a description: "Yes (= commitment of the asset manager to improve the PAI), No". The <b>Coverage</b> sub-element has a description: "% of the notional / AUM, which provide effectively data, or where data could be estimated". The <b>EligibleAssets</b> sub-element has a description: "% of assets (versus notional / AUM), which could provide data".</p> |
| type       | <a href="#">PercentageStrategyCoverageType1.1</a>   |
| properties | isRef 0<br>minOcc 0<br>maxOcc 1<br>content complex  |
| children   | <a href="#">Value</a> <a href="#">ConsideredInInvestmentStrategy</a> <a href="#">Coverage</a> <a href="#">EligibleAssets</a>  |
| annotation | documentation<br>Share_Of_Investments_In_Companies_Without_Sustainable_Oceans_Or_Seas_Practices (31871 - 31874)   |

element

### EETReportType1.1/PrincipalAdverseIndicators/MoreClimateAndEnvironmentRelatedIndicators/WaterWasteAndLandProtection/NonRecycledWasteRatio

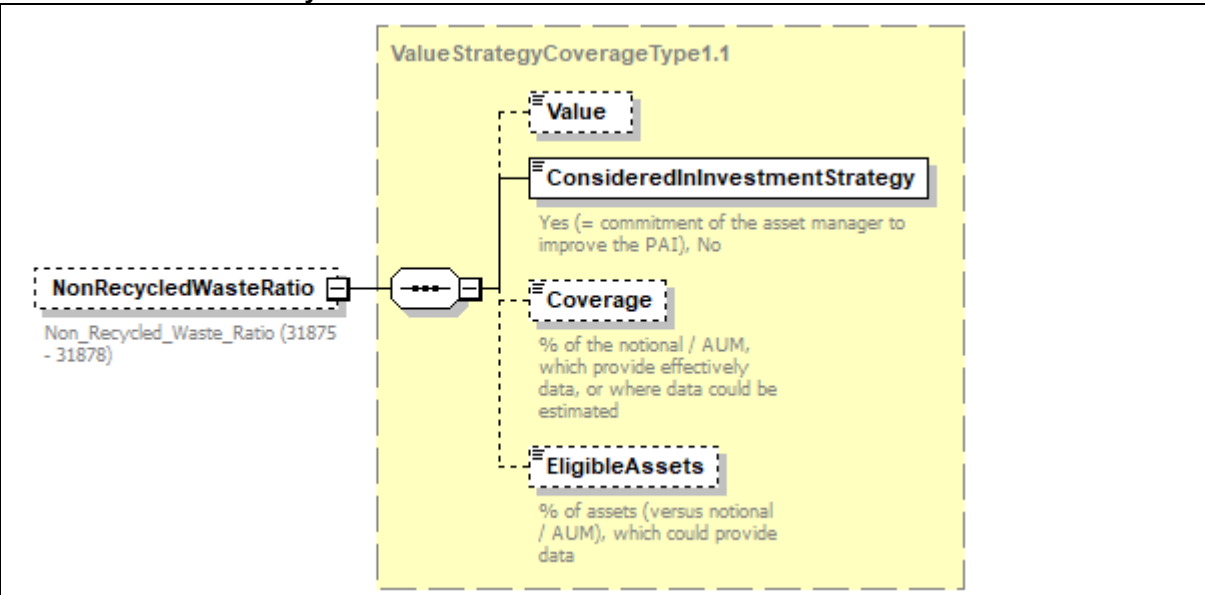
|         |  |
|---------|--|
| diagram |  <p>The diagram shows a tree structure for the element <b>NonRecycledWasteRatio</b> (Non_Recycled_Waste_Ratio (31875 - 31878)). This element is connected to a central node, which then branches into three sub-elements: <b>Value</b>, <b>ConsideredInInvestmentStrategy</b>, and <b>EligibleAssets</b>. The <b>ConsideredInInvestmentStrategy</b> sub-element has a description: "Yes (= commitment of the asset manager to improve the PAI), No". The <b>EligibleAssets</b> sub-element has a description: "% of assets (versus notional / AUM), which could provide data".</p> |
|---------|--|

|            |  |
|------------|--|
| type       | <a href="#">ValueStrategyCoverageType1.1</a>   |
| properties | isRef 0<br>minOcc 0<br>maxOcc 1<br>content complex   |
| children   | <a href="#">Value</a> <a href="#">ConsideredInInvestmentStrategy</a> <a href="#">Coverage</a> <a href="#">EligibleAssets</a> |
| annotation | documentation<br>Non_Recycled_Waste_Ratio (31875 - 31878)  |

element

**EETReportType1.1/PrincipalAdverseIndicators/MoreClimateAndEnvironmentRelatedIndicators/WaterWasteAndLandProtection/CompaniesWhoseOperationsAffectThreatenedSpecies**

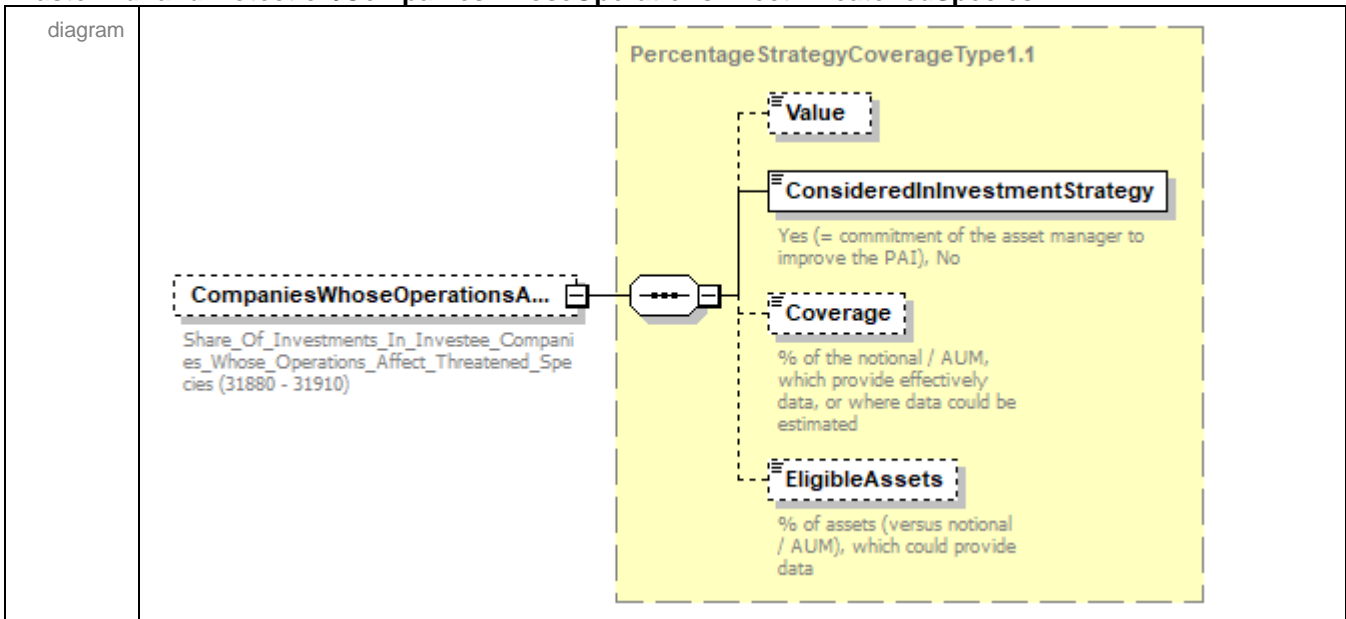

|            |  |
|------------|--|
| type       | <a href="#">PercentageStrategyCoverageType1.1</a>  |
| properties | isRef 0<br>minOcc 0<br>maxOcc 1<br>content complex   |
| children   | <a href="#">Value</a> <a href="#">ConsideredInInvestmentStrategy</a> <a href="#">Coverage</a> <a href="#">EligibleAssets</a> |
| annotation | documentation<br>Share_Of_Investments_In_Investee_Companies_Whose_Operations_Affect_Threatened_Species (31880 - 31910)       |

element

**EETReportType1.1/PrincipalAdverseIndicators/MoreClimateAndEnvironmentRelatedIndicators/WaterWasteAndLandProtection/CompaniesWithoutBiodiversityProtection**

|                   |  |
|-------------------|--|
| <p>diagram</p>    | <p><b>PercentageStrategyCoverageType1.1</b></p> <ul style="list-style-type: none"> <li><b>Value</b></li> <li><b>ConsideredInInvestmentStrategy</b><br/>Yes (= commitment of the asset manager to improve the PAI), No</li> <li><b>Coverage</b><br/>% of the notional / AUM, which provide effectively data, or where data could be estimated</li> <li><b>EligibleAssets</b><br/>% of assets (versus notional / AUM), which could provide data</li> </ul> <p><b>CompaniesWithoutBiodiversity...</b></p> <p>Share_Of_Investments_In_Investee_Companies_Without_A_Biodiversity_Protection_Policy_Covering_Operational_Sites_Owned_Leased_Managed_In_Or_Adjacent_To_A_Protected_Area_Or_An_Area_Of_High_Biodiversity_Value_Outside_Protected_Areas (31920 - 31950)</p> |
| <p>type</p>       | <p><a href="#">PercentageStrategyCoverageType1.1</a></p>   |
| <p>properties</p> | <p>isRef 0<br/>minOcc 0<br/>maxOcc 1<br/>content complex</p>   |
| <p>children</p>   | <p><a href="#">Value</a> <a href="#">ConsideredInInvestmentStrategy</a> <a href="#">Coverage</a> <a href="#">EligibleAssets</a></p>  |
| <p>annotation</p> | <p>documentation<br/>Share_Of_Investments_In_Investee_Companies_Without_A_Biodiversity_Protection_Policy_Covering_Operational_Sites_Owned_Leased_Managed_In_Or_Adjacent_To_A_Protected_Area_Or_An_Area_Of_High_Biodiversity_Value_Outside_Protected_Areas (31920 - 31950)</p>  |

element

**EETReportType1.1/PrincipalAdverseIndicators/MoreClimateAndEnvironmentRelatedIndicators/WaterWasteAndLandProtection/CompaniesWithoutDeforestationPolicy**

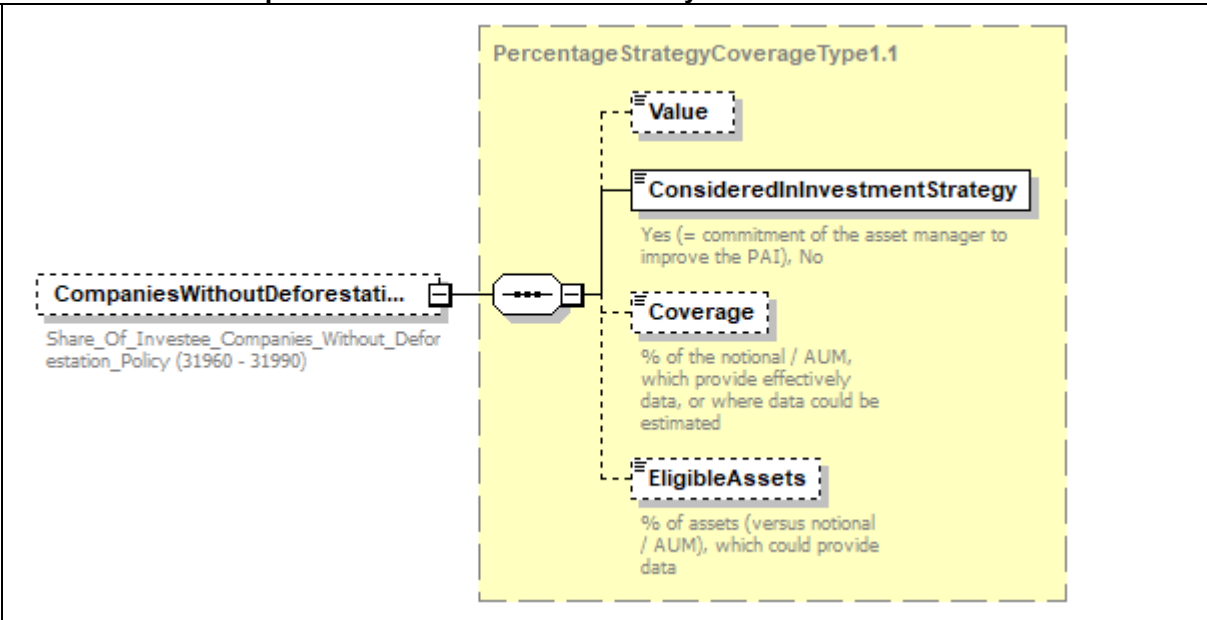
|                   |   |
|-------------------|---|
| <p>diagram</p>    |   |
| <p>type</p>       | <p><a href="#">PercentageStrategyCoverageType1.1</a></p>  |
| <p>properties</p> | <p>isRef 0<br/>minOcc 0<br/>maxOcc 1<br/>content complex</p>  |
| <p>children</p>   | <p><a href="#">Value</a> <a href="#">ConsideredInInvestmentStrategy</a> <a href="#">Coverage</a> <a href="#">EligibleAssets</a></p> |
| <p>annotation</p> | <p>documentation<br/>Share_Of_Investee_Companies_Without_Deforestation_Policy (31960 - 31990)</p>                                   |

element

**EETReportType1.1/PrincipalAdverseIndicators/MoreClimateAndEnvironmentRelatedIndicators/GreenSecurities**

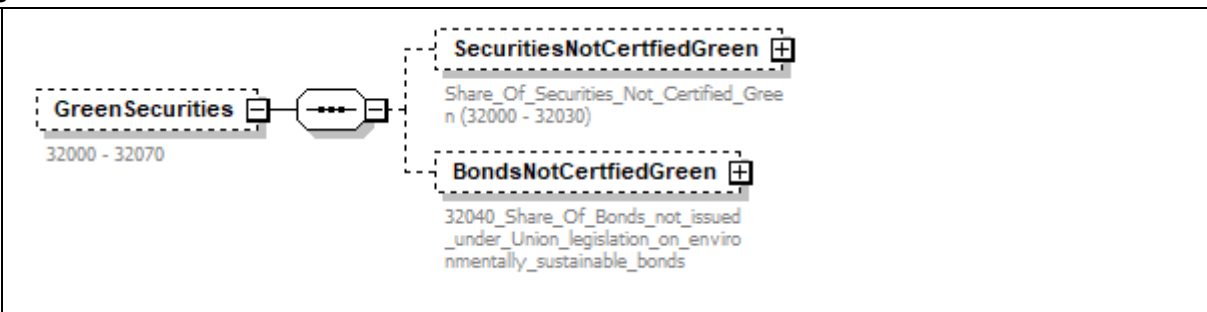
|                   |   |
|-------------------|---|
| <p>diagram</p>    |       |
| <p>properties</p> | <p>isRef 0<br/>minOcc 0<br/>maxOcc 1<br/>content complex</p>                              |
| <p>children</p>   | <p><a href="#">SecuritiesNotCertifiedGreen</a> <a href="#">BondsNotCertifiedGreen</a></p> |
| <p>annotation</p> | <p>documentation<br/>32000 - 32070</p>  |

element

**EETReportType1.1/PrincipalAdverseIndicators/MoreClimateAndEnvironmentRelatedIndicators/GreenSecurities/SecuritiesNotCertifiedGreen**

|                   |  |
|-------------------|--|
| <p>diagram</p>    | <p>The diagram illustrates the structure of the <b>SecuritiesNotCertifiedGreen</b> type. It is a complex type containing four child elements: <b>Value</b>, <b>ConsideredInInvestmentStrategy</b>, <b>Coverage</b>, and <b>EligibleAssets</b>. The diagram is titled <b>PercentageStrategyCoverageType1.1</b>.</p> <ul style="list-style-type: none"> <li><b>SecuritiesNotCertifiedGreen</b>: Share_Of_Securities_Not_Certified_Green (32000 - 32030)</li> <li><b>Value</b>: (No description provided)</li> <li><b>ConsideredInInvestmentStrategy</b>: Yes (= commitment of the asset manager to improve the PAI), No</li> <li><b>Coverage</b>: % of the notional / AUM, which provide effectively data, or where data could be estimated</li> <li><b>EligibleAssets</b>: % of assets (versus notional / AUM), which could provide data</li> </ul> |
| <p>type</p>       | <p><a href="#">PercentageStrategyCoverageType1.1</a></p>   |
| <p>properties</p> | <p>isRef 0<br/>minOcc 0<br/>maxOcc 1<br/>content complex</p>   |
| <p>children</p>   | <p><a href="#">Value</a> <a href="#">ConsideredInInvestmentStrategy</a> <a href="#">Coverage</a> <a href="#">EligibleAssets</a></p>  |
| <p>annotation</p> | <p>documentation<br/>Share_Of_Securities_Not_Certified_Green (32000 - 32030)</p>   |

element

**EETReportType1.1/PrincipalAdverseIndicators/MoreClimateAndEnvironmentRelatedIndicators/GreenSecurities/BondsNotCertifiedGreen**

|                |   |
|----------------|---|
| <p>diagram</p> | <p>The diagram illustrates the structure of the <b>BondsNotCertifiedGreen</b> type. It is a complex type containing four child elements: <b>Value</b>, <b>ConsideredInInvestmentStrategy</b>, <b>Coverage</b>, and <b>EligibleAssets</b>. The diagram is titled <b>PercentageStrategyCoverageType1.1</b>.</p> <ul style="list-style-type: none"> <li><b>BondsNotCertifiedGreen</b>: 32040_Share_Of_Bonds_not_issued_under_Union_legislation_on_environmentally_sustainable_bonds</li> <li><b>Value</b>: (No description provided)</li> <li><b>ConsideredInInvestmentStrategy</b>: Yes (= commitment of the asset manager to improve the PAI), No</li> <li><b>Coverage</b>: % of the notional / AUM, which provide effectively data, or where data could be estimated</li> <li><b>EligibleAssets</b>: % of assets (versus notional / AUM), which could provide data</li> </ul> |
|----------------|---|



|            |   |
|------------|---|
| type       | <a href="#">PercentageStrategyCoverageType1.1</a>   |
| properties | isRef 0<br>minOcc 0<br>maxOcc 1<br>content complex  |
| children   | <a href="#">Value ConsideredInInvestmentStrategy Coverage EligibleAssets</a>                                  |
| annotation | documentation<br>32040_Share_Of_Bonds_not_issued_under_Union_legislation_on_environmentally_sustainable_bonds |

element

**EETReportType1.1/PrincipalAdverseIndicators/MoreClimateAndEnvironmentRelatedIndicators/RealEstateInvestments**

|            |   |
|------------|---|
| diagram    | <pre> classDiagram     class RealEstateInvestments {         32080 - 32430     }     class GreenhouseGasEmissions {         32270     }     class EnergyConsumptionIntensity {         32310     }     class WasteProductionInOperations {         32350     }     class RawMaterialConsumptionForNewConstructionAndMajorRenovations {         32390     }     class LandArtificialisation {         32430     }     RealEstateInvestments &lt; -- GreenhouseGasEmissions     RealEstateInvestments &lt; -- EnergyConsumptionIntensity     RealEstateInvestments &lt; -- WasteProductionInOperations     RealEstateInvestments &lt; -- RawMaterialConsumptionForNewConstructionAndMajorRenovations     RealEstateInvestments &lt; -- LandArtificialisation </pre> |
| properties | isRef 0<br>minOcc 0<br>maxOcc 1<br>content complex  |
| children   | <a href="#">GreenhouseGasEmissions</a> <a href="#">EnergyConsumptionIntensity</a> <a href="#">WasteProductionInOperations</a><br><a href="#">RawMaterialConsumptionForNewConstructionAndMajorRenovations</a> <a href="#">LandArtificialisation</a>  |
| annotation | documentation<br>32080 - 32430  |

element

**EETReportType1.1/PrincipalAdverseIndicators/MoreClimateAndEnvironmentRelatedIndicators/RealEstateInvestments/GreenhouseGasEmissions**

|            |   |
|------------|---|
| diagram    | <p>The diagram shows a central element 'GreenhouseGasEmissions' with a dashed border and a small square icon. Below it is the text 'GHG_Emissions_Real_Estate (32080 - 32270)'. To its right is a hexagonal connector with three dots. From this connector, five dashed lines lead to five separate elements: 'Scope1', 'Scope2', 'Scope3', 'TotalScope12', and 'TotalScope123'. Each of these elements has a dashed border and a small square icon with a plus sign.</p> |
| properties | <p>isRef 0<br/> minOcc 0<br/> maxOcc 1<br/> content complex</p>   |
| children   | <p><a href="#">Scope1</a> <a href="#">Scope2</a> <a href="#">Scope3</a> <a href="#">TotalScope12</a> <a href="#">TotalScope123</a></p>  |
| annotation | <p>documentation<br/> GHG_Emissions_Real_Estate (32080 - 32270)</p>   |

element

**EETReportType1.1/PrincipalAdverseIndicators/MoreClimateAndEnvironmentRelatedIndicators/RealEstateInvestments/GreenhouseGasEmissions/Scope1**

|            |   |
|------------|---|
| diagram    | <p>The diagram shows a central element 'Scope1' with a dashed border and a small square icon. To its right is a hexagonal connector with three dots. From this connector, four dashed lines lead to four elements: 'Value', 'ConsideredInInvestmentStrategy', 'Coverage', and 'EligibleAssets'. These four elements are grouped within a larger dashed box labeled 'ValueStrategyCoverageType1.1'. 'Value' is a simple box. 'ConsideredInInvestmentStrategy' is a box containing the text 'Yes (= commitment of the asset manager to improve the PAI), No'. 'Coverage' is a box containing the text '% of the notional / AUM, which provide effectively data, or where data could be estimated'. 'EligibleAssets' is a box containing the text '% of assets (versus notional / AUM), which could provide data'.</p> |
| type       | <p><a href="#">ValueStrategyCoverageType1.1</a></p>   |
| properties | <p>isRef 0<br/> minOcc 0<br/> maxOcc 1<br/> content complex</p>   |
| children   | <p><a href="#">Value</a> <a href="#">ConsideredInInvestmentStrategy</a> <a href="#">Coverage</a> <a href="#">EligibleAssets</a></p>   |

element

**EETReportType1.1/PrincipalAdverseIndicators/MoreClimateAndEnvironmentRelatedIndicators/RealEst  
ateInvestments/GreenhouseGasEmissions/Scope2**

|            |  |
|------------|--|
| diagram    |  |
| type       | <a href="#">ValueStrategyCoverageType1.1</a>   |
| properties | isRef 0<br>minOcc 0<br>maxOcc 1<br>content complex   |
| children   | <a href="#">Value</a> <a href="#">ConsideredInInvestmentStrategy</a> <a href="#">Coverage</a> <a href="#">EligibleAssets</a> |

element

**EETReportType1.1/PrincipalAdverseIndicators/MoreClimateAndEnvironmentRelatedIndicators/RealEst  
ateInvestments/GreenhouseGasEmissions/Scope3**

|            |  |
|------------|--|
| diagram    |  |
| type       | <a href="#">ValueStrategyCoverageType1.1</a> |
| properties | isRef 0<br>minOcc 0                          |

|          |  |
|----------|--|
|          | maxOcc 1<br>content complex  |
| children | <a href="#">Value</a> <a href="#">ConsideredInInvestmentStrategy</a> <a href="#">Coverage</a> <a href="#">EligibleAssets</a> |

element

**EETReportType1.1/PrincipalAdverseIndicators/MoreClimateAndEnvironmentRelatedIndicators/RealEst  
ateInvestments/GreenhouseGasEmissions/TotalScope12**

|            |   |
|------------|---|
| diagram    | <pre> classDiagram     class TotalScope12     class ValueStrategyCoverageType11["ValueStrategyCoverageType1.1"]     class Value     class ConsideredInInvestmentStrategy     class Coverage     class EligibleAssets      TotalScope12 -- ValueStrategyCoverageType11     ValueStrategyCoverageType11 -- Value     ValueStrategyCoverageType11 -- ConsideredInInvestmentStrategy     ValueStrategyCoverageType11 -- Coverage     ValueStrategyCoverageType11 -- EligibleAssets     </pre> <p><b>ValueStrategyCoverageType1.1</b></p> <ul style="list-style-type: none"> <li><b>Value</b></li> <li><b>ConsideredInInvestmentStrategy</b><br/>Yes (= commitment of the asset manager to improve the PAI), No</li> <li><b>Coverage</b><br/>% of the notional / AUM, which provide effectively data, or where data could be estimated</li> <li><b>EligibleAssets</b><br/>% of assets (versus notional / AUM), which could provide data</li> </ul> |
| type       | <a href="#">ValueStrategyCoverageType1.1</a>  |
| properties | isRef 0<br>minOcc 0<br>maxOcc 1<br>content complex  |
| children   | <a href="#">Value</a> <a href="#">ConsideredInInvestmentStrategy</a> <a href="#">Coverage</a> <a href="#">EligibleAssets</a>  |

element

**EETReportType1.1/PrincipalAdverseIndicators/MoreClimateAndEnvironmentRelatedIndicators/RealEst  
ateInvestments/GreenhouseGasEmissions/TotalScope123**

|            |   |
|------------|---|
| diagram    | <p>The diagram illustrates the structure of the TotalScope123 element. It is connected to a central node labeled 'Value Strategy Coverage Type 1.1'. This node is further divided into four sub-elements: 'Value', 'Considered Investment Strategy', 'Coverage', and 'Eligible Assets'. The 'Considered Investment Strategy' element includes a description: 'Yes (= commitment of the asset manager to improve the PAI), No'. The 'Coverage' element includes a description: '% of the notional / AUM, which provide effectively data, or where data could be estimated'. The 'Eligible Assets' element includes a description: '% of assets (versus notional / AUM), which could provide data'.</p> |
| type       | <a href="#">ValueStrategyCoverageType1.1</a>  |
| properties | isRef 0<br>minOcc 0<br>maxOcc 1<br>content complex  |
| children   | <a href="#">Value</a> <a href="#">ConsideredInvestmentStrategy</a> <a href="#">Coverage</a> <a href="#">EligibleAssets</a>  |

element

**EETReportType1.1/PrincipalAdverseIndicators/MoreClimateAndEnvironmentRelatedIndicators/RealEst  
ateInvestments/EnergyConsumptionIntensity**

|         |  |
|---------|--|
| diagram | <p>The diagram illustrates the structure of the EnergyConsumptionIntensity element. It is connected to a central node labeled 'Value Strategy Coverage Type 1.1'. This node is further divided into four sub-elements: 'Value', 'Considered Investment Strategy', 'Coverage', and 'Eligible Assets'. The 'Considered Investment Strategy' element includes a description: 'Yes (= commitment of the asset manager to improve the PAI), No'. The 'Coverage' element includes a description: '% of the notional / AUM, which provide effectively data, or where data could be estimated'. The 'Eligible Assets' element includes a description: '% of assets (versus notional / AUM), which could provide data'.</p> |
| type    | <a href="#">ValueStrategyCoverageType1.1</a>   |

|            |  |
|------------|--|
| properties | isRef 0<br>minOcc 0<br>maxOcc 1<br>content complex   |
| children   | <a href="#">Value</a> <a href="#">ConsideredInInvestmentStrategy</a> <a href="#">Coverage</a> <a href="#">EligibleAssets</a> |
| annotation | documentation<br>Energy_Consumption_Intensity (32280 - 32310)  |

element

**EETReportType1.1/PrincipalAdverseIndicators/MoreClimateAndEnvironmentRelatedIndicators/RealEst  
ateInvestments/WasteProductionInOperations**

|            |  |
|------------|--|
| diagram    | <p>The diagram illustrates the composition of the <b>PercentageStrategyCoverageType1.1</b> element. It features a central box for <b>WasteProductionInOperations</b> (Waste_Production_In_Operations (32320 - 32350)) which is connected to a larger, yellow-shaded box representing <b>PercentageStrategyCoverageType1.1</b>. This larger box contains four sub-elements: <b>Value</b>, <b>ConsideredInInvestmentStrategy</b> (Yes (= commitment of the asset manager to improve the PAI), No), <b>Coverage</b> (% of the notional / AUM, which provide effectively data, or where data could be estimated), and <b>EligibleAssets</b> (% of assets (versus notional / AUM), which could provide data).</p> |
| type       | <a href="#">PercentageStrategyCoverageType1.1</a>  |
| properties | isRef 0<br>minOcc 0<br>maxOcc 1<br>content complex   |
| children   | <a href="#">Value</a> <a href="#">ConsideredInInvestmentStrategy</a> <a href="#">Coverage</a> <a href="#">EligibleAssets</a>   |
| annotation | documentation<br>Waste_Production_In_Operations (32320 - 32350)  |

element

**EETReportType1.1/PrincipalAdverseIndicators/MoreClimateAndEnvironmentRelatedIndicators/RealEstateInvestments/RawMaterialConsumptionForNewConstructionAndMajorRenovations**

|            |   |
|------------|---|
| diagram    | <p><b>PercentageStrategyCoverageType1.1</b></p> <ul style="list-style-type: none"><li><b>Value</b></li><li><b>ConsideredInInvestmentStrategy</b><br/>Yes (= commitment of the asset manager to improve the PAI), No</li><li><b>Coverage</b><br/>% of the notional / AUM, which provide effectively data, or where data could be estimated</li><li><b>EligibleAssets</b><br/>% of assets (versus notional / AUM), which could provide data</li></ul> <p><b>RawMaterialConsumptionForNewConstructionAndMajorRenovations</b><br/>Raw_Material_Consumption_For_New_Construction_And_Major_Renovations (32360 - 32390)</p> |
| type       | <a href="#">PercentageStrategyCoverageType1.1</a>   |
| properties | isRef 0<br>minOcc 0<br>maxOcc 1<br>content complex  |
| children   | <a href="#">Value</a> <a href="#">ConsideredInInvestmentStrategy</a> <a href="#">Coverage</a> <a href="#">EligibleAssets</a>  |
| annotation | documentation<br>Raw_Material_Consumption_For_New_Construction_And_Major_Renovations (32360 - 32390)  |

element

**EETReportType1.1/PrincipalAdverseIndicators/MoreClimateAndEnvironmentRelatedIndicators/RealEst  
ateInvestments/LandArtificialisation**

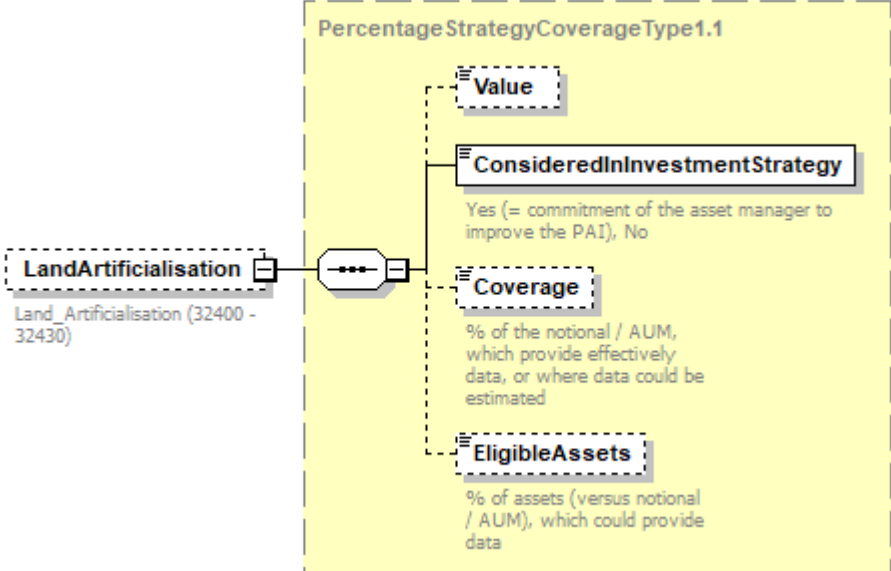
|                   |   |
|-------------------|---|
| <p>diagram</p>    |   |
| <p>type</p>       | <p><a href="#">PercentageStrategyCoverageType1.1</a></p>  |
| <p>properties</p> | <p>isRef 0<br/>minOcc 0<br/>maxOcc 1<br/>content complex</p>  |
| <p>children</p>   | <p><a href="#">Value</a> <a href="#">ConsideredInInvestmentStrategy</a> <a href="#">Coverage</a> <a href="#">EligibleAssets</a></p> |
| <p>annotation</p> | <p>documentation<br/>Land_Artificialisation (32400 - 32430)</p>   |

element **EETReportType1.1/PrincipalAdverseIndicators/MoreSocialAndEmployeeMatters**

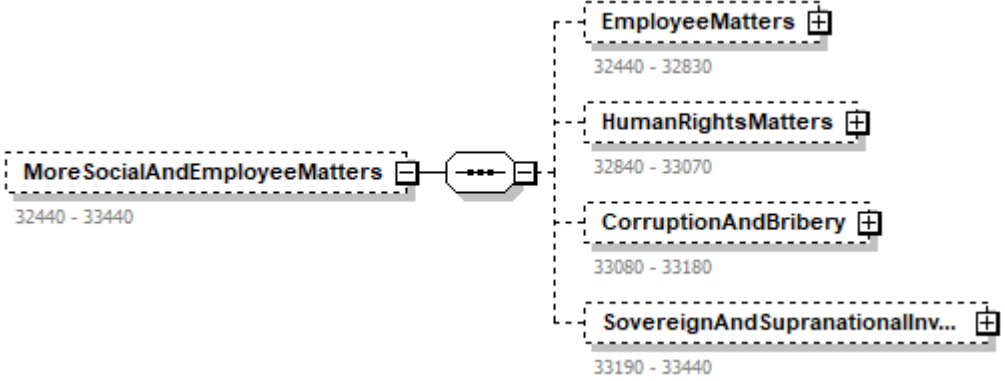
|                   |   |
|-------------------|---|
| <p>diagram</p>    |   |
| <p>properties</p> | <p>isRef 0<br/>minOcc 0<br/>maxOcc 1<br/>content complex</p>  |
| <p>children</p>   | <p><a href="#">EmployeeMatters</a> <a href="#">HumanRightsMatters</a> <a href="#">CorruptionAndBribery</a> <a href="#">SovereignAndSupranationalInvestments</a></p> |
| <p>annotation</p> | <p>documentation<br/>32440 - 33440</p>  |



element

**EETReportType1.1/PrincipalAdverseIndicators/MoreSocialAndEmployeeMatters/EmployeeMatters**

|                   |   |
|-------------------|---|
| <p>diagram</p>    | <p><b>EmployeeMatters</b> 32440 - 32830</p> <ul style="list-style-type: none"> <li><b>CompaniesWithoutWorkplaceA...</b> 32440 - 32470<br/>Exposure_To_Companies_Without_Workplace_Accident_Prevention_Policy (32440 - 32470)</li> <li><b>RateOfAccidents</b> 32480 - 32510<br/>Rate_Of_Accidents (32480 - 32510)</li> <li><b>NumberOfDaysLostForInjuries...</b> 32520 - 32550<br/>Number_Of_Days_Lost_For_Injuries_Accidents_Fatalities_Illness (32520 - 32550)</li> <li><b>CompaniesWithoutAnySupplier...</b> 32560 - 32590<br/>Share_Of_Investments_In_Investee_Companies_Without_Any_Supplier_Code_Of_Conduct_Against_Unsafe_Working_Conditions_Precarious_Work_Child_Labour_And_Forced_Labour (32560 - 32590)</li> <li><b>CompaniesWithoutAnyGrievan...</b> 32640 - 32670<br/>Share_Of_Investments_In_Investee_Companies_Without_Any_Grievance_Or_Complaints_Handling_Mechanism (32640 - 32670)</li> <li><b>CompaniesWithInsufficientWhi...</b> 32680 - 32710<br/>Share_Of_Investee_Companies_With_Insufficient_Whistleblower_Protection (32680 - 32710)</li> <li><b>NumberOfIncidentsOfDiscrimin...</b> 32720 - 32750<br/>Number_Of_Incidents_Of_Discrimination_Repored_In_Investee_Companies (32720 - 32750)</li> <li><b>NumberOfIncidentsOfDiscrimin...</b> 32760 - 32790<br/>Number_Of_Incidents_Of_Discrimination_Leading_To_Sanctions_In_Investee_Companies (32760 - 32790)</li> <li><b>ExcessiveCEOPayRatio</b> 32800 - 32830<br/>Excessive_CEO_Pay_Ratio (32800 - 32830)</li> </ul> |
| <p>properties</p> | <p>isRef 0<br/>minOcc 0<br/>maxOcc 1<br/>content complex</p>  |
| <p>children</p>   | <p><a href="#">CompaniesWithoutWorkplaceAccidentPreventionPolicy</a> <a href="#">RateOfAccidents</a> <a href="#">NumberOfDaysLostForInjuriesAccidentsFatalitiesIllness</a> <a href="#">CompaniesWithoutAnySupplierCodeOfConductAgainstUnsafeWorkingConditions</a> <a href="#">CompaniesWithoutAnyGrievanceOrComplaintsHandlingMechanism</a> <a href="#">CompaniesWithInsufficientWhistleblowerProtection</a> <a href="#">NumberOfIncidentsOfDiscriminationReported</a> <a href="#">NumberOfIncidentsOfDiscriminationLeadingToSanctions</a> <a href="#">ExcessiveCEOPayRatio</a></p>   |
| <p>annotation</p> | <p>documentation<br/>32440 - 32830</p>  |

element

### EETReportType1.1/PrincipalAdverseIndicators/MoreSocialAndEmployeeMatters/EmployeeMatters/CompaniesWithoutWorkplaceAccidentPreventionPolicy

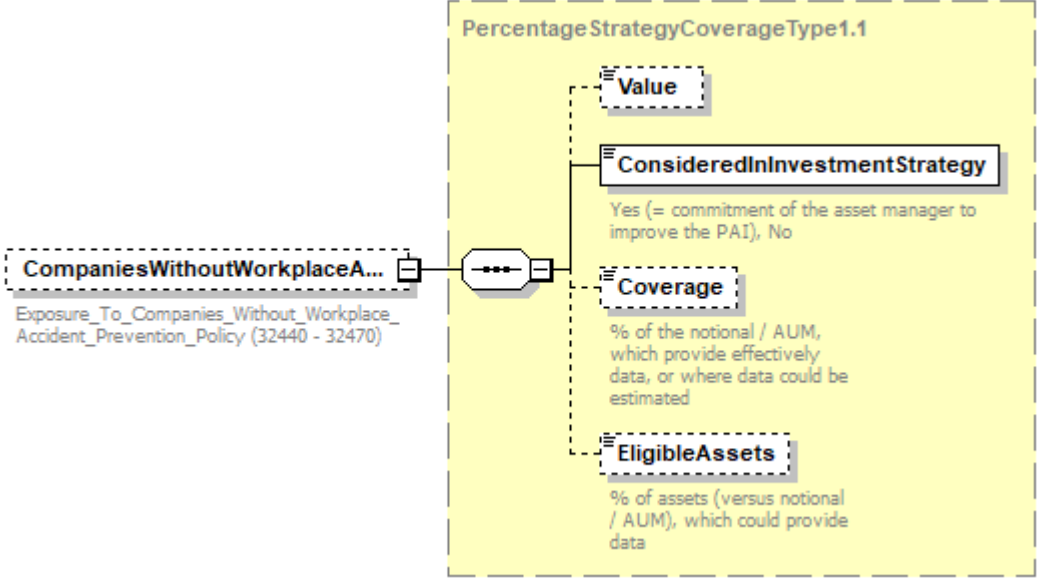
|            |   |
|------------|---|
| diagram    |  <p>The diagram shows a class hierarchy. On the left is a dashed box labeled <b>CompaniesWithoutWorkplaceA...</b> with the text "Exposure_To_Companies_Without_Workplace_Accident_Prevention_Policy (32440 - 32470)". A solid line connects it to a central octagonal connector. From this connector, a dashed line leads to a yellow dashed box titled <b>PercentageStrategyCoverageType1.1</b>. Inside this box, three dashed boxes are connected to the central connector: <b>Value</b>, <b>ConsideredInInvestmentStrategy</b> (with text "Yes (= commitment of the asset manager to improve the PAI), No"), and <b>Coverage</b> (with text "% of the notional / AUM, which provide effectively data, or where data could be estimated"). Below these is another dashed box <b>EligibleAssets</b> (with text "% of assets (versus notional / AUM), which could provide data").</p> |
| type       | <a href="#">PercentageStrategyCoverageType1.1</a>   |
| properties | isRef 0<br>minOcc 0<br>maxOcc 1<br>content complex  |
| children   | <a href="#">Value</a> <a href="#">ConsideredInInvestmentStrategy</a> <a href="#">Coverage</a> <a href="#">EligibleAssets</a>  |
| annotation | documentation<br>Exposure_To_Companies_Without_Workplace_Accident_Prevention_Policy (32440 - 32470)   |

element

### EETReportType1.1/PrincipalAdverseIndicators/MoreSocialAndEmployeeMatters/EmployeeMatters/RateOfAccidents

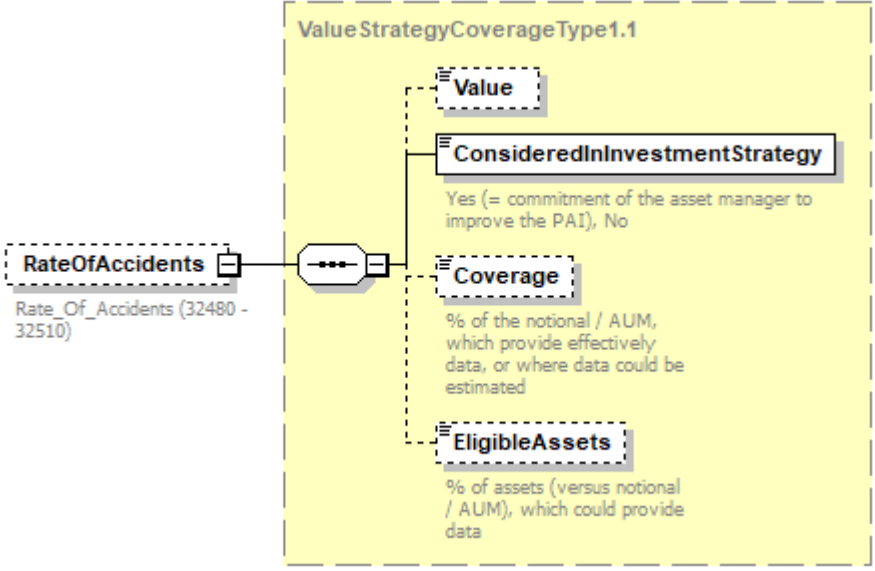
|         |   |
|---------|---|
| diagram |  <p>The diagram shows a class hierarchy. On the left is a dashed box labeled <b>RateOfAccidents</b> with the text "Rate_Of_Accidents (32480 - 32510)". A solid line connects it to a central octagonal connector. From this connector, a dashed line leads to a yellow dashed box titled <b>ValueStrategyCoverageType1.1</b>. Inside this box, three dashed boxes are connected to the central connector: <b>Value</b>, <b>ConsideredInInvestmentStrategy</b> (with text "Yes (= commitment of the asset manager to improve the PAI), No"), and <b>Coverage</b> (with text "% of the notional / AUM, which provide effectively data, or where data could be estimated"). Below these is another dashed box <b>EligibleAssets</b> (with text "% of assets (versus notional / AUM), which could provide data").</p> |
|---------|---|

|            |  |
|------------|--|
| type       | <a href="#">ValueStrategyCoverageType1.1</a>   |
| properties | isRef 0<br>minOcc 0<br>maxOcc 1<br>content complex   |
| children   | <a href="#">Value</a> <a href="#">ConsideredInInvestmentStrategy</a> <a href="#">Coverage</a> <a href="#">EligibleAssets</a> |
| annotation | documentation<br>Rate_Of_Accidents (32480 - 32510)   |

element

**EETReportType1.1/PrincipalAdverseIndicators/MoreSocialAndEmployeeMatters/EmployeeMatters/NumberOfDaysLostForInjuriesAccidentsFatalitiesIllness**

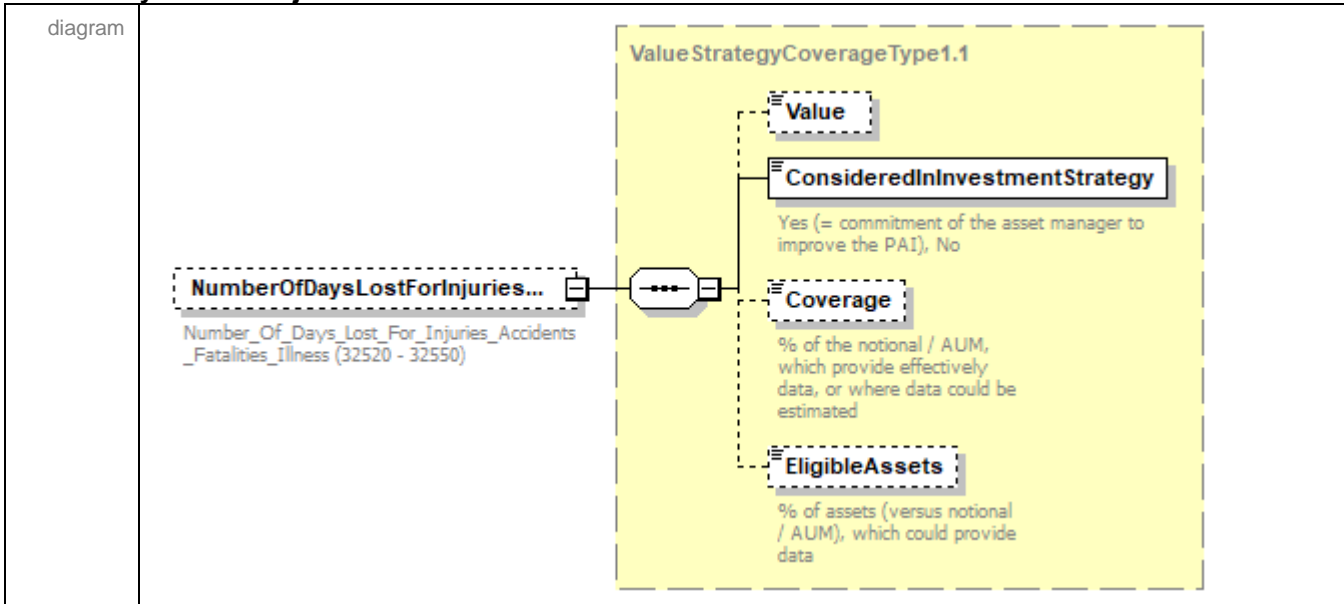

|            |  |
|------------|--|
| type       | <a href="#">ValueStrategyCoverageType1.1</a>   |
| properties | isRef 0<br>minOcc 0<br>maxOcc 1<br>content complex   |
| children   | <a href="#">Value</a> <a href="#">ConsideredInInvestmentStrategy</a> <a href="#">Coverage</a> <a href="#">EligibleAssets</a> |
| annotation | documentation<br>Number_Of_Days_Lost_For_Injuries_Accidents_Fatalities_Illness (32520 - 32550)                               |

element

**EETReportType1.1/PrincipalAdverseIndicators/MoreSocialAndEmployeeMatters/EmployeeMatters/CompaniesWithoutAnySupplierCodeOfConductAgainstUnsafeWorkingConditions**

|                   |   |
|-------------------|---|
| <p>diagram</p>    |   |
| <p>type</p>       | <p><a href="#">PercentageStrategyCoverageType1.1</a></p>  |
| <p>properties</p> | <p>isRef 0<br/>minOcc 0<br/>maxOcc 1<br/>content complex</p>  |
| <p>children</p>   | <p><a href="#">Value</a> <a href="#">ConsideredInInvestmentStrategy</a> <a href="#">Coverage</a> <a href="#">EligibleAssets</a></p>   |
| <p>annotation</p> | <p>documentation<br/>Share_Of_Investments_In_Investee_Companies_Without_Any_Supplier_Code_Of_Conduct_Against_Unsafe_Working_Conditions_Precarious_Work_Child_Labour_And_Forced_Labour (32560 - 32590)</p> |

element

**EETReportType1.1/PrincipalAdverseIndicators/MoreSocialAndEmployeeMatters/EmployeeMatters/CompaniesWithoutAnyGrievanceOrComplaintsHandlingMechanism**

|                   |  |
|-------------------|--|
| <p>diagram</p>    |  |
| <p>type</p>       | <p><a href="#">PercentageStrategyCoverageType1.1</a></p>   |
| <p>properties</p> | <p>isRef 0<br/>minOcc 0<br/>maxOcc 1<br/>content complex</p>   |
| <p>children</p>   | <p><a href="#">Value</a> <a href="#">ConsideredInInvestmentStrategy</a> <a href="#">Coverage</a> <a href="#">EligibleAssets</a></p>        |
| <p>annotation</p> | <p>documentation<br/>Share_Of_Investments_In_Investee_Companies_Without_Any_Grievance_Or_Complaints_Handling_Mechanism (32640 - 32670)</p> |

element

**EETReportType1.1/PrincipalAdverseIndicators/MoreSocialAndEmployeeMatters/EmployeeMatters/CompaniesWithInsufficientWhistleblowerProtection**

|                   |   |
|-------------------|---|
| <p>diagram</p>    |   |
| <p>type</p>       | <p><a href="#">PercentageStrategyCoverageType1.1</a></p>  |
| <p>properties</p> | <p>isRef 0<br/>minOcc 0<br/>maxOcc 1<br/>content complex</p>  |
| <p>children</p>   | <p><a href="#">Value</a> <a href="#">ConsideredInInvestmentStrategy</a> <a href="#">Coverage</a> <a href="#">EligibleAssets</a></p> |
| <p>annotation</p> | <p>documentation<br/>Share_Of_Investee_Companies_With_Insufficient_Whistleblower_Protection (32680 - 32710)</p>                     |

element

**EETReportType1.1/PrincipalAdverseIndicators/MoreSocialAndEmployeeMatters/EmployeeMatters/NumberOfIncidentsOfDiscriminationReported**

|                |  |
|----------------|--|
| <p>diagram</p> |  |
|----------------|--|

|            |  |
|------------|--|
| type       | <a href="#">ValueStrategyCoverageType1.1</a>   |
| properties | isRef 0<br>minOcc 0<br>maxOcc 1<br>content complex   |
| children   | <a href="#">Value</a> <a href="#">ConsideredInInvestmentStrategy</a> <a href="#">Coverage</a> <a href="#">EligibleAssets</a> |
| annotation | documentation<br>Number_Of_Incidents_Of_Discrimination_Reported_In_Investee_Companies (32720 - 32750)                        |

element

**EETReportType1.1/PrincipalAdverseIndicators/MoreSocialAndEmployeeMatters/EmployeeMatters/NumberOfIncidentsOfDiscriminationLeadingToSanctions**

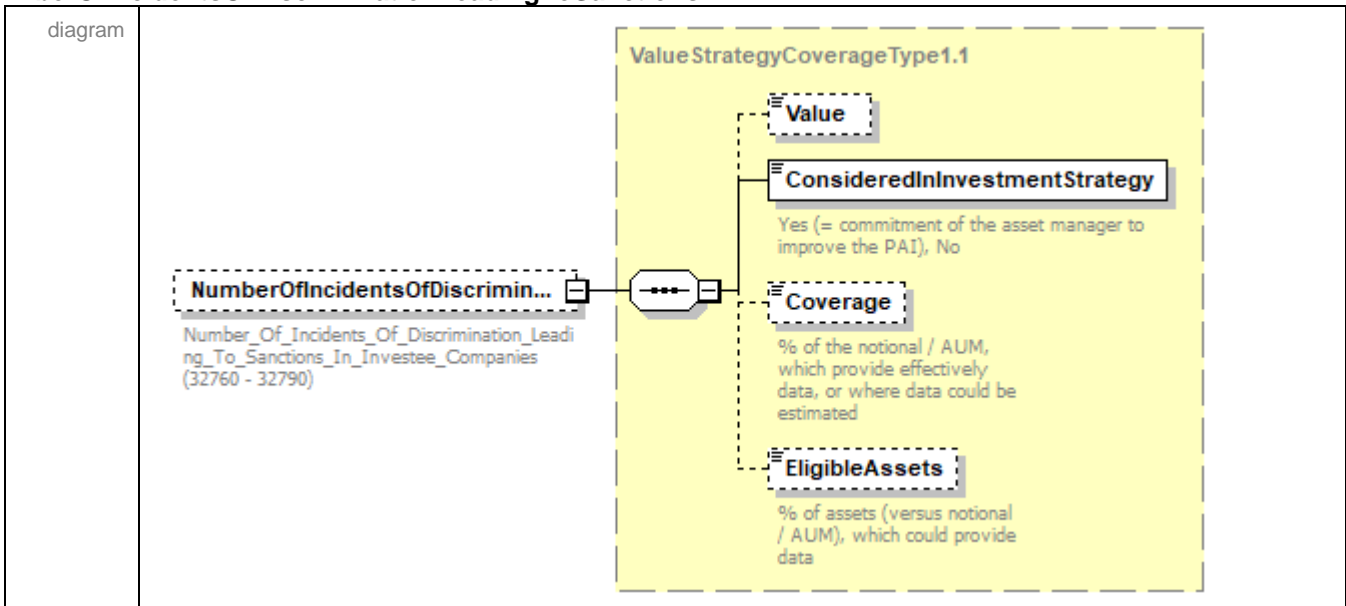

|            |  |
|------------|--|
| type       | <a href="#">ValueStrategyCoverageType1.1</a>   |
| properties | isRef 0<br>minOcc 0<br>maxOcc 1<br>content complex   |
| children   | <a href="#">Value</a> <a href="#">ConsideredInInvestmentStrategy</a> <a href="#">Coverage</a> <a href="#">EligibleAssets</a> |
| annotation | documentation<br>Number_Of_Incidents_Of_Discrimination_Leading_To_Sanctions_In_Investee_Companies (32760 - 32790)            |

element

**EETReportType1.1/PrincipalAdverseIndicators/MoreSocialAndEmployeeMatters/EmployeeMatters/ExcessiveCEOPayRatio**

|                   |   |
|-------------------|---|
| <p>diagram</p>    |   |
| <p>type</p>       | <p><a href="#">ValueStrategyCoverageType1.1</a></p>   |
| <p>properties</p> | <p>isRef 0<br/>minOcc 0<br/>maxOcc 1<br/>content complex</p>  |
| <p>children</p>   | <p><a href="#">Value</a> <a href="#">ConsideredInvestmentStrategy</a> <a href="#">Coverage</a> <a href="#">EligibleAssets</a></p> |
| <p>annotation</p> | <p>documentation<br/>Excessive_CEO_Pay_Ratio (32800 - 32830)</p>  |



element

**EETReportType1.1/PrincipalAdverseIndicators/MoreSocialAndEmployeeMatters/HumanRightsMatters**

|                   |   |
|-------------------|---|
| <p>diagram</p>    | <pre> classDiagram     class HumanRightsMatters {         32840 - 33070     }     class CompaniesWithoutHumanRightPolicy {         Exposure_To_Companies_Without_Human_Right_Policy (32840 - 32870)     }     class CompaniesWithLackOfDueDiligence {         Exposure_To_Companies_With_Lack_Of_Due_Diligence (32880 - 32910)     }     class CompaniesWithoutSufficientHumanTraffickingPrevention {         Exposure_To_Companies_With_Lack_Of_Processes_And_Measures_For_Preventing_Trafficking_In_Human_Beings_Local (32920 - 32950)     }     class CompaniesOperationsSuppliersSignificantRiskChildLabour {         Exposure_To_Compagnies_With_Operations_And_Suppliers_At_Significant_Risk_Of_Incidents_Of_Child_Labour (32960 - 32990)     }     class CompaniesOperationsSuppliersSignificantRiskForcedLabour {         Exposure_To_Compagnies_With_Operations_And_Suppliers_At_Significant_Risk_Of_Incidents_Of_Forced_Or_Compulsory_Labour (33000 - 33030)     }     class NumberOfCasesOfSevereHumanRightsIssues {         Number_Of_Identified_Cases_Of_Severe_Human_Rights_Issues_And_Incidents (33040 - 33070)     }     HumanRightsMatters &lt; -- CompaniesWithoutHumanRightPolicy     HumanRightsMatters &lt; -- CompaniesWithLackOfDueDiligence     HumanRightsMatters &lt; -- CompaniesWithoutSufficientHumanTraffickingPrevention     HumanRightsMatters &lt; -- CompaniesOperationsSuppliersSignificantRiskChildLabour     HumanRightsMatters &lt; -- CompaniesOperationsSuppliersSignificantRiskForcedLabour     HumanRightsMatters &lt; -- NumberOfCasesOfSevereHumanRightsIssues         </pre> |
| <p>properties</p> | <p>isRef 0<br/>minOcc 0<br/>maxOcc 1<br/>content complex</p>  |
| <p>children</p>   | <p><a href="#">CompaniesWithoutHumanRightPolicy</a> <a href="#">CompaniesWithLackOfDueDiligence</a><br/><a href="#">CompaniesWithoutSufficientHumanTraffickingPrevention</a><br/><a href="#">CompaniesOperationsSuppliersSignificantRiskChildLabour</a><br/><a href="#">CompaniesOperationsSuppliersSignificantRiskForcedLabour</a> <a href="#">NumberOfCasesOfSevereHumanRightsIssues</a></p>  |
| <p>annotation</p> | <p>documentation<br/>32840 - 33070</p>  |

element

**EETReportType1.1/PrincipalAdverseIndicators/MoreSocialAndEmployeeMatters/HumanRightsMatters/  
CompaniesWithoutHumanRightPolicy**

|                   |   |
|-------------------|---|
| <p>diagram</p>    |   |
| <p>type</p>       | <p><a href="#">PercentageStrategyCoverageType1.1</a></p>  |
| <p>properties</p> | <p>isRef 0<br/>minOcc 0<br/>maxOcc 1<br/>content complex</p>  |
| <p>children</p>   | <p><a href="#">Value</a> <a href="#">ConsideredInInvestmentStrategy</a> <a href="#">Coverage</a> <a href="#">EligibleAssets</a></p> |
| <p>annotation</p> | <p>documentation<br/>Exposure_To_Companies_Without_Human_Right_Policy (32840 - 32870)</p>   |

element

**EETReportType1.1/PrincipalAdverseIndicators/MoreSocialAndEmployeeMatters/HumanRightsMatters/  
CompaniesWithLackOfDueDiligence**

|                   |   |
|-------------------|---|
| <p>diagram</p>    |   |
| <p>type</p>       | <p><a href="#">PercentageStrategyCoverageType1.1</a></p>  |
| <p>properties</p> | <p>isRef 0<br/>minOcc 0<br/>maxOcc 1<br/>content complex</p>  |
| <p>children</p>   | <p><a href="#">Value</a> <a href="#">ConsideredInInvestmentStrategy</a> <a href="#">Coverage</a> <a href="#">EligibleAssets</a></p> |
| <p>annotation</p> | <p>documentation<br/>Exposure_To_Companies_With_Lack_Of_Due_Diligence (32880 - 32910)</p>   |

element

**EETReportType1.1/PrincipalAdverseIndicators/MoreSocialAndEmployeeMatters/HumanRightsMatters/CompaniesWithoutSufficientHumanTraffickingPrevention**

|                   |   |
|-------------------|---|
| <p>diagram</p>    |   |
| <p>type</p>       | <p><a href="#">PercentageStrategyCoverageType1.1</a></p>  |
| <p>properties</p> | <p>isRef 0<br/>minOcc 0<br/>maxOcc 1<br/>content complex</p>  |
| <p>children</p>   | <p><a href="#">Value</a> <a href="#">ConsideredInInvestmentStrategy</a> <a href="#">Coverage</a> <a href="#">EligibleAssets</a></p>                 |
| <p>annotation</p> | <p>documentation<br/>Exposure_To_Companies_With_Lack_Of_Processes_And_Measures_For_Preventing_Trafficking_In_Human_Beings_Local (32920 - 32950)</p> |

element

**EETReportType1.1/PrincipalAdverseIndicators/MoreSocialAndEmployeeMatters/HumanRightsMatters/  
CompaniesOperationsSuppliersSignificantRiskChildLabour**

|            |  |
|------------|--|
| diagram    | <p><b>PercentageStrategyCoverageType1.1</b></p> <ul style="list-style-type: none"><li><b>Value</b></li><li><b>ConsideredInInvestmentStrategy</b><br/>Yes (= commitment of the asset manager to improve the PAI), No</li><li><b>Coverage</b><br/>% of the notional / AUM, which provide effectively data, or where data could be estimated</li><li><b>EligibleAssets</b><br/>% of assets (versus notional / AUM), which could provide data</li></ul> <p><b>CompaniesOperationsSupplier...</b><br/>Exposure_To_Compagnies_With_Operations_And_Suppliers_At_Significant_Risk_Of_Incidents_Of_Child_Labour (32960 - 32990)</p> |
| type       | <a href="#">PercentageStrategyCoverageType1.1</a>  |
| properties | isRef 0<br>minOcc 0<br>maxOcc 1<br>content complex   |
| children   | <a href="#">Value</a> <a href="#">ConsideredInInvestmentStrategy</a> <a href="#">Coverage</a> <a href="#">EligibleAssets</a>   |
| annotation | documentation<br>Exposure_To_Compagnies_With_Operations_And_Suppliers_At_Significant_Risk_Of_Incidents_Of_Child_Labour (32960 - 32990)   |

element

**EETReportType1.1/PrincipalAdverseIndicators/MoreSocialAndEmployeeMatters/HumanRightsMatters/CompaniesOperationsSuppliersSignificantRiskForcedLabour**

|                   |   |
|-------------------|---|
| <p>diagram</p>    |   |
| <p>type</p>       | <p><a href="#">PercentageStrategyCoverageType1.1</a></p>  |
| <p>properties</p> | <p>isRef 0<br/>minOcc 0<br/>maxOcc 1<br/>content complex</p>  |
| <p>children</p>   | <p><a href="#">Value</a> <a href="#">ConsideredInInvestmentStrategy</a> <a href="#">Coverage</a> <a href="#">EligibleAssets</a></p>                           |
| <p>annotation</p> | <p>documentation<br/>Exposure_To_Compagnies_With_Operations_And_Suppliers_At_Significant_Risk_Of_Incidents_Of_Forced_Or_Compulsory_Labour (33000 - 33030)</p> |

element

**EETReportType1.1/PrincipalAdverseIndicators/MoreSocialAndEmployeeMatters/HumanRightsMatters/NumberOfCasesOfSevereHumanRightsIssues**

|                   |   |
|-------------------|---|
| <p>diagram</p>    |   |
| <p>type</p>       | <p><a href="#">ValueStrategyCoverageType1.1</a></p>   |
| <p>properties</p> | <p>isRef 0<br/>minOcc 0<br/>maxOcc 1<br/>content complex</p>  |
| <p>children</p>   | <p><a href="#">Value</a> <a href="#">ConsideredInInvestmentStrategy</a> <a href="#">Coverage</a> <a href="#">EligibleAssets</a></p> |
| <p>annotation</p> | <p>documentation<br/>Number_Of_Identified_Cases_of_Severe_Human_Rights_Issues_And_Incidents (33040 - 33070)</p>                     |

element

**EETReportType1.1/PrincipalAdverseIndicators/MoreSocialAndEmployeeMatters/CorruptionAndBribery**

|                   |   |
|-------------------|---|
| <p>diagram</p>    |   |
| <p>properties</p> | <p>isRef 0<br/>minOcc 0<br/>maxOcc 1<br/>content complex</p>  |
| <p>children</p>   | <p><a href="#">CompaniesWithLackOfAntiCorruptionAndAntiBriberyPolicies</a><br/><a href="#">CompaniesInsufficientReactionsOnCorruptionAndBribery</a> <a href="#">ConvictionsOfAntiCorruptionAndAntiBriberyLaws</a></p> |

|            |                                |
|------------|--------------------------------|
| annotation | documentation<br>33080 - 33180 |
|------------|--------------------------------|

element

**EETReportType1.1/PrincipalAdverseIndicators/MoreSocialAndEmployeeMatters/CorruptionAndBribery/  
CompaniesWithLackOfAntiCorruptionAndAntiBriberyPolicies**

|            |  |
|------------|--|
| diagram    | <p>The diagram illustrates the structure of the <b>PercentageStrategyCoverageType1.1</b> element. On the left, a dashed box represents the parent element <b>CompaniesWithLackOfAntiCorr...</b> with the description: "Exposure_To_Compagnies_With_Alack_Of_Anti_Corruption_And_Anti_Bribery_Policies (33080 - 33110)". This element is connected to a central connector box, which in turn connects to a large yellow dashed box representing the <b>PercentageStrategyCoverageType1.1</b> element. Inside this yellow box, four sub-elements are listed: <b>Value</b>, <b>ConsideredInInvestmentStrategy</b> (with a description: "Yes (= commitment of the asset manager to improve the PAI), No"), <b>Coverage</b> (with a description: "% of the notional / AUM, which provide effectively data, or where data could be estimated"), and <b>EligibleAssets</b> (with a description: "% of assets (versus notional / AUM), which could provide data").</p> |
| type       | <a href="#">PercentageStrategyCoverageType1.1</a>  |
| properties | <ul style="list-style-type: none"> <li>isRef 0</li> <li>minOcc 0</li> <li>maxOcc 1</li> <li>content complex</li> </ul>   |
| children   | <a href="#">Value</a> <a href="#">ConsideredInInvestmentStrategy</a> <a href="#">Coverage</a> <a href="#">EligibleAssets</a>   |
| annotation | documentation<br>Exposure_To_Compagnies_With_Alack_Of_Anti_Corruption_And_Anti_Bribery_Policies (33080 - 33110)  |



element

**EETReportType1.1/PrincipalAdverseIndicators/MoreSocialAndEmployeeMatters/CorruptionAndBribery/  
CompaniesInsufficientReactionsOnCorruptionAndBribery**

|                   |   |
|-------------------|---|
| <p>diagram</p>    |   |
| <p>type</p>       | <p><a href="#">PercentageStrategyCoverageType1.1</a></p>  |
| <p>properties</p> | <p>isRef 0<br/>minOcc 0<br/>maxOcc 1<br/>content complex</p>  |
| <p>children</p>   | <p><a href="#">Value</a> <a href="#">ConsideredInInvestmentStrategy</a> <a href="#">Coverage</a> <a href="#">EligibleAssets</a></p>   |
| <p>annotation</p> | <p>documentation<br/>Exposure_To_Companies_With_Cases_Of_Insufficient_Action_Taken_To_Address_Breaches_Of_Standards_Of_Anti_Corruption_And_Anti_Bribery (33120 - 33145)</p> |

element

**EETReportType1.1/PrincipalAdverseIndicators/MoreSocialAndEmployeeMatters/CorruptionAndBribery/ConvictionsOfAntiCorruptionAndAntiBriberyLaws**

|                   |   |
|-------------------|---|
| <p>diagram</p>    |   |
| <p>type</p>       | <p><a href="#">ValueStrategyCoverageType1.1</a></p>   |
| <p>properties</p> | <p>isRef 0<br/>minOcc 0<br/>maxOcc 1<br/>content complex</p>  |
| <p>children</p>   | <p><a href="#">Value</a> <a href="#">ConsideredInInvestmentStrategy</a> <a href="#">Coverage</a> <a href="#">EligibleAssets</a></p> |
| <p>annotation</p> | <p>documentation<br/>Number_Of_Convictions_For_Violation_Of_Anti_Corruption_And_Anti_Bribery_Laws (33150 - 33180)</p>               |

element

**EETReportType1.1/PrincipalAdverseIndicators/MoreSocialAndEmployeeMatters/SovereignAndSupranationalInvestments**

|                   |   |
|-------------------|---|
| <p>diagram</p>    | <p>The diagram shows a class hierarchy. The base class is <b>SovereignAndSupranationalInvestments</b> (ID 33190 - 33440). It has seven subclasses, each represented by a dashed box with a plus icon in the top right corner:</p> <ul style="list-style-type: none"> <li><b>AverageIncomeInequalityScope</b> (ID 33190 - 33220)</li> <li><b>AverageFreedomOfExpressionScore</b> (ID 33230 - 33260)</li> <li><b>AverageHumanRightsPerformance</b> (ID 33265 - 33290)</li> <li><b>AverageCorruptionScore</b> (ID 33295 - 33320)</li> <li><b>NonCooperativeTaxJurisdictions</b> (ID 33330 - 33360)</li> <li><b>AveragePoliticalStabilityScore</b> (ID 33370 - 33400)</li> <li><b>AverageRuleOfLawScore</b> (ID 33410 - 33440)</li> </ul> |
| <p>properties</p> | <p>isRef 0<br/> minOcc 0<br/> maxOcc 1<br/> content complex</p>   |
| <p>children</p>   | <p><a href="#">AverageIncomeInequalityScope</a> <a href="#">AverageFreedomOfExpressionScore</a> <a href="#">AverageHumanRightsPerformance</a><br/> <a href="#">AverageCorruptionScore</a> <a href="#">NonCooperativeTaxJurisdictions</a> <a href="#">AveragePoliticalStabilityScore</a> <a href="#">AverageRuleOfLawScore</a></p>   |
| <p>annotation</p> | <p>documentation<br/> 33190 - 33440</p>   |

element

### EETReportType1.1/PrincipalAdverseIndicators/MoreSocialAndEmployeeMatters/SovereignAndSupranationalInvestments/AverageIncomeInequalityScope

|            |   |
|------------|---|
| diagram    | <p><b>AverageIncomeInequalityScope</b><br/>Average_Income_Inequality_Scope (33190 - 33220)</p> <p><b>Value Strategy Coverage Type 1.1</b></p> <ul style="list-style-type: none"><li><b>Value</b></li><li><b>ConsideredInvestmentStrategy</b><br/>Yes (= commitment of the asset manager to improve the PAI), No</li><li><b>Coverage</b><br/>% of the notional / AUM, which provide effectively data, or where data could be estimated</li><li><b>EligibleAssets</b><br/>% of assets (versus notional / AUM), which could provide data</li></ul> |
| type       | <a href="#">ValueStrategyCoverageType1.1</a>  |
| properties | isRef 0<br>minOcc 0<br>maxOcc 1<br>content complex  |
| children   | <a href="#">Value</a> <a href="#">ConsideredInvestmentStrategy</a> <a href="#">Coverage</a> <a href="#">EligibleAssets</a>  |
| annotation | documentation<br>Average_Income_Inequality_Scope (33190 - 33220)  |

element

### EETReportType1.1/PrincipalAdverseIndicators/MoreSocialAndEmployeeMatters/SovereignAndSupranationalInvestments/AverageFreedomOfExpressionScore

|         |  |
|---------|--|
| diagram | <p><b>AverageFreedomOfExpression...</b><br/>Average_Freedom_of_Expression_Score (33230 - 33260)</p> <p><b>Value Strategy Coverage Type 1.1</b></p> <ul style="list-style-type: none"><li><b>Value</b></li><li><b>ConsideredInvestmentStrategy</b><br/>Yes (= commitment of the asset manager to improve the PAI), No</li><li><b>Coverage</b><br/>% of the notional / AUM, which provide effectively data, or where data could be estimated</li><li><b>EligibleAssets</b><br/>% of assets (versus notional / AUM), which could provide data</li></ul> |
|---------|--|

|            |  |
|------------|--|
| type       | <a href="#">ValueStrategyCoverageType1.1</a>   |
| properties | isRef 0<br>minOcc 0<br>maxOcc 1<br>content complex   |
| children   | <a href="#">Value</a> <a href="#">ConsideredInInvestmentStrategy</a> <a href="#">Coverage</a> <a href="#">EligibleAssets</a> |
| annotation | documentation<br>Average_Freedom_of_Expression_Score (33230 - 33260)   |

element

**EETReportType1.1/PrincipalAdverseIndicators/MoreSocialAndEmployeeMatters/SovereignAndSupranationalInvestments/AverageHumanRightsPerformance**

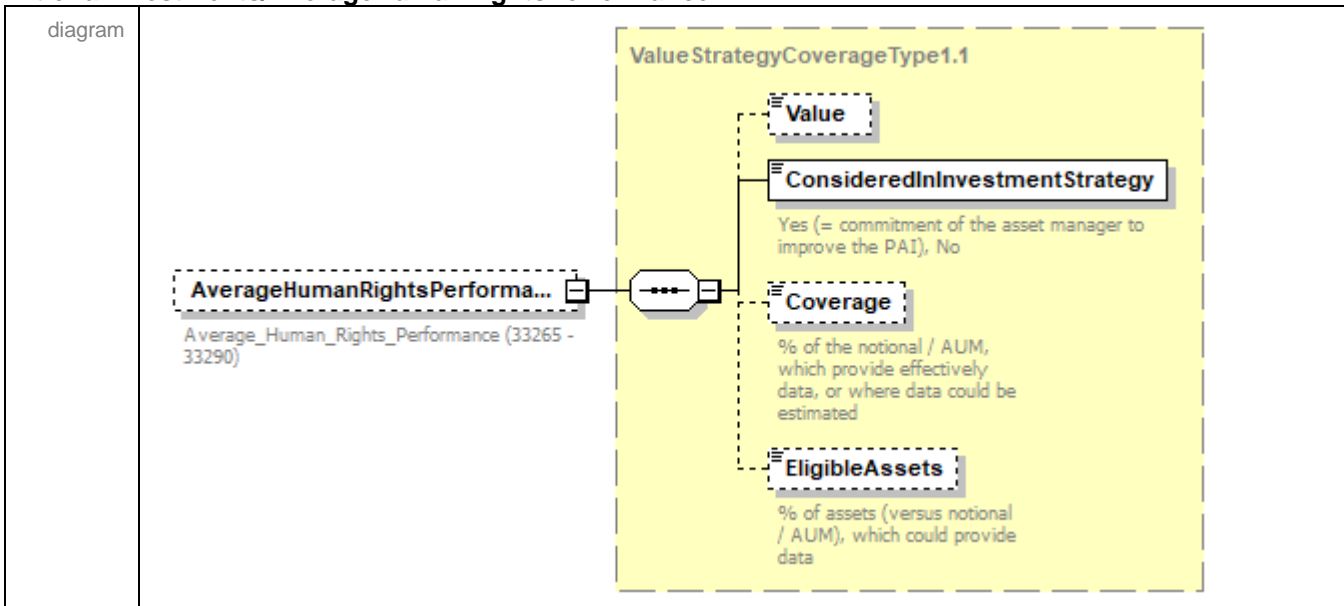

|            |  |
|------------|--|
| type       | <a href="#">ValueStrategyCoverageType1.1</a>   |
| properties | isRef 0<br>minOcc 0<br>maxOcc 1<br>content complex   |
| children   | <a href="#">Value</a> <a href="#">ConsideredInInvestmentStrategy</a> <a href="#">Coverage</a> <a href="#">EligibleAssets</a> |
| annotation | documentation<br>Average_Human_Rights_Performance (33265 - 33290)  |

element

### EETReportType1.1/PrincipalAdverseIndicators/MoreSocialAndEmployeeMatters/SovereignAndSupranationalInvestments/AverageCorruptionScore

|            |  |
|------------|--|
| diagram    |  |
| type       | <a href="#">ValueStrategyCoverageType1.1</a>   |
| properties | isRef 0<br>minOcc 0<br>maxOcc 1<br>content complex   |
| children   | <a href="#">Value</a> <a href="#">ConsideredInInvestmentStrategy</a> <a href="#">Coverage</a> <a href="#">EligibleAssets</a> |
| annotation | documentation<br>Average_Corruption_Score (33295 - 33320)  |

element

### EETReportType1.1/PrincipalAdverseIndicators/MoreSocialAndEmployeeMatters/SovereignAndSupranationalInvestments/NonCooperativeTaxJurisdictions

|         |  |
|---------|--|
| diagram |  |
|---------|--|

|            |  |
|------------|--|
| type       | <a href="#">ValueStrategyCoverageType1.1</a>   |
| properties | isRef 0<br>minOcc 0<br>maxOcc 1<br>content complex   |
| children   | <a href="#">Value</a> <a href="#">ConsideredInInvestmentStrategy</a> <a href="#">Coverage</a> <a href="#">EligibleAssets</a> |
| annotation | documentation<br>Non_Cooperative_Tax_Jurisdictions (33330 - 33360)   |

element

**EETReportType1.1/PrincipalAdverseIndicators/MoreSocialAndEmployeeMatters/SovereignAndSupranationalInvestments/AveragePoliticalStabilityScore**

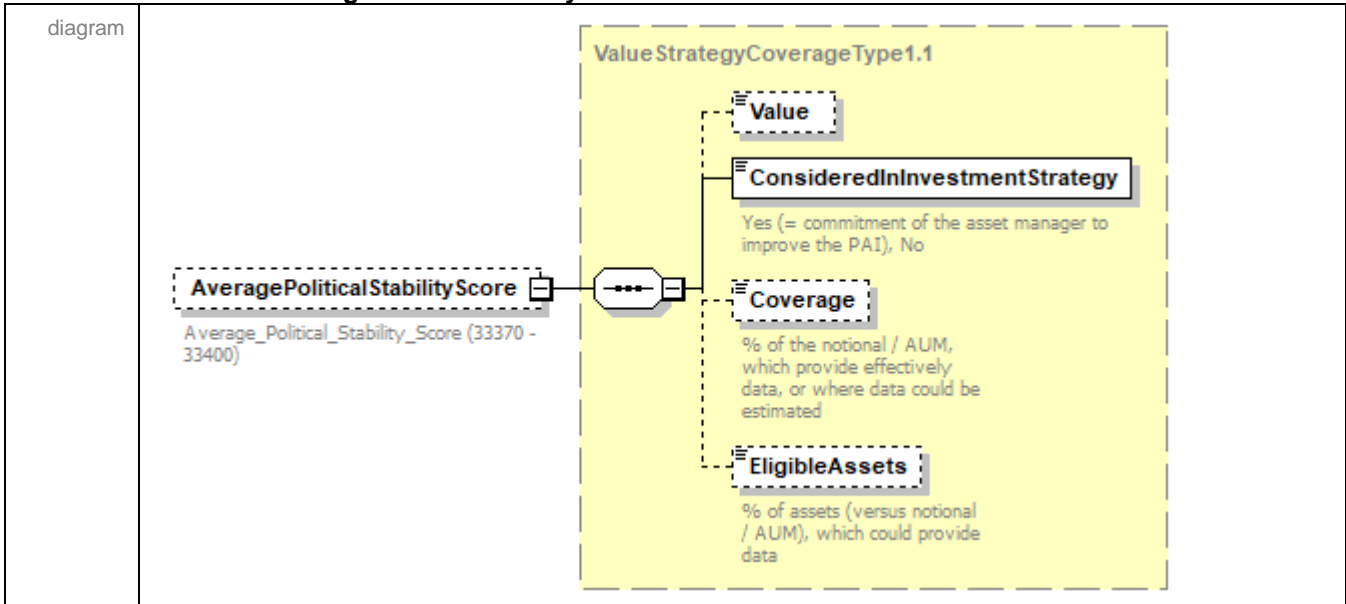

|            |  |
|------------|--|
| type       | <a href="#">ValueStrategyCoverageType1.1</a>   |
| properties | isRef 0<br>minOcc 0<br>maxOcc 1<br>content complex   |
| children   | <a href="#">Value</a> <a href="#">ConsideredInInvestmentStrategy</a> <a href="#">Coverage</a> <a href="#">EligibleAssets</a> |
| annotation | documentation<br>Average_Political_Stability_Score (33370 - 33400)   |

element

**EETReportType1.1/PrincipalAdverseIndicators/MoreSocialAndEmployeeMatters/SovereignAndSupranationalInvestments/AverageRuleOfLawScore**

|                   |   |
|-------------------|---|
| <p>diagram</p>    |   |
| <p>type</p>       | <p><a href="#">ValueStrategyCoverageType1.1</a></p>   |
| <p>properties</p> | <p>isRef 0<br/>minOcc 0<br/>maxOcc 1<br/>content complex</p>  |
| <p>children</p>   | <p><a href="#">Value</a> <a href="#">ConsideredInInvestmentStrategy</a> <a href="#">Coverage</a> <a href="#">EligibleAssets</a></p> |
| <p>annotation</p> | <p>documentation<br/>Average_Rule_Of_Law_Score (33410 - 33440)</p>  |

element **EETReportType1.1/ScreeningCriteria**

|                |  |
|----------------|--|
| <p>diagram</p> |  |
|----------------|--|



|            |   |
|------------|---|
| properties | isRef 0<br>minOcc 0<br>maxOcc 1<br>content complex  |
| children   | <a href="#">ExistingNegativeScreeningStrategy</a> <a href="#">LinkToExclusionPolicyAndCriteria</a> <a href="#">SectorsBasedExclusions</a> <a href="#">NormBasedExclusions</a> <a href="#">SovereignLevelExclusions</a> <a href="#">RealEstateExclusions</a> |
| annotation | documentation<br>40000 - 54070  |

element **EETReportType1.1/ScreeningCriteria/ExistingNegativeScreeningStrategy**

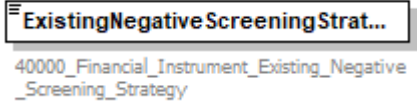
|            |  |
|------------|--|
| diagram    |  ExistingNegativeScreeningStrat...<br>40000_Financial_Instrument_Existing_Negative_Screening_Strategy |
| type       | <a href="#">EETYesNoType</a>   |
| properties | isRef 0<br>content simple  |
| facets     | Kind Value annotation<br>length 1  |
| annotation | documentation<br>40000_Financial_Instrument_Existing_Negative_Screening_Strategy   |

element **EETReportType1.1/ScreeningCriteria/LinkToExclusionPolicyAndCriteria**

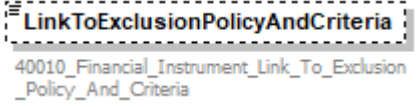
|            |   |
|------------|---|
| diagram    |  LinkToExclusionPolicyAndCriteria<br>40010_Financial_Instrument_Link_To_Exclusion_Policy_And_Criteria |
| type       | <b>xs:anyURI</b>  |
| properties | isRef 0<br>minOcc 0<br>maxOcc 1<br>content simple   |
| annotation | documentation<br>40010_Financial_Instrument_Link_To_Exclusion_Policy_And_Criteria   |

element **EETReportType1.1/ScreeningCriteria/SectorsBasedExclusions**

diagram



|            |   |
|------------|---|
| properties | isRef 0<br>minOcc 0<br>maxOcc 1<br>content complex  |
| children   | <a href="#">PornographyAdultEntertainmentServicesExclusion</a> <a href="#">AlcoholExclusion</a> <a href="#">AnimalTestingExclusion</a> <a href="#">CannabisExclusion</a> <a href="#">ConventionalWeaponsExclusion</a> <a href="#">CoalExclusion</a> <a href="#">FactoryFarmingExclusion</a> <a href="#">FurExclusion</a> <a href="#">GamblingExclusion</a> <a href="#">GasExclusion</a> <a href="#">GeneticEngineeringExclusion</a> <a href="#">GeneticallyModifiedOrganismsExclusion</a> <a href="#">NuclearEnergyExclusion</a> <a href="#">NuclearWeaponsExclusion</a> <a href="#">OilExclusion</a> <a href="#">OtherFossilFuelExclusion</a> <a href="#">PalmOilExclusion</a> <a href="#">PesticidesExclusion</a> <a href="#">ResearchOnHumanEmbryosExclusion</a> <a href="#">TobaccoExclusion</a> <a href="#">UnconventionalWeaponsExclusion</a> |
| annotation | documentation<br>50100 - 52130  |

element

**EETReportType1.1/ScreeningCriteria/SectorsBasedExclusions/PornographyAdultEntertainmentServiceExclusion**

|            |  |
|------------|--|
| diagram    |  |
| type       | <a href="#">EETExclusionType1.1</a>  |
| properties | isRef 0<br>minOcc 0<br>maxOcc 1<br>content complex   |
| children   | <a href="#">Applied</a> <a href="#">ThresholdType</a> <a href="#">RelativeThreshold</a> <a href="#">PartOfValueChain</a> |
| annotation | documentation<br>50100 - 50130   |

element **EETReportType1.1/ScreeningCriteria/SectorsBasedExclusions/AlcoholExclusion**

|            |  |
|------------|--|
| diagram    |  |
| type       | <a href="#">EETExclusionType1.1</a>  |
| properties | isRef 0<br>minOcc 0<br>maxOcc 1<br>content complex   |
| children   | <a href="#">Applied</a> <a href="#">ThresholdType</a> <a href="#">RelativeThreshold</a> <a href="#">PartOfValueChain</a> |
| annotation | documentation<br>50200 - 50230   |

element **EETReportType1.1/ScreeningCriteria/SectorsBasedExclusions/AnimalTestingExclusion**

|            |  |
|------------|--|
| diagram    |  |
| type       | <a href="#">EETExclusionType1.1</a>  |
| properties | isRef 0<br>minOcc 0<br>maxOcc 1<br>content complex   |
| children   | <a href="#">Applied</a> <a href="#">ThresholdType</a> <a href="#">RelativeThreshold</a> <a href="#">PartOfValueChain</a> |
| annotation | documentation<br>50300 - 50330   |

element **EETReportType1.1/ScreeningCriteria/SectorsBasedExclusions/CannabisExclusion**

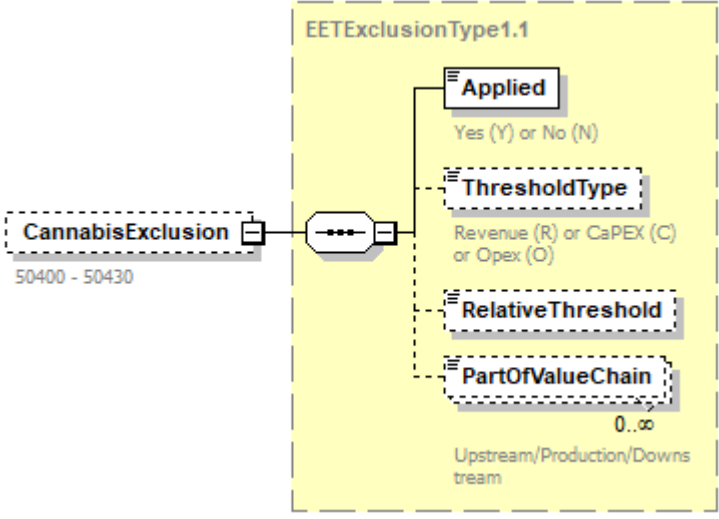
|            |   |
|------------|---|
| diagram    |  <p>The diagram shows the structure of the CannabisExclusion element. On the left, a dashed box labeled 'CannabisExclusion' with ID '50400 - 50430' is connected to a central connector. This connector leads to a larger dashed box labeled 'EETExclusionType1.1'. Inside this box, there are four sub-elements: 'Applied' (Yes (Y) or No (N)), 'ThresholdType' (Revenue (R) or CaPEX (C) or Opex (O)), 'RelativeThreshold', and 'PartOfValueChain' (0..∞, Upstream/Production/Downs tream).</p> |
| type       | <a href="#">EETExclusionType1.1</a>   |
| properties | isRef 0<br>minOcc 0<br>maxOcc 1<br>content complex  |
| children   | <a href="#">Applied</a> <a href="#">ThresholdType</a> <a href="#">RelativeThreshold</a> <a href="#">PartOfValueChain</a>  |
| annotation | documentation<br>50400 - 50430  |

element **EETReportType1.1/ScreeningCriteria/SectorsBasedExclusions/ConventionalWeaponsExclusion**

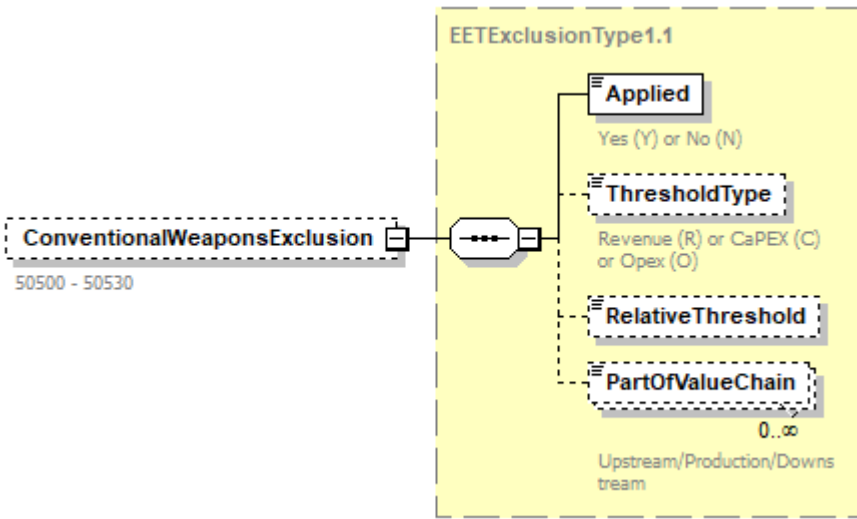
|            |   |
|------------|---|
| diagram    |  <p>The diagram shows the structure of the ConventionalWeaponsExclusion element. On the left, a dashed box labeled 'ConventionalWeaponsExclusion' with ID '50500 - 50530' is connected to a central connector. This connector leads to a larger dashed box labeled 'EETExclusionType1.1'. Inside this box, there are four sub-elements: 'Applied' (Yes (Y) or No (N)), 'ThresholdType' (Revenue (R) or CaPEX (C) or Opex (O)), 'RelativeThreshold', and 'PartOfValueChain' (0..∞, Upstream/Production/Downs tream).</p> |
| type       | <a href="#">EETExclusionType1.1</a>   |
| properties | isRef 0<br>minOcc 0<br>maxOcc 1   |

|            |  |
|------------|--|
|            | content complex  |
| children   | <a href="#">Applied</a> <a href="#">ThresholdType</a> <a href="#">RelativeThreshold</a> <a href="#">PartOfValueChain</a> |
| annotation | documentation<br>50500 - 50530   |

element **EETReportType1.1/ScreeningCriteria/SectorsBasedExclusions/CoalExclusion**

|            |  |
|------------|--|
| diagram    | <p>The diagram illustrates the structure of the <b>EETEnhancedExclusionType1.1</b> element. It is a complex type containing several sub-elements: <b>Applied</b> (Yes (Y) or No (N)), <b>ThresholdType</b> (Revenue (R) or CaPEX (C) or Opex (O)), <b>RelativeThreshold</b>, <b>PartOfValueChain</b> (Upstream/Production/Downs tream), <b>EnergyMixAbsoluteCap</b>, <b>EnergyMixRelativeCap</b>, and <b>NewInfrastructure</b> (Yes (Y) or No (N)). The <b>CoalExclusion</b> element (50600 - 50660) is shown as a separate class that is associated with <b>EETEnhancedExclusionType1.1</b> via a composition relationship.</p> |
| type       | <a href="#">EETEnhancedExclusionType1.1</a>  |
| properties | isRef 0<br>minOcc 0<br>maxOcc 1<br>content complex   |
| children   | <a href="#">Applied</a> <a href="#">ThresholdType</a> <a href="#">RelativeThreshold</a> <a href="#">PartOfValueChain</a> <a href="#">EnergyMixAbsoluteCap</a> <a href="#">EnergyMixRelativeCap</a> <a href="#">NewInfrastructure</a>   |
| annotation | documentation<br>50600 - 50660   |

element **EETReportType1.1/ScreeningCriteria/SectorsBasedExclusions/FactoryFarmingExclusion**

|            |  |
|------------|--|
| diagram    | <p>The diagram illustrates the structure of the <b>FactoryFarmingExclusion</b> element. It is a dashed box containing the text "FactoryFarmingExclusion" and the range "50700 - 50730". A line connects this box to a central connector box, which in turn connects to a larger dashed box labeled "EETExclusionType1.1". Inside this box, there are four sub-elements: "Applied" (Yes (Y) or No (N)), "ThresholdType" (Revenue (R) or CaPEX (C) or Opex (O)), "RelativeThreshold", and "PartOfValueChain" (0..∞, Upstream/Production/Downs stream).</p> |
| type       | <a href="#">EETExclusionType1.1</a>  |
| properties | <p>isRef 0<br/> minOcc 0<br/> maxOcc 1<br/> content complex</p>  |
| children   | <a href="#">Applied</a> <a href="#">ThresholdType</a> <a href="#">RelativeThreshold</a> <a href="#">PartOfValueChain</a>   |
| annotation | documentation<br>50700 - 50730   |

element **EETReportType1.1/ScreeningCriteria/SectorsBasedExclusions/FurExclusion**

|            |  |
|------------|--|
| diagram    | <p>The diagram illustrates the structure of the <b>FurExclusion</b> element. It is a dashed box containing the text "FurExclusion" and the range "50800 - 50830". A line connects this box to a central connector box, which in turn connects to a larger dashed box labeled "EETExclusionType1.1". Inside this box, there are four sub-elements: "Applied" (Yes (Y) or No (N)), "ThresholdType" (Revenue (R) or CaPEX (C) or Opex (O)), "RelativeThreshold", and "PartOfValueChain" (0..∞, Upstream/Production/Downs stream).</p> |
| type       | <a href="#">EETExclusionType1.1</a>  |
| properties | <p>isRef 0<br/> minOcc 0<br/> maxOcc 1<br/> content complex</p>  |
| children   | <a href="#">Applied</a> <a href="#">ThresholdType</a> <a href="#">RelativeThreshold</a> <a href="#">PartOfValueChain</a>   |
| annotation | documentation<br>50800 - 50830   |



element **EETReportType1.1/ScreeningCriteria/SectorsBasedExclusions/GamblingExclusion**

|                   |  |
|-------------------|--|
| <p>diagram</p>    | <pre> classDiagram     class GamblingExclusion {         50900 - 50930     }     class EETExclusionType1.1 {         50900 - 50930         Applied : Yes (Y) or No (N)         ThresholdType : Revenue (R) or CaPEX (C) or Opex (O)         RelativeThreshold         PartOfValueChain : 0..∞, Upstream/Production/Downstream     }     GamblingExclusion "1" *-- "1" EETExclusionType1.1     </pre> |
| <p>type</p>       | <p><a href="#">EETExclusionType1.1</a></p>   |
| <p>properties</p> | <p>isRef 0<br/> minOcc 0<br/> maxOcc 1<br/> content complex</p>  |
| <p>children</p>   | <p><a href="#">Applied</a> <a href="#">ThresholdType</a> <a href="#">RelativeThreshold</a> <a href="#">PartOfValueChain</a></p>  |
| <p>annotation</p> | <p>documentation<br/> 50900 - 50930</p>  |

element **EETReportType1.1/ScreeningCriteria/SectorsBasedExclusions/GasExclusion**

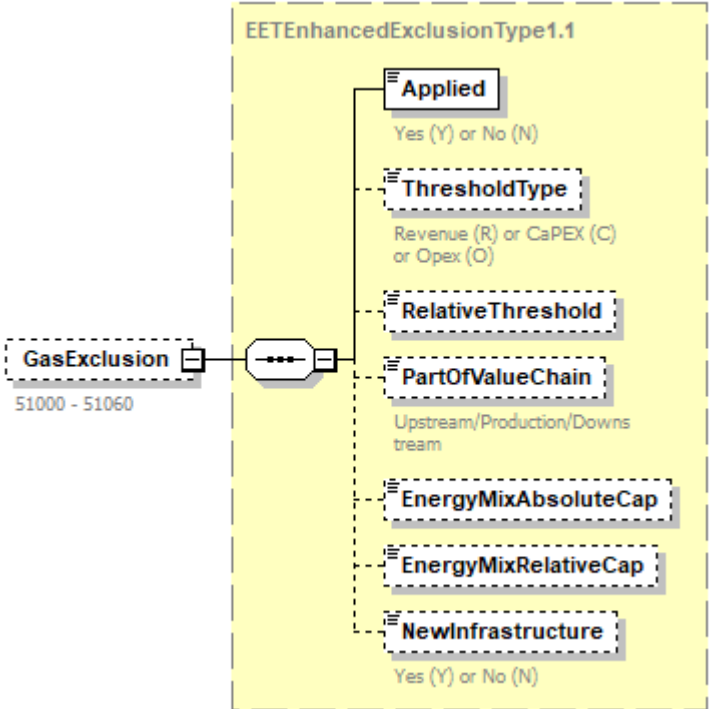
|                   |   |
|-------------------|---|
| <p>diagram</p>    |    |
| <p>type</p>       | <p><a href="#">EETEnhancedExclusionType1.1</a></p>  |
| <p>properties</p> | <p>isRef 0<br/>minOcc 0<br/>maxOcc 1<br/>content complex</p>  |
| <p>children</p>   | <p><a href="#">Applied</a> <a href="#">ThresholdType</a> <a href="#">RelativeThreshold</a> <a href="#">PartOfValueChain</a> <a href="#">EnergyMixAbsoluteCap</a> <a href="#">EnergyMixRelativeCap</a> <a href="#">NewInfrastructure</a></p> |
| <p>annotation</p> | <p>documentation<br/>51000 - 51060</p>  |

element **EETReportType1.1/ScreeningCriteria/SectorsBasedExclusions/GeneticEngineeringExclusion**

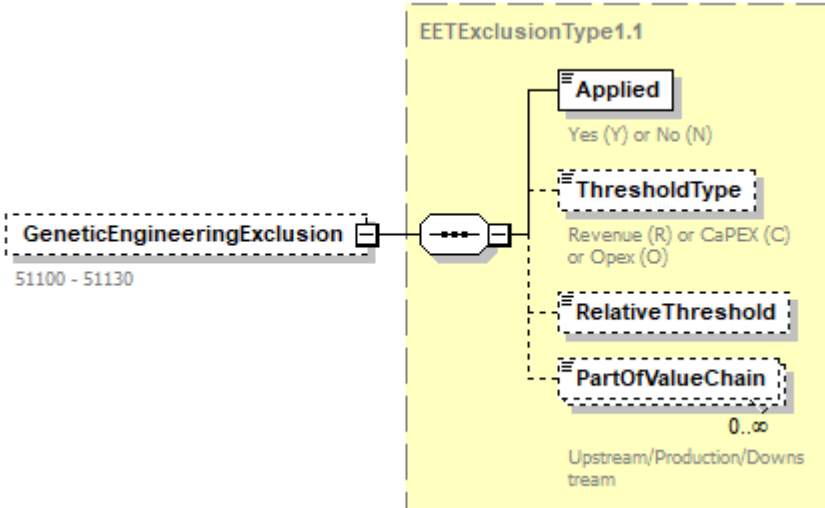
|                |  |
|----------------|--|
| <p>diagram</p> |  |
|----------------|--|

|            |  |
|------------|--|
| type       | <a href="#">EETExclusionType1.1</a>  |
| properties | isRef 0<br>minOcc 0<br>maxOcc 1<br>content complex   |
| children   | <a href="#">Applied</a> <a href="#">ThresholdType</a> <a href="#">RelativeThreshold</a> <a href="#">PartOfValueChain</a> |
| annotation | documentation<br>51100 - 51130   |

element

**EETReportType1.1/ScreeningCriteria/SectorsBasedExclusions/GeneticallyModifiedOrganismsExclusion**

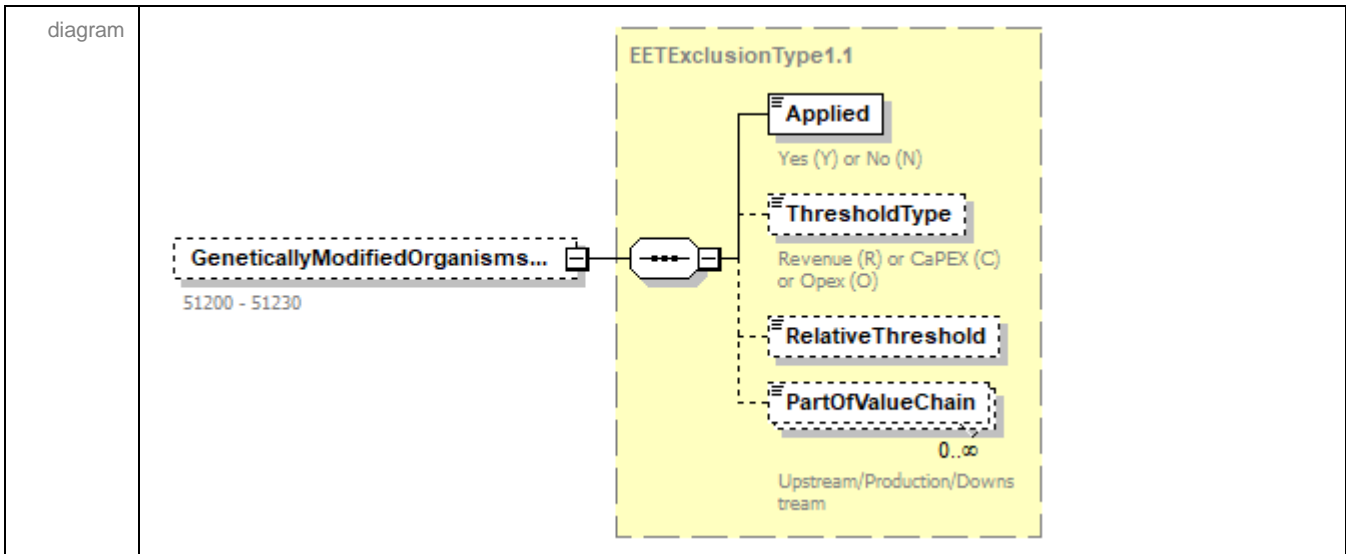

|            |  |
|------------|--|
| type       | <a href="#">EETExclusionType1.1</a>  |
| properties | isRef 0<br>minOcc 0<br>maxOcc 1<br>content complex   |
| children   | <a href="#">Applied</a> <a href="#">ThresholdType</a> <a href="#">RelativeThreshold</a> <a href="#">PartOfValueChain</a> |
| annotation | documentation<br>51200 - 51230   |

element **EETReportType1.1/ScreeningCriteria/SectorsBasedExclusions/NuclearEnergyExclusion**

|            |   |
|------------|---|
| diagram    | <p>The diagram illustrates the structure of the <b>NuclearEnergyExclusion</b> element. It is represented as a dashed box containing a solid box labeled <b>Applied</b> with the text "Yes (Y) or No (N)". To the right, a dashed box labeled <b>EETExclusionType1.1</b> contains a solid box labeled <b>Applied</b> with the text "Yes (Y) or No (N)", a dashed box labeled <b>ThresholdType</b> with the text "Revenue (R) or CaPEX (C) or Opex (O)", a dashed box labeled <b>RelativeThreshold</b>, and a dashed box labeled <b>PartOfValueChain</b> with the text "0..∞" and "Upstream/Production/Downs tream". A dashed box labeled <b>NuclearEnergyExclusion</b> with the text "51300 - 51330" is connected to the <b>EETExclusionType1.1</b> box.</p> |
| type       | <a href="#">EETExclusionType1.1</a>   |
| properties | isRef 0<br>minOcc 0<br>maxOcc 1<br>content complex  |
| children   | <a href="#">Applied</a> <a href="#">ThresholdType</a> <a href="#">RelativeThreshold</a> <a href="#">PartOfValueChain</a>  |
| annotation | documentation<br>51300 - 51330  |

element **EETReportType1.1/ScreeningCriteria/SectorsBasedExclusions/NuclearWeaponsExclusion**

|            |   |
|------------|---|
| diagram    | <p>The diagram illustrates the structure of the <b>NuclearWeaponsExclusion</b> element. It is represented as a dashed box containing a solid box labeled <b>Applied</b> with the text "Yes (Y) or No (N)". To the right, a dashed box labeled <b>EETExclusionType1.1</b> contains a solid box labeled <b>Applied</b> with the text "Yes (Y) or No (N)", a dashed box labeled <b>ThresholdType</b> with the text "Revenue (R) or CaPEX (C) or Opex (O)", a dashed box labeled <b>RelativeThreshold</b>, and a dashed box labeled <b>PartOfValueChain</b> with the text "0..∞" and "Upstream/Production/Downs tream". A dashed box labeled <b>NuclearWeaponsExclusion</b> with the text "51400 - 51430" is connected to the <b>EETExclusionType1.1</b> box.</p> |
| type       | <a href="#">EETExclusionType1.1</a>   |
| properties | isRef 0<br>minOcc 0<br>maxOcc 1<br>content complex  |
| children   | <a href="#">Applied</a> <a href="#">ThresholdType</a> <a href="#">RelativeThreshold</a> <a href="#">PartOfValueChain</a>  |
| annotation | documentation<br>51400 - 51430  |

element **EETReportType1.1/ScreeningCriteria/SectorsBasedExclusions/OilExclusion**

|                   |  |
|-------------------|--|
| <p>diagram</p>    | <p>The diagram illustrates the structure of the <b>OilExclusion</b> element. It is associated with the <b>EETEnhancedExclusionType1.1</b> type. The <b>OilExclusion</b> element is identified by the range 51500 - 51560. The <b>EETEnhancedExclusionType1.1</b> type contains several attributes:</p> <ul style="list-style-type: none"> <li><b>Applied</b>: Yes (Y) or No (N)</li> <li><b>ThresholdType</b>: Revenue (R) or CaPEX (C) or Opex (O)</li> <li><b>RelativeThreshold</b></li> <li><b>PartOfValueChain</b>: Upstream/Production/Downstream</li> <li><b>EnergyMixAbsoluteCap</b></li> <li><b>EnergyMixRelativeCap</b></li> <li><b>NewInfrastructure</b>: Yes (Y) or No (N)</li> </ul> |
| <p>type</p>       | <p><a href="#">EETEnhancedExclusionType1.1</a></p>   |
| <p>properties</p> | <p>isRef 0<br/>minOcc 0<br/>maxOcc 1<br/>content complex</p>   |
| <p>children</p>   | <p><a href="#">Applied</a> <a href="#">ThresholdType</a> <a href="#">RelativeThreshold</a> <a href="#">PartOfValueChain</a> <a href="#">EnergyMixAbsoluteCap</a> <a href="#">EnergyMixRelativeCap</a> <a href="#">NewInfrastructure</a></p>  |
| <p>annotation</p> | <p>documentation<br/>51500 - 51560</p>   |

element **EETReportType1.1/ScreeningCriteria/SectorsBasedExclusions/OtherFossilFuelExclusion**

|                   |   |
|-------------------|---|
| <p>diagram</p>    |   |
| <p>type</p>       | <p><a href="#">EETEnhancedExclusionType1.1</a></p>  |
| <p>properties</p> | <p>isRef 0<br/>minOcc 0<br/>maxOcc 1<br/>content complex</p>  |
| <p>children</p>   | <p><a href="#">Applied</a> <a href="#">ThresholdType</a> <a href="#">RelativeThreshold</a> <a href="#">PartOfValueChain</a> <a href="#">EnergyMixAbsoluteCap</a> <a href="#">EnergyMixRelativeCap</a> <a href="#">NewInfrastructure</a></p> |
| <p>annotation</p> | <p>documentation<br/>51600 - 51660</p>  |

element **EETReportType1.1/ScreeningCriteria/SectorsBasedExclusions/PalmOilExclusion**

|                |  |
|----------------|--|
| <p>diagram</p> |  |
|----------------|--|

|            |  |
|------------|--|
| type       | <a href="#">EETExclusionType1.1</a>  |
| properties | isRef 0<br>minOcc 0<br>maxOcc 1<br>content complex   |
| children   | <a href="#">Applied</a> <a href="#">ThresholdType</a> <a href="#">RelativeThreshold</a> <a href="#">PartOfValueChain</a> |
| annotation | documentation<br>51700 - 51730   |

element **EETReportType1.1/ScreeningCriteria/SectorsBasedExclusions/PesticidesExclusion**

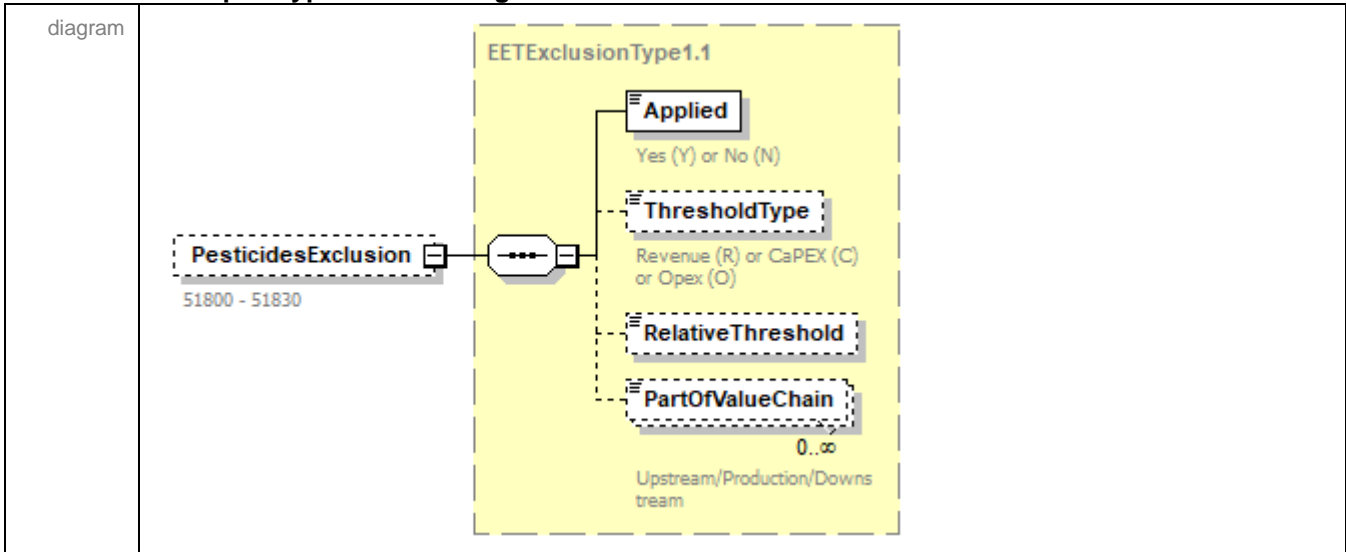

|            |  |
|------------|--|
| type       | <a href="#">EETExclusionType1.1</a>  |
| properties | isRef 0<br>minOcc 0<br>maxOcc 1<br>content complex   |
| children   | <a href="#">Applied</a> <a href="#">ThresholdType</a> <a href="#">RelativeThreshold</a> <a href="#">PartOfValueChain</a> |
| annotation | documentation<br>51800 - 51830   |

element

**EETReportType1.1/ScreeningCriteria/SectorsBasedExclusions/ResearchOnHumanEmbryosExclusion**

|                   |   |
|-------------------|---|
| <p>diagram</p>    |   |
| <p>type</p>       | <p><a href="#">EETExclusionType1.1</a></p>  |
| <p>properties</p> | <p>isRef 0<br/>minOcc 0<br/>maxOcc 1<br/>content complex</p>  |
| <p>children</p>   | <p><a href="#">Applied</a> <a href="#">ThresholdType</a> <a href="#">RelativeThreshold</a> <a href="#">PartOfValueChain</a></p> |
| <p>annotation</p> | <p>documentation<br/>51900 - 51930</p>  |

element **EETReportType1.1/ScreeningCriteria/SectorsBasedExclusions/TobaccoExclusion**

|                   |   |
|-------------------|---|
| <p>diagram</p>    |   |
| <p>type</p>       | <p><a href="#">EETExclusionType1.1</a></p>  |
| <p>properties</p> | <p>isRef 0<br/>minOcc 0<br/>maxOcc 1<br/>content complex</p>  |
| <p>children</p>   | <p><a href="#">Applied</a> <a href="#">ThresholdType</a> <a href="#">RelativeThreshold</a> <a href="#">PartOfValueChain</a></p> |



|            |                                |
|------------|--------------------------------|
| annotation | documentation<br>52000 - 52030 |
|------------|--------------------------------|

element

**EETReportType1.1/ScreeningCriteria/SectorsBasedExclusions/UnconventionalWeaponsExclusion**

|            |  |
|------------|--|
| diagram    |  |
| type       | <a href="#">EETExclusionType1.1</a>  |
| properties | isRef 0<br>minOcc 0<br>maxOcc 1<br>content complex   |
| children   | <a href="#">Applied</a> <a href="#">ThresholdType</a> <a href="#">RelativeThreshold</a> <a href="#">PartOfValueChain</a> |
| annotation | documentation<br>52100 - 52130   |

element **EETReportType1.1/ScreeningCriteria/NormBasedExclusions**

|            |  |
|------------|--|
| diagram    |  |
| properties | isRef 0<br>minOcc 0<br>maxOcc 1<br>content complex   |
| children   | <a href="#">UNGC Exclusion</a> <a href="#">OECD Guidelines Exclusion</a> <a href="#">ILO Exclusion</a> |
| annotation | documentation<br>52200 - 52220   |

element **EETReportType1.1/ScreeningCriteria/NormBasedExclusions/UNGC\_Exclusion**

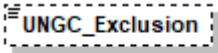
|            |  |
|------------|--|
| diagram    | <br>52200_Financial_Instrument<br>_UNGC_Exclusion |
| type       | <a href="#">EETYesNoType</a>   |
| properties | isRef 0<br>minOcc 0<br>maxOcc 1<br>content simple  |
| facets     | Kind Value annotation<br>length 1  |
| annotation | documentation<br>52200_Financial_Instrument_UNGC_Exclusion   |

element **EETReportType1.1/ScreeningCriteria/NormBasedExclusions/OECD\_Guidelines\_Exclusion**

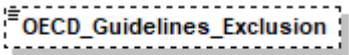
|            |   |
|------------|---|
| diagram    | <br>52210_Financial_Instrument_OECD_G<br>uidelines_Exclusion |
| type       | <a href="#">EETYesNoType</a>  |
| properties | isRef 0<br>minOcc 0<br>maxOcc 1<br>content simple   |
| facets     | Kind Value annotation<br>length 1   |
| annotation | documentation<br>52210_Financial_Instrument_OECD_Guidelines_Exclusion   |

element **EETReportType1.1/ScreeningCriteria/NormBasedExclusions/ILO\_Exclusion**

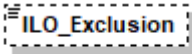
|            |   |
|------------|---|
| diagram    | <br>52220_Financial_Instrument<br>_ILO_Exclusion |
| type       | <a href="#">EETYesNoType</a>  |
| properties | isRef 0<br>minOcc 0<br>maxOcc 1<br>content simple   |
| facets     | Kind Value annotation<br>length 1   |
| annotation | documentation<br>52220_Financial_Instrument_ILO_Exclusion   |

element **EETReportType1.1/ScreeningCriteria/SovereignLevelExclusions**

|            |  |
|------------|--|
| diagram    | <p>The diagram shows a container element <b>SovereignLevelExclusions</b> (ID: 53000 - 53060) connected to seven sub-exclusion elements:</p> <ul style="list-style-type: none"> <li><b>NuclearWeaponsExclusion</b> (53000_Financial_Instrument_Nuclear_Weapons_Exclusion)</li> <li><b>NonProliferationTreatyOfNuclear...</b> (53010_Financial_Instrument_Non-proliferation_Treaty_Of_Nuclear_Weapons)</li> <li><b>QualitativeExclusionOfCountries</b> (53020_Financial_Instrument_Qualitative_Exc_lusion_Of_Countries: A - Freedomhouse, I - Internal method, N - None)</li> <li><b>CorruptionExclusion</b> (53030_Financial_Instrument_Corruption_Exclusion)</li> <li><b>DeathSentenceExclusion</b> (53040_Financial_Instrument_Death_Sentence_Exclusion)</li> <li><b>WarExclusion</b> (53050_Financial_Instrument_War_Exclusion)</li> <li><b>NonRatificationOfParisAgreeme...</b> (53060_Financial_Instrument_Non_Ratification_Of_Paris_Agreement_Exclusion)</li> </ul> |
| properties | <p>isRef 0<br/> minOcc 0<br/> maxOcc 1<br/> content complex</p>  |
| children   | <p><a href="#">NuclearWeaponsExclusion</a> <a href="#">NonProliferationTreatyOfNuclearWeapons</a> <a href="#">QualitativeExclusionOfCountries</a> <a href="#">CorruptionExclusion</a> <a href="#">DeathSentenceExclusion</a> <a href="#">WarExclusion</a> <a href="#">NonRatificationOfParisAgreementExclusion</a></p>   |
| annotation | <p>documentation<br/> 53000 - 53060</p>  |

element **EETReportType1.1/ScreeningCriteria/SovereignLevelExclusions/NuclearWeaponsExclusion**

|            |   |
|------------|---|
| diagram    | <p>The diagram shows the <b>NuclearWeaponsExclusion</b> element (ID: 53000_Financial_Instrument_Nuclear_Weapons_Exclusion).</p> |
| type       | <p><a href="#">EETYesNoType</a></p>   |
| properties | <p>isRef 0<br/> minOcc 0<br/> maxOcc 1<br/> content simple</p>  |
| facets     | <p>Kind Value annotation<br/> length 1</p>  |
| annotation | <p>documentation<br/> 53000_Financial_Instrument_Nuclear_Weapons_Exclusion</p>  |

element

**EETReportType1.1/ScreeningCriteria/SovereignLevelExclusions/NonProliferationTreatyOfNuclearWeapons**

|            |   |
|------------|---|
| diagram    |  <b>NonProliferationTreatyOfNuclear...</b><br>53010_Financial_Instrument_Non-proliferation_Treaty_Of_Nuclear_Weapons |
| type       | <a href="#">EETYesNoType</a>  |
| properties | isRef 0<br>minOcc 0<br>maxOcc 1<br>content simple   |
| facets     | Kind Value annotation<br>length 1   |
| annotation | documentation<br>53010_Financial_Instrument_Non-proliferation_Treaty_Of_Nuclear_Weapons   |

element

**EETReportType1.1/ScreeningCriteria/SovereignLevelExclusions/QualitativeExclusionOfCountries**

|            |  |
|------------|--|
| diagram    |  <b>QualitativeExclusionOfCountries</b><br>53020_Financial_Instrument_Qualitative_Exclusion_Of_Countries:<br>A- Freedomhouse<br>I - Internal method<br>N - None |
| type       | restriction of <b>xs:string</b>  |
| properties | isRef 0<br>minOcc 0<br>maxOcc 1<br>content simple  |
| annotation | documentation<br>53020_Financial_Instrument_Qualitative_Exclusion_Of_Countries:<br>A- Freedomhouse<br>I - Internal method<br>N - None  |

element **EETReportType1.1/ScreeningCriteria/SovereignLevelExclusions/CorruptionExclusion**

|            |   |
|------------|---|
| diagram    |  <b>CorruptionExclusion</b><br>53030_Financial_Instrument_Corruption_Exclusion |
| type       | <a href="#">EETYesNoType</a>  |
| properties | isRef 0<br>minOcc 0<br>maxOcc 1<br>content simple   |
| facets     | Kind Value annotation<br>length 1   |
| annotation | documentation<br>53030_Financial_Instrument_Corruption_Exclusion  |

element **EETReportType1.1/ScreeningCriteria/SovereignLevelExclusions/DeathSentenceExclusion**

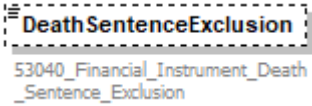
|            |  |
|------------|--|
| diagram    |  <p><b>DeathSentenceExclusion</b><br/>53040_Financial_Instrument_Death_Sentence_Exclusion</p> |
| type       | <a href="#">EETYesNoType</a>   |
| properties | isRef 0<br>minOcc 0<br>maxOcc 1<br>content simple  |
| facets     | Kind Value annotation<br>length 1  |
| annotation | documentation<br>53040_Financial_Instrument_Death_Sentence_Exclusion   |

element **EETReportType1.1/ScreeningCriteria/SovereignLevelExclusions/WarExclusion**

|            |   |
|------------|---|
| diagram    |  <p><b>WarExclusion</b><br/>53050_Financial_Instrument_War_Exclusion</p> |
| type       | <a href="#">EETYesNoType</a>  |
| properties | isRef 0<br>minOcc 0<br>maxOcc 1<br>content simple   |
| facets     | Kind Value annotation<br>length 1   |
| annotation | documentation<br>53050_Financial_Instrument_War_Exclusion   |

element **EETReportType1.1/ScreeningCriteria/SovereignLevelExclusions/NonRatificationOfParisAgreementExclusion**

|            |   |
|------------|---|
| diagram    |  <p><b>NonRatificationOfParisAgreementExclusion</b><br/>53060_Financial_Instrument_Non_Ratification_Of_Paris_Agreement_Exclusion</p> |
| type       | <a href="#">EETYesNoType</a>  |
| properties | isRef 0<br>minOcc 0<br>maxOcc 1<br>content simple   |
| facets     | Kind Value annotation<br>length 1   |
| annotation | documentation<br>53060_Financial_Instrument_Non_Ratification_Of_Paris_Agreement_Exclusion   |

element **EETReportType1.1/ScreeningCriteria/RealEstateExclusions**

|                   |  |
|-------------------|--|
| <p>diagram</p>    | <p>The diagram shows a container element named <b>RealEstateExclusions</b> with the ID range 54000 - 54070. It contains seven sub-elements, each in a dashed box:</p> <ul style="list-style-type: none"> <li><b>EnergyConsumptionMonitoring</b> (54000_Financial_Instrument_ESG_Energy_Consumption_Monitoring)</li> <li><b>GreenhouseGasEmissionMonitoring</b> (54010_Financial_Instrument_ESG_GHG_Emission_Monitoring)</li> <li><b>WaterConsumptionMonitoring</b> (54020_Financial_Instrument_ESG_Water_Consumption_Monitoring)</li> <li><b>WasteFinancialInstrumentationMonitoring</b> (54030_Financial_Instrument_ESG_Waste_Financial_Instrumentation_Monitoring)</li> <li><b>EnvironmentalHealthMonitoring</b> (54040_Financial_Instrument_ESG_Environmental_Health_Monitoring)</li> <li><b>SupplierMonitoring</b> (54050_Financial_Instrument_ESG_Supplier_Monitoring)</li> <li><b>SafetyMonitoring</b> (54060_Financial_Instrument_ESG_Safety_Monitoring)</li> <li><b>BiodiversityMonitoring</b> (54070_Financial_Instrument_ESG_Biodiversity_Monitoring)</li> </ul> |
| <p>properties</p> | <p>isRef 0<br/>minOcc 0<br/>maxOcc 1<br/>content complex</p>   |
| <p>children</p>   | <p><a href="#">EnergyConsumptionMonitoring</a> <a href="#">GreenhouseGasEmissionMonitoring</a> <a href="#">WaterConsumptionMonitoring</a> <a href="#">WasteFinancialInstrumentationMonitoring</a> <a href="#">EnvironmentalHealthMonitoring</a> <a href="#">SupplierMonitoring</a> <a href="#">SafetyMonitoring</a> <a href="#">BiodiversityMonitoring</a></p>   |
| <p>annotation</p> | <p>documentation<br/>54000 - 54070</p>   |

element **EETReportType1.1/ScreeningCriteria/RealEstateExclusions/EnergyConsumptionMonitoring**

|                   |  |
|-------------------|--|
| <p>diagram</p>    | <p>The diagram shows a simple element named <b>EnergyConsumptionMonitoring</b> with the ID range 54000_Financial_Instrument_ESG_Energy_Consumption_Monitoring.</p> |
| <p>type</p>       | <p><a href="#">EETYesNoType</a></p>  |
| <p>properties</p> | <p>isRef 0<br/>minOcc 0<br/>maxOcc 1<br/>content simple</p>  |
| <p>facets</p>     | <p>Kind Value annotation<br/>length 1</p>  |

|            |   |
|------------|---|
| annotation | documentation<br>54000_Financial_Instrument_ESG_Energy_Consumption_Monitoring |
|------------|---|

element

**EETReportType1.1/ScreeningCriteria/RealEstateExclusions/GreenhouseGasEmissionMonitoring**

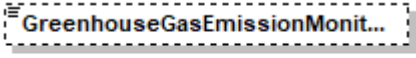
|            |   |
|------------|---|
| diagram    | <br>54010_Financial_Instrument_ESG_GHG_Emission_Monitoring |
| type       | <a href="#">EETYesNoType</a>  |
| properties | isRef 0<br>minOcc 0<br>maxOcc 1<br>content simple   |
| facets     | Kind Value annotation<br>length 1   |
| annotation | documentation<br>54010_Financial_Instrument_ESG_GHG_Emission_Monitoring   |

element **EETReportType1.1/ScreeningCriteria/RealEstateExclusions/WaterConsumptionMonitoring**

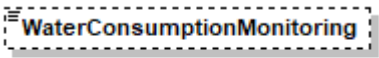
|            |  |
|------------|--|
| diagram    | <br>54020_Financial_Instrument_ESG_Water_Consumption_Monitoring |
| type       | <a href="#">EETYesNoType</a>   |
| properties | isRef 0<br>minOcc 0<br>maxOcc 1<br>content simple  |
| facets     | Kind Value annotation<br>length 1  |
| annotation | documentation<br>54020_Financial_Instrument_ESG_Water_Consumption_Monitoring   |

element

**EETReportType1.1/ScreeningCriteria/RealEstateExclusions/WasteFinancialInstrumentationMonitoring**

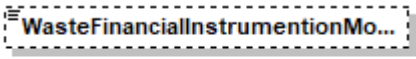
|            |  |
|------------|--|
| diagram    | <br>54030_Financial_Instrument_ESG_Waste_Financial_Instrumentation_Monitoring |
| type       | <a href="#">EETYesNoType</a>   |
| properties | isRef 0<br>minOcc 0<br>maxOcc 1<br>content simple  |
| facets     | Kind Value annotation<br>length 1  |
| annotation | documentation<br>54030_Financial_Instrument_ESG_Waste_Financial_Instrumentation_Monitoring   |

element **EETReportType1.1/ScreeningCriteria/RealEstateExclusions/EnvironmentalHealthMonitoring**

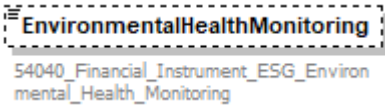
|            |   |
|------------|---|
| diagram    |  <p>54040_Financial_Instrument_ESG_Environmental_Health_Monitoring</p> |
| type       | <a href="#">EETYesNoType</a>  |
| properties | isRef 0<br>minOcc 0<br>maxOcc 1<br>content simple   |
| facets     | Kind Value annotation<br>length 1   |
| annotation | documentation<br>54040_Financial_Instrument_ESG_Environmental_Health_Monitoring   |

element **EETReportType1.1/ScreeningCriteria/RealEstateExclusions/SupplierMonitoring**

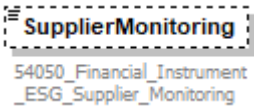
|            |   |
|------------|---|
| diagram    |  <p>54050_Financial_Instrument_ESG_Supplier_Monitoring</p> |
| type       | <a href="#">EETYesNoType</a>  |
| properties | isRef 0<br>minOcc 0<br>maxOcc 1<br>content simple   |
| facets     | Kind Value annotation<br>length 1   |
| annotation | documentation<br>54050_Financial_Instrument_ESG_Supplier_Monitoring   |

element **EETReportType1.1/ScreeningCriteria/RealEstateExclusions/SafetyMonitoring**

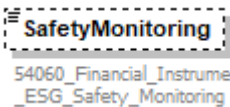
|            |   |
|------------|---|
| diagram    |  <p>54060_Financial_Instrument_ESG_Safety_Monitoring</p> |
| type       | <a href="#">EETYesNoType</a>  |
| properties | isRef 0<br>minOcc 0<br>maxOcc 1<br>content simple   |
| facets     | Kind Value annotation<br>length 1   |
| annotation | documentation<br>54060_Financial_Instrument_ESG_Safety_Monitoring   |

element **EETReportType1.1/ScreeningCriteria/RealEstateExclusions/BiodiversityMonitoring**

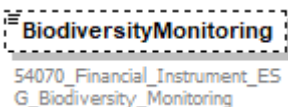
|         |   |
|---------|---|
| diagram |  <p>54070_Financial_Instrument_ESG_Biodiversity_Monitoring</p> |
| type    | <a href="#">EETYesNoType</a>  |



|            |   |
|------------|---|
| properties | isRef 0<br>minOcc 0<br>maxOcc 1<br>content simple                       |
| facets     | Kind Value annotation<br>length 1                                       |
| annotation | documentation<br>54070_Financial_Instrument_ESG_Biodiversity_Monitoring |

element **EETReportType1.1/CountrySpecificInformation**

|            |  |
|------------|--|
| diagram    | <p>The diagram shows a class <b>CountrySpecificInformation</b> (ID 60400 - 60440) with a dashed border. It is connected via a solid line with an open arrowhead to a central hexagonal connector. From this connector, two dashed lines with open arrowheads point to two child classes: <b>France</b> (ID 60400 - 60430) and <b>Germany</b> (ID 60440). Both child classes also have dashed borders and a small square icon with a plus sign in the top right corner.</p> |
| properties | isRef 0<br>minOcc 0<br>maxOcc 1<br>content complex   |
| children   | <a href="#">France</a> <a href="#">Germany</a>   |
| annotation | documentation<br>60400 - 60440   |

element **EETReportType1.1/CountrySpecificInformation/France**

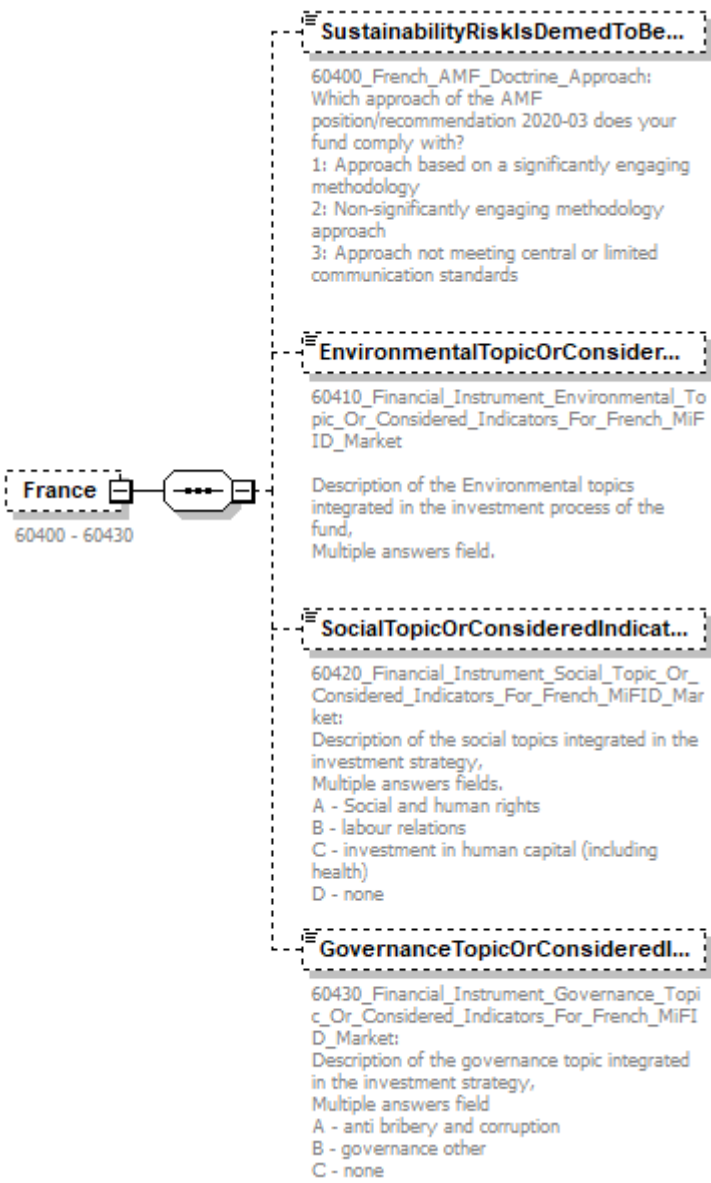
|                   |   |
|-------------------|---|
| <p>diagram</p>    |  <p><b>SustainabilityRisksDemedToBe...</b></p> <p>60400_French_AMF_Doctrine_Approach:<br/>Which approach of the AMF position/recommendation 2020-03 does your fund comply with?<br/>1: Approach based on a significantly engaging methodology<br/>2: Non-significantly engaging methodology approach<br/>3: Approach not meeting central or limited communication standards</p> <p><b>EnvironmentalTopicOrConsider...</b></p> <p>60410_Financial_Instrument_Environmental_Topic_Or_Considered_Indicators_For_French_MiFID_Market</p> <p>Description of the Environmental topics integrated in the investment process of the fund,<br/>Multiple answers field.</p> <p><b>SocialTopicOrConsideredIndicat...</b></p> <p>60420_Financial_Instrument_Social_Topic_Or_Considered_Indicators_For_French_MiFID_Market:<br/>Description of the social topics integrated in the investment strategy,<br/>Multiple answers fields.<br/>A - Social and human rights<br/>B - labour relations<br/>C - investment in human capital (including health)<br/>D - none</p> <p><b>GovernanceTopicOrConsideredl...</b></p> <p>60430_Financial_Instrument_Governance_Topic_Or_Considered_Indicators_For_French_MiFID_Market:<br/>Description of the governance topic integrated in the investment strategy,<br/>Multiple answers field<br/>A - anti bribery and corruption<br/>B - governance other<br/>C - none</p> |
| <p>properties</p> | <p>isRef 0<br/>minOcc 0<br/>maxOcc 1<br/>content complex</p>  |
| <p>children</p>   | <p><a href="#">SustainabilityRisksDemedToBeRelevant</a> <a href="#">EnvironmentalTopicOrConsideredIndicators</a><br/><a href="#">SocialTopicOrConsideredIndicatorsForFrenchMiFIDMarket</a><br/><a href="#">GovernanceTopicOrConsideredIndicatorsForFrenchMiFIDMarket</a></p>  |
| <p>annotation</p> | <p>documentation<br/>60400 - 60430</p>  |

element

**EETReportType1.1/CountrySpecificInformation/France/SustainabilityRisksDemedToBeRelevant**

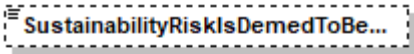
|            |  |
|------------|--|
| diagram    |  <p>60400_French_AMF_Doctrine_Approach:<br/>Which approach of the AMF position/recommendation 2020-03 does your fund comply with?<br/>1: Approach based on a significantly engaging methodology<br/>2: Non-significantly engaging methodology approach<br/>3: Approach not meeting central or limited communication standards</p> |
| type       | restriction of <b>xs:string</b>  |
| properties | isRef 0<br>minOcc 0<br>maxOcc 1<br>content simple  |
| annotation | documentation<br>60400_French_AMF_Doctrine_Approach:<br>Which approach of the AMF position/recommendation 2020-03 does your fund comply with?<br>1: Approach based on a significantly engaging methodology<br>2: Non-significantly engaging methodology approach<br>3: Approach not meeting central or limited communication standards   |

element

**EETReportType1.1/CountrySpecificInformation/France/EnvironmentalTopicOrConsideredIndicators**

|            |   |
|------------|---|
| diagram    |  <p>60410_Financial_Instrument_Environmental_Topic_Or_Considered_Indicators_For_French_MiFID_Market</p> <p>Description of the Environmental topics integrated in the investment process of the fund,<br/>Multiple answers field.</p> |
| type       | restriction of <b>xs:string</b>   |
| properties | isRef 0<br>minOcc 0<br>maxOcc 1<br>content simple   |
| annotation | documentation<br>60410_Financial_Instrument_Environmental_Topic_Or_Considered_Indicators_For_French_MiFID_Market  |
|            | Description of the Environmental topics integrated in the investment process of the fund,<br>Multiple answers field.  |

element

**EETReportType1.1/CountrySpecificInformation/France/SocialTopicOrConsideredIndicatorsForFrenchMiFIDMarket**

|            |   |
|------------|---|
| diagram    |  <b>SocialTopicOrConsideredIndicat...</b><br>60420_Financial_Instrument_Social_Topic_Or_Considered_Indicators_For_French_MiFID_Market:<br>Description of the social topics integrated in the investment strategy,<br>Multiple answers fields.<br>A - Social and human rights<br>B - labour relations<br>C - investment in human capital (including health)<br>D - none |
| type       | restriction of <b>xs:string</b>   |
| properties | isRef 0<br>minOcc 0<br>maxOcc 1<br>content simple   |
| annotation | documentation<br>60420_Financial_Instrument_Social_Topic_Or_Considered_Indicators_For_French_MiFID_Market:<br>Description of the social topics integrated in the investment strategy,<br>Multiple answers fields.<br>A - Social and human rights<br>B - labour relations<br>C - investment in human capital (including health)<br>D - none  |

element

**EETReportType1.1/CountrySpecificInformation/France/GovernanceTopicOrConsideredIndicatorsForFrenchMiFIDMarket**

|            |  |
|------------|--|
| diagram    |  <b>GovernanceTopicOrConsideredl...</b><br>60430_Financial_Instrument_Governance_Topic_Or_Considered_Indicators_For_French_MiFID_Market:<br>Description of the governance topic integrated in the investment strategy,<br>Multiple answers field<br>A - anti bribery and corruption<br>B - governance other<br>C - none |
| type       | restriction of <b>xs:string</b>  |
| properties | isRef 0<br>minOcc 0<br>maxOcc 1<br>content simple  |
| annotation | documentation<br>60430_Financial_Instrument_Governance_Topic_Or_Considered_Indicators_For_French_MiFID_Market:<br>Description of the governance topic integrated in the investment strategy,<br>Multiple answers field<br>A - anti bribery and corruption<br>B - governance other<br>C - none  |

element **EETReportType1.1/CountrySpecificInformation/Germany**

|            |   |
|------------|---|
| diagram    | <p>Germany<br/>60440</p> <p>SustainableIndicatorsForGermanMiFIDMarket<br/>60440_Financial_Instrument_Sustainable_Indicators_For_German_MiFID_Market:<br/>O, B, E, P, Q, R, S, T, U or V</p> |
| properties | <p>isRef 0</p> <p>minOcc 0</p> <p>maxOcc 1</p> <p>content complex</p>   |
| children   | <a href="#">SustainableIndicatorsForGermanMiFIDMarket</a>   |
| annotation | documentation<br>60440  |

element **EETReportType1.1/CountrySpecificInformation/Germany/SustainableIndicatorsForGermanMiFIDMarket**

|            |  |
|------------|--|
| diagram    | <p>SustainableIndicatorsForGermanMiFIDMarket<br/>60440_Financial_Instrument_Sustainable_Indicators_For_German_MiFID_Market:<br/>O, B, E, P, Q, R, S, T, U or V</p> |
| type       | restriction of <b>xs:string</b>  |
| properties | <p>isRef 0</p> <p>minOcc 0</p> <p>maxOcc 1</p> <p>content simple</p>   |
| annotation | documentation<br>60440_Financial_Instrument_Sustainable_Indicators_For_German_MiFID_Market:<br>O, B, E, P, Q, R, S, T, U or V                                      |

element **EETReportType1.1/SupplementaryFieldsV1.1**

|            |   |
|------------|---|
| diagram    | <p>SupplementaryFieldsV1.1<br/>70000-70010</p> <p>SustainabilityRisksDeemedToBeRelevant<br/>70000_Financial_Instrument_Sustainability_Risk_Is_Deemed_To_Be_Relevant<br/>SFDR art 6.1<br/>Yes / No</p> <p>TotalFundAUMORNational<br/>70010_Financial_Instrument_Total_Fund_AUM_Or_Notional<br/>AUM for a fund and Notional for structured products at PAI_End_Of_Reference_Period in EUR</p> |
| properties | <p>isRef 0</p> <p>minOcc 0</p> <p>maxOcc 1</p> <p>content complex</p>   |
| children   | <a href="#">SustainabilityRisksDeemedToBeRelevant</a> <a href="#">TotalFundAUMORNational</a>  |
| annotation | documentation<br>70000- 70010   |

element **EETReportType1.1/SupplementaryFieldsV1.1/SustainabilityRisksDemedToBeRelevant**

|            |  |
|------------|--|
| diagram    |  <p>70000_Financial_Instrument_Sustainability_Risk_Is_Deemed_To_Be_Relevant<br/>SFDR art 6.1<br/>Yes / No</p> |
| type       | <a href="#">EETYesNoType</a>   |
| properties | isRef 0<br>minOcc 0<br>maxOcc 1<br>content simple  |
| facets     | Kind Value annotation<br>length 1  |
| annotation | documentation<br>70000_Financial_Instrument_Sustainability_Risk_Is_Deemed_To_Be_Relevant<br>SFDR art 6.1<br>Yes / No   |

element **EETReportType1.1/SupplementaryFieldsV1.1/TotalFundAUMORNational**

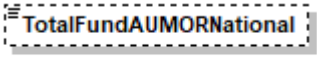
|            |  |
|------------|--|
| diagram    |  <p>70010_Financial_Instrument_Total_Fund_AUM_Or_Notional<br/>AUM for a fund and Notional for structured products at<br/>PAI_End_Of_Reference_Period in<br/>EUR</p> |
| type       | restriction of <b>xs:decimal</b>   |
| properties | isRef 0<br>minOcc 0<br>maxOcc 1<br>content simple  |
| annotation | documentation<br>70010_Financial_Instrument_Total_Fund_AUM_Or_Notional<br>AUM for a fund and Notional for structured products at PAI_End_Of_Reference_Period in EUR  |

element **EETReportType1.1/StructuredProductsAdditionalInformation**

|                   |  |
|-------------------|--|
| <p>diagram</p>    | <p><b>StructuredProductsAdditionalInformation</b><br/>80000 - 80050</p> <ul style="list-style-type: none"> <li><b>UseOfProceedsAssetPooling</b><br/>80000 "Defines if use of proceeds constitute<br/>S - Segregated Sustainable Asset Pool (SAP)<br/>U - Unsegregated Sustainable Asset Pool (USAP)<br/>N - Not a pooled approach (N) and therefore a general part of the balance sheet of the Issuer/Manufacturer"</li> <li><b>UseOfDerivativeExposure</b><br/>80010 Defines if the derivative exposure of a Structured Product is considered part of the assessed Taxonomy Alignment and Minimum Proportion of Sustainable Investment reported.</li> <li><b>StructuredProductFundingRelat...</b><br/>80020 Conditional to 20420 is filled and 80010 is set to Y. Means the percentage points reported in 20420 if only Funding component is considered.</li> <li><b>StructuredProductDerivateExpo...</b><br/>80030 Conditional to 20420 is filled and 80010 is set to Y. Means the percentage points reported in 20420 related to Derivative Exposure.</li> <li><b>StructuredProductFundingRelat...</b><br/>80040 Conditional to 20450 is filled and 80010 is set to Y. Means the percentage points reported in 20450 if only Funding component is considered.</li> <li><b>StructuredProductDerivateExpo...</b><br/>80050 Conditional to 20450 is filled and 80010 is set to Y. Means the percentage points reported in 20450 related to Derivative Exposure.</li> </ul> |
| <p>properties</p> | <p>isRef 0<br/>minOcc 0<br/>maxOcc 1<br/>content complex</p>   |
| <p>children</p>   | <p><a href="#">UseOfProceedsAssetPooling</a> <a href="#">UseOfDerivativeExposure</a><br/><a href="#">StructuredProductFundingRelatedEUSFDRMinimumOrPlannedInvestmentsSustainableInvestments</a><br/><a href="#">StructuredProductDerivateExposureRelatedEUSFDRMinimumOrPlannedInvestmentsSustainableInvestments</a><br/><a href="#">StructuredProductFundingRelatedEUSFDRMinimumOrPlannedInvestmentsSustainableInvestmentsTaxonomyAligned</a><br/><a href="#">StructuredProductDerivateExposureRelatedEUSFDRMinimumOrPlannedInvestmentsSustainableInvestmentsTaxonomyAligned</a></p>   |
| <p>annotation</p> | <p>documentation<br/>80000 - 80050</p>   |

element **EETReportType1.1/StructuredProductsAdditionalInformation/UseOfProceedsAssetPooling**

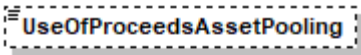
|            |  |
|------------|--|
| diagram    |  <p>80000 "Defines if use of proceeds constitute<br/>S - Segregated Sustainable Asset Pool (SAP)<br/>U - Unsegregated Sustainable Asset Pool (USAP)<br/>N - Not a pooled approach (N) and therefore a general part of the balance sheet of the Issuer/Manufacturer"</p> |
| type       | restriction of <b>xs:string</b>  |
| properties | <p>isRef 0<br/>minOcc 0<br/>maxOcc 1<br/>content simple</p>  |
| annotation | <p>documentation<br/>80000 "Defines if use of proceeds constitute<br/>S - Segregated Sustainable Asset Pool (SAP)<br/>U - Unsegregated Sustainable Asset Pool (USAP)<br/>N - Not a pooled approach (N) and therefore a general part of the balance sheet of the Issuer/Manufacturer"</p>   |

element **EETReportType1.1/StructuredProductsAdditionalInformation/UseOfDerivativeExposure**

|            |  |
|------------|--|
| diagram    |  <p>80010 Defines if the derivative exposure of a Structured Product is considered part of the assessed Taxonomy Alignment and Minimum Proportion of Sustainable Investment reported.</p> |
| type       | <a href="#">EETYesNoType</a>   |
| properties | <p>isRef 0<br/>minOcc 0<br/>maxOcc 1<br/>content simple</p>  |
| facets     | <p>Kind Value annotation<br/>length 1</p>  |
| annotation | <p>documentation<br/>80010 Defines if the derivative exposure of a Structured Product is considered part of the assessed Taxonomy Alignment and Minimum Proportion of Sustainable Investment reported.</p>   |



element

**EETReportType1.1/StructuredProductsAdditionalInformation/StructuredProductFundingRelatedEUSFDRMinimumOrPlannedInvestmentsSustainableInvestments**

|            |   |
|------------|---|
| diagram    |  <b>StructuredProductFundingRelat...</b><br>80020 Conditional to 20420 is filled and 80010 is set to Y. Means the percentage points reported in 20420 if only Funding component is considered. |
| type       | <b>xs:decimal</b>   |
| properties | isRef 0<br>minOcc 0<br>maxOcc 1<br>content simple   |
| annotation | documentation<br>80020 Conditional to 20420 is filled and 80010 is set to Y. Means the percentage points reported in 20420 if only Funding component is considered.   |

element

**EETReportType1.1/StructuredProductsAdditionalInformation/StructuredProductDerivateExposureRelatedEUSFDRMinimumOrPlannedInvestmentsSustainableInvestments**

|            |  |
|------------|--|
| diagram    |  <b>StructuredProductDerivateExpo...</b><br>80030 Conditional to 20420 is filled and 80010 is set to Y. Means the percentage points reported in 20420 related to Derivative Exposure. |
| type       | <b>xs:decimal</b>  |
| properties | isRef 0<br>minOcc 0<br>maxOcc 1<br>content simple  |
| annotation | documentation<br>80030 Conditional to 20420 is filled and 80010 is set to Y. Means the percentage points reported in 20420 related to Derivative Exposure.   |

element

**EETReportType1.1/StructuredProductsAdditionalInformation/StructuredProductFundingRelatedEUSFDRMinimumOrPlannedInvestmentsSustainableInvestmentsTaxonomyAligned**

|            |   |
|------------|---|
| diagram    |  <b>StructuredProductFundingRelat...</b><br>80040 Conditional to 20450 is filled and 80010 is set to Y. Means the percentage points reported in 20450 if only Funding component is considered. |
| type       | <b>xs:decimal</b>   |
| properties | isRef 0<br>minOcc 0<br>maxOcc 1<br>content simple   |

|            |   |
|------------|---|
| annotation | documentation<br>80040 Conditional to 20450 is filled and 80010 is set to Y. Means the percentage points reported in 20450 if only Funding component is considered. |
|------------|---|

element

**EETReportType1.1/StructuredProductsAdditionalInformation/StructuredProductDerivateExposureRelatedEUSFDRMinimumOrPlannedInvestmentsSustainableInvestmentsTaxonomyAligned**

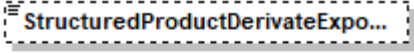
|            |  |
|------------|--|
| diagram    |  <p>80050 Conditional to 20450 is filled and 80010 is set to Y. Means the percentage points reported in 20450 related to Derivative Exposure.</p> |
| type       | <b>xs:decimal</b>  |
| properties | isRef 0<br>minOcc 0<br>maxOcc 1<br>content simple  |
| annotation | documentation<br>80050 Conditional to 20450 is filled and 80010 is set to Y. Means the percentage points reported in 20450 related to Derivative Exposure.   |

complexType **EETReportType1.1.1**

diagram



|          |  |
|----------|--|
| children | <a href="#">DataSetInformation</a> <a href="#">GeneralFinancialInstrumentInformation</a> <a href="#">MainCriteria</a> <a href="#">ProductDisclosures</a> <a href="#">SpecificInformationForArt8and9</a> <a href="#">ESGThematicInvestingDescription</a> <a href="#">ESGEngagementCoverage</a> <a href="#">ESGBenchmark</a> <a href="#">MinimumSustainableInvestments</a> <a href="#">LastReportedSustainableInvestments</a> <a href="#">AdditionalInfoArt9</a> <a href="#">MiFIDIDDTargetMarket</a> <a href="#">TaxonomyAlignedInvestments</a> <a href="#">PrincipalAdverseIndicators</a> <a href="#">ScreeningCriteria</a> <a href="#">CountrySpecificInformation</a> <a href="#">SupplementaryFieldsV1.1</a> <a href="#">StructuredProductsAdditionalInformation</a> <a href="#">SupplementaryTaxonomyInformationV1.1.1</a> <a href="#">ComplementaryInformation</a> |
| used by  | element <a href="#">EETsType1.1.1/EET1.1.1</a>   |

element **EETReportType1.1.1/DataSetInformation**

|            |   |
|------------|---|
| diagram    | <pre> classDiagram     class DataSetInformation {         00010 - 13000     }     class ManufacturerInformation {         10000 - 10040     }     class ManufacturerCommitmentToR... {         11000 - 11040     }     class ManufacturerStewardshipCode... {         12000 - 12040         0..∞     }     class ManufacturerWebsiteInformatio... {         13000 - 13040     }     DataSetInformation &lt; -- ManufacturerInformation     DataSetInformation &lt; -- ManufacturerCommitmentToR...     DataSetInformation &lt; -- ManufacturerStewardshipCode...     DataSetInformation &lt; -- ManufacturerWebsiteInformatio... </pre> <p>The diagram illustrates the class hierarchy for <b>DataSetInformation</b> (00010 - 13000). It is a base class for four subclasses: <b>ManufacturerInformation</b> (10000 - 10040), <b>ManufacturerCommitmentToR...</b> (11000 - 11040), <b>ManufacturerStewardshipCode...</b> (12000 - 12040), and <b>ManufacturerWebsiteInformatio...</b> (13000 - 13040). The <b>ManufacturerStewardshipCode...</b> class has a multiplicity of 0..∞. The <b>ManufacturerStewardshipCode...</b> class has a description: "12000_Manufacturer_Stewardship_Code_Signatory Disclosure of the applicable Stewardship Code". The <b>ManufacturerWebsiteInformatio...</b> class has a description: "13000_Manufacturer_Website_Information_Stewardship_And_Engagement Internet adress where the client can find all relevant informations regarding stewardship and engagement of the manufacturer".</p> |
| properties | isRef 0<br>content complex  |
| children   | <a href="#">DataSetInformation</a> <a href="#">ManufacturerInformation</a> <a href="#">ManufacturerCommitmentToResponsibleInvestment</a> <a href="#">ManufacturerStewardshipCodeSignatory</a> <a href="#">ManufacturerWebsiteInformationStewardshipAndEngagement</a>  |
| annotation | documentation<br>00010 - 13000  |

element **EETReportType1.1.1/DataSetInformation/DataSetInformation**

|                   |  |
|-------------------|--|
| <p>diagram</p>    |  |
| <p>properties</p> | <p>isRef 0<br/>content complex</p>   |
| <p>children</p>   | <p><a href="#">Version</a> <a href="#">Producer</a> <a href="#">FileGeneration</a> <a href="#">DataReporting</a></p> |
| <p>annotation</p> | <p>documentation<br/>00010 - 00100</p>   |

element **EETReportType1.1.1/DataSetInformation/DataSetInformation/Version**

|                   |  |
|-------------------|--|
| <p>diagram</p>    |  |
| <p>type</p>       | <p>restriction of <b>xs:string</b></p>   |
| <p>properties</p> | <p>isRef 0<br/>content simple</p>  |
| <p>annotation</p> | <p>documentation<br/>This field specifies the output version of the template and is used by the recipient to understand the number of fields expected, their labeling and order.</p> |

element **EETReportType1.1.1/DataSetInformation/DataSetInformation/Producer**

|            |  |
|------------|--|
| diagram    |  |
| properties | isRef 0<br>minOcc 0<br>maxOcc 1<br>content complex   |
| children   | <a href="#">Name</a> <a href="#">LEI</a> <a href="#">Email</a>                                 |
| annotation | documentation<br>00020_EET_Producer_Name<br>00030_EET_Producer_LEI<br>00040_EET_Producer_Email |

element **EETReportType1.1.1/DataSetInformation/DataSetInformation/Producer/Name**

|            |   |
|------------|---|
| diagram    |   |
| type       | <b>xs:string</b>                                  |
| properties | isRef 0<br>minOcc 0<br>maxOcc 1<br>content simple |
| annotation | documentation<br>00020_EET_Producer_Name          |

element **EETReportType1.1.1/DataSetInformation/DataSetInformation/Producer/LEI**

|            |  |            |       |            |           |    |  |           |    |  |         |                           |  |
|------------|--|------------|-------|------------|-----------|----|--|-----------|----|--|---------|---------------------------|--|
| diagram    |  |            |       |            |           |    |  |           |    |  |         |                           |  |
| type       | <a href="#">LEICodeType</a>  |            |       |            |           |    |  |           |    |  |         |                           |  |
| properties | isRef 0<br>minOcc 0<br>maxOcc 1<br>content simple  |            |       |            |           |    |  |           |    |  |         |                           |  |
| facets     | <table border="0"> <tr> <td>Kind</td> <td>Value</td> <td>annotation</td> </tr> <tr> <td>minLength</td> <td>20</td> <td></td> </tr> <tr> <td>maxLength</td> <td>20</td> <td></td> </tr> <tr> <td>pattern</td> <td>([0-9a-zA-Z]{18}[0-9]{2})</td> <td></td> </tr> </table> | Kind       | Value | annotation | minLength | 20 |  | maxLength | 20 |  | pattern | ([0-9a-zA-Z]{18}[0-9]{2}) |  |
| Kind       | Value  | annotation |       |            |           |    |  |           |    |  |         |                           |  |
| minLength  | 20   |            |       |            |           |    |  |           |    |  |         |                           |  |
| maxLength  | 20   |            |       |            |           |    |  |           |    |  |         |                           |  |
| pattern    | ([0-9a-zA-Z]{18}[0-9]{2})  |            |       |            |           |    |  |           |    |  |         |                           |  |
| annotation | documentation<br>00030_EET_Producer_LEI  |            |       |            |           |    |  |           |    |  |         |                           |  |

element **EETReportType1.1.1/DataSetInformation/DataSetInformation/Producer/Email**

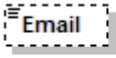
|            |   |
|------------|---|
| diagram    |  <p>00040_EET_Producer_Email</p> |
| type       | <b>xs:string</b>  |
| properties | isRef 0<br>minOcc 0<br>maxOcc 1<br>content simple   |
| annotation | documentation<br>00040_EET_Producer_Email   |

element **EETReportType1.1.1/DataSetInformation/DataSetInformation/FileGeneration**

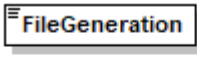
|            |   |
|------------|---|
| diagram    |  <p>00050_EET_File_Generation<br/>_Date_And_Time<br/>Date and Time of the<br/>creation of the EET file</p> |
| type       | <b>xs:dateTime</b>  |
| properties | isRef 0<br>content simple   |
| annotation | documentation<br>00050_EET_File_Generation_Date_And_Time<br>Date and Time of the creation of the EET file   |

element **EETReportType1.1.1/DataSetInformation/DataSetInformation/DataReporting**

|            |   |
|------------|---|
| diagram    |   |
| properties | isRef 0<br>content complex  |
| children   | <a href="#">SFDRPreContractual</a> <a href="#">SFDRPeriodic</a> <a href="#">SFDREntityLevel</a> <a href="#">MiFID</a> <a href="#">IDD</a> |
| annotation | documentation<br>00060 - 00100  |

element **EETReportType1.1.1/DataSetInformation/DataSetInformation/DataReporting/SFDRPreContractual**

|            |  |
|------------|--|
| diagram    |  |
| type       | <a href="#">EETYesNoType</a>                                   |
| properties | isRef 0<br>content simple                                      |
| facets     | Kind Value annotation<br>length 1                              |
| annotation | documentation<br>00060_EET_Data_Reporting_SFDR_Pre_Contractual |



element **EETReportType1.1.1/DataSetInformation/DataSetInformation/DataReporting/SFDRPeriodic**

|            |   |
|------------|---|
| diagram    |  <p>00070_EET_Data_Reporting_SFDR_Periodic<br/>No means that there is not yet a periodic reporting. The M related fields have not to be fulfilled"</p> |
| type       | <a href="#">EETYesNoType</a>  |
| properties | isRef 0<br>content simple   |
| facets     | Kind Value annotation<br>length 1   |
| annotation | documentation<br>00070_EET_Data_Reporting_SFDR_Periodic<br>No means that there is not yet a periodic reporting. The M related fields have not to be fulfilled"  |

element **EETReportType1.1.1/DataSetInformation/DataSetInformation/DataReporting/SFDREntityLevel**

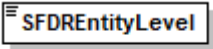
|            |   |
|------------|---|
| diagram    |  <p>00080_EET_Data_Reporting_SFDR_Entity_Level</p> |
| type       | <a href="#">EETYesNoType</a>  |
| properties | isRef 0<br>content simple   |
| facets     | Kind Value annotation<br>length 1   |
| annotation | documentation<br>00080_EET_Data_Reporting_SFDR_Entity_Level   |

element **EETReportType1.1.1/DataSetInformation/DataSetInformation/DataReporting/MiFID**

|            |   |
|------------|---|
| diagram    |  <p>00090_EET_Data_Reporting_Mifid</p> |
| type       | <a href="#">EETYesNoType</a>  |
| properties | isRef 0<br>content simple   |
| facets     | Kind Value annotation<br>length 1   |
| annotation | documentation<br>00090_EET_Data_Reporting_Mifid   |

element **EETReportType1.1.1/DataSetInformation/DataSetInformation/DataReporting/IDD**

|            |   |
|------------|---|
| diagram    |   |
| type       | <a href="#">EETYesNoType</a>                  |
| properties | isRef 0<br>content simple                     |
| facets     | Kind Value annotation<br>length 1             |
| annotation | documentation<br>00100_EET_Data_Reporting_IDD |

element **EETReportType1.1.1/DataSetInformation/ManufacturerInformation**

|            |   |
|------------|---|
| diagram    |   |
| properties | isRef 0<br>content complex  |
| children   | <a href="#">Name</a> <a href="#">CodeType</a> <a href="#">Code</a> <a href="#">Email</a> <a href="#">GeneralReferenceDate</a> |
| annotation | documentation<br>10000 - 10040  |

element **EETReportType1.1.1/DataSetInformation/ManufacturerInformation/Name**

|         |  |
|---------|--|
| diagram |  |
|---------|--|

|            |  |
|------------|--|
| type       | restriction of <b>xs:string</b>                                      |
| properties | isRef 0<br>content simple  |
| facets     | Kind Value annotation<br>maxLength 255                               |
| annotation | documentation<br>10000_Manufacturer_Name<br>Name of the Manufacturer |

element **EETReportType1.1.1/DataSetInformation/ManufacturerInformation/CodeType**

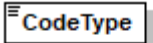
|            |   |
|------------|---|
| diagram    |  <p>10010_Manufacturer_Code_Type<br/>Codification used to determine the identification code. Either LEI or None.</p> |
| type       | restriction of <b>xs:string</b>   |
| properties | isRef 0<br>content simple   |
| annotation | documentation<br>10010_Manufacturer_Code_Type<br>Codification used to determine the identification code. Either LEI or None.  |

element **EETReportType1.1.1/DataSetInformation/ManufacturerInformation/Code**

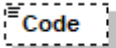
|            |  |
|------------|--|
| diagram    |  <p>10020_Manufacturer_Code<br/>Identification code of the Manufacturer</p> |
| type       | restriction of <b>xs:string</b>  |
| properties | isRef 0<br>minOcc 0<br>maxOcc 1<br>content simple  |
| facets     | Kind Value annotation<br>maxLength 255   |
| annotation | documentation<br>10020_Manufacturer_Code<br>Identification code of the Manufacturer  |

element **EETReportType1.1.1/DataSetInformation/ManufacturerInformation/Email**

|            |   |
|------------|---|
| diagram    |  <p>10030_Manufacturer_Email<br/>Contact entry point for distributors for content question</p> |
| type       | <b>xs:string</b>  |
| properties | isRef 0<br>minOcc 0<br>maxOcc 1<br>content simple   |

|            |  |
|------------|--|
| annotation | documentation<br>10030_Manufacturer_Email<br>Contact entry point for distributors for content question |
|------------|--|

element **EETReportType1.1.1/DataSetInformation/ManufacturerInformation/GeneralReferenceDate**

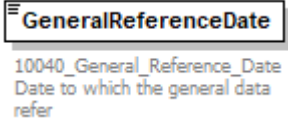
|            |  |
|------------|--|
| diagram    |  <p><b>GeneralReferenceDate</b><br/>10040_General_Reference_Date<br/>Date to which the general data refer</p> |
| type       | <b>xs:date</b>   |
| properties | isRef 0<br>content simple  |
| annotation | documentation<br>10040_General_Reference_Date<br>Date to which the general data refer  |

element **EETReportType1.1.1/DataSetInformation/ManufacturerCommitmentToResponsibleInvestment**

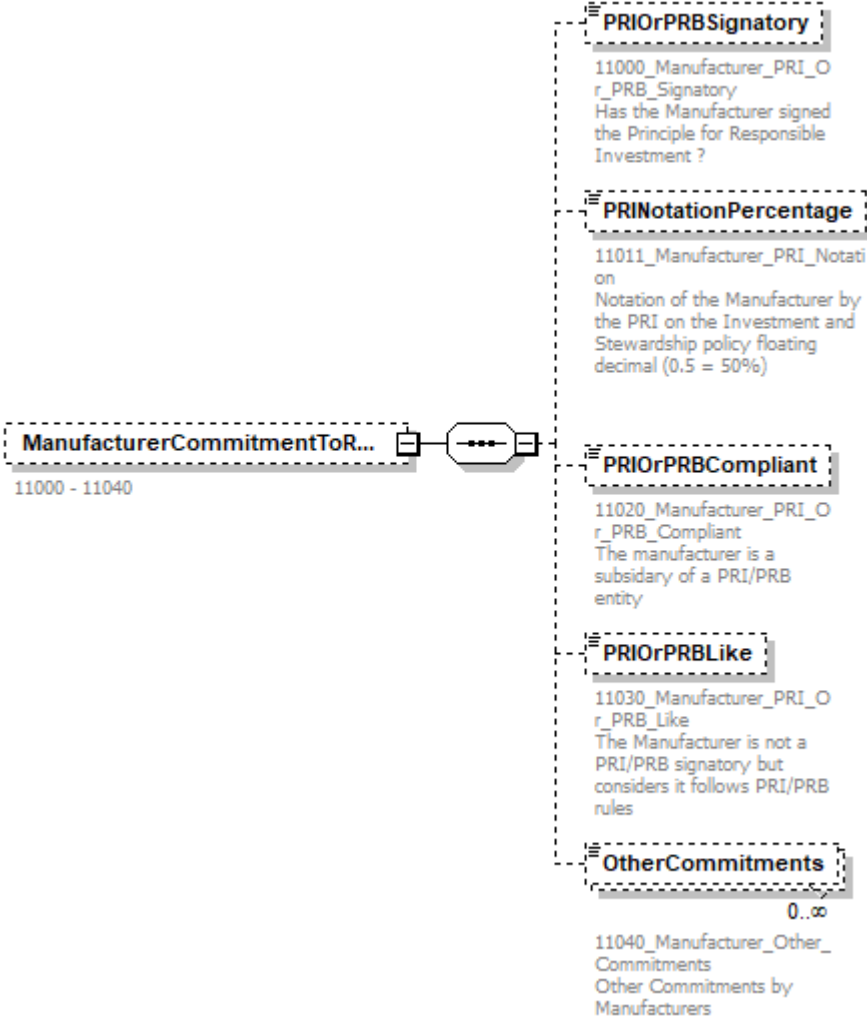
|            |  |
|------------|--|
| diagram    |  <p><b>ManufacturerCommitmentToResponsibleInvestment</b><br/>11000 - 11040</p> <ul style="list-style-type: none"> <li><b>PRIOrPRBSignatory</b><br/>11000_Manufacturer_PRI_O<br/>r_PRB_Signatory<br/>Has the Manufacturer signed<br/>the Principle for Responsible<br/>Investment ?</li> <li><b>PRINotationPercentage</b><br/>11011_Manufacturer_PRI_Notati<br/>on<br/>Notation of the Manufacturer by<br/>the PRI on the Investment and<br/>Stewardship policy floating<br/>decimal (0.5 = 50%)</li> <li><b>PRIOrPRBCompliant</b><br/>11020_Manufacturer_PRI_O<br/>r_PRB_Compliant<br/>The manufacturer is a<br/>subsidiary of a PRI/PRB<br/>entity</li> <li><b>PRIOrPRBLike</b><br/>11030_Manufacturer_PRI_O<br/>r_PRB_Like<br/>The Manufacturer is not a<br/>PRI/PRB signatory but<br/>considers it follows PRI/PRB<br/>rules</li> <li><b>OtherCommitments</b><br/>0..∞<br/>11040_Manufacturer_Other_<br/>Commitments<br/>Other Commitments by<br/>Manufacturers</li> </ul> |
| properties | isRef 0<br>minOcc 0  |

|            |   |
|------------|---|
|            | maxOcc 1<br>content complex   |
| children   | <a href="#">PRIOrPRBSignatory</a> <a href="#">PRINotationPercentage</a> <a href="#">PRIOrPRBCompliant</a> <a href="#">PRIOrPRBLike</a> <a href="#">OtherCommitments</a> |
| annotation | documentation<br>11000 - 11040  |

element

**EETReportType1.1.1/DataSetInformation/ManufacturerCommitmentToResponsibleInvestment/PRIOrPRBSignatory**

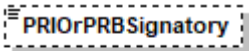
|            |   |
|------------|---|
| diagram    |  <p>11000_Manufacturer_PRI_Or_PRB_Signatory<br/>Has the Manufacturer signed the Principle for Responsible Investment ?</p> |
| type       | <a href="#">EETYesNoType</a>  |
| properties | isRef 0<br>minOcc 0<br>maxOcc 1<br>content simple   |
| facets     | Kind Value annotation<br>length 1   |
| annotation | documentation<br>11000_Manufacturer_PRI_Or_PRB_Signatory<br>Has the Manufacturer signed the Principle for Responsible Investment ?  |

element

**EETReportType1.1.1/DataSetInformation/ManufacturerCommitmentToResponsibleInvestment/PRINotationPercentage**

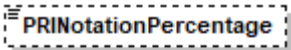
|            |  |
|------------|--|
| diagram    |  <p>11011_Manufacturer_PRI_Notation<br/>Notation of the Manufacturer by the PRI on the Investment and Stewardship policy floating decimal (0.5 = 50%)</p> |
| type       | <b>xs:decimal</b>  |
| properties | isRef 0<br>minOcc 0<br>maxOcc 1<br>content simple  |
| annotation | documentation<br>11011_Manufacturer_PRI_Notation<br>Notation of the Manufacturer by the PRI on the Investment and Stewardship policy floating decimal (0.5 = 50%)  |

element

### EETReportType1.1.1/DataSetInformation/ManufacturerCommitmentToResponsibleInvestment/PRIOrPRBCompliant

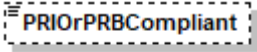
|            |   |
|------------|---|
| diagram    |  <p>11020_Manufacturer_PRI_Or_PRB_Compliant<br/>The manufacturer is a subsidiary of a PRI/PRB entity</p> |
| type       | <a href="#">EETYesNoType</a>  |
| properties | isRef 0<br>minOcc 0<br>maxOcc 1<br>content simple   |
| facets     | Kind Value annotation<br>length 1   |
| annotation | documentation<br>11020_Manufacturer_PRI_Or_PRB_Compliant<br>The manufacturer is a subsidiary of a PRI/PRB entity  |

element

### EETReportType1.1.1/DataSetInformation/ManufacturerCommitmentToResponsibleInvestment/PRIOrPRBLike

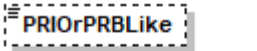
|            |   |
|------------|---|
| diagram    |  <p>11030_Manufacturer_PRI_Or_PRB_Like<br/>The Manufacturer is not a PRI/PRB signatory but considers it follows PRI/PRB rules</p> |
| type       | <a href="#">EETYesNoType</a>  |
| properties | isRef 0<br>minOcc 0<br>maxOcc 1<br>content simple   |
| facets     | Kind Value annotation<br>length 1   |
| annotation | documentation<br>11030_Manufacturer_PRI_Or_PRB_Like<br>The Manufacturer is not a PRI/PRB signatory but considers it follows PRI/PRB rules   |

element

### EETReportType1.1.1/DataSetInformation/ManufacturerCommitmentToResponsibleInvestment/OtherCommitments

|         |  |
|---------|--|
| diagram |  <p>11040_Manufacturer_Other_Commitments<br/>Other Commitments by Manufacturers</p> |
| type    | restriction of <b>xs:string</b>  |

|            |   |
|------------|---|
| properties | isRef 0<br>minOcc 0<br>maxOcc unbounded<br>content simple                                   |
| annotation | documentation<br>11040_Manufacturer_Other_Commitments<br>Other Commitments by Manufacturers |

element **EETReportType1.1.1/DataSetInformation/ManufacturerStewardshipCodeSignatory**

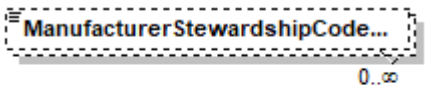
|            |  |
|------------|--|
| diagram    |  <p>12000_Manufacturer_Stewardship_Code_Signatory<br/>Disclosure of the applicable Stewardship Code</p> |
| type       | restriction of <b>xs:string</b>  |
| properties | isRef 0<br>minOcc 0<br>maxOcc unbounded<br>content simple  |
| annotation | documentation<br>12000_Manufacturer_Stewardship_Code_Signatory<br>Disclosure of the applicable Stewardship Code  |

element **EETReportType1.1.1/DataSetInformation/ManufacturerWebsiteInformationStewardshipAndEngagement**

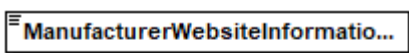
|            |   |
|------------|---|
| diagram    |  <p>13000_Manufacturer_Website_Information_Stewardship_And_Engagement<br/>Internet adress where the client can find all relevant informations regarding stewardship and engagement of the manufacturer</p> |
| type       | <b>xs:string</b>  |
| properties | isRef 0<br>content simple   |
| annotation | documentation<br>13000_Manufacturer_Website_Information_Stewardship_And_Engagement<br>Internet adress where the client can find all relevant informations regarding stewardship and engagement of the manufacturer  |

element **EETReportType1.1.1/GeneralFinancialInstrumentInformation**

diagram

**GeneralFinancialInstrumentInf...**

20000 - 20030

**IdentifyingData**

20000\_Financial\_Instrument\_Identifying\_Data  
Use the following priority:  
- ISO 6166 code of ISIN when available  
- Other recognised codes (e.g.: CUSIP, Bloomberg Ticker, Reuters RIC)  
- Code attributed by the undertaking, when the options above are not available. Code must be unique and kept consistent over time

**TypeOfIdentification**

20010\_Financial\_Instrument\_Type\_Of\_Identification\_Code  
One of the options in the following closed list to be used:  
1 - ISO 6166 for ISIN code  
2 - CUSIP (The Committee on Uniform Securities Identification Procedures number assigned by the CUSIP Service Bureau for U.S. and Canadian companies)  
3 - SEDOL (Stock Exchange Daily Official List for the London Stock Exchange)  
4 - WKN (Wertpapier Kenn-Nummer, the alphanumeric German identification number)  
5 - Bloomberg Ticker (Bloomberg letters code that identify a company's securities)  
6 - BBGID (The Bloomberg Global ID)  
7 - Reuters RIC (Reuters instrument code)  
8 - FIGI (Financial Instrument Global Identifier)  
9 - Other code by members of the Association of National Numbering Agencies  
10 - LEI  
99 - Code attributed by the undertaking

**Name**

20020\_Financial\_Instrument\_Name  
Name of the financial instrument

**Currency**

20030\_Financial\_Instrument\_Currency  
Denomination Currency of the Financial Instrument



|            |  |
|------------|--|
| properties | isRef 0<br>content complex   |
| children   | <a href="#">IdentifyingData</a> <a href="#">TypeOfIdentification</a> <a href="#">Name</a> <a href="#">Currency</a> |
| annotation | documentation<br>20000 - 20030   |

element **EETReportType1.1.1/GeneralFinancialInstrumentInformation/IdentifyingData**

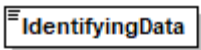
|            |   |
|------------|---|
| diagram    |  <p>20000_Financial_Instrument_Identifying_Data<br/>Use the following priority:<br/>- ISO 6166 code of ISIN when available<br/>- Other recognised codes (e.g.: CUSIP, Bloomberg Ticker, Reuters RIC)<br/>- Code attributed by the undertaking, when the options above are not available. Code must be unique and kept consistent over time</p> |
| type       | restriction of <b>xs:string</b>   |
| properties | isRef 0<br>content simple   |
| facets     | Kind Value annotation<br>maxLength 255  |
| annotation | documentation<br>20000_Financial_Instrument_Identifying_Data<br>Use the following priority:<br>- ISO 6166 code of ISIN when available<br>- Other recognised codes (e.g.: CUSIP, Bloomberg Ticker, Reuters RIC)<br>- Code attributed by the undertaking, when the options above are not available. Code must be unique and kept consistent over time   |

element **EETReportType1.1.1/GeneralFinancialInstrumentInformation/TypeOfIdentification**

|                   |  |
|-------------------|--|
| <p>diagram</p>    | <div style="border: 1px solid black; padding: 5px; margin-bottom: 10px;"> <p><b>TypeOfIdentification</b></p> </div> <p>20010_Financial_Instrument_Type_Of_Identification_Code</p> <p>One of the options in the following closed list to be used:</p> <ul style="list-style-type: none"> <li>1 - ISO 6166 for ISIN code</li> <li>2 - CUSIP (The Committee on Uniform Securities Identification Procedures number assigned by the CUSIP Service Bureau for U.S. and Canadian companies)</li> <li>3 - SEDOL (Stock Exchange Daily Official List for the London Stock Exchange)</li> <li>4 - WKN (Wertpapier Kenn-Nummer, the alphanumeric German identification number)</li> <li>5 - Bloomberg Ticker (Bloomberg letters code that identify a company's securities)</li> <li>6 - BBGID (The Bloomberg Global ID)</li> <li>7 - Reuters RIC (Reuters instrument code)</li> <li>8 - FIGI (Financial_Instrument Global Identifier)</li> <li>9 - Other code by members of the Association of National Numbering Agencies</li> <li>10 - LEI</li> <li>99 - Code attributed by the undertaking</li> </ul> |
| <p>type</p>       | <p>restriction of <b>xs:int</b></p>  |
| <p>properties</p> | <p>isRef 0<br/>content simple</p>  |
| <p>annotation</p> | <p>documentation</p> <p>20010_Financial_Instrument_Type_Of_Identification_Code</p> <p>One of the options in the following closed list to be used:</p> <ul style="list-style-type: none"> <li>1 - ISO 6166 for ISIN code</li> <li>2 - CUSIP (The Committee on Uniform Securities Identification Procedures number assigned by the CUSIP Service Bureau for U.S. and Canadian companies)</li> <li>3 - SEDOL (Stock Exchange Daily Official List for the London Stock Exchange)</li> <li>4 - WKN (Wertpapier Kenn-Nummer, the alphanumeric German identification number)</li> <li>5 - Bloomberg Ticker (Bloomberg letters code that identify a company's securities)</li> <li>6 - BBGID (The Bloomberg Global ID)</li> <li>7 - Reuters RIC (Reuters instrument code)</li> <li>8 - FIGI (Financial_Instrument Global Identifier)</li> <li>9 - Other code by members of the Association of National Numbering Agencies</li> <li>10 - LEI</li> <li>99 - Code attributed by the undertaking</li> </ul>  |

element **EETReportType1.1.1/GeneralFinancialInstrumentInformation/Name**

|            |  |
|------------|--|
| diagram    | <p>20020_Financial_Instrument<br/>_Name<br/>Name of the financial instrument</p>     |
| type       | restriction of <b>xs:string</b>  |
| properties | isRef 0<br>content simple  |
| facets     | Kind Value annotation<br>maxLength 255   |
| annotation | documentation<br>20020_Financial_Instrument_Name<br>Name of the financial instrument |

element **EETReportType1.1.1/GeneralFinancialInstrumentInformation/Currency**

|            |   |
|------------|---|
| diagram    | <p>20030_Financial_Instrument<br/>_Currency<br/>Denomination Currency of the Financial Instrument</p>     |
| type       | <a href="#"><b>ISOCurrencyCodeType</b></a>  |
| properties | isRef 0<br>content simple   |
| facets     | Kind Value annotation<br>minLength 3<br>maxLength 3<br>pattern [A-Z]{3}                                   |
| annotation | documentation<br>20030_Financial_Instrument_Currency<br>Denomination Currency of the Financial Instrument |

element **EETReportType1.1.1/MainCriteria**

diagram

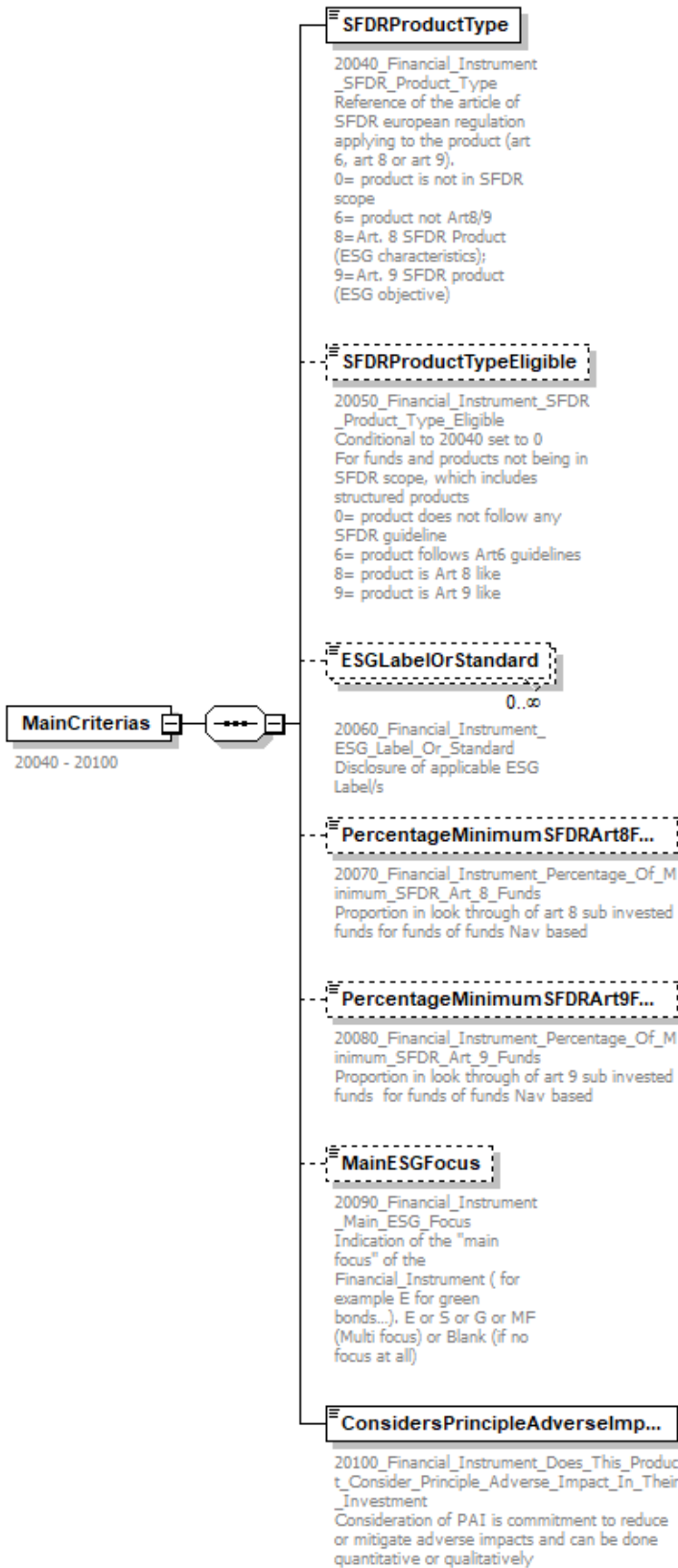

|            |   |
|------------|---|
| properties | isRef 0<br>content complex  |
| children   | <a href="#">SFDRProductType</a> <a href="#">SFDRProductTypeEligible</a> <a href="#">ESGLabelOrStandard</a> <a href="#">PercentageMinimumSFDRArt8Funds</a> <a href="#">PercentageMinimumSFDRArt9Funds</a> <a href="#">MainESGFocus</a> <a href="#">ConsidersPrincipleAdverseImpact</a> |
| annotation | documentation<br>20040 - 20100  |

element **EETReportType1.1.1/MainCriterias/SFDRProductType**

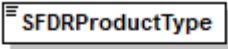
|            |  |
|------------|--|
| diagram    |  <p>20040_Financial_Instrument_SFDR_Product_Type<br/>Reference of the article of SFDR european regulation applying to the product (art 6, art 8 or art 9).<br/>0= product is not in SFDR scope<br/>6= product not Art8/9<br/>8=Art. 8 SFDR Product (ESG characteristics);<br/>9=Art. 9 SFDR product (ESG objective)</p> |
| type       | restriction of <b>xs:string</b>  |
| properties | isRef 0<br>content simple  |
| annotation | documentation<br>20040_Financial_Instrument_SFDR_Product_Type<br>Reference of the article of SFDR european regulation applying to the product (art 6, art 8 or art 9).<br>0= product is not in SFDR scope<br>6= product not Art8/9<br>8=Art. 8 SFDR Product (ESG characteristics);<br>9=Art. 9 SFDR product (ESG objective)  |

element **EETReportType1.1.1/MainCriterias/SFDRProductTypeEligible**

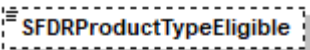
|            |  |
|------------|--|
| diagram    |  <p>20050_Financial_Instrument_SFDR_Product_Type_Eligible<br/>Conditional to 20040 set to 0<br/>For funds and products not being in SFDR scope, which includes structured products<br/>0= product does not follow any SFDR guideline<br/>6= product follows Art6 guidelines<br/>8= product is Art 8 like<br/>9= product is Art 9 like</p> |
| type       | restriction of <b>xs:string</b>  |
| properties | isRef 0<br>minOcc 0<br>maxOcc 1<br>content simple  |
| annotation | documentation<br>20050_Financial_Instrument_SFDR_Product_Type_Eligible<br>Conditional to 20040 set to 0<br>For funds and products not being in SFDR scope, which includes structured products<br>0= product does not follow any SFDR guideline   |

|  |  |
|--|--|
|  | 6= product follows Art6 guidelines<br>8= product is Art 8 like<br>9= product is Art 9 like |
|--|--|

element **EETReportType1.1.1/MainCriterias/ESGLabelOrStandard**

|            |   |
|------------|---|
| diagram    |  <p>ESGLabelOrStandard<br/>0..∞</p> <p>20060_Financial_Instrument_ESG_Label_Or_Standard<br/>Disclosure of applicable ESG Label/s</p> |
| type       | restriction of <b>xs:string</b>   |
| properties | isRef 0<br>minOcc 0<br>maxOcc unbounded<br>content simple   |
| annotation | documentation<br>20060_Financial_Instrument_ESG_Label_Or_Standard<br>Disclosure of applicable ESG Label/s   |

element **EETReportType1.1.1/MainCriterias/PercentageMinimumSFDRArt8Funds**

|            |  |
|------------|--|
| diagram    |  <p>PercentageMinimumSFDRArt8Funds<br/>0..1</p> <p>20070_Financial_Instrument_Percentage_Of_Minimum_SFDR_Art_8_Funds<br/>Proportion in look through of art 8 sub invested funds for funds of funds Nav based</p> |
| type       | <b>xs:decimal</b>  |
| properties | isRef 0<br>minOcc 0<br>maxOcc 1<br>content simple  |
| annotation | documentation<br>20070_Financial_Instrument_Percentage_Of_Minimum_SFDR_Art_8_Funds<br>Proportion in look through of art 8 sub invested funds for funds of funds Nav based  |

element **EETReportType1.1.1/MainCriterias/PercentageMinimumSFDRArt9Funds**

|            |   |
|------------|---|
| diagram    |  <p>PercentageMinimumSFDRArt9Funds<br/>0..1</p> <p>20080_Financial_Instrument_Percentage_Of_Minimum_SFDR_Art_9_Funds<br/>Proportion in look through of art 9 sub invested funds for funds of funds Nav based</p> |
| type       | <b>xs:decimal</b>   |
| properties | isRef 0<br>minOcc 0<br>maxOcc 1<br>content simple   |
| annotation | documentation   |

|  |  |
|--|--|
|  | 20080_Financial_Instrument_Percentage_Of_Minimum_SFDR_Art_9_Funds<br>Proportion in look through of art 9 sub invested funds for funds of funds Nav based |
|--|--|

element **EETReportType1.1.1/MainCriterias/MainESGFocus**

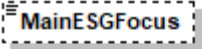
|            |   |
|------------|---|
| diagram    |  <p>20090_Financial_Instrument<br/>_Main_ESG_Focus<br/>Indication of the "main focus" of the Financial_Instrument ( for example E for green bonds...), E or S or G or MF (Multi focus) or Blank (if no focus at all)</p> |
| type       | restriction of <b>xs:string</b>   |
| properties | isRef 0<br>minOcc 0<br>maxOcc 1<br>content simple   |
| annotation | documentation<br>20090_Financial_Instrument_Main_ESG_Focus<br>Indication of the "main focus" of the Financial_Instrument ( for example E for green bonds...), E or S or G or MF (Multi focus) or Blank (if no focus at all)   |

element **EETReportType1.1.1/MainCriterias/ConsidersPrincipleAdverseImpact**

|            |   |
|------------|---|
| diagram    |  <p>20100_Financial_Instrument_Does_This_Product_Consider_Principle_Adverse_Impact_In_Their_Investment<br/>_Investment<br/>Consideration of PAI is commitment to reduce or mitigate adverse impacts and can be done quantitative or qualitatively</p> |
| type       | <a href="#">EETYesNoType</a>  |
| properties | isRef 0<br>content simple   |
| facets     | Kind Value annotation<br>length 1   |
| annotation | documentation<br>20100_Financial_Instrument_Does_This_Product_Consider_Principle_Adverse_Impact_In_Their_Investment<br>Consideration of PAI is commitment to reduce or mitigate adverse impacts and can be done quantitative or qualitatively   |

element **EETReportType1.1.1/ProductDisclosures**

|                   |   |
|-------------------|---|
| <p>diagram</p>    | <p><b>ProductDisclosures</b><br/>20110 - 20160</p> <ul style="list-style-type: none"> <li><b>Languages</b><br/>20110_Financial_Instrument_Languages<br/>Each insurance company needs to have the documents translated and published in the language of the countries of distribution. This field allows to list the languages in which the annexes documents are translated</li> <li><b>LinkToPCDFPForMOP</b><br/>20120_Financial_Instrument_Link_To_PCDFP_For_MOP<br/>Pre Contractual Disclosure for Financial Products referred to in Article 8(1) and 9(1), (2) and (3) (EU) 2019/2088 as stand alone document PDF for underlying investment options in Multi Option Products, Annex I, Annex II (EU) 2019/2088</li> <li><b>ProductionDatePCDFP</b><br/>20130_Financial_Instrument_Production_Date_PCDFP<br/>Dates of production of PCDFP for the different languages</li> <li><b>LinkToPDFPforMOP</b><br/>20140_Financial_Instrument_Link_To_PDFP_for_MOP<br/>Periodic Disclosure for Financial Products referred to in Article 8(1) and 9(1), (2) and (3) (EU) 2019/2088 as stand alone document PDF for underlying investment options in Multi Option Products, Annex III, Annex IV (EU) 2019/2088.</li> <li><b>EndDateOfReportingPeriodPDFP</b><br/>20150_Financial_Instrument_End_Date_Of_Reporting_Period_PDFP<br/>End Date Of Reporting Period PDFP (based on 12 months reporting report market usage)</li> <li><b>LinkToSFDRWebsiteProductDisc...</b><br/>20160_Financial_Instrument_Link_To_SFDR_Website_Product_Disclosures Art 10 SFDR - 24 RTS u 37 RTS</li> </ul> |
| <p>properties</p> | <p>isRef 0<br/>minOcc 0<br/>maxOcc 1<br/>content complex</p>  |
| <p>children</p>   | <p><a href="#">Languages</a> <a href="#">LinkToPCDFPForMOP</a> <a href="#">ProductionDatePCDFP</a> <a href="#">LinkToPDFPforMOP</a> <a href="#">EndDateOfReportingPeriodPDFP</a> <a href="#">LinkToSFDRWebsiteProductDisclosures</a></p>  |
| <p>annotation</p> | <p>documentation<br/>20110 - 20160</p>  |



element **EETReportType1.1.1/ProductDisclosures/Languages**

|            |   |
|------------|---|
| diagram    |  <b>Languages</b><br>20110_Financial_Instrument_Languages<br>Each insurance company needs to have the documents translated and published in the language of the countries of distribution. This field allows to list the languages in which the annexes documents are translated |
| type       | <b>xs:string</b>  |
| properties | isRef 0<br>minOcc 0<br>maxOcc 1<br>content simple   |
| annotation | documentation<br>20110_Financial_Instrument_Languages<br>Each insurance company needs to have the documents translated and published in the language of the countries of distribution. This field allows to list the languages in which the annexes documents are translated  |

element **EETReportType1.1.1/ProductDisclosures/LinkToPCDFPForMOP**

|            |  |
|------------|--|
| diagram    |  <b>LinkToPCDFPForMOP</b><br>20120_Financial_Instrument_Link_To_PCDFP_For_MOP<br>Pre Contractual Disclosure for Financial Products referred to in Article 8(1) and 9(1), (2) and (3) (EU) 2019/2088 as stand alone document PDF for underlying investment options in Multi Option Products. Annex I, Annex II (EU) 2019/2088 |
| type       | <b>xs:anyURI</b>   |
| properties | isRef 0<br>minOcc 0<br>maxOcc 1<br>content simple  |
| annotation | documentation<br>20120_Financial_Instrument_Link_To_PCDFP_For_MOP<br>Pre Contractual Disclosure for Financial Products referred to in Article 8(1) and 9(1), (2) and (3) (EU) 2019/2088 as stand alone document PDF for underlying investment options in Multi Option Products. Annex I, Annex II (EU) 2019/2088   |

element **EETReportType1.1.1/ProductDisclosures/ProductionDatePCDFP**

|         |  |
|---------|--|
| diagram |  <b>ProductionDatePCDFP</b><br>20130_Financial_Instrument_Production_Date_PCDFP<br>Dates of production of PCDFP for the different languages |
| type    | <b>xs:date</b>   |

|            |   |
|------------|---|
| properties | isRef 0<br>minOcc 0<br>maxOcc 1<br>content simple   |
| annotation | documentation<br>20130_Financial_Instrument_Production_Date_PCDFP<br>Dates of production of PCDFP for the different languages |

element **EETReportType1.1.1/ProductDisclosures/LinkToPDFPforMOP**

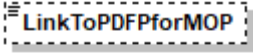
|            |  |
|------------|--|
| diagram    |  <p>20140_Financial_Instrument_Link_To_PDFP_for_MOP<br/>Periodic Disclosure for Financial Products referred to in Article 8(1) and 9(1), (2) and (3) (EU) 2019/2088 as stand alone document PDF for underlying investment options in Multi Option Products. Annex III, Annex IV (EU) 2019/2088.</p> |
| type       | <b>xs:anyURI</b>   |
| properties | isRef 0<br>minOcc 0<br>maxOcc 1<br>content simple  |
| annotation | documentation<br>20140_Financial_Instrument_Link_To_PDFP_for_MOP<br>Periodic Disclosure for Financial Products referred to in Article 8(1) and 9(1), (2) and (3) (EU) 2019/2088 as stand alone document PDF for underlying investment options in Multi Option Products. Annex III, Annex IV (EU) 2019/2088.  |

element **EETReportType1.1.1/ProductDisclosures/EndDateOfReportingPeriodPDFP**

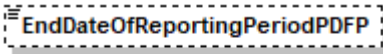
|            |  |
|------------|--|
| diagram    |  <p>20150_Financial_Instrument_End_Date_Of_Reporting_Period_PDFP<br/>End Date Of Reporting Period PDFP (based on 12 months reporting report market usage)</p> |
| type       | <b>xs:date</b>   |
| properties | isRef 0<br>minOcc 0<br>maxOcc 1<br>content simple  |
| annotation | documentation<br>20150_Financial_Instrument_End_Date_Of_Reporting_Period_PDFP<br>End Date Of Reporting Period PDFP (based on 12 months reporting report market usage)  |

element **EETReportType1.1.1/ProductDisclosures/LinkToSFDRWebsiteProductDisclosures**

|         |  |
|---------|--|
| diagram |  <p>20160_Financial_Instrument_Link_To_SFDR_Website_Product_Disclosures Art 10 SFDR - 24 RTS u 37 RTS</p> |
| type    | <b>xs:anyURI</b>   |

|            |  |
|------------|--|
| properties | isRef 0<br>minOcc 0<br>maxOcc 1<br>content simple  |
| annotation | documentation<br>20160_Financial_Instrument_Link_To_SFDR_Website_Product_Disclosures Art 10 SFDR - 24 RTS u 37 RTS |

element **EETReportType1.1.1/SpecificInformationForArt8and9**

diagram

**SpecificInformationForArt8and9**

20170 - 20250

**SustainableInvestmentsArt8**

20170\_Financial\_Instrument\_Sustainable\_Investments\_Art\_8 Does the art 8 product invest in sustainable investment?

**MinimalProportionOfSustainabl...**

20180\_Financial\_Instrument\_Products\_Minimal\_Proportion\_Of\_Sustainable\_Investments\_Art\_8

**SustainableInvestmentEUTaxon...**

20190\_Financial\_Instrument\_Sustainable\_Investment\_EU\_Taxonomy\_Art\_8 Does the minimum specified in field 20170 include EU Taxonomy sustainable investment?

**SustainableInvestmentEnviron...**

20200\_Financial\_Instrument\_Sustainable\_Investment\_Environmental\_Not\_EU\_Taxonomy\_Art\_8 Does the minimum specified in field 20170 include Non EU Taxonomy Environmental sustainable investment?

**SustainableInvestmentSocialObj...**

20210\_Financial\_Instrument\_Sustainable\_Investment\_Social\_Objective\_Art\_8 Does the minimum specified in field 20170 include include sustainable investment with social objective?

**SustainableInvestmentWithEnvi...**

20220\_Financial\_Instrument\_Minimum\_Sustainable\_Investment\_With\_Environmental\_Objective\_Art\_9 For art 9 products, the minimum proportion of sustainable investments.

**EnvironmentallySustainableInve...**

20230\_Financial\_Instrument\_Environmentally\_Sustainable\_Investment\_EU\_Taxonomy\_Art\_9 Does the minimum specified in field 20220 include EU Taxonomy Environmental sustainable investment?

**EnvironmentallySustainableInve...**

20240\_Financial\_Instrument\_Environmentally\_Sustainable\_Investment\_Not\_EU\_Taxonomy\_Art\_9 Does the minimum specified in field 20210 include Non EU Taxonomy Environmental sustainable investment?

**MinimumSustainableInvestmen...**

20250\_Financial\_Instrument\_Minimum\_Sustainable\_Investment\_Social\_Objective\_Art\_9 Does the minimum specified in field 20210 include sustainable investments with social objectives.

|            |  |
|------------|--|
| properties | isRef 0<br>minOcc 0<br>maxOcc 1<br>content complex   |
| children   | <a href="#">SustainableInvestmentsArt8</a> <a href="#">MinimalProportionOfSustainableInvestmentsArt8</a><br><a href="#">SustainableInvestmentEUTaxonomyArt8</a> <a href="#">SustainableInvestmentEnvironmentalNotEUTaxonomyArt8</a><br><a href="#">SustainableInvestmentSocialObjectiveArt8</a> <a href="#">SustainableInvestmentWithEnvironmentalObjectiveArt9</a><br><a href="#">EnvironmentallySustainableInvestmentEUTaxonomyArt9</a><br><a href="#">EnvironmentallySustainableInvestmentNotEUTaxonomyArt9</a> <a href="#">MinimumSustainableInvestmentSocialObjectiveArt9</a> |
| annotation | documentation<br>20170 - 20250   |

element **EETReportType1.1.1/SpecificInformationForArt8and9/SustainableInvestmentsArt8**

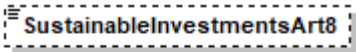
|            |  |
|------------|--|
| diagram    | <br>20170_Financial_Instrument_Sustainable_Investments_Art_8 Does the art 8 product invest in sustainable investment? |
| type       | <a href="#">EETYesNoType</a>   |
| properties | isRef 0<br>minOcc 0<br>maxOcc 1<br>content simple  |
| facets     | Kind Value annotation<br>length 1  |
| annotation | documentation<br>20170_Financial_Instrument_Sustainable_Investments_Art_8 Does the art 8 product invest in sustainable investment?   |

element

**EETReportType1.1.1/SpecificInformationForArt8and9/MinimalProportionOfSustainableInvestmentsArt8**

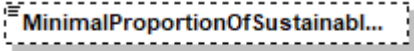
|            |  |
|------------|--|
| diagram    | <br>20180_Financial_Instrument_Products_Minimal_Proportion_Of_Sustainable_Investments_Art_8 |
| type       | <b>xs:decimal</b>  |
| properties | isRef 0<br>minOcc 0<br>maxOcc 1<br>content simple  |
| annotation | documentation<br>20180_Financial_Instrument_Products_Minimal_Proportion_Of_Sustainable_Investments_Art_8   |

element **EETReportType1.1.1/SpecificInformationForArt8and9/SustainableInvestmentEUTaxonomyArt8**

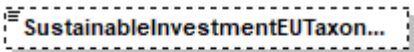
|         |   |
|---------|---|
| diagram | <br>20190_Financial_Instrument_Sustainable_Investment_EU_Taxonomy_Art_8<br>Does the minimum specified in field 20170 include EU Taxonomy sustainable investment? |
|---------|---|

|            |   |
|------------|---|
| type       | <a href="#">EETYesNoType</a>  |
| properties | isRef 0<br>minOcc 0<br>maxOcc 1<br>content simple   |
| facets     | Kind Value annotation<br>length 1   |
| annotation | documentation<br>20190_Financial_Instrument_Sustainable_Investment_EU_Taxonomy_Art_8<br>Does the minimum specified in field 20170 include EU Taxonomy sustainable investment? |

element

**EETReportType1.1.1/SpecificInformationForArt8and9/SustainableInvestmentEnvironmentalNotEUTaxonomyArt8**

|            |  |
|------------|--|
| diagram    |  <p>20200_Financial_Instrument_Sustainable_Investment_Environmental_Not_EU_Taxonomy_Art_8<br/>Does the minimum specified in field 20170 include Non EU Taxonomy Environmental sustainable investment?</p> |
| type       | <a href="#">EETYesNoType</a>   |
| properties | isRef 0<br>minOcc 0<br>maxOcc 1<br>content simple  |
| facets     | Kind Value annotation<br>length 1  |
| annotation | documentation<br>20200_Financial_Instrument_Sustainable_Investment_Environmental_Not_EU_Taxonomy_Art_8<br>Does the minimum specified in field 20170 include Non EU Taxonomy Environmental sustainable investment?  |

element

**EETReportType1.1.1/SpecificInformationForArt8and9/SustainableInvestmentSocialObjectiveArt8**

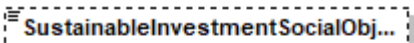
|            |   |
|------------|---|
| diagram    |  <p>20210_Financial_Instrument_Sustainable_Investment_Social_Objective_Art_8<br/>Does the minimum specified in field 20170 include include sustainable investment with social objective?</p> |
| type       | <a href="#">EETYesNoType</a>  |
| properties | isRef 0<br>minOcc 0<br>maxOcc 1<br>content simple   |
| facets     | Kind Value annotation<br>length 1   |
| annotation | documentation<br>20210_Financial_Instrument_Sustainable_Investment_Social_Objective_Art_8<br>Does the minimum specified in field 20170 include include sustainable investment with social objective?  |

element

**EETReportType1.1.1/SpecificInformationForArt8and9/SustainableInvestmentWithEnvironmentalObjecti**

**veArt9**

|            |   |
|------------|---|
| diagram    |  <b>SustainableInvestmentWithEnvi...</b><br>20220_Financial_Instrument_Minimum_Sustainable_Investment_With_Environmental_Objective_Art_9<br>For art 9 products, the minimum proportion of sustainable investments. |
| type       | <b>xs:decimal</b>   |
| properties | isRef 0<br>minOcc 0<br>maxOcc 1<br>content simple   |
| annotation | documentation<br>20220_Financial_Instrument_Minimum_Sustainable_Investment_With_Environmental_Objective_Art_9<br>For art 9 products, the minimum proportion of sustainable investments.   |

element

**EETReportType1.1.1/SpecificInformationForArt8and9/EnvironmentallySustainableInvestmentEUTaxonomyArt9**

|            |  |
|------------|--|
| diagram    |  <b>EnvironmentallySustainableInve...</b><br>20230_Financial_Instrument_Environmentally_Sustainable_Investment_EU_Taxonomy_Art_9<br>Does the minimum specified in field 20220 include EU Taxonomy Environmental sustainable investment? |
| type       | <a href="#">EETYesNoType</a>   |
| properties | isRef 0<br>minOcc 0<br>maxOcc 1<br>content simple  |
| facets     | Kind Value annotation<br>length 1  |
| annotation | documentation<br>20230_Financial_Instrument_Environmentally_Sustainable_Investment_EU_Taxonomy_Art_9<br>Does the minimum specified in field 20220 include EU Taxonomy Environmental sustainable investment?  |

element

**EETReportType1.1.1/SpecificInformationForArt8and9/EnvironmentallySustainableInvestmentNotEUTaxonomyArt9**

|            |  |
|------------|--|
| diagram    |  <b>EnvironmentallySustainableInve...</b><br>20240_Financial_Instrument_Environmentally_Sustainable_Investment_Not_EU_Taxonomy_Art_9<br>Does the minimum specified in field 20210 include Non EU Taxonomy Environmental sustainable investment? |
| type       | <a href="#">EETYesNoType</a>   |
| properties | isRef 0<br>minOcc 0<br>maxOcc 1<br>content simple  |
| facets     | Kind Value annotation<br>length 1  |

|            |   |
|------------|---|
| annotation | documentation<br>20240_Financial_Instrument_Environmentally_Sustainable_Investment_Not_EU_Taxonomy_Art_9<br>Does the minimum specified in field 20210 include Non EU Taxonomy Environmental sustainable investment? |
|------------|---|

element

**EETReportType1.1.1/SpecificInformationForArt8and9/MinimumSustainableInvestmentSocialObjectiveArt9**

|            |   |
|------------|---|
| diagram    |  <p>20250_Financial_Instrument_Minimum_Sustainable_Investment_Social_Objective_Art_9<br/>Does the minimum specified in field 20210 include sustainable investments with social objectives.</p> |
| type       | <a href="#">PercentageType</a>  |
| properties | isRef 0<br>minOcc 0<br>maxOcc 1<br>content simple   |
| annotation | documentation<br>20250_Financial_Instrument_Minimum_Sustainable_Investment_Social_Objective_Art_9<br>Does the minimum specified in field 20210 include sustainable investments with social objectives.  |



element **EETReportType1.1.1/ESGThematicInvestingDescription**

diagram

**ESGThematicInvestingDescripti...**

This part describes investment strategy, and is not linked to Taxonomy  
20260 - 20300



**ESGExistingThematicCharacteri...**

20260\_Financial\_Instrument\_ESG\_Existing\_Thematic\_Characteristics  
Does this Financial\_Instrument incorporate ESG factors through ESG thematic approach ?

**EnvironmentalThematicCharact...**

0..∞

20270\_Financial\_Instrument\_Environmental\_Thematic\_Characteristics  
Description of the product environment thematic investment strategy, according to SFDR art 2(17). Multiple answers fields.  
A - energy  
B - renewable energy  
C - raw materials  
D - water and land  
E - waste  
F - greenhouse gas emissions  
G - biodiversity  
H - circular economy  
I - environment other  
J - none

**SocialThematicCharacteristics**

0..∞

20280\_Financial\_Instrument\_Social\_Thematic\_Characteristics  
Description of the product social thematic investment strategy, according to SFDR art 2(17)  
Multiple answers fields.

A - inequality  
B - social cohesion  
C - social integration  
D - labour relations  
E - investment in human capital  
F - economically or socially disadvantaged communities  
G - social other  
H - none

**GovernanceThematicCharacteri...**

0..∞

20290\_Financial\_Instrument\_Governance\_Thematic\_Characteristics  
Description of the product thematic investment strategy, according to SFDR art 2(17)  
Multiple answers field

A - sound management structures  
B - employee relations  
C - remuneration of staff  
D - tax compliance  
E - governance other  
F - none

**AlignmentWithSustainableDevel...**

0..∞

20300\_Financial\_Instrument\_Alignment\_With\_Sustainable\_Development\_Goals  
Alignment with SDG means that SDG are used in the investment process (screening) or targeted by the fund. Multiple answers field.

A - No Poverty  
B - Zero Hunger  
C - Good Health and Well-Being  
D - Quality Education  
E - Gender Equality  
F - Clean Water and Sanitation  
G - Affordable and Clean Energy  
H - Decent Work and Economic Growth  
I - Industry, Innovation and Infrastructure  
J - Reduced Inequality  
K - Sustainable Cities and Communities  
L - Responsible Consumption and Production  
M - Climate Action  
N - Life Below Water  
O - Life on Land  
P - Peace and Justice, Strong Institutions  
Q - Partnerships to achieve to Goal  
R - None

|            |  |
|------------|--|
| properties | isRef 0<br>minOcc 0<br>maxOcc 1<br>content complex   |
| children   | <a href="#">ESGExistingThematicCharacteristics</a> <a href="#">EnvironmentalThematicCharacteristics</a> <a href="#">SocialThematicCharacteristics</a> <a href="#">GovernanceThematicCharacteristics</a> <a href="#">AlignmentWithSustainableDevelopmentGoals</a> |
| annotation | documentation<br>This part describes investment strategy, and is not linked to Taxonomy<br>20260 - 20300   |

element **EETReportType1.1.1/ESGThematicInvestingDescription/ESGExistingThematicCharacteristics**

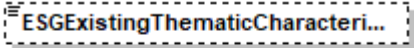
|            |  |
|------------|--|
| diagram    |  <p>20260_Financial_Instrument_ESG_Existing_Thematic_Characteristics<br/>Does this Financial_Instrument incorporate ESG factors through ESG thematic approach ?</p> |
| type       | <a href="#">EETYesNoType</a>   |
| properties | isRef 0<br>minOcc 0<br>maxOcc 1<br>content simple  |
| facets     | Kind Value annotation<br>length 1  |
| annotation | documentation<br>20260_Financial_Instrument_ESG_Existing_Thematic_Characteristics<br>Does this Financial_Instrument incorporate ESG factors through ESG thematic approach ?  |

element **EETReportType1.1.1/ESGThematicInvestingDescription/EnvironmentalThematicCharacteristics**

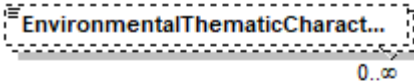
|            |  |
|------------|--|
| diagram    |  <p>20270_Financial_Instrument_Environmental_Thematic_Characteristics<br/>Description of the product environment thematic investment strategy, according to SFDR art 2(17). Multiple answers fields.<br/>A - energy<br/>B - renewable energy<br/>C - raw materials<br/>D - water and land<br/>E - waste<br/>F - greenhouse gas emissions<br/>G - biodiversity<br/>H - circular economy<br/>I - environment other<br/>J - none</p> |
| type       | restriction of <b>xs:string</b>  |
| properties | isRef 0<br>minOcc 0<br>maxOcc unbounded<br>content simple  |
| annotation | documentation<br>20270_Financial_Instrument_Environmental_Thematic_Characteristics<br>Description of the product environment thematic investment strategy, according to SFDR art 2(17). Multiple answers fields.<br>A - energy<br>B - renewable energy<br>C - raw materials  |

|  |  |
|--|--|
|  | D - water and land<br>E - waste<br>F - greenhouse gas emissions<br>G - biodiversity<br>H - circular economy<br>I - environment other<br>J - none |
|--|--|

element **EETReportType1.1.1/ESGThematicInvestingDescription/SocialThematicCharacteristics**

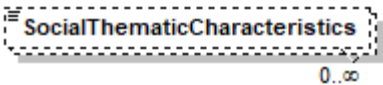
|            |  |
|------------|--|
| diagram    |  <p>0..∞</p> <p>20280_Financial_Instrument_Social_Thematic_Characteristics<br/> Description of the product social thematic investment strategy, according to SFDR art 2(17)<br/> Multiple answers fields.</p> <p>A - inequality<br/> B - social cohesion<br/> C - social integration<br/> D - labour relations<br/> E - investment in human capital<br/> F - economically or socially disadvantaged communities<br/> G - social other<br/> H - none</p> |
| type       | restriction of <b>xs:string</b>  |
| properties | isRef 0<br>minOcc 0<br>maxOcc unbounded<br>content simple  |
| annotation | documentation<br>20280_Financial_Instrument_Social_Thematic_Characteristics<br>Description of the product social thematic investment strategy, according to SFDR art 2(17)<br>Multiple answers fields. <p>A - inequality<br/> B - social cohesion<br/> C - social integration<br/> D - labour relations<br/> E - investment in human capital<br/> F - economically or socially disadvantaged communities<br/> G - social other<br/> H - none</p>   |

element **EETReportType1.1.1/ESGThematicInvestingDescription/GovernanceThematicCharacteristics**

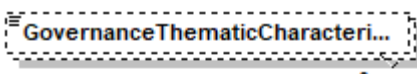
|            |  |
|------------|--|
| diagram    |  <p>0..∞</p> <p>20290_Financial_Instrument_Governance_Thematic_Characteristics<br/>Description of the product thematic investment strategy, according to SFDR art 2(17)<br/>Multiple answers field</p> <p>A - sound management structures<br/>B - employee relations<br/>C - remuneration of staff<br/>D - tax compliance<br/>E - governance other<br/>F - none</p> |
| type       | restriction of <b>xs:string</b>  |
| properties | <p>isRef 0</p> <p>minOcc 0</p> <p>maxOcc unbounded</p> <p>content simple</p>   |
| annotation | <p>documentation</p> <p>20290_Financial_Instrument_Governance_Thematic_Characteristics<br/>Description of the product thematic investment strategy, according to SFDR art 2(17)<br/>Multiple answers field</p> <p>A - sound management structures<br/>B - employee relations<br/>C - remuneration of staff<br/>D - tax compliance<br/>E - governance other<br/>F - none</p>  |

element

**EETReportType1.1.1/ESGThematicInvestingDescription/AlignmentWithSustainableDevelopmentGoals**

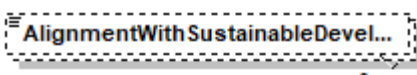
|         |  |
|---------|--|
| diagram |  <p>0..∞</p> <p>20300_Financial_Instrument_Alignment_With_Sustainable_Development_Goals<br/>Alignment with SDG means that SDG are used in the investment process (screening) or targeted by the fund. Multiple answers field.</p> <p>A - No Poverty<br/>B - Zero Hunger<br/>C - Good Health and Well-Being<br/>D - Quality Education<br/>E - Gender Equality<br/>F - Clean Water and Sanitaion<br/>G - Affordable and Clean Energy<br/>H - Decent Work and Economic Growth<br/>I - Industry, Innovation and Infrastructure<br/>J - Reduced Inequality<br/>K - Sustainable Cities and Communities<br/>L - Responsible Consumption and Production<br/>M - Climate Action<br/>N - Life Below Water<br/>O - Life on Land<br/>P - Peace and Justice, Strong Institutions<br/>Q - Partnerships to achive to Goal<br/>R - None</p> |
|---------|--|

|            |   |
|------------|---|
| type       | restriction of <b>xs:string</b>   |
| properties | isRef 0<br>minOcc 0<br>maxOcc unbounded<br>content simple   |
| annotation | documentation<br>20300_Financial_Instrument_Alignment_With_Sustainable_Development_Goals Alignment with SDG means that SDG are used in the investment process (screening) or targeted by the fund. Multiple answers field.<br>A - No Poverty<br>B - Zero Hunger<br>C - Good Health and Well-Being<br>D - Quality Education<br>E - Gender Equality<br>F - Clean Water and Sanitaion<br>G - Affordable and Clean Energy<br>H - Decent Work and Economic Growth<br>I - Industry, Innovation and Infrastructure<br>J - Reduced Inequality<br>K - Sustainable Cities and Communities<br>L - Responsible Consumption and Production<br>M - Climate Action<br>N - Life Below Water<br>O - Life on Land<br>P - Peace and Justice, Strong Institutions<br>Q - Partnerships to achive to Goal<br>R - None |

element **EETReportType1.1/ESGEngagementCoverage**

|            |  |
|------------|--|
| diagram    | <pre> classDiagram     class ESGEngagementCoverage {         20310 - 20360     }     class EligibleIssuers {         20310_Financial_Instrument_Weight_Of_Eligible_Issuers         20320_Financial_Instrument_Number_Of_Eligible_Issuers     }     class ESGCoveredIssuers {         20330_Financial_Instrument_Weight_Of_ESG_Covered_Issuers         20340_Financial_Instrument_Number_Of_ESG_Covered_Issuers     }     class EngagedIssuers {         20350_Financial_Instrument_Weight_Of_Engaged_Issuers         20360_Financial_Instrument_Number_Of_Engaged_Issuers     }     ESGEngagementCoverage -- EligibleIssuers     ESGEngagementCoverage -- ESGCoveredIssuers     ESGEngagementCoverage -- EngagedIssuers </pre> |
| properties | isRef 0<br>minOcc 0<br>maxOcc 1<br>content complex   |
| children   | <a href="#">EligibleIssuers</a> <a href="#">ESGCoveredIssuers</a> <a href="#">EngagedIssuers</a>   |
| annotation | documentation<br>20310 - 20360   |

element **EETReportType1.1.1/ESGEngagementCoverage/EligibleIssuers**

|            |   |
|------------|---|
| diagram    | <p>The diagram illustrates the structure of the <b>EligibleIssuers</b> element. It is a complex type containing two children: <b>Weight</b> and <b>Number</b>. The diagram also shows the parent type <b>EETWeightNumberType1.1</b>.</p> <p>20310_Financial_Instrument_Weight_Of_Eligible_Issuers<br/>20320_Financial_Instrument_Number_Of_Eligible_Issuers</p> |
| type       | <a href="#">EETWeightNumberType1.1</a>  |
| properties | isRef 0<br>minOcc 0<br>maxOcc 1<br>content complex  |
| children   | <a href="#">Weight</a> <a href="#">Number</a>   |
| annotation | documentation<br>20310_Financial_Instrument_Weight_Of_Eligible_Issuers<br>20320_Financial_Instrument_Number_Of_Eligible_Issuers   |

element **EETReportType1.1.1/ESGEngagementCoverage/ESGCoveredIssuers**

|            |   |
|------------|---|
| diagram    | <p>The diagram illustrates the structure of the <b>ESGCoveredIssuers</b> element. It is a complex type containing two children: <b>Weight</b> and <b>Number</b>. The diagram also shows the parent type <b>EETWeightNumberType1.1</b>.</p> <p>20330_Financial_Instrument_Weight_Of_ESG_Covered_Issuers<br/>20340_Financial_Instrument_Number_Of_ESG_Covered_Issuers</p> |
| type       | <a href="#">EETWeightNumberType1.1</a>  |
| properties | isRef 0<br>minOcc 0<br>maxOcc 1<br>content complex  |
| children   | <a href="#">Weight</a> <a href="#">Number</a>   |
| annotation | documentation<br>20330_Financial_Instrument_Weight_Of_ESG_Covered_Issuers<br>20340_Financial_Instrument_Number_Of_ESG_Covered_Issuers   |

element **EETReportType1.1/ESGEngagementCoverage/EngagedIssuers**

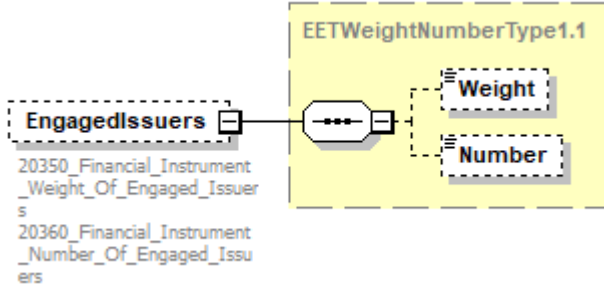
|            |   |
|------------|---|
| diagram    |  <p>The diagram illustrates the structure of the <b>EngagedIssuers</b> element. It is composed of two parts: <b>Weight</b> and <b>Number</b>, which are grouped under the type <b>EETWeightNumberType1.1</b>. The <b>EngagedIssuers</b> element is associated with the following documentation: 20350_Financial_Instrument_Weight_Of_Engaged_Issuers and 20360_Financial_Instrument_Number_Of_Engaged_Issuers.</p> |
| type       | <a href="#">EETWeightNumberType1.1</a>  |
| properties | <ul style="list-style-type: none"> <li>isRef 0</li> <li>minOcc 0</li> <li>maxOcc 1</li> <li>content complex</li> </ul>  |
| children   | <a href="#">Weight</a> <a href="#">Number</a>   |
| annotation | <p>documentation</p> <p>20350_Financial_Instrument_Weight_Of_Engaged_Issuers</p> <p>20360_Financial_Instrument_Number_Of_Engaged_Issuers</p>  |

element **EETReportType1.1/ESGBenchmark**

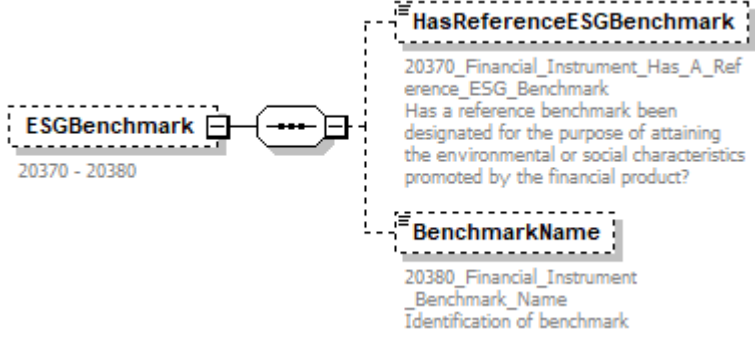
|            |   |
|------------|---|
| diagram    |  <p>The diagram shows the <b>ESGBenchmark</b> element (documentation: 20370 - 20380) connected to two child elements: <b>HasReferenceESGBenchmark</b> (documentation: 20370_Financial_Instrument_Has_A_Reference_ESG_Benchmark, description: Has a reference benchmark been designated for the purpose of attaining the environmental or social characteristics promoted by the financial product?) and <b>BenchmarkName</b> (documentation: 20380_Financial_Instrument_Benchmark_Name, description: Identification of benchmark).</p> |
| properties | <ul style="list-style-type: none"> <li>isRef 0</li> <li>minOcc 0</li> <li>maxOcc 1</li> <li>content complex</li> </ul>  |
| children   | <a href="#">HasReferenceESGBenchmark</a> <a href="#">BenchmarkName</a>  |
| annotation | <p>documentation</p> <p>20370 - 20380</p>   |

element **EETReportType1.1/ESGBenchmark/HasReferenceESGBenchmark**

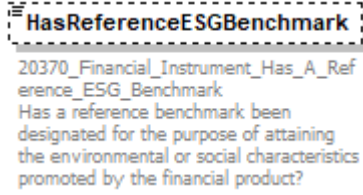
|            |   |
|------------|---|
| diagram    |  <p>The diagram shows the <b>HasReferenceESGBenchmark</b> element (documentation: 20370_Financial_Instrument_Has_A_Reference_ESG_Benchmark, description: Has a reference benchmark been designated for the purpose of attaining the environmental or social characteristics promoted by the financial product?).</p> |
| type       | <a href="#">EETYesNoType</a>  |
| properties | <ul style="list-style-type: none"> <li>isRef 0</li> <li>minOcc 0</li> </ul>   |



|            |  |
|------------|--|
|            | maxOcc 1<br>content simple   |
| facets     | Kind Value annotation<br>length 1  |
| annotation | documentation<br>20370_Financial_Instrument_Has_A_Reference_ESG_Benchmark<br>Has a reference benchmark been designated for the purpose of attaining the environmental or social characteristics promoted by the financial product? |

element **EETReportType1.1.1/ESGBenchmark/BenchmarkName**

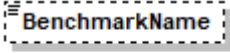
|            |   |
|------------|---|
| diagram    |  <p>20380_Financial_Instrument<br/>_Benchmark_Name<br/>Identification of benchmark</p> |
| type       | <b>xs:string</b>  |
| properties | isRef 0<br>minOcc 0<br>maxOcc 1<br>content simple   |
| annotation | documentation<br>20380_Financial_Instrument_Benchmark_Name<br>Identification of benchmark   |

element **EETReportType1.1.1/MinimumSustainableInvestments**

|                   |  |
|-------------------|--|
| <p>diagram</p>    | <p><b>Minimum Sustainable Investme...</b><br/>20390 - 20470</p> <ul style="list-style-type: none"> <li><b>MinimumAssetAllocationDate</b><br/>20390_Financial_Instrument_Minimum_Or_Planned_Asset_Allocation_Date<br/>The date to which the disclosure refer</li> <li><b>MinimumInvestmentsWithEnvir...</b><br/>20400_Financial_Instrument_EU_SFDR_Minimum_Or_Planned_Investments_With_Environmental_Or_Social_Characteristics</li> <li><b>MethodologyFor SustainableInve...</b><br/>20410_Financial_Instrument_EU_SFDR_Methodology_For_Sustainable_Investments_Calculation<br/>Revenue(R), Capex(C), Opex(O), other approach(A)</li> <li><b>MinimumInvestments Sustainable...</b><br/>20420_Financial_Instrument_EU_SFDR_Minimum_Or_Planned_Investments_Sustainable_Investments</li> <li><b>MinimumOtherInvestmentsWith...</b><br/>20430_Financial_Instrument_EU_SFDR_Minimum_Or_Planned_Other_Investments_With_Environmental_Or_Social_Characteristics</li> <li><b>MinimumInvestments Sustainable...</b><br/>20440_Financial_Instrument_EU_SFDR_Minimum_Or_Planned_Investments_Sustainable_Investments_Environmental</li> <li><b>MinimumInvestments Sustainable...</b><br/>20450_Financial_Instrument_EU_SFDR_Minimum_Or_Planned_Investments_Sustainable_Investments_Taxonomy_Aligned</li> <li><b>MinimumInvestments Sustainable...</b><br/>20460_Financial_Instrument_EU_SFDR_Minimum_Or_Planned_Investments_Sustainable_Investments_Other_Environmental</li> <li><b>MinimumInvestments Sustainable...</b><br/>20470_Financial_Instrument_EU_SFDR_Minimum_Or_Planned_Investments_Sustainable_Investments_Social</li> </ul> |
| <p>properties</p> | <p>isRef 0<br/>minOcc 0<br/>maxOcc 1<br/>content complex</p>   |
| <p>children</p>   | <p><a href="#">MinimumAssetAllocationDate</a> <a href="#">MinimumInvestmentsWithEnvironmentalOrSocialCharacteristics</a> <a href="#">MethodologyForSustainableInvestmentsCalculation</a> <a href="#">MinimumInvestmentsSustainableInvestments</a> <a href="#">MinimumOtherInvestmentsWithEnvironmentalOrSocialCharacteristics</a> <a href="#">MinimumInvestmentsSustainableInvestmentsEnvironmental</a> <a href="#">MinimumInvestmentsSustainableInvestmentsTaxonomyAligned</a> <a href="#">MinimumInvestmentsSustainableInvestmentsOtherEnvironmental</a> <a href="#">MinimumInvestmentsSustainableInvestmentsSocial</a></p>  |

|            |                                |
|------------|--------------------------------|
| annotation | documentation<br>20390 - 20470 |
|------------|--------------------------------|

element **EETReportType1.1.1/MinimumSustainableInvestments/MinimumAssetAllocationDate**

|            |   |
|------------|---|
| diagram    |  <p>20390_Financial_Instrument_Minimum_Or_Planned_Asset_Allocation_Date<br/>The date to which the disclosure refer</p> |
| type       | <b>xs:date</b>  |
| properties | isRef 0<br>content simple   |
| annotation | documentation<br>20390_Financial_Instrument_Minimum_Or_Planned_Asset_Allocation_Date<br>The date to which the disclosure refer  |

element **EETReportType1.1.1/MinimumSustainableInvestments/MinimumInvestmentsWithEnvironmentalOrSocialCharacteristics**

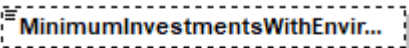
|            |   |
|------------|---|
| diagram    |  <p>20400_Financial_Instrument_EU_SFDR_Minimum_Or_Planned_Investments_With_Environmental_Or_Social_Characteristics</p> |
| type       | <a href="#">PercentageType</a>  |
| properties | isRef 0<br>minOcc 0<br>maxOcc 1<br>content simple   |
| annotation | documentation<br>20400_Financial_Instrument_EU_SFDR_Minimum_Or_Planned_Investments_With_Environmental_Or_Social_Characteristics   |

element **EETReportType1.1.1/MinimumSustainableInvestments/MethodologyForSustainableInvestmentsCalculation**

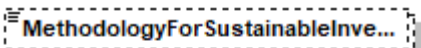
|            |  |
|------------|--|
| diagram    |  <p>20410_Financial_Instrument_EU_SFDR_Methodology_For_Sustainable_Investments_Calculation<br/>Revenue(R), Capex(C), Opex(O), other approach(A)</p> |
| type       | restriction of <b>xs:string</b>  |
| properties | isRef 0<br>minOcc 0<br>maxOcc unbounded<br>content simple  |
| annotation | documentation<br>20410_Financial_Instrument_EU_SFDR_Methodology_For_Sustainable_Investments_Calculation<br>Revenue(R), Capex(C), Opex(O), other approach(A)  |

element

**EETReportType1.1.1/MinimumSustainableInvestments/MinimumInvestmentsSustainableInvestments**

|            |  |
|------------|--|
| diagram    |  <b>MinimumInvestmentsSustainab...</b><br>20420_Financial_Instrument_EU_SFDR_Minimum_Or_Planned_Investments_Sustainable_Investments |
| type       | <a href="#">PercentageType</a>   |
| properties | isRef 0<br>minOcc 0<br>maxOcc 1<br>content simple  |
| annotation | documentation<br>20420_Financial_Instrument_EU_SFDR_Minimum_Or_Planned_Investments_Sustainable_Investments   |

element

**EETReportType1.1.1/MinimumSustainableInvestments/MinimumOtherInvestmentsWithEnvironmentalOrSocialCharacteristics**

|            |   |
|------------|---|
| diagram    |  <b>MinimumOtherInvestmentsWith...</b><br>20430_Financial_Instrument_EU_SFDR_Minimum_Or_Planned_Other_Investments_With_Environmental_Or_Social_Characteristics |
| type       | <a href="#">PercentageType</a>  |
| properties | isRef 0<br>minOcc 0<br>maxOcc 1<br>content simple   |
| annotation | documentation<br>20430_Financial_Instrument_EU_SFDR_Minimum_Or_Planned_Other_Investments_With_Environmental_Or_Social_Characteristics   |

element

**EETReportType1.1.1/MinimumSustainableInvestments/MinimumInvestmentsSustainableInvestmentsEnvironmental**

|            |  |
|------------|--|
| diagram    |  <b>MinimumInvestmentsSustainab...</b><br>20440_Financial_Instrument_EU_SFDR_Minimum_Or_Planned_Investments_Sustainable_Investments_Environmental |
| type       | <a href="#">PercentageType</a>   |
| properties | isRef 0<br>minOcc 0<br>maxOcc 1<br>content simple  |
| annotation | documentation<br>20440_Financial_Instrument_EU_SFDR_Minimum_Or_Planned_Investments_Sustainable_Investments_Environmental   |

element

### EETReportType1.1.1/MinimumSustainableInvestments/MinimumInvestmentsSustainableInvestmentsTaxonomyAligned

|            |   |
|------------|---|
| diagram    |  <b>MinimumInvestmentsSustainab...</b><br>20450_Financial_Instrument_EU_SFDR_Minimum_Or_Planned_Investments_Sustainable_Investments_Taxonomy_Aligned |
| type       | <a href="#">PercentageType</a>  |
| properties | isRef 0<br>minOcc 0<br>maxOcc 1<br>content simple   |
| annotation | documentation<br>20450_Financial_Instrument_EU_SFDR_Minimum_Or_Planned_Investments_Sustainable_Investments_Taxonomy_Aligned   |

element

### EETReportType1.1.1/MinimumSustainableInvestments/MinimumInvestmentsSustainableInvestmentsOtherEnvironmental

|            |  |
|------------|--|
| diagram    |  <b>MinimumInvestmentsSustainab...</b><br>20460_Financial_Instrument_EU_SFDR_Minimum_Or_Planned_Investments_Sustainable_Investments_Other_Environmental |
| type       | <a href="#">PercentageType</a>   |
| properties | isRef 0<br>minOcc 0<br>maxOcc 1<br>content simple  |
| annotation | documentation<br>20460_Financial_Instrument_EU_SFDR_Minimum_Or_Planned_Investments_Sustainable_Investments_Other_Environmental   |

element

### EETReportType1.1.1/MinimumSustainableInvestments/MinimumInvestmentsSustainableInvestmentsSocial

|            |   |
|------------|---|
| diagram    |  <b>MinimumInvestmentsSustainab...</b><br>20470_Financial_Instrument_EU_SFDR_Minimum_Or_Planned_Investments_Sustainable_Investments_Social |
| type       | <a href="#">PercentageType</a>  |
| properties | isRef 0<br>minOcc 0<br>maxOcc 1<br>content simple   |
| annotation | documentation<br>20470_Financial_Instrument_EU_SFDR_Minimum_Or_Planned_Investments_Sustainable_Investments_Social   |

element **EETReportType1.1.1/LastReportedSustainableInvestments**

|                   |  |
|-------------------|--|
| <p>diagram</p>    |  |
| <p>properties</p> | <p>isRef 0<br/> minOcc 0<br/> maxOcc 1<br/> content complex</p>  |
| <p>children</p>   | <p><a href="#">LastReportedAssetAllocationDate</a> <a href="#">LastReportedInvestmentsWithEnvironmentalOrSocialCharacteristics</a><br/> <a href="#">LastReportedInvestmentsNotSustainableOther</a> <a href="#">LastReportedInvestmentsSustainableInvestments</a><br/> <a href="#">LastReportedOtherInvestmentsWithEnvironmentalOrSocialCharacteristics</a><br/> <a href="#">LastReportedInvestmentsSustainableInvestmentsEnvironmental</a><br/> <a href="#">LastReportedInvestmentsSustainableInvestmentsTaxonomyAligned</a><br/> <a href="#">LastReportedInvestmentsSustainableInvestmentsOtherEnvironmental</a><br/> <a href="#">LastReportedInvestmentsSustainableInvestmentsSocial</a></p> |
| <p>annotation</p> | <p>documentation<br/> 20480 - 20560</p>  |

element **EETReportType1.1.1/LastReportedSustainableInvestments/LastReportedAssetAllocationDate**

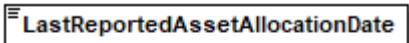
|            |  |
|------------|--|
| diagram    |  <p>20480_Financial_Instrument_Last_Reported_Asset_Allocation_Date<br/>The date to which the disclosure refer</p> |
| type       | <b>xs:date</b>   |
| properties | isRef 0<br>content simple  |
| annotation | documentation<br>20480_Financial_Instrument_Last_Reported_Asset_Allocation_Date<br>The date to which the disclosure refer  |

element

**EETReportType1.1.1/LastReportedSustainableInvestments/LastReportedInvestmentsWithEnvironmentalOrSocialCharacteristics**

|            |  |
|------------|--|
| diagram    |  <p>20490_Financial_Instrument_EU_SFDR_Last_Reported_Investments_With_Environmental_Or_Social_Characteristics</p> |
| type       | <a href="#">PercentageType</a>   |
| properties | isRef 0<br>minOcc 0<br>maxOcc 1<br>content simple  |
| annotation | documentation<br>20490_Financial_Instrument_EU_SFDR_Last_Reported_Investments_With_Environmental_Or_Social_Characteristics   |

element

**EETReportType1.1.1/LastReportedSustainableInvestments/LastReportedInvestmentsNotSustainableOther**

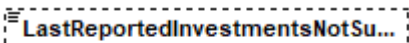
|            |   |
|------------|---|
| diagram    |  <p>20500_Financial_Instrument_EU_SFDR_Last_Reported_Investments_Not_Sustainable_Other</p> |
| type       | <a href="#">PercentageType</a>  |
| properties | isRef 0<br>minOcc 0<br>maxOcc 1<br>content simple   |
| annotation | documentation<br>20500_Financial_Instrument_EU_SFDR_Last_Reported_Investments_Not_Sustainable_Other   |

element

**EETReportType1.1.1/LastReportedSustainableInvestments/LastReportedInvestmentsSustainableInvestments**

|            |   |
|------------|---|
| diagram    |  <p>20510_Financial_Instrument_EU_SFDR_Last_Reported_Investments_Are_Sustainable_Investments</p> |
| type       | <a href="#">PercentageType</a>  |
| properties | isRef 0<br>minOcc 0<br>maxOcc 1<br>content simple   |
| annotation | documentation<br>20510_Financial_Instrument_EU_SFDR_Last_Reported_Investments_Are_Sustainable_Investments   |

element

**EETReportType1.1.1/LastReportedSustainableInvestments/LastReportedOtherInvestmentsWithEnvironmentalOrSocialCharacteristics**

|            |  |
|------------|--|
| diagram    |  <p>20520_Financial_Instrument_EU_SFDR_Last_Reported_Other_Investments_With_Environmental_Or_Social_Characteristics</p> |
| type       | <a href="#">PercentageType</a>   |
| properties | isRef 0<br>minOcc 0<br>maxOcc 1<br>content simple  |
| annotation | documentation<br>20520_Financial_Instrument_EU_SFDR_Last_Reported_Other_Investments_With_Environmental_Or_Social_Characteristics   |

element

**EETReportType1.1.1/LastReportedSustainableInvestments/LastReportedInvestmentsSustainableInvestmentsEnvironmental**

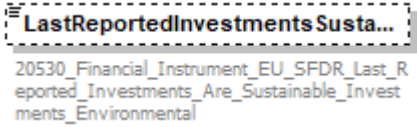
|            |   |
|------------|---|
| diagram    |  <p>20530_Financial_Instrument_EU_SFDR_Last_Reported_Investments_Are_Sustainable_Investments_Environmental</p> |
| type       | <a href="#">PercentageType</a>  |
| properties | isRef 0<br>minOcc 0<br>maxOcc 1<br>content simple   |
| annotation | documentation<br>20530_Financial_Instrument_EU_SFDR_Last_Reported_Investments_Are_Sustainable_Investments_Environmental   |



element

**EETReportType1.1.1/LastReportedSustainableInvestments/LastReportedInvestmentsSustainableInvestmentsTaxonomyAligned**

|            |  |
|------------|--|
| diagram    |  <b>LastReportedInvestments Susta...</b><br>20540_Financial_Instrument_EU_SFDR_Last_Reported_Investments_Are_Sustainable_Investments_Taxonomy_Aligned |
| type       | <a href="#">PercentageType</a>   |
| properties | isRef 0<br>minOcc 0<br>maxOcc 1<br>content simple  |
| annotation | documentation<br>20540_Financial_Instrument_EU_SFDR_Last_Reported_Investments_Are_Sustainable_Investments_Taxonomy_Aligned   |

element

**EETReportType1.1.1/LastReportedSustainableInvestments/LastReportedInvestmentsSustainableInvestmentsOtherEnvironmental**

|            |   |
|------------|---|
| diagram    |  <b>LastReportedInvestments Susta...</b><br>20550_Financial_Instrument_EU_SFDR_Last_Reported_Investments_Are_Sustainable_Investments_Other_Environmental |
| type       | <a href="#">PercentageType</a>  |
| properties | isRef 0<br>minOcc 0<br>maxOcc 1<br>content simple   |
| annotation | documentation<br>20550_Financial_Instrument_EU_SFDR_Last_Reported_Investments_Are_Sustainable_Investments_Other_Environmental   |

element

**EETReportType1.1.1/LastReportedSustainableInvestments/LastReportedInvestmentsSustainableInvestmentsSocial**

|            |  |
|------------|--|
| diagram    |  <b>LastReportedInvestments Susta...</b><br>20560_Financial_Instrument_EU_SFDR_Last_Reported_Investments_Are_Sustainable_Investments_Social |
| type       | <a href="#">PercentageType</a>   |
| properties | isRef 0<br>minOcc 0<br>maxOcc 1<br>content simple  |
| annotation | documentation<br>20560_Financial_Instrument_EU_SFDR_Last_Reported_Investments_Are_Sustainable_Investments_Social   |

element **EETReportType1.1.1/AdditionalInfoArt9**

|            |   |
|------------|---|
| diagram    |   |
| properties | isRef 0<br>minOcc 0<br>maxOcc 1<br>content complex  |
| children   | <a href="#">ObjectiveReductionInCarbonEmissions</a> <a href="#">AlignedWithParisAgreement</a> |
| annotation | documentation<br>20570 - 20580  |

element **EETReportType1.1.1/AdditionalInfoArt9/ObjectiveReductionInCarbonEmissions**

|            |   |
|------------|---|
| diagram    |   |
| type       | <a href="#">EETYesNoType</a>  |
| properties | isRef 0<br>minOcc 0<br>maxOcc 1<br>content simple   |
| facets     | Kind Value annotation<br>length 1   |
| annotation | documentation<br>20570_Financial_Instrument_With_Objective_Of_A_Reduction_In_Carbon_Emissions<br>Does the Financial Instrument have the objective of reduction in carbon emissions? |

element **EETReportType1.1.1/AdditionalInfoArt9/AlignedWithParisAgreement**

|            |   |
|------------|---|
| diagram    |   |
| type       | <a href="#">EETYesNoType</a>  |
| properties | isRef 0<br>minOcc 0<br>maxOcc 1<br>content simple   |
| facets     | Kind Value annotation<br>length 1   |
| annotation | documentation<br>20580_Financial_Instrument_Aligned_With_Paris_Agreement<br>Is the Financial Instrument Aligned with the Paris Agreement? |

element **EETReportType1.1.1/MiFIDIDDTargetMarket**

|            |   |
|------------|---|
| diagram    | <p>20590</p> <p>MIFID: COMMISSION DELEGATED REGULATION (EU) 2021/1253 Art. 1<br/>IDD: COMMISSION DELEGATED DIRECTIVE (EU) 2021/1257 Art. 2</p> <p>answer = Yes or Neutral</p> |
| properties | isRef 0<br>content complex  |
| children   | <a href="#">EndClientSustainabilityPreferences_Considered</a>   |
| annotation | documentation<br>20590  |

element **EETReportType1.1.1/MiFIDIDDTargetMarket/EndClientSustainabilityPreferences\_Considered**

| diagram    | <p>MIFID: COMMISSION DELEGATED REGULATION (EU) 2021/1253 Art. 1<br/>IDD: COMMISSION DELEGATED DIRECTIVE (EU) 2021/1257 Art. 2</p> <p>answer = Yes or Neutral</p>  |            |       |            |           |   |  |           |   |  |
|------------|---|------------|-------|------------|-----------|---|--|-----------|---|--|
| type       | <a href="#">EETYesNeutralType</a>   |            |       |            |           |   |  |           |   |  |
| properties | isRef 0<br>content simple   |            |       |            |           |   |  |           |   |  |
| facets     | <table border="1"> <thead> <tr> <th>Kind</th> <th>Value</th> <th>annotation</th> </tr> </thead> <tbody> <tr> <td>minLength</td> <td>1</td> <td></td> </tr> <tr> <td>maxLength</td> <td>7</td> <td></td> </tr> </tbody> </table> | Kind       | Value | annotation | minLength | 1 |  | maxLength | 7 |  |
| Kind       | Value   | annotation |       |            |           |   |  |           |   |  |
| minLength  | 1   |            |       |            |           |   |  |           |   |  |
| maxLength  | 7   |            |       |            |           |   |  |           |   |  |
| annotation | documentation<br>MIFID: COMMISSION DELEGATED REGULATION (EU) 2021/1253 Art. 1<br>IDD: COMMISSION DELEGATED DIRECTIVE (EU) 2021/1257 Art. 2  |            |       |            |           |   |  |           |   |  |
|            | answer = Yes or Neutral   |            |       |            |           |   |  |           |   |  |

element **EETReportType1.1/TaxonomyAlignedInvestments**

diagram



- MinimumInvestmentsEUTaxono...**  
 20600\_Financial\_Instrument\_Minimum\_Percentage\_Investments\_Aligned\_EU\_Taxonomy\_Incl\_Sovereign\_Bonds
- MinimumInvestmentsEUTaxono...**  
 20610\_Financial\_Instrument\_Minimum\_Percentage\_Investments\_Aligned\_EU\_Taxonomy\_Excl\_Sovereign\_Bonds
- SubjectToExternalReviewByThir...**  
 20620\_Financial\_Instrument\_Was\_This\_Statement\_Subject\_To\_An\_External\_Review\_By\_Third\_Party
- MethodologyUsedForAlignment...**  
 20630\_Financial\_Instrument\_Methodology\_Used\_For\_Alignment\_Calculation\_With\_EU\_Taxonomy  
 Discloses the methodology used for alignment calculation with the EU Taxonomy, defined as either Revenue (R), CapEx (C) or OpEx (O)
- MinimumShareOfTransitionalAc...**  
 20640\_Financial\_Instrument\_Minimum\_Share\_Of\_Transitional\_Activities
- MinimumShareOfEnablingActivit...**  
 20650\_Financial\_Instrument\_Minimum\_Share\_Of\_Enabling\_Activities
- TaxonomyAlignedInclSovereign...**  
 20660\_Financial\_Instrument\_Percentage\_Taxonomy\_Aligned\_Incl\_Sovereign\_Revenue
- TaxonomyAlignedInclSovereign...**  
 20670\_Financial\_Instrument\_Percentage\_Taxonomy\_Aligned\_Incl\_Sovereign\_Capex
- TaxonomyAlignedInclSovereign...**  
 20680\_Financial\_Instrument\_Percentage\_Taxonomy\_Aligned\_Incl\_Sovereign\_Opex
- TaxonomyAlignedExclSovereign...**  
 20690\_Financial\_Instrument\_Percentage\_Taxonomy\_Aligned\_Excl\_Sovereign\_Revenue
- TaxonomyAlignedExclSovereign...**  
 20700\_Financial\_Instrument\_Percentage\_Taxonomy\_Aligned\_Excl\_Sovereign\_Capex
- TaxonomyAlignedExclSovereign...**  
 20710\_Financial\_Instrument\_Percentage\_Taxonomy\_Aligned\_Excl\_Sovereign\_Opex
- ClimateChangeMitigationPercen...**  
 20721\_Financial\_Instrument\_Climate\_Change\_Mitigation\_Percentage
- ClimateChangeAdaptationPerce...**  
 20731\_Financial\_Instrument\_Climate\_Change\_Adaptation\_Percentage
- SustainableUseAndProtectionOf...**  
 20741\_Financial\_Instrument\_Sustainable\_Use\_And\_Protection\_Of\_Water\_And\_Marine\_Resources\_Percentage
- TransitionToCircularEconomyPe...**  
 20751\_Financial\_Instrument\_Transition\_To\_A\_Circular\_Economy\_Percentage
- PollutionPreventionAndControl...**  
 20761\_Financial\_Instrument\_Pollution\_Prevention\_And\_Control\_Percentage
- ProtectionAndRestorationOfBio...**  
 20771\_Financial\_Instrument\_Protection\_And\_Restoration\_Of\_Biodiversity\_And\_Ecosystems\_Percentage
- ShareOfTransitionalActivities**  
 20780\_Financial\_Instrument\_Share\_Of\_Transitional\_Activities
- ShareOfEnablingActivities**  
 20790\_Financial\_Instrument\_Share\_Of\_Enabling\_Activities

|            |   |
|------------|---|
| properties | isRef 0<br>minOcc 0<br>maxOcc 1<br>content complex  |
| children   | <a href="#">MinimumInvestmentsEUTaxonomy_InclSovereignBonds</a> <a href="#">MinimumInvestmentsEUTaxonomy_ExclSovereignBonds</a> <a href="#">SubjectToExternalReviewByThirdParty_MethodologyUsedForAlignmentCalculationWith_EU_Taxonomy_MinimumShareOfTransitionalActivities_MinimumShareOfEnablingActivities</a> <a href="#">TaxonomyAlignedInclSovereignRevenue</a> <a href="#">TaxonomyAlignedInclSovereignCapex</a> <a href="#">TaxonomyAlignedInclSovereignOpex</a> <a href="#">TaxonomyAlignedExclSovereignRevenue</a> <a href="#">TaxonomyAlignedExclSovereignCapex</a> <a href="#">TaxonomyAlignedExclSovereignOpex</a> <a href="#">ClimateChangeMitigationPercentage</a> <a href="#">ClimateChangeAdaptationPercentage</a> <a href="#">SustainableUseAndProtectionOfWaterAndMarineResourcesPercentage</a> <a href="#">TransitionToCircularEconomyPercentage</a> <a href="#">PollutionPreventionAndControlPercentage</a> <a href="#">ProtectionAndRestorationOfBiodiversityAndEcosystemsPercentage</a> <a href="#">ShareOfTransitionalActivities</a> <a href="#">ShareOfEnablingActivities</a> |
| annotation | documentation<br>20600 - 20790  |

element

**EETReportType1.1.1/TaxonomyAlignedInvestments/MinimumInvestmentsEUTaxonomy\_InclSovereign Bonds**

|            |  |
|------------|--|
| diagram    |  <b>MinimumInvestmentsEUTaxono...</b><br>20600_Financial_Instrument_Minimum_Percentage_Investments_Aligned_EU_Taxonomy_Incl_Sovereign_Bonds |
| type       | <b>xs:decimal</b>  |
| properties | isRef 0<br>minOcc 0<br>maxOcc 1<br>content simple  |
| annotation | documentation<br>20600_Financial_Instrument_Minimum_Percentage_Investments_Aligned_EU_Taxonomy_Incl_Sovereign_Bonds  |

element

**EETReportType1.1.1/TaxonomyAlignedInvestments/MinimumInvestmentsEUTaxonomy\_ExclSovereign Bonds**

|            |  |
|------------|--|
| diagram    |  <b>MinimumInvestmentsEUTaxono...</b><br>20610_Financial_Instrument_Minimum_Percentage_Investments_Aligned_EU_Taxonomy_Excl_Sovereign_Bonds |
| type       | <b>xs:decimal</b>  |
| properties | isRef 0<br>minOcc 0<br>maxOcc 1<br>content simple  |
| annotation | documentation<br>20610_Financial_Instrument_Minimum_Percentage_Investments_Aligned_EU_Taxonomy_Excl_Sovereign_Bonds  |

element **EETReportType1.1.1/TaxonomyAlignedInvestments/SubjectToExternalReviewByThirdParty**

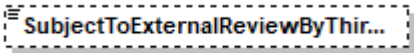
|            |   |
|------------|---|
| diagram    |  <p>20620_Financial_Instrument_Was_This_Statement_Subject_To_An_External_Review_By_Third_Party</p> |
| type       | <b>EETYesNoType</b>   |
| properties | isRef 0<br>minOcc 0<br>maxOcc 1<br>content simple   |
| facets     | Kind Value annotation<br>length 1   |
| annotation | documentation<br>20620_Financial_Instrument_Was_This_Statement_Subject_To_An_External_Review_By_Third_Party   |

element **EETReportType1.1.1/TaxonomyAlignedInvestments/MethodologyUsedForAlignmentCalculationWith\_EU\_Taxonomy**

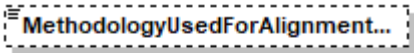
|            |  |
|------------|--|
| diagram    |  <p>20630_Financial_Instrument_Methodology_Used_For_Alignment_Calculation_With_EU_Taxonomy<br/>         Discloses the methodology used for alignment calculation with the EU Taxonomy, defined as either Revenue (R), CapEx (C) or OpEx (O)</p> |
| type       | restriction of <b>xs:string</b>  |
| properties | isRef 0<br>minOcc 0<br>maxOcc 1<br>content simple  |
| annotation | documentation<br>20630_Financial_Instrument_Methodology_Used_For_Alignment_Calculation_With_EU_Taxonomy<br>Discloses the methodology used for alignment calculation with the EU Taxonomy, defined as either Revenue (R), CapEx (C) or OpEx (O)   |

element **EETReportType1.1.1/TaxonomyAlignedInvestments/MinimumShareOfTransitionalActivities**

|            |  |
|------------|--|
| diagram    |  <p>20640_Financial_Instrument_Minimum_Share_Of_Transitional_Activities</p> |
| type       | <b>xs:decimal</b>  |
| properties | isRef 0<br>minOcc 0<br>maxOcc 1<br>content simple  |
| annotation | documentation<br>20640_Financial_Instrument_Minimum_Share_Of_Transitional_Activities   |

element **EETReportType1.1.1/TaxonomyAlignedInvestments/MinimumShareOfEnablingActivities**

|            |   |
|------------|---|
| diagram    |  <b>Minimum ShareOfEnablingActivit...</b><br>20650_Financial_Instrument_Minimum_Share_Of_Enabling_Activities |
| type       | <b>xs:decimal</b>   |
| properties | isRef 0<br>minOcc 0<br>maxOcc 1<br>content simple   |
| annotation | documentation<br>20650_Financial_Instrument_Minimum_Share_Of_Enabling_Activities  |

element **EETReportType1.1.1/TaxonomyAlignedInvestments/TaxonomyAlignedInclSovereignRevenue**

|            |   |
|------------|---|
| diagram    |  <b>TaxonomyAlignedInclSovereign...</b><br>20660_Financial_Instrument_Percentage_Taxonomy_Aligned_Incl_Sovereign_Revenue |
| type       | <b>xs:decimal</b>   |
| properties | isRef 0<br>minOcc 0<br>maxOcc 1<br>content simple   |
| annotation | documentation<br>20660_Financial_Instrument_Percentage_Taxonomy_Aligned_Incl_Sovereign_Revenue  |

element **EETReportType1.1.1/TaxonomyAlignedInvestments/TaxonomyAlignedInclSovereignCapex**

|            |   |
|------------|---|
| diagram    |  <b>TaxonomyAlignedInclSovereign...</b><br>20670_Financial_Instrument_Percentage_Taxonomy_Aligned_Incl_Sovereign_Capex |
| type       | <b>xs:decimal</b>   |
| properties | isRef 0<br>minOcc 0<br>maxOcc 1<br>content simple   |
| annotation | documentation<br>20670_Financial_Instrument_Percentage_Taxonomy_Aligned_Incl_Sovereign_Capex  |

element **EETReportType1.1.1/TaxonomyAlignedInvestments/TaxonomyAlignedInclSovereignOpex**

|            |  |
|------------|--|
| diagram    |  <b>TaxonomyAlignedInclSovereign...</b><br>20680_Financial_Instrument_Percentage_Taxonomy_Aligned_Incl_Sovereign_Opex |
| type       | <b>xs:decimal</b>  |
| properties | isRef 0<br>minOcc 0<br>maxOcc 1<br>content simple  |
| annotation | documentation<br>20680_Financial_Instrument_Percentage_Taxonomy_Aligned_Incl_Sovereign_Opex  |

element **EETReportType1.1.1/TaxonomyAlignedInvestments/TaxonomyAlignedExclSovereignRevenue**

|            |  |
|------------|--|
| diagram    |  |
| type       | <b>xs:decimal</b>  |
| properties | isRef 0<br>minOcc 0<br>maxOcc 1<br>content simple  |
| annotation | documentation<br>20690_Financial_Instrument_Percentage_Taxonomy_Aligned_Excl_Sovereign_Revenue |

element **EETReportType1.1.1/TaxonomyAlignedInvestments/TaxonomyAlignedExclSovereignCapex**

|            |  |
|------------|--|
| diagram    |  |
| type       | <b>xs:decimal</b>  |
| properties | isRef 0<br>minOcc 0<br>maxOcc 1<br>content simple  |
| annotation | documentation<br>20700_Financial_Instrument_Percentage_Taxonomy_Aligned_Excl_Sovereign_Capex |

element **EETReportType1.1.1/TaxonomyAlignedInvestments/TaxonomyAlignedExclSovereignOpex**

|            |   |
|------------|---|
| diagram    |   |
| type       | <b>xs:decimal</b>   |
| properties | isRef 0<br>minOcc 0<br>maxOcc 1<br>content simple   |
| annotation | documentation<br>20710_Financial_Instrument_Percentage_Taxonomy_Aligned_Excl_Sovereign_Opex |

element **EETReportType1.1.1/TaxonomyAlignedInvestments/ClimateChangeMitigationPercentage**

|            |   |
|------------|---|
| diagram    |   |
| type       | <b>xs:decimal</b>                                 |
| properties | isRef 0<br>minOcc 0<br>maxOcc 1<br>content simple |



|            |  |
|------------|--|
| annotation | documentation<br>20721_Financial_Instrument_Climate_Change_Mitigation_Percentage |
|------------|--|

element **EETReportType1.1.1/TaxonomyAlignedInvestments/ClimateChangeAdaptationPercentage**

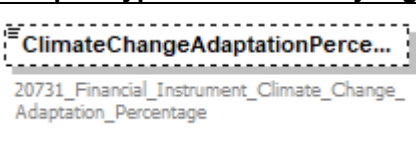
|            |   |
|------------|---|
| diagram    |  |
| type       | <b>xs:decimal</b>   |
| properties | isRef 0<br>minOcc 0<br>maxOcc 1<br>content simple                                 |
| annotation | documentation<br>20731_Financial_Instrument_Climate_Change_Adaptation_Percentage  |

element **EETReportType1.1.1/TaxonomyAlignedInvestments/SustainableUseAndProtectionOfWaterAndMarineResourcesPercentage**

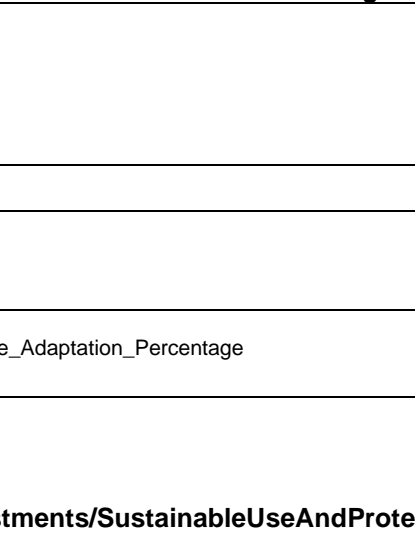
|            |   |
|------------|---|
| diagram    |                                   |
| type       | <b>xs:decimal</b>   |
| properties | isRef 0<br>minOcc 0<br>maxOcc 1<br>content simple   |
| annotation | documentation<br>20741_Financial_Instrument_Sustainable_Use_And_Protection_Of_Water_And_Marine_Resources_Percentage |

element **EETReportType1.1.1/TaxonomyAlignedInvestments/TransitionToCircularEconomyPercentage**

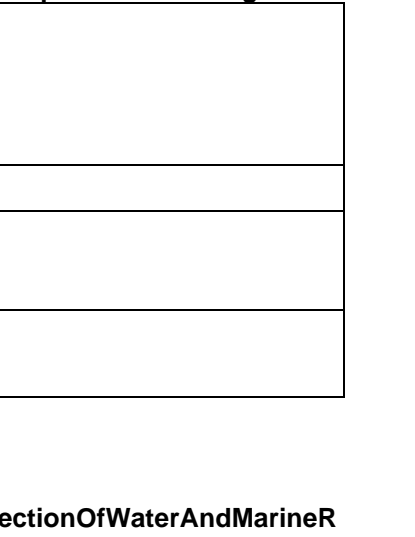
|            |   |
|------------|---|
| diagram    |      |
| type       | <b>xs:decimal</b>   |
| properties | isRef 0<br>minOcc 0<br>maxOcc 1<br>content simple                                       |
| annotation | documentation<br>20751_Financial_Instrument_Transition_To_A_Circular_Economy_Percentage |

element **EETReportType1.1.1/TaxonomyAlignedInvestments/PollutionPreventionAndControlPercentage**

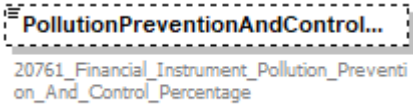
|            |   |
|------------|---|
| diagram    |        |
| type       | <b>xs:decimal</b>   |
| properties | isRef 0<br>minOcc 0<br>maxOcc 1<br>content simple                                       |
| annotation | documentation<br>20761_Financial_Instrument_Pollution_Prevention_And_Control_Percentage |

element

**EETReportType1.1.1/TaxonomyAlignedInvestments/ProtectionAndRestorationOfBiodiversityAndEcosystemsPercentage**

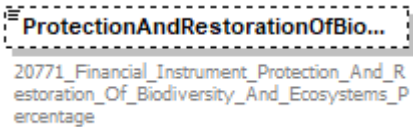
|            |  |
|------------|--|
| diagram    |                                 |
| type       | <b>xs:decimal</b>  |
| properties | isRef 0<br>minOcc 0<br>maxOcc 1<br>content simple  |
| annotation | documentation<br>20771_Financial_Instrument_Protection_And_Restoration_Of_Biodiversity_And_Ecosystems_Percentage |

element **EETReportType1.1.1/TaxonomyAlignedInvestments/ShareOfTransitionalActivities**

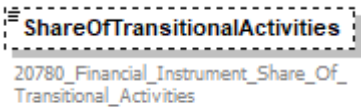
|            |   |
|------------|---|
| diagram    |  |
| type       | <b>xs:decimal</b>   |
| properties | isRef 0<br>minOcc 0<br>maxOcc 1<br>content simple                                   |
| annotation | documentation<br>20780_Financial_Instrument_Share_Of_Transitional_Activities        |

element **EETReportType1.1.1/TaxonomyAlignedInvestments/ShareOfEnablingActivities**

|            |   |
|------------|---|
| diagram    | <p><b>ShareOfEnablingActivities</b><br/>20790_Financial_Instrument_Share_Of_Enabling_Activities</p> |
| type       | <b>xs:decimal</b>   |
| properties | isRef 0<br>minOcc 0<br>maxOcc 1<br>content simple   |
| annotation | documentation<br>20790_Financial_Instrument_Share_Of_Enabling_Activities                            |

element **EETReportType1.1.1/PrincipalAdverseIndicators**

|            |   |
|------------|---|
| diagram    | <p><b>PrincipalAdverseIndicators</b><br/>30000 - 33440</p> <ul style="list-style-type: none"> <li><b>PAI</b><br/>30000 this field is no more used dont fill in</li> <li><b>PAIReferencDate</b><br/>30010_PAI_Reference_Date<br/>Date to which data refer</li> <li><b>ClimateAndEnvironmentRelate...</b><br/>30020 - 30970</li> <li><b>SocialAndEmployeeMatters</b><br/>30980 - 31160</li> <li><b>SovereignAndSupranationalInv...</b><br/>31170 - 31280</li> <li><b>RealEstateInvestments</b><br/>31290 - 31360</li> <li><b>MoreClimateAndEnvironmentR...</b><br/>31370 - 32430</li> <li><b>More SocialAndEmployeeMatters</b><br/>32440 - 33440</li> </ul> |
| properties | isRef 0<br>minOcc 0<br>maxOcc 1<br>content complex  |
| children   | <a href="#">PAI</a> <a href="#">PAIReferencDate</a> <a href="#">ClimateAndEnvironmentRelatedIndicators</a> <a href="#">SocialAndEmployeeMatters</a><br><a href="#">SovereignAndSupranationalInvestments</a> <a href="#">RealEstateInvestments</a> <a href="#">MoreClimateAndEnvironmentRelatedIndicators</a><br><a href="#">MoreSocialAndEmployeeMatters</a>  |
| annotation | documentation<br>30000 - 33440  |

element **EETReportType1.1.1/PrincipalAdverseIndicators/PAI**

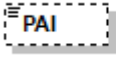
|            |   |
|------------|---|
| diagram    |  <p>30000_ this field is no more used dont fill in</p> |
| type       | <b>xs:date</b>  |
| properties | isRef 0<br>minOcc 0<br>maxOcc 1<br>content simple   |
| annotation | documentation<br>30000_ this field is no more used dont fill in   |

element **EETReportType1.1.1/PrincipalAdverseIndicators/PAIReferencDate**

|            |  |
|------------|--|
| diagram    |  <p>30010_PAI_Reference_Date<br/>Date to which data refer</p> |
| type       | <b>xs:date</b>   |
| properties | isRef 0<br>content simple  |
| annotation | documentation<br>30010_PAI_Reference_Date<br>Date to which data refer  |

element **EETReportType1.1.1/PrincipalAdverseIndicators/ClimateAndEnvironmentRelatedIndicators**

|                   |  |
|-------------------|--|
| <p>diagram</p>    |  |
| <p>properties</p> | <p>isRef 0<br/>minOcc 0<br/>maxOcc 1<br/>content complex</p>   |
| <p>children</p>   | <p><a href="#">GreenhousegasEmissions</a> <a href="#">CarbonFootprintScope12</a> <a href="#">CarbonFootprintScope123</a><br/><a href="#">GHG_IntensityOfInvesteeCompaniesScope12</a> <a href="#">GHG_IntensityOfInvesteeCompaniesScope123</a><br/><a href="#">ExposureToCompaniesActiveInTheFossilFuelSector</a> <a href="#">EnergyConsumptionFromNonRenewableSources</a><br/><a href="#">EnergyProductionFromNonRenewableSources</a> <a href="#">EnergyConsumptionIntensityPerHighImpactClimateSector</a><br/><a href="#">ActivitiesNegativelyAffectingBiodiversitySensitiveAreas</a> <a href="#">WaterEmissions</a> <a href="#">HazardousWaste</a></p> |
| <p>annotation</p> | <p>documentation<br/>30020 - 30970</p>   |

element

**EETReportType1.1.1/PrincipalAdverseIndicators/ClimateAndEnvironmentRelatedIndicators/GreenhousegasEmissions**

|            |  |
|------------|--|
| diagram    |  |
| properties | <p>isRef 0<br/> minOcc 0<br/> maxOcc 1<br/> content complex</p>  |
| children   | <p><a href="#">Scope1</a> <a href="#">Scope2</a> <a href="#">Scope3</a> <a href="#">TotalScope12</a> <a href="#">TotalScope123</a></p> |
| annotation | <p>documentation<br/> 30020 - 30210</p>  |

element

**EETReportType1.1.1/PrincipalAdverseIndicators/ClimateAndEnvironmentRelatedIndicators/GreenhousegasEmissions/Scope1**

|            |   |
|------------|---|
| diagram    |   |
| type       | <p><a href="#">ValueStrategyCoverageType1.1</a></p>             |
| properties | <p>isRef 0<br/> minOcc 0<br/> maxOcc 1<br/> content complex</p> |

|            |  |
|------------|--|
| children   | <a href="#">Value</a> <a href="#">ConsideredInInvestmentStrategy</a> <a href="#">Coverage</a> <a href="#">EligibleAssets</a> |
| annotation | documentation<br>30020 - 30050   |

element

**EETReportType1.1.1/PrincipalAdverseIndicators/ClimateAndEnvironmentRelatedIndicators/GreenhouseGasEmissions/Scope2**

|            |  |
|------------|--|
| diagram    | <p>The diagram illustrates the structure of the <b>ValueStrategyCoverageType1.1</b> element. It is a container (yellow dashed box) that includes four sub-elements:</p> <ul style="list-style-type: none"> <li><b>Value</b>: A simple text field.</li> <li><b>ConsideredInInvestmentStrategy</b>: A text field with a description: "Yes (= commitment of the asset manager to improve the PAI), No".</li> <li><b>Coverage</b>: A text field with a description: "% of the notional / AUM, which provide effectively data, or where data could be estimated".</li> <li><b>EligibleAssets</b>: A text field with a description: "% of assets (versus notional / AUM), which could provide data".</li> </ul> <p>On the left, a <b>Scope2</b> element (code range 30060 - 30090) is connected to the main container via a relationship line.</p> |
| type       | <a href="#">ValueStrategyCoverageType1.1</a>   |
| properties | <ul style="list-style-type: none"> <li>isRef 0</li> <li>minOcc 0</li> <li>maxOcc 1</li> <li>content complex</li> </ul>   |
| children   | <a href="#">Value</a> <a href="#">ConsideredInInvestmentStrategy</a> <a href="#">Coverage</a> <a href="#">EligibleAssets</a>   |
| annotation | documentation<br>30060 - 30090   |

element

### EETReportType1.1.1/PrincipalAdverseIndicators/ClimateAndEnvironmentRelatedIndicators/GreenhouseGasEmissions/Scope3

|            |  |
|------------|--|
| diagram    | <p>The diagram illustrates the structure of 'Value Strategy Coverage Type 1.1' for 'Scope3' (30100 - 30130). The central box contains four sub-elements:</p> <ul style="list-style-type: none"><li><b>Value</b>: A dashed box representing the numerical value.</li><li><b>ConsideredInInvestmentStrategy</b>: A solid box with the text: "Yes (= commitment of the asset manager to improve the PAI), No".</li><li><b>Coverage</b>: A dashed box with the text: "% of the notional / AUM, which provide effectively data, or where data could be estimated".</li><li><b>EligibleAssets</b>: A dashed box with the text: "% of assets (versus notional / AUM), which could provide data".</li></ul> <p>'Scope3' (30100 - 30130) is connected to the central box via a dashed line.</p> |
| type       | <a href="#">ValueStrategyCoverageType1.1</a>   |
| properties | isRef 0<br>minOcc 0<br>maxOcc 1<br>content complex   |
| children   | <a href="#">Value</a> <a href="#">ConsideredInInvestmentStrategy</a> <a href="#">Coverage</a> <a href="#">EligibleAssets</a>   |
| annotation | documentation<br>30100 - 30130   |

element

### EETReportType1.1.1/PrincipalAdverseIndicators/ClimateAndEnvironmentRelatedIndicators/GreenhouseGasEmissions/TotalScope12

|         |  |
|---------|--|
| diagram | <p>The diagram illustrates the structure of 'Value Strategy Coverage Type 1.1' for 'TotalScope12' (30140 - 30170). The central box contains four sub-elements:</p> <ul style="list-style-type: none"><li><b>Value</b>: A dashed box representing the numerical value.</li><li><b>ConsideredInInvestmentStrategy</b>: A solid box with the text: "Yes (= commitment of the asset manager to improve the PAI), No".</li><li><b>Coverage</b>: A dashed box with the text: "% of the notional / AUM, which provide effectively data, or where data could be estimated".</li><li><b>EligibleAssets</b>: A dashed box with the text: "% of assets (versus notional / AUM), which could provide data".</li></ul> <p>'TotalScope12' (30140 - 30170) is connected to the central box via a dashed line.</p> |
|---------|--|



|            |  |
|------------|--|
| type       | <a href="#">ValueStrategyCoverageType1.1</a>   |
| properties | isRef 0<br>minOcc 0<br>maxOcc 1<br>content complex   |
| children   | <a href="#">Value</a> <a href="#">ConsideredInInvestmentStrategy</a> <a href="#">Coverage</a> <a href="#">EligibleAssets</a> |
| annotation | documentation<br>30140 - 30170   |

element

**EETReportType1.1.1/PrincipalAdverseIndicators/ClimateAndEnvironmentRelatedIndicators/GreenhouseGasEmissions/TotalScope123**

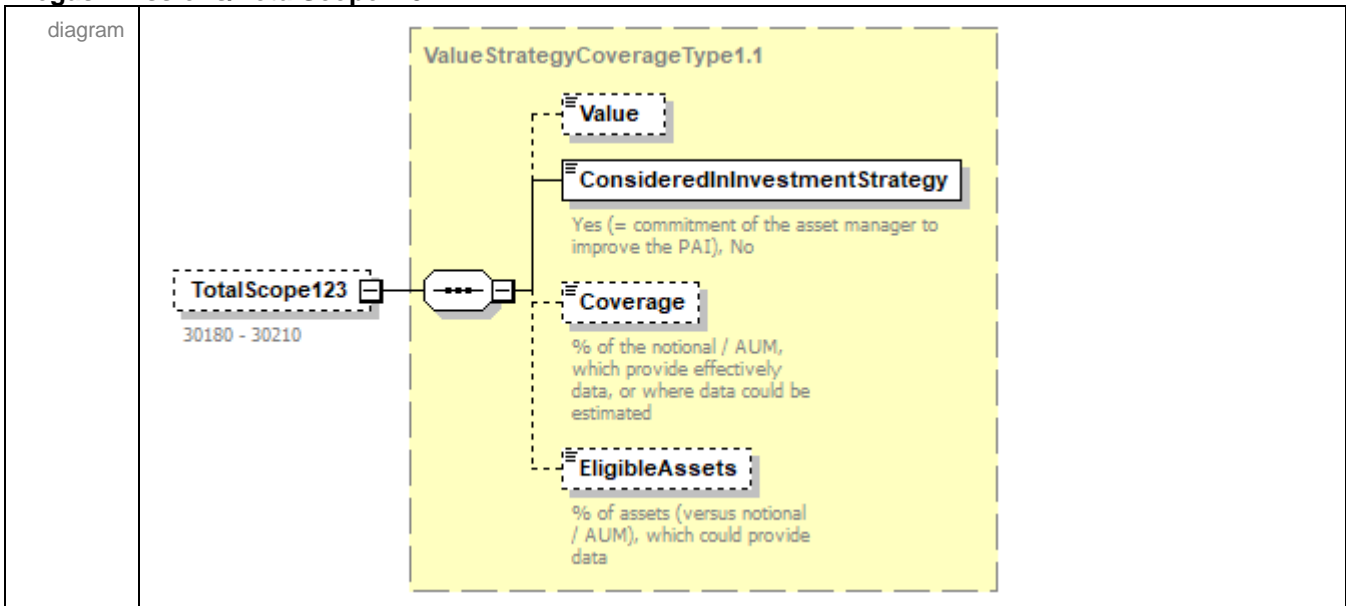

|            |  |
|------------|--|
| type       | <a href="#">ValueStrategyCoverageType1.1</a>   |
| properties | isRef 0<br>minOcc 0<br>maxOcc 1<br>content complex   |
| children   | <a href="#">Value</a> <a href="#">ConsideredInInvestmentStrategy</a> <a href="#">Coverage</a> <a href="#">EligibleAssets</a> |
| annotation | documentation<br>30180 - 30210   |

element

**EETReportType1.1.1/PrincipalAdverseIndicators/ClimateAndEnvironmentRelatedIndicators/CarbonFootprintScope12**

|            |  |
|------------|--|
| diagram    |  |
| type       | <a href="#">ValueStrategyCoverageType1.1</a>   |
| properties | isRef 0<br>minOcc 0<br>maxOcc 1<br>content complex   |
| children   | <a href="#">Value</a> <a href="#">ConsideredInInvestmentStrategy</a> <a href="#">Coverage</a> <a href="#">EligibleAssets</a> |
| annotation | documentation<br>30220 - 30250   |

element

**EETReportType1.1.1/PrincipalAdverseIndicators/ClimateAndEnvironmentRelatedIndicators/CarbonFootprintScope123**

|         |  |
|---------|--|
| diagram |  |
|---------|--|

|            |  |
|------------|--|
| type       | <a href="#">ValueStrategyCoverageType1.1</a>   |
| properties | isRef 0<br>minOcc 0<br>maxOcc 1<br>content complex   |
| children   | <a href="#">Value</a> <a href="#">ConsideredInInvestmentStrategy</a> <a href="#">Coverage</a> <a href="#">EligibleAssets</a> |
| annotation | documentation<br>30260 - 30290   |

element

**EETReportType1.1.1/PrincipalAdverseIndicators/ClimateAndEnvironmentRelatedIndicators/GHG\_IntensityOfInvesteeCompaniesScope12**

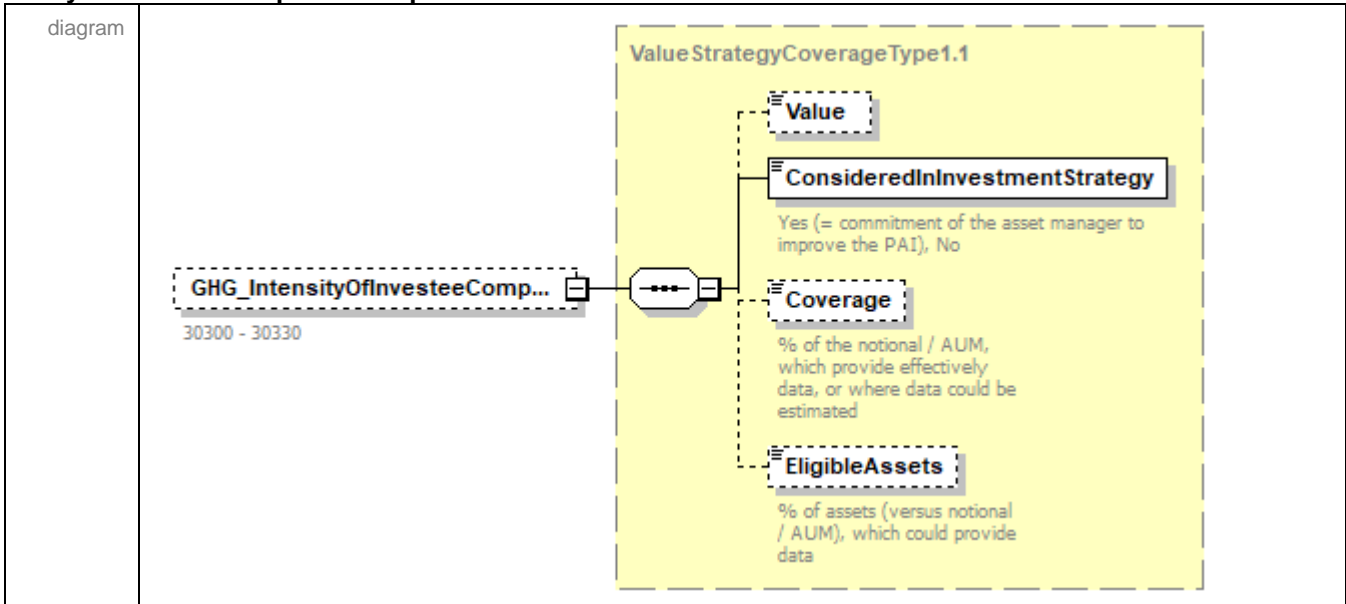

|            |  |
|------------|--|
| type       | <a href="#">ValueStrategyCoverageType1.1</a>   |
| properties | isRef 0<br>minOcc 0<br>maxOcc 1<br>content complex   |
| children   | <a href="#">Value</a> <a href="#">ConsideredInInvestmentStrategy</a> <a href="#">Coverage</a> <a href="#">EligibleAssets</a> |
| annotation | documentation<br>30300 - 30330   |

element

### EETReportType1.1.1/PrincipalAdverseIndicators/ClimateAndEnvironmentRelatedIndicators/GHG\_IntensityOfInvesteeCompaniesScope123

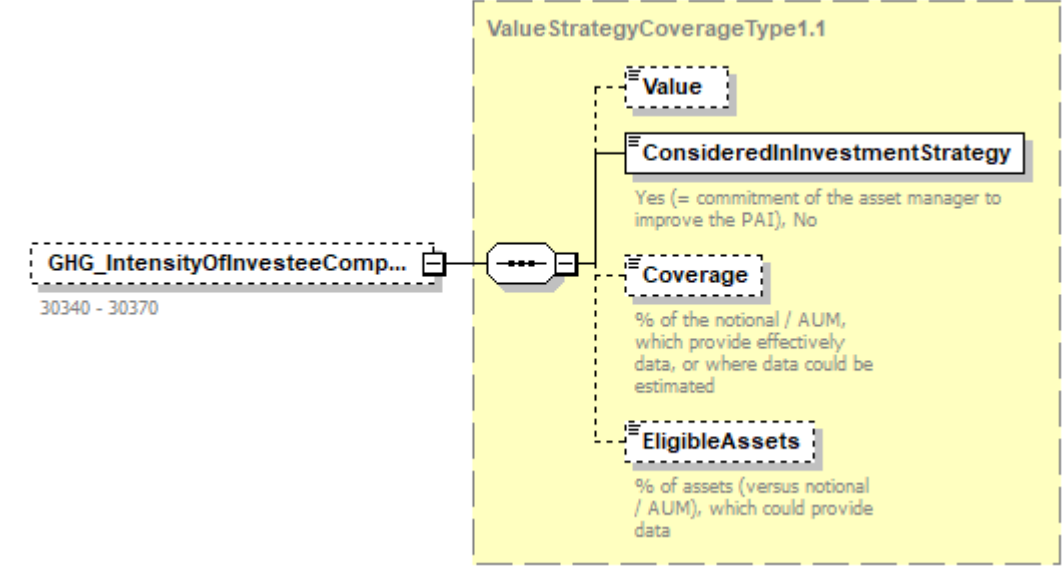
|            |  |
|------------|--|
| diagram    |  <p>The diagram shows a dashed box labeled "ValueStrategyCoverageType1.1" containing three sub-elements: "Value", "ConsideredInInvestmentStrategy", and "EligibleAssets". A separate dashed box labeled "GHG_IntensityOfInvesteeComp..." with the range "30340 - 30370" is connected to the "Value" sub-element of the main structure.</p> |
| type       | <a href="#">ValueStrategyCoverageType1.1</a>   |
| properties | isRef 0<br>minOcc 0<br>maxOcc 1<br>content complex   |
| children   | <a href="#">Value</a> <a href="#">ConsideredInInvestmentStrategy</a> <a href="#">Coverage</a> <a href="#">EligibleAssets</a>   |
| annotation | documentation<br>30340 - 30370   |

element

### EETReportType1.1.1/PrincipalAdverseIndicators/ClimateAndEnvironmentRelatedIndicators/ExposureToCompaniesActiveInTheFossilFuelSector

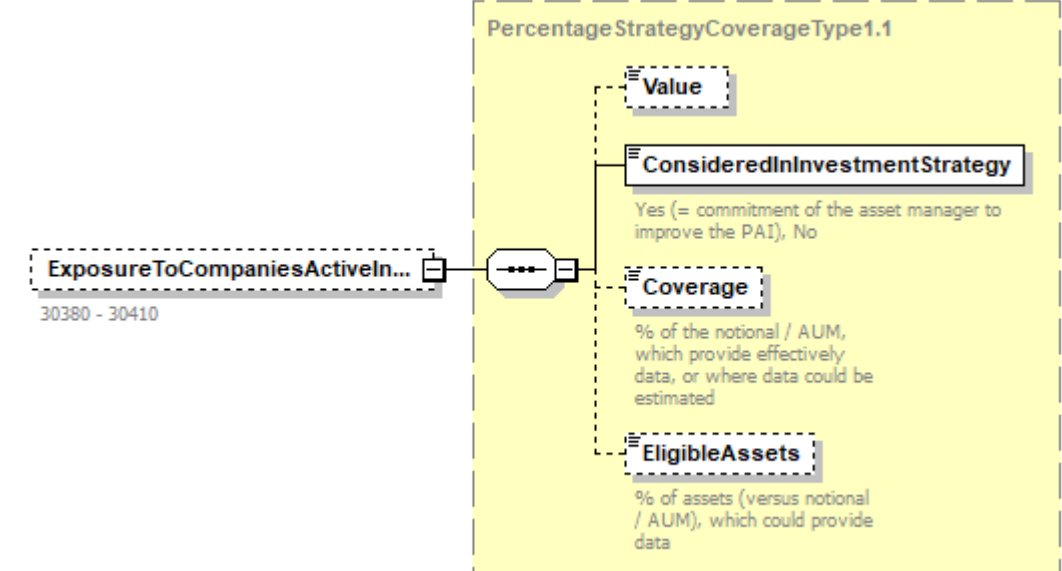
|         |   |
|---------|---|
| diagram |  <p>The diagram shows a dashed box labeled "PercentageStrategyCoverageType1.1" containing three sub-elements: "Value", "ConsideredInInvestmentStrategy", and "EligibleAssets". A separate dashed box labeled "ExposureToCompaniesActiveIn..." with the range "30380 - 30410" is connected to the "Value" sub-element of the main structure.</p> |
|---------|---|

|            |  |
|------------|--|
| type       | <a href="#">PercentageStrategyCoverageType1.1</a>  |
| properties | isRef 0<br>minOcc 0<br>maxOcc 1<br>content complex   |
| children   | <a href="#">Value</a> <a href="#">ConsideredInInvestmentStrategy</a> <a href="#">Coverage</a> <a href="#">EligibleAssets</a> |
| annotation | documentation<br>30380 - 30410   |

element

**EETReportType1.1.1/PrincipalAdverseIndicators/ClimateAndEnvironmentRelatedIndicators/EnergyConsumptionFromNonRenewableSources**

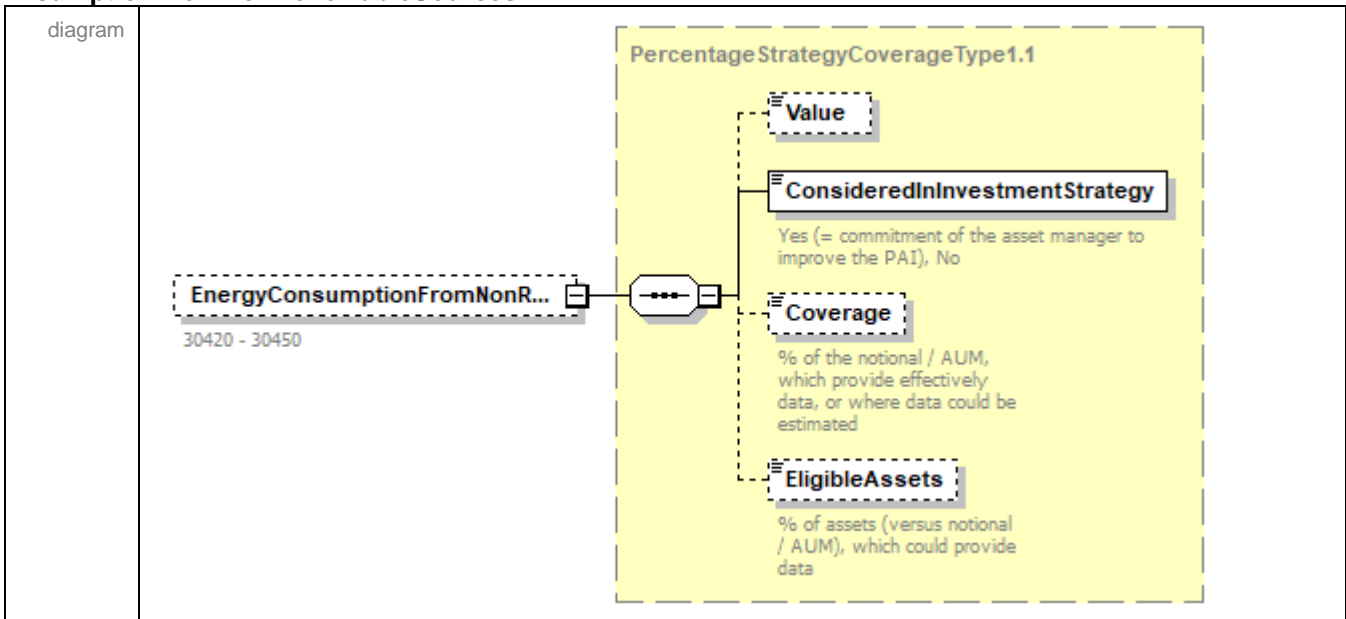

|            |  |
|------------|--|
| type       | <a href="#">PercentageStrategyCoverageType1.1</a>  |
| properties | isRef 0<br>minOcc 0<br>maxOcc 1<br>content complex   |
| children   | <a href="#">Value</a> <a href="#">ConsideredInInvestmentStrategy</a> <a href="#">Coverage</a> <a href="#">EligibleAssets</a> |
| annotation | documentation<br>30420 - 30450   |

element

**EETReportType1.1.1/PrincipalAdverseIndicators/ClimateAndEnvironmentRelatedIndicators/EnergyProductionFromNonRenewableSources**

|                   |   |
|-------------------|---|
| <p>diagram</p>    |   |
| <p>type</p>       | <p><a href="#">PercentageStrategyCoverageType1.1</a></p>  |
| <p>properties</p> | <p>isRef 0<br/>minOcc 0<br/>maxOcc 1<br/>content complex</p>  |
| <p>children</p>   | <p><a href="#">Value</a> <a href="#">ConsideredInInvestmentStrategy</a> <a href="#">Coverage</a> <a href="#">EligibleAssets</a></p> |
| <p>annotation</p> | <p>documentation<br/>30460 - 30490</p>  |

element

**EETReportType1.1.1/PrincipalAdverseIndicators/ClimateAndEnvironmentRelatedIndicators/EnergyConsumptionIntensityPerHighImpactClimateSector**

|                   |  |
|-------------------|--|
| <p>diagram</p>    |  |
| <p>properties</p> | <p>isRef 0<br/>minOcc 0<br/>maxOcc 1<br/>content complex</p> |
| <p>children</p>   | <p><a href="#">NACE_Values</a></p>                           |
| <p>annotation</p> | <p>documentation<br/>30500 - 30850</p>                       |

element

**EETReportType1.1.1/PrincipalAdverseIndicators/ClimateAndEnvironmentRelatedIndicators/EnergyConsumptionIntensityPerHighImpactClimateSector/NACE\_Values**

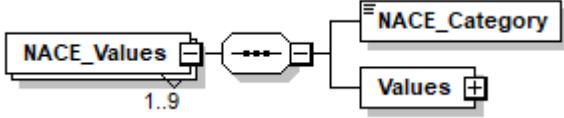
|            |   |
|------------|---|
| diagram    |  |
| properties | isRef 0<br>minOcc 1<br>maxOcc 9<br>content complex                                |
| children   | <a href="#">NACE_Category</a> <a href="#">Values</a>                              |

element

**EETReportType1.1.1/PrincipalAdverseIndicators/ClimateAndEnvironmentRelatedIndicators/EnergyConsumptionIntensityPerHighImpactClimateSector/NACE\_Values/NACE\_Category**

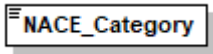
|            |   |
|------------|---|
| diagram    |  |
| type       | restriction of xs:string  |
| properties | isRef 0<br>content simple   |

element

**EETReportType1.1.1/PrincipalAdverseIndicators/ClimateAndEnvironmentRelatedIndicators/EnergyConsumptionIntensityPerHighImpactClimateSector/NACE\_Values/Values**

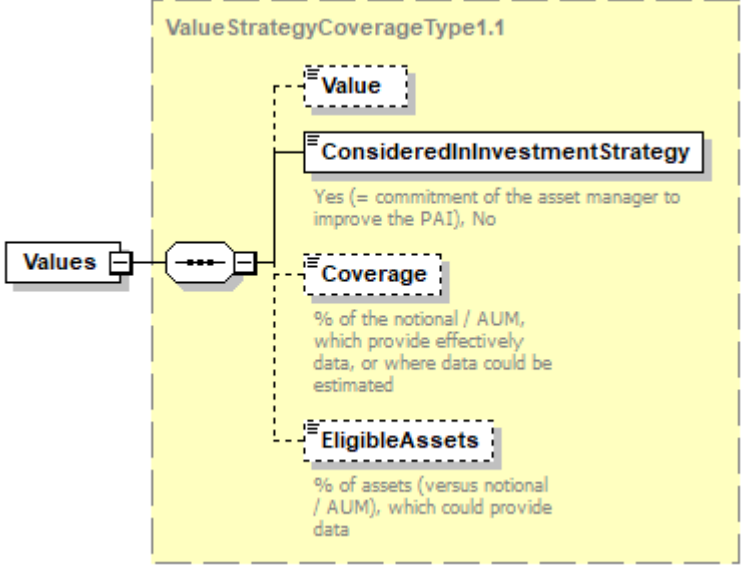
|            |  |
|------------|--|
| diagram    |    |
| type       | <a href="#">ValueStrategyCoverageType1.1</a>   |
| properties | isRef 0<br>content complex   |
| children   | <a href="#">Value</a> <a href="#">ConsideredInInvestmentStrategy</a> <a href="#">Coverage</a> <a href="#">EligibleAssets</a> |

element  
**EETReportType1.1/PrincipalAdverseIndicators/ClimateAndEnvironmentRelatedIndicators/ActivitiesNegativelyAffectingBiodiversitySensitiveAreas**

|                   |   |
|-------------------|---|
| <p>diagram</p>    | <pre> classDiagram     class ActivitiesNegativelyAffectingBi... {         30860 - 30890     }     class ValueStrategyCoverageType1.1 {         Value         ConsideredInInvestmentStrategy         Coverage         EligibleAssets     }     ActivitiesNegativelyAffectingBi... -- ValueStrategyCoverageType1.1     </pre> |
| <p>type</p>       | <p><a href="#">ValueStrategyCoverageType1.1</a></p>   |
| <p>properties</p> | <p>isRef 0<br/> minOcc 0<br/> maxOcc 1<br/> content complex</p>   |
| <p>children</p>   | <p><a href="#">Value</a> <a href="#">ConsideredInInvestmentStrategy</a> <a href="#">Coverage</a> <a href="#">EligibleAssets</a></p>   |
| <p>annotation</p> | <p>documentation<br/> 30860 - 30890</p>   |



element

### EETReportType1.1.1/PrincipalAdverseIndicators/ClimateAndEnvironmentRelatedIndicators/WaterEmissions

|            |  |
|------------|--|
| diagram    |  |
| type       | <a href="#">ValueStrategyCoverageType1.1</a>   |
| properties | isRef 0<br>minOcc 0<br>maxOcc 1<br>content complex   |
| children   | <a href="#">Value</a> <a href="#">ConsideredInInvestmentStrategy</a> <a href="#">Coverage</a> <a href="#">EligibleAssets</a> |
| annotation | documentation<br>30900 - 30930   |

element

### EETReportType1.1.1/PrincipalAdverseIndicators/ClimateAndEnvironmentRelatedIndicators/Hazardous Waste

|         |  |
|---------|--|
| diagram |  |
|---------|--|

|            |  |
|------------|--|
| type       | <a href="#">ValueStrategyCoverageType1.1</a>                                 |
| properties | isRef 0<br>minOcc 0<br>maxOcc 1<br>content complex                           |
| children   | <a href="#">Value ConsideredInInvestmentStrategy Coverage EligibleAssets</a> |
| annotation | documentation<br>30940 - 30970   |

element **EETReportType1.1.1/PrincipalAdverseIndicators/SocialAndEmployeeMatters**

|            |  |
|------------|--|
| diagram    | <p>The diagram shows a class <b>SocialAndEmployeeMatters</b> (ID: 30980 - 31160) with a composition relationship to a container class. This container class has five subclasses, each in a dashed box:</p> <ul style="list-style-type: none"> <li><b>CompaniesInvolvedInViolation...</b> (ID: 30980 - 31010): Companies_Involved_In_Violation_Of_UN_Global_Compact_Principles_And_OECD_Guidelines_For_Multinational_Enterprises</li> <li><b>CompaniesWithoutMonitoring...</b> (ID: 31020 - 31045): Share_Of_Companies_Without_Policies_To_Monitor_Compliance_With_UNGCP_And_OECD_Guidelines_For_Multinational_Enterprises</li> <li><b>UnadjustedGenderPayGap</b> (ID: 31050 - 31080): Unadjusted_Gender_Pay_Gap</li> <li><b>BoardGenderDiversity</b> (ID: 31090 - 31120): Board_Gender_Diversity</li> <li><b>InvestmentsInvolvedInControv...</b> (ID: 31130 - 31160): Investments_Involved_In_Controversial_Weapons</li> </ul> |
| properties | isRef 0<br>minOcc 0<br>maxOcc 1<br>content complex   |
| children   | <a href="#">CompaniesInvolvedInViolation UN GCP Or OECD ME Guidelines</a><br><a href="#">CompaniesWithoutMonitoringCompliance UN GCP Or OECD ME Guidelines</a><br><a href="#">UnadjustedGenderPayGap</a><br><a href="#">BoardGenderDiversity</a><br><a href="#">InvestmentsInvolvedInControversialWeapons</a>  |
| annotation | documentation<br>30980 - 31160   |

element

**EETReportType1.1/PrincipalAdverseIndicators/SocialAndEmployeeMatters/CompaniesInvolvedInViolation\_UN\_GCP\_Or\_OECD\_ME\_Guidelines**

|                   |  |
|-------------------|--|
| <p>diagram</p>    |  |
| <p>type</p>       | <p><a href="#">PercentageStrategyCoverageType1.1</a></p>   |
| <p>properties</p> | <p>isRef 0<br/>minOcc 0<br/>maxOcc 1<br/>content complex</p>   |
| <p>children</p>   | <p><a href="#">Value</a> <a href="#">ConsideredInInvestmentStrategy</a> <a href="#">Coverage</a> <a href="#">EligibleAssets</a></p>                        |
| <p>annotation</p> | <p>documentation<br/>Companies_Involved_In_Violation_Of_UN_Global_Compact_Principles_And_OECD_Guidelines_For_Multinational_Enterprises (30980 - 31010)</p> |

element

**EETReportType1.1.1/PrincipalAdverseIndicators/SocialAndEmployeeMatters/CompaniesWithoutMonitoringCompliance\_UN\_GCP\_Or\_OECD\_ME\_Guidelines**

|                   |   |
|-------------------|---|
| <p>diagram</p>    |   |
| <p>type</p>       | <p><a href="#">PercentageStrategyCoverageType1.1</a></p>  |
| <p>properties</p> | <p>isRef 0<br/>minOcc 0<br/>maxOcc 1<br/>content complex</p>  |
| <p>children</p>   | <p><a href="#">Value</a> <a href="#">ConsideredInInvestmentStrategy</a> <a href="#">Coverage</a> <a href="#">EligibleAssets</a></p>                             |
| <p>annotation</p> | <p>documentation<br/>Share_Of_Companies_Without_Policies_To_Monitor_Compliance_With_UNGCP_And_OECD_Guidelines_For_Multinational_Enterprises (31020 - 31045)</p> |

element

**EETReportType1.1/PrincipalAdverseIndicators/SocialAndEmployeeMatters/UnadjustedGenderPayGap**

|                   |   |
|-------------------|---|
| <p>diagram</p>    |   |
| <p>type</p>       | <p><a href="#">PercentageStrategyCoverageType1.1</a></p>  |
| <p>properties</p> | <p>isRef 0<br/>minOcc 0<br/>maxOcc 1<br/>content complex</p>  |
| <p>children</p>   | <p><a href="#">Value</a> <a href="#">ConsideredInInvestmentStrategy</a> <a href="#">Coverage</a> <a href="#">EligibleAssets</a></p> |
| <p>annotation</p> | <p>documentation<br/>Unadjusted_Gender_Pay_Gap (31050 - 31080)</p>  |

element

**EETReportType1.1/PrincipalAdverseIndicators/SocialAndEmployeeMatters/BoardGenderDiversity**

|                |  |
|----------------|--|
| <p>diagram</p> |  |
|----------------|--|

|            |  |
|------------|--|
| type       | <a href="#">ValueStrategyCoverageType1.1</a>   |
| properties | isRef 0<br>minOcc 0<br>maxOcc 1<br>content complex   |
| children   | <a href="#">Value</a> <a href="#">ConsideredInInvestmentStrategy</a> <a href="#">Coverage</a> <a href="#">EligibleAssets</a> |
| annotation | documentation<br>Board_Gender_Diversity (31090 - 31120)  |

element

**EETReportType1.1.1/PrincipalAdverseIndicators/SocialAndEmployeeMatters/InvestmentsInvolvedInControversialWeapons**

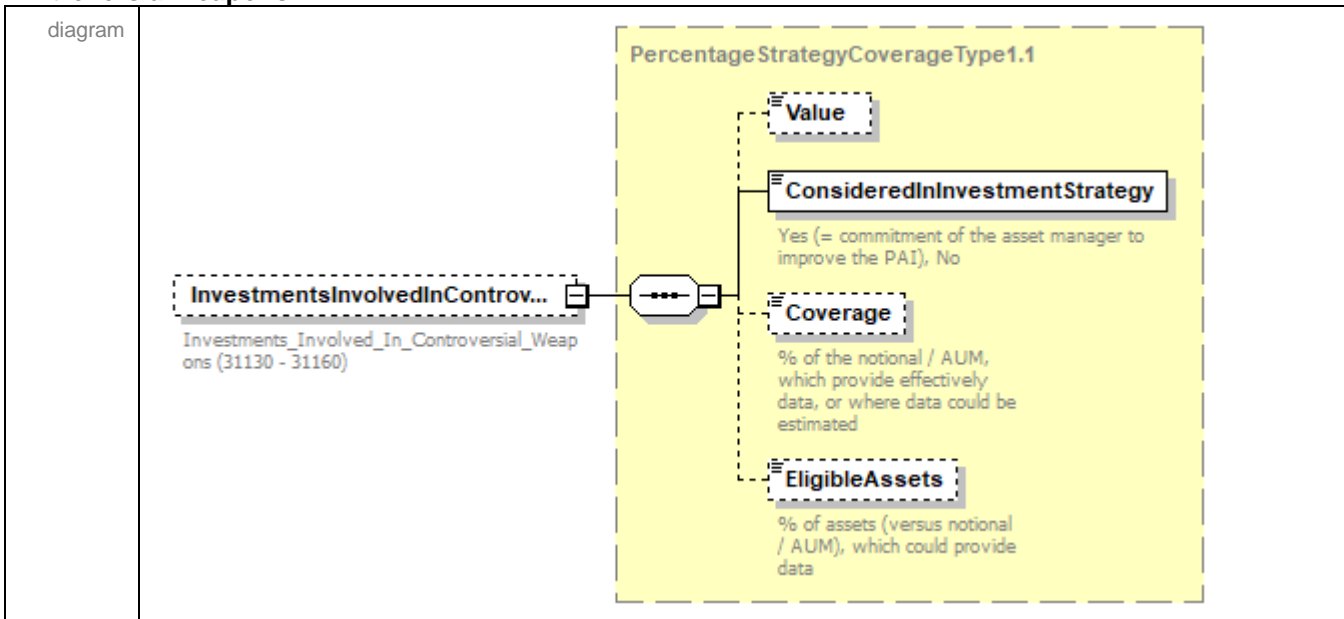

|            |  |
|------------|--|
| type       | <a href="#">PercentageStrategyCoverageType1.1</a>  |
| properties | isRef 0<br>minOcc 0<br>maxOcc 1<br>content complex   |
| children   | <a href="#">Value</a> <a href="#">ConsideredInInvestmentStrategy</a> <a href="#">Coverage</a> <a href="#">EligibleAssets</a> |
| annotation | documentation<br>Investments_Involved_In_Controversial_Weapons (31130 - 31160)   |

element **EETReportType1.1.1/PrincipalAdverseIndicators/SovereignAndSupranationalInvestments**

|            |   |
|------------|---|
| diagram    |   |
| properties | <p>isRef 0<br/> minOcc 0<br/> maxOcc 1<br/> content complex</p>   |
| children   | <p><a href="#">GreenhouseGasIntensity</a> <a href="#">NumberOfCountriesSubjectToSocialViolations</a><br/> <a href="#">PercentOfCountriesSubjectToSocialViolations</a></p> |
| annotation | <p>documentation<br/> 31170 - 31280</p>   |

element **EETReportType1.1.1/PrincipalAdverseIndicators/SovereignAndSupranationalInvestments/Greenhouse GasIntensity**

|            |   |
|------------|---|
| diagram    |   |
| type       | <p><a href="#">ValueStrategyCoverageType1.1</a></p>   |
| properties | <p>isRef 0<br/> minOcc 0<br/> maxOcc 1<br/> content complex</p>   |
| children   | <p><a href="#">Value</a> <a href="#">ConsideredInInvestmentStrategy</a> <a href="#">Coverage</a> <a href="#">EligibleAssets</a></p> |
| annotation | <p>documentation<br/> GHG_Intesity (31170 - 31200)</p>  |

element

### EETReportType1.1.1/PrincipalAdverseIndicators/SovereignAndSupranationalInvestments/NumberOfCountriesSubjectToSocialViolations

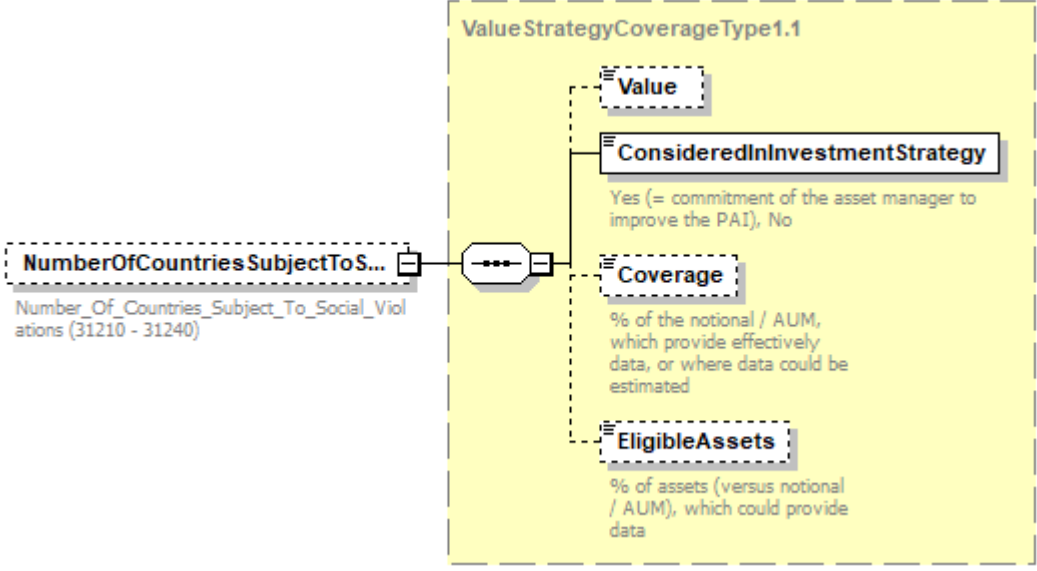
|            |  |
|------------|--|
| diagram    |  <p>The diagram shows a dashed box labeled "ValueStrategyCoverageType1.1" containing four sub-elements: "Value", "ConsideredInInvestmentStrategy", "Coverage", and "EligibleAssets". Each sub-element has a brief description: "Value" (no description), "ConsideredInInvestmentStrategy" (Yes (= commitment of the asset manager to improve the PAI), No), "Coverage" (% of the notional / AUM, which provide effectively data, or where data could be estimated), and "EligibleAssets" (% of assets (versus notional / AUM), which could provide data). To the left of this box is a dashed box labeled "NumberOfCountriesSubjectToS..." with the description "Number_Of_Countries_Subject_To_Social_Violations (31210 - 31240)". A line connects this box to the "ValueStrategyCoverageType1.1" box via a connector symbol.</p> |
| type       | <a href="#">ValueStrategyCoverageType1.1</a>   |
| properties | isRef 0<br>minOcc 0<br>maxOcc 1<br>content complex   |
| children   | <a href="#">Value</a> <a href="#">ConsideredInInvestmentStrategy</a> <a href="#">Coverage</a> <a href="#">EligibleAssets</a>   |
| annotation | documentation<br>Number_Of_Countries_Subject_To_Social_Violations (31210 - 31240)  |

element

### EETReportType1.1.1/PrincipalAdverseIndicators/SovereignAndSupranationalInvestments/PercentOfCountriesSubjectToSocialViolations

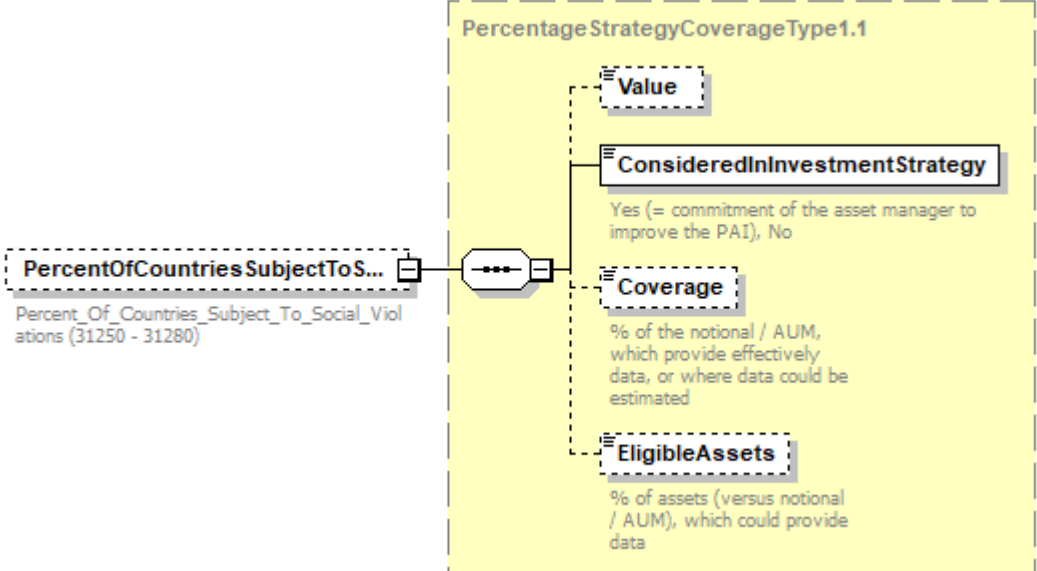
|         |  |
|---------|--|
| diagram |  <p>The diagram shows a dashed box labeled "PercentageStrategyCoverageType1.1" containing four sub-elements: "Value", "ConsideredInInvestmentStrategy", "Coverage", and "EligibleAssets". Each sub-element has a brief description: "Value" (no description), "ConsideredInInvestmentStrategy" (Yes (= commitment of the asset manager to improve the PAI), No), "Coverage" (% of the notional / AUM, which provide effectively data, or where data could be estimated), and "EligibleAssets" (% of assets (versus notional / AUM), which could provide data). To the left of this box is a dashed box labeled "PercentOfCountriesSubjectToS..." with the description "Percent_Of_Countries_Subject_To_Social_Violations (31250 - 31280)". A line connects this box to the "PercentageStrategyCoverageType1.1" box via a connector symbol.</p> |
|---------|--|



|            |  |
|------------|--|
| type       | <a href="#">PercentageStrategyCoverageType1.1</a>  |
| properties | isRef 0<br>minOcc 0<br>maxOcc 1<br>content complex   |
| children   | <a href="#">Value</a> <a href="#">ConsideredInInvestmentStrategy</a> <a href="#">Coverage</a> <a href="#">EligibleAssets</a> |
| annotation | documentation<br>Percent_Of_Countries_Subject_To_Social_Violations (31250 - 31280)   |

element **EETReportType1.1.1/PrincipalAdverseIndicators/RealEstateInvestments**

|            |  |
|------------|--|
| diagram    | <p>The diagram shows a central element 'RealEstateInvestments' (ID 31290 - 31360) connected to two child elements: 'FossilFuelsExtractionStorageTransportManufacture' (ID 31290 - 31320) and 'EnergyInefficientRealEstateAssets' (ID 31330 - 31360).</p> |
| properties | isRef 0<br>minOcc 0<br>maxOcc 1<br>content complex   |
| children   | <a href="#">FossilFuelsExtractionStorageTransportManufacture</a> <a href="#">EnergyInefficientRealEstateAssets</a>   |
| annotation | documentation<br>31290 - 31360   |

element **EETReportType1.1.1/PrincipalAdverseIndicators/RealEstateInvestments/FossilFuelsExtractionStorageTransportManufacture**

|            |   |
|------------|---|
| diagram    | <p>The diagram shows 'FossilFuelsExtractionStorageTransportManufacture' (ID 31290 - 31320) connected to a larger structure 'PercentageStrategyCoverageType1.1'. This structure contains four sub-elements: 'Value', 'ConsideredInInvestmentStrategy' (with text: 'Yes (= commitment of the asset manager to improve the PAI), No'), 'Coverage' (with text: '% of the notional / AUM, which provide effectively data, or where data could be estimated'), and 'EligibleAssets' (with text: '% of assets (versus notional / AUM), which could provide data').</p> |
| type       | <a href="#">PercentageStrategyCoverageType1.1</a>   |
| properties | isRef 0<br>minOcc 0<br>maxOcc 1   |

|            |  |
|------------|--|
|            | content complex  |
| children   | <a href="#">Value</a> <a href="#">ConsideredInInvestmentStrategy</a> <a href="#">Coverage</a> <a href="#">EligibleAssets</a> |
| annotation | documentation<br>Exposure_To_Fossil_Fuels_Extraction_Storage_Transport_Manufacture (31290 - 31320)                           |

element

**EETReportType1.1.1/PrincipalAdverseIndicators/RealEstateInvestments/EnergyInefficientRealEstateAssets**

|            |  |
|------------|--|
| diagram    | <p>The diagram illustrates the composition of the <b>EnergyInefficientRealEstateAssets</b> class. It is composed of the <b>PercentageStrategyCoverageType1.1</b> class. The <b>PercentageStrategyCoverageType1.1</b> class is further composed of four elements: <b>Value</b>, <b>ConsideredInInvestmentStrategy</b> (Yes (= commitment of the asset manager to improve the PAI), No), <b>Coverage</b> (% of the notional / AUM, which provide effectively data, or where data could be estimated), and <b>EligibleAssets</b> (% of assets (versus notional / AUM), which could provide data).</p> |
| type       | <a href="#">PercentageStrategyCoverageType1.1</a>  |
| properties | isRef 0<br>minOcc 0<br>maxOcc 1<br>content complex   |
| children   | <a href="#">Value</a> <a href="#">ConsideredInInvestmentStrategy</a> <a href="#">Coverage</a> <a href="#">EligibleAssets</a>   |
| annotation | documentation<br>Exposure_To_Energy_infficient_Real_Estate_Assets (31330 - 31360)  |

element

**EETReportType1.1.1/PrincipalAdverseIndicators/MoreClimateAndEnvironmentRelatedIndicators**

|                   |   |
|-------------------|---|
| <p>diagram</p>    |   |
| <p>properties</p> | <p>isRef 0<br/>minOcc 0<br/>maxOcc 1<br/>content complex</p>  |
| <p>children</p>   | <p><a href="#">EnergyEfficiency</a> <a href="#">EnergyConsumptionNonRenewable</a> <a href="#">WaterWasteAndLandProtection</a> <a href="#">GreenSecurities</a> <a href="#">RealEstateInvestments</a></p> |
| <p>annotation</p> | <p>documentation<br/>31370 - 32430</p>  |

element

**EETReportType1.1.1/PrincipalAdverseIndicators/MoreClimateAndEnvironmentRelatedIndicators/EnergyEfficiency**

|                   |   |
|-------------------|---|
| <p>diagram</p>    |   |
| <p>properties</p> | <p>isRef 0<br/>minOcc 0<br/>maxOcc 1<br/>content complex</p>  |
| <p>children</p>   | <p><a href="#">EmissionsOfInorganicPollutants</a> <a href="#">EmissionsOfAirPollutants</a> <a href="#">EmissionsOfOzoneDepletionSubstances</a> <a href="#">CompaniesWithoutCarbonEmissionReductionInitiatives</a></p> |
| <p>annotation</p> | <p>documentation<br/>31370 - 31510</p>  |

element

**EETReportType1.1/PrincipalAdverseIndicators/MoreClimateAndEnvironmentRelatedIndicators/EnergyEfficiency/EmissionsOfInorganicPollutants**

|                   |   |
|-------------------|---|
| <p>diagram</p>    |   |
| <p>type</p>       | <p><a href="#">ValueStrategyCoverageType1.1</a></p>   |
| <p>properties</p> | <p>isRef 0<br/>minOcc 0<br/>maxOcc 1<br/>content complex</p>  |
| <p>children</p>   | <p><a href="#">Value</a> <a href="#">ConsideredInInvestmentStrategy</a> <a href="#">Coverage</a> <a href="#">EligibleAssets</a></p> |
| <p>annotation</p> | <p>documentation<br/>Emissions_Of_Inorganic_Pollutants (31370 - 31400)</p>  |

element

### EETReportType1.1.1/PrincipalAdverseIndicators/MoreClimateAndEnvironmentRelatedIndicators/EnergyEfficiency/EmissionsOfAirPollutants

|            |   |
|------------|---|
| diagram    | <p><b>EmissionsOfAirPollutants</b><br/>Emissions_Of_Air_Pollutants (31410 - 31440)</p> <p><b>ValueStrategyCoverageType1.1</b></p> <ul style="list-style-type: none"><li><b>Value</b></li><li><b>ConsideredInInvestmentStrategy</b><br/>Yes (= commitment of the asset manager to improve the PAI), No</li><li><b>Coverage</b><br/>% of the notional / AUM, which provide effectively data, or where data could be estimated</li><li><b>EligibleAssets</b><br/>% of assets (versus notional / AUM), which could provide data</li></ul> |
| type       | <a href="#">ValueStrategyCoverageType1.1</a>  |
| properties | isRef 0<br>minOcc 0<br>maxOcc 1<br>content complex  |
| children   | <a href="#">Value</a> <a href="#">ConsideredInInvestmentStrategy</a> <a href="#">Coverage</a> <a href="#">EligibleAssets</a>  |
| annotation | documentation<br>Emissions_Of_Air_Pollutants (31410 - 31440)  |

element

### EETReportType1.1.1/PrincipalAdverseIndicators/MoreClimateAndEnvironmentRelatedIndicators/EnergyEfficiency/EmissionsOfOzoneDepletionSubstances

|         |  |
|---------|--|
| diagram | <p><b>EmissionsOfOzoneDepletionSubstances</b><br/>Emissions_Of_Ozone_Depletion_Substances (31450 - 31480)</p> <p><b>ValueStrategyCoverageType1.1</b></p> <ul style="list-style-type: none"><li><b>Value</b></li><li><b>ConsideredInInvestmentStrategy</b><br/>Yes (= commitment of the asset manager to improve the PAI), No</li><li><b>Coverage</b><br/>% of the notional / AUM, which provide effectively data, or where data could be estimated</li><li><b>EligibleAssets</b><br/>% of assets (versus notional / AUM), which could provide data</li></ul> |
|---------|--|

|            |  |
|------------|--|
| type       | <a href="#">ValueStrategyCoverageType1.1</a>   |
| properties | isRef 0<br>minOcc 0<br>maxOcc 1<br>content complex   |
| children   | <a href="#">Value</a> <a href="#">ConsideredInInvestmentStrategy</a> <a href="#">Coverage</a> <a href="#">EligibleAssets</a> |
| annotation | documentation<br>Emissions_Of_Ozone_Depletion_Substances (31450 - 31480)   |

element

**EETReportType1.1.1/PrincipalAdverseIndicators/MoreClimateAndEnvironmentRelatedIndicators/EnergyEfficiency/CompaniesWithoutCarbonEmissionReductionInitiatives**

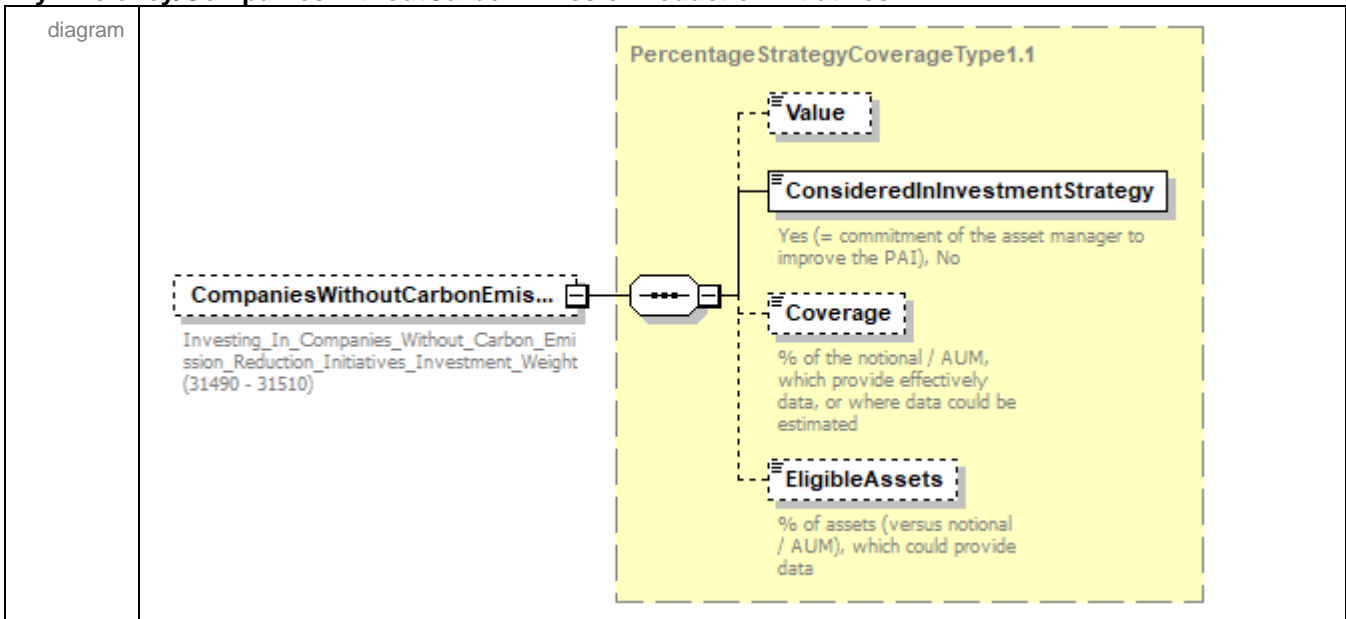

|            |  |
|------------|--|
| type       | <a href="#">PercentageStrategyCoverageType1.1</a>  |
| properties | isRef 0<br>minOcc 0<br>maxOcc 1<br>content complex   |
| children   | <a href="#">Value</a> <a href="#">ConsideredInInvestmentStrategy</a> <a href="#">Coverage</a> <a href="#">EligibleAssets</a> |
| annotation | documentation<br>Investing_In_Companies_Without_Carbon_Emission_Reduction_Initiatives_Investment_Weight (31490 - 31510)      |

element

### EETReportType1.1.1/PrincipalAdverseIndicators/MoreClimateAndEnvironmentRelatedIndicators/EnergyConsumptionNonRenewable

|            |   |
|------------|---|
| diagram    | <p><b>Oil</b> (+)<br/>Breakdown_Of_Energy_Consumption_By_Type_Of_Non-renewable_Sources_Of_Energy_Oil (31520 - 31550)</p> <p><b>NaturalGas</b> (+)<br/>Breakdown_Of_Energy_Consumption_By_Type_Of_Non-renewable_Sources_Of_Energy_Natural_Gas (31560 - 31590)</p> <p><b>Coal</b> (+)<br/>Breakdown_Of_Energy_Consumption_By_Type_Of_Non-renewable_Sources_Of_Energy_Coal (31600 - 31630)</p> |
| properties | isRef 0<br>minOcc 0<br>maxOcc 1<br>content complex  |
| children   | <a href="#">Oil</a> <a href="#">NaturalGas</a> <a href="#">Coal</a>   |
| annotation | documentation<br>31520 - 31630  |

element

### EETReportType1.1.1/PrincipalAdverseIndicators/MoreClimateAndEnvironmentRelatedIndicators/EnergyConsumptionNonRenewable/Oil

|            |  |
|------------|--|
| diagram    | <p><b>Oil</b> (+)<br/>Breakdown_Of_Energy_Consumption_By_Type_Of_Non-renewable_Sources_Of_Energy_Oil (31520 - 31550)</p> <p><b>PercentageStrategyCoverageType1.1</b></p> <ul style="list-style-type: none"><li><b>Value</b></li><li><b>ConsideredInInvestmentStrategy</b><br/>Yes (= commitment of the asset manager to improve the PAI), No</li><li><b>Coverage</b><br/>% of the notional / AUM, which provide effectively data, or where data could be estimated</li><li><b>EligibleAssets</b><br/>% of assets (versus notional / AUM), which could provide data</li></ul> |
| type       | <a href="#">PercentageStrategyCoverageType1.1</a>  |
| properties | isRef 0<br>minOcc 0  |

|            |  |
|------------|--|
|            | maxOcc 1<br>content complex  |
| children   | <a href="#">Value</a> <a href="#">ConsideredInInvestmentStrategy</a> <a href="#">Coverage</a> <a href="#">EligibleAssets</a> |
| annotation | documentation<br>Breakdown_Of_Energy_Consumption_By_Type_Of_Non-renewable_Sources_Of_Energy_Oil (31520 - 31550)              |

element

**EETReportType1.1.1/PrincipalAdverseIndicators/MoreClimateAndEnvironmentRelatedIndicators/EnergyConsumptionNonRenewable/NaturalGas**

|            |  |
|------------|--|
| diagram    |  |
| type       | <a href="#">PercentageStrategyCoverageType1.1</a>  |
| properties | isRef 0<br>minOcc 0<br>maxOcc 1<br>content complex   |
| children   | <a href="#">Value</a> <a href="#">ConsideredInInvestmentStrategy</a> <a href="#">Coverage</a> <a href="#">EligibleAssets</a> |
| annotation | documentation<br>Breakdown_Of_Energy_Consumption_By_Type_Of_Non-renewable_Sources_Of_Energy_Natural_Gas (31560 - 31590)      |



element

**EETReportType1.1.1/PrincipalAdverseIndicators/MoreClimateAndEnvironmentRelatedIndicators/EnergyConsumptionNonRenewable/Coal**

|                   |   |
|-------------------|---|
| <p>diagram</p>    |   |
| <p>type</p>       | <p><a href="#">PercentageStrategyCoverageType1.1</a></p>  |
| <p>properties</p> | <p>isRef 0<br/>minOcc 0<br/>maxOcc 1<br/>content complex</p>  |
| <p>children</p>   | <p><a href="#">Value</a> <a href="#">ConsideredInInvestmentStrategy</a> <a href="#">Coverage</a> <a href="#">EligibleAssets</a></p> |
| <p>annotation</p> | <p>documentation<br/>Breakdown_Of_Energy_Consumption_By_Type_Of_Non-renewable_Sources_Of_Energy_Coal (31600 - 31630)</p>            |

element

**EETReportType1.1.1/PrincipalAdverseIndicators/MoreClimateAndEnvironmentRelatedIndicators/Water  
WasteAndLandProtection**

diagram

**WaterWasteAndLandProtection**

31640 - 31990

**WaterUsageAndRecyclingAmo...**

Water\_Usage\_And\_Recycling\_Average\_Amount (31640 - 31670)

**WaterUsageAndRecyclingPerce...**

Water\_Usage\_And\_Recycling\_Average\_Percentage (31640 - 31670)

**CompaniesWithoutWaterMana...**

Investing\_In\_Companies\_Without\_Water\_Management\_Policies\_Weight (31680 - 31710)

**AreasOfHighWaterStress**

Exposure\_To\_Areas\_Of\_High\_Water\_Stress (31720 - 31750)

**CompaniesProducingChemicals**

Exposure\_To\_Companies\_Producing\_Chemicals (31760 - 31790)

**CompaniesCausingLandDegra...**

Exposure\_To\_Companies\_Causing\_Land\_Degradation\_Desertification\_Or\_Soil\_Sealing (31800 - 31830)

**CompaniesWithoutSustainable...**

Exposure\_To\_Companies\_Without\_Sustainable\_Land\_Or\_Agriculture\_Practices\_Policies (31840 - 31870)

**CompaniesWithoutSustainable...**

Share\_Of\_Investments\_In\_Companies\_Without\_Sustainable\_Oceans\_Or\_Seas\_Practices (31871 - 31874)

**NonRecycledWasteRatio**

Non\_Recycled\_Waste\_Ratio (31875 - 31878)

**CompaniesWhoseOperationsA...**

Share\_Of\_Investments\_In\_Investee\_Companies\_Whose\_Operations\_Affect\_Threatened\_Species (31880 - 31910)

**CompaniesWithoutBiodiversity...**

Share\_Of\_Investments\_In\_Investee\_Companies\_Without\_A\_Biodiversity\_Protection\_Policy\_Covering\_Operational\_Sites\_Owned\_Leased\_Managed\_In\_Or\_Adjacent\_To\_A\_Protected\_Area\_Or\_An\_Area\_Of\_High\_Biodiversity\_Value\_Outside\_Protected\_Areas (31920 - 31950)

**CompaniesWithoutDeforestat...**

Share\_Of\_Investee\_Companies\_Without\_Deforestation\_Policy (31960 - 31990)

properties

isRef 0  
minOcc 0

|            |  |
|------------|--|
|            | maxOcc 1<br>content complex  |
| children   | <a href="#">WaterUsageAndRecyclingAmount</a> <a href="#">WaterUsageAndRecyclingPercentage</a> <a href="#">CompaniesWithoutWaterManagement</a> <a href="#">AreasOfHighWaterStress</a> <a href="#">CompaniesProducingChemicals</a> <a href="#">CompaniesCausingLandDegradationDesertificationSoilSealing</a> <a href="#">CompaniesWithoutSustainableLandOrAgriculturePractices</a> <a href="#">CompaniesWithoutSustainableOceansSeasPractices</a> <a href="#">NonRecycledWasteRatio</a> <a href="#">CompaniesWhoseOperationsAffectThreatenedSpecies</a> <a href="#">CompaniesWithoutBiodiversityProtection</a> <a href="#">CompaniesWithoutDeforestationPolicy</a> |
| annotation | documentation<br>31640 - 31990   |

element

**EETReportType1.1/PrincipalAdverseIndicators/MoreClimateAndEnvironmentRelatedIndicators/WaterWasteAndLandProtection/WaterUsageAndRecyclingAmount**

|            |  |
|------------|--|
| diagram    |  |
| type       | <a href="#">ValueStrategyCoverageType1.1</a>   |
| properties | isRef 0<br>minOcc 0<br>maxOcc 1<br>content complex   |
| children   | <a href="#">Value</a> <a href="#">ConsideredInInvestmentStrategy</a> <a href="#">Coverage</a> <a href="#">EligibleAssets</a> |
| annotation | documentation<br>Water_Usage_And_Recycling_Average_Amount (31640 - 31670)  |

element

**EETReportType1.1.1/PrincipalAdverseIndicators/MoreClimateAndEnvironmentRelatedIndicators/WaterWasteAndLandProtection/WaterUsageAndRecyclingPercentage**

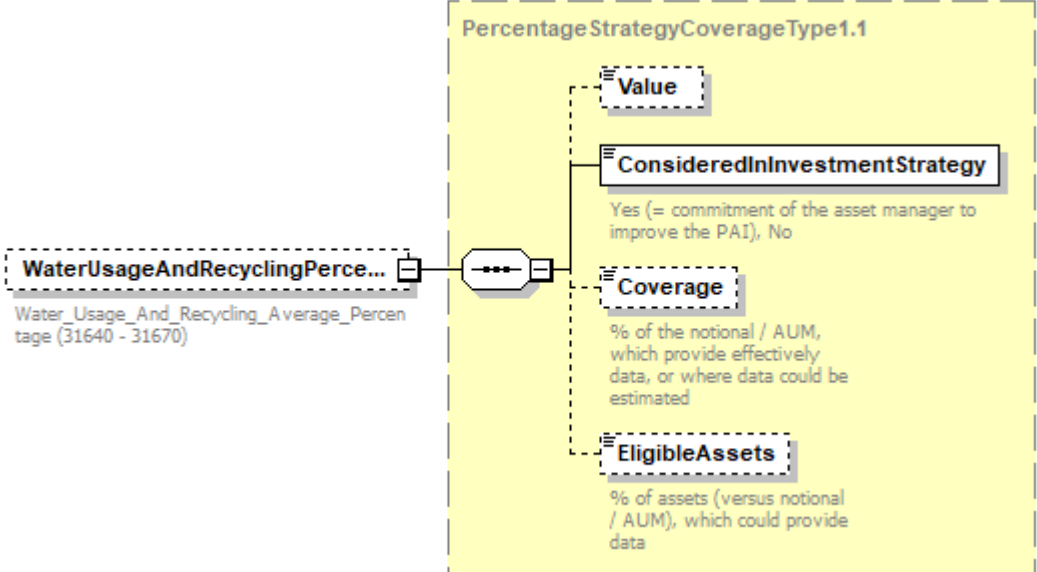
|            |  |
|------------|--|
| diagram    |  <p><b>WaterUsageAndRecyclingPerce...</b><br/>Water_Usage_And_Recycling_Average_Percentage (31640 - 31670)</p> <p><b>PercentageStrategyCoverageType1.1</b></p> <ul style="list-style-type: none"><li><b>Value</b></li><li><b>ConsideredInInvestmentStrategy</b><br/>Yes (= commitment of the asset manager to improve the PAI), No</li><li><b>Coverage</b><br/>% of the notional / AUM, which provide effectively data, or where data could be estimated</li><li><b>EligibleAssets</b><br/>% of assets (versus notional / AUM), which could provide data</li></ul> |
| type       | <a href="#">PercentageStrategyCoverageType1.1</a>  |
| properties | isRef 0<br>minOcc 0<br>maxOcc 1<br>content complex   |
| children   | <a href="#">Value</a> <a href="#">ConsideredInInvestmentStrategy</a> <a href="#">Coverage</a> <a href="#">EligibleAssets</a>   |
| annotation | documentation<br>Water_Usage_And_Recycling_Average_Percentage (31640 - 31670)  |

element

**EETReportType1.1.1/PrincipalAdverseIndicators/MoreClimateAndEnvironmentRelatedIndicators/Water WasteAndLandProtection/CompaniesWithoutWaterManagement**

|                   |   |
|-------------------|---|
| <p>diagram</p>    |   |
| <p>type</p>       | <p><a href="#">PercentageStrategyCoverageType1.1</a></p>  |
| <p>properties</p> | <p>isRef 0<br/>minOcc 0<br/>maxOcc 1<br/>content complex</p>  |
| <p>children</p>   | <p><a href="#">Value</a> <a href="#">ConsideredInInvestmentStrategy</a> <a href="#">Coverage</a> <a href="#">EligibleAssets</a></p> |
| <p>annotation</p> | <p>documentation<br/>Investing_In_Companies_Without_Water_Management_Policies_Weight (31680 - 31710)</p>                            |

element

**EETReportType1.1.1/PrincipalAdverseIndicators/MoreClimateAndEnvironmentRelatedIndicators/WaterWasteAndLandProtection/AreasOfHighWaterStress**

|                   |   |
|-------------------|---|
| <p>diagram</p>    |   |
| <p>type</p>       | <p><a href="#">PercentageStrategyCoverageType1.1</a></p>  |
| <p>properties</p> | <p>isRef 0<br/>minOcc 0<br/>maxOcc 1<br/>content complex</p>  |
| <p>children</p>   | <p><a href="#">Value</a> <a href="#">ConsideredInInvestmentStrategy</a> <a href="#">Coverage</a> <a href="#">EligibleAssets</a></p> |
| <p>annotation</p> | <p>documentation<br/>Exposure_To_Areas_Of_High_Water_Stress (31720 - 31750)</p>   |

element

**EETReportType1.1.1/PrincipalAdverseIndicators/MoreClimateAndEnvironmentRelatedIndicators/WaterWasteAndLandProtection/CompaniesProducingChemicals**

|                   |   |
|-------------------|---|
| <p>diagram</p>    |   |
| <p>type</p>       | <p><a href="#">PercentageStrategyCoverageType1.1</a></p>  |
| <p>properties</p> | <p>isRef 0<br/>minOcc 0<br/>maxOcc 1<br/>content complex</p>  |
| <p>children</p>   | <p><a href="#">Value</a> <a href="#">ConsideredInInvestmentStrategy</a> <a href="#">Coverage</a> <a href="#">EligibleAssets</a></p> |
| <p>annotation</p> | <p>documentation<br/>Exposure_To_Companies_Producing_Chemicals (31760 - 31790)</p>  |



element

**EETReportType1.1.1/PrincipalAdverseIndicators/MoreClimateAndEnvironmentRelatedIndicators/Water WasteAndLandProtection/CompaniesCausingLandDegradationDesertificationSoilSealing**

|                   |   |
|-------------------|---|
| <p>diagram</p>    |   |
| <p>type</p>       | <p><a href="#">PercentageStrategyCoverageType1.1</a></p>  |
| <p>properties</p> | <p>isRef 0<br/>minOcc 0<br/>maxOcc 1<br/>content complex</p>  |
| <p>children</p>   | <p><a href="#">Value</a> <a href="#">ConsideredInInvestmentStrategy</a> <a href="#">Coverage</a> <a href="#">EligibleAssets</a></p> |
| <p>annotation</p> | <p>documentation<br/>Exposure_To_Companies_Causing_Land_Degradation_Desertification_Or_Soil_Sealing (31800 - 31830)</p>             |

element

**EETReportType1.1.1/PrincipalAdverseIndicators/MoreClimateAndEnvironmentRelatedIndicators/WaterWasteAndLandProtection/CompaniesWithoutSustainableLandOrAgriculturePractices**

|                   |  |
|-------------------|--|
| <p>diagram</p>    | <p>The diagram illustrates the structure of the <b>PercentageStrategyCoverageType1.1</b> element. On the left, a dashed box represents the parent element <b>CompaniesWithoutSustainable...</b>, with the description: "Exposure_To_Companies_Without_Sustainable_Land_Or_Agriculture_Practices_Policies (31840 - 31870)". This element is connected to a central connector, which in turn connects to a yellow box representing the <b>PercentageStrategyCoverageType1.1</b> element. This yellow box contains four sub-elements: <b>Value</b>, <b>ConsideredInInvestmentStrategy</b> (with the description: "Yes (= commitment of the asset manager to improve the PAI), No"), <b>Coverage</b> (with the description: "% of the notional / AUM, which provide effectively data, or where data could be estimated"), and <b>EligibleAssets</b> (with the description: "% of assets (versus notional / AUM), which could provide data").</p> |
| <p>type</p>       | <p><a href="#">PercentageStrategyCoverageType1.1</a></p>   |
| <p>properties</p> | <p>isRef 0<br/>minOcc 0<br/>maxOcc 1<br/>content complex</p>   |
| <p>children</p>   | <p><a href="#">Value</a> <a href="#">ConsideredInInvestmentStrategy</a> <a href="#">Coverage</a> <a href="#">EligibleAssets</a></p>  |
| <p>annotation</p> | <p>documentation<br/>Exposure_To_Companies_Without_Sustainable_Land_Or_Agriculture_Practices_Policies (31840 - 31870)</p>  |

element

**EETReportType1.1.1/PrincipalAdverseIndicators/MoreClimateAndEnvironmentRelatedIndicators/WaterWasteAndLandProtection/CompaniesWithoutSustainableOceansSeasPractices**

|                   |   |
|-------------------|---|
| <p>diagram</p>    |   |
| <p>type</p>       | <p><a href="#">PercentageStrategyCoverageType1.1</a></p>  |
| <p>properties</p> | <p>isRef 0<br/>minOcc 0<br/>maxOcc 1<br/>content complex</p>  |
| <p>children</p>   | <p><a href="#">Value</a> <a href="#">ConsideredInInvestmentStrategy</a> <a href="#">Coverage</a> <a href="#">EligibleAssets</a></p> |
| <p>annotation</p> | <p>documentation<br/>Share_Of_Investments_In_Companies_Without_Sustainable_Oceans_Or_Seas_Practices (31871 - 31874)</p>             |

element

**EETReportType1.1.1/PrincipalAdverseIndicators/MoreClimateAndEnvironmentRelatedIndicators/WaterWasteAndLandProtection/NonRecycledWasteRatio**

|                |  |
|----------------|--|
| <p>diagram</p> |  |
|----------------|--|

|            |  |
|------------|--|
| type       | <a href="#">ValueStrategyCoverageType1.1</a>   |
| properties | isRef 0<br>minOcc 0<br>maxOcc 1<br>content complex   |
| children   | <a href="#">Value</a> <a href="#">ConsideredInInvestmentStrategy</a> <a href="#">Coverage</a> <a href="#">EligibleAssets</a> |
| annotation | documentation<br>Non_Recycled_Waste_Ratio (31875 - 31878)  |

element

**EETReportType1.1.1/PrincipalAdverseIndicators/MoreClimateAndEnvironmentRelatedIndicators/WaterWasteAndLandProtection/CompaniesWhoseOperationsAffectThreatenedSpecies**

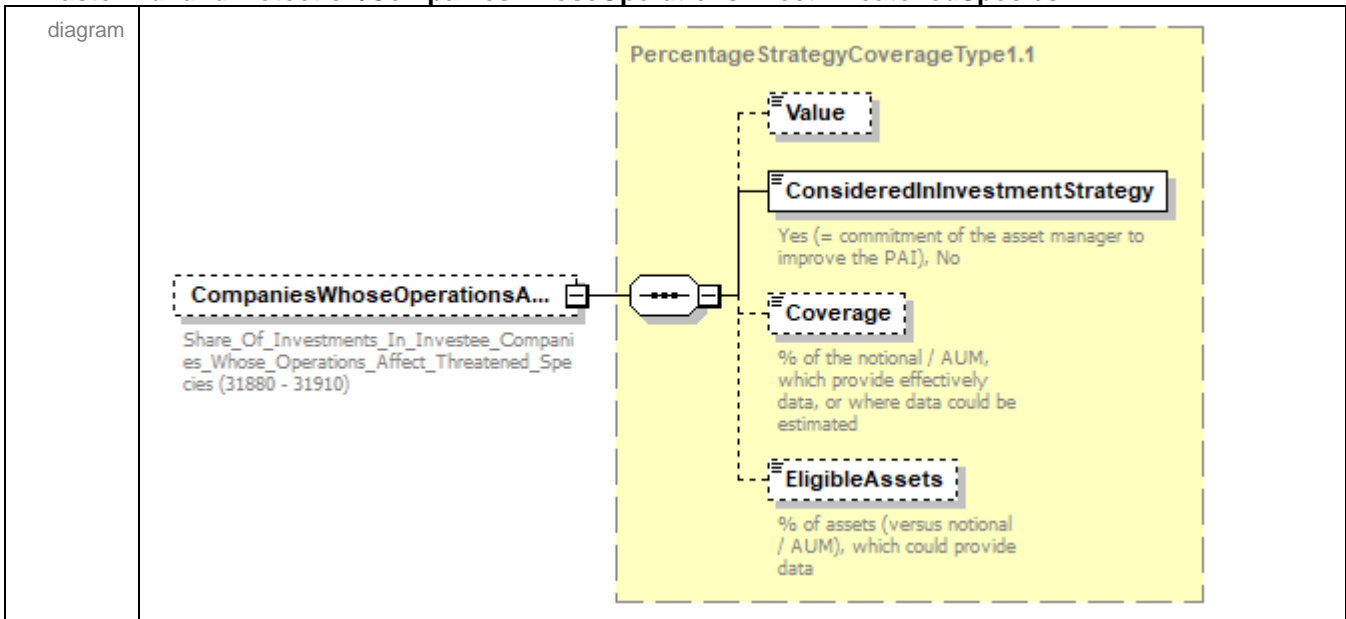

|            |  |
|------------|--|
| type       | <a href="#">PercentageStrategyCoverageType1.1</a>  |
| properties | isRef 0<br>minOcc 0<br>maxOcc 1<br>content complex   |
| children   | <a href="#">Value</a> <a href="#">ConsideredInInvestmentStrategy</a> <a href="#">Coverage</a> <a href="#">EligibleAssets</a> |
| annotation | documentation<br>Share_Of_Investments_In_Investee_Companies_Whose_Operations_Affect_Threatened_Species (31880 - 31910)       |

element

**EETReportType1.1/PrincipalAdverseIndicators/MoreClimateAndEnvironmentRelatedIndicators/Water  
WasteAndLandProtection/CompaniesWithoutBiodiversityProtection**

|                   |   |
|-------------------|---|
| <p>diagram</p>    |   |
| <p>type</p>       | <p><a href="#">PercentageStrategyCoverageType1.1</a></p>  |
| <p>properties</p> | <p>isRef 0<br/>minOcc 0<br/>maxOcc 1<br/>content complex</p>  |
| <p>children</p>   | <p><a href="#">Value</a> <a href="#">ConsideredInInvestmentStrategy</a> <a href="#">Coverage</a> <a href="#">EligibleAssets</a></p>   |
| <p>annotation</p> | <p>documentation<br/>Share_Of_Investments_In_Investee_Companies_Without_A_Biodiversity_Protection_Policy_Covering_Operational_Sites_Owned_Leased_Managed_In_Or_Adjacent_To_A_Protected_Area_Or_An_Area_Of_High_Biodiversity_Value_Outside_Protected_Areas (31920 - 31950)</p> |

element

**EETReportType1.1/PrincipalAdverseIndicators/MoreClimateAndEnvironmentRelatedIndicators/Water WasteAndLandProtection/CompaniesWithoutDeforestationPolicy**

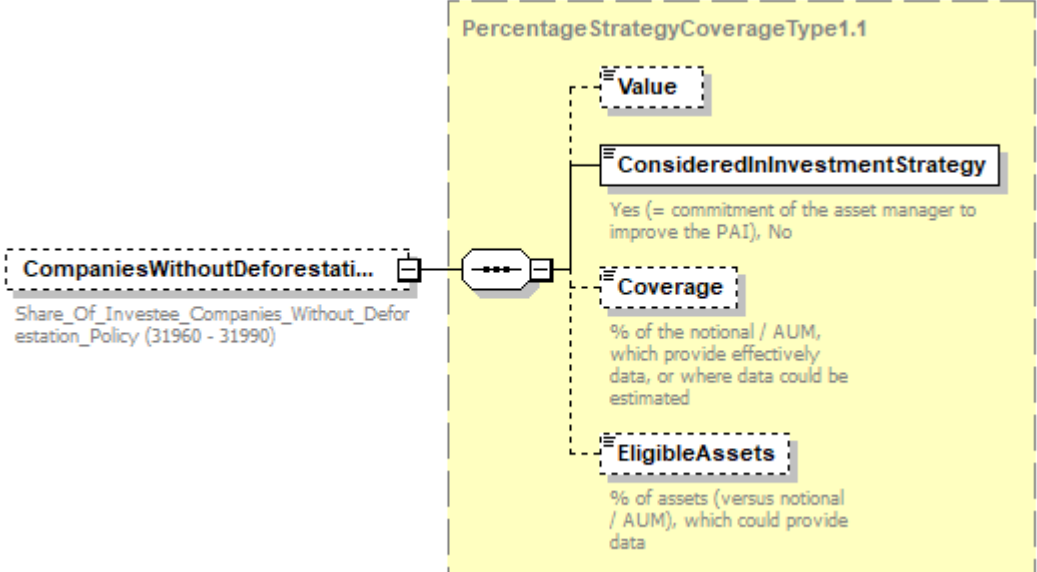
|                   |  |
|-------------------|--|
| <p>diagram</p>    |  <p><b>CompaniesWithoutDeforestationPolicy</b><br/>Share_Of_Investee_Companies_Without_Deforestation_Policy (31960 - 31990)</p> <p><b>PercentageStrategyCoverageType1.1</b></p> <ul style="list-style-type: none"> <li><b>Value</b></li> <li><b>ConsideredInInvestmentStrategy</b><br/>Yes (= commitment of the asset manager to improve the PAI), No</li> <li><b>Coverage</b><br/>% of the notional / AUM, which provide effectively data, or where data could be estimated</li> <li><b>EligibleAssets</b><br/>% of assets (versus notional / AUM), which could provide data</li> </ul> |
| <p>type</p>       | <p><a href="#">PercentageStrategyCoverageType1.1</a></p>   |
| <p>properties</p> | <p>isRef 0<br/>minOcc 0<br/>maxOcc 1<br/>content complex</p>   |
| <p>children</p>   | <p><a href="#">Value</a> <a href="#">ConsideredInInvestmentStrategy</a> <a href="#">Coverage</a> <a href="#">EligibleAssets</a></p>  |
| <p>annotation</p> | <p>documentation<br/>Share_Of_Investee_Companies_Without_Deforestation_Policy (31960 - 31990)</p>  |

element

**EETReportType1.1/PrincipalAdverseIndicators/MoreClimateAndEnvironmentRelatedIndicators/Green Securities**

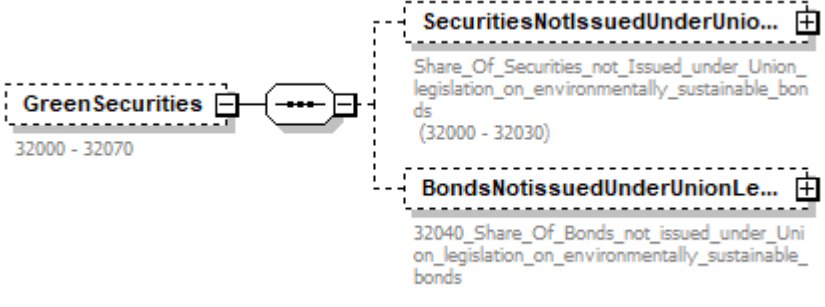
|                   |   |
|-------------------|---|
| <p>diagram</p>    |  <p><b>GreenSecurities</b><br/>32000 - 32070</p> <ul style="list-style-type: none"> <li><b>SecuritiesNotIssuedUnderUnionLegislationOnEnvironmentallySustainableBonds</b><br/>Share_Of_Securities_not_Issued_under_Union_legislation_on_environmentally_sustainable_bonds (32000 - 32030)</li> <li><b>BondsNotIssuedUnderUnionLegislationOnEnvironmentallySustainableBonds</b><br/>32040_Share_Of_Bonds_not_issued_under_Union_legislation_on_environmentally_sustainable_bonds</li> </ul> |
| <p>properties</p> | <p>isRef 0<br/>minOcc 0<br/>maxOcc 1<br/>content complex</p>  |
| <p>children</p>   | <p><a href="#">SecuritiesNotIssuedUnderUnionLegislationOnEnvironmentallySustainableBonds</a><br/><a href="#">BondsNotIssuedUnderUnionLegislationOnEnvironmentallySustainableBonds</a></p>   |
| <p>annotation</p> | <p>documentation<br/>32000 - 32070</p>  |

element

**EETReportType1.1.1/PrincipalAdverseIndicators/MoreClimateAndEnvironmentRelatedIndicators/Green Securities/SecuritiesNotIssuedUnderUnionLegislationOnEnvironmentallySustainableBonds**

|                   |  |
|-------------------|--|
| <p>diagram</p>    | <p>The diagram illustrates the structure of the element <b>SecuritiesNotIssuedUnderUnionLegislationOnEnvironmentallySustainableBonds</b>. It is a complex type with four children: <b>Value</b>, <b>ConsideredInInvestmentStrategy</b>, <b>Coverage</b>, and <b>EligibleAssets</b>. The diagram is titled <b>PercentageStrategyCoverageType1.1</b>.</p> <p><b>SecuritiesNotIssuedUnderUnionLegislationOnEnvironmentallySustainableBonds</b><br/>     Share_Of_Securities_not_Issued_under_Union_legislation_on_environmentally_sustainable_bonds<br/>     (32000 - 32030)</p> <p><b>Value</b></p> <p><b>ConsideredInInvestmentStrategy</b><br/>     Yes (= commitment of the asset manager to improve the PAI), No</p> <p><b>Coverage</b><br/>     % of the notional / AUM, which provide effectively data, or where data could be estimated</p> <p><b>EligibleAssets</b><br/>     % of assets (versus notional / AUM), which could provide data</p> |
| <p>type</p>       | <p><a href="#">PercentageStrategyCoverageType1.1</a></p>   |
| <p>properties</p> | <p>isRef 0<br/>         minOcc 0<br/>         maxOcc 1<br/>         content complex</p>  |
| <p>children</p>   | <p><a href="#">Value</a> <a href="#">ConsideredInInvestmentStrategy</a> <a href="#">Coverage</a> <a href="#">EligibleAssets</a></p>  |
| <p>annotation</p> | <p>documentation<br/>         Share_Of_Securities_not_Issued_under_Union_legislation_on_environmentally_sustainable_bonds<br/>         (32000 - 32030)</p>   |

element

**EETReportType1.1.1/PrincipalAdverseIndicators/MoreClimateAndEnvironmentRelatedIndicators/Green Securities/BondsNotissuedUnderUnionLegislationOnEnvironmentallySustainableBonds**

|            |  |
|------------|--|
| diagram    |  |
| type       | <a href="#">PercentageStrategyCoverageType1.1</a>  |
| properties | isRef 0<br>minOcc 0<br>maxOcc 1<br>content complex   |
| children   | <a href="#">Value</a> <a href="#">ConsideredInInvestmentStrategy</a> <a href="#">Coverage</a> <a href="#">EligibleAssets</a> |
| annotation | documentation<br>32040_Share_Of_Bonds_not_issued_under_Union_legislation_on_environmentally_sustainable_bonds                |



element

**EETReportType1.1.1/PrincipalAdverseIndicators/MoreClimateAndEnvironmentRelatedIndicators/RealEstateInvestments**

|                   |   |
|-------------------|---|
| <p>diagram</p>    | <p>The diagram illustrates the structure of the 'RealEstateInvestments' element. It is a complex element (indicated by a dashed border and a plus icon) with a range of 32080 - 32430. It is connected to five child elements, each also shown as a complex element with a plus icon:         <ul style="list-style-type: none"> <li><b>GreenhouseGasEmissions</b> (32080 - 32270): GHG_Emissions_Real_Estate (32080 - 32270)</li> <li><b>EnergyConsumptionIntensity</b> (32280 - 32310): Energy_Consumption_Intensity_Value (32280 - 32310)</li> <li><b>WasteProductionInOperations</b> (32320 - 32350): Waste_Production_In_Operations (32320 - 32350)</li> <li><b>RawMaterialConsumptionForNewConstructionAndMajorRenovations</b> (32360 - 32390): Raw_Material_Consumption_For_New_Construction_And_Major_Renovations (32360 - 32390)</li> <li><b>LandArtificialisation</b> (32400 - 32430): Land_Artificialisation (32400 - 32430)</li> </ul> </p> |
| <p>properties</p> | <p>isRef 0<br/>minOcc 0<br/>maxOcc 1<br/>content complex</p>  |
| <p>children</p>   | <p><a href="#">GreenhouseGasEmissions</a> <a href="#">EnergyConsumptionIntensity</a> <a href="#">WasteProductionInOperations</a> <a href="#">RawMaterialConsumptionForNewConstructionAndMajorRenovations</a> <a href="#">LandArtificialisation</a></p>  |
| <p>annotation</p> | <p>documentation<br/>32080 - 32430</p>  |

element

**EETReportType1.1.1/PrincipalAdverseIndicators/MoreClimateAndEnvironmentRelatedIndicators/RealEstateInvestments/GreenhouseGasEmissions**

|                   |  |
|-------------------|--|
| <p>diagram</p>    | <p>The diagram illustrates the structure of the 'GreenhouseGasEmissions' element. It is a complex element (indicated by a dashed border and a plus icon) with a range of 32080 - 32270. It is connected to five child elements, each also shown as a complex element with a plus icon:         <ul style="list-style-type: none"> <li><b>Scope1</b></li> <li><b>Scope2</b></li> <li><b>Scope3</b></li> <li><b>TotalScope12</b></li> <li><b>TotalScope123</b></li> </ul> </p> |
| <p>properties</p> | <p>isRef 0<br/>minOcc 0<br/>maxOcc 1<br/>content complex</p>   |
| <p>children</p>   | <p><a href="#">Scope1</a> <a href="#">Scope2</a> <a href="#">Scope3</a> <a href="#">TotalScope12</a> <a href="#">TotalScope123</a></p>   |
| <p>annotation</p> | <p>documentation<br/>GHG_Emissions_Real_Estate (32080 - 32270)</p>   |

element

**EETReportType1.1.1/PrincipalAdverseIndicators/MoreClimateAndEnvironmentRelatedIndicators/RealEstateInvestments/GreenhouseGasEmissions/Scope1**

|            |  |
|------------|--|
| diagram    |  |
| type       | <a href="#">ValueStrategyCoverageType1.1</a>   |
| properties | isRef 0<br>minOcc 0<br>maxOcc 1<br>content complex   |
| children   | <a href="#">Value</a> <a href="#">ConsideredInInvestmentStrategy</a> <a href="#">Coverage</a> <a href="#">EligibleAssets</a> |

element

**EETReportType1.1.1/PrincipalAdverseIndicators/MoreClimateAndEnvironmentRelatedIndicators/RealEstateInvestments/GreenhouseGasEmissions/Scope2**

|         |  |
|---------|--|
| diagram |  |
|---------|--|

|            |  |
|------------|--|
| type       | <a href="#">ValueStrategyCoverageType1.1</a>   |
| properties | isRef 0<br>minOcc 0<br>maxOcc 1<br>content complex   |
| children   | <a href="#">Value</a> <a href="#">ConsideredInInvestmentStrategy</a> <a href="#">Coverage</a> <a href="#">EligibleAssets</a> |

element

**EETReportType1.1/PrincipalAdverseIndicators/MoreClimateAndEnvironmentRelatedIndicators/RealEstateInvestments/GreenhouseGasEmissions/Scope3**

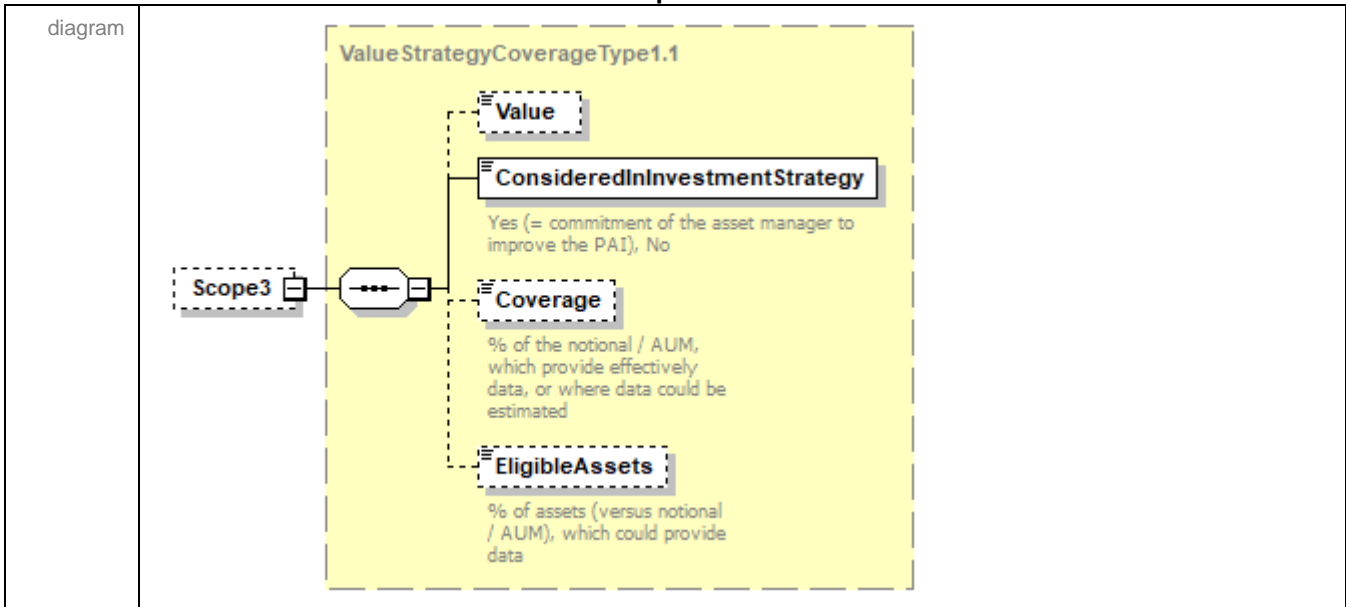

|            |  |
|------------|--|
| type       | <a href="#">ValueStrategyCoverageType1.1</a>   |
| properties | isRef 0<br>minOcc 0<br>maxOcc 1<br>content complex   |
| children   | <a href="#">Value</a> <a href="#">ConsideredInInvestmentStrategy</a> <a href="#">Coverage</a> <a href="#">EligibleAssets</a> |

element

**EETReportType1.1.1/PrincipalAdverseIndicators/MoreClimateAndEnvironmentRelatedIndicators/RealEstateInvestments/GreenhouseGasEmissions/TotalScope12**

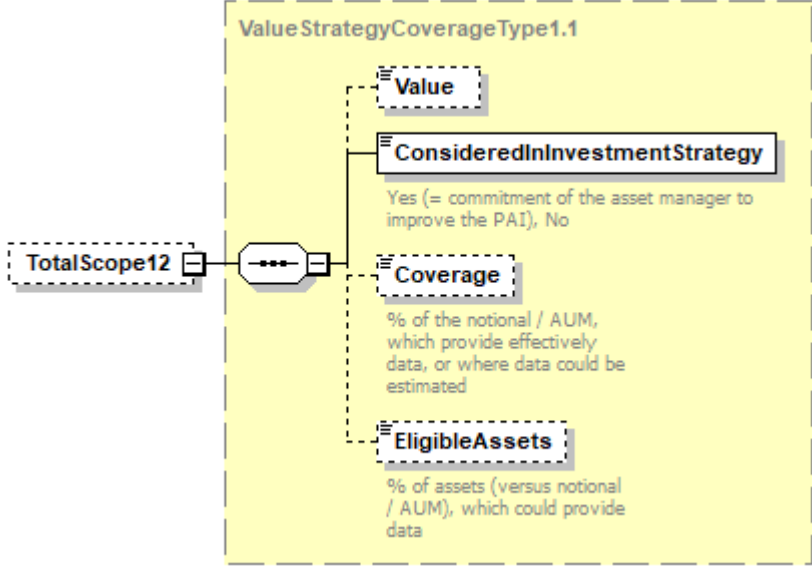
|            |  |
|------------|--|
| diagram    |  <p>The diagram shows a hierarchical structure for 'ValueStrategyCoverageType1.1'. A dashed box labeled 'TotalScope12' is connected to a central octagonal connector. This connector branches into three sub-elements: 'Value', 'ConsideredInInvestmentStrategy', and 'Coverage'. 'Value' is a simple box. 'ConsideredInInvestmentStrategy' is a box with the text 'Yes (= commitment of the asset manager to improve the PAI), No'. 'Coverage' is a box with the text '% of the notional / AUM, which provide effectively data, or where data could be estimated'. 'EligibleAssets' is a box with the text '% of assets (versus notional / AUM), which could provide data'. The entire structure is enclosed in a yellow dashed box labeled 'ValueStrategyCoverageType1.1'.</p> |
| type       | <a href="#">ValueStrategyCoverageType1.1</a>   |
| properties | isRef 0<br>minOcc 0<br>maxOcc 1<br>content complex   |
| children   | <a href="#">Value</a> <a href="#">ConsideredInInvestmentStrategy</a> <a href="#">Coverage</a> <a href="#">EligibleAssets</a>   |

element

**EETReportType1.1.1/PrincipalAdverseIndicators/MoreClimateAndEnvironmentRelatedIndicators/RealEstateInvestments/GreenhouseGasEmissions/TotalScope123**

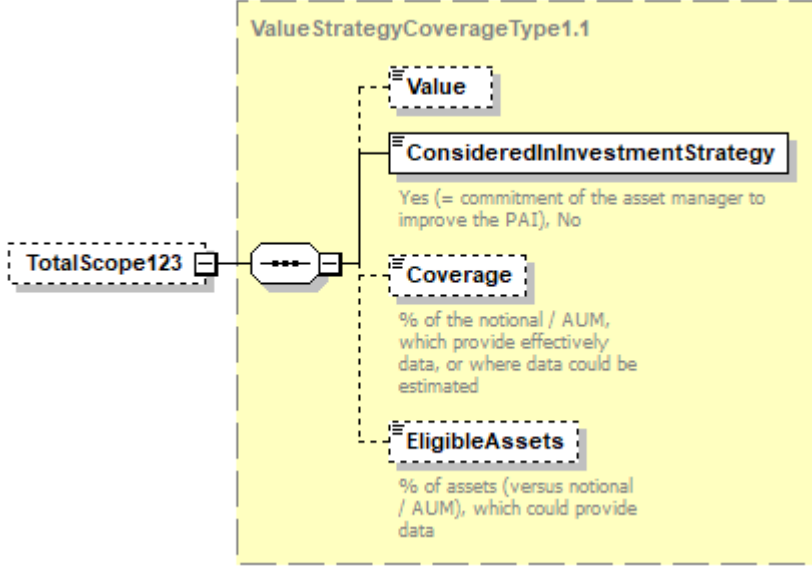
|         |   |
|---------|---|
| diagram |  <p>The diagram shows a hierarchical structure for 'ValueStrategyCoverageType1.1'. A dashed box labeled 'TotalScope123' is connected to a central octagonal connector. This connector branches into three sub-elements: 'Value', 'ConsideredInInvestmentStrategy', and 'Coverage'. 'Value' is a simple box. 'ConsideredInInvestmentStrategy' is a box with the text 'Yes (= commitment of the asset manager to improve the PAI), No'. 'Coverage' is a box with the text '% of the notional / AUM, which provide effectively data, or where data could be estimated'. 'EligibleAssets' is a box with the text '% of assets (versus notional / AUM), which could provide data'. The entire structure is enclosed in a yellow dashed box labeled 'ValueStrategyCoverageType1.1'.</p> |
| type    | <a href="#">ValueStrategyCoverageType1.1</a>  |

|            |  |
|------------|--|
| properties | isRef 0<br>minOcc 0<br>maxOcc 1<br>content complex   |
| children   | <a href="#">Value</a> <a href="#">ConsideredInInvestmentStrategy</a> <a href="#">Coverage</a> <a href="#">EligibleAssets</a> |

element

**EETReportType1.1.1/PrincipalAdverseIndicators/MoreClimateAndEnvironmentRelatedIndicators/RealEstateInvestments/EnergyConsumptionIntensity**

|            |  |
|------------|--|
| diagram    |  |
| type       | <a href="#">ValueStrategyCoverageType1.1</a>   |
| properties | isRef 0<br>minOcc 0<br>maxOcc 1<br>content complex   |
| children   | <a href="#">Value</a> <a href="#">ConsideredInInvestmentStrategy</a> <a href="#">Coverage</a> <a href="#">EligibleAssets</a> |
| annotation | documentation<br>Energy_Consumption_Intensity_Value<br>(32280 - 32310)   |

element

**EETReportType1.1.1/PrincipalAdverseIndicators/MoreClimateAndEnvironmentRelatedIndicators/RealEstateInvestments/WasteProductionInOperations**

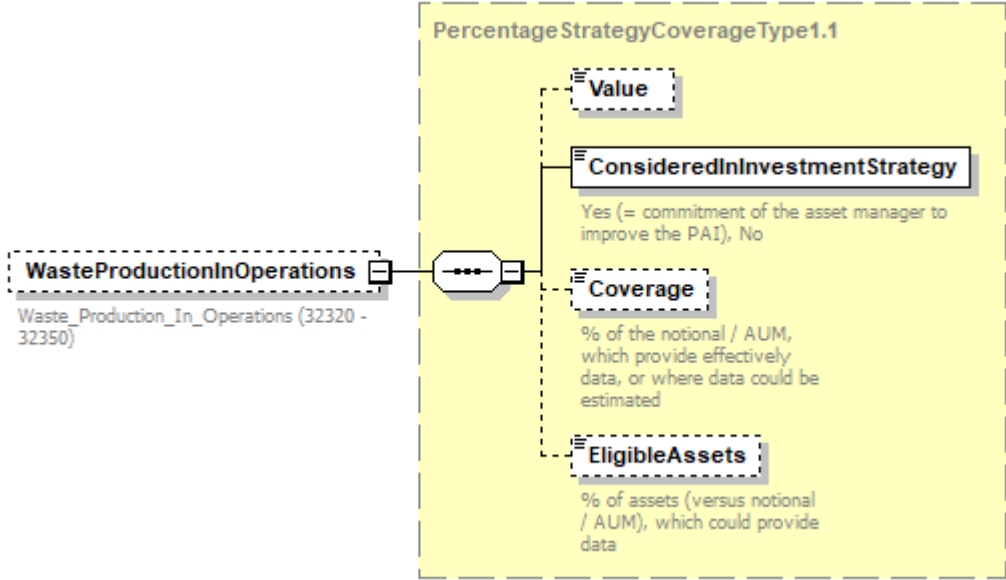
|                   |   |
|-------------------|---|
| <p>diagram</p>    |   |
| <p>type</p>       | <p><a href="#">PercentageStrategyCoverageType1.1</a></p>  |
| <p>properties</p> | <p>isRef 0<br/>minOcc 0<br/>maxOcc 1<br/>content complex</p>  |
| <p>children</p>   | <p><a href="#">Value</a> <a href="#">ConsideredInInvestmentStrategy</a> <a href="#">Coverage</a> <a href="#">EligibleAssets</a></p> |
| <p>annotation</p> | <p>documentation<br/>Waste_Production_In_Operations (32320 - 32350)</p>   |

element

**EETReportType1.1.1/PrincipalAdverseIndicators/MoreClimateAndEnvironmentRelatedIndicators/RealEstateInvestments/RawMaterialConsumptionForNewConstructionAndMajorRenovations**

|                   |  |
|-------------------|--|
| <p>diagram</p>    |  |
| <p>type</p>       | <p><a href="#">PercentageStrategyCoverageType1.1</a></p>   |
| <p>properties</p> | <p>isRef 0<br/>minOcc 0<br/>maxOcc 1<br/>content complex</p>   |
| <p>children</p>   | <p><a href="#">Value</a> <a href="#">CoveredInInvestmentStrategy</a> <a href="#">Coverage</a> <a href="#">EligibleAssets</a></p> |
| <p>annotation</p> | <p>documentation<br/>Raw_Material_Consumption_For_New_Construction_And_Major_Renovations (32360 - 32390)</p>                     |

element

**EETReportType1.1.1/PrincipalAdverseIndicators/MoreClimateAndEnvironmentRelatedIndicators/RealEstateInvestments/LandArtificialisation**

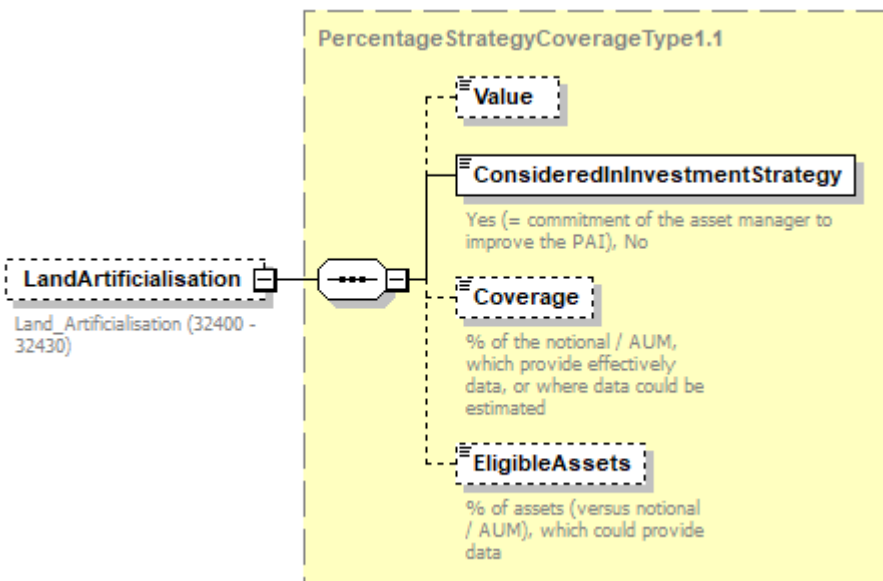
|                   |   |
|-------------------|---|
| <p>diagram</p>    |  <p>The diagram illustrates the structure of the <b>PercentageStrategyCoverageType1.1</b> element. It is connected to the <b>LandArtificialisation</b> element (ID range 32400 - 32430). The <b>PercentageStrategyCoverageType1.1</b> element contains four sub-elements: <b>Value</b>, <b>ConsideredInInvestmentStrategy</b> (with a description: "Yes (= commitment of the asset manager to improve the PAI), No"), <b>Coverage</b> (with a description: "% of the notional / AUM, which provide effectively data, or where data could be estimated"), and <b>EligibleAssets</b> (with a description: "% of assets (versus notional / AUM), which could provide data").</p> |
| <p>type</p>       | <p><a href="#">PercentageStrategyCoverageType1.1</a></p>  |
| <p>properties</p> | <p>isRef 0<br/>minOcc 0<br/>maxOcc 1<br/>content complex</p>  |
| <p>children</p>   | <p><a href="#">Value</a> <a href="#">ConsideredInInvestmentStrategy</a> <a href="#">Coverage</a> <a href="#">EligibleAssets</a></p>   |
| <p>annotation</p> | <p>documentation<br/>Land_Artificialisation (32400 - 32430)</p>   |

element **EETReportType1.1.1/PrincipalAdverseIndicators/MoreSocialAndEmployeeMatters**

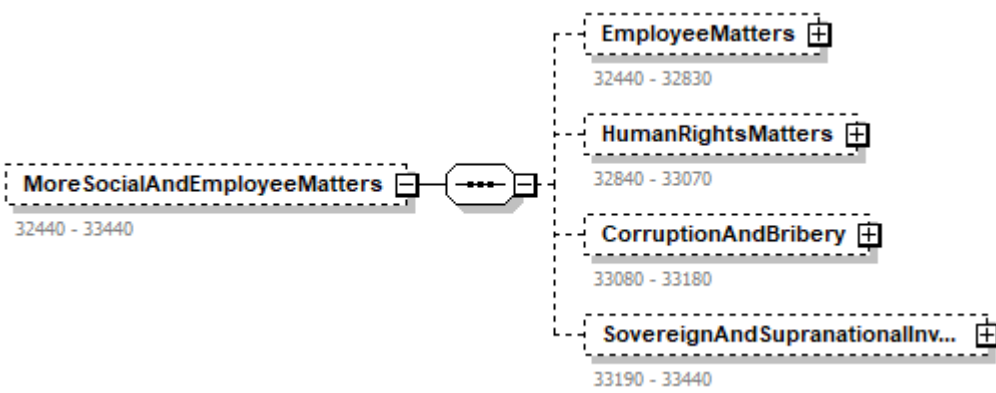
|                   |   |
|-------------------|---|
| <p>diagram</p>    |  <p>The diagram illustrates the structure of the <b>More SocialAndEmployeeMatters</b> element (ID range 32440 - 33440). It is connected to four sub-elements: <b>EmployeeMatters</b> (ID range 32440 - 32830), <b>HumanRightsMatters</b> (ID range 32840 - 33070), <b>CorruptionAndBribery</b> (ID range 33080 - 33180), and <b>SovereignAndSupranationalInv...</b> (ID range 33190 - 33440).</p> |
| <p>properties</p> | <p>isRef 0<br/>minOcc 0<br/>maxOcc 1<br/>content complex</p>  |
| <p>children</p>   | <p><a href="#">EmployeeMatters</a> <a href="#">HumanRightsMatters</a> <a href="#">CorruptionAndBribery</a> <a href="#">SovereignAndSupranationalInvestments</a></p>   |
| <p>annotation</p> | <p>documentation<br/>32440 - 33440</p>  |



element

**EETReportType1.1.1/PrincipalAdverseIndicators/MoreSocialAndEmployeeMatters/EmployeeMatters**

|                   |  |
|-------------------|--|
| <p>diagram</p>    | <p><b>EmployeeMatters</b> 32440 - 32830</p> <ul style="list-style-type: none"> <li><b>CompaniesWithoutWorkplaceA...</b> Exposure_To_Companies_Without_Workplace_Accident_Prevention_Policy (32440 - 32470)</li> <li><b>RateOfAccidents</b> Rate_Of_Accidents (32480 - 32510)</li> <li><b>NumberOfDaysLostForInjuries...</b> Number_Of_Days_Lost_For_Injuries_Accidents_Fatalities_Illness (32520 - 32550)</li> <li><b>CompaniesWithoutAnySupplier...</b> Share_Of_Investments_In_Investee_Companies_Without_Any_Supplier_Code_Of_Conduct_Against_Unsafe_Working_Conditions_Precarious_Work_Child_Labour_And_Forced_Labour (32560 - 32590)</li> <li><b>CompaniesWithoutAnyGrievan...</b> Share_Of_Investments_In_Investee_Companies_Without_Any_Grievance_Or_Complaints_Handling_Mechanism (32640 - 32670)</li> <li><b>CompaniesWithInsufficientWhi...</b> Share_Of_Investee_Companies_With_Insufficient_Whistleblower_Protection (32680 - 32710)</li> <li><b>NumberOfIncidentsOfDiscrimin...</b> Number_Of_Incidents_Of_Discrimination_Reported_In_Investee_Companies (32720 - 32750)</li> <li><b>NumberOfIncidentsOfDiscrimin...</b> Number_Of_Incidents_Of_Discrimination_Leading_To_Sanctions_In_Investee_Companies (32760 - 32790)</li> <li><b>ExcessiveCEOPayRatio</b> Excessive_CEO_Pay_Ratio (32800 - 32830)</li> </ul> |
| <p>properties</p> | <p>isRef 0<br/>minOcc 0<br/>maxOcc 1<br/>content complex</p>   |
| <p>children</p>   | <p><a href="#">CompaniesWithoutWorkplaceAccidentPreventionPolicy</a> <a href="#">RateOfAccidents</a> <a href="#">NumberOfDaysLostForInjuriesAccidentsFatalitiesIllness</a> <a href="#">CompaniesWithoutAnySupplierCodeOfConductAgainstUnsafeWorkingConditions</a> <a href="#">CompaniesWithoutAnyGrievanceOrComplaintsHandlingMechanism</a> <a href="#">CompaniesWithInsufficientWhistleblowerProtection</a> <a href="#">NumberOfIncidentsOfDiscriminationReported</a> <a href="#">NumberOfIncidentsOfDiscriminationLeadingToSanctions</a> <a href="#">ExcessiveCEOPayRatio</a></p>  |
| <p>annotation</p> | <p>documentation<br/>32440 - 32830</p>   |

element

**EETReportType1.1.1/PrincipalAdverseIndicators/MoreSocialAndEmployeeMatters/EmployeeMatters/CompaniesWithoutWorkplaceAccidentPreventionPolicy**

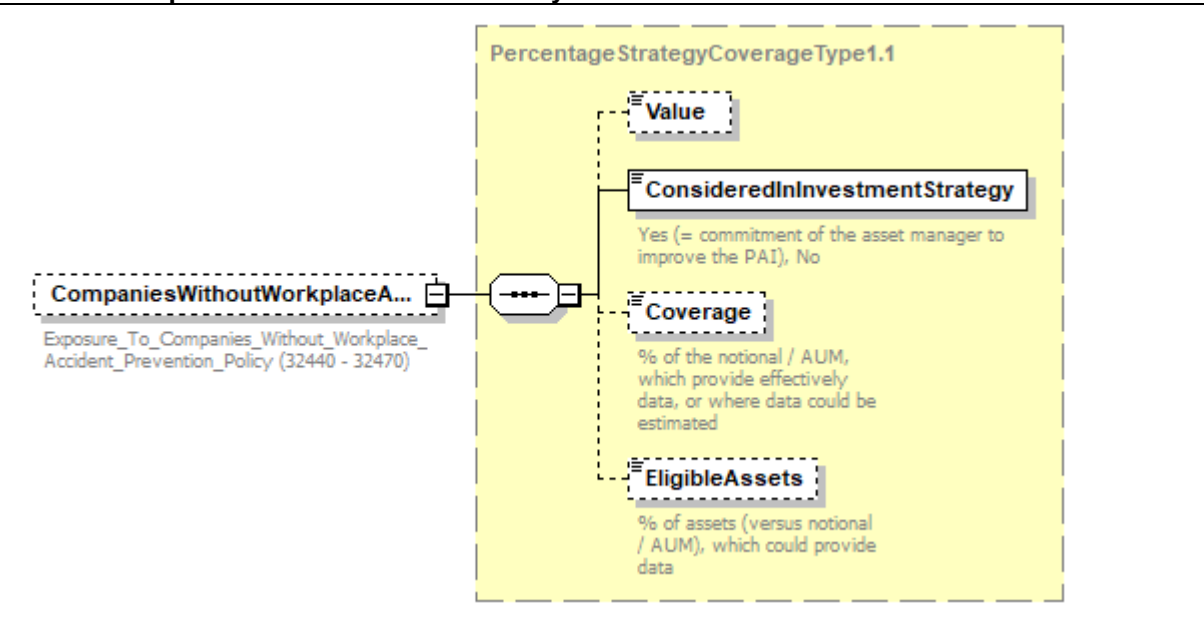
|            |   |
|------------|---|
| diagram    |  <p>The diagram shows a class structure for <b>PercentageStrategyCoverageType1.1</b>. On the left, a dashed box represents the class <b>CompaniesWithoutWorkplaceA...</b> with the ID <b>Exposure_To_Companies_Without_Workplace_Accident_Prevention_Policy (32440 - 32470)</b>. A solid line connects this class to a central octagonal connector. From this connector, three dashed lines branch out to the right, each leading to a sub-element: <b>Value</b>, <b>ConsideredInInvestmentStrategy</b>, and <b>EligibleAssets</b>. The <b>ConsideredInInvestmentStrategy</b> element is highlighted with a solid border and contains the text: "Yes (= commitment of the asset manager to improve the PAI), No". The <b>Coverage</b> element is highlighted with a dashed border and contains the text: "% of the notional / AUM, which provide effectively data, or where data could be estimated". The <b>EligibleAssets</b> element is highlighted with a dashed border and contains the text: "% of assets (versus notional / AUM), which could provide data".</p> |
| type       | <a href="#">PercentageStrategyCoverageType1.1</a>   |
| properties | isRef 0<br>minOcc 0<br>maxOcc 1<br>content complex  |
| children   | <a href="#">Value</a> <a href="#">ConsideredInInvestmentStrategy</a> <a href="#">Coverage</a> <a href="#">EligibleAssets</a>  |
| annotation | documentation<br>Exposure_To_Companies_Without_Workplace_Accident_Prevention_Policy (32440 - 32470)   |

element

**EETReportType1.1.1/PrincipalAdverseIndicators/MoreSocialAndEmployeeMatters/EmployeeMatters/RateOfAccidents**

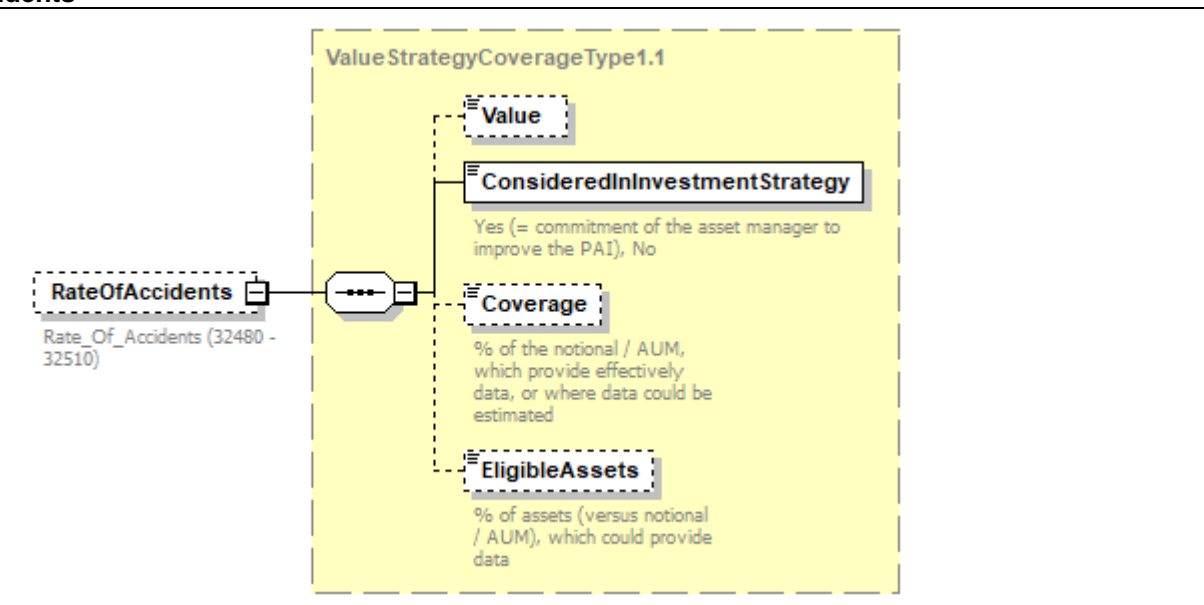
|         |   |
|---------|---|
| diagram |  <p>The diagram shows a class structure for <b>ValueStrategyCoverageType1.1</b>. On the left, a dashed box represents the class <b>RateOfAccidents</b> with the ID <b>Rate_Of_Accidents (32480 - 32510)</b>. A solid line connects this class to a central octagonal connector. From this connector, three dashed lines branch out to the right, each leading to a sub-element: <b>Value</b>, <b>ConsideredInInvestmentStrategy</b>, and <b>EligibleAssets</b>. The <b>ConsideredInInvestmentStrategy</b> element is highlighted with a solid border and contains the text: "Yes (= commitment of the asset manager to improve the PAI), No". The <b>Coverage</b> element is highlighted with a dashed border and contains the text: "% of the notional / AUM, which provide effectively data, or where data could be estimated". The <b>EligibleAssets</b> element is highlighted with a dashed border and contains the text: "% of assets (versus notional / AUM), which could provide data".</p> |
|---------|---|

|            |  |
|------------|--|
| type       | <a href="#">ValueStrategyCoverageType1.1</a>   |
| properties | isRef 0<br>minOcc 0<br>maxOcc 1<br>content complex   |
| children   | <a href="#">Value</a> <a href="#">ConsideredInInvestmentStrategy</a> <a href="#">Coverage</a> <a href="#">EligibleAssets</a> |
| annotation | documentation<br>Rate_Of_Accidents (32480 - 32510)   |

element

**EETReportType1.1/PrincipalAdverseIndicators/MoreSocialAndEmployeeMatters/EmployeeMatters/NumberOfDaysLostForInjuriesAccidentsFatalitiesIllness**

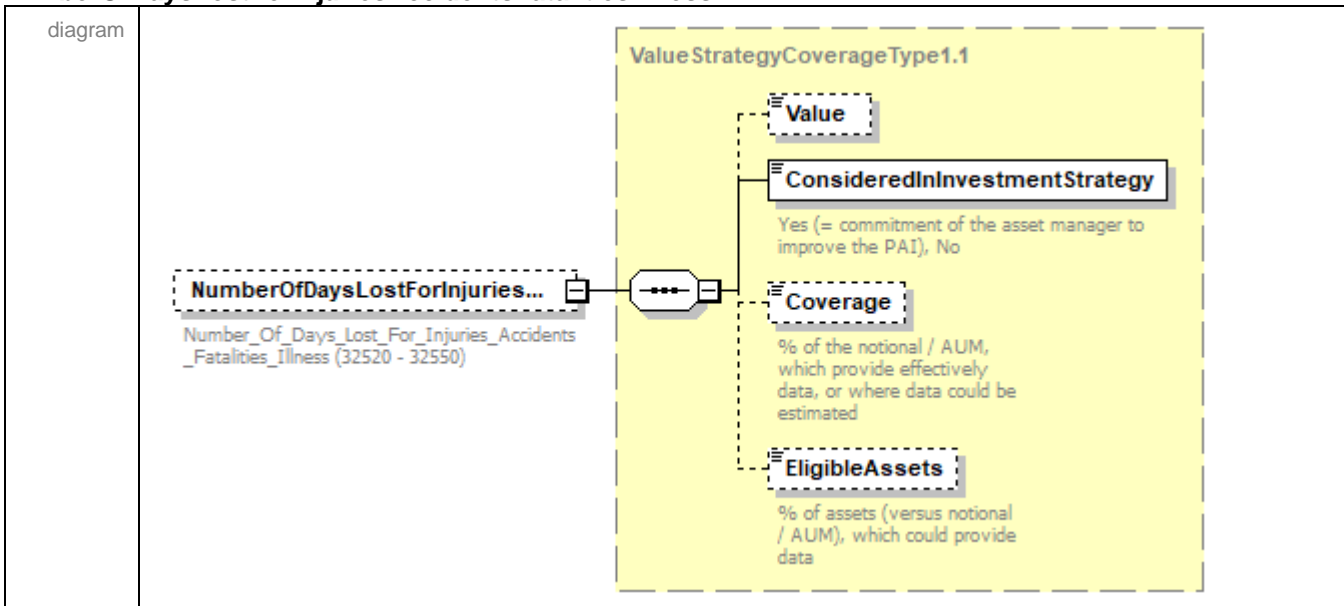

|            |  |
|------------|--|
| type       | <a href="#">ValueStrategyCoverageType1.1</a>   |
| properties | isRef 0<br>minOcc 0<br>maxOcc 1<br>content complex   |
| children   | <a href="#">Value</a> <a href="#">ConsideredInInvestmentStrategy</a> <a href="#">Coverage</a> <a href="#">EligibleAssets</a> |
| annotation | documentation<br>Number_Of_Days_Lost_For_Injuries_Accidents_Fatalities_Illness (32520 - 32550)                               |

element

**EETReportType1.1.1/PrincipalAdverseIndicators/MoreSocialAndEmployeeMatters/EmployeeMatters/CompaniesWithoutAnySupplierCodeOfConductAgainstUnsafeWorkingConditions**

|                   |   |
|-------------------|---|
| <p>diagram</p>    |   |
| <p>type</p>       | <p><a href="#">PercentageStrategyCoverageType1.1</a></p>  |
| <p>properties</p> | <p>isRef 0<br/>minOcc 0<br/>maxOcc 1<br/>content complex</p>  |
| <p>children</p>   | <p><a href="#">Value</a> <a href="#">ConsideredInInvestmentStrategy</a> <a href="#">Coverage</a> <a href="#">EligibleAssets</a></p>   |
| <p>annotation</p> | <p>documentation<br/>Share_Of_Investments_In_Investee_Companies_Without_Any_Supplier_Code_Of_Conduct_Against_Unsafe_Working_Conditions_Precarious_Work_Child_Labour_And_Forced_Labour (32560 - 32590)</p> |

element

**EETReportType1.1/PrincipalAdverseIndicators/MoreSocialAndEmployeeMatters/EmployeeMatters/CompaniesWithoutAnyGrievanceOrComplaintsHandlingMechanism**

|                   |  |
|-------------------|--|
| <p>diagram</p>    |  |
| <p>type</p>       | <p><a href="#">PercentageStrategyCoverageType1.1</a></p>   |
| <p>properties</p> | <p>isRef 0<br/>minOcc 0<br/>maxOcc 1<br/>content complex</p>   |
| <p>children</p>   | <p><a href="#">Value</a> <a href="#">ConsideredInInvestmentStrategy</a> <a href="#">Coverage</a> <a href="#">EligibleAssets</a></p>        |
| <p>annotation</p> | <p>documentation<br/>Share_Of_Investments_In_Investee_Companies_Without_Any_Grievance_Or_Complaints_Handling_Mechanism (32640 - 32670)</p> |

element

**EETReportType1.1.1/PrincipalAdverseIndicators/MoreSocialAndEmployeeMatters/EmployeeMatters/CompaniesWithInsufficientWhistleblowerProtection**

|                   |   |
|-------------------|---|
| <p>diagram</p>    |   |
| <p>type</p>       | <p><a href="#">PercentageStrategyCoverageType1.1</a></p>  |
| <p>properties</p> | <p>isRef 0<br/>minOcc 0<br/>maxOcc 1<br/>content complex</p>  |
| <p>children</p>   | <p><a href="#">Value</a> <a href="#">ConsideredInInvestmentStrategy</a> <a href="#">Coverage</a> <a href="#">EligibleAssets</a></p> |
| <p>annotation</p> | <p>documentation<br/>Share_Of_Investee_Companies_With_Insufficient_Whistleblower_Protection (32680 - 32710)</p>                     |

element

**EETReportType1.1.1/PrincipalAdverseIndicators/MoreSocialAndEmployeeMatters/EmployeeMatters/NumberOfIncidentsOfDiscriminationReported**

|                |  |
|----------------|--|
| <p>diagram</p> |  |
|----------------|--|

|            |  |
|------------|--|
| type       | <a href="#">ValueStrategyCoverageType1.1</a>   |
| properties | isRef 0<br>minOcc 0<br>maxOcc 1<br>content complex   |
| children   | <a href="#">Value</a> <a href="#">ConsideredInInvestmentStrategy</a> <a href="#">Coverage</a> <a href="#">EligibleAssets</a> |
| annotation | documentation<br>Number_Of_Incidents_Of_Discrimination_Reported_In_Investee_Companies (32720 - 32750)                        |

element

**EETReportType1.1.1/PrincipalAdverseIndicators/MoreSocialAndEmployeeMatters/EmployeeMatters/NumberOfIncidentsOfDiscriminationLeadingToSanctions**

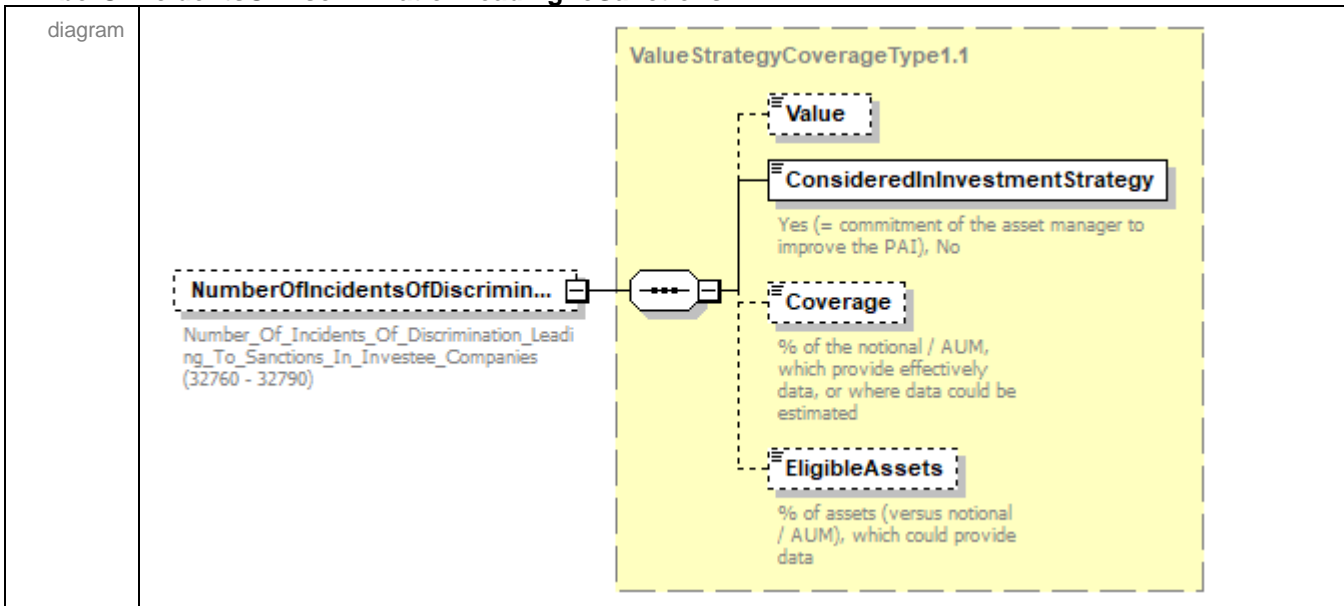

|            |  |
|------------|--|
| type       | <a href="#">ValueStrategyCoverageType1.1</a>   |
| properties | isRef 0<br>minOcc 0<br>maxOcc 1<br>content complex   |
| children   | <a href="#">Value</a> <a href="#">ConsideredInInvestmentStrategy</a> <a href="#">Coverage</a> <a href="#">EligibleAssets</a> |
| annotation | documentation<br>Number_Of_Incidents_Of_Discrimination_Leading_To_Sanctions_In_Investee_Companies (32760 - 32790)            |

element

**EETReportType1.1.1/PrincipalAdverseIndicators/MoreSocialAndEmployeeMatters/EmployeeMatters/ExcessiveCEOPayRatio**

|                   |   |
|-------------------|---|
| <p>diagram</p>    |   |
| <p>type</p>       | <p><a href="#">ValueStrategyCoverageType1.1</a></p>   |
| <p>properties</p> | <p>isRef 0<br/>minOcc 0<br/>maxOcc 1<br/>content complex</p>  |
| <p>children</p>   | <p><a href="#">Value</a> <a href="#">ConsideredInvestmentStrategy</a> <a href="#">Coverage</a> <a href="#">EligibleAssets</a></p> |
| <p>annotation</p> | <p>documentation<br/>Excessive_CEO_Pay_Ratio (32800 - 32830)</p>  |



element

**EETReportType1.1.1/PrincipalAdverseIndicators/MoreSocialAndEmployeeMatters/HumanRightsMatters**

|                   |  |
|-------------------|--|
| <p>diagram</p>    | <pre> classDiagram     class HumanRightsMatters {         32840 - 33070     }     class CompaniesWithoutHumanRightPolicy {         32840 - 32870     }     class CompaniesWithLackOfDueDiligence {         32880 - 32910     }     class CompaniesWithoutSufficientHumanTraffickingPrevention {         32920 - 32950     }     class CompaniesOperationsSuppliersSignificantRiskChildLabour {         32960 - 32990     }     class CompaniesOperationsSuppliersSignificantRiskForcedLabour {         33000 - 33030     }     class NumberOfCasesOfSevereHumanRightsIssues {         33040 - 33070     }     HumanRightsMatters --&gt; CompaniesWithoutHumanRightPolicy     HumanRightsMatters --&gt; CompaniesWithLackOfDueDiligence     HumanRightsMatters --&gt; CompaniesWithoutSufficientHumanTraffickingPrevention     HumanRightsMatters --&gt; CompaniesOperationsSuppliersSignificantRiskChildLabour     HumanRightsMatters --&gt; CompaniesOperationsSuppliersSignificantRiskForcedLabour     HumanRightsMatters --&gt; NumberOfCasesOfSevereHumanRightsIssues     </pre> |
| <p>properties</p> | <p>isRef 0<br/> minOcc 0<br/> maxOcc 1<br/> content complex</p>  |
| <p>children</p>   | <p><a href="#">CompaniesWithoutHumanRightPolicy</a> <a href="#">CompaniesWithLackOfDueDiligence</a><br/> <a href="#">CompaniesWithoutSufficientHumanTraffickingPrevention</a><br/> <a href="#">CompaniesOperationsSuppliersSignificantRiskChildLabour</a><br/> <a href="#">CompaniesOperationsSuppliersSignificantRiskForcedLabour</a> <a href="#">NumberOfCasesOfSevereHumanRightsIssues</a></p>  |
| <p>annotation</p> | <p>documentation<br/> 32840 - 33070</p>  |

element

**EETReportType1.1.1/PrincipalAdverseIndicators/MoreSocialAndEmployeeMatters/HumanRightsMatters/CompaniesWithoutHumanRightPolicy**

|                   |   |
|-------------------|---|
| <p>diagram</p>    |   |
| <p>type</p>       | <p><a href="#">PercentageStrategyCoverageType1.1</a></p>  |
| <p>properties</p> | <p>isRef 0<br/>minOcc 0<br/>maxOcc 1<br/>content complex</p>  |
| <p>children</p>   | <p><a href="#">Value</a> <a href="#">ConsideredInInvestmentStrategy</a> <a href="#">Coverage</a> <a href="#">EligibleAssets</a></p> |
| <p>annotation</p> | <p>documentation<br/>Exposure_To_Companies_Without_Human_Right_Policy (32840 - 32870)</p>   |

element

**EETReportType1.1.1/PrincipalAdverseIndicators/MoreSocialAndEmployeeMatters/HumanRightsMatters/CompaniesWithLackOfDueDiligence**

|                   |   |
|-------------------|---|
| <p>diagram</p>    |   |
| <p>type</p>       | <p><a href="#">PercentageStrategyCoverageType1.1</a></p>  |
| <p>properties</p> | <p>isRef 0<br/>minOcc 0<br/>maxOcc 1<br/>content complex</p>  |
| <p>children</p>   | <p><a href="#">Value</a> <a href="#">ConsideredInInvestmentStrategy</a> <a href="#">Coverage</a> <a href="#">EligibleAssets</a></p> |
| <p>annotation</p> | <p>documentation<br/>Exposure_To_Companies_With_Lack_Of_Due_Diligence (32880 - 32910)</p>   |

element

**EETReportType1.1/PrincipalAdverseIndicators/MoreSocialAndEmployeeMatters/HumanRightsMatters/CompaniesWithoutSufficientHumanTraffickingPrevention**

|                   |  |
|-------------------|--|
| <p>diagram</p>    |  |
| <p>type</p>       | <p><a href="#">PercentageStrategyCoverageType1.1</a></p>   |
| <p>properties</p> | <p>isRef 0<br/>minOcc 0<br/>maxOcc 1<br/>content complex</p>   |
| <p>children</p>   | <p><a href="#">Value</a> <a href="#">CoveredInInvestmentStrategy</a> <a href="#">Coverage</a> <a href="#">EligibleAssets</a></p>                   |
| <p>annotation</p> | <p>documentation<br/>Exposure_To_Companies_With_Lack_Of_Proceses_And_Measures_For_Preventing_Trafficking_In_Human_Beings_Local (32920 - 32950)</p> |

element

**EETReportType1.1.1/PrincipalAdverseIndicators/MoreSocialAndEmployeeMatters/HumanRightsMatters/CompaniesOperationsSuppliersSignificantRiskChildLabour**

|                   |   |
|-------------------|---|
| <p>diagram</p>    |   |
| <p>type</p>       | <p><a href="#">PercentageStrategyCoverageType1.1</a></p>  |
| <p>properties</p> | <p>isRef 0<br/>minOcc 0<br/>maxOcc 1<br/>content complex</p>  |
| <p>children</p>   | <p><a href="#">Value</a> <a href="#">ConsideredInInvestmentStrategy</a> <a href="#">Coverage</a> <a href="#">EligibleAssets</a></p>           |
| <p>annotation</p> | <p>documentation<br/>Exposure_To_Companies_With_Operations_And_Suppliers_At_Significant_Risk_Of_Incidents_Of_Child_Labour (32960 - 32990)</p> |

element

**EETReportType1.1.1/PrincipalAdverseIndicators/MoreSocialAndEmployeeMatters/HumanRightsMatters/CompaniesOperationsSuppliersSignificantRiskForcedLabour**

|                   |  |
|-------------------|--|
| <p>diagram</p>    | <p>The diagram illustrates the structure of the <b>PercentageStrategyCoverageType1.1</b> element. It features a central node connected to a dashed box labeled <b>CompaniesOperationsSupplier...</b> with the text: <i>Exposure_To_Companies_With_Operations_And_Suppliers_At_Significant_Risk_Of_Incidents_Of_Forced_Or_Compulsory_Labour (33000 - 33030)</i>. To the right, a yellow box titled <b>PercentageStrategyCoverageType1.1</b> contains four sub-elements: <b>Value</b>, <b>ConsideredInInvestmentStrategy</b> (Yes (= commitment of the asset manager to improve the PAI), No), <b>Coverage</b> (% of the notional / AUM, which provide effectively data, or where data could be estimated), and <b>EligibleAssets</b> (% of assets (versus notional / AUM), which could provide data).</p> |
| <p>type</p>       | <p><a href="#">PercentageStrategyCoverageType1.1</a></p>   |
| <p>properties</p> | <p>isRef 0<br/>minOcc 0<br/>maxOcc 1<br/>content complex</p>   |
| <p>children</p>   | <p><a href="#">Value</a> <a href="#">ConsideredInInvestmentStrategy</a> <a href="#">Coverage</a> <a href="#">EligibleAssets</a></p>  |
| <p>annotation</p> | <p>documentation<br/><i>Exposure_To_Companies_With_Operations_And_Suppliers_At_Significant_Risk_Of_Incidents_Of_Forced_Or_Compulsory_Labour (33000 - 33030)</i></p>  |

element

**EETReportType1.1.1/PrincipalAdverseIndicators/MoreSocialAndEmployeeMatters/HumanRightsMatters/NumberOfCasesOfSevereHumanRightsIssues**

|                   |  |
|-------------------|--|
| <p>diagram</p>    | <p><b>ValueStrategyCoverageType1.1</b></p> <ul style="list-style-type: none"> <li><b>Value</b></li> <li><b>ConsideredInInvestmentStrategy</b><br/>Yes (= commitment of the asset manager to improve the PAI), No</li> <li><b>Coverage</b><br/>% of the notional / AUM, which provide effectively data, or where data could be estimated</li> <li><b>EligibleAssets</b><br/>% of assets (versus notional / AUM), which could provide data</li> </ul> <p><b>NumberOfCasesOfSevereHum...</b><br/>Number_Of_Identified_Cases_of_Severe_Human_Rights_Issues_And_Incidents (33040 - 33070)</p> |
| <p>type</p>       | <p><a href="#">ValueStrategyCoverageType1.1</a></p>  |
| <p>properties</p> | <p>isRef 0<br/>minOcc 0<br/>maxOcc 1<br/>content complex</p>   |
| <p>children</p>   | <p><a href="#">Value</a> <a href="#">ConsideredInInvestmentStrategy</a> <a href="#">Coverage</a> <a href="#">EligibleAssets</a></p>  |
| <p>annotation</p> | <p>documentation<br/>Number_Of_Identified_Cases_of_Severe_Human_Rights_Issues_And_Incidents (33040 - 33070)</p>  |

element

**EETReportType1.1.1/PrincipalAdverseIndicators/MoreSocialAndEmployeeMatters/CorruptionAndBribery**

|                   |  |
|-------------------|--|
| <p>diagram</p>    | <p><b>CorruptionAndBribery</b><br/>33080 - 33180</p> <ul style="list-style-type: none"> <li><b>CompaniesWithLackOfAntiCorr...</b><br/>Exposure_To_Companies_With_A_lack_Of_Anti_Corruption_And_Anti_Bribery_Policies (33080 - 33110)</li> <li><b>CompaniesInsufficientReaction...</b><br/>Exposure_To_Companies_With_Cases_Of_Insufficient_Action_Taken_To_Address_Breaches_Of_Standards_Of_Anti_Corruption_And_Anti_Bribery (33120 - 33145)</li> <li><b>ConvictionsOfAntiCorruptionA...</b><br/>Number_Of_Convictions_For_Violation_Of_Anti_Corruption_And_Anti_Bribery_Laws (33150 - 33180)</li> </ul> |
| <p>properties</p> | <p>isRef 0<br/>minOcc 0<br/>maxOcc 1<br/>content complex</p>   |
| <p>children</p>   | <p><a href="#">CompaniesWithLackOfAntiCorruptionAndAntiBriberyPolicies</a></p>   |

|            |  |
|------------|--|
|            | <a href="#">CompaniesInsufficientReactionsOnCorruptionAndBribery ConvictionsOfAntiCorruptionAndAntiBriberyLaws</a> |
| annotation | documentation<br>33080 - 33180   |

element

**EETReportType1.1/PrincipalAdverseIndicators/MoreSocialAndEmployeeMatters/CorruptionAndBribery/CompaniesWithLackOfAntiCorruptionAndAntiBriberyPolicies**

|            |  |
|------------|--|
| diagram    |  |
| type       | <a href="#">PercentageStrategyCoverageType1.1</a>  |
| properties | isRef 0<br>minOcc 0<br>maxOcc 1<br>content complex   |
| children   | <a href="#">Value</a> <a href="#">ConsideredInInvestmentStrategy</a> <a href="#">Coverage</a> <a href="#">EligibleAssets</a> |
| annotation | documentation<br>Exposure_To_Companies_With_A_lack_Of_Anti_Corruption_And_Anti_Bribery_Policies (33080 - 33110)              |



element

**EETReportType1.1.1/PrincipalAdverseIndicators/MoreSocialAndEmployeeMatters/CorruptionAndBribery/CompaniesInsufficientReactionsOnCorruptionAndBribery**

|                   |   |
|-------------------|---|
| <p>diagram</p>    |   |
| <p>type</p>       | <p><a href="#">PercentageStrategyCoverageType1.1</a></p>  |
| <p>properties</p> | <p>isRef 0<br/>minOcc 0<br/>maxOcc 1<br/>content complex</p>  |
| <p>children</p>   | <p><a href="#">Value</a> <a href="#">CoveredInvestmentStrategy</a> <a href="#">Covered</a> <a href="#">EligibleAssets</a></p>   |
| <p>annotation</p> | <p>documentation<br/>Exposure_To_Companies_With_Cases_Of_Insufficient_Action_Taken_To_Address_Breaches_Of_Standards_Of_Anti_Corruption_And_Anti_Bribery (33120 - 33145)</p> |

element

**EETReportType1.1.1/PrincipalAdverseIndicators/MoreSocialAndEmployeeMatters/CorruptionAndBribery/ConvictionsOfAntiCorruptionAndAntiBriberyLaws**

|                   |   |
|-------------------|---|
| <p>diagram</p>    | <pre> classDiagram     class ConvictionsOfAntiCorruptionAndAntiBriberyLaws {         Number_Of_Convictions_For_Violation_Of_Anti_Corruption_And_Anti_Bribery_Laws (33150 - 33180)     }     class ValueStrategyCoverageType11 {         Value         ConsideredInInvestmentStrategy         Coverage         EligibleAssets     }     ConvictionsOfAntiCorruptionAndAntiBriberyLaws -- ValueStrategyCoverageType11     </pre> <p><b>ConvictionsOfAntiCorruptionAndAntiBriberyLaws</b><br/>     Number_Of_Convictions_For_Violation_Of_Anti_Corruption_And_Anti_Bribery_Laws (33150 - 33180)</p> <p><b>ValueStrategyCoverageType1.1</b></p> <ul style="list-style-type: none"> <li><b>Value</b></li> <li><b>ConsideredInInvestmentStrategy</b><br/>             Yes (= commitment of the asset manager to improve the PAI), No</li> <li><b>Coverage</b><br/>             % of the notional / AUM, which provide effectively data, or where data could be estimated</li> <li><b>EligibleAssets</b><br/>             % of assets (versus notional / AUM), which could provide data</li> </ul> |
| <p>type</p>       | <p><a href="#">ValueStrategyCoverageType1.1</a></p>   |
| <p>properties</p> | <p>isRef 0<br/>             minOcc 0<br/>             maxOcc 1<br/>             content complex</p>   |
| <p>children</p>   | <p><a href="#">Value</a> <a href="#">ConsideredInInvestmentStrategy</a> <a href="#">Coverage</a> <a href="#">EligibleAssets</a></p>   |
| <p>annotation</p> | <p>documentation<br/>             Number_Of_Convictions_For_Violation_Of_Anti_Corruption_And_Anti_Bribery_Laws (33150 - 33180)</p>  |

element

**EETReportType1.1.1/PrincipalAdverseIndicators/MoreSocialAndEmployeeMatters/SovereignAndSupranationalInvestments**

|                   |   |
|-------------------|---|
| <p>diagram</p>    | <p>The diagram shows a class <b>SovereignAndSupranationalInv...</b> (ID: 33190 - 33440) containing seven sub-classes, each in a dashed box with a plus icon:</p> <ul style="list-style-type: none"> <li><b>AverageIncomeInequalityScope</b> (33190 - 33220)</li> <li><b>AverageFreedomOfExpression...</b> (33230 - 33260)</li> <li><b>AverageHumanRightsPerforma...</b> (33265 - 33290)</li> <li><b>AverageCorruptionScore</b> (33295 - 33320)</li> <li><b>NonCooperativeTaxJurisdictions</b> (33330 - 33360)</li> <li><b>AveragePoliticalStabilityScore</b> (33370 - 33400)</li> <li><b>AverageRuleOfLawScore</b> (33410 - 33440)</li> </ul> |
| <p>properties</p> | <p>isRef 0<br/>minOcc 0<br/>maxOcc 1<br/>content complex</p>  |
| <p>children</p>   | <p><a href="#">AverageIncomeInequalityScope</a> <a href="#">AverageFreedomOfExpressionScore</a> <a href="#">AverageHumanRightsPerformance</a> <a href="#">AverageCorruptionScore</a> <a href="#">NonCooperativeTaxJurisdictions</a> <a href="#">AveragePoliticalStabilityScore</a> <a href="#">AverageRuleOfLawScore</a></p>  |
| <p>annotation</p> | <p>documentation<br/>33190 - 33440</p>  |

element

**EETReportType1.1.1/PrincipalAdverseIndicators/MoreSocialAndEmployeeMatters/SovereignAndSupranationalInvestments/AverageIncomeInequalityScope**

|            |  |
|------------|--|
| diagram    | <p>The diagram illustrates the structure of the <b>AverageIncomeInequalityScope</b> element. It is connected to a <b>Value Strategy Coverage Type 1.1</b> container. The container includes the following components:</p> <ul style="list-style-type: none"><li><b>Value</b>: A box representing the value of the scope.</li><li><b>Considered Investment Strategy</b>: A box with the description: "Yes (= commitment of the asset manager to improve the PAI), No".</li><li><b>Coverage</b>: A box with the description: "% of the notional / AUM, which provide effectively data, or where data could be estimated".</li><li><b>Eligible Assets</b>: A box with the description: "% of assets (versus notional / AUM), which could provide data".</li></ul> <p>The <b>AverageIncomeInequalityScope</b> element is defined as: <b>Average_Income_Inequality_Scope (33190 - 33220)</b>.</p> |
| type       | <a href="#">ValueStrategyCoverageType1.1</a>   |
| properties | isRef 0<br>minOcc 0<br>maxOcc 1<br>content complex   |
| children   | <a href="#">Value</a> <a href="#">ConsideredInvestmentStrategy</a> <a href="#">Coverage</a> <a href="#">EligibleAssets</a>   |
| annotation | documentation<br>Average_Income_Inequality_Scope (33190 - 33220)   |

element

**EETReportType1.1.1/PrincipalAdverseIndicators/MoreSocialAndEmployeeMatters/SovereignAndSupranationalInvestments/AverageFreedomOfExpressionScore**

|         |  |
|---------|--|
| diagram | <p>The diagram illustrates the structure of the <b>AverageFreedomOfExpressionScore</b> element. It is connected to a <b>Value Strategy Coverage Type 1.1</b> container. The container includes the following components:</p> <ul style="list-style-type: none"><li><b>Value</b>: A box representing the value of the score.</li><li><b>Considered Investment Strategy</b>: A box with the description: "Yes (= commitment of the asset manager to improve the PAI), No".</li><li><b>Coverage</b>: A box with the description: "% of the notional / AUM, which provide effectively data, or where data could be estimated".</li><li><b>Eligible Assets</b>: A box with the description: "% of assets (versus notional / AUM), which could provide data".</li></ul> <p>The <b>AverageFreedomOfExpressionScore</b> element is defined as: <b>Average_Freedom_of_Expression_Score (33230 - 33260)</b>.</p> |
|---------|--|

|            |  |
|------------|--|
| type       | <a href="#">ValueStrategyCoverageType1.1</a>   |
| properties | isRef 0<br>minOcc 0<br>maxOcc 1<br>content complex   |
| children   | <a href="#">Value</a> <a href="#">ConsideredInInvestmentStrategy</a> <a href="#">Coverage</a> <a href="#">EligibleAssets</a> |
| annotation | documentation<br>Average_Freedom_of_Expression_Score (33230 - 33260)   |

element

**EETReportType1.1.1/PrincipalAdverseIndicators/MoreSocialAndEmployeeMatters/SovereignAndSupranationalInvestments/AverageHumanRightsPerformance**

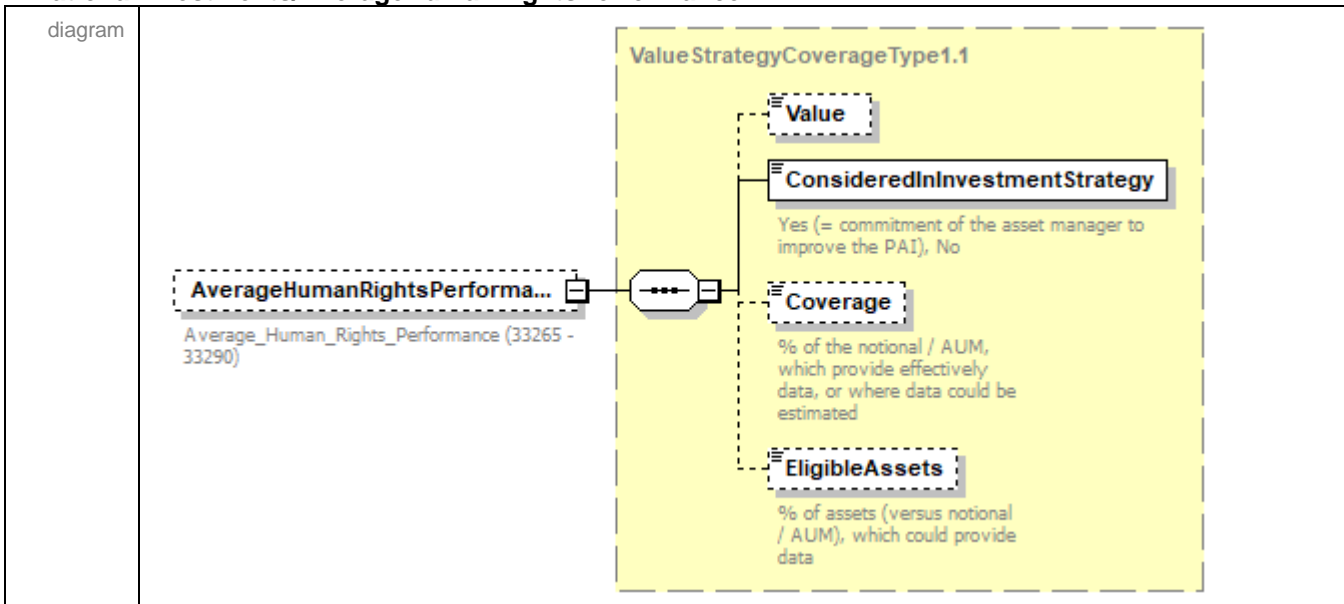

|            |  |
|------------|--|
| type       | <a href="#">ValueStrategyCoverageType1.1</a>   |
| properties | isRef 0<br>minOcc 0<br>maxOcc 1<br>content complex   |
| children   | <a href="#">Value</a> <a href="#">ConsideredInInvestmentStrategy</a> <a href="#">Coverage</a> <a href="#">EligibleAssets</a> |
| annotation | documentation<br>Average_Human_Rights_Performance (33265 - 33290)  |

element

### EETReportType1.1.1/PrincipalAdverseIndicators/MoreSocialAndEmployeeMatters/SovereignAndSupranationalInvestments/AverageCorruptionScore

|            |  |
|------------|--|
| diagram    |  |
| type       | <a href="#">ValueStrategyCoverageType1.1</a>   |
| properties | isRef 0<br>minOcc 0<br>maxOcc 1<br>content complex   |
| children   | <a href="#">Value</a> <a href="#">CoveredInvestmentStrategy</a> <a href="#">CoveredInvestmentStrategy</a> <a href="#">EligibleAssets</a> |
| annotation | documentation<br>Average_Corruption_Score (33295 - 33320)  |

element

### EETReportType1.1.1/PrincipalAdverseIndicators/MoreSocialAndEmployeeMatters/SovereignAndSupranationalInvestments/NonCooperativeTaxJurisdictions

|         |  |
|---------|--|
| diagram |  |
|---------|--|

|            |  |
|------------|--|
| type       | <a href="#">ValueStrategyCoverageType1.1</a>   |
| properties | isRef 0<br>minOcc 0<br>maxOcc 1<br>content complex   |
| children   | <a href="#">Value</a> <a href="#">ConsideredInInvestmentStrategy</a> <a href="#">Coverage</a> <a href="#">EligibleAssets</a> |
| annotation | documentation<br>Non_Cooperative_Tax_Jurisdictions (33330 - 33360)   |

element

**EETReportType1.1.1/PrincipalAdverseIndicators/MoreSocialAndEmployeeMatters/SovereignAndSupranationalInvestments/AveragePoliticalStabilityScore**

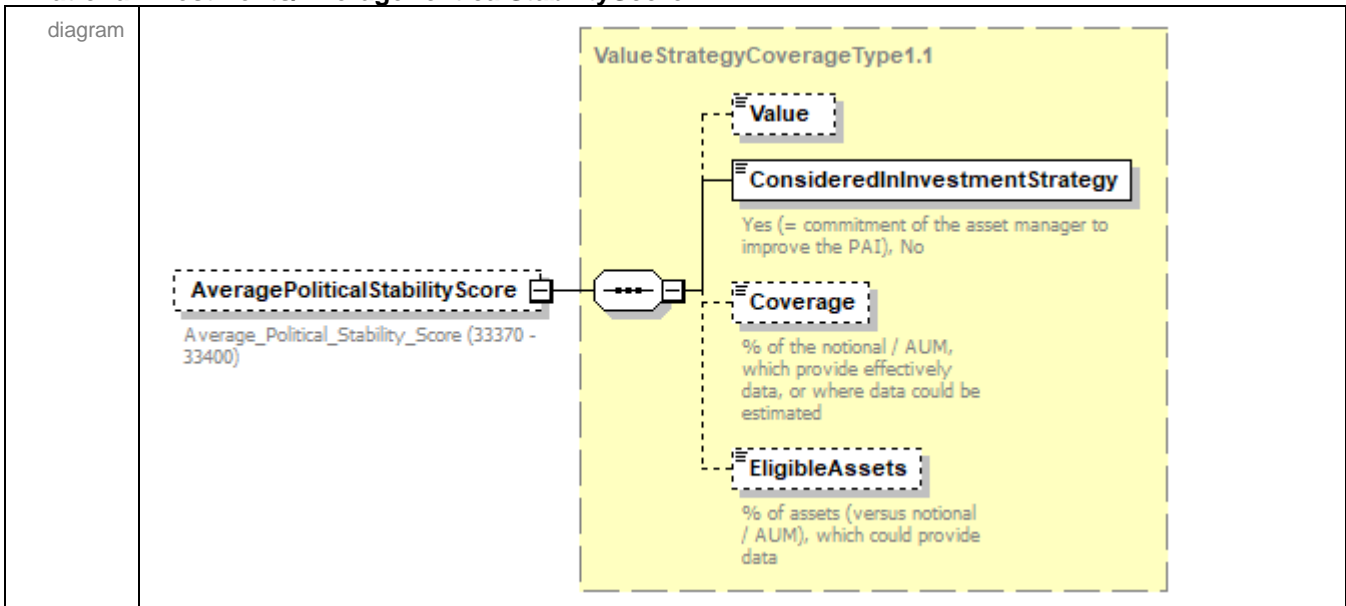

|            |  |
|------------|--|
| type       | <a href="#">ValueStrategyCoverageType1.1</a>   |
| properties | isRef 0<br>minOcc 0<br>maxOcc 1<br>content complex   |
| children   | <a href="#">Value</a> <a href="#">ConsideredInInvestmentStrategy</a> <a href="#">Coverage</a> <a href="#">EligibleAssets</a> |
| annotation | documentation<br>Average_Political_Stability_Score (33370 - 33400)   |

element

**EETReportType1.1/PrincipalAdverseIndicators/MoreSocialAndEmployeeMatters/SovereignAndSupranationalInvestments/AverageRuleOfLawScore**

|                   |   |
|-------------------|---|
| <p>diagram</p>    |   |
| <p>type</p>       | <p><a href="#">ValueStrategyCoverageType1.1</a></p>   |
| <p>properties</p> | <p>isRef 0<br/>minOcc 0<br/>maxOcc 1<br/>content complex</p>  |
| <p>children</p>   | <p><a href="#">Value</a> <a href="#">ConsideredInInvestmentStrategy</a> <a href="#">Coverage</a> <a href="#">EligibleAssets</a></p> |
| <p>annotation</p> | <p>documentation<br/>Average_Rule_Of_Law_Score (33410 - 33440)</p>  |



element **EETReportType1.1.1/ScreeningCriteria**

|            |  |
|------------|--|
| diagram    |  |
| properties | isRef 0<br>minOcc 0<br>maxOcc 1<br>content complex   |
| children   | <a href="#">ExistingNegativeScreeningStrategy</a> <a href="#">LinkToExclusionPolicyAndCriteria</a> <a href="#">SectorsBasedExclusions</a><br><a href="#">NormBasedExclusions</a> <a href="#">SovereignLevelExclusions</a> <a href="#">RealEstateExclusions</a> |
| annotation | documentation<br>40000 - 54070   |

element **EETReportType1.1.1/ScreeningCriteria/ExistingNegativeScreeningStrategy**

|            |  |
|------------|--|
| diagram    |  |
| type       | <a href="#">EETYesNoType</a>   |
| properties | isRef 0<br>minOcc 0<br>maxOcc 1<br>content simple  |
| facets     | Kind Value annotation<br>length 1  |
| annotation | documentation<br>40000_Financial_Instrument_Existing_Negative_Screening_Strategy<br>Yes / No |

element **EETReportType1.1.1/ScreeningCriteria/LinkToExclusionPolicyAndCriteria**

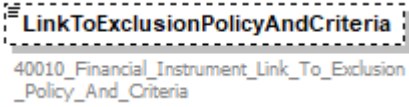
|            |   |
|------------|---|
| diagram    |  <p>40010_Financial_Instrument_Link_To_Exclusion_Policy_And_Criteria</p> |
| type       | <b>xs:anyURI</b>  |
| properties | isRef 0<br>minOcc 0<br>maxOcc 1<br>content simple   |
| annotation | documentation<br>40010_Financial_Instrument_Link_To_Exclusion_Policy_And_Criteria   |

element **EETReportType1.1.1/ScreeningCriteria/SectorsBasedExclusions**

diagram



|            |   |
|------------|---|
| properties | isRef 0<br>minOcc 0<br>maxOcc 1<br>content complex  |
| children   | <a href="#">PornographyAdultEntertainmentServicesExclusion</a> <a href="#">AlcoholExclusion</a> <a href="#">AnimalTestingExclusion</a> <a href="#">CannabisExclusion</a> <a href="#">ConventionalWeaponsExclusion</a> <a href="#">CoalExclusion</a> <a href="#">FactoryFarmingExclusion</a> <a href="#">FurExclusion</a> <a href="#">GamblingExclusion</a> <a href="#">GasExclusion</a> <a href="#">GeneticEngineeringExclusion</a> <a href="#">GeneticallyModifiedOrganismsExclusion</a> <a href="#">NuclearEnergyExclusion</a> <a href="#">NuclearWeaponsExclusion</a> <a href="#">OilExclusion</a> <a href="#">OtherFossilFuelExclusion</a> <a href="#">PalmOilExclusion</a> <a href="#">PesticidesExclusion</a> <a href="#">ResearchOnHumanEmbryosExclusion</a> <a href="#">TobaccoExclusion</a> <a href="#">UnconventionalWeaponsExclusion</a> |
| annotation | documentation<br>50100 - 52130  |

element

**EETReportType1.1.1/ScreeningCriteria/SectorsBasedExclusions/PornographyAdultEntertainmentServicesExclusion**

|            |  |
|------------|--|
| diagram    |  |
| type       | <a href="#">EETExclusionType1.1</a>  |
| properties | isRef 0<br>minOcc 0<br>maxOcc 1<br>content complex   |
| children   | <a href="#">Applied</a> <a href="#">ThresholdType</a> <a href="#">RelativeThreshold</a> <a href="#">PartOfValueChain</a> |
| annotation | documentation<br>50100 - 50130   |

element **EETReportType1.1/ScreeningCriteria/SectorsBasedExclusions/AlcoholExclusion**

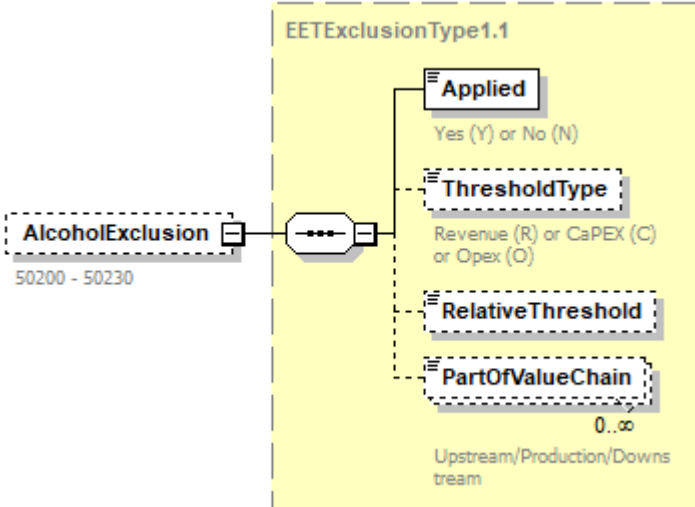
|                   |   |
|-------------------|---|
| <p>diagram</p>    |  <p>The diagram shows the structure of the <b>AlcoholExclusion</b> element (ID 50200 - 50230). It is a dashed box connected to a central connector box, which is linked to a larger dashed box labeled <b>EETExclusionType1.1</b>. Inside this box, the <b>Applied</b> element (Yes (Y) or No (N)) is connected to the <b>ThresholdType</b> element (Revenue (R) or CaPEX (C) or Opex (O)). The <b>ThresholdType</b> element is further connected to the <b>RelativeThreshold</b> and <b>PartOfValueChain</b> elements. The <b>PartOfValueChain</b> element has a cardinality of 0..∞ and is associated with the text "Upstream/Production/Downs tream".</p> |
| <p>type</p>       | <p><a href="#">EETExclusionType1.1</a></p>  |
| <p>properties</p> | <p>isRef 0<br/>minOcc 0<br/>maxOcc 1<br/>content complex</p>  |
| <p>children</p>   | <p><a href="#">Applied</a> <a href="#">ThresholdType</a> <a href="#">RelativeThreshold</a> <a href="#">PartOfValueChain</a></p>   |
| <p>annotation</p> | <p>documentation<br/>50200 - 50230</p>  |

element **EETReportType1.1/ScreeningCriteria/SectorsBasedExclusions/AnimalTestingExclusion**

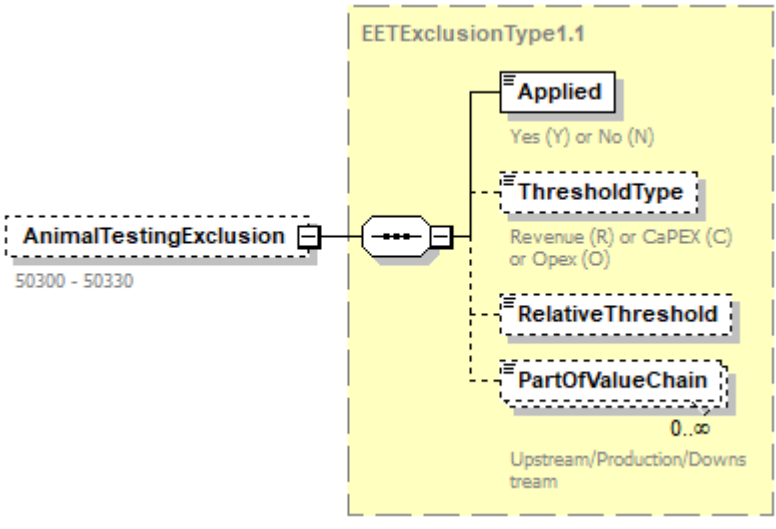
|                   |  |
|-------------------|--|
| <p>diagram</p>    |  <p>The diagram shows the structure of the <b>AnimalTestingExclusion</b> element (ID 50300 - 50330). It is a dashed box connected to a central connector box, which is linked to a larger dashed box labeled <b>EETExclusionType1.1</b>. Inside this box, the <b>Applied</b> element (Yes (Y) or No (N)) is connected to the <b>ThresholdType</b> element (Revenue (R) or CaPEX (C) or Opex (O)). The <b>ThresholdType</b> element is further connected to the <b>RelativeThreshold</b> and <b>PartOfValueChain</b> elements. The <b>PartOfValueChain</b> element has a cardinality of 0..∞ and is associated with the text "Upstream/Production/Downs tream".</p> |
| <p>type</p>       | <p><a href="#">EETExclusionType1.1</a></p>   |
| <p>properties</p> | <p>isRef 0<br/>minOcc 0<br/>maxOcc 1<br/>content complex</p>   |
| <p>children</p>   | <p><a href="#">Applied</a> <a href="#">ThresholdType</a> <a href="#">RelativeThreshold</a> <a href="#">PartOfValueChain</a></p>  |
| <p>annotation</p> | <p>documentation<br/>50300 - 50330</p>   |

element **EETReportType1.1/ScreeningCriteria/SectorsBasedExclusions/CannabisExclusion**

|            |  |
|------------|--|
| diagram    |  |
| type       | <a href="#">EETExclusionType1.1</a>  |
| properties | isRef 0<br>minOcc 0<br>maxOcc 1<br>content complex   |
| children   | <a href="#">Applied</a> <a href="#">ThresholdType</a> <a href="#">RelativeThreshold</a> <a href="#">PartOfValueChain</a> |
| annotation | documentation<br>50400 - 50430   |

element **EETReportType1.1/ScreeningCriteria/SectorsBasedExclusions/ConventionalWeaponsExclusion**

|            |                                     |
|------------|-------------------------------------|
| diagram    |                                     |
| type       | <a href="#">EETExclusionType1.1</a> |
| properties | isRef 0<br>minOcc 0<br>maxOcc 1     |

|            |  |
|------------|--|
|            | content complex  |
| children   | <a href="#">Applied</a> <a href="#">ThresholdType</a> <a href="#">RelativeThreshold</a> <a href="#">PartOfValueChain</a> |
| annotation | documentation<br>50500 - 50530   |

element **EETReportType1.1/ScreeningCriteria/SectorsBasedExclusions/CoalExclusion**

|            |   |
|------------|---|
| diagram    | <p>The diagram illustrates the structure of the <b>EETEnhancedExclusionType1.1</b> element. It is a complex type that contains several sub-elements: <b>Applied</b> (Yes (Y) or No (N)), <b>ThresholdType</b> (Revenue (R) or CaPEX (C) or Opex (O)), <b>RelativeThreshold</b>, <b>PartOfValueChain</b> (Upstream/Production/Downs tream), <b>EnergyMixAbsoluteCap</b>, <b>EnergyMixRelativeCap</b>, and <b>NewInfrastructure</b> (Yes (Y) or No (N)). The <b>CoalExclusion</b> element (50600 - 50660) is shown as a separate class that is associated with <b>EETEnhancedExclusionType1.1</b> via a composition relationship.</p> |
| type       | <a href="#">EETEnhancedExclusionType1.1</a>   |
| properties | isRef 0<br>minOcc 0<br>maxOcc 1<br>content complex  |
| children   | <a href="#">Applied</a> <a href="#">ThresholdType</a> <a href="#">RelativeThreshold</a> <a href="#">PartOfValueChain</a> <a href="#">EnergyMixAbsoluteCap</a> <a href="#">EnergyMixRelativeCap</a> <a href="#">NewInfrastructure</a>  |
| annotation | documentation<br>50600 - 50660  |



element **EETReportType1.1.1/ScreeningCriteria/SectorsBasedExclusions/FactoryFarmingExclusion**

|            |  |
|------------|--|
| diagram    | <p>The diagram illustrates the structure of the <b>FactoryFarmingExclusion</b> element. It is connected to the <b>EETExclusionType1.1</b> structure. The <b>EETExclusionType1.1</b> structure includes the following elements:</p> <ul style="list-style-type: none"> <li><b>Applied</b>: Yes (Y) or No (N)</li> <li><b>ThresholdType</b>: Revenue (R) or CaPEX (C) or Opex (O)</li> <li><b>RelativeThreshold</b></li> <li><b>PartOfValueChain</b>: 0..∞, Upstream/Production/Downs tream</li> </ul> |
| type       | <a href="#">EETExclusionType1.1</a>  |
| properties | <ul style="list-style-type: none"> <li>isRef 0</li> <li>minOcc 0</li> <li>maxOcc 1</li> <li>content complex</li> </ul>   |
| children   | <a href="#">Applied</a> <a href="#">ThresholdType</a> <a href="#">RelativeThreshold</a> <a href="#">PartOfValueChain</a>   |
| annotation | documentation<br>50700 - 50730   |

element **EETReportType1.1.1/ScreeningCriteria/SectorsBasedExclusions/FurExclusion**

|            |   |
|------------|---|
| diagram    | <p>The diagram illustrates the structure of the <b>FurExclusion</b> element. It is connected to the <b>EETExclusionType1.1</b> structure. The <b>EETExclusionType1.1</b> structure includes the following elements:</p> <ul style="list-style-type: none"> <li><b>Applied</b>: Yes (Y) or No (N)</li> <li><b>ThresholdType</b>: Revenue (R) or CaPEX (C) or Opex (O)</li> <li><b>RelativeThreshold</b></li> <li><b>PartOfValueChain</b>: 0..∞, Upstream/Production/Downs tream</li> </ul> |
| type       | <a href="#">EETExclusionType1.1</a>   |
| properties | <ul style="list-style-type: none"> <li>isRef 0</li> <li>minOcc 0</li> <li>maxOcc 1</li> <li>content complex</li> </ul>  |
| children   | <a href="#">Applied</a> <a href="#">ThresholdType</a> <a href="#">RelativeThreshold</a> <a href="#">PartOfValueChain</a>  |
| annotation | documentation<br>50800 - 50830  |

element **EETReportType1.1/ScreeningCriteria/SectorsBasedExclusions/GamblingExclusion**

|                   |  |
|-------------------|--|
| <p>diagram</p>    | <pre> classDiagram     class GamblingExclusion {         50900 - 50930     }     class EETExclusionType1.1     class Applied {         Yes (Y) or No (N)     }     class ThresholdType {         Revenue (R) or CaPEX (C) or Opex (O)     }     class RelativeThreshold     class PartOfValueChain {         0..∞         Upstream/Production/Downstream     }     GamblingExclusion -- &gt; EETExclusionType1.1     EETExclusionType1.1 -- &gt; Applied     EETExclusionType1.1 -- &gt; ThresholdType     EETExclusionType1.1 -- &gt; RelativeThreshold     EETExclusionType1.1 -- &gt; PartOfValueChain     </pre> |
| <p>type</p>       | <p><a href="#">EETExclusionType1.1</a></p>   |
| <p>properties</p> | <p>isRef 0<br/> minOcc 0<br/> maxOcc 1<br/> content complex</p>  |
| <p>children</p>   | <p><a href="#">Applied</a> <a href="#">ThresholdType</a> <a href="#">RelativeThreshold</a> <a href="#">PartOfValueChain</a></p>  |
| <p>annotation</p> | <p>documentation<br/> 50900 - 50930</p>  |

element **EETReportType1.1.1/ScreeningCriteria/SectorsBasedExclusions/GasExclusion**

|                   |   |
|-------------------|---|
| <p>diagram</p>    |   |
| <p>type</p>       | <p><a href="#">EETEnhancedExclusionType1.1</a></p>  |
| <p>properties</p> | <p>isRef 0<br/>minOcc 0<br/>maxOcc 1<br/>content complex</p>  |
| <p>children</p>   | <p><a href="#">Applied</a> <a href="#">ThresholdType</a> <a href="#">RelativeThreshold</a> <a href="#">PartOfValueChain</a> <a href="#">EnergyMixAbsoluteCap</a> <a href="#">EnergyMixRelativeCap</a> <a href="#">NewInfrastructure</a></p> |
| <p>annotation</p> | <p>documentation<br/>51000 - 51060</p>  |

element **EETReportType1.1.1/ScreeningCriteria/SectorsBasedExclusions/GeneticEngineeringExclusion**

|                |  |
|----------------|--|
| <p>diagram</p> |  |
|----------------|--|

|            |  |
|------------|--|
| type       | <a href="#">EETExclusionType1.1</a>  |
| properties | isRef 0<br>minOcc 0<br>maxOcc 1<br>content complex   |
| children   | <a href="#">Applied</a> <a href="#">ThresholdType</a> <a href="#">RelativeThreshold</a> <a href="#">PartOfValueChain</a> |
| annotation | documentation<br>51100 - 51130   |

element

**EETReportType1.1.1/ScreeningCriteria/SectorsBasedExclusions/GeneticallyModifiedOrganismsExclusion**

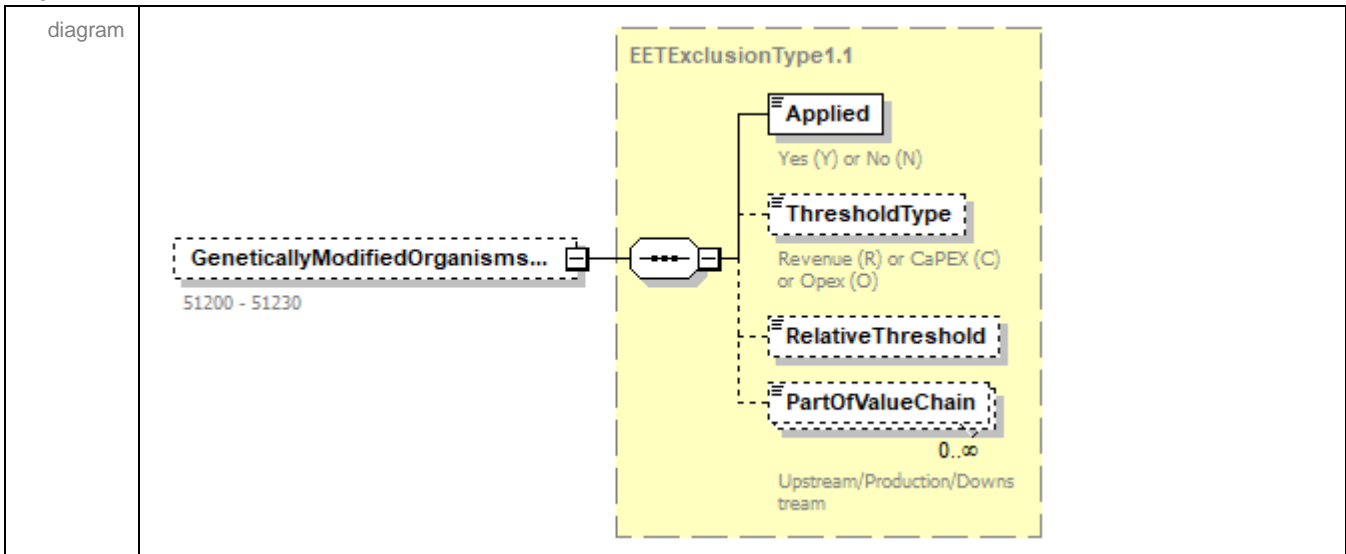

|            |  |
|------------|--|
| type       | <a href="#">EETExclusionType1.1</a>  |
| properties | isRef 0<br>minOcc 0<br>maxOcc 1<br>content complex   |
| children   | <a href="#">Applied</a> <a href="#">ThresholdType</a> <a href="#">RelativeThreshold</a> <a href="#">PartOfValueChain</a> |
| annotation | documentation<br>51200 - 51230   |

element **EETReportType1.1.1/ScreeningCriteria/SectorsBasedExclusions/NuclearEnergyExclusion**

|            |  |
|------------|--|
| diagram    |  |
| type       | <a href="#">EETExclusionType1.1</a>  |
| properties | isRef 0<br>minOcc 0<br>maxOcc 1<br>content complex   |
| children   | <a href="#">Applied</a> <a href="#">ThresholdType</a> <a href="#">RelativeThreshold</a> <a href="#">PartOfValueChain</a> |
| annotation | documentation<br>51300 - 51330   |

element **EETReportType1.1.1/ScreeningCriteria/SectorsBasedExclusions/NuclearWeaponsExclusion**

|            |  |
|------------|--|
| diagram    |  |
| type       | <a href="#">EETExclusionType1.1</a>  |
| properties | isRef 0<br>minOcc 0<br>maxOcc 1<br>content complex   |
| children   | <a href="#">Applied</a> <a href="#">ThresholdType</a> <a href="#">RelativeThreshold</a> <a href="#">PartOfValueChain</a> |
| annotation | documentation<br>51400 - 51430   |

element **EETReportType1.1/ScreeningCriteria/SectorsBasedExclusions/OilExclusion**

|                   |   |
|-------------------|---|
| <p>diagram</p>    | <p>The diagram illustrates the structure of the <b>EETEnhancedExclusionType1.1</b> class. It is associated with the <b>OilExclusion</b> class (documentation: 51500 - 51560). The <b>EETEnhancedExclusionType1.1</b> class contains the following attributes:</p> <ul style="list-style-type: none"> <li><b>Applied</b>: Yes (Y) or No (N)</li> <li><b>ThresholdType</b>: Revenue (R) or CaPEX (C) or Opex (O)</li> <li><b>RelativeThreshold</b></li> <li><b>PartOfValueChain</b>: Upstream/Production/Downstream</li> <li><b>EnergyMixAbsoluteCap</b></li> <li><b>EnergyMixRelativeCap</b></li> <li><b>NewInfrastructure</b>: Yes (Y) or No (N)</li> </ul> |
| <p>type</p>       | <p><a href="#">EETEnhancedExclusionType1.1</a></p>  |
| <p>properties</p> | <p>isRef 0<br/>minOcc 0<br/>maxOcc 1<br/>content complex</p>  |
| <p>children</p>   | <p><a href="#">Applied</a> <a href="#">ThresholdType</a> <a href="#">RelativeThreshold</a> <a href="#">PartOfValueChain</a> <a href="#">EnergyMixAbsoluteCap</a> <a href="#">EnergyMixRelativeCap</a> <a href="#">NewInfrastructure</a></p>   |
| <p>annotation</p> | <p>documentation<br/>51500 - 51560</p>  |

element **EETReportType1.1.1/ScreeningCriteria/SectorsBasedExclusions/OtherFossilFuelExclusion**

|            |  |
|------------|--|
| diagram    |  |
| type       | <a href="#">EETEnhancedExclusionType1.1</a>  |
| properties | isRef 0<br>minOcc 0<br>maxOcc 1<br>content complex   |
| children   | <a href="#">Applied</a> <a href="#">ThresholdType</a> <a href="#">RelativeThreshold</a> <a href="#">PartOfValueChain</a> <a href="#">EnergyMixAbsoluteCap</a> <a href="#">EnergyMixRelativeCap</a> <a href="#">NewInfrastructure</a> |
| annotation | documentation<br>51600 - 51660   |

element **EETReportType1.1.1/ScreeningCriteria/SectorsBasedExclusions/PalmOilExclusion**

|         |  |
|---------|--|
| diagram |  |
|---------|--|

|            |  |
|------------|--|
| type       | <a href="#">EETExclusionType1.1</a>  |
| properties | isRef 0<br>minOcc 0<br>maxOcc 1<br>content complex   |
| children   | <a href="#">Applied</a> <a href="#">ThresholdType</a> <a href="#">RelativeThreshold</a> <a href="#">PartOfValueChain</a> |
| annotation | documentation<br>51700 - 51730   |

element **EETReportType1.1/ScreeningCriteria/SectorsBasedExclusions/PesticidesExclusion**

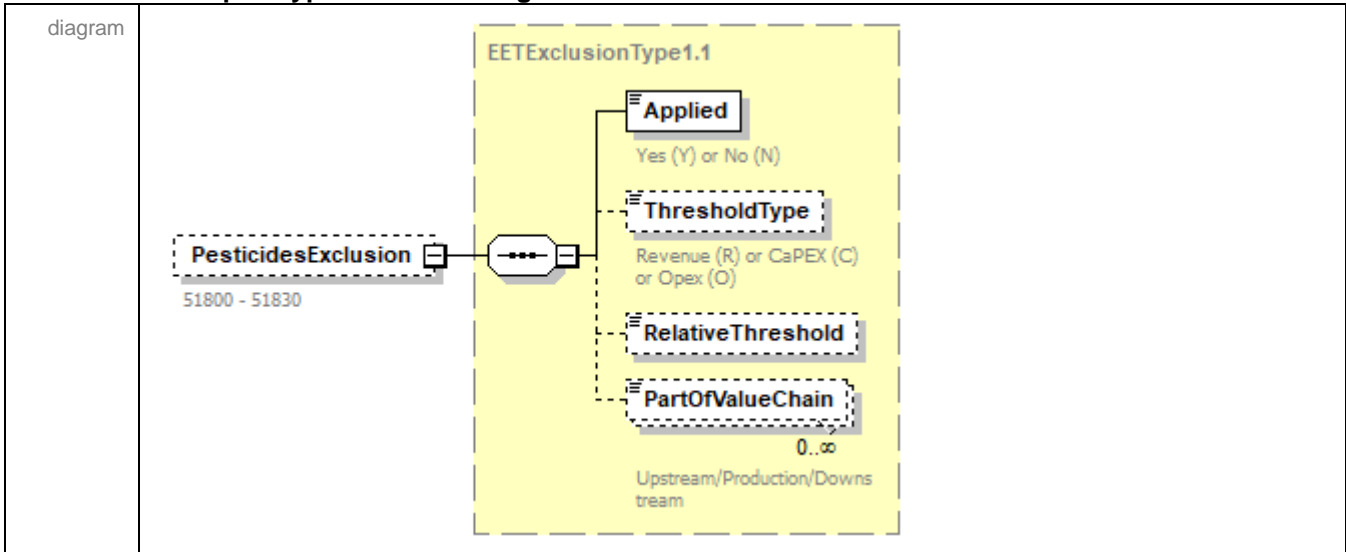

|            |  |
|------------|--|
| type       | <a href="#">EETExclusionType1.1</a>  |
| properties | isRef 0<br>minOcc 0<br>maxOcc 1<br>content complex   |
| children   | <a href="#">Applied</a> <a href="#">ThresholdType</a> <a href="#">RelativeThreshold</a> <a href="#">PartOfValueChain</a> |
| annotation | documentation<br>51800 - 51830   |



element

**EETReportType1.1.1/ScreeningCriteria/SectorsBasedExclusions/ResearchOnHumanEmbryosExclusion**

|                   |   |
|-------------------|---|
| <p>diagram</p>    |   |
| <p>type</p>       | <p><a href="#">EETExclusionType1.1</a></p>  |
| <p>properties</p> | <p>isRef 0<br/>minOcc 0<br/>maxOcc 1<br/>content complex</p>  |
| <p>children</p>   | <p><a href="#">Applied</a> <a href="#">ThresholdType</a> <a href="#">RelativeThreshold</a> <a href="#">PartOfValueChain</a></p> |
| <p>annotation</p> | <p>documentation<br/>51900 - 51930</p>  |

element **EETReportType1.1.1/ScreeningCriteria/SectorsBasedExclusions/TobaccoExclusion**

|                   |   |
|-------------------|---|
| <p>diagram</p>    |   |
| <p>type</p>       | <p><a href="#">EETExclusionType1.1</a></p>  |
| <p>properties</p> | <p>isRef 0<br/>minOcc 0<br/>maxOcc 1<br/>content complex</p>  |
| <p>children</p>   | <p><a href="#">Applied</a> <a href="#">ThresholdType</a> <a href="#">RelativeThreshold</a> <a href="#">PartOfValueChain</a></p> |

|            |                                |
|------------|--------------------------------|
| annotation | documentation<br>52000 - 52030 |
|------------|--------------------------------|

element

**EETReportType1.1.1/ScreeningCriteria/SectorsBasedExclusions/UnconventionalWeaponsExclusion**

|            |  |
|------------|--|
| diagram    |  |
| type       | <a href="#">EETExclusionType1.1</a>  |
| properties | isRef 0<br>minOcc 0<br>maxOcc 1<br>content complex   |
| children   | <a href="#">Applied</a> <a href="#">ThresholdType</a> <a href="#">RelativeThreshold</a> <a href="#">PartOfValueChain</a> |
| annotation | documentation<br>52100 - 52130   |

element **EETReportType1.1.1/ScreeningCriteria/NormBasedExclusions**

|            |  |
|------------|--|
| diagram    |  |
| properties | isRef 0<br>minOcc 0<br>maxOcc 1<br>content complex   |
| children   | <a href="#">UNGC Exclusion</a> <a href="#">OECD Guidelines Exclusion</a> <a href="#">ILO Exclusion</a> |
| annotation | documentation<br>52200 - 52220   |

element **EETReportType1.1.1/ScreeningCriteria/NormBasedExclusions/UNGC\_Exclusion**

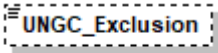
|            |   |
|------------|---|
| diagram    |  <p>52200_Financial_Instrument<br/>_UNGC_Exclusion</p> |
| type       | <a href="#">EETYesNoType</a>  |
| properties | isRef 0<br>minOcc 0<br>maxOcc 1<br>content simple   |
| facets     | Kind Value annotation<br>length 1   |
| annotation | documentation<br>52200_Financial_Instrument_UNGC_Exclusion  |

element **EETReportType1.1.1/ScreeningCriteria/NormBasedExclusions/OECD\_Guidelines\_Exclusion**

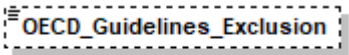
|            |  |
|------------|--|
| diagram    |  <p>52210_Financial_Instrument_OECD_G<br/>uidelines_Exclusion</p> |
| type       | <a href="#">EETYesNoType</a>   |
| properties | isRef 0<br>minOcc 0<br>maxOcc 1<br>content simple  |
| facets     | Kind Value annotation<br>length 1  |
| annotation | documentation<br>52210_Financial_Instrument_OECD_Guidelines_Exclusion  |

element **EETReportType1.1.1/ScreeningCriteria/NormBasedExclusions/ILO\_Exclusion**

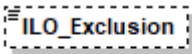
|            |  |
|------------|--|
| diagram    |  <p>52220_Financial_Instrument<br/>_ILO_Exclusion</p> |
| type       | <a href="#">EETYesNoType</a>   |
| properties | isRef 0<br>minOcc 0<br>maxOcc 1<br>content simple  |
| facets     | Kind Value annotation<br>length 1  |
| annotation | documentation<br>52220_Financial_Instrument_ILO_Exclusion  |

element **EETReportType1.1.1/ScreeningCriteria/SovereignLevelExclusions**

|            |  |
|------------|--|
| diagram    | <p>The diagram shows a container element <b>SovereignLevelExclusions</b> (ID: 53000 - 53060) connected to seven sub-exclusion elements:</p> <ul style="list-style-type: none"> <li><b>NuclearWeaponsExclusion</b> (53000_Financial_Instrument_Nuclear_Weapons_Exclusion)</li> <li><b>NonProliferationTreatyOfNuclear...</b> (53010_Financial_Instrument_Non-proliferation_Treaty_Of_Nuclear_Weapons)</li> <li><b>QualitativeExclusionOfCountries</b> (53020_Financial_Instrument_Qualitative_Exc_lusion_Of_Countries: A - Freedomhouse, I - Internal method, N - None)</li> <li><b>CorruptionExclusion</b> (53030_Financial_Instrument_Corruption_Exclusion)</li> <li><b>DeathSentenceExclusion</b> (53040_Financial_Instrument_Death_Sentence_Exclusion)</li> <li><b>WarExclusion</b> (53050_Financial_Instrument_War_Exclusion)</li> <li><b>NonRatificationOfParisAgreeme...</b> (53060_Financial_Instrument_Non_Ratification_Of_Paris_Agreement_Exclusion)</li> </ul> |
| properties | <p>isRef 0<br/> minOcc 0<br/> maxOcc 1<br/> content complex</p>  |
| children   | <p><a href="#">NuclearWeaponsExclusion</a> <a href="#">NonProliferationTreatyOfNuclearWeapons</a> <a href="#">QualitativeExclusionOfCountries</a> <a href="#">CorruptionExclusion</a> <a href="#">DeathSentenceExclusion</a> <a href="#">WarExclusion</a> <a href="#">NonRatificationOfParisAgreementExclusion</a></p>   |
| annotation | <p>documentation<br/> 53000 - 53060</p>  |

element **EETReportType1.1.1/ScreeningCriteria/SovereignLevelExclusions/NuclearWeaponsExclusion**

|            |   |
|------------|---|
| diagram    | <p>The diagram shows the <b>NuclearWeaponsExclusion</b> element (ID: 53000_Financial_Instrument_Nuclear_Weapons_Exclusion).</p> |
| type       | <p><a href="#">EETYesNoType</a></p>   |
| properties | <p>isRef 0<br/> minOcc 0<br/> maxOcc 1<br/> content simple</p>  |
| facets     | <p>Kind Value annotation<br/> length 1</p>  |
| annotation | <p>documentation<br/> 53000_Financial_Instrument_Nuclear_Weapons_Exclusion</p>  |

element

**EETReportType1.1.1/ScreeningCriteria/SovereignLevelExclusions/NonProliferationTreatyOfNuclearWeapons**

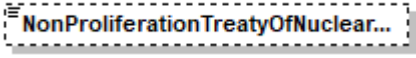
|            |   |
|------------|---|
| diagram    | <br>53010_Financial_Instrument_Non-proliferation_Treaty_Of_Nuclear_Weapons |
| type       | <a href="#">EETYesNoType</a>  |
| properties | isRef 0<br>minOcc 0<br>maxOcc 1<br>content simple   |
| facets     | Kind Value annotation<br>length 1   |
| annotation | documentation<br>53010_Financial_Instrument_Non-proliferation_Treaty_Of_Nuclear_Weapons   |

element

**EETReportType1.1.1/ScreeningCriteria/SovereignLevelExclusions/QualitativeExclusionOfCountries**

|            |   |
|------------|---|
| diagram    | <br>53020_Financial_Instrument_Qualitative_Exclusion_Of_Countries:<br>A- Freedomhouse<br>I - Internal method<br>N - None |
| type       | restriction of <b>xs:string</b>   |
| properties | isRef 0<br>minOcc 0<br>maxOcc 1<br>content simple   |
| annotation | documentation<br>53020_Financial_Instrument_Qualitative_Exclusion_Of_Countries:<br>A- Freedomhouse<br>I - Internal method<br>N - None   |

element **EETReportType1.1.1/ScreeningCriteria/SovereignLevelExclusions/CorruptionExclusion**

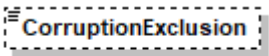
|            |  |
|------------|--|
| diagram    | <br>53030_Financial_Instrument_Corruption_Exclusion |
| type       | <a href="#">EETYesNoType</a>   |
| properties | isRef 0<br>minOcc 0<br>maxOcc 1<br>content simple  |
| facets     | Kind Value annotation<br>length 1  |
| annotation | documentation<br>53030_Financial_Instrument_Corruption_Exclusion   |

element **EETReportType1.1.1/ScreeningCriteria/SovereignLevelExclusions/DeathSentenceExclusion**

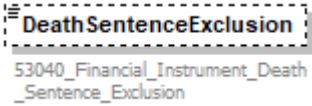
|            |  |
|------------|--|
| diagram    |  The diagram shows a dashed box containing the text "DeathSentenceExclusion" and "53040_Financial_Instrument_Death_Sentence_Exclusion". |
| type       | <a href="#">EETYesNoType</a>   |
| properties | isRef 0<br>minOcc 0<br>maxOcc 1<br>content simple  |
| facets     | Kind Value annotation<br>length 1  |
| annotation | documentation<br>53040_Financial_Instrument_Death_Sentence_Exclusion   |

element **EETReportType1.1.1/ScreeningCriteria/SovereignLevelExclusions/WarExclusion**

|            |   |
|------------|---|
| diagram    |  The diagram shows a dashed box containing the text "WarExclusion" and "53050_Financial_Instrument_War_Exclusion". |
| type       | <a href="#">EETYesNoType</a>  |
| properties | isRef 0<br>minOcc 0<br>maxOcc 1<br>content simple   |
| facets     | Kind Value annotation<br>length 1   |
| annotation | documentation<br>53050_Financial_Instrument_War_Exclusion   |

element **EETReportType1.1.1/ScreeningCriteria/SovereignLevelExclusions/NonRatificationOfParisAgreementExclusion**

|            |   |
|------------|---|
| diagram    |  The diagram shows a dashed box containing the text "NonRatificationOfParisAgreementExclusion" and "53060_Financial_Instrument_Non_Ratification_Of_Paris_Agreement_Exclusion". |
| type       | <a href="#">EETYesNoType</a>  |
| properties | isRef 0<br>minOcc 0<br>maxOcc 1<br>content simple   |
| facets     | Kind Value annotation<br>length 1   |
| annotation | documentation<br>53060_Financial_Instrument_Non_Ratification_Of_Paris_Agreement_Exclusion   |

element **EETReportType1.1.1/ScreeningCriteria/RealEstateExclusions**

|                   |  |
|-------------------|--|
| <p>diagram</p>    | <p>The diagram shows a container element <b>RealEstateExclusions</b> (ID: 54000 - 54070) connected to seven sub-elements, each in a dashed box:</p> <ul style="list-style-type: none"> <li><b>EnergyConsumptionMonitoring</b> (54000_Financial_Instrument_ESG_Energy_Consumption_Monitoring)</li> <li><b>GreenhouseGasEmissionMonitoring</b> (54010_Financial_Instrument_ESG_GHG_Emission_Monitoring)</li> <li><b>WaterConsumptionMonitoring</b> (54020_Financial_Instrument_ESG_Water_Consumption_Monitoring)</li> <li><b>WasteFinancialInstrumentMonitoring</b> (54030_Financial_Instrument_ESG_Waste_Financial_Instrument_Monitoring)</li> <li><b>EnvironmentalHealthMonitoring</b> (54040_Financial_Instrument_ESG_Environmental_Health_Monitoring)</li> <li><b>SupplierMonitoring</b> (54050_Financial_Instrument_ESG_Supplier_Monitoring)</li> <li><b>SafetyMonitoring</b> (54060_Financial_Instrument_ESG_Safety_Monitoring)</li> <li><b>BiodiversityMonitoring</b> (54070_Financial_Instrument_ESG_Biodiversity_Monitoring)</li> </ul> |
| <p>properties</p> | <p>isRef 0<br/>minOcc 0<br/>maxOcc 1<br/>content complex</p>   |
| <p>children</p>   | <p><a href="#">EnergyConsumptionMonitoring</a> <a href="#">GreenhouseGasEmissionMonitoring</a> <a href="#">WaterConsumptionMonitoring</a> <a href="#">WasteFinancialInstrumentMonitoring</a> <a href="#">EnvironmentalHealthMonitoring</a> <a href="#">SupplierMonitoring</a> <a href="#">SafetyMonitoring</a> <a href="#">BiodiversityMonitoring</a></p>  |
| <p>annotation</p> | <p>documentation<br/>54000 - 54070</p>   |

element **EETReportType1.1.1/ScreeningCriteria/RealEstateExclusions/EnergyConsumptionMonitoring**

|                   |  |
|-------------------|--|
| <p>diagram</p>    | <p>The diagram shows a single element <b>EnergyConsumptionMonitoring</b> (ID: 54000_Financial_Instrument_ESG_Energy_Consumption_Monitoring) in a dashed box.</p> |
| <p>type</p>       | <p><a href="#">EETYesNoType</a></p>  |
| <p>properties</p> | <p>isRef 0<br/>minOcc 0<br/>maxOcc 1<br/>content simple</p>  |
| <p>facets</p>     | <p>Kind Value annotation<br/>length 1</p>  |

|            |   |
|------------|---|
| annotation | documentation<br>54000_Financial_Instrument_ESG_Energy_Consumption_Monitoring |
|------------|---|

element

**EETReportType1.1.1/ScreeningCriteria/RealEstateExclusions/GreenhouseGasEmissionMonitoring**

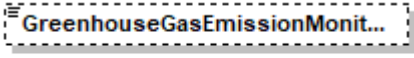
|            |   |
|------------|---|
| diagram    | <br>54010_Financial_Instrument_ESG_GHG_Emission_Monitoring |
| type       | <a href="#">EETYesNoType</a>  |
| properties | isRef 0<br>minOcc 0<br>maxOcc 1<br>content simple   |
| facets     | Kind Value annotation<br>length 1   |
| annotation | documentation<br>54010_Financial_Instrument_ESG_GHG_Emission_Monitoring   |

element **EETReportType1.1.1/ScreeningCriteria/RealEstateExclusions/WaterConsumptionMonitoring**

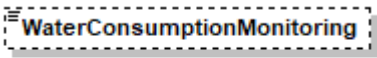
|            |  |
|------------|--|
| diagram    | <br>54020_Financial_Instrument_ESG_Water_Consumption_Monitoring |
| type       | <a href="#">EETYesNoType</a>   |
| properties | isRef 0<br>minOcc 0<br>maxOcc 1<br>content simple  |
| facets     | Kind Value annotation<br>length 1  |
| annotation | documentation<br>54020_Financial_Instrument_ESG_Water_Consumption_Monitoring   |

element

**EETReportType1.1.1/ScreeningCriteria/RealEstateExclusions/WasteFinancialInstrumentMonitoring**

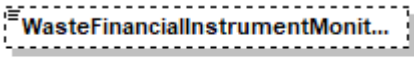
|            |   |
|------------|---|
| diagram    | <br>54030_Financial_Instrument_ESG_Waste_Financial_Instrument_Monitoring |
| type       | <a href="#">EETYesNoType</a>  |
| properties | isRef 0<br>minOcc 0<br>maxOcc 1<br>content simple   |
| facets     | Kind Value annotation<br>length 1   |
| annotation | documentation<br>54030_Financial_Instrument_ESG_Waste_Financial_Instrument_Monitoring   |

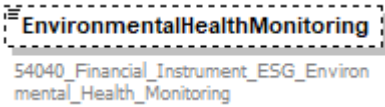

element **EETReportType1.1.1/ScreeningCriteria/RealEstateExclusions/EnvironmentalHealthMonitoring**

|            |   |
|------------|---|
| diagram    |  <p>54040_Financial_Instrument_ESG_Environmental_Health_Monitoring</p> |
| type       | <a href="#">EETYesNoType</a>  |
| properties | isRef 0<br>minOcc 0<br>maxOcc 1<br>content simple   |
| facets     | Kind Value annotation<br>length 1   |
| annotation | documentation<br>54040_Financial_Instrument_ESG_Environmental_Health_Monitoring   |

element **EETReportType1.1.1/ScreeningCriteria/RealEstateExclusions/SupplierMonitoring**

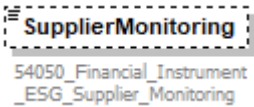
|            |   |
|------------|---|
| diagram    |  <p>54050_Financial_Instrument_ESG_Supplier_Monitoring</p> |
| type       | <a href="#">EETYesNoType</a>  |
| properties | isRef 0<br>minOcc 0<br>maxOcc 1<br>content simple   |
| facets     | Kind Value annotation<br>length 1   |
| annotation | documentation<br>54050_Financial_Instrument_ESG_Supplier_Monitoring   |

element **EETReportType1.1.1/ScreeningCriteria/RealEstateExclusions/SafetyMonitoring**

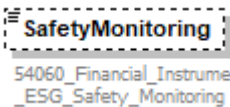
|            |   |
|------------|---|
| diagram    |  <p>54060_Financial_Instrument_ESG_Safety_Monitoring</p> |
| type       | <a href="#">EETYesNoType</a>  |
| properties | isRef 0<br>minOcc 0<br>maxOcc 1<br>content simple   |
| facets     | Kind Value annotation<br>length 1   |
| annotation | documentation<br>54060_Financial_Instrument_ESG_Safety_Monitoring   |

element **EETReportType1.1.1/ScreeningCriteria/RealEstateExclusions/BiodiversityMonitoring**

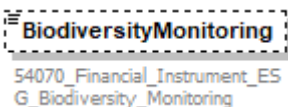
|         |   |
|---------|---|
| diagram |  <p>54070_Financial_Instrument_ESG_Biodiversity_Monitoring</p> |
| type    | <a href="#">EETYesNoType</a>  |

|            |   |
|------------|---|
| properties | isRef 0<br>minOcc 0<br>maxOcc 1<br>content simple                       |
| facets     | Kind Value annotation<br>length 1                                       |
| annotation | documentation<br>54070_Financial_Instrument_ESG_Biodiversity_Monitoring |

element **EETReportType1.1.1/CountrySpecificInformation**

|            |   |
|------------|---|
| diagram    | <p>The diagram shows a class <b>CountrySpecificInformation</b> (ID 60400 - 60440) with a dashed border. It is connected via a solid line with an open arrowhead to a central hexagonal connector. From this connector, two dashed lines branch out to two other classes: <b>France</b> (ID 60400 - 60430) and <b>Germany</b> (ID 60440). Both France and Germany classes also have dashed borders and a small square icon with a plus sign in the top right corner.</p> |
| properties | isRef 0<br>minOcc 0<br>maxOcc 1<br>content complex  |
| children   | <a href="#">France</a> <a href="#">Germany</a>  |
| annotation | documentation<br>60400 - 60440  |

element **EETReportType1.1.1/CountrySpecificInformation/France**

|                   |   |
|-------------------|---|
| <p>diagram</p>    | <p><b>France</b><br/>60400 - 60430</p> <p><b>FrenchAMFDoctrineApproach</b><br/>60400_French_AMF_Doctrine_Approach:<br/>Which approach of the AMF position/recommendation 2020-03 does your fund comply with?<br/>1: Approach based on a significantly engaging methodology<br/>2: Non-significantly engaging methodology approach<br/>3: Approach not meeting central or limited communication standards</p> <p><b>EnvironmentalTopicOrConsideredIndicatorsForFrenchMiFIDMarket</b><br/>60410_Financial_Instrument_Environmental_Topic_Or_Considered_Indicators_For_French_MiFID_Market<br/>Description of the Environmental topics integrated in the investment process of the fund,<br/>Multiple answers field.<br/>A - Transition to low carbon economy<br/>B - Natural resources preservation or consumption<br/>C - Land and Ocean preservation<br/>D - Waste<br/>E - Biodiversity preservation<br/>F - none</p> <p><b>SocialTopicOrConsideredIndicatorsForFrenchMiFIDMarket</b><br/>60420_Financial_Instrument_Social_Topic_Or_Considered_Indicators_For_French_MiFID_Market:<br/>Description of the social topics integrated in the investment strategy,<br/>Multiple answers fields.<br/>A - Social and human rights<br/>B - labour relations<br/>C - investment in human capital (including health)<br/>D - none</p> <p><b>GovernanceTopicOrConsideredIndicatorsForFrenchMiFIDMarket</b><br/>60430_Financial_Instrument_Governance_Topic_Or_Considered_Indicators_For_French_MiFID_Market:<br/>Description of the governance topic integrated in the investment strategy,<br/>Multiple answers field<br/>A - anti bribery and corruption<br/>B - governance other<br/>C - none</p> |
| <p>properties</p> | <p>isRef 0<br/>minOcc 0<br/>maxOcc 1<br/>content complex</p>  |
| <p>children</p>   | <p><a href="#">FrenchAMFDoctrineApproach</a> <a href="#">EnvironmentalTopicOrConsideredIndicatorsForFrenchMiFIDMarket</a> <a href="#">SocialTopicOrConsideredIndicatorsForFrenchMiFIDMarket</a> <a href="#">GovernanceTopicOrConsideredIndicatorsForFrenchMiFIDMarket</a></p>   |

|            |   |
|------------|---|
|            | <a href="#">GovernanceTopicOrConsideredIndicatorsForFrenchMiFIDMarket</a> |
| annotation | documentation<br>60400 - 60430  |

element **EETReportType1.1.1/CountrySpecificInformation/France/FrenchAMFDoctrineApproach**

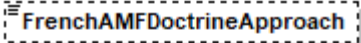
|            |  |
|------------|--|
| diagram    |  <p>60400_French_AMF_Doctrine_Approach:<br/>Which approach of the AMF position/recommendation 2020-03 does your fund comply with?<br/>1: Approach based on a significantly engaging methodology<br/>2: Non-significantly engaging methodology approach<br/>3: Approach not meeting central or limited communication standards</p> |
| type       | restriction of <b>xs:string</b>  |
| properties | isRef 0<br>minOcc 0<br>maxOcc 1<br>content simple  |
| annotation | documentation<br>60400_French_AMF_Doctrine_Approach:<br>Which approach of the AMF position/recommendation 2020-03 does your fund comply with?<br>1: Approach based on a significantly engaging methodology<br>2: Non-significantly engaging methodology approach<br>3: Approach not meeting central or limited communication standards   |

element **EETReportType1.1.1/CountrySpecificInformation/France/EnvironmentalTopicOrConsideredIndicators**

|            |   |
|------------|---|
| diagram    |  <p>0..∞</p> <p>60410_Financial_Instrument_Environmental_Topic_Or_Considered_Indicators_For_French_MiFID_Market<br/>Description of the Environmental topics integrated in the investment process of the fund,<br/>Multiple answers field.</p> <p>A - Transition to low carbon economy<br/>B - Natural resources preservation or consumption<br/>C - Land and Ocean preservation<br/>D - Waste<br/>E - Biodiversity preservation<br/>F - none</p> |
| type       | restriction of <b>xs:string</b>   |
| properties | isRef 0<br>minOcc 0<br>maxOcc unbounded<br>content simple   |
| annotation | documentation<br>60410_Financial_Instrument_Environmental_Topic_Or_Considered_Indicators_For_French_MiFID_Market<br>Description of the Environmental topics integrated in the investment process of the fund,<br>Multiple answers field.  |

|  |   |
|--|---|
|  | <p>A - Transition to low carbon economy<br/> B - Natural resources preservation or consumption<br/> C - Land and Ocean preservation<br/> D - Waste<br/> E - Biodiversity preservation<br/> F - none</p> |
|--|---|

element

**EETReportType1.1.1/CountrySpecificInformation/France/SocialTopicOrConsideredIndicatorsForFrenchMiFIDMarket**

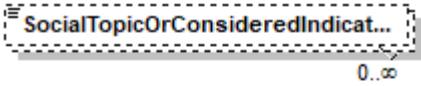
|            |  |
|------------|--|
| diagram    |  <p>60420_Financial_Instrument_Social_Topic_Or_Considered_Indicators_For_French_MiFID_Market:<br/> Description of the social topics integrated in the investment strategy,<br/> Multiple answers fields.</p> <p>A - Social and human rights<br/> B - labour relations<br/> C - investment in human capital (including health)<br/> D - none</p> |
| type       | restriction of <b>xs:string</b>  |
| properties | isRef 0<br>minOcc 0<br>maxOcc unbounded<br>content simple  |
| annotation | documentation<br>60420_Financial_Instrument_Social_Topic_Or_Considered_Indicators_For_French_MiFID_Market:<br>Description of the social topics integrated in the investment strategy,<br>Multiple answers fields. <p>A - Social and human rights<br/> B - labour relations<br/> C - investment in human capital (including health)<br/> D - none</p>   |

element

**EETReportType1.1.1/CountrySpecificInformation/France/GovernanceTopicOrConsideredIndicatorsForFrenchMiFIDMarket**

|         |   |
|---------|---|
| diagram |  <p>60430_Financial_Instrument_Governance_Topic_Or_Considered_Indicators_For_French_MiFID_Market:<br/> Description of the governance topic integrated in the investment strategy,<br/> Multiple answers field</p> <p>A - anti bribery and corruption<br/> B - governance other<br/> C - none</p> |
|---------|---|

|            |   |
|------------|---|
| type       | restriction of <b>xs:string</b>   |
| properties | isRef 0<br>minOcc 0<br>maxOcc unbounded<br>content simple   |
| annotation | documentation<br>60430_Financial_Instrument_Governance_Topic_Or_Considered_Indicators_For_French_MiFID_Market:<br>Description of the governance topic integrated in the investment strategy,<br>Multiple answers field<br>A - anti bribery and corruption<br>B - governance other<br>C - none |

element **EETReportType1.1.1/CountrySpecificInformation/Germany**

|            |   |
|------------|---|
| diagram    |   |
| properties | isRef 0<br>minOcc 0<br>maxOcc 1<br>content complex        |
| children   | <a href="#">SustainableIndicatorsForGermanMiFIDMarket</a> |
| annotation | documentation<br>60440                                    |

element

**EETReportType1.1.1/CountrySpecificInformation/Germany/SustainableIndicatorsForGermanMiFIDMarket**

|            |   |
|------------|---|
| diagram    |   |
| type       | restriction of <b>xs:string</b>   |
| properties | isRef 0<br>minOcc 0<br>maxOcc unbounded<br>content simple   |
| annotation | documentation<br>60440_Financial_Instrument_Sustainable_Indicators_For_German_MiFID_Market:<br>O, B, E, P, Q, R, S, T, U or V |

element **EETReportType1.1.1/SupplementaryFieldsV1.1**

|            |  |
|------------|--|
| diagram    | <p>The diagram shows a central element <b>SupplementaryFieldsV1.1</b> (70000-70010) connected to two child elements: <b>SustainabilityRisksDemedToBe...</b> (70000_Financial_Instrument_Sustainability_Risk_Is_Deemed_To_Be_Relevant) and <b>TotalFundAUMORNational</b> (70010_Financial_Instrument_Total_Fund_AUM_Or_Notional).</p> |
| properties | <p>isRef 0<br/> minOcc 0<br/> maxOcc 1<br/> content complex</p>  |
| children   | <p><a href="#">SustainabilityRisksDemedToBeRelevant</a> <a href="#">TotalFundAUMORNational</a></p>   |
| annotation | <p>documentation<br/> 70000- 70010</p>   |

element **EETReportType1.1.1/SupplementaryFieldsV1.1/SustainabilityRisksDemedToBeRelevant**

|            |  |
|------------|--|
| diagram    | <p>The diagram shows the element <b>SustainabilityRisksDemedToBe...</b> (70000_Financial_Instrument_Sustainability_Risk_Is_Deemed_To_Be_Relevant).</p> |
| type       | <p><a href="#">EETYesNoType</a></p>  |
| properties | <p>isRef 0<br/> minOcc 0<br/> maxOcc 1<br/> content simple</p>   |
| facets     | <p>Kind Value annotation<br/> length 1</p>   |
| annotation | <p>documentation<br/> 70000_Financial_Instrument_Sustainability_Risk_Is_Deemed_To_Be_Relevant<br/> SFDR art 6.1<br/> Yes / No</p>                      |

element **EETReportType1.1.1/SupplementaryFieldsV1.1/TotalFundAUMORNational**

|         |   |
|---------|---|
| diagram | <p>The diagram shows the element <b>TotalFundAUMORNational</b> (70010_Financial_Instrument_Total_Fund_AUM_Or_Notional).</p> |
| type    | <p>restriction of <b>xs:decimal</b></p>   |

|            |   |
|------------|---|
| properties | isRef 0<br>minOcc 0<br>maxOcc 1<br>content simple   |
| annotation | documentation<br>70010_Financial_Instrument_Total_Fund_AUM_Or_Notional<br>AUM for a fund and Notional for structured products at PAI_End_Of_Reference_Period in EUR |

element **EETReportType1.1.1/StructuredProductsAdditionalInformation**

|            |   |
|------------|---|
| diagram    | <p><b>StructuredProductsAdditional...</b><br/>80000 - 80050</p> <ul style="list-style-type: none"> <li><b>UseOfProceedsAssetPooling</b><br/>80000 Defines if use of proceeds constitute<br/>S - Segregated Sustainable Asset Pool (SAP)<br/>U - Unsegregated Sustainable Asset Pool (USAP)<br/>N - Not a pooled approach (N) and therefore a general part of the balance sheet of the Issuer/Manufacturer"</li> <li><b>UseOfDerivativeExposure</b><br/>80010 Defines if the derivative exposure of a Structured Product is considered part of the assessed Taxonomy Alignment and Minimum Proportion of Sustainable Investment reported.</li> <li><b>StructuredProductFundingRelat...</b><br/>80020 Conditional to 20420 is filled and 80010 is set to Y. Means the percentage points reported in 20420 if only Funding component is considered.</li> <li><b>StructuredProductDerivateExpo...</b><br/>80030 Conditional to 20420 is filled and 80010 is set to Y. Means the percentage points reported in 20420 related to Derivative Exposure.</li> <li><b>StructuredProductFundingRelat...</b><br/>80040 Conditional to 20450 is filled and 80010 is set to Y. Means the percentage points reported in 20450 if only Funding component is considered.</li> <li><b>StructuredProductDerivateExpo...</b><br/>80050 Conditional to 20450 is filled and 80010 is set to Y. Means the percentage points reported in 20450 related to Derivative Exposure.</li> </ul> |
| properties | isRef 0<br>minOcc 0<br>maxOcc 1   |



|            |   |
|------------|---|
|            | content complex   |
| children   | <a href="#">UseOfProceedsAssetPooling</a> <a href="#">UseOfDerivativeExposure</a><br><a href="#">StructuredProductFundingRelatedEUSFDRMinimumOrPlannedInvestmentsSustainableInvestments</a><br><a href="#">StructuredProductDerivateExposureRelatedEUSFDRMinimumOrPlannedInvestmentsSustainableInvestments</a><br><a href="#">StructuredProductFundingRelatedEUSFDRMinimumOrPlannedInvestmentsSustainableInvestmentsTaxonomyAligned</a><br><a href="#">StructuredProductDerivateExposureRelatedEUSFDRMinimumOrPlannedInvestmentsSustainableInvestmentsTaxonomyAligned</a> |
| annotation | documentation<br>80000 - 80050  |

element **EETReportType1.1.1/StructuredProductsAdditionalInformation/UseOfProceedsAssetPooling**

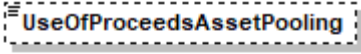
|            |   |
|------------|---|
| diagram    |  <p>80000 Defines if use of proceeds constitute<br/>S - Segregated Sustainable Asset Pool (SAP)<br/>U - Unsegregated Sustainable Asset Pool (USAP)<br/>N - Not a pooled approach (N) and therefore a general part of the balance sheet of the Issuer/Manufacturer"</p> |
| type       | restriction of <b>xs:string</b>   |
| properties | isRef 0<br>minOcc 0<br>maxOcc 1<br>content simple   |
| annotation | documentation<br>80000 Defines if use of proceeds constitute<br>S - Segregated Sustainable Asset Pool (SAP)<br>U - Unsegregated Sustainable Asset Pool (USAP)<br>N - Not a pooled approach (N) and therefore a general part of the balance sheet of the Issuer/Manufacturer"  |

element **EETReportType1.1.1/StructuredProductsAdditionalInformation/UseOfDerivativeExposure**

|            |  |
|------------|--|
| diagram    |  <p>80010 Defines if the derivative exposure of a Structured Product is considered part of the assessed Taxonomy Alignment and Minimum Proportion of Sustainable Investment reported.</p> |
| type       | <a href="#">EETYesNoType</a>   |
| properties | isRef 0<br>minOcc 0<br>maxOcc 1<br>content simple  |
| facets     | Kind Value annotation<br>length 1  |
| annotation | documentation<br>80010 Defines if the derivative exposure of a Structured Product is considered part of the assessed Taxonomy Alignment and Minimum Proportion of Sustainable Investment reported.   |

element

**EETReportType1.1.1/StructuredProductsAdditionalInformation/StructuredProductFundingRelatedEUSFDRMinimumOrPlannedInvestmentsSustainableInvestments**

|            |   |
|------------|---|
| diagram    |  <b>StructuredProductFundingRelat...</b><br>80020 Conditional to 20420 is filled and 80010 is set to Y. Means the percentage points reported in 20420 if only Funding component is considered. |
| type       | <b>xs:decimal</b>   |
| properties | isRef 0<br>minOcc 0<br>maxOcc 1<br>content simple   |
| annotation | documentation<br>80020 Conditional to 20420 is filled and 80010 is set to Y. Means the percentage points reported in 20420 if only Funding component is considered.   |

element

**EETReportType1.1.1/StructuredProductsAdditionalInformation/StructuredProductDerivateExposureRelatedEUSFDRMinimumOrPlannedInvestmentsSustainableInvestments**

|            |   |
|------------|---|
| diagram    |  <b>StructuredProductDerivateExpo...</b><br>80030 Conditional to 20420 is filled and 80010 is set to Y. Means the percentage points reported in 20420 related to Derivative Exposure. |
| type       | <b>xs:decimal</b>   |
| properties | isRef 0<br>minOcc 0<br>maxOcc 1<br>content simple   |
| annotation | documentation<br>80030 Conditional to 20420 is filled and 80010 is set to Y. Means the percentage points reported in 20420 related to Derivative Exposure.  |

element

**EETReportType1.1.1/StructuredProductsAdditionalInformation/StructuredProductFundingRelatedEUSFDRMinimumOrPlannedInvestmentsSustainableInvestmentsTaxonomyAligned**

|            |   |
|------------|---|
| diagram    |  <b>StructuredProductFundingRelat...</b><br>80040 Conditional to 20450 is filled and 80010 is set to Y. Means the percentage points reported in 20450 if only Funding component is considered. |
| type       | <b>xs:decimal</b>   |
| properties | isRef 0<br>minOcc 0   |

|            |   |
|------------|---|
|            | maxOcc 1<br>content simple  |
| annotation | documentation<br>80040 Conditional to 20450 is filled and 80010 is set to Y. Means the percentage points reported in 20450 if only Funding component is considered. |

element

**EETReportType1.1.1/StructuredProductsAdditionalInformation/StructuredProductDerivateExposureRelatedEUSFDRMinimumOrPlannedInvestmentsSustainableInvestmentsTaxonomyAligned**

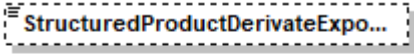
|            |  |
|------------|--|
| diagram    |  <p>80050 Conditional to 20450 is filled and 80010 is set to Y. Means the percentage points reported in 20450 related to Derivative Exposure.</p> |
| type       | <b>xs:decimal</b>  |
| properties | isRef 0<br>minOcc 0<br>maxOcc 1<br>content simple  |
| annotation | documentation<br>80050 Conditional to 20450 is filled and 80010 is set to Y. Means the percentage points reported in 20450 related to Derivative Exposure.   |

element EETReportType1.1/SupplementaryTaxonomyInformationV1.1.1

diagram

SupplementaryTaxonomyInfor...  
9000 9020

- InvestingEU Taxonomy Aligned...  
9000\_Financial\_Instrument\_Investing\_In\_EU\_Taxonomy\_Aligned\_Fossil\_Gas\_Activites
- Minimum Percentage Investments...  
9001\_Financial\_Instrument\_Minimum\_Percentage\_Investments\_Aligned\_EU\_Taxonomy\_Fossil\_Gas\_End\_Sovereign\_Bonds
- Minimum Percentage Investments...  
9002\_Financial\_Instrument\_Minimum\_Percentage\_Investments\_Aligned\_EU\_Taxonomy\_Fossil\_Gas\_End\_Sovereign\_Bonds
- InvestingEU Taxonomy Aligned...  
9003\_Financial\_Instrument\_Investing\_In\_EU\_Taxonomy\_Aligned\_Nuclear\_Activites
- Minimum Percentage Investments...  
9004\_Financial\_Instrument\_Minimum\_Percentage\_Investments\_Aligned\_EU\_Taxonomy\_Nuclear\_End\_Sovereign\_Bonds
- Minimum Percentage Investments...  
9005\_Financial\_Instrument\_Minimum\_Percentage\_Investments\_Aligned\_EU\_Taxonomy\_Nuclear\_End\_Sovereign\_Bonds
- Minimum Percentage Investments...  
9006\_Financial\_Instrument\_Minimum\_Percentage\_Investments\_Aligned\_EU\_Taxonomy\_Fossil\_Gas\_and\_Nuclear\_End\_Sovereign\_Bonds
- Minimum Percentage Investments...  
9007\_Financial\_Instrument\_Minimum\_Percentage\_Investments\_Aligned\_EU\_Taxonomy\_Fossil\_Gas\_and\_Nuclear\_End\_Sovereign\_Bonds
- Current Percentage Investments...  
9008\_Financial\_Instrument\_Current\_Percentage\_Investments\_Aligned\_EU\_Taxonomy\_Fossil\_Gas\_End\_Sovereign\_Bonds\_Turnover
- Current Percentage Investments...  
9009\_Financial\_Instrument\_Current\_Percentage\_Investments\_Aligned\_EU\_Taxonomy\_Fossil\_Gas\_End\_Sovereign\_Bonds\_Turnover
- Current Percentage Investments...  
9010\_Financial\_Instrument\_Current\_Percentage\_Investments\_Aligned\_EU\_Taxonomy\_Nuclear\_End\_Sovereign\_Bonds\_Turnover
- Current Percentage Investments...  
9011\_Financial\_Instrument\_Current\_Percentage\_Investments\_Aligned\_EU\_Taxonomy\_Nuclear\_End\_Sovereign\_Bonds\_Turnover
- Current Percentage Investments...  
9012\_Financial\_Instrument\_Current\_Percentage\_Investments\_Aligned\_EU\_Taxonomy\_Fossil\_Gas\_and\_Nuclear\_End\_Sovereign\_Bonds\_Turnover
- Current Percentage Investments...  
9013\_Financial\_Instrument\_Current\_Percentage\_Investments\_Aligned\_EU\_Taxonomy\_Fossil\_Gas\_and\_Nuclear\_End\_Sovereign\_Bonds\_Turnover
- Current Percentage Investments...  
9014\_Financial\_Instrument\_Current\_Percentage\_Investments\_Aligned\_EU\_Taxonomy\_Fossil\_Gas\_End\_Sovereign\_Bonds\_Capex
- Current Percentage Investments...  
9015\_Financial\_Instrument\_Current\_Percentage\_Investments\_Aligned\_EU\_Taxonomy\_Fossil\_Gas\_End\_Sovereign\_Bonds\_Capex
- Current Percentage Investments...  
9016\_Financial\_Instrument\_Current\_Percentage\_Investments\_Aligned\_EU\_Taxonomy\_Nuclear\_End\_Sovereign\_Bonds\_Capex
- Current Percentage Investments...  
9017\_Financial\_Instrument\_Current\_Percentage\_Investments\_Aligned\_EU\_Taxonomy\_Nuclear\_End\_Sovereign\_Bonds\_Capex
- Current Percentage Investments...  
9018\_Financial\_Instrument\_Current\_Percentage\_Investments\_Aligned\_EU\_Taxonomy\_Fossil\_Gas\_and\_Nuclear\_End\_Sovereign\_Bonds\_Capex
- Current Percentage Investments...  
9019\_Financial\_Instrument\_Current\_Percentage\_Investments\_Aligned\_EU\_Taxonomy\_Fossil\_Gas\_and\_Nuclear\_End\_Sovereign\_Bonds\_Capex
- Current Percentage Investments...  
9020\_Financial\_Instrument\_Current\_Percentage\_Investments\_Aligned\_EU\_Taxonomy\_Fossil\_Gas\_End\_Sovereign\_Bonds\_Opex
- Current Percentage Investments...  
9021\_Financial\_Instrument\_Current\_Percentage\_Investments\_Aligned\_EU\_Taxonomy\_Fossil\_Gas\_End\_Sovereign\_Bonds\_Opex
- Current Percentage Investments...  
9022\_Financial\_Instrument\_Current\_Percentage\_Investments\_Aligned\_EU\_Taxonomy\_Nuclear\_End\_Sovereign\_Bonds\_Opex
- Current Percentage Investments...  
9023\_Financial\_Instrument\_Current\_Percentage\_Investments\_Aligned\_EU\_Taxonomy\_Nuclear\_End\_Sovereign\_Bonds\_Opex
- Current Percentage Investments...  
9024\_Financial\_Instrument\_Current\_Percentage\_Investments\_Aligned\_EU\_Taxonomy\_Fossil\_Gas\_and\_Nuclear\_End\_Sovereign\_Bonds\_Opex
- Current Percentage Investments...  
9025\_Financial\_Instrument\_Current\_Percentage\_Investments\_Aligned\_EU\_Taxonomy\_Fossil\_Gas\_and\_Nuclear\_End\_Sovereign\_Bonds\_Opex

|            |  |
|------------|--|
| properties | isRef 0<br>minOcc 0<br>maxOcc 1<br>content complex   |
| children   | <a href="#">InvestingInEUTaxonomyAlignedFossilGasActivities</a><br><a href="#">MinimumPercentageInvestmentsAlignedEUTaxonomyFossilGasInclSovereignBonds</a><br><a href="#">MinimumPercentageInvestmentsAlignedEUTaxonomyFossilGasExclSovereignBonds</a><br><a href="#">InvestingInEUTaxonomyAlignedNuclearActivities</a><br><a href="#">MinimumPercentageInvestmentsAlignedEUTaxonomyNuclearInclSovereignBonds</a><br><a href="#">MinimumPercentageInvestmentsAlignedEUTaxonomyNuclearExclSovereignBonds</a><br><a href="#">MinimumPercentageInvestmentsAlignedEUTaxonomyNoFossilGasandNuclearInclSovereignBonds</a><br><a href="#">MinimumPercentageInvestmentsAlignedEUTaxonomyNoFossilGasandNuclearExclSovereignBonds</a><br><a href="#">CurrentPercentageInvestmentsAlignedEUTaxonomyFossilGasInclSovereignBondsTurnover</a><br><a href="#">CurrentPercentageInvestmentsAlignedEUTaxonomyFossilGasExclSovereignBondsTurnover</a><br><a href="#">CurrentPercentageInvestmentsAlignedEUTaxonomyNuclearInclSovereignBondsTurnover</a><br><a href="#">CurrentPercentageInvestmentsAlignedEUTaxonomyNuclearExclSovereignBondsTurnover</a><br><a href="#">CurrentPercentageInvestmentsAlignedEUTaxonomyNoFossilGasandNuclearInclSovereignBondsTurnover</a><br><a href="#">CurrentPercentageInvestmentsAlignedEUTaxonomyNoFossilGasandNuclearExclSovereignBondsTurnover</a><br><a href="#">CurrentPercentageInvestmentsAlignedEUTaxonomyFossilGasInclSovereignBondsCapex</a><br><a href="#">CurrentPercentageInvestmentsAlignedEUTaxonomyFossilGasExclSovereignBondsCapex</a><br><a href="#">CurrentPercentageInvestmentsAlignedEUTaxonomyNuclearInclSovereignBondsCapex</a><br><a href="#">CurrentPercentageInvestmentsAlignedEUTaxonomyNuclearExclSovereignBondsCapex</a><br><a href="#">CurrentPercentageInvestmentsAlignedEUTaxonomyNoFossilGasandNuclearInclSovereignBondsCapex</a><br><a href="#">CurrentPercentageInvestmentsAlignedEUTaxonomyNoFossilGasandNuclearExclSovereignBondsCapex</a><br><a href="#">CurrentPercentageInvestmentsAlignedEUTaxonomyFossilGasInclSovereignBondsOpex</a><br><a href="#">CurrentPercentageInvestmentsAlignedEUTaxonomyFossilGasExclSovereignBondsOpex</a><br><a href="#">CurrentPercentageInvestmentsAlignedEUTaxonomyNuclearInclSovereignBondsOpex</a><br><a href="#">CurrentPercentageInvestmentsAlignedEUTaxonomyNuclearExclSovereignBondsOpex</a><br><a href="#">CurrentPercentageInvestmentsAlignedEUTaxonomyNoFossilGasandNuclearInclSovereignBondsOpex</a><br><a href="#">CurrentPercentageInvestmentsAlignedEUTaxonomyNoFossilGasandNuclearExclSovereignBondsOpex</a> |
| annotation | documentation<br>90000- 90250  |

element

**EETReportType1.1.1/SupplementaryTaxonomyInformationV1.1.1/InvestingInEUTaxonomyAlignedFossil GasActivities**

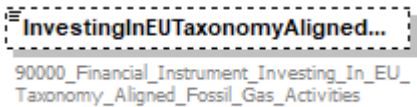
|            |  |
|------------|--|
| diagram    |                 |
| type       | <a href="#">EETYesNoType</a>   |
| properties | isRef 0<br>minOcc 0<br>maxOcc 1<br>content simple  |
| facets     | Kind Value annotation<br>length 1  |
| annotation | documentation<br>90000_Financial_Instrument_Investing_In_EU_Taxonomy_Aligned_Fossil_Gas_Activities |

element

**EETReportType1.1.1/SupplementaryTaxonomyInformationV1.1.1/MinimumPercentageInvestmentsAlignedEUTaxonomyFossilGasInclSovereignBonds**

|            |   |
|------------|---|
| diagram    |  <b>MinimumPercentageInvestmen...</b><br>90010_Financial_Instrument_Minimum_Percentage_Investments_Aligned_EU_Taxonomy_Fossil_Gas_Incl_Sovereign_Bonds |
| type       | <b>xs:decimal</b>   |
| properties | isRef 0<br>minOcc 0<br>maxOcc 1<br>content simple   |
| annotation | documentation<br>90010_Financial_Instrument_Minimum_Percentage_Investments_Aligned_EU_Taxonomy_Fossil_Gas_Incl_Sovereign_Bonds  |

element

**EETReportType1.1.1/SupplementaryTaxonomyInformationV1.1.1/MinimumPercentageInvestmentsAlignedEUTaxonomyFossilGasExclSovereignBonds**

|            |   |
|------------|---|
| diagram    |  <b>MinimumPercentageInvestmen...</b><br>90020_Financial_Instrument_Minimum_Percentage_Investments_Aligned_EU_Taxonomy_Fossil_Gas_Excl_Sovereign_Bonds |
| type       | <b>xs:decimal</b>   |
| properties | isRef 0<br>minOcc 0<br>maxOcc 1<br>content simple   |
| annotation | documentation<br>90020_Financial_Instrument_Minimum_Percentage_Investments_Aligned_EU_Taxonomy_Fossil_Gas_Excl_Sovereign_Bonds  |

element

**EETReportType1.1.1/SupplementaryTaxonomyInformationV1.1.1/InvestingInEUTaxonomyAlignedNuclearActivities**

|            |  |
|------------|--|
| diagram    |  <b>InvestingInEUTaxonomyAligned...</b><br>90030_Financial_Instrument_Investing_In_EU_Taxonomy_Aligned_Nuclear_Activities |
| type       | <a href="#">EETYesNoType</a>   |
| properties | isRef 0<br>minOcc 0<br>maxOcc 1<br>content simple  |
| facets     | Kind Value annotation<br>length 1  |

|            |   |
|------------|---|
| annotation | documentation<br>90030_Financial_Instrument_Investing_In_EU_Taxonomy_Aligned_Nuclear_Activities |
|------------|---|

element

**EETReportType1.1.1/SupplementaryTaxonomyInformationV1.1.1/MinimumPercentageInvestmentsAlignedEUTaxonomyNuclearInclSovereignBonds**

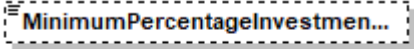
|            |   |
|------------|---|
| diagram    |  <p>90040_Financial_Instrument_Minimum_Percentage_Investments_Aligned_EU_Taxonomy_Nuclear_Incl_Sovereign_Bonds</p> |
| type       | <b>xs:decimal</b>   |
| properties | isRef 0<br>minOcc 0<br>maxOcc 1<br>content simple   |
| annotation | documentation<br>90040_Financial_Instrument_Minimum_Percentage_Investments_Aligned_EU_Taxonomy_Nuclear_Incl_Sovereign_Bonds   |

element

**EETReportType1.1.1/SupplementaryTaxonomyInformationV1.1.1/MinimumPercentageInvestmentsAlignedEUTaxonomyNuclearExclSovereignBonds**

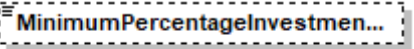
|            |   |
|------------|---|
| diagram    |  <p>90050_Financial_Instrument_Minimum_Percentage_Investments_Aligned_EU_Taxonomy_Nuclear_Excl_Sovereign_Bonds</p> |
| type       | <b>xs:decimal</b>   |
| properties | isRef 0<br>minOcc 0<br>maxOcc 1<br>content simple   |
| annotation | documentation<br>90050_Financial_Instrument_Minimum_Percentage_Investments_Aligned_EU_Taxonomy_Nuclear_Excl_Sovereign_Bonds   |

element

**EETReportType1.1.1/SupplementaryTaxonomyInformationV1.1.1/MinimumPercentageInvestmentsAlignedEUTaxonomyNoFossilGasandNuclearInclSovereignBonds**

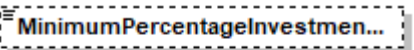
|            |   |
|------------|---|
| diagram    |  <p>90060_Financial_Instrument_Minimum_Percentage_Investments_Aligned_EU_Taxonomy_No_Fossil_Gas_and_Nuclear_Incl_Sovereign_Bonds</p> |
| type       | <b>xs:decimal</b>   |
| properties | isRef 0<br>minOcc 0<br>maxOcc 1<br>content simple   |
| annotation | documentation<br>90060_Financial_Instrument_Minimum_Percentage_Investments_Aligned_EU_Taxonomy_No_Fossil_Gas_and_Nuclear_Incl_Sovereign_Bonds   |

|                      |
|----------------------|
| Incl_Sovereign_Bonds |
|----------------------|

element

**EETReportType1.1.1/SupplementaryTaxonomyInformationV1.1.1/MinimumPercentageInvestmentsAlignedEUTaxonomyNoFossilGasandNuclearExclSovereignBonds**

|            |  |
|------------|--|
| diagram    |  <b>MinimumPercentageInvestmen...</b><br>90070_Financial_Instrument_Minimum_Percentage_Investments_Aligned_EU_Taxonomy_No_Fossil_Gas_and_Nuclear_Excl_Sovereign_Bonds |
| type       | <b>xs:decimal</b>  |
| properties | isRef 0<br>minOcc 0<br>maxOcc 1<br>content simple  |
| annotation | documentation<br>90070_Financial_Instrument_Minimum_Percentage_Investments_Aligned_EU_Taxonomy_No_Fossil_Gas_and_Nuclear_Excl_Sovereign_Bonds  |

element

**EETReportType1.1.1/SupplementaryTaxonomyInformationV1.1.1/CurrentPercentageInvestmentsAlignedEUTaxonomyFossilGasInclSovereignBondsTurnover**

|            |   |
|------------|---|
| diagram    |  <b>CurrentPercentageInvestments...</b><br>90080_Financial_Instrument_Current_Percentage_Investments_Aligned_EU_Taxonomy_Fossil_Gas_Incl_Sovereign_Bonds_Turnover |
| type       | <b>xs:decimal</b>   |
| properties | isRef 0<br>minOcc 0<br>maxOcc 1<br>content simple   |
| annotation | documentation<br>90080_Financial_Instrument_Current_Percentage_Investments_Aligned_EU_Taxonomy_Fossil_Gas_Incl_Sovereign_Bonds_Turnover   |

element

**EETReportType1.1.1/SupplementaryTaxonomyInformationV1.1.1/CurrentPercentageInvestmentsAlignedEUTaxonomyFossilGasExclSovereignBondsTurnover**

|            |  |
|------------|--|
| diagram    |  <b>CurrentPercentageInvestments...</b><br>90090_Financial_Instrument_Current_Percentage_Investments_Aligned_EU_Taxonomy_Fossil_Gas_Excl_Sovereign_Bonds_Turnover |
| type       | <b>xs:decimal</b>  |
| properties | isRef 0<br>minOcc 0<br>maxOcc 1<br>content simple  |
| annotation | documentation<br>90090_Financial_Instrument_Current_Percentage_Investments_Aligned_EU_Taxonomy_Fossil_Gas_Excl_Sovereign_Bonds_Turnover  |



element

**EETReportType1.1.1/SupplementaryTaxonomyInformationV1.1.1/CurrentPercentageInvestmentsAlignedEUTaxonomyNuclearInclSovereignBondsTurnover**

|            |   |
|------------|---|
| diagram    |  <b>CurrentPercentageInvestments...</b><br>90100_Financial_Instrument_Current_Percentage_Investments_Aligned_EU_Taxonomy_Nuclear_Incl_Sovereign_Bonds_Turnover |
| type       | <b>xs:decimal</b>   |
| properties | isRef 0<br>minOcc 0<br>maxOcc 1<br>content simple   |
| annotation | documentation<br>90100_Financial_Instrument_Current_Percentage_Investments_Aligned_EU_Taxonomy_Nuclear_Incl_Sovereign_Bonds_Turnover  |

element

**EETReportType1.1.1/SupplementaryTaxonomyInformationV1.1.1/CurrentPercentageInvestmentsAlignedEUTaxonomyNuclearExclSovereignBondsTurnover**

|            |  |
|------------|--|
| diagram    |  <b>CurrentPercentageInvestments...</b><br>90110_Financial_Instrument_Current_Percentage_Investments_Aligned_EU_Taxonomy_Nuclear_Excl_Sovereign_Bonds_Turnover |
| type       | <b>xs:decimal</b>  |
| properties | isRef 0<br>minOcc 0<br>maxOcc 1<br>content simple  |
| annotation | documentation<br>90110_Financial_Instrument_Current_Percentage_Investments_Aligned_EU_Taxonomy_Nuclear_Excl_Sovereign_Bonds_Turnover   |

element

**EETReportType1.1.1/SupplementaryTaxonomyInformationV1.1.1/CurrentPercentageInvestmentsAlignedEUTaxonomyNoFossilGasandNuclearInclSovereignBondsTurnover**

|            |   |
|------------|---|
| diagram    |  <b>CurrentPercentageInvestments...</b><br>90120_Financial_Instrument_Current_Percentage_Investments_Aligned_EU_Taxonomy_No_Fossil_Gas_and_Nuclear_Incl_Sovereign_Bonds_Turnover |
| type       | <b>xs:decimal</b>   |
| properties | isRef 0<br>minOcc 0   |

|            |  |
|------------|--|
|            | maxOcc 1<br>content simple   |
| annotation | documentation<br>90120_Financial_Instrument_Current_Percentage_Investments_Aligned_EU_Taxonomy_No_Fossil_Gas_and_Nuclear_Incl_Sovereign_Bonds_Turnover |

element

**EETReportType1.1.1/SupplementaryTaxonomyInformationV1.1.1/CurrentPercentageInvestmentsAlignedEUTaxonomyNoFossilGasandNuclearExclSovereignBondsTurnover**

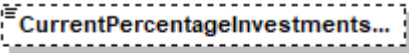
|            |  |
|------------|--|
| diagram    |  <p>90130_Financial_Instrument_Current_Percentage_Investments_Aligned_EU_Taxonomy_No_Fossil_Gas_and_Nuclear_Excl_Sovereign_Bonds_Turnover</p> |
| type       | <b>xs:decimal</b>  |
| properties | isRef 0<br>minOcc 0<br>maxOcc 1<br>content simple  |
| annotation | documentation<br>90130_Financial_Instrument_Current_Percentage_Investments_Aligned_EU_Taxonomy_No_Fossil_Gas_and_Nuclear_Excl_Sovereign_Bonds_Turnover   |

element

**EETReportType1.1.1/SupplementaryTaxonomyInformationV1.1.1/CurrentPercentageInvestmentsAlignedEUTaxonomyFossilGasInclSovereignBondsCapex**

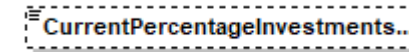
|            |  |
|------------|--|
| diagram    |  <p>90140_Financial_Instrument_Current_Percentage_Investments_Aligned_EU_Taxonomy_Fossil_Gas_Incl_Sovereign_Bonds_Capex</p> |
| type       | <b>xs:decimal</b>  |
| properties | isRef 0<br>minOcc 0<br>maxOcc 1<br>content simple  |
| annotation | documentation<br>90140_Financial_Instrument_Current_Percentage_Investments_Aligned_EU_Taxonomy_Fossil_Gas_Incl_Sovereign_Bonds_Capex   |

element

**EETReportType1.1.1/SupplementaryTaxonomyInformationV1.1.1/CurrentPercentageInvestmentsAlignedEUTaxonomyFossilGasExclSovereignBondsCapex**

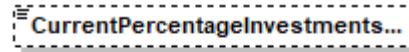
|            |  |
|------------|--|
| diagram    |  <p>90150_Financial_Instrument_Current_Percentage_Investments_Aligned_EU_Taxonomy_Fossil_Gas_Excl_Sovereign_Bonds_Capex</p> |
| type       | <b>xs:decimal</b>  |
| properties | isRef 0<br>minOcc 0<br>maxOcc 1  |

|            |  |
|------------|--|
|            | content simple   |
| annotation | documentation<br>90150_Financial_Instrument_Current_Percentage_Investments_Aligned_EU_Taxonomy_Fossil_Gas_Excl_Sovereign_Bonds_Capex |

element

**EETReportType1.1.1/SupplementaryTaxonomyInformationV1.1.1/CurrentPercentageInvestmentsAlignedEUTaxonomyNuclearInclSovereignBondsCapex**

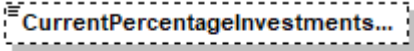
|            |   |
|------------|---|
| diagram    |  <p>90160_Financial_Instrument_Current_Percentage_Investments_Aligned_EU_Taxonomy_Nuclear_Incl_Sovereign_Bonds_Capex</p> |
| type       | <b>xs:decimal</b>   |
| properties | isRef 0<br>minOcc 0<br>maxOcc 1<br>content simple   |
| annotation | documentation<br>90160_Financial_Instrument_Current_Percentage_Investments_Aligned_EU_Taxonomy_Nuclear_Incl_Sovereign_Bonds_Capex   |

element

**EETReportType1.1.1/SupplementaryTaxonomyInformationV1.1.1/CurrentPercentageInvestmentsAlignedEUTaxonomyNuclearExclSovereignBondsCapex**

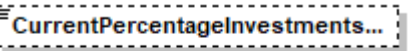
|            |   |
|------------|---|
| diagram    |  <p>90170_Financial_Instrument_Current_Percentage_Investments_Aligned_EU_Taxonomy_Nuclear_Excl_Sovereign_Bonds_Capex</p> |
| type       | <b>xs:decimal</b>   |
| properties | isRef 0<br>minOcc 0<br>maxOcc 1<br>content simple   |
| annotation | documentation<br>90170_Financial_Instrument_Current_Percentage_Investments_Aligned_EU_Taxonomy_Nuclear_Excl_Sovereign_Bonds_Capex   |

element

**EETReportType1.1.1/SupplementaryTaxonomyInformationV1.1.1/CurrentPercentageInvestmentsAlignedEUTaxonomyNoFossilGasandNuclearInclSovereignBondsCapex**

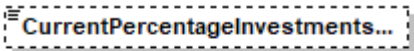
|            |   |
|------------|---|
| diagram    |  <p>90180_Financial_Instrument_Current_Percentage_Investments_Aligned_EU_Taxonomy_No_Fossil_Gas_and_Nuclear_Incl_Sovereign_Bonds_Capex</p> |
| type       | <b>xs:decimal</b>   |
| properties | isRef 0<br>minOcc 0<br>maxOcc 1   |

|            |   |
|------------|---|
|            | content simple  |
| annotation | documentation<br>90180_Financial_Instrument_Current_Percentage_Investments_Aligned_EU_Taxonomy_No_Fossil_Gas_and_Nuclear_Incl_Sovereign_Bonds_Capex |

element

**EETReportType1.1.1/SupplementaryTaxonomyInformationV1.1.1/CurrentPercentageInvestmentsAlignedEUTaxonomyNoFossilGasandNuclearExclSovereignBondsCapex**

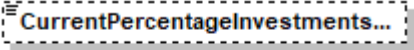
|            |   |
|------------|---|
| diagram    |  <p>90190_Financial_Instrument_Current_Percentage_Investments_Aligned_EU_Taxonomy_No_Fossil_Gas_and_Nuclear_Excl_Sovereign_Bonds_Capex</p> |
| type       | <b>xs:decimal</b>   |
| properties | isRef 0<br>minOcc 0<br>maxOcc 1<br>content simple   |
| annotation | documentation<br>90190_Financial_Instrument_Current_Percentage_Investments_Aligned_EU_Taxonomy_No_Fossil_Gas_and_Nuclear_Excl_Sovereign_Bonds_Capex   |

element

**EETReportType1.1.1/SupplementaryTaxonomyInformationV1.1.1/CurrentPercentageInvestmentsAlignedEUTaxonomyFossilGasInclSovereignBondsOpex**

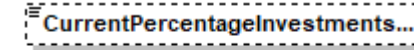
|            |   |
|------------|---|
| diagram    |  <p>90200_Financial_Instrument_Current_Percentage_Investments_Aligned_EU_Taxonomy_Fossil_Gas_Incl_Sovereign_Bonds_Opex</p> |
| type       | <b>xs:decimal</b>   |
| properties | isRef 0<br>minOcc 0<br>maxOcc 1<br>content simple   |
| annotation | documentation<br>90200_Financial_Instrument_Current_Percentage_Investments_Aligned_EU_Taxonomy_Fossil_Gas_Incl_Sovereign_Bonds_Opex   |

element

**EETReportType1.1.1/SupplementaryTaxonomyInformationV1.1.1/CurrentPercentageInvestmentsAlignedEUTaxonomyFossilGasExclSovereignBondsOpex**

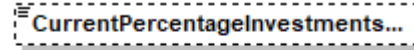
|            |   |
|------------|---|
| diagram    |  <p>90210_Financial_Instrument_Current_Percentage_Investments_Aligned_EU_Taxonomy_Fossil_Gas_Excl_Sovereign_Bonds_Opex</p> |
| type       | <b>xs:decimal</b>   |
| properties | isRef 0<br>minOcc 0<br>maxOcc 1<br>content simple   |

|            |   |
|------------|---|
| annotation | documentation<br>90210_Financial_Instrument_Current_Percentage_Investments_Aligned_EU_Taxonomy_Fossil_Gas_Excl_Sovereign_Bonds_Opex |
|------------|---|

element

**EETReportType1.1.1/SupplementaryTaxonomyInformationV1.1.1/CurrentPercentageInvestmentsAlignedEUTaxonomyNuclearInclSovereignBondsOpex**

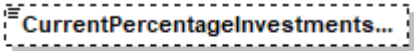
|            |  |
|------------|--|
| diagram    |  <p>90220_Financial_Instrument_Current_Percentage_Investments_Aligned_EU_Taxonomy_Nuclear_Incl_Sovereign_Bonds_Opex</p> |
| type       | <b>xs:decimal</b>  |
| properties | isRef 0<br>minOcc 0<br>maxOcc 1<br>content simple  |
| annotation | documentation<br>90220_Financial_Instrument_Current_Percentage_Investments_Aligned_EU_Taxonomy_Nuclear_Incl_Sovereign_Bonds_Opex   |

element

**EETReportType1.1.1/SupplementaryTaxonomyInformationV1.1.1/CurrentPercentageInvestmentsAlignedEUTaxonomyNuclearExclSovereignBondsOpex**

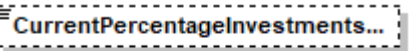
|            |   |
|------------|---|
| diagram    |  <p>90230_Financial_Instrument_Current_Percentage_Investments_Aligned_EU_Taxonomy_Nuclear_Excl_Sovereign_Bonds_Opex</p> |
| type       | <b>xs:decimal</b>   |
| properties | isRef 0<br>minOcc 0<br>maxOcc 1<br>content simple   |
| annotation | documentation<br>90230_Financial_Instrument_Current_Percentage_Investments_Aligned_EU_Taxonomy_Nuclear_Excl_Sovereign_Bonds_Opex  |

element

**EETReportType1.1.1/SupplementaryTaxonomyInformationV1.1.1/CurrentPercentageInvestmentsAlignedEUTaxonomyNoFossilGasandNuclearInclSovereignBondsOpex**

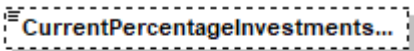
|            |  |
|------------|--|
| diagram    |  <p>90240_Financial_Instrument_Current_Percentage_Investments_Aligned_EU_Taxonomy_No_Fossil_Gas_and_Nuclear_Incl_Sovereign_Bonds_Opex</p> |
| type       | <b>xs:decimal</b>  |
| properties | isRef 0<br>minOcc 0<br>maxOcc 1<br>content simple  |
| annotation | documentation<br>90240_Financial_Instrument_Current_Percentage_Investments_Aligned_EU_Taxonomy_No_Fossil_Gas_and_Nuclear_  |

|                           |
|---------------------------|
| Incl_Sovereign_Bonds_Opex |
|---------------------------|

element

**EETReportType1.1.1/SupplementaryTaxonomyInformationV1.1.1/CurrentPercentageInvestmentsAlignedEU TaxonomyNoFossilGasandNuclearExclSovereignBondsOpex**

|            |  |
|------------|--|
| diagram    |  |
| type       | <b>xs:decimal</b>  |
| properties | isRef 0<br>minOcc 0<br>maxOcc 1<br>content simple  |
| annotation | documentation<br>90250_Financial_Instrument_Current_Percentage_Investments_Aligned_EU_Taxonomy_No_Fossil_Gas_and_Nuclear_Excl_Sovereign_Bonds_Opex |

element **EETReportType1.1.1/ComplementaryInformation**

|            |  |
|------------|--|
| diagram    |  |
| properties | isRef 0<br>minOcc 0<br>maxOcc 1<br>content complex |
| children   | <a href="#">Social</a>                             |
| annotation | documentation<br>100000                            |

element **EETReportType1.1.1/ComplementaryInformation/Social**

|            |  |
|------------|--|
| diagram    |  |
| properties | isRef 0<br>minOcc 0<br>maxOcc 1<br>content complex       |
| children   | <a href="#">ListOfCountriesSubjectToSocialViolations</a> |

element

**EETReportType1.1.1/ComplementaryInformation/Social/ListOfCountriesSubjectToSocialViolations**

|            |  |
|------------|--|
| diagram    |  <p>100000_List_Of_Countries_Subject_To_Social_Violations</p> |
| type       | restriction of <b>xs:string</b>  |
| properties | isRef 0<br>minOcc 0<br>maxOcc unbounded<br>content simple  |
| facets     | Kind Value annotation<br>maxLength 3   |
| annotation | documentation<br>100000_List_Of_Countries_Subject_To_Social_Violations   |

complexType **EETReportType1.1.2**

diagram





|          |  |
|----------|--|
| children | <a href="#">DataSetInformation</a> <a href="#">GeneralFinancialInstrumentInformation</a> <a href="#">MainCriteria</a> <a href="#">ProductDisclosures</a> <a href="#">SpecificInformationForArt8and9</a> <a href="#">ESGThematicInvestingDescription</a> <a href="#">ESGEngagementCoverage</a> <a href="#">ESGBenchmark</a> <a href="#">MinimumSustainableInvestments</a> <a href="#">LastReportedSustainableInvestments</a> <a href="#">AdditionalInfoArt9</a> <a href="#">MiFIDIDDTargetMarket</a> <a href="#">TaxonomyAlignedInvestments</a> <a href="#">PrincipalAdverseIndicators</a> <a href="#">ScreeningCriteria</a> <a href="#">CountrySpecificInformation</a> <a href="#">SupplementaryFieldsV1.1</a> <a href="#">StructuredProductsAdditionalInformation</a> <a href="#">SupplementaryTaxonomyInformationV1.1.1</a> <a href="#">ComplementaryInformation</a> |
| used by  | element <a href="#">EETsType1.1.2/EET1.1.2</a>   |

element **EETReportType1.1.2/DataSetInformation**

|            |  |
|------------|--|
| diagram    |  |
| properties | isRef 0<br>content complex   |
| children   | <a href="#">DataSetInformation</a> <a href="#">ManufacturerInformation</a> <a href="#">ManufacturerCommitmentToResponsibleInvestment</a> <a href="#">ManufacturerStewardshipCodeSignatory</a> <a href="#">ManufacturerWebsiteInformationStewardshipAndEngagement</a> |
| annotation | documentation<br>00010 - 13000   |

element **EETReportType1.1.2/DataSetInformation/DataSetInformation**

|            |   |
|------------|---|
| diagram    |   |
| properties | isRef 0<br>content complex  |
| children   | <a href="#">Version</a> <a href="#">Producer</a> <a href="#">FileGeneration</a> <a href="#">DataReporting</a> |
| annotation | documentation<br>00010 - 00100  |

element **EETReportType1.1.2/DataSetInformation/DataSetInformation/Version**

|            |  |
|------------|--|
| diagram    |  |
| type       | restriction of <b>xs:string</b>  |
| properties | isRef 0<br>content simple  |
| annotation | documentation<br>This field specifies the output version of the template and is used by the recipient to understand the number of fields expected, their labeling and order. |

element **EETReportType1.1.2/DataSetInformation/DataSetInformation/Producer**

|            |  |
|------------|--|
| diagram    |  |
| properties | isRef 0<br>minOcc 0<br>maxOcc 1<br>content complex   |
| children   | <a href="#">Name</a> <a href="#">LEI</a> <a href="#">Email</a>                                 |
| annotation | documentation<br>00020_EET_Producer_Name<br>00030_EET_Producer_LEI<br>00040_EET_Producer_Email |

element **EETReportType1.1.2/DataSetInformation/DataSetInformation/Producer/Name**

|            |   |
|------------|---|
| diagram    |   |
| type       | <b>xs:string</b>                                  |
| properties | isRef 0<br>minOcc 0<br>maxOcc 1<br>content simple |
| annotation | documentation<br>00020_EET_Producer_Name          |

element **EETReportType1.1.2/DataSetInformation/DataSetInformation/Producer/LEI**

|            |  |            |       |            |           |    |  |           |    |  |         |                           |  |
|------------|--|------------|-------|------------|-----------|----|--|-----------|----|--|---------|---------------------------|--|
| diagram    |  |            |       |            |           |    |  |           |    |  |         |                           |  |
| type       | <a href="#">LEICodeType</a>  |            |       |            |           |    |  |           |    |  |         |                           |  |
| properties | isRef 0<br>minOcc 0<br>maxOcc 1<br>content simple  |            |       |            |           |    |  |           |    |  |         |                           |  |
| facets     | <table border="0"> <tr> <td>Kind</td> <td>Value</td> <td>annotation</td> </tr> <tr> <td>minLength</td> <td>20</td> <td></td> </tr> <tr> <td>maxLength</td> <td>20</td> <td></td> </tr> <tr> <td>pattern</td> <td>([0-9a-zA-Z]{18}[0-9]{2})</td> <td></td> </tr> </table> | Kind       | Value | annotation | minLength | 20 |  | maxLength | 20 |  | pattern | ([0-9a-zA-Z]{18}[0-9]{2}) |  |
| Kind       | Value  | annotation |       |            |           |    |  |           |    |  |         |                           |  |
| minLength  | 20   |            |       |            |           |    |  |           |    |  |         |                           |  |
| maxLength  | 20   |            |       |            |           |    |  |           |    |  |         |                           |  |
| pattern    | ([0-9a-zA-Z]{18}[0-9]{2})  |            |       |            |           |    |  |           |    |  |         |                           |  |
| annotation | documentation<br>00030_EET_Producer_LEI  |            |       |            |           |    |  |           |    |  |         |                           |  |

element **EETReportType1.1.2/DataSetInformation/DataSetInformation/Producer/Email**

|            |   |
|------------|---|
| diagram    |  <p>00040_EET_Producer_Email</p> |
| type       | <b>xs:string</b>  |
| properties | isRef 0<br>minOcc 0<br>maxOcc 1<br>content simple   |
| annotation | documentation<br>00040_EET_Producer_Email   |

element **EETReportType1.1.2/DataSetInformation/DataSetInformation/FileGeneration**

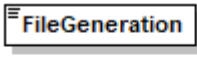
|            |   |
|------------|---|
| diagram    |  <p>00050_EET_File_Generation<br/>_Date_And_Time<br/>Date and Time of the<br/>creation of the EET file</p> |
| type       | <b>xs:dateTime</b>  |
| properties | isRef 0<br>content simple   |
| annotation | documentation<br>00050_EET_File_Generation_Date_And_Time<br>Date and Time of the creation of the EET file   |

element **EETReportType1.1.2/DataSetInformation/DataSetInformation/DataReporting**

|            |   |
|------------|---|
| diagram    |   |
| properties | isRef 0<br>content complex  |
| children   | <a href="#">SFDRPreContractual</a> <a href="#">SFDRPeriodic</a> <a href="#">SFDREntityLevel</a> <a href="#">MiFID</a> <a href="#">IDD</a> |
| annotation | documentation<br>00060 - 00100  |

element **EETReportType1.1.2/DataSetInformation/DataSetInformation/DataReporting/SFDRPreContractual**

|            |  |
|------------|--|
| diagram    |  |
| type       | <a href="#">EETYesNoType</a>                                   |
| properties | isRef 0<br>content simple                                      |
| facets     | Kind Value annotation<br>length 1                              |
| annotation | documentation<br>00060_EET_Data_Reporting_SFDR_Pre_Contractual |

element **EETReportType1.1.2/DataSetInformation/DataSetInformation/DataReporting/SFDRPeriodic**

|            |   |
|------------|---|
| diagram    |  <p>00070_EET_Data_Reporting_SFDR_Periodic<br/>No means that there is not yet a periodic reporting. The M related fields have not to be fulfilled"</p> |
| type       | <a href="#">EETYesNoType</a>  |
| properties | isRef 0<br>content simple   |
| facets     | Kind Value annotation<br>length 1   |
| annotation | documentation<br>00070_EET_Data_Reporting_SFDR_Periodic<br>No means that there is not yet a periodic reporting. The M related fields have not to be fulfilled"  |

element **EETReportType1.1.2/DataSetInformation/DataSetInformation/DataReporting/SFDREntityLevel**

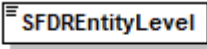
|            |   |
|------------|---|
| diagram    |  <p>00080_EET_Data_Reporting_SFDR_Entity_Level</p> |
| type       | <a href="#">EETYesNoType</a>  |
| properties | isRef 0<br>content simple   |
| facets     | Kind Value annotation<br>length 1   |
| annotation | documentation<br>00080_EET_Data_Reporting_SFDR_Entity_Level   |

element **EETReportType1.1.2/DataSetInformation/DataSetInformation/DataReporting/MiFID**

|            |   |
|------------|---|
| diagram    |  <p>00090_EET_Data_Reporting_Mifid</p> |
| type       | <a href="#">EETYesNoType</a>  |
| properties | isRef 0<br>content simple   |
| facets     | Kind Value annotation<br>length 1   |
| annotation | documentation<br>00090_EET_Data_Reporting_Mifid   |

element **EETReportType1.1.2/DataSetInformation/DataSetInformation/DataReporting/IDD**

|            |   |
|------------|---|
| diagram    | <p>IDD<br/>00100_EET_Data_Reporting_IDD</p>   |
| type       | <a href="#">EETYesNoType</a>                  |
| properties | isRef 0<br>content simple                     |
| facets     | Kind Value annotation<br>length 1             |
| annotation | documentation<br>00100_EET_Data_Reporting_IDD |

element **EETReportType1.1.2/DataSetInformation/ManufacturerInformation**

|            |  |
|------------|--|
| diagram    | <p><b>ManufacturerInformation</b><br/>10000 - 10040</p> <ul style="list-style-type: none"> <li><b>Name</b><br/>10000_Manufacturer_Name<br/>Name of the Manufacturer</li> <li><b>CodeType</b><br/>10010_Manufacturer_Code_Type<br/>Type<br/>Codification used to determine the identification code. Either LEI or None.</li> <li><b>Code</b><br/>10020_Manufacturer_Code<br/>Identification code of the Manufacturer</li> <li><b>Email</b><br/>10030_Manufacturer_Email<br/>Contact entry point for distributors for content question</li> <li><b>GeneralReferenceDate</b><br/>10040_General_Reference_Date<br/>Date to which the general data refer</li> </ul> |
| properties | isRef 0<br>content complex   |
| children   | <a href="#">Name</a> <a href="#">CodeType</a> <a href="#">Code</a> <a href="#">Email</a> <a href="#">GeneralReferenceDate</a>  |
| annotation | documentation<br>10000 - 10040   |

element **EETReportType1.1.2/DataSetInformation/ManufacturerInformation/Name**

|         |  |
|---------|--|
| diagram | <p>Name<br/>10000_Manufacturer_Name<br/>Name of the Manufacturer</p> |
|---------|--|

|            |  |
|------------|--|
| type       | restriction of <b>xs:string</b>                                      |
| properties | isRef 0<br>content simple  |
| facets     | Kind Value annotation<br>maxLength 255                               |
| annotation | documentation<br>10000_Manufacturer_Name<br>Name of the Manufacturer |

element **EETReportType1.1.2/DataSetInformation/ManufacturerInformation/CodeType**

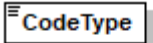
|            |   |
|------------|---|
| diagram    |  <p>10010_Manufacturer_Code_Type<br/>Codification used to determine the identification code. Either LEI or None.</p> |
| type       | restriction of <b>xs:string</b>   |
| properties | isRef 0<br>content simple   |
| annotation | documentation<br>10010_Manufacturer_Code_Type<br>Codification used to determine the identification code. Either LEI or None.  |

element **EETReportType1.1.2/DataSetInformation/ManufacturerInformation/Code**

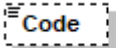
|            |  |
|------------|--|
| diagram    |  <p>10020_Manufacturer_Code<br/>Identification code of the Manufacturer</p> |
| type       | restriction of <b>xs:string</b>  |
| properties | isRef 0<br>minOcc 0<br>maxOcc 1<br>content simple  |
| facets     | Kind Value annotation<br>maxLength 255   |
| annotation | documentation<br>10020_Manufacturer_Code<br>Identification code of the Manufacturer  |

element **EETReportType1.1.2/DataSetInformation/ManufacturerInformation/Email**

|            |   |
|------------|---|
| diagram    |  <p>10030_Manufacturer_Email<br/>Contact entry point for distributors for content question</p> |
| type       | <b>xs:string</b>  |
| properties | isRef 0<br>minOcc 0<br>maxOcc 1<br>content simple   |



|            |  |
|------------|--|
| annotation | documentation<br>10030_Manufacturer_Email<br>Contact entry point for distributors for content question |
|------------|--|

element **EETReportType1.1.2/DataSetInformation/ManufacturerInformation/GeneralReferenceDate**

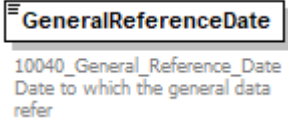
|            |  |
|------------|--|
| diagram    |  <p><b>GeneralReferenceDate</b><br/>10040_General_Reference_Date<br/>Date to which the general data refer</p> |
| type       | <b>xs:date</b>   |
| properties | isRef 0<br>content simple  |
| annotation | documentation<br>10040_General_Reference_Date<br>Date to which the general data refer  |

element **EETReportType1.1.2/DataSetInformation/ManufacturerCommitmentToResponsibleInvestment**

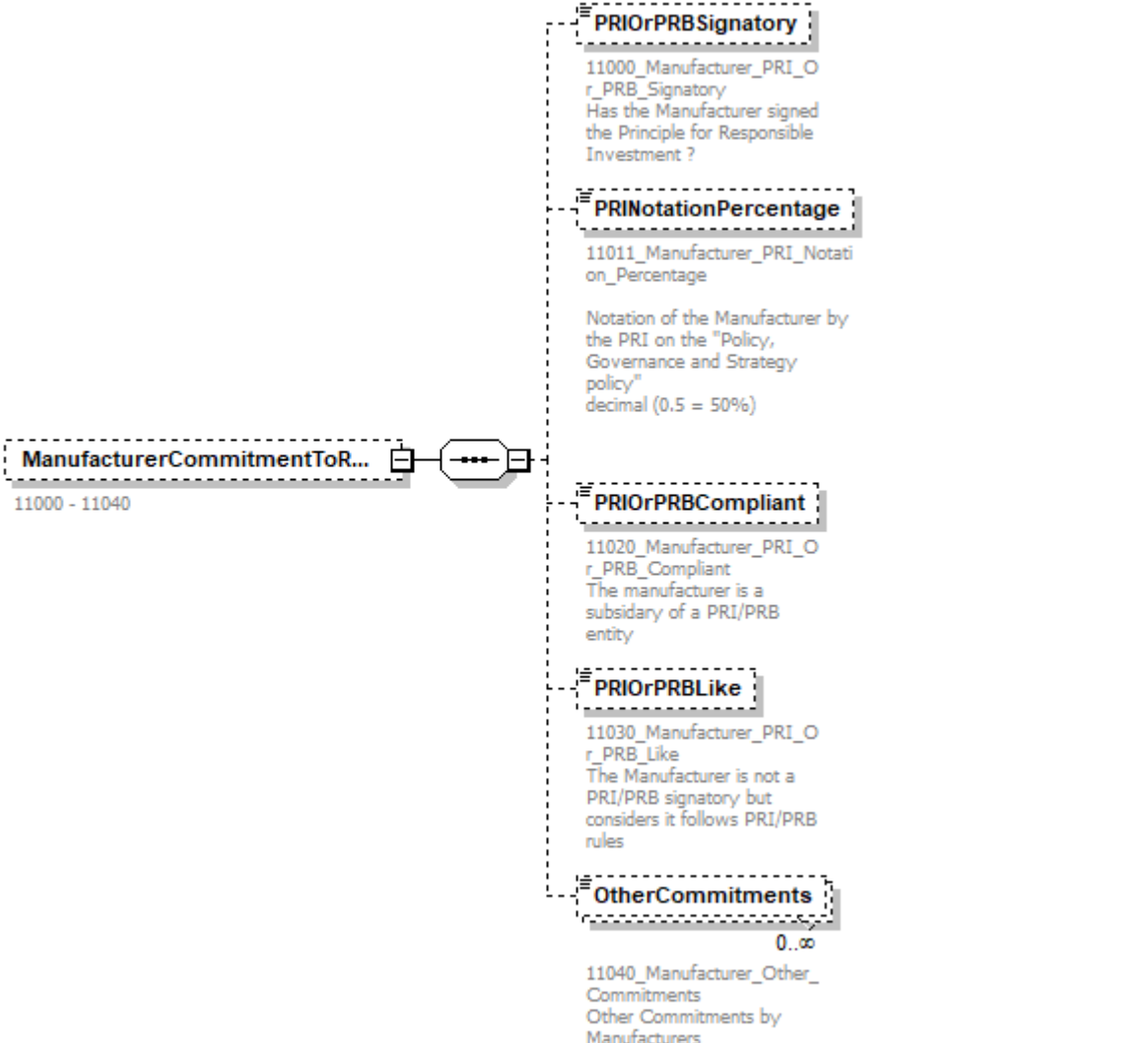
|         |   |
|---------|---|
| diagram |  <p><b>ManufacturerCommitmentToResponsibleInvestment</b><br/>11000 - 11040</p> <ul style="list-style-type: none"> <li><b>PRIOrPRBSignatory</b><br/>11000_Manufacturer_PRI_Or_PRB_Signatory<br/>Has the Manufacturer signed the Principle for Responsible Investment ?</li> <li><b>PRINotationPercentage</b><br/>11011_Manufacturer_PRI_Notation_Percentage<br/>Notation of the Manufacturer by the PRI on the "Policy, Governance and Strategy policy"<br/>decimal (0.5 = 50%)</li> <li><b>PRIOrPRBCompliant</b><br/>11020_Manufacturer_PRI_Or_PRB_Compliant<br/>The manufacturer is a subsidiary of a PRI/PRB entity</li> <li><b>PRIOrPRBLike</b><br/>11030_Manufacturer_PRI_Or_PRB_Like<br/>The Manufacturer is not a PRI/PRB signatory but considers it follows PRI/PRB rules</li> <li><b>OtherCommitments</b><br/>11040_Manufacturer_Other_Commitments<br/>Other Commitments by Manufacturers</li> </ul> |
|---------|---|

|            |   |
|------------|---|
| properties | isRef 0<br>minOcc 0<br>maxOcc 1<br>content complex  |
| children   | <a href="#">PRIOrPRBSignatory</a> <a href="#">PRINotationPercentage</a> <a href="#">PRIOrPRBCompliant</a> <a href="#">PRIOrPRBLike</a> <a href="#">OtherCommitments</a> |
| annotation | documentation<br>11000 - 11040  |

element

**EETReportType1.1.2/DataSetInformation/ManufacturerCommitmentToResponsibleInvestment/PRIOrPRBSignatory**

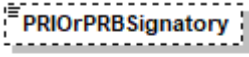
|            |   |
|------------|---|
| diagram    |  <p>11000_Manufacturer_PRI_Or_PRB_Signatory<br/>Has the Manufacturer signed the Principle for Responsible Investment ?</p> |
| type       | <a href="#">EETYesNoType</a>  |
| properties | isRef 0<br>minOcc 0<br>maxOcc 1<br>content simple   |
| facets     | Kind Value annotation<br>length 1   |
| annotation | documentation<br>11000_Manufacturer_PRI_Or_PRB_Signatory<br>Has the Manufacturer signed the Principle for Responsible Investment ?  |

element

**EETReportType1.1.2/DataSetInformation/ManufacturerCommitmentToResponsibleInvestment/PRINotationPercentage**

|            |   |
|------------|---|
| diagram    |  <p>11011_Manufacturer_PRI_Notation_Percentage<br/>Notation of the Manufacturer by the PRI on the "Policy, Governance and Strategy policy" decimal (0.5 = 50%)</p> |
| type       | <b>xs:decimal</b>   |
| properties | isRef 0<br>minOcc 0<br>maxOcc 1<br>content simple   |
| annotation | documentation<br>11011_Manufacturer_PRI_Notation_Percentage<br>Notation of the Manufacturer by the PRI on the "Policy, Governance and Strategy policy" decimal (0.5 = 50%)  |

element

### EETReportType1.1.2/DataSetInformation/ManufacturerCommitmentToResponsibleInvestment/PRIOrPRBCompliant

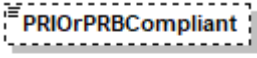
|            |   |
|------------|---|
| diagram    |  <p>11020_Manufacturer_PRI_Or_PRB_Compliant<br/>The manufacturer is a subsidiary of a PRI/PRB entity</p> |
| type       | <a href="#">EETYesNoType</a>  |
| properties | isRef 0<br>minOcc 0<br>maxOcc 1<br>content simple   |
| facets     | Kind Value annotation<br>length 1   |
| annotation | documentation<br>11020_Manufacturer_PRI_Or_PRB_Compliant<br>The manufacturer is a subsidiary of a PRI/PRB entity  |

element

### EETReportType1.1.2/DataSetInformation/ManufacturerCommitmentToResponsibleInvestment/PRIOrPRBLike

|            |   |
|------------|---|
| diagram    |  <p>11030_Manufacturer_PRI_Or_PRB_Like<br/>The Manufacturer is not a PRI/PRB signatory but considers it follows PRI/PRB rules</p> |
| type       | <a href="#">EETYesNoType</a>  |
| properties | isRef 0<br>minOcc 0<br>maxOcc 1<br>content simple   |
| facets     | Kind Value annotation<br>length 1   |
| annotation | documentation<br>11030_Manufacturer_PRI_Or_PRB_Like<br>The Manufacturer is not a PRI/PRB signatory but considers it follows PRI/PRB rules   |

element

### EETReportType1.1.2/DataSetInformation/ManufacturerCommitmentToResponsibleInvestment/OtherCommitments

|         |   |
|---------|---|
| diagram |  <p>0..∞<br/>11040_Manufacturer_Other_Commitments<br/>Other Commitments by Manufacturers</p> |
| type    | restriction of <b>xs:string</b>   |

|            |   |
|------------|---|
| properties | isRef 0<br>minOcc 0<br>maxOcc unbounded<br>content simple                                   |
| annotation | documentation<br>11040_Manufacturer_Other_Commitments<br>Other Commitments by Manufacturers |

element **EETReportType1.1.2/DataSetInformation/ManufacturerStewardshipCodeSignatory**

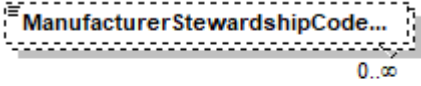
|            |  |
|------------|--|
| diagram    |  <p>12000_Manufacturer_Stewardship_Code_Signatory<br/>Disclosure of the applicable Stewardship Code</p> |
| type       | restriction of <b>xs:string</b>  |
| properties | isRef 0<br>minOcc 0<br>maxOcc unbounded<br>content simple  |
| annotation | documentation<br>12000_Manufacturer_Stewardship_Code_Signatory<br>Disclosure of the applicable Stewardship Code  |

element **EETReportType1.1.2/DataSetInformation/ManufacturerWebsiteInformationStewardshipAndEngagement**

|            |   |
|------------|---|
| diagram    |  <p>13000_Manufacturer_Website_Information_Stewardship_And_Engagement<br/>Internet adress where the client can find all relevant informations regarding stewardship and engagement of the manufacturer</p> |
| type       | <b>xs:string</b>  |
| properties | isRef 0<br>content simple   |
| annotation | documentation<br>13000_Manufacturer_Website_Information_Stewardship_And_Engagement<br>Internet adress where the client can find all relevant informations regarding stewardship and engagement of the manufacturer  |

element **EETReportType1.1.2/GeneralFinancialInstrumentInformation**

diagram

**GeneralFinancialInstrumentInf...**

20000 - 20030

**IdentifyingData**

20000\_Financial\_Instrument\_Identifying\_Data  
 Use the following priority:  
 - ISO 6166 code of ISIN when available  
 - Other recognised codes (e.g.: CUSIP, Bloomberg Ticker, Reuters RIC)  
 - Code attributed by the undertaking, when the options above are not available. Code must be unique and kept consistent over time

**TypeOfIdentification**

20010\_Financial\_Instrument\_Type\_Of\_Identification\_Code  
 One of the options in the following closed list to be used:  
 1 - ISO 6166 for ISIN code  
 2 - CUSIP (The Committee on Uniform Securities Identification Procedures number assigned by the CUSIP Service Bureau for U.S. and Canadian companies)  
 3 - SEDOL (Stock Exchange Daily Official List for the London Stock Exchange)  
 4 - WKN (Wertpapier Kenn-Nummer, the alphanumeric German identification number)  
 5 - Bloomberg Ticker (Bloomberg letters code that identify a company's securities)  
 6 - BBGID (The Bloomberg Global ID)  
 7 - Reuters RIC (Reuters instrument code)  
 8 - FIGI (Financial Instrument Global Identifier)  
 9 - Other code by members of the Association of National Numbering Agencies  
 10 - LEI  
 99 - Code attributed by the undertaking

**Name**

20020\_Financial\_Instrument\_Name  
 Name of the financial instrument

**Currency**

20030\_Financial\_Instrument\_Currency  
 Denomination Currency of the Financial Instrument

|            |  |
|------------|--|
| properties | isRef 0<br>content complex   |
| children   | <a href="#">IdentifyingData</a> <a href="#">TypeOfIdentification</a> <a href="#">Name</a> <a href="#">Currency</a> |
| annotation | documentation<br>20000 - 20030   |

element **EETReportType1.1.2/GeneralFinancialInstrumentInformation/IdentifyingData**

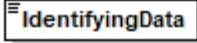
|            |   |
|------------|---|
| diagram    |  <p>20000_Financial_Instrument_Identifying_Data<br/>Use the following priority:<br/>- ISO 6166 code of ISIN when available<br/>- Other recognised codes (e.g.: CUSIP, Bloomberg Ticker, Reuters RIC)<br/>- Code attributed by the undertaking, when the options above are not available. Code must be unique and kept consistent over time</p> |
| type       | restriction of <b>xs:string</b>   |
| properties | isRef 0<br>content simple   |
| facets     | Kind Value annotation<br>maxLength 255  |
| annotation | documentation<br>20000_Financial_Instrument_Identifying_Data<br>Use the following priority:<br>- ISO 6166 code of ISIN when available<br>- Other recognised codes (e.g.: CUSIP, Bloomberg Ticker, Reuters RIC)<br>- Code attributed by the undertaking, when the options above are not available. Code must be unique and kept consistent over time   |

element **EETReportType1.1.2/GeneralFinancialInstrumentInformation/TypeOfIdentification**

|                   |   |
|-------------------|---|
| <p>diagram</p>    | <div style="border: 1px solid black; padding: 2px; margin-bottom: 5px;"> <b>TypeOfIdentification</b> </div> <p>20010_Financial_Instrument<br/>_Type_Of_Identification_Code</p> <p>One of the options in the following closed list to be used:</p> <ul style="list-style-type: none"> <li>1 - ISO 6166 for ISIN code</li> <li>2 - CUSIP (The Committee on Uniform Securities Identification Procedures number assigned by the CUSIP Service Bureau for U.S. and Canadian companies)</li> <li>3 - SEDOL (Stock Exchange Daily Official List for the London Stock Exchange)</li> <li>4 - WKN (Wertpapier Kenn-Nummer, the alphanumeric German identification number)</li> <li>5 - Bloomberg Ticker (Bloomberg letters code that identify a company's securities)</li> <li>6 - BBGID (The Bloomberg Global ID)</li> <li>7 - Reuters RIC (Reuters instrument code)</li> <li>8 - FIGI (Financial_Instrument Global Identifier)</li> <li>9 - Other code by members of the Association of National Numbering Agencies</li> <li>10 - LEI</li> <li>99 - Code attributed by the undertaking</li> </ul> |
| <p>type</p>       | <p>restriction of <b>xs:int</b></p>   |
| <p>properties</p> | <p>isRef 0<br/>content simple</p>   |
| <p>annotation</p> | <p>documentation</p> <p>20010_Financial_Instrument_Type_Of_Identification_Code</p> <p>One of the options in the following closed list to be used:</p> <ul style="list-style-type: none"> <li>1 - ISO 6166 for ISIN code</li> <li>2 - CUSIP (The Committee on Uniform Securities Identification Procedures number assigned by the CUSIP Service Bureau for U.S. and Canadian companies)</li> <li>3 - SEDOL (Stock Exchange Daily Official List for the London Stock Exchange)</li> <li>4 - WKN (Wertpapier Kenn-Nummer, the alphanumeric German identification number)</li> <li>5 - Bloomberg Ticker (Bloomberg letters code that identify a company's securities)</li> <li>6 - BBGID (The Bloomberg Global ID)</li> <li>7 - Reuters RIC (Reuters instrument code)</li> <li>8 - FIGI (Financial_Instrument Global Identifier)</li> <li>9 - Other code by members of the Association of National Numbering Agencies</li> <li>10 - LEI</li> <li>99 - Code attributed by the undertaking</li> </ul>   |

element **EETReportType1.1.2/GeneralFinancialInstrumentInformation/Name**

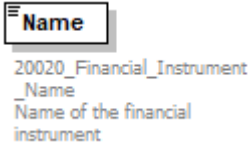
|            |  |
|------------|--|
| diagram    |     |
| type       | restriction of <b>xs:string</b>  |
| properties | isRef 0<br>content simple  |
| facets     | Kind Value annotation<br>maxLength 255   |
| annotation | documentation<br>20020_Financial_Instrument_Name<br>Name of the financial instrument |

element **EETReportType1.1.2/GeneralFinancialInstrumentInformation/Currency**

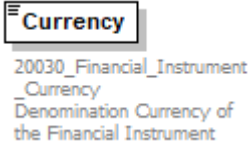
|            |   |
|------------|---|
| diagram    |                          |
| type       | <a href="#"><b>ISOCurrencyCodeType</b></a>  |
| properties | isRef 0<br>content simple   |
| facets     | Kind Value annotation<br>minLength 3<br>maxLength 3<br>pattern [A-Z]{3}                                   |
| annotation | documentation<br>20030_Financial_Instrument_Currency<br>Denomination Currency of the Financial Instrument |



element **EETReportType1.1.2/MainCriteria**

diagram

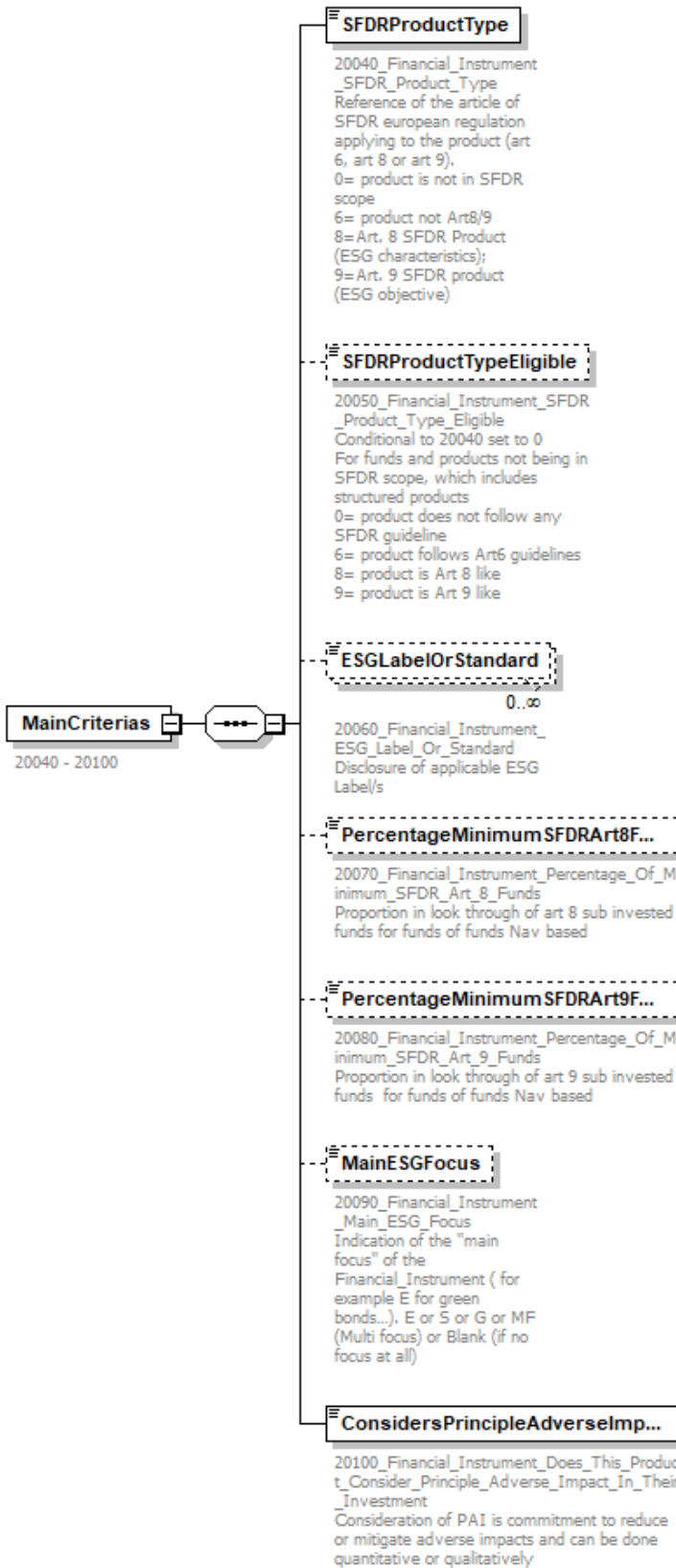

|            |   |
|------------|---|
| properties | isRef 0<br>content complex  |
| children   | <a href="#">SFDRProductType</a> <a href="#">SFDRProductTypeEligible</a> <a href="#">ESGLabelOrStandard</a> <a href="#">PercentageMinimumSFDRArt8Funds</a> <a href="#">PercentageMinimumSFDRArt9Funds</a> <a href="#">MainESGFocus</a> <a href="#">ConsidersPrincipleAdverseImpact</a> |
| annotation | documentation<br>20040 - 20100  |

element **EETReportType1.1.2/MainCriterias/SFDRProductType**

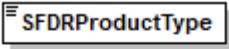
|            |  |
|------------|--|
| diagram    |  <p>20040_Financial_Instrument_SFDR_Product_Type<br/>Reference of the article of SFDR european regulation applying to the product (art 6, art 8 or art 9).<br/>0= product is not in SFDR scope<br/>6= product not Art8/9<br/>8=Art. 8 SFDR Product (ESG characteristics);<br/>9=Art. 9 SFDR product (ESG objective)</p> |
| type       | restriction of <b>xs:string</b>  |
| properties | isRef 0<br>content simple  |
| annotation | documentation<br>20040_Financial_Instrument_SFDR_Product_Type<br>Reference of the article of SFDR european regulation applying to the product (art 6, art 8 or art 9).<br>0= product is not in SFDR scope<br>6= product not Art8/9<br>8=Art. 8 SFDR Product (ESG characteristics);<br>9=Art. 9 SFDR product (ESG objective)  |

element **EETReportType1.1.2/MainCriterias/SFDRProductTypeEligible**

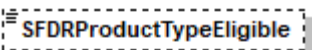
|            |  |
|------------|--|
| diagram    |  <p>20050_Financial_Instrument_SFDR_Product_Type_Eligible<br/>Conditional to 20040 set to 0<br/>For funds and products not being in SFDR scope, which includes structured products<br/>0= product does not follow any SFDR guideline<br/>6= product follows Art6 guidelines<br/>8= product is Art 8 like<br/>9= product is Art 9 like</p> |
| type       | restriction of <b>xs:string</b>  |
| properties | isRef 0<br>minOcc 0<br>maxOcc 1<br>content simple  |
| annotation | documentation<br>20050_Financial_Instrument_SFDR_Product_Type_Eligible<br>Conditional to 20040 set to 0<br>For funds and products not being in SFDR scope, which includes structured products<br>0= product does not follow any SFDR guideline   |

|  |  |
|--|--|
|  | 6= product follows Art6 guidelines<br>8= product is Art 8 like<br>9= product is Art 9 like |
|--|--|

element **EETReportType1.1.2/MainCriterias/ESGLabelOrStandard**

|            |   |
|------------|---|
| diagram    |                          |
| type       | restriction of <b>xs:string</b>   |
| properties | isRef 0<br>minOcc 0<br>maxOcc unbounded<br>content simple   |
| annotation | documentation<br>20060_Financial_Instrument_ESG_Label_Or_Standard<br>Disclosure of applicable ESG Label/s |

element **EETReportType1.1.2/MainCriterias/PercentageMinimumSFDRArt8Funds**

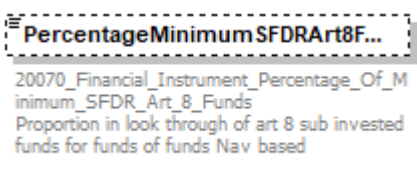
|            |   |
|------------|---|
| diagram    |   |
| type       | <b>xs:decimal</b>   |
| properties | isRef 0<br>minOcc 0<br>maxOcc 1<br>content simple   |
| annotation | documentation<br>20070_Financial_Instrument_Percentage_Of_Minimum_SFDR_Art_8_Funds<br>Proportion in look through of art 8 sub invested funds for funds of funds Nav based |

element **EETReportType1.1.2/MainCriterias/PercentageMinimumSFDRArt9Funds**

|            |   |
|------------|---|
| diagram    |  |
| type       | <b>xs:decimal</b>   |
| properties | isRef 0<br>minOcc 0<br>maxOcc 1<br>content simple                                   |
| annotation | documentation   |

|  |  |
|--|--|
|  | 20080_Financial_Instrument_Percentage_Of_Minimum_SFDR_Art_9_Funds<br>Proportion in look through of art 9 sub invested funds for funds of funds Nav based |
|--|--|

element **EETReportType1.1.2/MainCriterias/MainESGFocus**

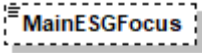
|            |   |
|------------|---|
| diagram    |  <p>20090_Financial_Instrument<br/>_Main_ESG_Focus<br/>Indication of the "main focus" of the Financial_Instrument ( for example E for green bonds...), E or S or G or MF (Multi focus) or Blank (if no focus at all)</p> |
| type       | restriction of <b>xs:string</b>   |
| properties | isRef 0<br>minOcc 0<br>maxOcc 1<br>content simple   |
| annotation | documentation<br>20090_Financial_Instrument_Main_ESG_Focus<br>Indication of the "main focus" of the Financial_Instrument ( for example E for green bonds...), E or S or G or MF (Multi focus) or Blank (if no focus at all)   |

element **EETReportType1.1.2/MainCriterias/ConsidersPrincipleAdverseImpact**

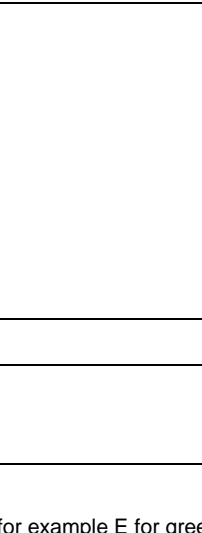
|            |   |
|------------|---|
| diagram    |  <p>20100_Financial_Instrument_Does_This_Product_Consider_Principle_Adverse_Impact_In_Their_Investment<br/>_Investment<br/>Consideration of PAI is commitment to reduce or mitigate adverse impacts and can be done quantitative or qualitatively</p> |
| type       | <a href="#">EETYesNoType</a>  |
| properties | isRef 0<br>content simple   |
| facets     | Kind Value annotation<br>length 1   |
| annotation | documentation<br>20100_Financial_Instrument_Does_This_Product_Consider_Principle_Adverse_Impact_In_Their_Investment<br>Consideration of PAI is commitment to reduce or mitigate adverse impacts and can be done quantitative or qualitatively   |

element **EETReportType1.1.2/ProductDisclosures**

diagram

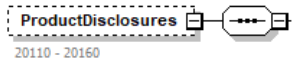

**Languages**

20110\_Financial\_Instrument\_Languages  
 Each insurance company needs to have the documents translated and published in the language of the countries of distribution. This field allows to list the languages in which the annexes documents are translated. The asset managers and structured product houses are due to provide the languages of the countries of distribution of their funds: the list of the countries/languages is similar to the list of countries where EPT are distributed"

**LinkToPCDFPForMOP**

20120\_Financial\_Instrument\_Link\_To\_PCDFP\_For\_MOP  
 Pre Contractual Disclosure for Financial Products referred to in Article 8(1) and 9(1), (2) and (3) (EU) 2019/2088 as stand alone document PDF for underlying investment options in Multi Option Products. Annex I, Annex II (EU) 2019/2088. The asset managers and structured product houses are due to provide the languages of the countries of distribution of their funds: the list of the countries/languages is similar to the list of countries where EPT are distributed"

**ProductionDatePCDFP**

20130\_Financial\_Instrument\_Production\_Date\_PCDFP  
 Dates of production of PCDFP for the different languages

**LinkToPDFPforMOP**

20140\_Financial\_Instrument\_Link\_To\_PDFP\_for\_MOP  
 Periodic Disclosure for Financial Products referred to in Article 8(1) and 9(1), (2) and (3) (EU) 2019/2088 as stand alone document PDF for underlying investment options in Multi Option Products. Annex III, Annex IV (EU) 2019/2088. The asset managers and structured product houses are due to provide the languages of the countries of distribution of their funds: the list of the countries/languages is similar to the list of countries where EPT are distributed

The link has to be to the actual full disclosure website and not to a generic"

**EndDateOfReportingPeriodPDFP**

20150\_Financial\_Instrument\_End\_Date\_Of\_Reporting\_Period\_PDFP  
 End Date Of Reporting Period PDFP (based on 12 months reporting report market usage)

**LinkToSFDRWebsiteProductDisc...**

20160\_Financial\_Instrument\_Link\_To\_SFDR\_Website\_Product\_Disclosures Art 10 SFDR - 24 RTS u 37 RTS  
 The asset managers and structured product houses are due to provide the languages of the countries of distribution of their funds: the list of the countries/languages is similar to the list of countries where EPT are distributed

The link has to be to the actual full disclosure website and not to a generic"

|            |   |
|------------|---|
| properties | isRef 0<br>minOcc 0<br>maxOcc 1<br>content complex  |
| children   | <a href="#">Languages</a> <a href="#">LinkToPCDFPForMOP</a> <a href="#">ProductionDatePCDFP</a> <a href="#">LinkToPDFPforMOP</a> <a href="#">EndDateOfReportingPeriodPDFP</a> <a href="#">LinkToSFDRWebsiteProductDisclosures</a> |
| annotation | documentation<br>20110 - 20160  |

element **EETReportType1.1.2/ProductDisclosures/Languages**

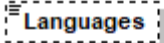
|            |  |
|------------|--|
| diagram    |  <p>20110_Financial_Instrument_Languages<br/>Each insurance company needs to have the documents translated and published in the language of the countries of distribution. This field allows to list the languages in which the annexes documents are translated. The asset managers and structured product houses are due to provide the languages of the countries of distribution of their funds: the list of the countries/languages is similar to the list of countries where EPT are distributed"</p> |
| type       | <b>xs:string</b>   |
| properties | isRef 0<br>minOcc 0<br>maxOcc 1<br>content simple  |
| annotation | documentation<br>20110_Financial_Instrument_Languages<br>Each insurance company needs to have the documents translated and published in the language of the countries of distribution. This field allows to list the languages in which the annexes documents are translated. The asset managers and structured product houses are due to provide the languages of the countries of distribution of their funds: the list of the countries/languages is similar to the list of countries where EPT are distributed"  |

element **EETReportType1.1.2/ProductDisclosures/LinkToPCDFPForMOP**

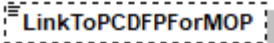
|            |  |
|------------|--|
| diagram    |  <p>20120_Financial_Instrument_Link_To_PCDFP_For_MOP<br/>Pre Contractual Disclosure for Financial Products referred to in Article 8(1) and 9(1), (2) and (3) (EU) 2019/2088 as stand alone document PDF for underlying investment options in Multi Option Products. Annex I, Annex II (EU) 2019/2088. The asset managers and structured product houses are due to provide the langagues of the countries of distribution of their funds: the list of the countries/languages is similar to the list of countries where EPT are distributed"</p> |
| type       | <b>xs:anyURI</b>   |
| properties | isRef 0<br>minOcc 0<br>maxOcc 1<br>content simple  |
| annotation | documentation<br>20120_Financial_Instrument_Link_To_PCDFP_For_MOP<br>Pre Contractual Disclosure for Financial Products referred to in Article 8(1) and 9(1), (2) and (3) (EU) 2019/2088 as stand alone document PDF for underlying investment options in Multi Option Products. Annex I, Annex II (EU) 2019/2088. The asset managers and structured product houses are due to provide the langagues of the countries of distribution of their funds: the list of the countries/languages is similar to the list of countries where EPT are distributed"  |

element **EETReportType1.1.2/ProductDisclosures/ProductionDatePCDFP**

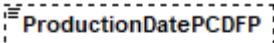
|            |  |
|------------|--|
| diagram    |  <p>20130_Financial_Instrument_Production_Date_PCDFP<br/>Dates of production of PCDFP for the different languages</p> |
| type       | <b>xs:date</b>   |
| properties | isRef 0<br>minOcc 0<br>maxOcc 1<br>content simple  |
| annotation | documentation<br>20130_Financial_Instrument_Production_Date_PCDFP<br>Dates of production of PCDFP for the different languages  |

element **EETReportType1.1.2/ProductDisclosures/LinkToPDFPforMOP**

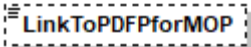
|            |  |
|------------|--|
| diagram    |  <p>20140_Financial_Instrument_Link_To_PDFP_for_MOP<br/>         Periodic Disclosure for Financial Products referred to in Article 8(1) and 9(1), (2) and (3) (EU) 2019/2088 as stand alone document PDF for underlying investment options in Multi Option Products. Annex III, Annex IV (EU) 2019/2088. The asset managers and structured product houses are due to provide the langagues of the countries of distribution of their funds: the list of the countries/languages is similar to the list of countries where EPT are distributed</p> <p>The link has to be to the actual full disclosure website and not to a generic"</p> |
| type       | <b>xs:anyURI</b>   |
| properties | isRef 0<br>minOcc 0<br>maxOcc 1<br>content simple  |
| annotation | documentation<br>20140_Financial_Instrument_Link_To_PDFP_for_MOP<br>Periodic Disclosure for Financial Products referred to in Article 8(1) and 9(1), (2) and (3) (EU) 2019/2088 as stand alone document PDF for underlying investment options in Multi Option Products. Annex III, Annex IV (EU) 2019/2088. The asset managers and structured product houses are due to provide the langagues of the countries of distribution of their funds: the list of the countries/languages is similar to the list of countries where EPT are distributed <p>The link has to be to the actual full disclosure website and not to a generic"</p>   |

element **EETReportType1.1.2/ProductDisclosures/EndDateOfReportingPeriodPDFP**

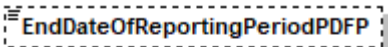
|            |   |
|------------|---|
| diagram    |  <p>20150_Financial_Instrument_End_Date_Of_Reporting_Period_PDFP<br/>         End Date Of Reporting Period PDFP (based on 12 months reporting report market usage)</p> |
| type       | <b>xs:date</b>  |
| properties | isRef 0<br>minOcc 0<br>maxOcc 1<br>content simple   |
| annotation | documentation<br>20150_Financial_Instrument_End_Date_Of_Reporting_Period_PDFP<br>End Date Of Reporting Period PDFP (based on 12 months reporting report market usage)   |



element **EETReportType1.1.2/ProductDisclosures/LinkToSFDRWebsiteProductDisclosures**

|                   |   |
|-------------------|---|
| <p>diagram</p>    |  <p>20160_Financial_Instrument_Link_To_SFDR_Website_Product_Disclosures Art 10 SFDR - 24 RTS u 37 RTS<br/>         The asset managers and structured product houses are due to provide the languages of the countries of distribution of their funds: the list of the countries/languages is similar to the list of countries where EPT are distributed</p> <p>The link has to be to the actual full disclosure website and not to a generic</p> |
| <p>type</p>       | <p><b>xs:anyURI</b></p>   |
| <p>properties</p> | <p>isRef 0<br/>         minOcc 0<br/>         maxOcc 1<br/>         content simple</p>  |
| <p>annotation</p> | <p>documentation<br/>         20160_Financial_Instrument_Link_To_SFDR_Website_Product_Disclosures Art 10 SFDR - 24 RTS u 37 RTS<br/>         The asset managers and structured product houses are due to provide the languages of the countries of distribution of their funds: the list of the countries/languages is similar to the list of countries where EPT are distributed</p> <p>The link has to be to the actual full disclosure website and not to a generic</p>  |

element **EETReportType1.1.2/SpecificInformationForArt8and9**

diagram

**SpecificInformationForArt8and9**

20170 - 20250

**SustainableInvestmentsArt8**

20170\_Financial\_Instrument\_Sustainable\_Investments\_Art\_8 Does the art 8 product invest in sustainable investment?

**MinimalProportionOfSustainabl...**

20180\_Financial\_Instrument\_Products\_Minimal\_Proportion\_Of\_Sustainable\_Investments\_Art\_8

**SustainableInvestmentEUTaxon...**

20190\_Financial\_Instrument\_Sustainable\_Investment\_EU\_Taxonomy\_Art\_8 Does the minimum specified in field 20170 include EU Taxonomy sustainable investment?

**SustainableInvestmentEnviron...**

20200\_Financial\_Instrument\_Sustainable\_Investment\_Environmental\_Not\_EU\_Taxonomy\_Art\_8 Does the minimum specified in field 20170 include Non EU Taxonomy Environmental sustainable investment?

**SustainableInvestmentSocialObj...**

20210\_Financial\_Instrument\_Sustainable\_Investment\_Social\_Objective\_Art\_8 Does the minimum specified in field 20170 include include sustainable investment with social objective?

**SustainableInvestmentWithEnvi...**

20220\_Financial\_Instrument\_Minimum\_Sustainable\_Investment\_With\_Environmental\_Objective\_Art\_9 For art 9 products, the minimum proportion of sustainable investments.

**EnvironmentallySustainableInve...**

20230\_Financial\_Instrument\_Environmentally\_Sustainable\_Investment\_EU\_Taxonomy\_Art\_9 Does the minimum specified in field 20220 include EU Taxonomy Environmental sustainable investment?

**EnvironmentallySustainableInve...**

20240\_Financial\_Instrument\_Environmentally\_Sustainable\_Investment\_Not\_EU\_Taxonomy\_Art\_9 Does the minimum specified in field 20210 include Non EU Taxonomy Environmental sustainable investment?

**MinimumSustainableInvestmen...**

20250\_Financial\_Instrument\_Minimum\_Sustainable\_Investment\_Social\_Objective\_Art\_9 Does the minimum specified in field 20210 include sustainable investments with social objectives.

|            |  |
|------------|--|
| properties | isRef 0<br>minOcc 0<br>maxOcc 1<br>content complex   |
| children   | <a href="#">SustainableInvestmentsArt8</a> <a href="#">MinimalProportionOfSustainableInvestmentsArt8</a><br><a href="#">SustainableInvestmentEUTaxonomyArt8</a> <a href="#">SustainableInvestmentEnvironmentalNotEUTaxonomyArt8</a><br><a href="#">SustainableInvestmentSocialObjectiveArt8</a> <a href="#">SustainableInvestmentWithEnvironmentalObjectiveArt9</a><br><a href="#">EnvironmentallySustainableInvestmentEUTaxonomyArt9</a><br><a href="#">EnvironmentallySustainableInvestmentNotEUTaxonomyArt9</a> <a href="#">MinimumSustainableInvestmentSocialObjectiveArt9</a> |
| annotation | documentation<br>20170 - 20250   |

element **EETReportType1.1.2/SpecificInformationForArt8and9/SustainableInvestmentsArt8**

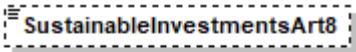
|            |  |
|------------|--|
| diagram    | <br>20170_Financial_Instrument_Sustainable_Investments_Art_8 Does the art 8 product invest in sustainable investment? |
| type       | <a href="#">EETYesNoType</a>   |
| properties | isRef 0<br>minOcc 0<br>maxOcc 1<br>content simple  |
| facets     | Kind Value annotation<br>length 1  |
| annotation | documentation<br>20170_Financial_Instrument_Sustainable_Investments_Art_8 Does the art 8 product invest in sustainable investment?   |

element

**EETReportType1.1.2/SpecificInformationForArt8and9/MinimalProportionOfSustainableInvestmentsArt8**

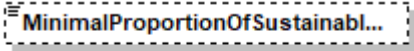
|            |  |
|------------|--|
| diagram    | <br>20180_Financial_Instrument_Products_Minimal_Proportion_Of_Sustainable_Investments_Art_8 |
| type       | <b>xs:decimal</b>  |
| properties | isRef 0<br>minOcc 0<br>maxOcc 1<br>content simple  |
| annotation | documentation<br>20180_Financial_Instrument_Products_Minimal_Proportion_Of_Sustainable_Investments_Art_8   |

element **EETReportType1.1.2/SpecificInformationForArt8and9/SustainableInvestmentEUTaxonomyArt8**

|         |   |
|---------|---|
| diagram | <br>20190_Financial_Instrument_Sustainable_Investment_EU_Taxonomy_Art_8<br>Does the minimum specified in field 20170 include EU Taxonomy sustainable investment? |
|---------|---|

|            |   |
|------------|---|
| type       | <a href="#">EETYesNoType</a>  |
| properties | isRef 0<br>minOcc 0<br>maxOcc 1<br>content simple   |
| facets     | Kind Value annotation<br>length 1   |
| annotation | documentation<br>20190_Financial_Instrument_Sustainable_Investment_EU_Taxonomy_Art_8<br>Does the minimum specified in field 20170 include EU Taxonomy sustainable investment? |

element

**EETReportType1.1.2/SpecificInformationForArt8and9/SustainableInvestmentEnvironmentalNotEUTaxonomyArt8**

|            |  |
|------------|--|
| diagram    |  <p>20200_Financial_Instrument_Sustainable_Investment_Environmental_Not_EU_Taxonomy_Art_8<br/>Does the minimum specified in field 20170 include Non EU Taxonomy Environmental sustainable investment?</p> |
| type       | <a href="#">EETYesNoType</a>   |
| properties | isRef 0<br>minOcc 0<br>maxOcc 1<br>content simple  |
| facets     | Kind Value annotation<br>length 1  |
| annotation | documentation<br>20200_Financial_Instrument_Sustainable_Investment_Environmental_Not_EU_Taxonomy_Art_8<br>Does the minimum specified in field 20170 include Non EU Taxonomy Environmental sustainable investment?  |

element

**EETReportType1.1.2/SpecificInformationForArt8and9/SustainableInvestmentSocialObjectiveArt8**

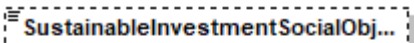
|            |   |
|------------|---|
| diagram    |  <p>20210_Financial_Instrument_Sustainable_Investment_Social_Objective_Art_8<br/>Does the minimum specified in field 20170 include include sustainable investment with social objective?</p> |
| type       | <a href="#">EETYesNoType</a>  |
| properties | isRef 0<br>minOcc 0<br>maxOcc 1<br>content simple   |
| facets     | Kind Value annotation<br>length 1   |
| annotation | documentation<br>20210_Financial_Instrument_Sustainable_Investment_Social_Objective_Art_8<br>Does the minimum specified in field 20170 include include sustainable investment with social objective?  |

element

**EETReportType1.1.2/SpecificInformationForArt8and9/SustainableInvestmentWithEnvironmentalObjecti**

**veArt9**

|            |   |
|------------|---|
| diagram    |  <b>SustainableInvestmentWithEnvi...</b><br>20220_Financial_Instrument_Minimum_Sustainable_Investment_With_Environmental_Objective_Art_9<br>For art 9 products, the minimum proportion of sustainable investments. |
| type       | <b>xs:decimal</b>   |
| properties | isRef 0<br>minOcc 0<br>maxOcc 1<br>content simple   |
| annotation | documentation<br>20220_Financial_Instrument_Minimum_Sustainable_Investment_With_Environmental_Objective_Art_9<br>For art 9 products, the minimum proportion of sustainable investments.   |

element

**EETReportType1.1.2/SpecificInformationForArt8and9/EnvironmentallySustainableInvestmentEUTaxonomyArt9**

|            |  |
|------------|--|
| diagram    |  <b>EnvironmentallySustainableInve...</b><br>20230_Financial_Instrument_Environmentally_Sustainable_Investment_EU_Taxonomy_Art_9<br>Does the minimum specified in field 20220 include EU Taxonomy Environmental sustainable investment? |
| type       | <a href="#">EETYesNoType</a>   |
| properties | isRef 0<br>minOcc 0<br>maxOcc 1<br>content simple  |
| facets     | Kind Value annotation<br>length 1  |
| annotation | documentation<br>20230_Financial_Instrument_Environmentally_Sustainable_Investment_EU_Taxonomy_Art_9<br>Does the minimum specified in field 20220 include EU Taxonomy Environmental sustainable investment?  |

element

**EETReportType1.1.2/SpecificInformationForArt8and9/EnvironmentallySustainableInvestmentNotEUTaxonomyArt9**

|            |  |
|------------|--|
| diagram    |  <b>EnvironmentallySustainableInve...</b><br>20240_Financial_Instrument_Environmentally_Sustainable_Investment_Not_EU_Taxonomy_Art_9<br>Does the minimum specified in field 20210 include Non EU Taxonomy Environmental sustainable investment? |
| type       | <a href="#">EETYesNoType</a>   |
| properties | isRef 0<br>minOcc 0<br>maxOcc 1<br>content simple  |
| facets     | Kind Value annotation<br>length 1  |

|            |   |
|------------|---|
| annotation | documentation<br>20240_Financial_Instrument_Environmentally_Sustainable_Investment_Not_EU_Taxonomy_Art_9<br>Does the minimum specified in field 20210 include Non EU Taxonomy Environmental sustainable investment? |
|------------|---|

element

**EETReportType1.1.2/SpecificInformationForArt8and9/MinimumSustainableInvestmentSocialObjectiveArt9**

|            |   |
|------------|---|
| diagram    |  <p>20250_Financial_Instrument_Minimum_Sustainable_Investment_Social_Objective_Art_9<br/>Does the minimum specified in field 20210 include sustainable investments with social objectives.</p> |
| type       | <a href="#">PercentageType</a>  |
| properties | isRef 0<br>minOcc 0<br>maxOcc 1<br>content simple   |
| annotation | documentation<br>20250_Financial_Instrument_Minimum_Sustainable_Investment_Social_Objective_Art_9<br>Does the minimum specified in field 20210 include sustainable investments with social objectives.  |

element **EETReportType1.1.2/ESGThematicInvestingDescription**

diagram

**ESGThematicInvestingDescripti...**

This part describes investment strategy, and is not linked to Taxonomy  
20260 - 20300



**ESGExistingThematicCharacteri...**

20260\_Financial\_Instrument\_ESG\_Existing\_Thematic\_Characteristics  
Does this Financial\_Instrument incorporate ESG factors through ESG thematic approach ?

**EnvironmentalThematicCharact...**

0..∞

20270\_Financial\_Instrument\_Environmental\_Thematic\_Characteristics  
Description of the product environment thematic investment strategy, according to SFDR art 2(17). Multiple answers fields.  
A - energy  
B - renewable energy  
C - raw materials  
D - water and land  
E - waste  
F - greenhouse gas emissions  
G - biodiversity  
H - circular economy  
I - environment other  
J - none

**SocialThematicCharacteristics**

0..∞

20280\_Financial\_Instrument\_Social\_Thematic\_Characteristics  
Description of the product social thematic investment strategy, according to SFDR art 2(17)  
Multiple answers fields.

A - inequality  
B - social cohesion  
C - social integration  
D - labour relations  
E - investment in human capital  
F - economically or socially disadvantaged communities  
G - social other  
H - none

**GovernanceThematicCharacteri...**

0..∞

20290\_Financial\_Instrument\_Governance\_Thematic\_Characteristics  
Description of the product thematic investment strategy, according to SFDR art 2(17)  
Multiple answers field

A - sound management structures  
B - employee relations  
C - remuneration of staff  
D - tax compliance  
E - governance other  
F - none

**AlignmentWithSustainableDevel...**

0..∞

20300\_Financial\_Instrument\_Alignment\_With\_Sustainable\_Development\_Goals  
Alignment with SDG means that SDG are used in the investment process (screening) or targeted by the fund. Multiple answers field.

A - No Poverty  
B - Zero Hunger  
C - Good Health and Well-Being  
D - Quality Education  
E - Gender Equality  
F - Clean Water and Sanitation  
G - Affordable and Clean Energy  
H - Decent Work and Economic Growth  
I - Industry, Innovation and Infrastructure  
J - Reduced Inequality  
K - Sustainable Cities and Communities  
L - Responsible Consumption and Production  
M - Climate Action  
N - Life Below Water  
O - Life on Land  
P - Peace and Justice, Strong Institutions  
Q - Partnerships to achieve to Goal  
R - None



|            |  |
|------------|--|
| properties | isRef 0<br>minOcc 0<br>maxOcc 1<br>content complex   |
| children   | <a href="#">ESGExistingThematicCharacteristics</a> <a href="#">EnvironmentalThematicCharacteristics</a> <a href="#">SocialThematicCharacteristics</a> <a href="#">GovernanceThematicCharacteristics</a> <a href="#">AlignmentWithSustainableDevelopmentGoals</a> |
| annotation | documentation<br>This part describes investment strategy, and is not linked to Taxonomy<br>20260 - 20300   |

element **EETReportType1.1.2/ESGThematicInvestingDescription/ESGExistingThematicCharacteristics**

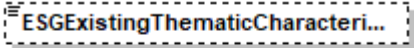
|            |  |
|------------|--|
| diagram    |  <p>20260_Financial_Instrument_ESG_Existing_Thematic_Characteristics<br/>Does this Financial_Instrument incorporate ESG factors through ESG thematic approach ?</p> |
| type       | <a href="#">EETYesNoType</a>   |
| properties | isRef 0<br>minOcc 0<br>maxOcc 1<br>content simple  |
| facets     | Kind Value annotation<br>length 1  |
| annotation | documentation<br>20260_Financial_Instrument_ESG_Existing_Thematic_Characteristics<br>Does this Financial_Instrument incorporate ESG factors through ESG thematic approach ?  |

element **EETReportType1.1.2/ESGThematicInvestingDescription/EnvironmentalThematicCharacteristics**

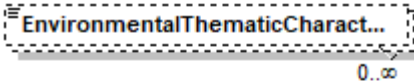
|            |  |
|------------|--|
| diagram    |  <p>20270_Financial_Instrument_Environmental_Thematic_Characteristics<br/>Description of the product environment thematic investment strategy, according to SFDR art 2(17). Multiple answers fields.<br/>A - energy<br/>B - renewable energy<br/>C - raw materials<br/>D - water and land<br/>E - waste<br/>F - greenhouse gas emissions<br/>G - biodiversity<br/>H - circular economy<br/>I - environment other<br/>J - none</p> |
| type       | restriction of <b>xs:string</b>  |
| properties | isRef 0<br>minOcc 0<br>maxOcc unbounded<br>content simple  |
| annotation | documentation<br>20270_Financial_Instrument_Environmental_Thematic_Characteristics<br>Description of the product environment thematic investment strategy, according to SFDR art 2(17). Multiple answers fields.<br>A - energy<br>B - renewable energy<br>C - raw materials  |

|  |  |
|--|--|
|  | D - water and land<br>E - waste<br>F - greenhouse gas emissions<br>G - biodiversity<br>H - circular economy<br>I - environment other<br>J - none |
|--|--|

element **EETReportType1.1.2/ESGThematicInvestingDescription/SocialThematicCharacteristics**

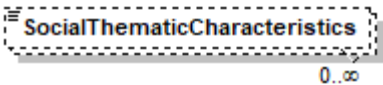
|            |  |
|------------|--|
| diagram    |  <p>0..∞</p> <p>20280_Financial_Instrument_Social_Thematic_Characteristics<br/> Description of the product social thematic investment strategy, according to SFDR art 2(17)<br/> Multiple answers fields.</p> <p>A - inequality<br/> B - social cohesion<br/> C - social integration<br/> D - labour relations<br/> E - investment in human capital<br/> F - economically or socially disadvantaged communities<br/> G - social other<br/> H - none</p> |
| type       | restriction of <b>xs:string</b>  |
| properties | isRef 0<br>minOcc 0<br>maxOcc unbounded<br>content simple  |
| annotation | documentation<br>20280_Financial_Instrument_Social_Thematic_Characteristics<br>Description of the product social thematic investment strategy, according to SFDR art 2(17)<br>Multiple answers fields. <p>A - inequality<br/> B - social cohesion<br/> C - social integration<br/> D - labour relations<br/> E - investment in human capital<br/> F - economically or socially disadvantaged communities<br/> G - social other<br/> H - none</p>   |

element **EETReportType1.1.2/ESGThematicInvestingDescription/GovernanceThematicCharacteristics**

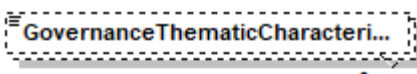
|            |  |
|------------|--|
| diagram    |  <p>0..∞</p> <p>20290_Financial_Instrument_Governance_Thematic_Characteristics<br/>Description of the product thematic investment strategy, according to SFDR art 2(17)<br/>Multiple answers field</p> <p>A - sound management structures<br/>B - employee relations<br/>C - remuneration of staff<br/>D - tax compliance<br/>E - governance other<br/>F - none</p> |
| type       | restriction of <b>xs:string</b>  |
| properties | <p>isRef 0</p> <p>minOcc 0</p> <p>maxOcc unbounded</p> <p>content simple</p>   |
| annotation | <p>documentation</p> <p>20290_Financial_Instrument_Governance_Thematic_Characteristics<br/>Description of the product thematic investment strategy, according to SFDR art 2(17)<br/>Multiple answers field</p> <p>A - sound management structures<br/>B - employee relations<br/>C - remuneration of staff<br/>D - tax compliance<br/>E - governance other<br/>F - none</p>  |

element

**EETReportType1.1.2/ESGThematicInvestingDescription/AlignmentWithSustainableDevelopmentGoals**

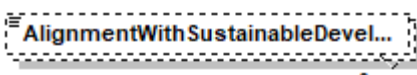
|         |  |
|---------|--|
| diagram |  <p>0..∞</p> <p>20300_Financial_Instrument_Alignment_With_Sustainable_Development_Goals<br/>Alignment with SDG means that SDG are used in the investment process (screening) or targeted by the fund. Multiple answers field.</p> <p>A - No Poverty<br/>B - Zero Hunger<br/>C - Good Health and Well-Being<br/>D - Quality Education<br/>E - Gender Equality<br/>F - Clean Water and Sanitaion<br/>G - Affordable and Clean Energy<br/>H - Decent Work and Economic Growth<br/>I - Industry, Innovation and Infrastructure<br/>J - Reduced Inequality<br/>K - Sustainable Cities and Communities<br/>L - Responsible Consumption and Production<br/>M - Climate Action<br/>N - Life Below Water<br/>O - Life on Land<br/>P - Peace and Justice, Strong Institutions<br/>Q - Partnerships to achive to Goal<br/>R - None</p> |
|---------|--|

|            |   |
|------------|---|
| type       | restriction of <b>xs:string</b>   |
| properties | isRef 0<br>minOcc 0<br>maxOcc unbounded<br>content simple   |
| annotation | documentation<br>20300_Financial_Instrument_Alignment_With_Sustainable_Development_Goals Alignment with SDG means that SDG are used in the investment process (screening) or targeted by the fund. Multiple answers field.<br>A - No Poverty<br>B - Zero Hunger<br>C - Good Health and Well-Being<br>D - Quality Education<br>E - Gender Equality<br>F - Clean Water and Sanitaion<br>G - Affordable and Clean Energy<br>H - Decent Work and Economic Growth<br>I - Industry, Innovation and Infrastructure<br>J - Reduced Inequality<br>K - Sustainable Cities and Communities<br>L - Responsible Consumption and Production<br>M - Climate Action<br>N - Life Below Water<br>O - Life on Land<br>P - Peace and Justice, Strong Institutions<br>Q - Partnerships to achive to Goal<br>R - None |

element **EETReportType1.1.2/ESGEngagementCoverage**

|            |   |
|------------|---|
| diagram    | <pre> classDiagram     class ESGEngagementCoverage {         20310 - 20360     }     class EligibleIssuers {         20310_Financial_Instrument_Weight_Of_Eligible_Issuers         20320_Financial_Instrument_Number_Of_Eligible_Issuers     }     class ESGCoveredIssuers {         20330_Financial_Instrument_Weight_Of_ESG_Covered_Issuers         20340_Financial_Instrument_Number_Of_ESG_Covered_Issuers     }     class EngagedIssuers {         20350_Financial_Instrument_Weight_Of_Engaged_Issuers         20360_Financial_Instrument_Number_Of_Engaged_Issuers     }     ESGEngagementCoverage "1" *-- "1" EligibleIssuers     ESGEngagementCoverage "1" *-- "1" ESGCoveredIssuers     ESGEngagementCoverage "1" *-- "1" EngagedIssuers </pre> |
| properties | isRef 0<br>minOcc 0<br>maxOcc 1<br>content complex  |
| children   | <a href="#">EligibleIssuers</a> <a href="#">ESGCoveredIssuers</a> <a href="#">EngagedIssuers</a>  |
| annotation | documentation<br>20310 - 20360  |

element **EETReportType1.1.2/ESGEngagementCoverage/EligibleIssuers**

|            |  |
|------------|--|
| diagram    | <p>The diagram illustrates the structure of the <b>EligibleIssuers</b> element. It is connected to the <b>EETWeightNumberType1.1</b> type, which contains two sub-elements: <b>Weight</b> and <b>Number</b>. The <b>EligibleIssuers</b> element is associated with the following documentation: 20310_Financial_Instrument_Weight_Of_Eligible_Issuers and 20320_Financial_Instrument_Number_Of_Eligible_Issuers.</p> |
| type       | <a href="#">EETWeightNumberType1.1</a>   |
| properties | isRef 0<br>minOcc 0<br>maxOcc 1<br>content complex   |
| children   | <a href="#">Weight</a> <a href="#">Number</a>  |
| annotation | documentation<br>20310_Financial_Instrument_Weight_Of_Eligible_Issuers<br>20320_Financial_Instrument_Number_Of_Eligible_Issuers  |

element **EETReportType1.1.2/ESGEngagementCoverage/ESGCoveredIssuers**

|            |  |
|------------|--|
| diagram    | <p>The diagram illustrates the structure of the <b>ESGCoveredIssuers</b> element. It is connected to the <b>EETWeightNumberType1.1</b> type, which contains two sub-elements: <b>Weight</b> and <b>Number</b>. The <b>ESGCoveredIssuers</b> element is associated with the following documentation: 20330_Financial_Instrument_Weight_Of_ESG_Covered_Issuers and 20340_Financial_Instrument_Number_Of_ESG_Covered_Issuers.</p> |
| type       | <a href="#">EETWeightNumberType1.1</a>   |
| properties | isRef 0<br>minOcc 0<br>maxOcc 1<br>content complex   |
| children   | <a href="#">Weight</a> <a href="#">Number</a>  |
| annotation | documentation<br>20330_Financial_Instrument_Weight_Of_ESG_Covered_Issuers<br>20340_Financial_Instrument_Number_Of_ESG_Covered_Issuers  |

element **EETReportType1.1.2/ESGEngagementCoverage/EngagedIssuers**

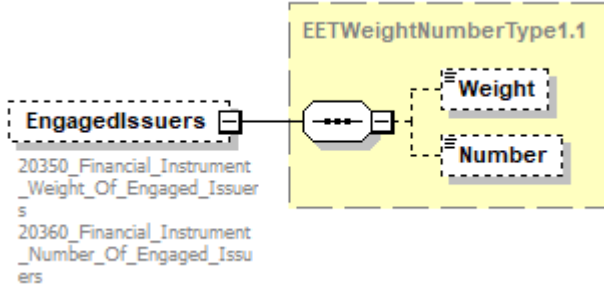
|            |   |
|------------|---|
| diagram    |  <p>The diagram illustrates the structure of the <b>EngagedIssuers</b> element. It is composed of two parts: <b>Weight</b> and <b>Number</b>, which are grouped under the type <b>EETWeightNumberType1.1</b>. The <b>EngagedIssuers</b> element is associated with the following documentation: 20350_Financial_Instrument_Weight_Of_Engaged_Issuers and 20360_Financial_Instrument_Number_Of_Engaged_Issuers.</p> |
| type       | <a href="#">EETWeightNumberType1.1</a>  |
| properties | <ul style="list-style-type: none"> <li>isRef 0</li> <li>minOcc 0</li> <li>maxOcc 1</li> <li>content complex</li> </ul>  |
| children   | <a href="#">Weight</a> <a href="#">Number</a>   |
| annotation | <p>documentation</p> <p>20350_Financial_Instrument_Weight_Of_Engaged_Issuers</p> <p>20360_Financial_Instrument_Number_Of_Engaged_Issuers</p>  |

element **EETReportType1.1.2/ESGBenchmark**

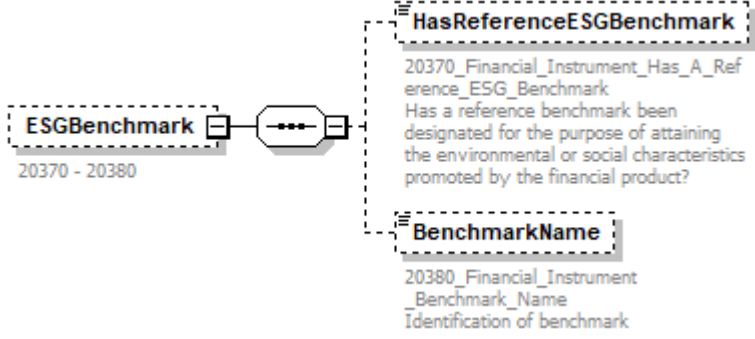
|            |   |
|------------|---|
| diagram    |  <p>The diagram shows the <b>ESGBenchmark</b> element (documentation: 20370 - 20380) connected to two child elements: <b>HasReferenceESGBenchmark</b> (documentation: 20370_Financial_Instrument_Has_A_Reference_ESG_Benchmark, description: Has a reference benchmark been designated for the purpose of attaining the environmental or social characteristics promoted by the financial product?) and <b>BenchmarkName</b> (documentation: 20380_Financial_Instrument_Benchmark_Name, description: Identification of benchmark).</p> |
| properties | <ul style="list-style-type: none"> <li>isRef 0</li> <li>minOcc 0</li> <li>maxOcc 1</li> <li>content complex</li> </ul>  |
| children   | <a href="#">HasReferenceESGBenchmark</a> <a href="#">BenchmarkName</a>  |
| annotation | <p>documentation</p> <p>20370 - 20380</p>   |

element **EETReportType1.1.2/ESGBenchmark/HasReferenceESGBenchmark**

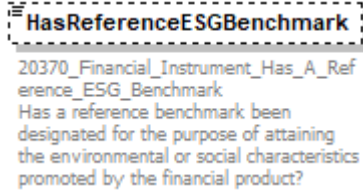
|            |   |
|------------|---|
| diagram    |  <p>The diagram shows the <b>HasReferenceESGBenchmark</b> element (documentation: 20370_Financial_Instrument_Has_A_Reference_ESG_Benchmark, description: Has a reference benchmark been designated for the purpose of attaining the environmental or social characteristics promoted by the financial product?).</p> |
| type       | <a href="#">EETYesNoType</a>  |
| properties | <ul style="list-style-type: none"> <li>isRef 0</li> <li>minOcc 0</li> </ul>   |

|            |  |
|------------|--|
|            | maxOcc 1<br>content simple   |
| facets     | Kind Value annotation<br>length 1  |
| annotation | documentation<br>20370_Financial_Instrument_Has_A_Reference_ESG_Benchmark<br>Has a reference benchmark been designated for the purpose of attaining the environmental or social characteristics promoted by the financial product? |

element **EETReportType1.1.2/ESGBenchmark/BenchmarkName**

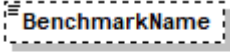
|            |   |
|------------|---|
| diagram    |  <p>20380_Financial_Instrument<br/>_Benchmark_Name<br/>Identification of benchmark</p> |
| type       | <b>xs:string</b>  |
| properties | isRef 0<br>minOcc 0<br>maxOcc 1<br>content simple   |
| annotation | documentation<br>20380_Financial_Instrument_Benchmark_Name<br>Identification of benchmark   |

element **EETReportType1.1.2/MinimumSustainableInvestments**

|                   |  |
|-------------------|--|
| <p>diagram</p>    | <p><b>Minimum Sustainable Investme...</b><br/>20390 - 20470</p> <ul style="list-style-type: none"> <li><b>MinimumAssetAllocationDate</b><br/>20390_Financial_Instrument_Minimum_Or_Planned_Asset_Allocation_Date<br/>The date to which the disclosure refer</li> <li><b>MinimumInvestmentsWithEnvir...</b><br/>20400_Financial_Instrument_EU_SFDR_Minimum_Or_Planned_Investments_With_Environmental_Or_Social_Characteristics</li> <li><b>MethodologyFor SustainableInve...</b><br/>20410_Financial_Instrument_EU_SFDR_Methodology_For_Sustainable_Investments_Calculation<br/>Revenue(R), Capex(C), Opex(O), other approach(A)</li> <li><b>MinimumInvestments Sustainable...</b><br/>20420_Financial_Instrument_EU_SFDR_Minimum_Or_Planned_Investments_Sustainable_Investments</li> <li><b>MinimumOtherInvestmentsWith...</b><br/>20430_Financial_Instrument_EU_SFDR_Minimum_Or_Planned_Other_Investments_With_Environmental_Or_Social_Characteristics</li> <li><b>MinimumInvestments Sustainable...</b><br/>20440_Financial_Instrument_EU_SFDR_Minimum_Or_Planned_Investments_Sustainable_Investments_Environmental</li> <li><b>MinimumInvestments Sustainable...</b><br/>20450_Financial_Instrument_EU_SFDR_Minimum_Or_Planned_Investments_Sustainable_Investments_Taxonomy_Aligned</li> <li><b>MinimumInvestments Sustainable...</b><br/>20460_Financial_Instrument_EU_SFDR_Minimum_Or_Planned_Investments_Sustainable_Investments_Other_Environmental</li> <li><b>MinimumInvestments Sustainable...</b><br/>20470_Financial_Instrument_EU_SFDR_Minimum_Or_Planned_Investments_Sustainable_Investments_Social</li> </ul> |
| <p>properties</p> | <p>isRef 0<br/>minOcc 0<br/>maxOcc 1<br/>content complex</p>   |
| <p>children</p>   | <p><a href="#">MinimumAssetAllocationDate</a> <a href="#">MinimumInvestmentsWithEnvironmentalOrSocialCharacteristics</a> <a href="#">MethodologyForSustainableInvestmentsCalculation</a> <a href="#">MinimumInvestmentsSustainableInvestments</a> <a href="#">MinimumOtherInvestmentsWithEnvironmentalOrSocialCharacteristics</a> <a href="#">MinimumInvestmentsSustainableInvestmentsEnvironmental</a> <a href="#">MinimumInvestmentsSustainableInvestmentsTaxonomyAligned</a> <a href="#">MinimumInvestmentsSustainableInvestmentsOtherEnvironmental</a> <a href="#">MinimumInvestmentsSustainableInvestmentsSocial</a></p>  |



|            |                                |
|------------|--------------------------------|
| annotation | documentation<br>20390 - 20470 |
|------------|--------------------------------|

element **EETReportType1.1.2/MinimumSustainableInvestments/MinimumAssetAllocationDate**

|            |   |
|------------|---|
| diagram    |  <p>20390_Financial_Instrument_Minimum_Or_Planned_Asset_Allocation_Date<br/>The date to which the disclosure refer</p> |
| type       | <b>xs:date</b>  |
| properties | isRef 0<br>content simple   |
| annotation | documentation<br>20390_Financial_Instrument_Minimum_Or_Planned_Asset_Allocation_Date<br>The date to which the disclosure refer  |

element **EETReportType1.1.2/MinimumSustainableInvestments/MinimumInvestmentsWithEnvironmentalOrSocialCharacteristics**

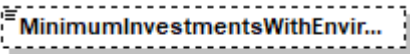
|            |   |
|------------|---|
| diagram    |  <p>20400_Financial_Instrument_EU_SFDR_Minimum_Or_Planned_Investments_With_Environmental_Or_Social_Characteristics</p> |
| type       | <a href="#">PercentageType</a>  |
| properties | isRef 0<br>minOcc 0<br>maxOcc 1<br>content simple   |
| annotation | documentation<br>20400_Financial_Instrument_EU_SFDR_Minimum_Or_Planned_Investments_With_Environmental_Or_Social_Characteristics   |

element **EETReportType1.1.2/MinimumSustainableInvestments/MethodologyForSustainableInvestmentsCalculation**

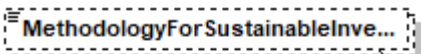
|            |  |
|------------|--|
| diagram    |  <p>20410_Financial_Instrument_EU_SFDR_Methodology_For_Sustainable_Investments_Calculation<br/>Revenue(R), Capex(C), Opex(O), other approach(A)</p> |
| type       | restriction of <b>xs:string</b>  |
| properties | isRef 0<br>minOcc 0<br>maxOcc unbounded<br>content simple  |
| annotation | documentation<br>20410_Financial_Instrument_EU_SFDR_Methodology_For_Sustainable_Investments_Calculation<br>Revenue(R), Capex(C), Opex(O), other approach(A)  |

element

**EETReportType1.1.2/MinimumSustainableInvestments/MinimumInvestmentsSustainableInvestments**

|            |  |
|------------|--|
| diagram    |  <b>MinimumInvestmentsSustainab...</b><br>20420_Financial_Instrument_EU_SFDR_Minimum_Or_Planned_Investments_Sustainable_Investments |
| type       | <a href="#">PercentageType</a>   |
| properties | isRef 0<br>minOcc 0<br>maxOcc 1<br>content simple  |
| annotation | documentation<br>20420_Financial_Instrument_EU_SFDR_Minimum_Or_Planned_Investments_Sustainable_Investments   |

element

**EETReportType1.1.2/MinimumSustainableInvestments/MinimumOtherInvestmentsWithEnvironmentalOrSocialCharacteristics**

|            |   |
|------------|---|
| diagram    |  <b>MinimumOtherInvestmentsWith...</b><br>20430_Financial_Instrument_EU_SFDR_Minimum_Or_Planned_Other_Investments_With_Environmental_Or_Social_Characteristics |
| type       | <a href="#">PercentageType</a>  |
| properties | isRef 0<br>minOcc 0<br>maxOcc 1<br>content simple   |
| annotation | documentation<br>20430_Financial_Instrument_EU_SFDR_Minimum_Or_Planned_Other_Investments_With_Environmental_Or_Social_Characteristics   |

element

**EETReportType1.1.2/MinimumSustainableInvestments/MinimumInvestmentsSustainableInvestmentsEnvironmental**

|            |  |
|------------|--|
| diagram    |  <b>MinimumInvestmentsSustainab...</b><br>20440_Financial_Instrument_EU_SFDR_Minimum_Or_Planned_Investments_Sustainable_Investments_Environmental |
| type       | <a href="#">PercentageType</a>   |
| properties | isRef 0<br>minOcc 0<br>maxOcc 1<br>content simple  |
| annotation | documentation<br>20440_Financial_Instrument_EU_SFDR_Minimum_Or_Planned_Investments_Sustainable_Investments_Environmental   |

element

**EETReportType1.1.2/MinimumSustainableInvestments/MinimumInvestmentsSustainableInvestmentsTaxonomyAligned**

|            |   |
|------------|---|
| diagram    |  <b>MinimumInvestmentsSustainab...</b><br>20450_Financial_Instrument_EU_SFDR_Minimum_Or_Planned_Investments_Sustainable_Investments_Taxonomy_Aligned |
| type       | <a href="#">PercentageType</a>  |
| properties | isRef 0<br>minOcc 0<br>maxOcc 1<br>content simple   |
| annotation | documentation<br>20450_Financial_Instrument_EU_SFDR_Minimum_Or_Planned_Investments_Sustainable_Investments_Taxonomy_Aligned   |

element

**EETReportType1.1.2/MinimumSustainableInvestments/MinimumInvestmentsSustainableInvestmentsOtherEnvironmental**

|            |  |
|------------|--|
| diagram    |  <b>MinimumInvestmentsSustainab...</b><br>20460_Financial_Instrument_EU_SFDR_Minimum_Or_Planned_Investments_Sustainable_Investments_Other_Environmental |
| type       | <a href="#">PercentageType</a>   |
| properties | isRef 0<br>minOcc 0<br>maxOcc 1<br>content simple  |
| annotation | documentation<br>20460_Financial_Instrument_EU_SFDR_Minimum_Or_Planned_Investments_Sustainable_Investments_Other_Environmental   |

element

**EETReportType1.1.2/MinimumSustainableInvestments/MinimumInvestmentsSustainableInvestmentsSocial**

|            |   |
|------------|---|
| diagram    |  <b>MinimumInvestmentsSustainab...</b><br>20470_Financial_Instrument_EU_SFDR_Minimum_Or_Planned_Investments_Sustainable_Investments_Social |
| type       | <a href="#">PercentageType</a>  |
| properties | isRef 0<br>minOcc 0<br>maxOcc 1<br>content simple   |
| annotation | documentation<br>20470_Financial_Instrument_EU_SFDR_Minimum_Or_Planned_Investments_Sustainable_Investments_Social   |

element **EETReportType1.1.2/LastReportedSustainableInvestments**

|                   |   |
|-------------------|---|
| <p>diagram</p>    | <p><b>LastReportedSustainableInves...</b><br/>20480 - 20560</p> <ul style="list-style-type: none"> <li><b>LastReportedAssetAllocationDate</b><br/>20480_Financial_Instrument_Last_Reported_Asset_Allocation_Date<br/>The date to which the disclosure refer</li> <li><b>LastReportedInvestmentsWithE...</b><br/>20490_Financial_Instrument_EU_SFDR_Last_Reported_Investments_With_Environmental_Or_Social_Characteristics</li> <li><b>LastReportedInvestmentsNotSu...</b><br/>20500_Financial_Instrument_EU_SFDR_Last_Reported_Investments_Not_Sustainable_Other</li> <li><b>LastReportedInvestments Susta...</b><br/>20510_Financial_Instrument_EU_SFDR_Last_Reported_Investments_Are_Sustainable_Investments</li> <li><b>LastReportedOtherInvestments...</b><br/>20520_Financial_Instrument_EU_SFDR_Last_Reported_Other_Investments_With_Environmental_Or_Social_Characteristics</li> <li><b>LastReportedInvestments Susta...</b><br/>20530_Financial_Instrument_EU_SFDR_Last_Reported_Investments_Are_Sustainable_Investments_Environmental</li> <li><b>LastReportedInvestments Susta...</b><br/>20540_Financial_Instrument_EU_SFDR_Last_Reported_Investments_Are_Sustainable_Investments_Taxonomy_Aligned</li> <li><b>LastReportedInvestments Susta...</b><br/>20550_Financial_Instrument_EU_SFDR_Last_Reported_Investments_Are_Sustainable_Investments_Other_Environmental</li> <li><b>LastReportedInvestments Susta...</b><br/>20560_Financial_Instrument_EU_SFDR_Last_Reported_Investments_Are_Sustainable_Investments_Social</li> </ul> |
| <p>properties</p> | <p>isRef 0<br/>minOcc 0<br/>maxOcc 1<br/>content complex</p>  |
| <p>children</p>   | <p><a href="#">LastReportedAssetAllocationDate</a> <a href="#">LastReportedInvestmentsWithEnvironmentalOrSocialCharacteristics</a><br/><a href="#">LastReportedInvestmentsNotSustainableOther</a> <a href="#">LastReportedInvestmentsSustainableInvestments</a><br/><a href="#">LastReportedOtherInvestmentsWithEnvironmentalOrSocialCharacteristics</a><br/><a href="#">LastReportedInvestmentsSustainableInvestmentsEnvironmental</a><br/><a href="#">LastReportedInvestmentsSustainableInvestmentsTaxonomyAligned</a><br/><a href="#">LastReportedInvestmentsSustainableInvestmentsOtherEnvironmental</a><br/><a href="#">LastReportedInvestmentsSustainableInvestmentsSocial</a></p>  |
| <p>annotation</p> | <p>documentation<br/>20480 - 20560</p>  |

element **EETReportType1.1.2/LastReportedSustainableInvestments/LastReportedAssetAllocationDate**

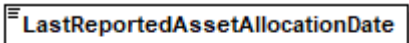
|            |  |
|------------|--|
| diagram    |  <p>20480_Financial_Instrument_Last_Reported_Asset_Allocation_Date<br/>The date to which the disclosure refer</p> |
| type       | <b>xs:date</b>   |
| properties | isRef 0<br>content simple  |
| annotation | documentation<br>20480_Financial_Instrument_Last_Reported_Asset_Allocation_Date<br>The date to which the disclosure refer  |

element

**EETReportType1.1.2/LastReportedSustainableInvestments/LastReportedInvestmentsWithEnvironmentalOrSocialCharacteristics**

|            |  |
|------------|--|
| diagram    |  <p>20490_Financial_Instrument_EU_SFDR_Last_Reported_Investments_With_Environmental_Or_Social_Characteristics</p> |
| type       | <a href="#">PercentageType</a>   |
| properties | isRef 0<br>minOcc 0<br>maxOcc 1<br>content simple  |
| annotation | documentation<br>20490_Financial_Instrument_EU_SFDR_Last_Reported_Investments_With_Environmental_Or_Social_Characteristics   |

element

**EETReportType1.1.2/LastReportedSustainableInvestments/LastReportedInvestmentsNotSustainableOther**

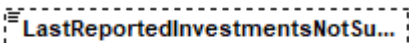
|            |   |
|------------|---|
| diagram    |  <p>20500_Financial_Instrument_EU_SFDR_Last_Reported_Investments_Not_Sustainable_Other</p> |
| type       | <a href="#">PercentageType</a>  |
| properties | isRef 0<br>minOcc 0<br>maxOcc 1<br>content simple   |
| annotation | documentation<br>20500_Financial_Instrument_EU_SFDR_Last_Reported_Investments_Not_Sustainable_Other   |

element

**EETReportType1.1.2/LastReportedSustainableInvestments/LastReportedInvestmentsSustainableInvestments**

|            |   |
|------------|---|
| diagram    | <br>20510_Financial_Instrument_EU_SFDR_Last_Reported_Investments_Are_Sustainable_Investments |
| type       | <a href="#">PercentageType</a>  |
| properties | isRef 0<br>minOcc 0<br>maxOcc 1<br>content simple   |
| annotation | documentation<br>20510_Financial_Instrument_EU_SFDR_Last_Reported_Investments_Are_Sustainable_Investments   |

element

**EETReportType1.1.2/LastReportedSustainableInvestments/LastReportedOtherInvestmentsWithEnvironmentalOrSocialCharacteristics**

|            |  |
|------------|--|
| diagram    | <br>20520_Financial_Instrument_EU_SFDR_Last_Reported_Other_Investments_With_Environmental_Or_Social_Characteristics |
| type       | <a href="#">PercentageType</a>   |
| properties | isRef 0<br>minOcc 0<br>maxOcc 1<br>content simple  |
| annotation | documentation<br>20520_Financial_Instrument_EU_SFDR_Last_Reported_Other_Investments_With_Environmental_Or_Social_Characteristics   |

element

**EETReportType1.1.2/LastReportedSustainableInvestments/LastReportedInvestmentsSustainableInvestmentsEnvironmental**

|            |   |
|------------|---|
| diagram    | <br>20530_Financial_Instrument_EU_SFDR_Last_Reported_Investments_Are_Sustainable_Investments_Environmental |
| type       | <a href="#">PercentageType</a>  |
| properties | isRef 0<br>minOcc 0<br>maxOcc 1<br>content simple   |
| annotation | documentation<br>20530_Financial_Instrument_EU_SFDR_Last_Reported_Investments_Are_Sustainable_Investments_Environmental   |

element

**EETReportType1.1.2/LastReportedSustainableInvestments/LastReportedInvestmentsSustainableInvestmentsTaxonomyAligned**

|            |  |
|------------|--|
| diagram    |  <b>LastReportedInvestments Susta...</b><br>20540_Financial_Instrument_EU_SFDR_Last_Reported_Investments_Are_Sustainable_Investments_Taxonomy_Aligned |
| type       | <a href="#">PercentageType</a>   |
| properties | isRef 0<br>minOcc 0<br>maxOcc 1<br>content simple  |
| annotation | documentation<br>20540_Financial_Instrument_EU_SFDR_Last_Reported_Investments_Are_Sustainable_Investments_Taxonomy_Aligned   |

element

**EETReportType1.1.2/LastReportedSustainableInvestments/LastReportedInvestmentsSustainableInvestmentsOtherEnvironmental**

|            |   |
|------------|---|
| diagram    |  <b>LastReportedInvestments Susta...</b><br>20550_Financial_Instrument_EU_SFDR_Last_Reported_Investments_Are_Sustainable_Investments_Other_Environmental |
| type       | <a href="#">PercentageType</a>  |
| properties | isRef 0<br>minOcc 0<br>maxOcc 1<br>content simple   |
| annotation | documentation<br>20550_Financial_Instrument_EU_SFDR_Last_Reported_Investments_Are_Sustainable_Investments_Other_Environmental   |

element

**EETReportType1.1.2/LastReportedSustainableInvestments/LastReportedInvestmentsSustainableInvestmentsSocial**

|            |  |
|------------|--|
| diagram    |  <b>LastReportedInvestments Susta...</b><br>20560_Financial_Instrument_EU_SFDR_Last_Reported_Investments_Are_Sustainable_Investments_Social |
| type       | <a href="#">PercentageType</a>   |
| properties | isRef 0<br>minOcc 0<br>maxOcc 1<br>content simple  |
| annotation | documentation<br>20560_Financial_Instrument_EU_SFDR_Last_Reported_Investments_Are_Sustainable_Investments_Social   |

element **EETReportType1.1.2/AdditionalInfoArt9**

|            |   |
|------------|---|
| diagram    |   |
| properties | isRef 0<br>minOcc 0<br>maxOcc 1<br>content complex  |
| children   | <a href="#">ObjectiveReductionInCarbonEmissions</a> <a href="#">AlignedWithParisAgreement</a> |
| annotation | documentation<br>20570 - 20580  |

element **EETReportType1.1.2/AdditionalInfoArt9/ObjectiveReductionInCarbonEmissions**

|            |   |
|------------|---|
| diagram    |   |
| type       | <a href="#">EETYesNoType</a>  |
| properties | isRef 0<br>minOcc 0<br>maxOcc 1<br>content simple   |
| facets     | Kind Value annotation<br>length 1   |
| annotation | documentation<br>20570_Financial_Instrument_With_Objective_Of_A_Reduction_In_Carbon_Emissions<br>Does the Financial Instrument have the objective of reduction in carbon emissions? |

element **EETReportType1.1.2/AdditionalInfoArt9/AlignedWithParisAgreement**

|            |   |
|------------|---|
| diagram    |   |
| type       | <a href="#">EETYesNoType</a>  |
| properties | isRef 0<br>minOcc 0<br>maxOcc 1<br>content simple   |
| facets     | Kind Value annotation<br>length 1   |
| annotation | documentation<br>20580_Financial_Instrument_Aligned_With_Paris_Agreement<br>Is the Financial Instrument Aligned with the Paris Agreement? |

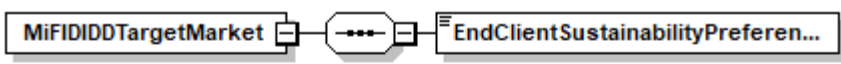

element **EETReportType1.1.2/MiFIDIDDTargetMarket**

|            |  |
|------------|--|
| diagram    |  <p>20590</p> <p>MIFID: COMMISSION DELEGATED REGULATION (EU) 2021/1253 Art. 1<br/>IDD: COMMISSION DELEGATED DIRECTIVE (EU) 2021/1257 Art. 2</p> <p>answer = Yes or Neutral</p> |
| properties | isRef 0<br>content complex   |
| children   | <a href="#">EndClientSustainabilityPreferences_Considered</a>  |
| annotation | documentation<br>20590   |

element **EETReportType1.1.2/MiFIDIDDTargetMarket/EndClientSustainabilityPreferences\_Considered**

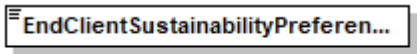
| diagram    |  <p>MIFID: COMMISSION DELEGATED REGULATION (EU) 2021/1253 Art. 1<br/>IDD: COMMISSION DELEGATED DIRECTIVE (EU) 2021/1257 Art. 2</p> <p>answer = Yes or Neutral</p> |            |       |            |           |   |  |           |   |  |
|------------|--|------------|-------|------------|-----------|---|--|-----------|---|--|
| type       | <a href="#">EETYesNeutralType</a>  |            |       |            |           |   |  |           |   |  |
| properties | isRef 0<br>content simple  |            |       |            |           |   |  |           |   |  |
| facets     | <table border="1"> <thead> <tr> <th>Kind</th> <th>Value</th> <th>annotation</th> </tr> </thead> <tbody> <tr> <td>minLength</td> <td>1</td> <td></td> </tr> <tr> <td>maxLength</td> <td>7</td> <td></td> </tr> </tbody> </table>                    | Kind       | Value | annotation | minLength | 1 |  | maxLength | 7 |  |
| Kind       | Value  | annotation |       |            |           |   |  |           |   |  |
| minLength  | 1  |            |       |            |           |   |  |           |   |  |
| maxLength  | 7  |            |       |            |           |   |  |           |   |  |
| annotation | documentation<br>MIFID: COMMISSION DELEGATED REGULATION (EU) 2021/1253 Art. 1<br>IDD: COMMISSION DELEGATED DIRECTIVE (EU) 2021/1257 Art. 2   |            |       |            |           |   |  |           |   |  |
|            | answer = Yes or Neutral  |            |       |            |           |   |  |           |   |  |

element **EETReportType1.1.2/TaxonomyAlignedInvestments**

diagram

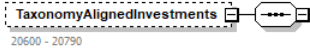

- MinimumInvestmentsEUTaxono...**  
 20600\_Financial\_Instrument\_Minimum\_Percentage\_Investments\_Aligned\_EU\_Taxonomy\_Incl\_Sovereign\_Bonds
- MinimumInvestmentsEUTaxono...**  
 20610\_Financial\_Instrument\_Minimum\_Percentage\_Investments\_Aligned\_EU\_Taxonomy\_Excl\_Sovereign\_Bonds
- SubjectToExternalReviewByThir...**  
 20620\_Financial\_Instrument\_Was\_This\_Statement\_Subject\_To\_An\_External\_Review\_By\_Third\_Party
- MethodologyUsedForAlignment...**  
 20630\_Financial\_Instrument\_Methodology\_Used\_For\_Alignment\_Calculation\_With\_EU\_Taxonomy  
 Discloses the methodology used for alignment calculation with the EU Taxonomy, defined as either Revenue (R), CapEx (C) or OpEx (O)
- MinimumShareOfTransitionalAc...**  
 20640\_Financial\_Instrument\_Minimum\_Share\_Of\_Transitional\_Activities
- MinimumShareOfEnablingActivit...**  
 20650\_Financial\_Instrument\_Minimum\_Share\_Of\_Enabling\_Activities
- TaxonomyAlignedInclSovereign...**  
 20660\_Financial\_Instrument\_Percentage\_Taxonomy\_Aligned\_Incl\_Sovereign\_Revenue
- TaxonomyAlignedInclSovereign...**  
 20670\_Financial\_Instrument\_Percentage\_Taxonomy\_Aligned\_Incl\_Sovereign\_Capex
- TaxonomyAlignedInclSovereign...**  
 20680\_Financial\_Instrument\_Percentage\_Taxonomy\_Aligned\_Incl\_Sovereign\_Opex
- TaxonomyAlignedExclSovereign...**  
 20690\_Financial\_Instrument\_Percentage\_Taxonomy\_Aligned\_Excl\_Sovereign\_Revenue
- TaxonomyAlignedExclSovereign...**  
 20700\_Financial\_Instrument\_Percentage\_Taxonomy\_Aligned\_Excl\_Sovereign\_Capex
- TaxonomyAlignedExclSovereign...**  
 20710\_Financial\_Instrument\_Percentage\_Taxonomy\_Aligned\_Excl\_Sovereign\_Opex
- ClimateChangeMitigationPercen...**  
 20721\_Financial\_Instrument\_Climate\_Change\_Mitigation\_Percentage
- ClimateChangeAdaptationPercen...**  
 20731\_Financial\_Instrument\_Climate\_Change\_Adaptation\_Percentage
- SustainableUseAndProtectionOf...**  
 20741\_Financial\_Instrument\_Sustainable\_Use\_And\_Protection\_Of\_Water\_And\_Marine\_Resources\_Percentage
- TransitionToCircularEconomyPe...**  
 20751\_Financial\_Instrument\_Transition\_To\_A\_Circular\_Economy\_Percentage
- PollutionPreventionAndControl...**  
 20761\_Financial\_Instrument\_Pollution\_Prevention\_And\_Control\_Percentage
- ProtectionAndRestorationOfBio...**  
 20771\_Financial\_Instrument\_Protection\_And\_Restoration\_Of\_Biodiversity\_And\_Ecosystems\_Percentage
- ShareOfTransitionalActivities**  
 20780\_Financial\_Instrument\_Share\_Of\_Transitional\_Activities
- ShareOfEnablingActivities**  
 20790\_Financial\_Instrument\_Share\_Of\_Enabling\_Activities

|            |   |
|------------|---|
| properties | isRef 0<br>minOcc 0<br>maxOcc 1<br>content complex  |
| children   | <a href="#">MinimumInvestmentsEUTaxonomy_InclSovereignBonds</a> <a href="#">MinimumInvestmentsEUTaxonomy_ExclSovereignBonds</a> <a href="#">SubjectToExternalReviewByThirdParty_MethodologyUsedForAlignmentCalculationWith_EU_Taxonomy_MinimumShareOfTransitionalActivities_MinimumShareOfEnablingActivities</a> <a href="#">TaxonomyAlignedInclSovereignRevenue</a> <a href="#">TaxonomyAlignedInclSovereignCapex</a> <a href="#">TaxonomyAlignedInclSovereignOpex</a> <a href="#">TaxonomyAlignedExclSovereignRevenue</a> <a href="#">TaxonomyAlignedExclSovereignCapex</a> <a href="#">TaxonomyAlignedExclSovereignOpex</a> <a href="#">ClimateChangeMitigationPercentage</a> <a href="#">ClimateChangeAdaptationPercentage</a> <a href="#">SustainableUseAndProtectionOfWaterAndMarineResourcesPercentage</a> <a href="#">TransitionToCircularEconomyPercentage</a> <a href="#">PollutionPreventionAndControlPercentage</a> <a href="#">ProtectionAndRestorationOfBiodiversityAndEcosystemsPercentage</a> <a href="#">ShareOfTransitionalActivities</a> <a href="#">ShareOfEnablingActivities</a> |
| annotation | documentation<br>20600 - 20790  |

element

**EETReportType1.1.2/TaxonomyAlignedInvestments/MinimumInvestmentsEUTaxonomy\_InclSovereign Bonds**

|            |  |
|------------|--|
| diagram    |  <b>MinimumInvestmentsEUTaxono...</b><br>20600_Financial_Instrument_Minimum_Percentage_Investments_Aligned_EU_Taxonomy_Incl_Sovereign_Bonds |
| type       | <b>xs:decimal</b>  |
| properties | isRef 0<br>minOcc 0<br>maxOcc 1<br>content simple  |
| annotation | documentation<br>20600_Financial_Instrument_Minimum_Percentage_Investments_Aligned_EU_Taxonomy_Incl_Sovereign_Bonds  |

element

**EETReportType1.1.2/TaxonomyAlignedInvestments/MinimumInvestmentsEUTaxonomy\_ExclSovereign Bonds**

|            |  |
|------------|--|
| diagram    |  <b>MinimumInvestmentsEUTaxono...</b><br>20610_Financial_Instrument_Minimum_Percentage_Investments_Aligned_EU_Taxonomy_Excl_Sovereign_Bonds |
| type       | <b>xs:decimal</b>  |
| properties | isRef 0<br>minOcc 0<br>maxOcc 1<br>content simple  |
| annotation | documentation<br>20610_Financial_Instrument_Minimum_Percentage_Investments_Aligned_EU_Taxonomy_Excl_Sovereign_Bonds  |

element **EETReportType1.1.2/TaxonomyAlignedInvestments/SubjectToExternalReviewByThirdParty**

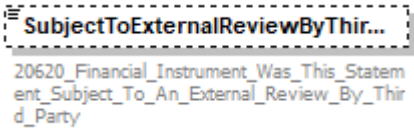
|            |   |
|------------|---|
| diagram    |  <p>20620_Financial_Instrument_Was_This_Statement_Subject_To_An_External_Review_By_Third_Party</p> |
| type       | <b>EETYesNoType</b>   |
| properties | isRef 0<br>minOcc 0<br>maxOcc 1<br>content simple   |
| facets     | Kind Value annotation<br>length 1   |
| annotation | documentation<br>20620_Financial_Instrument_Was_This_Statement_Subject_To_An_External_Review_By_Third_Party   |

element **EETReportType1.1.2/TaxonomyAlignedInvestments/MethodologyUsedForAlignmentCalculationWith\_EU\_Taxonomy**

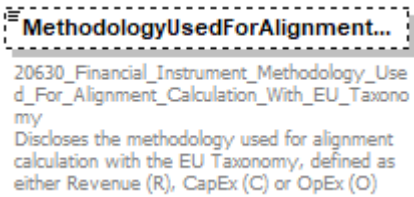
|            |   |
|------------|---|
| diagram    |  <p>20630_Financial_Instrument_Methodology_Used_For_Alignment_Calculation_With_EU_Taxonomy<br/>         Discloses the methodology used for alignment calculation with the EU Taxonomy, defined as either Revenue (R), CapEx (C) or OpEx (O)</p> |
| type       | restriction of <b>xs:string</b>   |
| properties | isRef 0<br>minOcc 0<br>maxOcc 1<br>content simple   |
| annotation | documentation<br>20630_Financial_Instrument_Methodology_Used_For_Alignment_Calculation_With_EU_Taxonomy<br>Discloses the methodology used for alignment calculation with the EU Taxonomy, defined as either Revenue (R), CapEx (C) or OpEx (O)  |

element **EETReportType1.1.2/TaxonomyAlignedInvestments/MinimumShareOfTransitionalActivities**

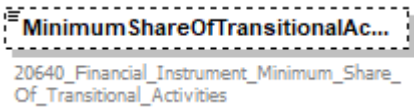
|            |  |
|------------|--|
| diagram    |  <p>20640_Financial_Instrument_Minimum_Share_Of_Transitional_Activities</p> |
| type       | <b>xs:decimal</b>  |
| properties | isRef 0<br>minOcc 0<br>maxOcc 1<br>content simple  |
| annotation | documentation<br>20640_Financial_Instrument_Minimum_Share_Of_Transitional_Activities   |

element **EETReportType1.1.2/TaxonomyAlignedInvestments/MinimumShareOfEnablingActivities**

|            |   |
|------------|---|
| diagram    |  <b>Minimum ShareOfEnablingActivit...</b><br>20650_Financial_Instrument_Minimum_Share_Of_Enabling_Activities |
| type       | <b>xs:decimal</b>   |
| properties | isRef 0<br>minOcc 0<br>maxOcc 1<br>content simple   |
| annotation | documentation<br>20650_Financial_Instrument_Minimum_Share_Of_Enabling_Activities  |

element **EETReportType1.1.2/TaxonomyAlignedInvestments/TaxonomyAlignedInclSovereignRevenue**

|            |   |
|------------|---|
| diagram    |  <b>TaxonomyAlignedInclSovereign...</b><br>20660_Financial_Instrument_Percentage_Taxonomy_Aligned_Incl_Sovereign_Revenue |
| type       | <b>xs:decimal</b>   |
| properties | isRef 0<br>minOcc 0<br>maxOcc 1<br>content simple   |
| annotation | documentation<br>20660_Financial_Instrument_Percentage_Taxonomy_Aligned_Incl_Sovereign_Revenue  |

element **EETReportType1.1.2/TaxonomyAlignedInvestments/TaxonomyAlignedInclSovereignCapex**

|            |   |
|------------|---|
| diagram    |  <b>TaxonomyAlignedInclSovereign...</b><br>20670_Financial_Instrument_Percentage_Taxonomy_Aligned_Incl_Sovereign_Capex |
| type       | <b>xs:decimal</b>   |
| properties | isRef 0<br>minOcc 0<br>maxOcc 1<br>content simple   |
| annotation | documentation<br>20670_Financial_Instrument_Percentage_Taxonomy_Aligned_Incl_Sovereign_Capex  |

element **EETReportType1.1.2/TaxonomyAlignedInvestments/TaxonomyAlignedInclSovereignOpex**

|            |  |
|------------|--|
| diagram    |  <b>TaxonomyAlignedInclSovereign...</b><br>20680_Financial_Instrument_Percentage_Taxonomy_Aligned_Incl_Sovereign_Opex |
| type       | <b>xs:decimal</b>  |
| properties | isRef 0<br>minOcc 0<br>maxOcc 1<br>content simple  |
| annotation | documentation<br>20680_Financial_Instrument_Percentage_Taxonomy_Aligned_Incl_Sovereign_Opex  |

element **EETReportType1.1.2/TaxonomyAlignedInvestments/TaxonomyAlignedExclSovereignRevenue**

|            |   |
|------------|---|
| diagram    |  <b>TaxonomyAlignedExclSovereign...</b><br>20690_Financial_Instrument_Percentage_Taxonomy_Aligned_Excl_Sovereign_Revenue |
| type       | <b>xs:decimal</b>   |
| properties | isRef 0<br>minOcc 0<br>maxOcc 1<br>content simple   |
| annotation | documentation<br>20690_Financial_Instrument_Percentage_Taxonomy_Aligned_Excl_Sovereign_Revenue  |

element **EETReportType1.1.2/TaxonomyAlignedInvestments/TaxonomyAlignedExclSovereignCapex**

|            |   |
|------------|---|
| diagram    |  <b>TaxonomyAlignedExclSovereign...</b><br>20700_Financial_Instrument_Percentage_Taxonomy_Aligned_Excl_Sovereign_Capex |
| type       | <b>xs:decimal</b>   |
| properties | isRef 0<br>minOcc 0<br>maxOcc 1<br>content simple   |
| annotation | documentation<br>20700_Financial_Instrument_Percentage_Taxonomy_Aligned_Excl_Sovereign_Capex  |

element **EETReportType1.1.2/TaxonomyAlignedInvestments/TaxonomyAlignedExclSovereignOpex**

|            |  |
|------------|--|
| diagram    |  <b>TaxonomyAlignedExclSovereign...</b><br>20710_Financial_Instrument_Percentage_Taxonomy_Aligned_Excl_Sovereign_Opex |
| type       | <b>xs:decimal</b>  |
| properties | isRef 0<br>minOcc 0<br>maxOcc 1<br>content simple  |
| annotation | documentation<br>20710_Financial_Instrument_Percentage_Taxonomy_Aligned_Excl_Sovereign_Opex  |

element **EETReportType1.1.2/TaxonomyAlignedInvestments/ClimateChangeMitigationPercentage**

|            |  |
|------------|--|
| diagram    |  <b>ClimateChangeMitigationPercen...</b><br>20721_Financial_Instrument_Climate_Change_Mitigation_Percentage |
| type       | <b>xs:decimal</b>  |
| properties | isRef 0<br>minOcc 0<br>maxOcc 1<br>content simple  |

|            |  |
|------------|--|
| annotation | documentation<br>20721_Financial_Instrument_Climate_Change_Mitigation_Percentage |
|------------|--|

element **EETReportType1.1.2/TaxonomyAlignedInvestments/ClimateChangeAdaptationPercentage**

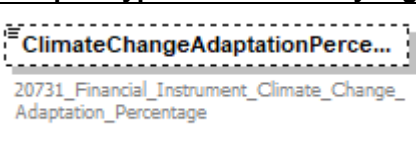
|            |   |
|------------|---|
| diagram    |  |
| type       | <b>xs:decimal</b>   |
| properties | isRef 0<br>minOcc 0<br>maxOcc 1<br>content simple                                 |
| annotation | documentation<br>20731_Financial_Instrument_Climate_Change_Adaptation_Percentage  |

element **EETReportType1.1.2/TaxonomyAlignedInvestments/SustainableUseAndProtectionOfWaterAndMarineResourcesPercentage**

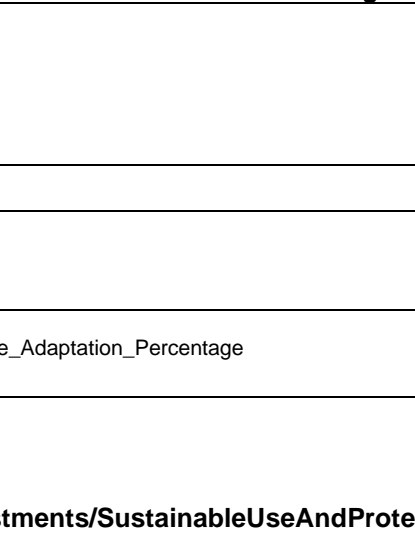
|            |   |
|------------|---|
| diagram    |                                   |
| type       | <b>xs:decimal</b>   |
| properties | isRef 0<br>minOcc 0<br>maxOcc 1<br>content simple   |
| annotation | documentation<br>20741_Financial_Instrument_Sustainable_Use_And_Protection_Of_Water_And_Marine_Resources_Percentage |

element **EETReportType1.1.2/TaxonomyAlignedInvestments/TransitionToCircularEconomyPercentage**

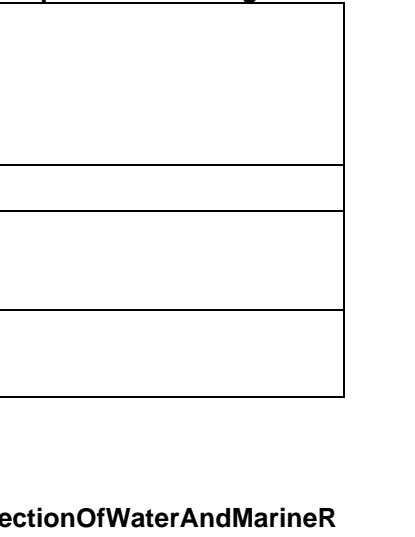
|            |   |
|------------|---|
| diagram    |      |
| type       | <b>xs:decimal</b>   |
| properties | isRef 0<br>minOcc 0<br>maxOcc 1<br>content simple                                       |
| annotation | documentation<br>20751_Financial_Instrument_Transition_To_A_Circular_Economy_Percentage |

element **EETReportType1.1.2/TaxonomyAlignedInvestments/PollutionPreventionAndControlPercentage**

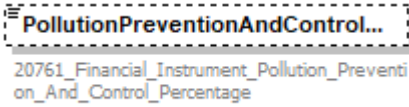
|            |   |
|------------|---|
| diagram    |        |
| type       | <b>xs:decimal</b>   |
| properties | isRef 0<br>minOcc 0<br>maxOcc 1<br>content simple                                       |
| annotation | documentation<br>20761_Financial_Instrument_Pollution_Prevention_And_Control_Percentage |

element

**EETReportType1.1.2/TaxonomyAlignedInvestments/ProtectionAndRestorationOfBiodiversityAndEcosystemsPercentage**

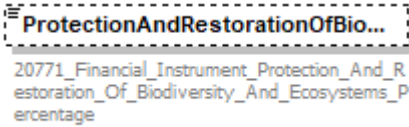
|            |  |
|------------|--|
| diagram    |                                 |
| type       | <b>xs:decimal</b>  |
| properties | isRef 0<br>minOcc 0<br>maxOcc 1<br>content simple  |
| annotation | documentation<br>20771_Financial_Instrument_Protection_And_Restoration_Of_Biodiversity_And_Ecosystems_Percentage |

element **EETReportType1.1.2/TaxonomyAlignedInvestments/ShareOfTransitionalActivities**

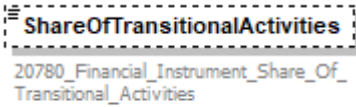
|            |   |
|------------|---|
| diagram    |  |
| type       | <b>xs:decimal</b>   |
| properties | isRef 0<br>minOcc 0<br>maxOcc 1<br>content simple                                   |
| annotation | documentation<br>20780_Financial_Instrument_Share_Of_Transitional_Activities        |

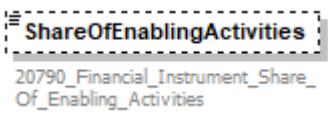

element **EETReportType1.1.2/TaxonomyAlignedInvestments/ShareOfEnablingActivities**

|            |   |
|------------|---|
| diagram    |  <p><b>ShareOfEnablingActivities</b><br/>20790_Financial_Instrument_Share_Of_Enabling_Activities</p> |
| type       | <b>xs:decimal</b>   |
| properties | isRef 0<br>minOcc 0<br>maxOcc 1<br>content simple   |
| annotation | documentation<br>20790_Financial_Instrument_Share_Of_Enabling_Activities  |

element **EETReportType1.1.2/PrincipalAdverseIndicators**

|            |   |
|------------|---|
| diagram    |  <p><b>PrincipalAdverseIndicators</b><br/>30000 - 33440</p> <ul style="list-style-type: none"> <li><b>PAISnapshotFrequency</b><br/>30000_PAISnapshot_Frequency<br/>Annual (Calendar year) or Quarterly (Calendar quarter) or Monthly</li> <li><b>PAIReferenceDate</b><br/>30010_PAISnapshot_Frequency<br/>Date to which data refer</li> <li><b>ClimateAndEnvironmentRelatedIndicators</b><br/>30020 - 30970</li> <li><b>SocialAndEmployeeMatters</b><br/>30980 - 31160</li> <li><b>SovereignAndSupranationalInvestments</b><br/>31170 - 31280</li> <li><b>RealEstateInvestments</b><br/>31290 - 31360</li> <li><b>MoreClimateAndEnvironmentRelatedIndicators</b><br/>31370 - 32430</li> <li><b>MoreSocialAndEmployeeMatters</b><br/>32440 - 33440</li> </ul> |
| properties | isRef 0<br>minOcc 0<br>maxOcc 1<br>content complex  |
| children   | <a href="#">PAISnapshotFrequency</a> <a href="#">PAIReferenceDate</a> <a href="#">ClimateAndEnvironmentRelatedIndicators</a> <a href="#">SocialAndEmployeeMatters</a> <a href="#">SovereignAndSupranationalInvestments</a> <a href="#">RealEstateInvestments</a> <a href="#">MoreClimateAndEnvironmentRelatedIndicators</a> <a href="#">MoreSocialAndEmployeeMatters</a>  |
| annotation | documentation<br>30000 - 33440  |

element **EETReportType1.1.2/PrincipalAdverseIndicators/PAISnapshotFrequency**

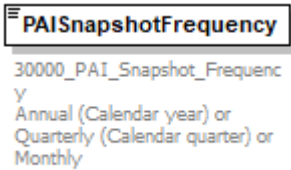
|            |  |
|------------|--|
| diagram    |  <p>30000_PAI_Snapshot_Frequenc<br/>Y<br/>Annual (Calendar year) or<br/>Quarterly (Calendar quarter) or<br/>Monthly</p> |
| type       | restriction of <b>xs:string</b>  |
| properties | isRef 0<br>content simple  |
| annotation | documentation<br>30000_PAI_Snapshot_Frequency<br>Annual (Calendar year) or Quarterly (Calendar quarter) or Monthly   |

element **EETReportType1.1.2/PrincipalAdverseIndicators/PAIReferenceDate**

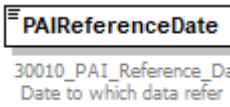
|            |  |
|------------|--|
| diagram    |  <p>30010_PAI_Reference_Date<br/>Date to which data refer</p> |
| type       | <b>xs:date</b>   |
| properties | isRef 0<br>content simple  |
| annotation | documentation<br>30010_PAI_Reference_Date<br>Date to which data refer  |

element **EETReportType1.1.2/PrincipalAdverseIndicators/ClimateAndEnvironmentRelatedIndicators**

|                   |  |
|-------------------|--|
| <p>diagram</p>    |  |
| <p>properties</p> | <p>isRef 0<br/>minOcc 0<br/>maxOcc 1<br/>content complex</p>   |
| <p>children</p>   | <p><a href="#">GreenhousegasEmissions</a> <a href="#">CarbonFootprintScope12</a> <a href="#">CarbonFootprintScope123</a><br/><a href="#">GHG_IntensityOfInvesteeCompaniesScope12</a> <a href="#">GHG_IntensityOfInvesteeCompaniesScope123</a><br/><a href="#">ExposureToCompaniesActiveInTheFossilFuelSector</a> <a href="#">EnergyConsumptionFromNonRenewableSources</a><br/><a href="#">EnergyProductionFromNonRenewableSources</a> <a href="#">EnergyConsumptionIntensityPerHighImpactClimateSector</a><br/><a href="#">ActivitiesNegativelyAffectingBiodiversitySensitiveAreas</a> <a href="#">WaterEmissions</a> <a href="#">HazardousWaste</a></p> |
| <p>annotation</p> | <p>documentation<br/>30020 - 30970</p>   |

element

**EETReportType1.1.2/PrincipalAdverseIndicators/ClimateAndEnvironmentRelatedIndicators/Greenhouse gasEmissions**

|            |  |
|------------|--|
| diagram    |  |
| properties | <p>isRef 0<br/> minOcc 0<br/> maxOcc 1<br/> content complex</p>  |
| children   | <p><a href="#">Scope1</a> <a href="#">Scope2</a> <a href="#">Scope3</a> <a href="#">TotalScope12</a> <a href="#">TotalScope123</a></p> |
| annotation | <p>documentation<br/> 30020 - 30210</p>  |

element

**EETReportType1.1.2/PrincipalAdverseIndicators/ClimateAndEnvironmentRelatedIndicators/Greenhouse gasEmissions/Scope1**

|            |   |
|------------|---|
| diagram    |   |
| type       | <p><a href="#">ValueStrategyCoverageType1.1</a></p>             |
| properties | <p>isRef 0<br/> minOcc 0<br/> maxOcc 1<br/> content complex</p> |

|            |  |
|------------|--|
| children   | <a href="#">Value</a> <a href="#">ConsideredInInvestmentStrategy</a> <a href="#">Coverage</a> <a href="#">EligibleAssets</a> |
| annotation | documentation<br>30020 - 30050   |

element

**EETReportType1.1.2/PrincipalAdverseIndicators/ClimateAndEnvironmentRelatedIndicators/GreenhouseGasEmissions/Scope2**

|            |   |
|------------|---|
| diagram    | <p>The diagram shows a central component labeled "ValueStrategyCoverageType1.1" enclosed in a dashed yellow box. To its left is a component labeled "Scope2" with the range "30060 - 30090". A solid line connects "Scope2" to the central box. Inside the central box, four sub-components are listed, each with a dashed border and a small icon to its left:</p> <ul style="list-style-type: none"> <li><b>Value</b></li> <li><b>ConsideredInInvestmentStrategy</b>: Yes (= commitment of the asset manager to improve the PAI), No</li> <li><b>Coverage</b>: % of the notional / AUM, which provide effectively data, or where data could be estimated</li> <li><b>EligibleAssets</b>: % of assets (versus notional / AUM), which could provide data</li> </ul> |
| type       | <a href="#">ValueStrategyCoverageType1.1</a>  |
| properties | isRef 0<br>minOcc 0<br>maxOcc 1<br>content complex  |
| children   | <a href="#">Value</a> <a href="#">ConsideredInInvestmentStrategy</a> <a href="#">Coverage</a> <a href="#">EligibleAssets</a>  |
| annotation | documentation<br>30060 - 30090  |

element

**EETReportType1.1.2/PrincipalAdverseIndicators/ClimateAndEnvironmentRelatedIndicators/GreenhouseGasEmissions/Scope3**

|            |  |
|------------|--|
| diagram    |  |
| type       | <a href="#">ValueStrategyCoverageType1.1</a>   |
| properties | isRef 0<br>minOcc 0<br>maxOcc 1<br>content complex   |
| children   | <a href="#">Value</a> <a href="#">ConsideredInInvestmentStrategy</a> <a href="#">Coverage</a> <a href="#">EligibleAssets</a> |
| annotation | documentation<br>30100 - 30130   |

element

**EETReportType1.1.2/PrincipalAdverseIndicators/ClimateAndEnvironmentRelatedIndicators/GreenhouseGasEmissions/TotalScope12**

|         |  |
|---------|--|
| diagram |  |
|---------|--|

|            |  |
|------------|--|
| type       | <a href="#">ValueStrategyCoverageType1.1.2</a>   |
| properties | isRef 0<br>minOcc 0<br>maxOcc 1<br>content complex   |
| children   | <a href="#">Value</a> <a href="#">ConsideredInInvestmentStrategy</a> <a href="#">Coverage</a> <a href="#">EligibleAssets</a> |
| annotation | documentation<br>30140 - 30170   |

element

**EETReportType1.1.2/PrincipalAdverseIndicators/ClimateAndEnvironmentRelatedIndicators/GreenhouseGasEmissions/TotalScope123**

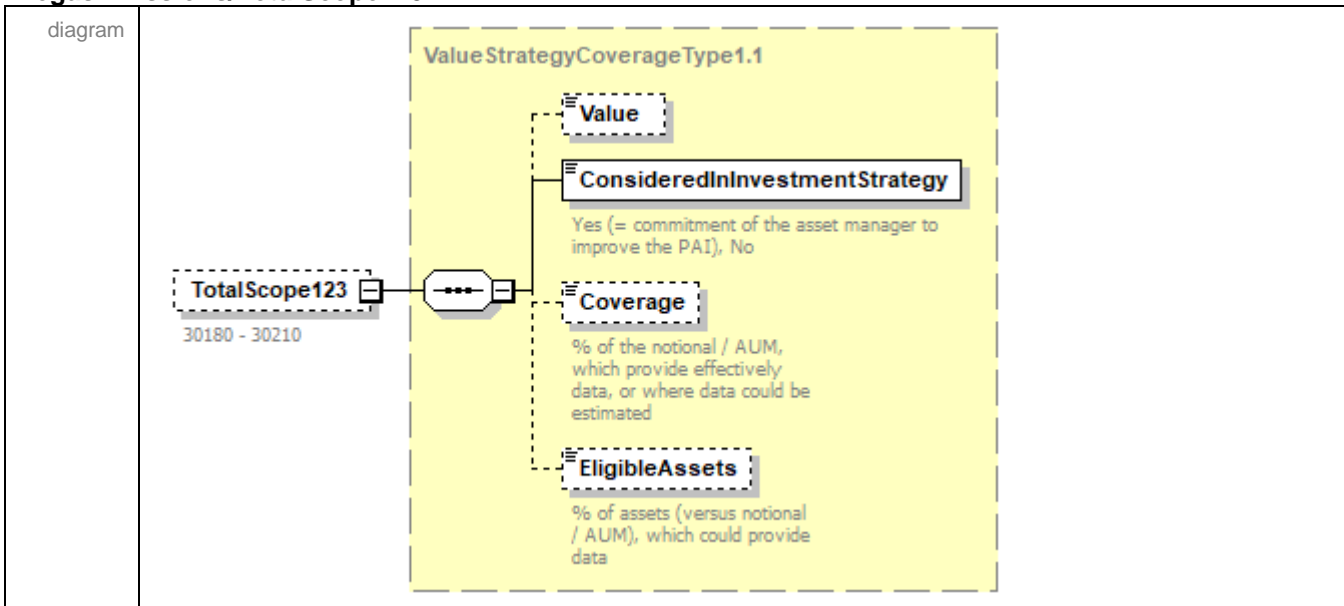

|            |  |
|------------|--|
| type       | <a href="#">ValueStrategyCoverageType1.1</a>   |
| properties | isRef 0<br>minOcc 0<br>maxOcc 1<br>content complex   |
| children   | <a href="#">Value</a> <a href="#">ConsideredInInvestmentStrategy</a> <a href="#">Coverage</a> <a href="#">EligibleAssets</a> |
| annotation | documentation<br>30180 - 30210   |

element

**EETReportType1.1.2/PrincipalAdverseIndicators/ClimateAndEnvironmentRelatedIndicators/CarbonFootprintScope12**

|            |  |
|------------|--|
| diagram    |  |
| type       | <a href="#">ValueStrategyCoverageType1.1.2</a>   |
| properties | isRef 0<br>minOcc 0<br>maxOcc 1<br>content complex   |
| children   | <a href="#">Value</a> <a href="#">ConsideredInInvestmentStrategy</a> <a href="#">Coverage</a> <a href="#">EligibleAssets</a> |
| annotation | documentation<br>30220 - 30250   |

element

**EETReportType1.1.2/PrincipalAdverseIndicators/ClimateAndEnvironmentRelatedIndicators/CarbonFootprintScope123**

|         |  |
|---------|--|
| diagram |  |
|---------|--|



|            |  |
|------------|--|
| type       | <a href="#">ValueStrategyCoverageType1.1</a>   |
| properties | isRef 0<br>minOcc 0<br>maxOcc 1<br>content complex   |
| children   | <a href="#">Value</a> <a href="#">ConsideredInInvestmentStrategy</a> <a href="#">Coverage</a> <a href="#">EligibleAssets</a> |
| annotation | documentation<br>30260 - 30290   |

element

**EETReportType1.1.2/PrincipalAdverseIndicators/ClimateAndEnvironmentRelatedIndicators/GHG\_IntensityOfInvesteeCompaniesScope12**

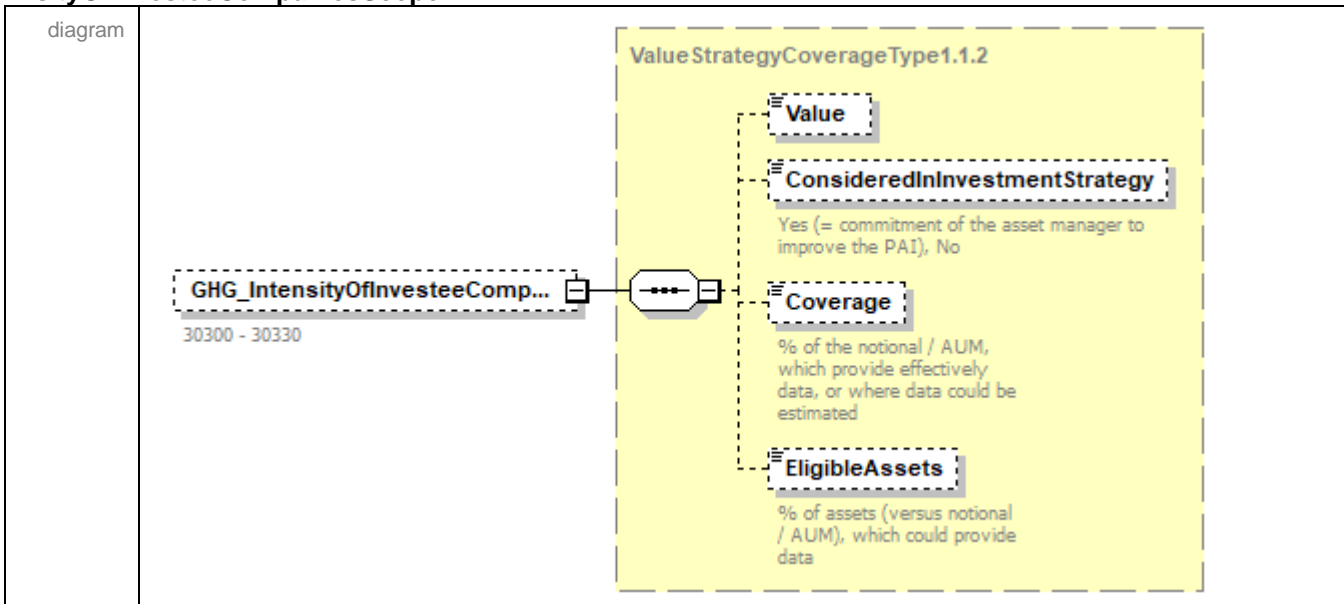

|            |  |
|------------|--|
| type       | <a href="#">ValueStrategyCoverageType1.1.2</a>   |
| properties | isRef 0<br>minOcc 0<br>maxOcc 1<br>content complex   |
| children   | <a href="#">Value</a> <a href="#">ConsideredInInvestmentStrategy</a> <a href="#">Coverage</a> <a href="#">EligibleAssets</a> |
| annotation | documentation<br>30300 - 30330   |

element

**EETReportType1.1.2/PrincipalAdverseIndicators/ClimateAndEnvironmentRelatedIndicators/GHG\_IntensityOfInvesteeCompaniesScope123**

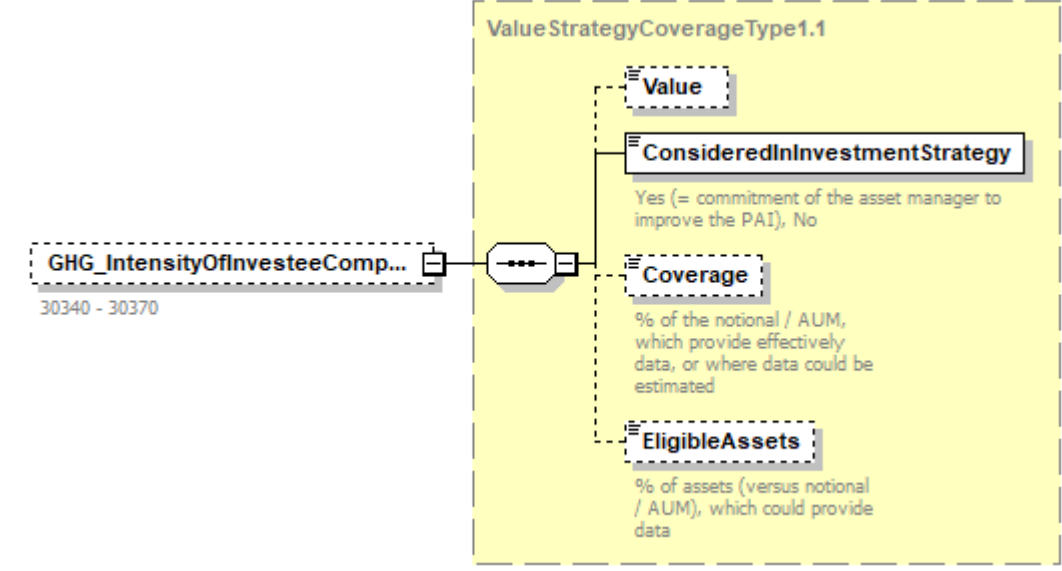
|            |  |
|------------|--|
| diagram    |  <p>The diagram shows a dashed box on the left labeled "GHG_IntensityOfInvesteeComp..." with the range "30340 - 30370". This box is connected to a central connector box, which in turn connects to a larger dashed box on the right labeled "ValueStrategyCoverageType1.1". Inside this larger box, there are three sub-elements: "Value", "ConsideredInInvestmentStrategy" (with a description: "Yes (= commitment of the asset manager to improve the PAI), No"), "Coverage" (with a description: "% of the notional / AUM, which provide effectively data, or where data could be estimated"), and "EligibleAssets" (with a description: "% of assets (versus notional / AUM), which could provide data").</p> |
| type       | <a href="#">ValueStrategyCoverageType1.1</a>   |
| properties | isRef 0<br>minOcc 0<br>maxOcc 1<br>content complex   |
| children   | <a href="#">Value</a> <a href="#">ConsideredInInvestmentStrategy</a> <a href="#">Coverage</a> <a href="#">EligibleAssets</a>   |
| annotation | documentation<br>30340 - 30370   |

element

**EETReportType1.1.2/PrincipalAdverseIndicators/ClimateAndEnvironmentRelatedIndicators/ExposureToCompaniesActiveInTheFossilFuelSector**

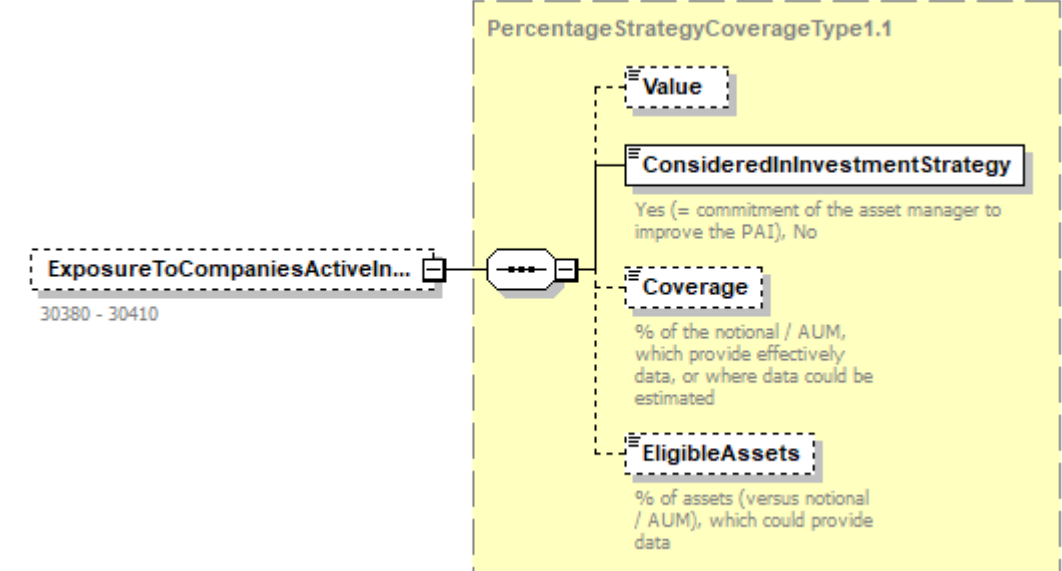
|         |   |
|---------|---|
| diagram |  <p>The diagram shows a dashed box on the left labeled "ExposureToCompaniesActiveIn..." with the range "30380 - 30410". This box is connected to a central connector box, which in turn connects to a larger dashed box on the right labeled "PercentageStrategyCoverageType1.1". Inside this larger box, there are three sub-elements: "Value", "ConsideredInInvestmentStrategy" (with a description: "Yes (= commitment of the asset manager to improve the PAI), No"), "Coverage" (with a description: "% of the notional / AUM, which provide effectively data, or where data could be estimated"), and "EligibleAssets" (with a description: "% of assets (versus notional / AUM), which could provide data").</p> |
|---------|---|

|            |  |
|------------|--|
| type       | <a href="#">PercentageStrategyCoverageType1.1</a>  |
| properties | isRef 0<br>minOcc 0<br>maxOcc 1<br>content complex   |
| children   | <a href="#">Value</a> <a href="#">ConsideredInInvestmentStrategy</a> <a href="#">Coverage</a> <a href="#">EligibleAssets</a> |
| annotation | documentation<br>30380 - 30410   |

element

**EETReportType1.1.2/PrincipalAdverseIndicators/ClimateAndEnvironmentRelatedIndicators/EnergyConsumptionFromNonRenewableSources**

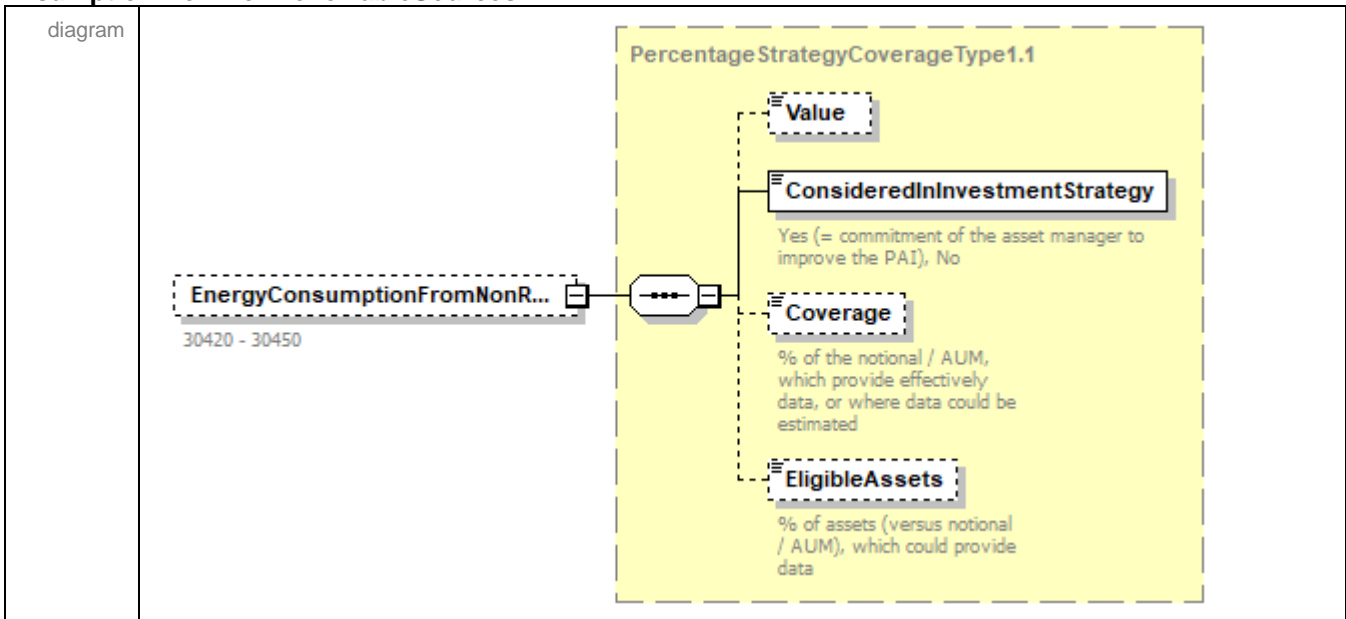

|            |  |
|------------|--|
| type       | <a href="#">PercentageStrategyCoverageType1.1</a>  |
| properties | isRef 0<br>minOcc 0<br>maxOcc 1<br>content complex   |
| children   | <a href="#">Value</a> <a href="#">ConsideredInInvestmentStrategy</a> <a href="#">Coverage</a> <a href="#">EligibleAssets</a> |
| annotation | documentation<br>30420 - 30450   |

element

**EETReportType1.1.2/PrincipalAdverseIndicators/ClimateAndEnvironmentRelatedIndicators/EnergyProductionFromNonRenewableSources**

|                   |   |
|-------------------|---|
| <p>diagram</p>    |   |
| <p>type</p>       | <p><a href="#">PercentageStrategyCoverageType1.1</a></p>  |
| <p>properties</p> | <p>isRef 0<br/>minOcc 0<br/>maxOcc 1<br/>content complex</p>  |
| <p>children</p>   | <p><a href="#">Value</a> <a href="#">ConsideredInInvestmentStrategy</a> <a href="#">Coverage</a> <a href="#">EligibleAssets</a></p> |
| <p>annotation</p> | <p>documentation<br/>30460 - 30490</p>  |

element

**EETReportType1.1.2/PrincipalAdverseIndicators/ClimateAndEnvironmentRelatedIndicators/EnergyConsumptionIntensityPerHighImpactClimateSector**

|                   |  |
|-------------------|--|
| <p>diagram</p>    |  |
| <p>properties</p> | <p>isRef 0<br/>minOcc 0<br/>maxOcc 1<br/>content complex</p> |
| <p>children</p>   | <p><a href="#">NACE_Values</a></p>                           |
| <p>annotation</p> | <p>documentation<br/>30500 - 30850</p>                       |

element

**EETReportType1.1.2/PrincipalAdverseIndicators/ClimateAndEnvironmentRelatedIndicators/EnergyConsumptionIntensityPerHighImpactClimateSector/NACE\_Values**

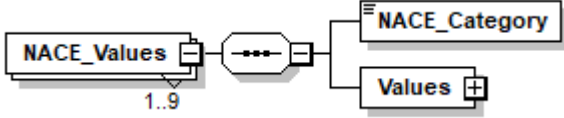
|            |   |
|------------|---|
| diagram    |  <p>The diagram shows a box labeled 'NACE_Values' with a multiplicity of '1..9'. This box is connected to a container (represented by a rounded rectangle with a dashed line) which contains two sub-elements: 'NACE_Category' and 'Values'.</p> |
| properties | isRef 0<br>minOcc 1<br>maxOcc 9<br>content complex  |
| children   | <a href="#">NACE_Category</a> <a href="#">Values</a>  |

element

**EETReportType1.1.2/PrincipalAdverseIndicators/ClimateAndEnvironmentRelatedIndicators/EnergyConsumptionIntensityPerHighImpactClimateSector/NACE\_Values/NACE\_Category**

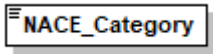
|            |  |
|------------|--|
| diagram    |  <p>The diagram shows a single box labeled 'NACE_Category'.</p> |
| type       | restriction of xs:string   |
| properties | isRef 0<br>content simple  |

element

**EETReportType1.1.2/PrincipalAdverseIndicators/ClimateAndEnvironmentRelatedIndicators/EnergyConsumptionIntensityPerHighImpactClimateSector/NACE\_Values/Values**

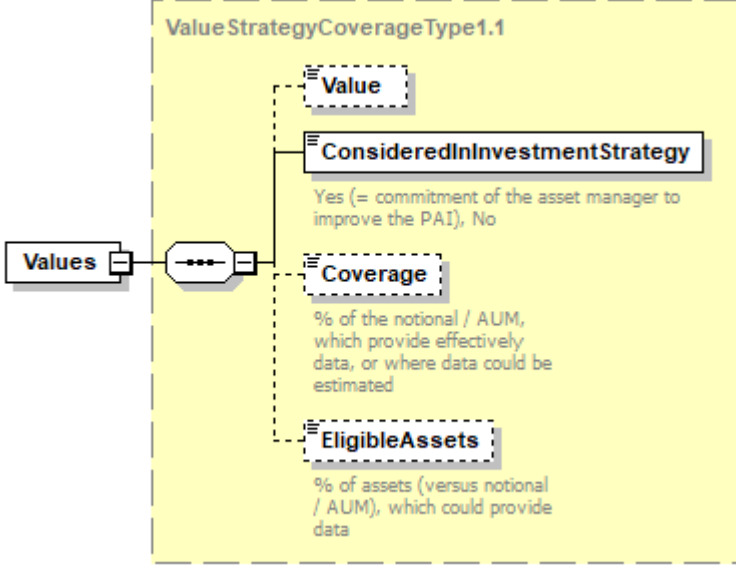
|            |  |
|------------|--|
| diagram    |  <p>The diagram shows a box labeled 'Values' connected to a container (represented by a rounded rectangle with a dashed line). This container is titled 'Value Strategy Coverage Type 1.1' and contains four sub-elements: 'Value', 'ConsideredInInvestmentStrategy', 'Coverage', and 'EligibleAssets'.<br/>- 'Value' is connected to 'ConsideredInInvestmentStrategy'.<br/>- 'ConsideredInInvestmentStrategy' has the text: 'Yes (= commitment of the asset manager to improve the PAI), No'.<br/>- 'Coverage' has the text: '% of the notional / AUM, which provide effectively data, or where data could be estimated'.<br/>- 'EligibleAssets' has the text: '% of assets (versus notional / AUM), which could provide data'.</p> |
| type       | <a href="#">ValueStrategyCoverageType1.1</a>   |
| properties | isRef 0<br>content complex   |
| children   | <a href="#">Value</a> <a href="#">ConsideredInInvestmentStrategy</a> <a href="#">Coverage</a> <a href="#">EligibleAssets</a>   |

element  
**EETReportType1.1.2/PrincipalAdverseIndicators/ClimateAndEnvironmentRelatedIndicators/ActivitiesNegativelyAffectingBiodiversitySensitiveAreas**

|                   |   |
|-------------------|---|
| <p>diagram</p>    | <p>The diagram illustrates the structure of the <b>ValueStrategyCoverageType1.1</b> class. It is associated with the class <b>ActivitiesNegativelyAffectingBi...</b> (ID 30860 - 30890). The <b>ValueStrategyCoverageType1.1</b> class contains the following attributes:</p> <ul style="list-style-type: none"> <li><b>Value</b>: A simple attribute.</li> <li><b>ConsideredInInvestmentStrategy</b>: A boolean attribute with the description: "Yes (= commitment of the asset manager to improve the PAI), No".</li> <li><b>Coverage</b>: A percentage attribute with the description: "% of the notional / AUM, which provide effectively data, or where data could be estimated".</li> <li><b>EligibleAssets</b>: A percentage attribute with the description: "% of assets (versus notional / AUM), which could provide data".</li> </ul> |
| <p>type</p>       | <p><a href="#">ValueStrategyCoverageType1.1</a></p>   |
| <p>properties</p> | <p>isRef 0<br/> minOcc 0<br/> maxOcc 1<br/> content complex</p>   |
| <p>children</p>   | <p><a href="#">Value</a> <a href="#">ConsideredInInvestmentStrategy</a> <a href="#">Coverage</a> <a href="#">EligibleAssets</a></p>   |
| <p>annotation</p> | <p>documentation<br/> 30860 - 30890</p>   |

element

### EETReportType1.1.2/PrincipalAdverseIndicators/ClimateAndEnvironmentRelatedIndicators/WaterEmissions

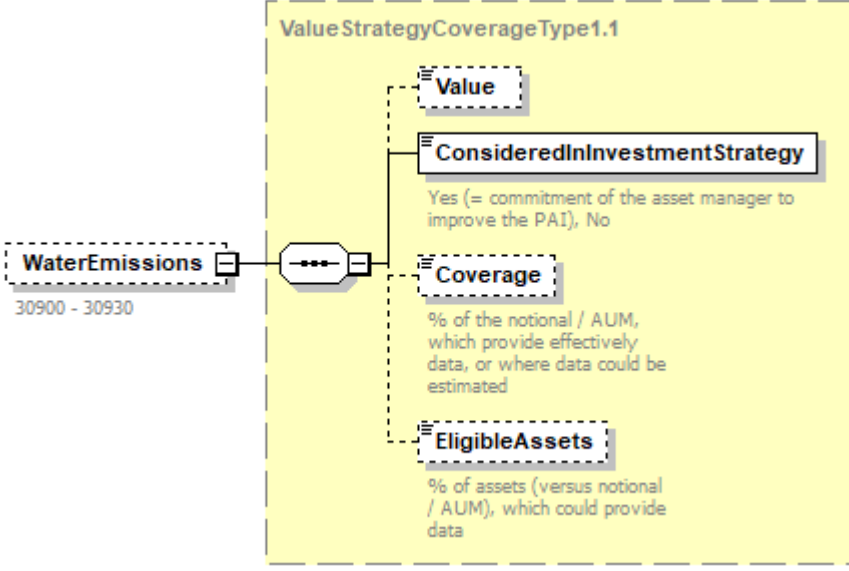
|            |  |
|------------|--|
| diagram    |    |
| type       | <a href="#">ValueStrategyCoverageType1.1</a>   |
| properties | isRef 0<br>minOcc 0<br>maxOcc 1<br>content complex   |
| children   | <a href="#">Value</a> <a href="#">ConsideredInInvestmentStrategy</a> <a href="#">Coverage</a> <a href="#">EligibleAssets</a> |
| annotation | documentation<br>30900 - 30930   |

element

### EETReportType1.1.2/PrincipalAdverseIndicators/ClimateAndEnvironmentRelatedIndicators/Hazardous Waste

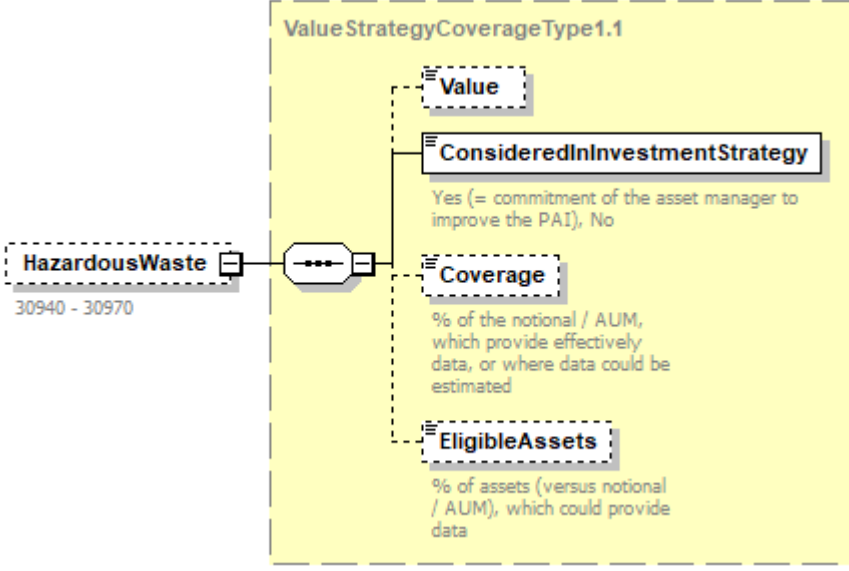
|         |  |
|---------|--|
| diagram |  |
|---------|--|

|            |  |
|------------|--|
| type       | <a href="#">ValueStrategyCoverageType1.1</a>                                 |
| properties | isRef 0<br>minOcc 0<br>maxOcc 1<br>content complex                           |
| children   | <a href="#">Value ConsideredInInvestmentStrategy Coverage EligibleAssets</a> |
| annotation | documentation<br>30940 - 30970   |

element **EETReportType1.1.2/PrincipalAdverseIndicators/SocialAndEmployeeMatters**

|            |   |
|------------|---|
| diagram    | <p>The diagram illustrates the structure of the <b>SocialAndEmployeeMatters</b> element (ID 30980 - 31160). It is represented as a container box with a dashed border and a plus sign icon. Inside this container, five sub-elements are listed, each in its own dashed box with a plus sign icon:</p> <ul style="list-style-type: none"> <li><b>CompaniesInvolvedInViolation...</b> (ID 30980 - 31010): Companies_Involved_In_Violation_Of_UN_Global_Compact_Principles_And_OECD_Guidelines_For_Multinational_Enterprises</li> <li><b>CompaniesWithoutMonitoring...</b> (ID 31020 - 31045): Share_Of_Companies_Without_Policies_To_Monitor_Compliance_With_UNGCP_And_OECD_Guidelines_For_Multinational_Enterprises</li> <li><b>UnadjustedGenderPayGap</b> (ID 31050 - 31080): Unadjusted_Gender_Pay_Gap</li> <li><b>BoardGenderDiversity</b> (ID 31090 - 31120): Board_Gender_Diversity</li> <li><b>InvestmentsInvolvedInControv...</b> (ID 31130 - 31160): Investments_Involved_In_Controversial_Weapons</li> </ul> |
| properties | isRef 0<br>minOcc 0<br>maxOcc 1<br>content complex  |
| children   | <a href="#">CompaniesInvolvedInViolation UN GCP Or OECD ME Guidelines</a><br><a href="#">CompaniesWithoutMonitoringCompliance UN GCP Or OECD ME Guidelines</a><br><a href="#">UnadjustedGenderPayGap</a><br><a href="#">BoardGenderDiversity</a><br><a href="#">InvestmentsInvolvedInControversialWeapons</a>   |
| annotation | documentation<br>30980 - 31160  |



element

**EETReportType1.1.2/PrincipalAdverseIndicators/SocialAndEmployeeMatters/CompaniesInvolvedInViolation\_UN\_GCP\_Or\_OECD\_ME\_Guidelines**

|                   |  |
|-------------------|--|
| <p>diagram</p>    |  |
| <p>type</p>       | <p><a href="#">PercentageStrategyCoverageType1.1</a></p>   |
| <p>properties</p> | <p>isRef 0<br/>minOcc 0<br/>maxOcc 1<br/>content complex</p>   |
| <p>children</p>   | <p><a href="#">Value</a> <a href="#">ConsideredInInvestmentStrategy</a> <a href="#">Coverage</a> <a href="#">EligibleAssets</a></p>                        |
| <p>annotation</p> | <p>documentation<br/>Companies_Involved_In_Violation_Of_UN_Global_Compact_Principles_And_OECD_Guidelines_For_Multinational_Enterprises (30980 - 31010)</p> |

element

**EETReportType1.1.2/PrincipalAdverseIndicators/SocialAndEmployeeMatters/CompaniesWithoutMonitoringCompliance\_UN\_GCP\_Or\_OECD\_ME\_Guidelines**

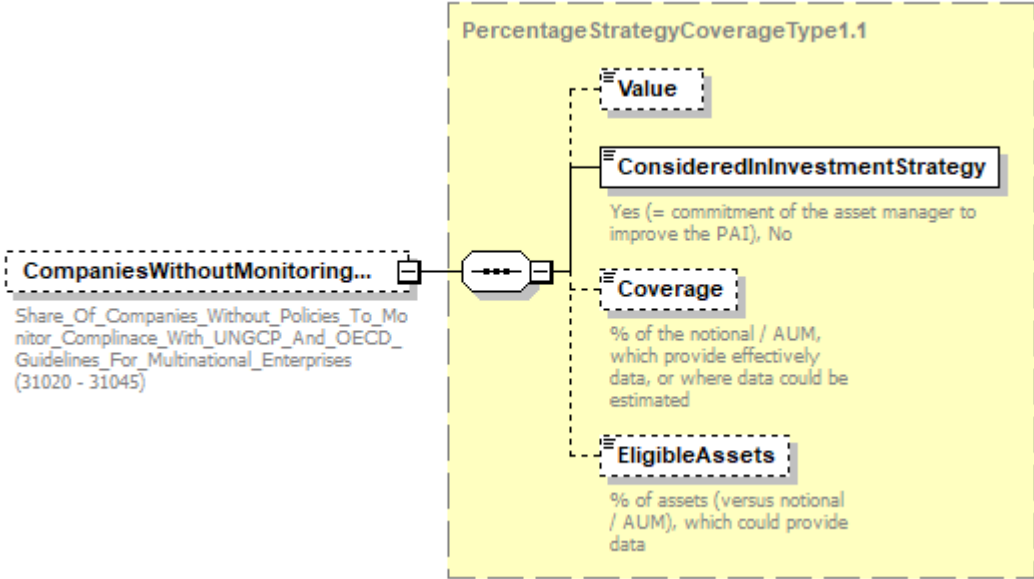
|                   |   |
|-------------------|---|
| <p>diagram</p>    |   |
| <p>type</p>       | <p><a href="#">PercentageStrategyCoverageType1.1</a></p>  |
| <p>properties</p> | <p>isRef 0<br/>minOcc 0<br/>maxOcc 1<br/>content complex</p>  |
| <p>children</p>   | <p><a href="#">Value</a> <a href="#">ConsideredInInvestmentStrategy</a> <a href="#">Coverage</a> <a href="#">EligibleAssets</a></p>                             |
| <p>annotation</p> | <p>documentation<br/>Share_Of_Companies_Without_Policies_To_Monitor_Compliance_With_UNGCP_And_OECD_Guidelines_For_Multinational_Enterprises (31020 - 31045)</p> |

element

### EETReportType1.1.2/PrincipalAdverseIndicators/SocialAndEmployeeMatters/UnadjustedGenderPayGap

|            |  |
|------------|--|
| diagram    | <p><b>UnadjustedGenderPayGap</b><br/>Unadjusted_Gender_Pay_Gap (31050 - 31080)</p> <p><b>PercentageStrategyCoverageType1.1</b></p> <ul style="list-style-type: none"><li><b>Value</b></li><li><b>ConsideredInInvestmentStrategy</b><br/>Yes (= commitment of the asset manager to improve the PAI), No</li><li><b>Coverage</b><br/>% of the notional / AUM, which provide effectively data, or where data could be estimated</li><li><b>EligibleAssets</b><br/>% of assets (versus notional / AUM), which could provide data</li></ul> |
| type       | <a href="#">PercentageStrategyCoverageType1.1</a>  |
| properties | isRef 0<br>minOcc 0<br>maxOcc 1<br>content complex   |
| children   | <a href="#">Value</a> <a href="#">ConsideredInInvestmentStrategy</a> <a href="#">Coverage</a> <a href="#">EligibleAssets</a>   |
| annotation | documentation<br>Unadjusted_Gender_Pay_Gap (31050 - 31080)   |

element

### EETReportType1.1.2/PrincipalAdverseIndicators/SocialAndEmployeeMatters/BoardGenderDiversity

|         |  |
|---------|--|
| diagram | <p><b>BoardGenderDiversity</b><br/>Board_Gender_Diversity (31090 - 31120)</p> <p><b>ValueStrategyCoverageType1.1</b></p> <ul style="list-style-type: none"><li><b>Value</b></li><li><b>ConsideredInInvestmentStrategy</b><br/>Yes (= commitment of the asset manager to improve the PAI), No</li><li><b>Coverage</b><br/>% of the notional / AUM, which provide effectively data, or where data could be estimated</li><li><b>EligibleAssets</b><br/>% of assets (versus notional / AUM), which could provide data</li></ul> |
|---------|--|

|            |  |
|------------|--|
| type       | <a href="#">ValueStrategyCoverageType1.1</a>   |
| properties | isRef 0<br>minOcc 0<br>maxOcc 1<br>content complex   |
| children   | <a href="#">Value</a> <a href="#">ConsideredInInvestmentStrategy</a> <a href="#">Coverage</a> <a href="#">EligibleAssets</a> |
| annotation | documentation<br>Board_Gender_Diversity (31090 - 31120)  |

element

**EETReportType1.1.2/PrincipalAdverseIndicators/SocialAndEmployeeMatters/InvestmentsInvolvedInControversialWeapons**

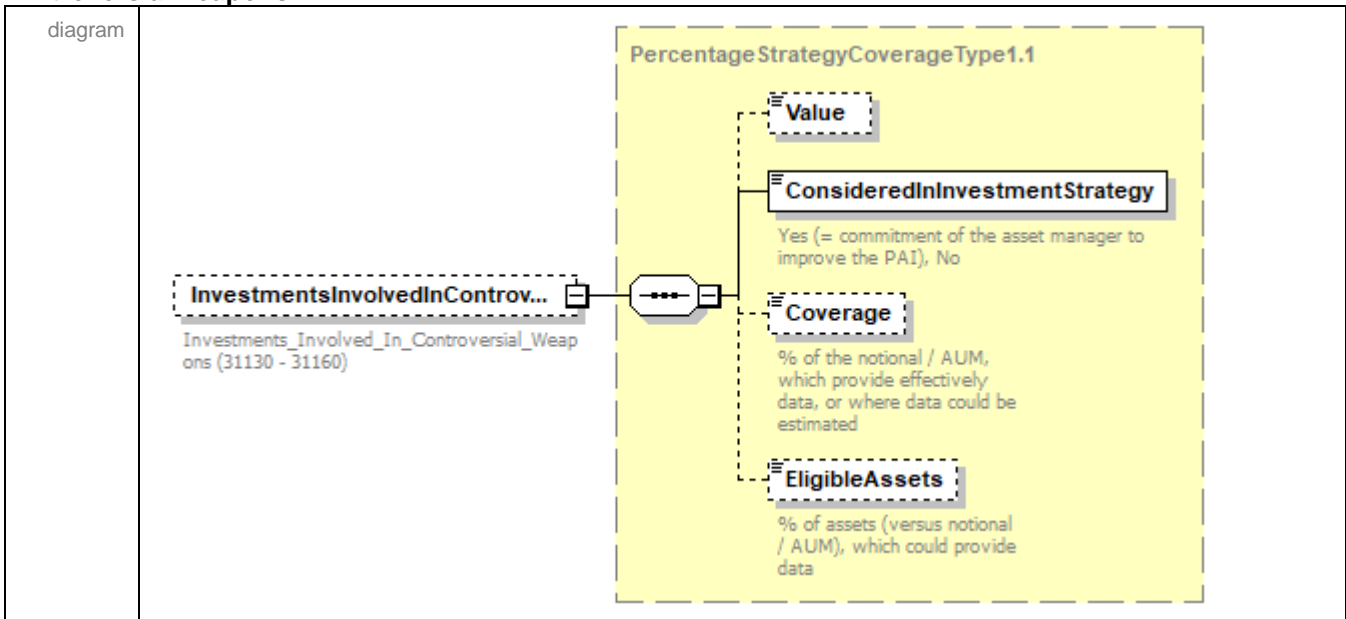

|            |  |
|------------|--|
| type       | <a href="#">PercentageStrategyCoverageType1.1</a>  |
| properties | isRef 0<br>minOcc 0<br>maxOcc 1<br>content complex   |
| children   | <a href="#">Value</a> <a href="#">ConsideredInInvestmentStrategy</a> <a href="#">Coverage</a> <a href="#">EligibleAssets</a> |
| annotation | documentation<br>Investments_Involved_In_Controversial_Weapons (31130 - 31160)   |

element **EETReportType1.1.2/PrincipalAdverseIndicators/SovereignAndSupranationalInvestments**

|            |   |
|------------|---|
| diagram    |   |
| properties | <p>isRef 0<br/> minOcc 0<br/> maxOcc 1<br/> content complex</p>   |
| children   | <p><a href="#">GreenhouseGasIntensity</a> <a href="#">NumberOfCountriesSubjectToSocialViolations</a><br/> <a href="#">PercentOfCountriesSubjectToSocialViolations</a></p> |
| annotation | <p>documentation<br/> 31170 - 31280</p>   |

element **EETReportType1.1.2/PrincipalAdverseIndicators/SovereignAndSupranationalInvestments/Greenhouse GasIntensity**

|            |   |
|------------|---|
| diagram    |   |
| type       | <p><a href="#">ValueStrategyCoverageType1.1</a></p>   |
| properties | <p>isRef 0<br/> minOcc 0<br/> maxOcc 1<br/> content complex</p>   |
| children   | <p><a href="#">Value</a> <a href="#">ConsideredInInvestmentStrategy</a> <a href="#">Coverage</a> <a href="#">EligibleAssets</a></p> |
| annotation | <p>documentation<br/> GHG_Intesity (31170 - 31200)</p>  |

element

### EETReportType1.1.2/PrincipalAdverseIndicators/SovereignAndSupranationalInvestments/NumberOfCountriesSubjectToSocialViolations

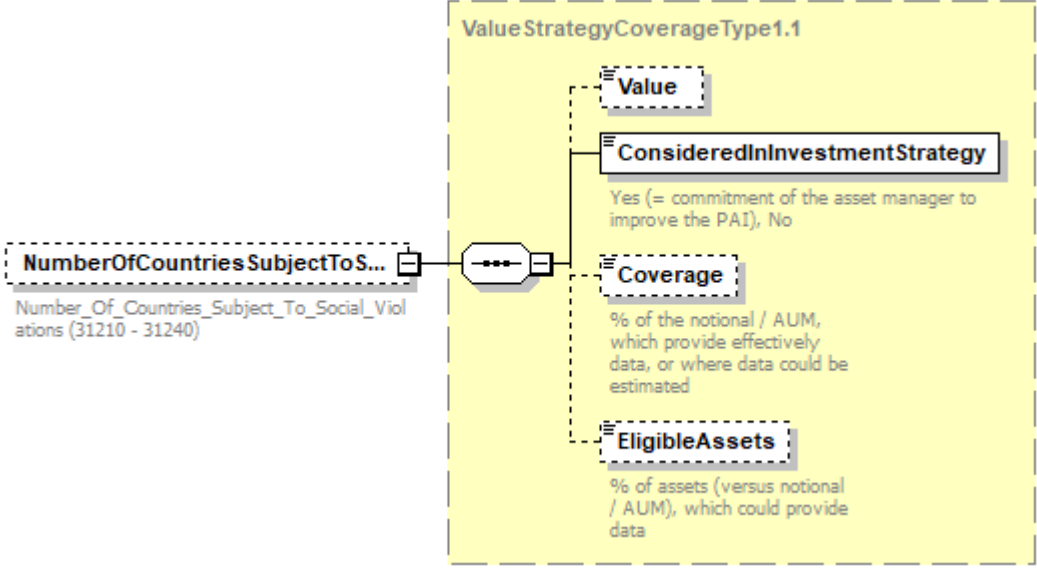
|            |  |
|------------|--|
| diagram    |  <p>The diagram shows a dashed box labeled "ValueStrategyCoverageType1.1" containing four sub-elements: "Value", "ConsideredInInvestmentStrategy", "Coverage", and "EligibleAssets". To the left, a dashed box labeled "NumberOfCountriesSubjectToS..." is connected to the main structure by a line with a circle containing three dots. Below this box is the text "Number_Of_Countries_Subject_To_Social_Violations (31210 - 31240)".</p> |
| type       | <a href="#">ValueStrategyCoverageType1.1</a>   |
| properties | isRef 0<br>minOcc 0<br>maxOcc 1<br>content complex   |
| children   | <a href="#">Value</a> <a href="#">ConsideredInInvestmentStrategy</a> <a href="#">Coverage</a> <a href="#">EligibleAssets</a>   |
| annotation | documentation<br>Number_Of_Countries_Subject_To_Social_Violations (31210 - 31240)  |

element

### EETReportType1.1.2/PrincipalAdverseIndicators/SovereignAndSupranationalInvestments/PercentOfCountriesSubjectToSocialViolations

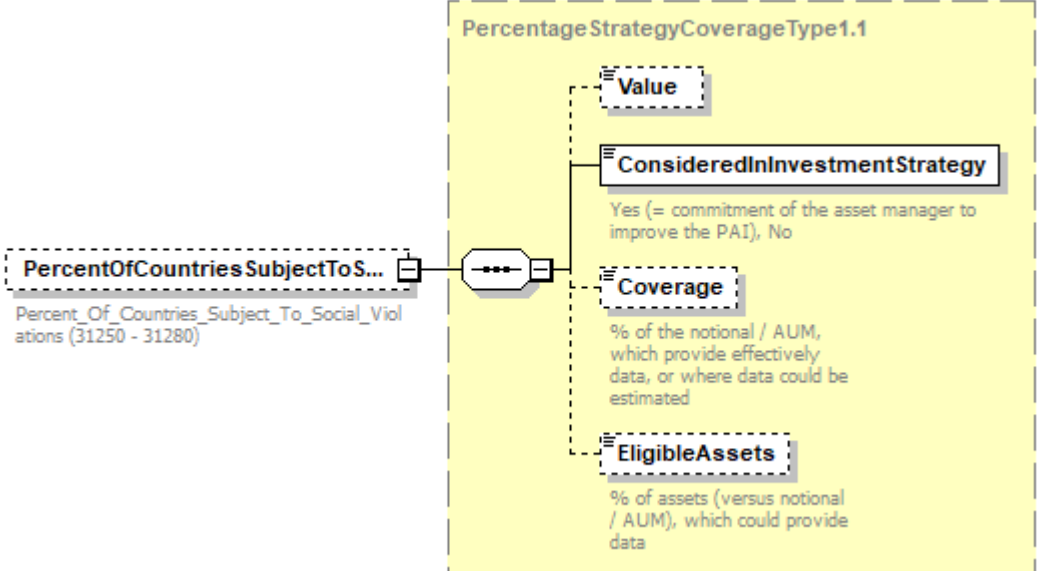
|         |   |
|---------|---|
| diagram |  <p>The diagram shows a dashed box labeled "PercentageStrategyCoverageType1.1" containing four sub-elements: "Value", "ConsideredInInvestmentStrategy", "Coverage", and "EligibleAssets". To the left, a dashed box labeled "PercentOfCountriesSubjectToS..." is connected to the main structure by a line with a circle containing three dots. Below this box is the text "Percent_Of_Countries_Subject_To_Social_Violations (31250 - 31280)".</p> |
|---------|---|

|            |  |
|------------|--|
| type       | <a href="#">PercentageStrategyCoverageType1.1</a>                                  |
| properties | isRef 0<br>minOcc 0<br>maxOcc 1<br>content complex                                 |
| children   | <a href="#">Value ConsideredInInvestmentStrategy Coverage EligibleAssets</a>       |
| annotation | documentation<br>Percent_Of_Countries_Subject_To_Social_Violations (31250 - 31280) |

element **EETReportType1.1.2/PrincipalAdverseIndicators/RealEstateInvestments**

|            |   |
|------------|---|
| diagram    | <p>The diagram shows a central element 'RealEstateInvestments' (31290 - 31360) connected to two child elements: 'FossilFuelsExtractionStorageTransportManufacture' (31290 - 31320) and 'EnergyInefficientRealEstateAssets' (31330 - 31360).</p> |
| properties | isRef 0<br>minOcc 0<br>maxOcc 1<br>content complex  |
| children   | <a href="#">FossilFuelsExtractionStorageTransportManufacture</a> <a href="#">EnergyInefficientRealEstateAssets</a>  |
| annotation | documentation<br>31290 - 31360  |

element **EETReportType1.1.2/PrincipalAdverseIndicators/RealEstateInvestments/FossilFuelsExtractionStorageTransportManufacture**

|            |  |
|------------|--|
| diagram    | <p>The diagram shows 'FossilFuelsExtractionStorageTransportManufacture' (31290 - 31320) connected to 'PercentageStrategyCoverageType1.1'. This coverage type includes four sub-elements: 'Value', 'ConsideredInInvestmentStrategy' (Yes (= commitment of the asset manager to improve the PAI), No), 'Coverage' (% of the notional / AUM, which provide effectively data, or where data could be estimated), and 'EligibleAssets' (% of assets (versus notional / AUM), which could provide data).</p> |
| type       | <a href="#">PercentageStrategyCoverageType1.1</a>  |
| properties | isRef 0<br>minOcc 0<br>maxOcc 1  |

|            |  |
|------------|--|
|            | content complex  |
| children   | <a href="#">Value</a> <a href="#">ConsideredInInvestmentStrategy</a> <a href="#">Coverage</a> <a href="#">EligibleAssets</a> |
| annotation | documentation<br>Exposure_To_Fossil_Fuels_Extraction_Storage_Transport_Manufacture (31290 - 31320)                           |

element

**EETReportType1.1.2/PrincipalAdverseIndicators/RealEstateInvestments/EnergyInefficientRealEstateAssets**

|            |  |
|------------|--|
| diagram    | <p>The diagram illustrates the composition of the <b>EnergyInefficientRealEstateAssets</b> class. It is composed of the <b>PercentageStrategyCoverageType1.1</b> class. The <b>PercentageStrategyCoverageType1.1</b> class is further composed of four elements: <b>Value</b>, <b>ConsideredInInvestmentStrategy</b> (Yes (= commitment of the asset manager to improve the PAI), No), <b>Coverage</b> (% of the notional / AUM, which provide effectively data, or where data could be estimated), and <b>EligibleAssets</b> (% of assets (versus notional / AUM), which could provide data).</p> |
| type       | <a href="#">PercentageStrategyCoverageType1.1</a>  |
| properties | isRef 0<br>minOcc 0<br>maxOcc 1<br>content complex   |
| children   | <a href="#">Value</a> <a href="#">ConsideredInInvestmentStrategy</a> <a href="#">Coverage</a> <a href="#">EligibleAssets</a>   |
| annotation | documentation<br>Exposure_To_Energy_infficient_Real_Estate_Assets (31330 - 31360)  |



element

**EETReportType1.1.2/PrincipalAdverseIndicators/MoreClimateAndEnvironmentRelatedIndicators**

|                   |   |
|-------------------|---|
| <p>diagram</p>    |   |
| <p>properties</p> | <p>isRef 0<br/>minOcc 0<br/>maxOcc 1<br/>content complex</p>  |
| <p>children</p>   | <p><a href="#">EnergyEfficiency</a> <a href="#">EnergyConsumptionNonRenewable</a> <a href="#">WaterWasteAndLandProtection</a> <a href="#">GreenSecurities</a> <a href="#">RealEstateInvestments</a></p> |
| <p>annotation</p> | <p>documentation<br/>31370 - 32430</p>  |

element

**EETReportType1.1.2/PrincipalAdverseIndicators/MoreClimateAndEnvironmentRelatedIndicators/EnergyEfficiency**

|                   |   |
|-------------------|---|
| <p>diagram</p>    |   |
| <p>properties</p> | <p>isRef 0<br/>minOcc 0<br/>maxOcc 1<br/>content complex</p>  |
| <p>children</p>   | <p><a href="#">EmissionsOfInorganicPollutants</a> <a href="#">EmissionsOfAirPollutants</a> <a href="#">EmissionsOfOzoneDepletionSubstances</a> <a href="#">CompaniesWithoutCarbonEmissionReductionInitiatives</a></p> |
| <p>annotation</p> | <p>documentation<br/>31370 - 31510</p>  |

element

**EETReportType1.1.2/PrincipalAdverseIndicators/MoreClimateAndEnvironmentRelatedIndicators/EnergyEfficiency/EmissionsOfInorganicPollutants**

|                   |   |
|-------------------|---|
| <p>diagram</p>    | <pre> classDiagram     class EmissionsOfInorganicPollutants {         Emissions_Of_Inorganic_Pollutants (31370 - 31400)     }     class ValueStrategyCoverageType1_1 {         Value         ConsideredInInvestmentStrategy         Coverage         EligibleAssets     }     EmissionsOfInorganicPollutants -- ValueStrategyCoverageType1_1     </pre> |
| <p>type</p>       | <p><a href="#">ValueStrategyCoverageType1.1</a></p>   |
| <p>properties</p> | <p>isRef 0<br/>minOcc 0<br/>maxOcc 1<br/>content complex</p>  |
| <p>children</p>   | <p><a href="#">Value</a> <a href="#">ConsideredInInvestmentStrategy</a> <a href="#">Coverage</a> <a href="#">EligibleAssets</a></p>   |
| <p>annotation</p> | <p>documentation<br/>Emissions_Of_Inorganic_Pollutants (31370 - 31400)</p>  |

element

**EETReportType1.1.2/PrincipalAdverseIndicators/MoreClimateAndEnvironmentRelatedIndicators/EnergyEfficiency/EmissionsOfAirPollutants**

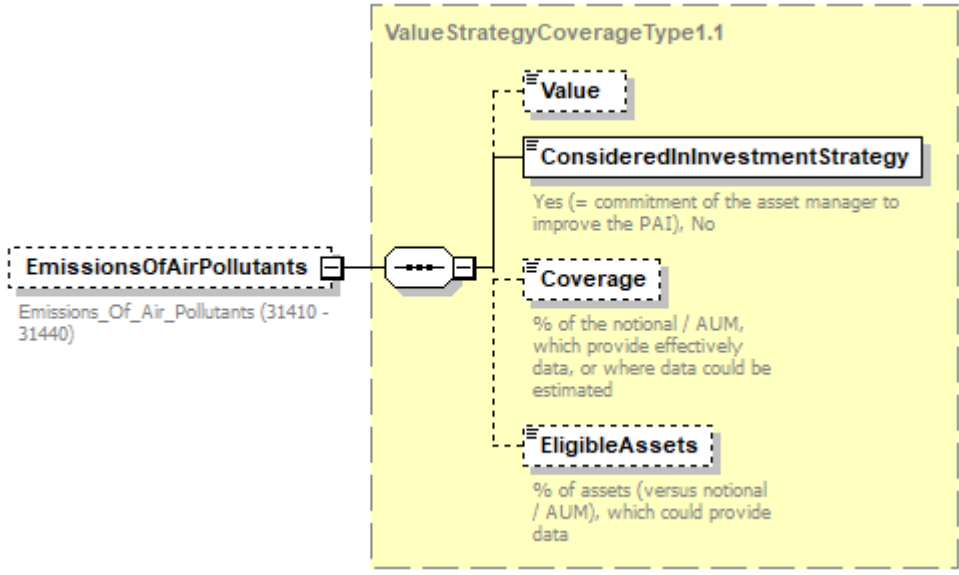
|            |  |
|------------|--|
| diagram    |    |
| type       | <a href="#">ValueStrategyCoverageType1.1</a>   |
| properties | isRef 0<br>minOcc 0<br>maxOcc 1<br>content complex   |
| children   | <a href="#">Value</a> <a href="#">ConsideredInInvestmentStrategy</a> <a href="#">Coverage</a> <a href="#">EligibleAssets</a> |
| annotation | documentation<br>Emissions_Of_Air_Pollutants (31410 - 31440)   |

element

**EETReportType1.1.2/PrincipalAdverseIndicators/MoreClimateAndEnvironmentRelatedIndicators/EnergyEfficiency/EmissionsOfOzoneDepletionSubstances**

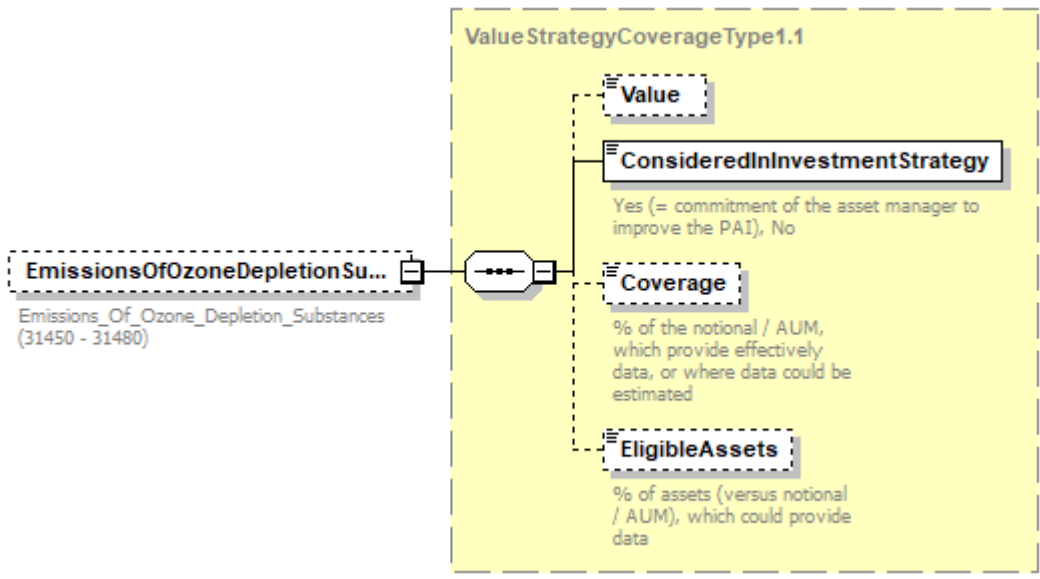
|         |  |
|---------|--|
| diagram |  |
|---------|--|

|            |  |
|------------|--|
| type       | <a href="#">ValueStrategyCoverageType1.1</a>   |
| properties | isRef 0<br>minOcc 0<br>maxOcc 1<br>content complex   |
| children   | <a href="#">Value</a> <a href="#">ConsideredInInvestmentStrategy</a> <a href="#">Coverage</a> <a href="#">EligibleAssets</a> |
| annotation | documentation<br>Emissions_Of_Ozone_Depletion_Substances (31450 - 31480)   |

element

**EETReportType1.1.2/PrincipalAdverseIndicators/MoreClimateAndEnvironmentRelatedIndicators/EnergyEfficiency/CompaniesWithoutCarbonEmissionReductionInitiatives**

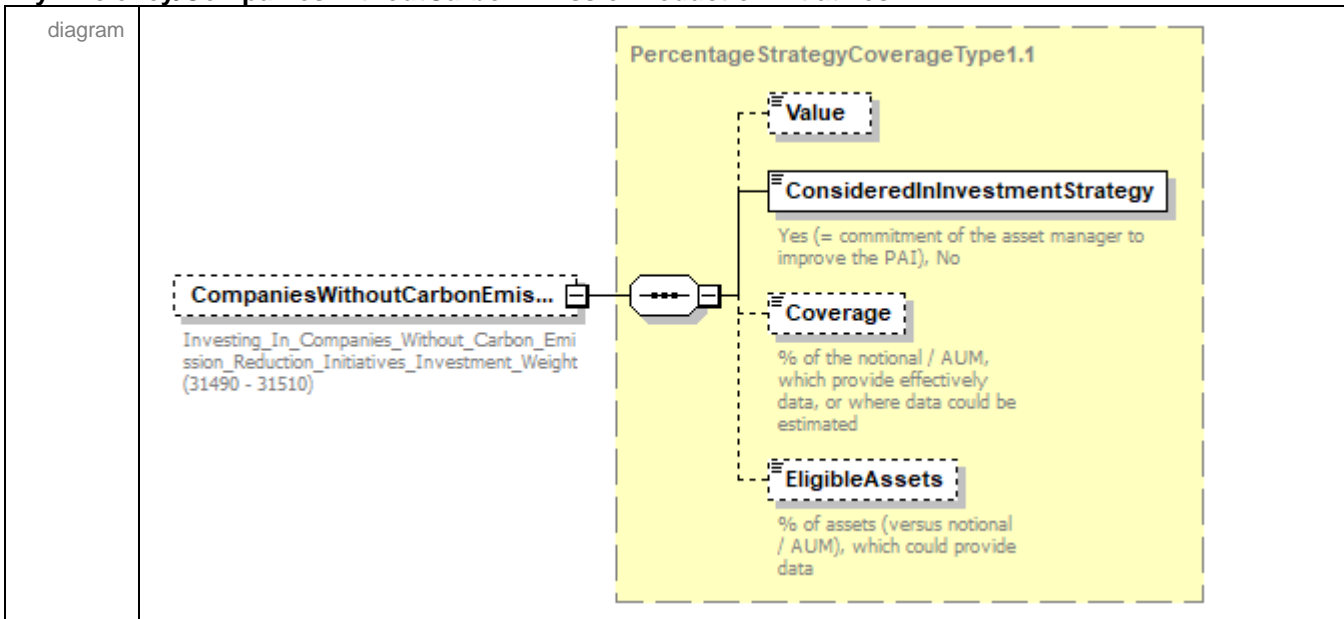

|            |  |
|------------|--|
| type       | <a href="#">PercentageStrategyCoverageType1.1</a>  |
| properties | isRef 0<br>minOcc 0<br>maxOcc 1<br>content complex   |
| children   | <a href="#">Value</a> <a href="#">ConsideredInInvestmentStrategy</a> <a href="#">Coverage</a> <a href="#">EligibleAssets</a> |
| annotation | documentation<br>Investing_In_Companies_Without_Carbon_Emission_Reduction_Initiatives_Investment_Weight (31490 - 31510)      |

element

### EETReportType1.1.2/PrincipalAdverseIndicators/MoreClimateAndEnvironmentRelatedIndicators/EnergyConsumptionNonRenewable

|            |   |
|------------|---|
| diagram    | <p><b>EnergyConsumptionNonRenewable</b><br/>31520 - 31630</p> <p><b>Oil</b><br/>Breakdown_Of_Energy_Consumption_By_Type_Of_Non-renewable_Sources_Of_Energy_Oil (31520 - 31550)</p> <p><b>NaturalGas</b><br/>Breakdown_Of_Energy_Consumption_By_Type_Of_Non-renewable_Sources_Of_Energy_Natural_Gas (31560 - 31590)</p> <p><b>Coal</b><br/>Breakdown_Of_Energy_Consumption_By_Type_Of_Non-renewable_Sources_Of_Energy_Coal (31600 - 31630)</p> |
| properties | isRef 0<br>minOcc 0<br>maxOcc 1<br>content complex  |
| children   | <a href="#">Oil</a> <a href="#">NaturalGas</a> <a href="#">Coal</a>   |
| annotation | documentation<br>31520 - 31630  |

element

### EETReportType1.1.2/PrincipalAdverseIndicators/MoreClimateAndEnvironmentRelatedIndicators/EnergyConsumptionNonRenewable/Oil

|            |  |
|------------|--|
| diagram    | <p><b>Oil</b><br/>Breakdown_Of_Energy_Consumption_By_Type_Of_Non-renewable_Sources_Of_Energy_Oil (31520 - 31550)</p> <p><b>PercentageStrategyCoverageType1.1</b></p> <ul style="list-style-type: none"><li><b>Value</b></li><li><b>ConsideredInInvestmentStrategy</b><br/>Yes (= commitment of the asset manager to improve the PAI), No</li><li><b>Coverage</b><br/>% of the notional / AUM, which provide effectively data, or where data could be estimated</li><li><b>EligibleAssets</b><br/>% of assets (versus notional / AUM), which could provide data</li></ul> |
| type       | <a href="#">PercentageStrategyCoverageType1.1</a>  |
| properties | isRef 0<br>minOcc 0  |

|            |  |
|------------|--|
|            | maxOcc 1<br>content complex  |
| children   | <a href="#">Value</a> <a href="#">ConsideredInInvestmentStrategy</a> <a href="#">Coverage</a> <a href="#">EligibleAssets</a> |
| annotation | documentation<br>Breakdown_Of_Energy_Consumption_By_Type_Of_Non-renewable_Sources_Of_Energy_Oil (31520 - 31550)              |

element

**EETReportType1.1.2/PrincipalAdverseIndicators/MoreClimateAndEnvironmentRelatedIndicators/EnergyConsumptionNonRenewable/NaturalGas**

|            |  |
|------------|--|
| diagram    |  |
| type       | <a href="#">PercentageStrategyCoverageType1.1</a>  |
| properties | isRef 0<br>minOcc 0<br>maxOcc 1<br>content complex   |
| children   | <a href="#">Value</a> <a href="#">ConsideredInInvestmentStrategy</a> <a href="#">Coverage</a> <a href="#">EligibleAssets</a> |
| annotation | documentation<br>Breakdown_Of_Energy_Consumption_By_Type_Of_Non-renewable_Sources_Of_Energy_Natural_Gas (31560 - 31590)      |

element

**EETReportType1.1.2/PrincipalAdverseIndicators/MoreClimateAndEnvironmentRelatedIndicators/EnergyConsumptionNonRenewable/Coal**

|                   |   |
|-------------------|---|
| <p>diagram</p>    |   |
| <p>type</p>       | <p><a href="#">PercentageStrategyCoverageType1.1</a></p>  |
| <p>properties</p> | <p>isRef 0<br/>minOcc 0<br/>maxOcc 1<br/>content complex</p>  |
| <p>children</p>   | <p><a href="#">Value</a> <a href="#">ConsideredInInvestmentStrategy</a> <a href="#">Coverage</a> <a href="#">EligibleAssets</a></p> |
| <p>annotation</p> | <p>documentation<br/>Breakdown_Of_Energy_Consumption_By_Type_Of_Non-renewable_Sources_Of_Energy_Coal (31600 - 31630)</p>            |

element

**EETReportType1.1.2/PrincipalAdverseIndicators/MoreClimateAndEnvironmentRelatedIndicators/Water  
WasteAndLandProtection**



diagram

**WaterWasteAndLandProtection**

31640 - 31990

**WaterUsageAndRecyclingAmo...**

Water\_Usage\_And\_Recycling\_Average\_Amount (31640 - 31670)

**WaterUsageAndRecyclingPerce...**

Water\_Usage\_And\_Recycling\_Average\_Percentage (31640 - 31670)

**CompaniesWithoutWaterMana...**

Investing\_In\_Companies\_Without\_Water\_Management\_Policies\_Weight (31680 - 31710)

**AreasOfHighWaterStress**

Exposure\_To\_Areas\_Of\_High\_Water\_Stress (31720 - 31750)

**CompaniesProducingChemicals**

Exposure\_To\_Companies\_Producing\_Chemicals (31760 - 31790)

**CompaniesCausingLandDegra...**

Exposure\_To\_Companies\_Causing\_Land\_Degradation\_Desertification\_Or\_Soil\_Sealing (31800 - 31830)

**CompaniesWithoutSustainable...**

Exposure\_To\_Companies\_Without\_Sustainable\_Land\_Or\_Agriculture\_Practices\_Policies (31840 - 31870)

**CompaniesWithoutSustainable...**

Share\_Of\_Investments\_In\_Companies\_Without\_Sustainable\_Oceans\_Or\_Seas\_Practices (31871 - 31874)

**NonRecycledWasteRatio**

Non\_Recycled\_Waste\_Ratio (31875 - 31878)

**CompaniesWhoseOperationsA...**

Share\_Of\_Investments\_In\_Investee\_Companies\_Whose\_Operations\_Affect\_Threatened\_Species (31880 - 31910)

**CompaniesWithoutBiodiversity...**

Share\_Of\_Investments\_In\_Investee\_Companies\_Without\_A\_Biodiversity\_Protection\_Policy\_Covering\_Operational\_Sites\_Owned\_Leased\_Managed\_In\_Or\_Adjacent\_To\_A\_Protected\_Area\_Or\_An\_Area\_Of\_High\_Biodiversity\_Value\_Outside\_Protected\_Areas (31920 - 31950)

**CompaniesWithoutDeforestat...**

Share\_Of\_Investee\_Companies\_Without\_Deforestation\_Policy (31960 - 31990)

properties

isRef 0  
minOcc 0

|            |  |
|------------|--|
|            | maxOcc 1<br>content complex  |
| children   | <a href="#">WaterUsageAndRecyclingAmount</a> <a href="#">WaterUsageAndRecyclingPercentage</a> <a href="#">CompaniesWithoutWaterManagement</a> <a href="#">AreasOfHighWaterStress</a> <a href="#">CompaniesProducingChemicals</a> <a href="#">CompaniesCausingLandDegradationDesertificationSoilSealing</a> <a href="#">CompaniesWithoutSustainableLandOrAgriculturePractices</a> <a href="#">CompaniesWithoutSustainableOceansSeasPractices</a> <a href="#">NonRecycledWasteRatio</a> <a href="#">CompaniesWhoseOperationsAffectThreatenedSpecies</a> <a href="#">CompaniesWithoutBiodiversityProtection</a> <a href="#">CompaniesWithoutDeforestationPolicy</a> |
| annotation | documentation<br>31640 - 31990   |

element

**EETReportType1.1.2/PrincipalAdverseIndicators/MoreClimateAndEnvironmentRelatedIndicators/Water WasteAndLandProtection/WaterUsageAndRecyclingAmount**

|            |  |
|------------|--|
| diagram    |  |
| type       | <a href="#">ValueStrategyCoverageType1.1</a>   |
| properties | isRef 0<br>minOcc 0<br>maxOcc 1<br>content complex   |
| children   | <a href="#">Value</a> <a href="#">ConsideredInInvestmentStrategy</a> <a href="#">Coverage</a> <a href="#">EligibleAssets</a> |
| annotation | documentation<br>Water_Usage_And_Recycling_Average_Amount (31640 - 31670)  |

element

**EETReportType1.1.2/PrincipalAdverseIndicators/MoreClimateAndEnvironmentRelatedIndicators/WaterWasteAndLandProtection/WaterUsageAndRecyclingPercentage**

|            |   |
|------------|---|
| diagram    | <p><b>PercentageStrategyCoverageType1.1</b></p> <ul style="list-style-type: none"><li><b>Value</b></li><li><b>ConsideredInInvestmentStrategy</b><br/>Yes (= commitment of the asset manager to improve the PAI), No</li><li><b>Coverage</b><br/>% of the notional / AUM, which provide effectively data, or where data could be estimated</li><li><b>EligibleAssets</b><br/>% of assets (versus notional / AUM), which could provide data</li></ul> <p><b>WaterUsageAndRecyclingPerce...</b><br/>Water_Usage_And_Recycling_Average_Percentage (31640 - 31670)</p> |
| type       | <a href="#">PercentageStrategyCoverageType1.1</a>   |
| properties | isRef 0<br>minOcc 0<br>maxOcc 1<br>content complex  |
| children   | <a href="#">Value</a> <a href="#">ConsideredInInvestmentStrategy</a> <a href="#">Coverage</a> <a href="#">EligibleAssets</a>  |
| annotation | documentation<br>Water_Usage_And_Recycling_Average_Percentage (31640 - 31670)   |

element

**EETReportType1.1.2/PrincipalAdverseIndicators/MoreClimateAndEnvironmentRelatedIndicators/Water WasteAndLandProtection/CompaniesWithoutWaterManagement**

|                   |   |
|-------------------|---|
| <p>diagram</p>    |   |
| <p>type</p>       | <p><a href="#">PercentageStrategyCoverageType1.1</a></p>  |
| <p>properties</p> | <p>isRef 0<br/>minOcc 0<br/>maxOcc 1<br/>content complex</p>  |
| <p>children</p>   | <p><a href="#">Value</a> <a href="#">ConsideredInInvestmentStrategy</a> <a href="#">Coverage</a> <a href="#">EligibleAssets</a></p> |
| <p>annotation</p> | <p>documentation<br/>Investing_In_Companies_Without_Water_Management_Policies_Weight (31680 - 31710)</p>                            |

element

**EETReportType1.1.2/PrincipalAdverseIndicators/MoreClimateAndEnvironmentRelatedIndicators/WaterWasteAndLandProtection/AreasOfHighWaterStress**

|                   |   |
|-------------------|---|
| <p>diagram</p>    |   |
| <p>type</p>       | <p><a href="#">PercentageStrategyCoverageType1.1</a></p>  |
| <p>properties</p> | <p>isRef 0<br/>minOcc 0<br/>maxOcc 1<br/>content complex</p>  |
| <p>children</p>   | <p><a href="#">Value</a> <a href="#">ConsideredInInvestmentStrategy</a> <a href="#">Coverage</a> <a href="#">EligibleAssets</a></p> |
| <p>annotation</p> | <p>documentation<br/>Exposure_To_Areas_Of_High_Water_Stress (31720 - 31750)</p>   |

element

**EETReportType1.1.2/PrincipalAdverseIndicators/MoreClimateAndEnvironmentRelatedIndicators/WaterWasteAndLandProtection/CompaniesProducingChemicals**

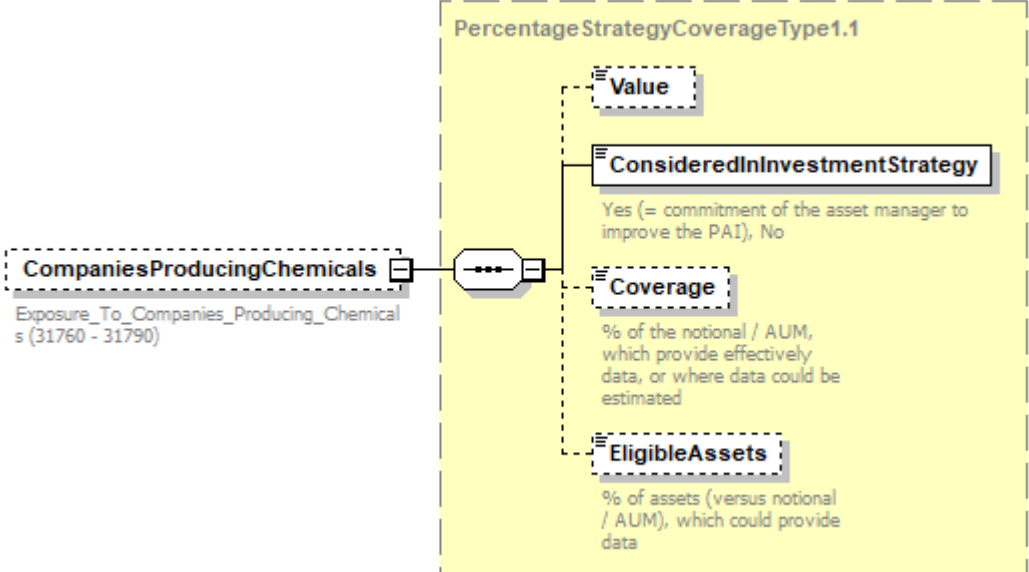
|                   |   |
|-------------------|---|
| <p>diagram</p>    |  <p><b>PercentageStrategyCoverageType1.1</b></p> <ul style="list-style-type: none"> <li><b>Value</b></li> <li><b>ConsideredInInvestmentStrategy</b><br/>Yes (= commitment of the asset manager to improve the PAI), No</li> <li><b>Coverage</b><br/>% of the notional / AUM, which provide effectively data, or where data could be estimated</li> <li><b>EligibleAssets</b><br/>% of assets (versus notional / AUM), which could provide data</li> </ul> <p><b>CompaniesProducingChemicals</b><br/>Exposure_To_Companies_Producing_Chemicals (31760 - 31790)</p> |
| <p>type</p>       | <p><a href="#">PercentageStrategyCoverageType1.1</a></p>  |
| <p>properties</p> | <p>isRef 0<br/>minOcc 0<br/>maxOcc 1<br/>content complex</p>  |
| <p>children</p>   | <p><a href="#">Value</a> <a href="#">ConsideredInInvestmentStrategy</a> <a href="#">Coverage</a> <a href="#">EligibleAssets</a></p>   |
| <p>annotation</p> | <p>documentation<br/>Exposure_To_Companies_Producing_Chemicals (31760 - 31790)</p>  |

element

**EETReportType1.1.2/PrincipalAdverseIndicators/MoreClimateAndEnvironmentRelatedIndicators/WaterWasteAndLandProtection/CompaniesCausingLandDegradationDesertificationSoilSealing**

|                   |   |
|-------------------|---|
| <p>diagram</p>    |   |
| <p>type</p>       | <p><a href="#">PercentageStrategyCoverageType1.1</a></p>  |
| <p>properties</p> | <p>isRef 0<br/>minOcc 0<br/>maxOcc 1<br/>content complex</p>  |
| <p>children</p>   | <p><a href="#">Value</a> <a href="#">ConsideredInInvestmentStrategy</a> <a href="#">Coverage</a> <a href="#">EligibleAssets</a></p> |
| <p>annotation</p> | <p>documentation<br/>Exposure_To_Companies_Causing_Land_Degradation_Desertification_Or_Soil_Sealing (31800 - 31830)</p>             |

element

**EETReportType1.1.2/PrincipalAdverseIndicators/MoreClimateAndEnvironmentRelatedIndicators/WaterWasteAndLandProtection/CompaniesWithoutSustainableLandOrAgriculturePractices**

|                   |   |
|-------------------|---|
| <p>diagram</p>    |   |
| <p>type</p>       | <p><a href="#">PercentageStrategyCoverageType1.1</a></p>  |
| <p>properties</p> | <p>isRef 0<br/>minOcc 0<br/>maxOcc 1<br/>content complex</p>  |
| <p>children</p>   | <p><a href="#">Value</a> <a href="#">ConsideredInInvestmentStrategy</a> <a href="#">Coverage</a> <a href="#">EligibleAssets</a></p> |
| <p>annotation</p> | <p>documentation<br/>Exposure_To_Companies_Without_Sustainable_Land_Or_Agriculture_Practices_Policies (31840 - 31870)</p>           |



element

**EETReportType1.1.2/PrincipalAdverseIndicators/MoreClimateAndEnvironmentRelatedIndicators/Water WasteAndLandProtection/CompaniesWithoutSustainableOceansSeasPractices**

|                   |   |
|-------------------|---|
| <p>diagram</p>    | <p>The diagram illustrates the relationship between the indicator <b>CompaniesWithoutSustainable...</b> (Share_Of_Investments_In_Companies_Without_Sustainable_Oceans_Or_Seas_Practices, 31871 - 31874) and the <b>PercentageStrategyCoverageType1.1</b> structure. The indicator is linked to a central node that branches into four components: <b>Value</b>, <b>ConsideredInInvestmentStrategy</b> (Yes/No), <b>Coverage</b> (% of notional/AUM), and <b>EligibleAssets</b> (% of assets).</p> |
| <p>type</p>       | <p><a href="#">PercentageStrategyCoverageType1.1</a></p>  |
| <p>properties</p> | <p>isRef 0<br/>minOcc 0<br/>maxOcc 1<br/>content complex</p>  |
| <p>children</p>   | <p><a href="#">Value</a> <a href="#">ConsideredInInvestmentStrategy</a> <a href="#">Coverage</a> <a href="#">EligibleAssets</a></p>   |
| <p>annotation</p> | <p>documentation<br/>Share_Of_Investments_In_Companies_Without_Sustainable_Oceans_Or_Seas_Practices (31871 - 31874)</p>   |

element

**EETReportType1.1.2/PrincipalAdverseIndicators/MoreClimateAndEnvironmentRelatedIndicators/Water WasteAndLandProtection/NonRecycledWasteRatio**

|                |   |
|----------------|---|
| <p>diagram</p> | <p>The diagram illustrates the relationship between the indicator <b>NonRecycledWasteRatio</b> (Non_Recycled_Waste_Ratio, 31875 - 31878) and the <b>ValueStrategyCoverageType1.1</b> structure. The indicator is linked to a central node that branches into four components: <b>Value</b>, <b>ConsideredInInvestmentStrategy</b> (Yes/No), <b>Coverage</b> (% of notional/AUM), and <b>EligibleAssets</b> (% of assets).</p> |
|----------------|---|

|            |  |
|------------|--|
| type       | <a href="#">ValueStrategyCoverageType1.1</a>   |
| properties | isRef 0<br>minOcc 0<br>maxOcc 1<br>content complex   |
| children   | <a href="#">Value</a> <a href="#">ConsideredInInvestmentStrategy</a> <a href="#">Coverage</a> <a href="#">EligibleAssets</a> |
| annotation | documentation<br>Non_Recycled_Waste_Ratio (31875 - 31878)  |

element

**EETReportType1.1.2/PrincipalAdverseIndicators/MoreClimateAndEnvironmentRelatedIndicators/WaterWasteAndLandProtection/CompaniesWhoseOperationsAffectThreatenedSpecies**

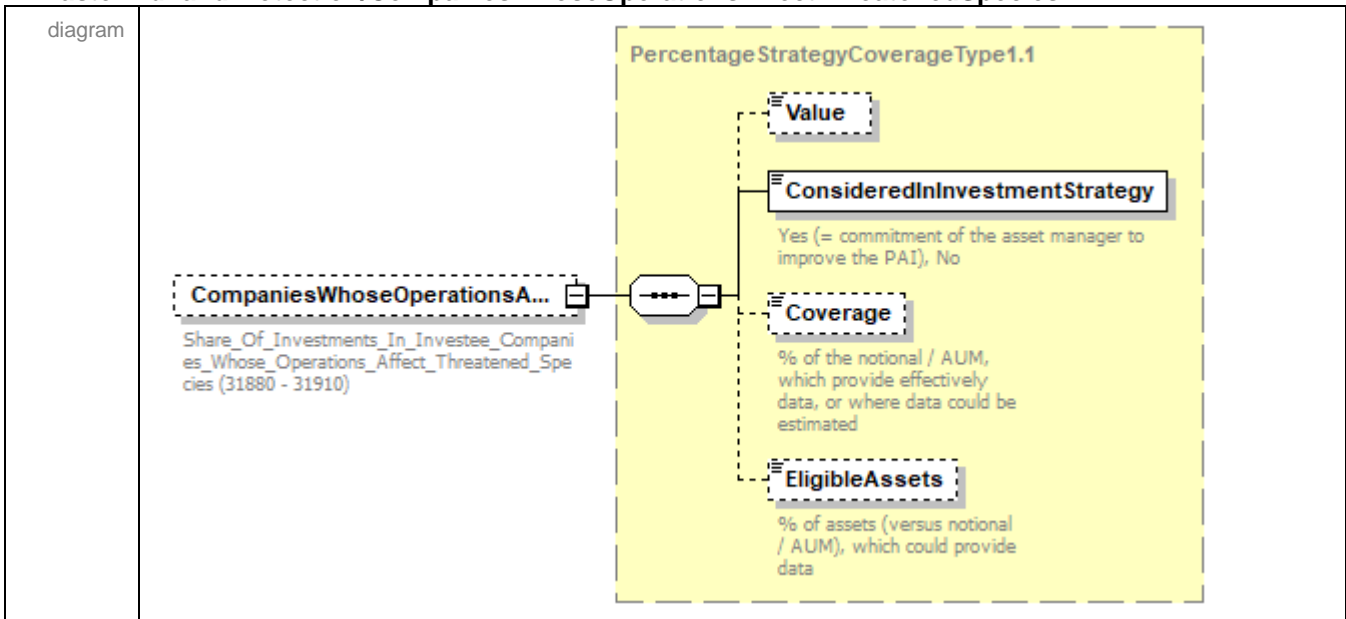

|            |  |
|------------|--|
| type       | <a href="#">PercentageStrategyCoverageType1.1</a>  |
| properties | isRef 0<br>minOcc 0<br>maxOcc 1<br>content complex   |
| children   | <a href="#">Value</a> <a href="#">ConsideredInInvestmentStrategy</a> <a href="#">Coverage</a> <a href="#">EligibleAssets</a> |
| annotation | documentation<br>Share_Of_Investments_In_Investee_Companies_Whose_Operations_Affect_Threatened_Species (31880 - 31910)       |

element

**EETReportType1.1.2/PrincipalAdverseIndicators/MoreClimateAndEnvironmentRelatedIndicators/Water  
WasteAndLandProtection/CompaniesWithoutBiodiversityProtection**

|                   |   |
|-------------------|---|
| <p>diagram</p>    |   |
| <p>type</p>       | <p><a href="#">PercentageStrategyCoverageType1.1</a></p>  |
| <p>properties</p> | <p>isRef 0<br/>minOcc 0<br/>maxOcc 1<br/>content complex</p>  |
| <p>children</p>   | <p><a href="#">Value</a> <a href="#">ConsideredInInvestmentStrategy</a> <a href="#">Coverage</a> <a href="#">EligibleAssets</a></p>   |
| <p>annotation</p> | <p>documentation<br/>Share_Of_Investments_In_Investee_Companies_Without_A_Biodiversity_Protection_Policy_Covering_Operational_Sites_Owned_Leased_Managed_In_Or_Adjacent_To_A_Protected_Area_Or_An_Area_Of_High_Biodiversity_Value_Outside_Protected_Areas (31920 - 31950)</p> |

element

**EETReportType1.1.2/PrincipalAdverseIndicators/MoreClimateAndEnvironmentRelatedIndicators/Water WasteAndLandProtection/CompaniesWithoutDeforestationPolicy**

|                   |   |
|-------------------|---|
| <p>diagram</p>    |   |
| <p>type</p>       | <p><a href="#">PercentageStrategyCoverageType1.1</a></p>  |
| <p>properties</p> | <p>isRef 0<br/>minOcc 0<br/>maxOcc 1<br/>content complex</p>  |
| <p>children</p>   | <p><a href="#">Value</a> <a href="#">ConsideredInInvestmentStrategy</a> <a href="#">Coverage</a> <a href="#">EligibleAssets</a></p> |
| <p>annotation</p> | <p>documentation<br/>Share_Of_Investee_Companies_Without_Deforestation_Policy (31960 - 31990)</p>                                   |

element

**EETReportType1.1.2/PrincipalAdverseIndicators/MoreClimateAndEnvironmentRelatedIndicators/Green Securities**

|                   |   |
|-------------------|---|
| <p>diagram</p>    |   |
| <p>properties</p> | <p>isRef 0<br/>minOcc 0<br/>maxOcc 1<br/>content complex</p>  |
| <p>children</p>   | <p><a href="#">SecuritiesNotIssuedUnderUnionLegislationOnEnvironmentallySustainableBonds</a><br/><a href="#">BondsNotIssuedUnderUnionLegislationOnEnvironmentallySustainableBonds</a></p> |
| <p>annotation</p> | <p>documentation<br/>32000 - 32070</p>  |

element

**EETReportType1.1.2/PrincipalAdverseIndicators/MoreClimateAndEnvironmentRelatedIndicators/Green Securities/SecuritiesNotIssuedUnderUnionLegislationOnEnvironmentallySustainableBonds**

|                   |  |
|-------------------|--|
| <p>diagram</p>    |  |
| <p>type</p>       | <p><a href="#">PercentageStrategyCoverageType1.1</a></p>   |
| <p>properties</p> | <p>isRef 0<br/>minOcc 0<br/>maxOcc 1<br/>content complex</p>   |
| <p>children</p>   | <p><a href="#">Value</a> <a href="#">ConsideredInInvestmentStrategy</a> <a href="#">Coverage</a> <a href="#">EligibleAssets</a></p>      |
| <p>annotation</p> | <p>documentation<br/>Share_Of_Securities_not_Issued_under_Union_legislation_on_environmentally_sustainable_bonds<br/>(32000 - 32030)</p> |

element

**EETReportType1.1.2/PrincipalAdverseIndicators/MoreClimateAndEnvironmentRelatedIndicators/Green Securities/BondsNotissuedUnderUnionLegislationOnEnvironmentallySustainableBonds**

|                   |   |
|-------------------|---|
| <p>diagram</p>    |   |
| <p>type</p>       | <p><a href="#">PercentageStrategyCoverageType1.1</a></p>  |
| <p>properties</p> | <p>isRef 0<br/>minOcc 0<br/>maxOcc 1<br/>content complex</p>  |
| <p>children</p>   | <p><a href="#">Value</a> <a href="#">ConsideredInInvestmentStrategy</a> <a href="#">Coverage</a> <a href="#">EligibleAssets</a></p> |
| <p>annotation</p> | <p>documentation<br/>32040_Share_Of_Bonds_not_issued_under_Union_legislation_on_environmentally_sustainable_bonds</p>               |

element

**EETReportType1.1.2/PrincipalAdverseIndicators/MoreClimateAndEnvironmentRelatedIndicators/RealEstateInvestments**

|                   |  |
|-------------------|--|
| <p>diagram</p>    |  |
| <p>properties</p> | <p>isRef 0<br/>minOcc 0<br/>maxOcc 1<br/>content complex</p>   |
| <p>children</p>   | <p><a href="#">GreenhouseGasEmissions</a> <a href="#">EnergyConsumptionIntensity</a> <a href="#">WasteProductionInOperations</a> <a href="#">RawMaterialConsumptionForNewConstructionAndMajorRenovations</a> <a href="#">LandArtificialisation</a></p> |
| <p>annotation</p> | <p>documentation<br/>32080 - 32430</p>   |

element

**EETReportType1.1.2/PrincipalAdverseIndicators/MoreClimateAndEnvironmentRelatedIndicators/RealEstateInvestments/GreenhouseGasEmissions**

|                   |  |
|-------------------|--|
| <p>diagram</p>    |  |
| <p>properties</p> | <p>isRef 0<br/>minOcc 0<br/>maxOcc 1<br/>content complex</p>   |
| <p>children</p>   | <p><a href="#">Scope1</a> <a href="#">Scope2</a> <a href="#">Scope3</a> <a href="#">TotalScope12</a> <a href="#">TotalScope123</a></p> |
| <p>annotation</p> | <p>documentation<br/>GHG_Emissions_Real_Estate (32080 - 32270)</p>   |

element

**EETReportType1.1.2/PrincipalAdverseIndicators/MoreClimateAndEnvironmentRelatedIndicators/RealEstateInvestments/GreenhouseGasEmissions/Scope1**

|            |  |
|------------|--|
| diagram    |  |
| type       | <a href="#">ValueStrategyCoverageType1.1</a>   |
| properties | isRef 0<br>minOcc 0<br>maxOcc 1<br>content complex   |
| children   | <a href="#">Value</a> <a href="#">ConsideredInInvestmentStrategy</a> <a href="#">Coverage</a> <a href="#">EligibleAssets</a> |

element

**EETReportType1.1.2/PrincipalAdverseIndicators/MoreClimateAndEnvironmentRelatedIndicators/RealEstateInvestments/GreenhouseGasEmissions/Scope2**

|         |  |
|---------|--|
| diagram |  |
|---------|--|



|            |  |
|------------|--|
| type       | <a href="#">ValueStrategyCoverageType1.1</a>   |
| properties | isRef 0<br>minOcc 0<br>maxOcc 1<br>content complex   |
| children   | <a href="#">Value</a> <a href="#">ConsideredInInvestmentStrategy</a> <a href="#">Coverage</a> <a href="#">EligibleAssets</a> |

element

**EETReportType1.1.2/PrincipalAdverseIndicators/MoreClimateAndEnvironmentRelatedIndicators/RealEstateInvestments/GreenhouseGasEmissions/Scope3**

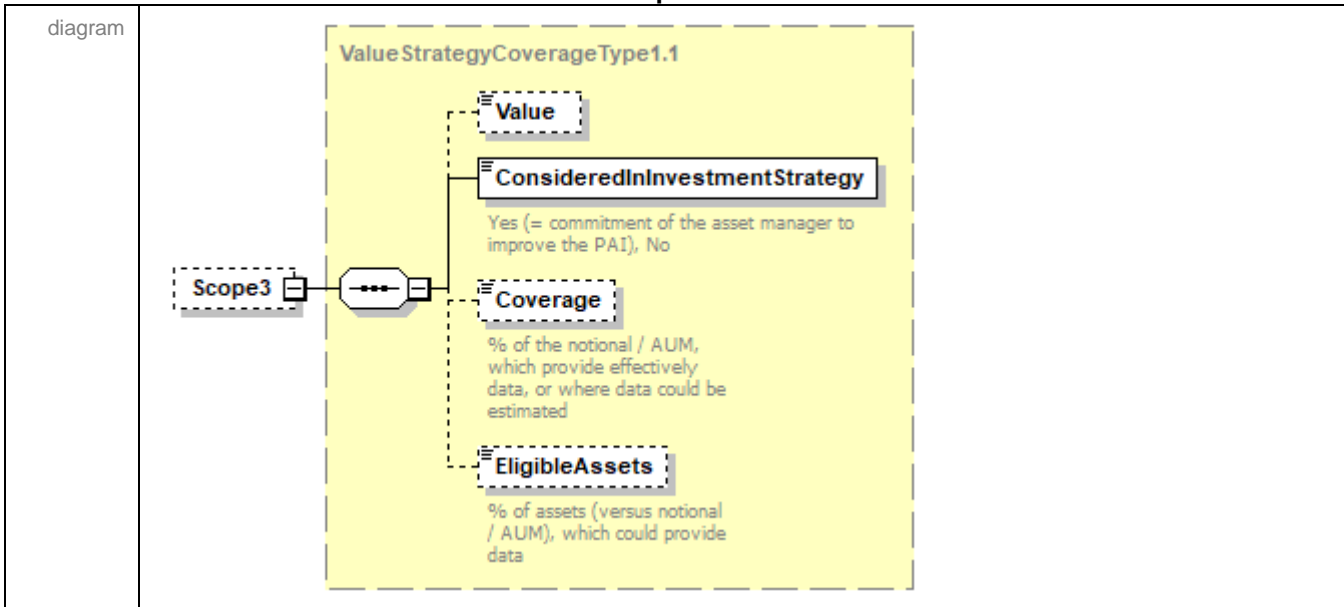

|            |  |
|------------|--|
| type       | <a href="#">ValueStrategyCoverageType1.1</a>   |
| properties | isRef 0<br>minOcc 0<br>maxOcc 1<br>content complex   |
| children   | <a href="#">Value</a> <a href="#">ConsideredInInvestmentStrategy</a> <a href="#">Coverage</a> <a href="#">EligibleAssets</a> |

element

**EETReportType1.1.2/PrincipalAdverseIndicators/MoreClimateAndEnvironmentRelatedIndicators/RealEstateInvestments/GreenhouseGasEmissions/TotalScope12**

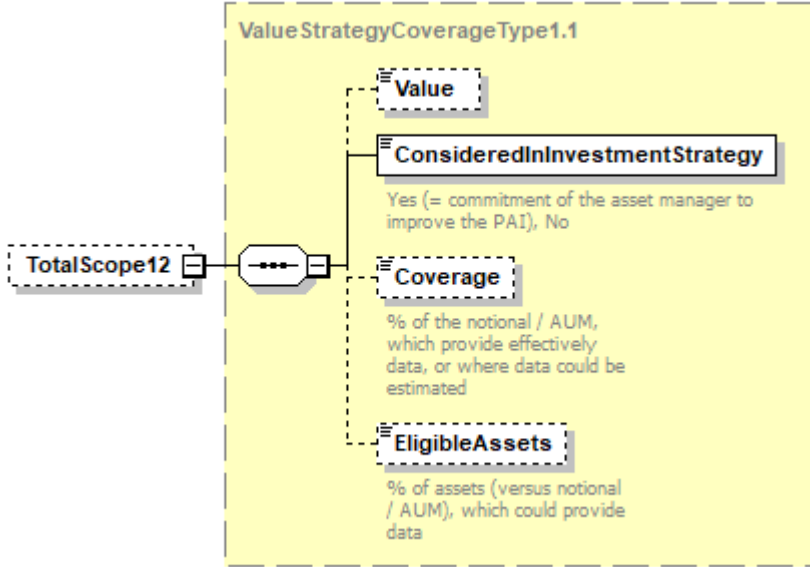
|            |  |
|------------|--|
| diagram    |  <p>The diagram shows a hierarchical structure for 'ValueStrategyCoverageType1.1'. A dashed box labeled 'TotalScope12' is connected to a central octagonal connector. This connector branches into three sub-elements: 'Value', 'ConsideredInInvestmentStrategy', and 'Coverage'. 'Value' is a simple box. 'ConsideredInInvestmentStrategy' is a box with a description: 'Yes (= commitment of the asset manager to improve the PAI), No'. 'Coverage' is a box with a description: '% of the notional / AUM, which provide effectively data, or where data could be estimated'. 'EligibleAssets' is a box with a description: '% of assets (versus notional / AUM), which could provide data'. The entire structure is enclosed in a yellow dashed box labeled 'ValueStrategyCoverageType1.1'.</p> |
| type       | <a href="#">ValueStrategyCoverageType1.1</a>   |
| properties | isRef 0<br>minOcc 0<br>maxOcc 1<br>content complex   |
| children   | <a href="#">Value</a> <a href="#">ConsideredInInvestmentStrategy</a> <a href="#">Coverage</a> <a href="#">EligibleAssets</a>   |

element

**EETReportType1.1.2/PrincipalAdverseIndicators/MoreClimateAndEnvironmentRelatedIndicators/RealEstateInvestments/GreenhouseGasEmissions/TotalScope123**

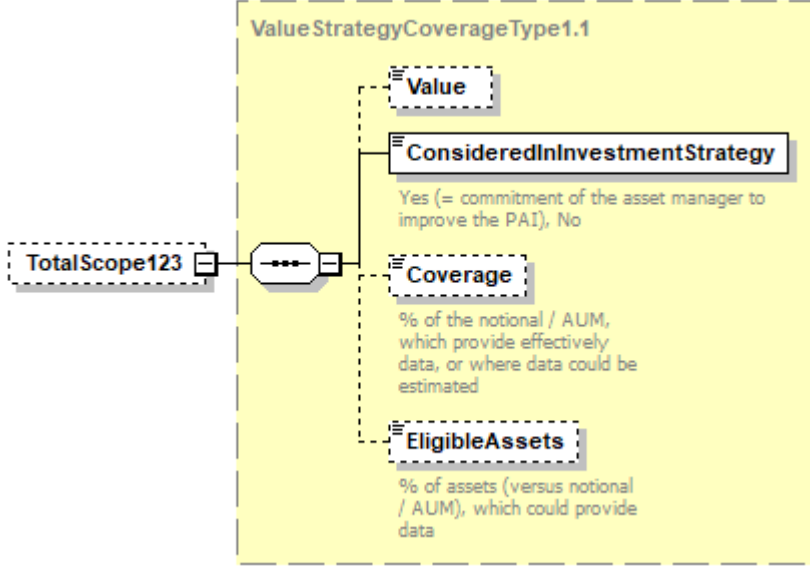
|         |   |
|---------|---|
| diagram |  <p>The diagram shows a hierarchical structure for 'ValueStrategyCoverageType1.1'. A dashed box labeled 'TotalScope123' is connected to a central octagonal connector. This connector branches into three sub-elements: 'Value', 'ConsideredInInvestmentStrategy', and 'Coverage'. 'Value' is a simple box. 'ConsideredInInvestmentStrategy' is a box with a description: 'Yes (= commitment of the asset manager to improve the PAI), No'. 'Coverage' is a box with a description: '% of the notional / AUM, which provide effectively data, or where data could be estimated'. 'EligibleAssets' is a box with a description: '% of assets (versus notional / AUM), which could provide data'. The entire structure is enclosed in a yellow dashed box labeled 'ValueStrategyCoverageType1.1'.</p> |
| type    | <a href="#">ValueStrategyCoverageType1.1</a>  |

|            |  |
|------------|--|
| properties | isRef 0<br>minOcc 0<br>maxOcc 1<br>content complex   |
| children   | <a href="#">Value</a> <a href="#">ConsideredInInvestmentStrategy</a> <a href="#">Coverage</a> <a href="#">EligibleAssets</a> |

element

**EETReportType1.1.2/PrincipalAdverseIndicators/MoreClimateAndEnvironmentRelatedIndicators/RealEstateInvestments/EnergyConsumptionIntensity**

|            |  |
|------------|--|
| diagram    |  |
| type       | <a href="#">ValueStrategyCoverageType1.1</a>   |
| properties | isRef 0<br>minOcc 0<br>maxOcc 1<br>content complex   |
| children   | <a href="#">Value</a> <a href="#">ConsideredInInvestmentStrategy</a> <a href="#">Coverage</a> <a href="#">EligibleAssets</a> |
| annotation | documentation<br>Energy_Consumption_Intensity_Value<br>(32280 - 32310)   |

element

**EETReportType1.1.2/PrincipalAdverseIndicators/MoreClimateAndEnvironmentRelatedIndicators/RealEstateInvestments/WasteProductionInOperations**

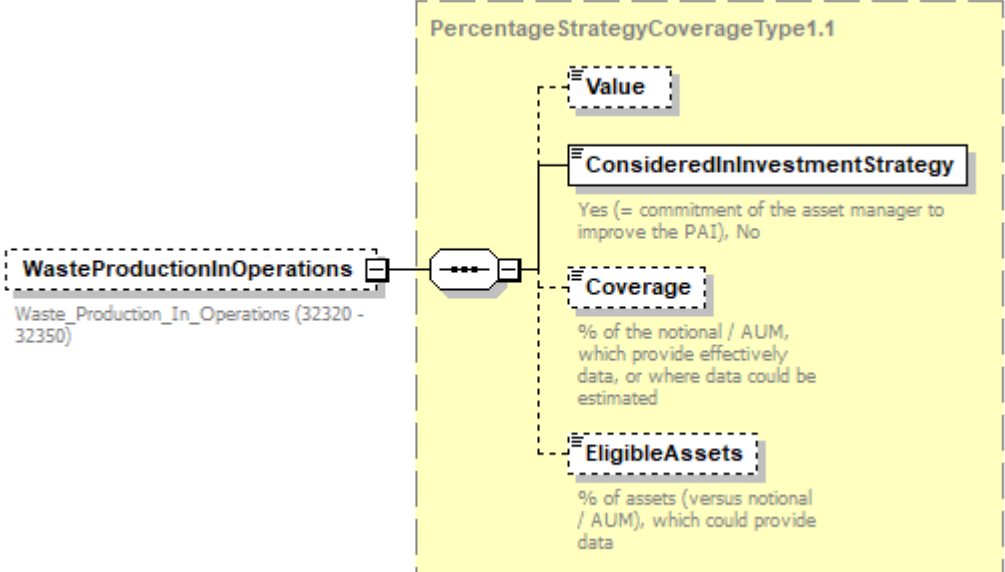
|                   |   |
|-------------------|---|
| <p>diagram</p>    |  <pre> classDiagram     class WasteProductionInOperations {         Waste_Production_In_Operations (32320 - 32350)     }     class PercentageStrategyCoverageType11 {         Value         ConsideredInInvestmentStrategy         Coverage         EligibleAssets     }     WasteProductionInOperations -- PercentageStrategyCoverageType11     </pre> |
| <p>type</p>       | <p><a href="#">PercentageStrategyCoverageType1.1</a></p>  |
| <p>properties</p> | <p>isRef 0<br/>minOcc 0<br/>maxOcc 1<br/>content complex</p>  |
| <p>children</p>   | <p><a href="#">Value</a> <a href="#">ConsideredInInvestmentStrategy</a> <a href="#">Coverage</a> <a href="#">EligibleAssets</a></p>   |
| <p>annotation</p> | <p>documentation<br/>Waste_Production_In_Operations (32320 - 32350)</p>   |

element

**EETReportType1.1.2/PrincipalAdverseIndicators/MoreClimateAndEnvironmentRelatedIndicators/RealEstateInvestments/RawMaterialConsumptionForNewConstructionAndMajorRenovations**

|                   |   |
|-------------------|---|
| <p>diagram</p>    |   |
| <p>type</p>       | <p><a href="#">PercentageStrategyCoverageType1.1</a></p>  |
| <p>properties</p> | <p>isRef 0<br/>minOcc 0<br/>maxOcc 1<br/>content complex</p>  |
| <p>children</p>   | <p><a href="#">Value</a> <a href="#">ConsideredInInvestmentStrategy</a> <a href="#">Coverage</a> <a href="#">EligibleAssets</a></p> |
| <p>annotation</p> | <p>documentation<br/>Raw_Material_Consumption_For_New_Construction_And_Major_Renovations (32360 - 32390)</p>                        |

element

**EETReportType1.1.2/PrincipalAdverseIndicators/MoreClimateAndEnvironmentRelatedIndicators/RealEstateInvestments/LandArtificialisation**

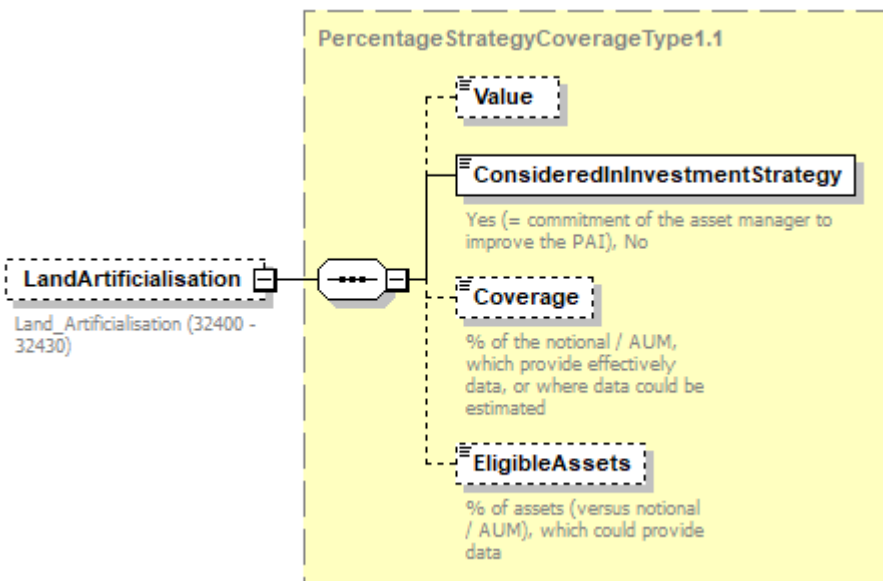
|                   |  |
|-------------------|--|
| <p>diagram</p>    |  <p><b>PercentageStrategyCoverageType1.1</b></p> <ul style="list-style-type: none"> <li><b>Value</b></li> <li><b>ConsideredInInvestmentStrategy</b><br/>Yes (= commitment of the asset manager to improve the PAI), No</li> <li><b>Coverage</b><br/>% of the notional / AUM, which provide effectively data, or where data could be estimated</li> <li><b>EligibleAssets</b><br/>% of assets (versus notional / AUM), which could provide data</li> </ul> <p><b>LandArtificialisation</b><br/>Land_Artificialisation (32400 - 32430)</p> |
| <p>type</p>       | <p><a href="#">PercentageStrategyCoverageType1.1</a></p>   |
| <p>properties</p> | <p>isRef 0<br/>minOcc 0<br/>maxOcc 1<br/>content complex</p>   |
| <p>children</p>   | <p><a href="#">Value</a> <a href="#">ConsideredInInvestmentStrategy</a> <a href="#">Coverage</a> <a href="#">EligibleAssets</a></p>  |
| <p>annotation</p> | <p>documentation<br/>Land_Artificialisation (32400 - 32430)</p>  |

element **EETReportType1.1.2/PrincipalAdverseIndicators/MoreSocialAndEmployeeMatters**

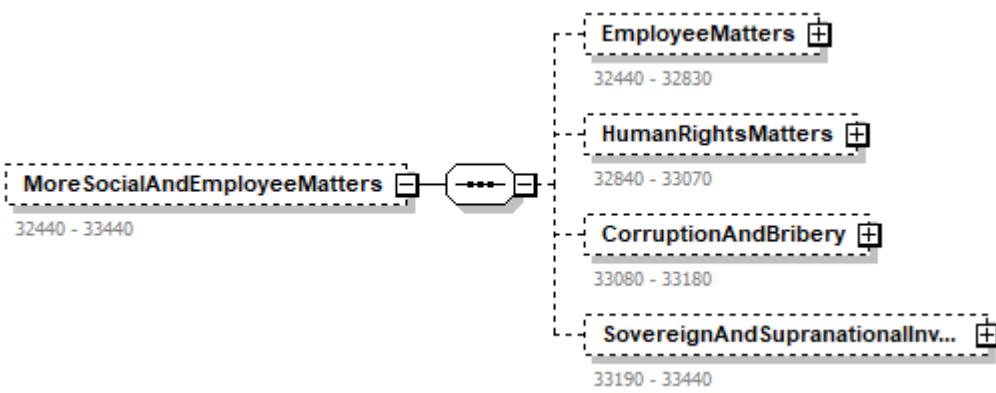
|                   |   |
|-------------------|---|
| <p>diagram</p>    |  <p><b>More SocialAndEmployeeMatters</b><br/>32440 - 33440</p> <ul style="list-style-type: none"> <li><b>EmployeeMatters</b><br/>32440 - 32830</li> <li><b>HumanRightsMatters</b><br/>32840 - 33070</li> <li><b>CorruptionAndBribery</b><br/>33080 - 33180</li> <li><b>SovereignAndSupranationalInv...</b><br/>33190 - 33440</li> </ul> |
| <p>properties</p> | <p>isRef 0<br/>minOcc 0<br/>maxOcc 1<br/>content complex</p>  |
| <p>children</p>   | <p><a href="#">EmployeeMatters</a> <a href="#">HumanRightsMatters</a> <a href="#">CorruptionAndBribery</a> <a href="#">SovereignAndSupranationalInvestments</a></p>   |
| <p>annotation</p> | <p>documentation<br/>32440 - 33440</p>  |

element

**EETReportType1.1.2/PrincipalAdverseIndicators/MoreSocialAndEmployeeMatters/EmployeeMatters**

|                   |  |
|-------------------|--|
| <p>diagram</p>    | <p><b>EmployeeMatters</b> 32440 - 32830</p> <ul style="list-style-type: none"> <li><b>CompaniesWithoutWorkplaceA...</b> Exposure_To_Companies_Without_Workplace_Accident_Prevention_Policy (32440 - 32470)</li> <li><b>RateOfAccidents</b> Rate_Of_Accidents (32480 - 32510)</li> <li><b>NumberOfDaysLostForInjuries...</b> Number_Of_Days_Lost_For_Injuries_Accidents_Fatalities_Illness (32520 - 32550)</li> <li><b>CompaniesWithoutAnySupplier...</b> Share_Of_Investments_In_Investee_Companies_Without_Any_Supplier_Code_Of_Conduct_Against_Unsafe_Working_Conditions_Precarious_Work_Child_Labour_And_Forced_Labour (32560 - 32590)</li> <li><b>CompaniesWithoutAnyGrievan...</b> Share_Of_Investments_In_Investee_Companies_Without_Any_Grievance_Or_Complaints_Handling_Mechanism (32640 - 32670)</li> <li><b>CompaniesWithInsufficientWhi...</b> Share_Of_Investee_Companies_With_Insufficient_Whistleblower_Protection (32680 - 32710)</li> <li><b>NumberOfIncidentsOfDiscrimin...</b> Number_Of_Incidents_Of_Discrimination_Reported_In_Investee_Companies (32720 - 32750)</li> <li><b>NumberOfIncidentsOfDiscrimin...</b> Number_Of_Incidents_Of_Discrimination_Leading_To_Sanctions_In_Investee_Companies (32760 - 32790)</li> <li><b>ExcessiveCEOPayRatio</b> Excessive_CEO_Pay_Ratio (32800 - 32830)</li> </ul> |
| <p>properties</p> | <p>isRef 0<br/>minOcc 0<br/>maxOcc 1<br/>content complex</p>   |
| <p>children</p>   | <p><a href="#">CompaniesWithoutWorkplaceAccidentPreventionPolicy</a> <a href="#">RateOfAccidents</a> <a href="#">NumberOfDaysLostForInjuriesAccidentsFatalitiesIllness</a> <a href="#">CompaniesWithoutAnySupplierCodeOfConductAgainstUnsafeWorkingConditions</a> <a href="#">CompaniesWithoutAnyGrievanceOrComplaintsHandlingMechanism</a> <a href="#">CompaniesWithInsufficientWhistleblowerProtection</a> <a href="#">NumberOfIncidentsOfDiscriminationReported</a> <a href="#">NumberOfIncidentsOfDiscriminationLeadingToSanctions</a> <a href="#">ExcessiveCEOPayRatio</a></p>  |
| <p>annotation</p> | <p>documentation<br/>32440 - 32830</p>   |

element

**EETReportType1.1.2/PrincipalAdverseIndicators/MoreSocialAndEmployeeMatters/EmployeeMatters/CompaniesWithoutWorkplaceAccidentPreventionPolicy**

|                   |   |
|-------------------|---|
| <p>diagram</p>    |   |
| <p>type</p>       | <p><a href="#">PercentageStrategyCoverageType1.1</a></p>  |
| <p>properties</p> | <p>isRef 0<br/>minOcc 0<br/>maxOcc 1<br/>content complex</p>  |
| <p>children</p>   | <p><a href="#">Value</a> <a href="#">ConsideredInInvestmentStrategy</a> <a href="#">Coverage</a> <a href="#">EligibleAssets</a></p> |
| <p>annotation</p> | <p>documentation<br/>Exposure_To_Companies_Without_Workplace_Accident_Prevention_Policy (32440 - 32470)</p>                         |

element

**EETReportType1.1.2/PrincipalAdverseIndicators/MoreSocialAndEmployeeMatters/EmployeeMatters/RateOfAccidents**

|                |  |
|----------------|--|
| <p>diagram</p> |  |
|----------------|--|



|            |  |
|------------|--|
| type       | <a href="#">ValueStrategyCoverageType1.1</a>   |
| properties | isRef 0<br>minOcc 0<br>maxOcc 1<br>content complex   |
| children   | <a href="#">Value</a> <a href="#">ConsideredInInvestmentStrategy</a> <a href="#">Coverage</a> <a href="#">EligibleAssets</a> |
| annotation | documentation<br>Rate_Of_Accidents (32480 - 32510)   |

element

**EETReportType1.1.2/PrincipalAdverseIndicators/MoreSocialAndEmployeeMatters/EmployeeMatters/NumberOfDaysLostForInjuriesAccidentsFatalitiesIllness**

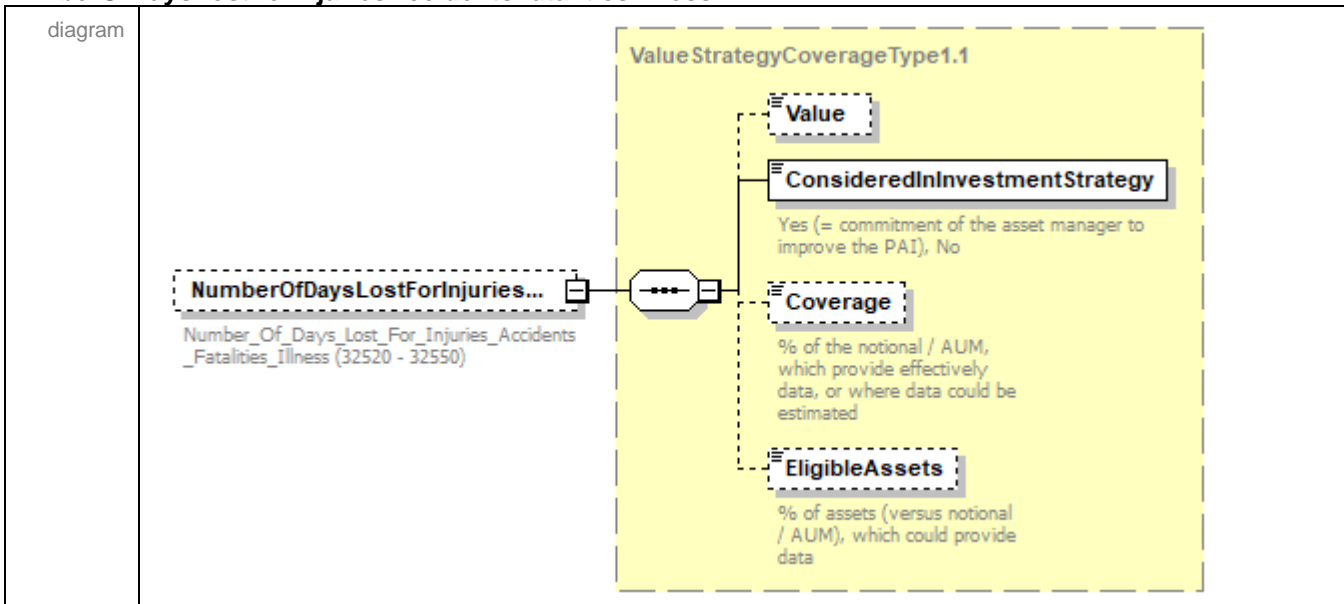

|            |  |
|------------|--|
| type       | <a href="#">ValueStrategyCoverageType1.1</a>   |
| properties | isRef 0<br>minOcc 0<br>maxOcc 1<br>content complex   |
| children   | <a href="#">Value</a> <a href="#">ConsideredInInvestmentStrategy</a> <a href="#">Coverage</a> <a href="#">EligibleAssets</a> |
| annotation | documentation<br>Number_Of_Days_Lost_For_Injuries_Accidents_Fatalities_Illness (32520 - 32550)                               |

element

**EETReportType1.1.2/PrincipalAdverseIndicators/MoreSocialAndEmployeeMatters/EmployeeMatters/CompaniesWithoutAnySupplierCodeOfConductAgainstUnsafeWorkingConditions**

|                   |   |
|-------------------|---|
| <p>diagram</p>    |   |
| <p>type</p>       | <p><a href="#">PercentageStrategyCoverageType1.1</a></p>  |
| <p>properties</p> | <p>isRef 0<br/>minOcc 0<br/>maxOcc 1<br/>content complex</p>  |
| <p>children</p>   | <p><a href="#">Value</a> <a href="#">ConsideredInInvestmentStrategy</a> <a href="#">Coverage</a> <a href="#">EligibleAssets</a></p>   |
| <p>annotation</p> | <p>documentation<br/>Share_Of_Investments_In_Investee_Companies_Without_Any_Supplier_Code_Of_Conduct_Against_Unsafe_Working_Conditions_Precarious_Work_Child_Labour_And_Forced_Labour (32560 - 32590)</p> |

element

**EETReportType1.1.2/PrincipalAdverseIndicators/MoreSocialAndEmployeeMatters/EmployeeMatters/CompaniesWithoutAnyGrievanceOrComplaintsHandlingMechanism**

|                   |  |
|-------------------|--|
| <p>diagram</p>    |  |
| <p>type</p>       | <p><a href="#">PercentageStrategyCoverageType1.1</a></p>   |
| <p>properties</p> | <p>isRef 0<br/>minOcc 0<br/>maxOcc 1<br/>content complex</p>   |
| <p>children</p>   | <p><a href="#">Value</a> <a href="#">ConsideredInInvestmentStrategy</a> <a href="#">Coverage</a> <a href="#">EligibleAssets</a></p>        |
| <p>annotation</p> | <p>documentation<br/>Share_Of_Investments_In_Investee_Companies_Without_Any_Grievance_Or_Complaints_Handling_Mechanism (32640 - 32670)</p> |

element

### EETReportType1.1.2/PrincipalAdverseIndicators/MoreSocialAndEmployeeMatters/EmployeeMatters/CompaniesWithInsufficientWhistleblowerProtection

|            |  |
|------------|--|
| diagram    | <p>The diagram shows a class structure for <b>PercentageStrategyCoverageType1.1</b>. On the left, a dashed box labeled <b>CompaniesWithInsufficientWhi...</b> contains the text <i>Share_Of_Investee_Companies_With_Insufficient_Whistleblower_Protection (32680 - 32710)</i>. This box is connected to a central circle containing a dashed line. To the right, a larger dashed box titled <b>PercentageStrategyCoverageType1.1</b> contains three sub-elements: <b>Value</b>, <b>ConsideredInInvestmentStrategy</b>, and <b>EligibleAssets</b>. <b>ConsideredInInvestmentStrategy</b> is a solid box with the text "Yes (= commitment of the asset manager to improve the PAI), No". <b>Coverage</b> is a dashed box with the text "% of the notional / AUM, which provide effectively data, or where data could be estimated". <b>EligibleAssets</b> is a dashed box with the text "% of assets (versus notional / AUM), which could provide data".</p> |
| type       | <a href="#">PercentageStrategyCoverageType1.1</a>  |
| properties | isRef 0<br>minOcc 0<br>maxOcc 1<br>content complex   |
| children   | <a href="#">Value</a> <a href="#">ConsideredInInvestmentStrategy</a> <a href="#">Coverage</a> <a href="#">EligibleAssets</a>   |
| annotation | documentation<br>Share_Of_Investee_Companies_With_Insufficient_Whistleblower_Protection (32680 - 32710)  |

element

### EETReportType1.1.2/PrincipalAdverseIndicators/MoreSocialAndEmployeeMatters/EmployeeMatters/NumberOfIncidentsOfDiscriminationReported

|         |  |
|---------|--|
| diagram | <p>The diagram shows a class structure for <b>ValueStrategyCoverageType1.1</b>. On the left, a dashed box labeled <b>NumberOfIncidentsOfDiscrimin...</b> contains the text <i>Number_Of_Incidents_Of_Discrimination_Reporded_In_Investee_Companies (32720 - 32750)</i>. This box is connected to a central circle containing a dashed line. To the right, a larger dashed box titled <b>ValueStrategyCoverageType1.1</b> contains three sub-elements: <b>Value</b>, <b>ConsideredInInvestmentStrategy</b>, and <b>EligibleAssets</b>. <b>ConsideredInInvestmentStrategy</b> is a solid box with the text "Yes (= commitment of the asset manager to improve the PAI), No". <b>Coverage</b> is a dashed box with the text "% of the notional / AUM, which provide effectively data, or where data could be estimated". <b>EligibleAssets</b> is a dashed box with the text "% of assets (versus notional / AUM), which could provide data".</p> |
|---------|--|

|            |  |
|------------|--|
| type       | <a href="#">ValueStrategyCoverageType1.1</a>   |
| properties | isRef 0<br>minOcc 0<br>maxOcc 1<br>content complex   |
| children   | <a href="#">Value</a> <a href="#">ConsideredInInvestmentStrategy</a> <a href="#">Coverage</a> <a href="#">EligibleAssets</a> |
| annotation | documentation<br>Number_Of_Incidents_Of_Discrimination_Reported_In_Investee_Companies (32720 - 32750)                        |

element

**EETReportType1.1.2/PrincipalAdverseIndicators/MoreSocialAndEmployeeMatters/EmployeeMatters/NumberOfIncidentsOfDiscriminationLeadingToSanctions**

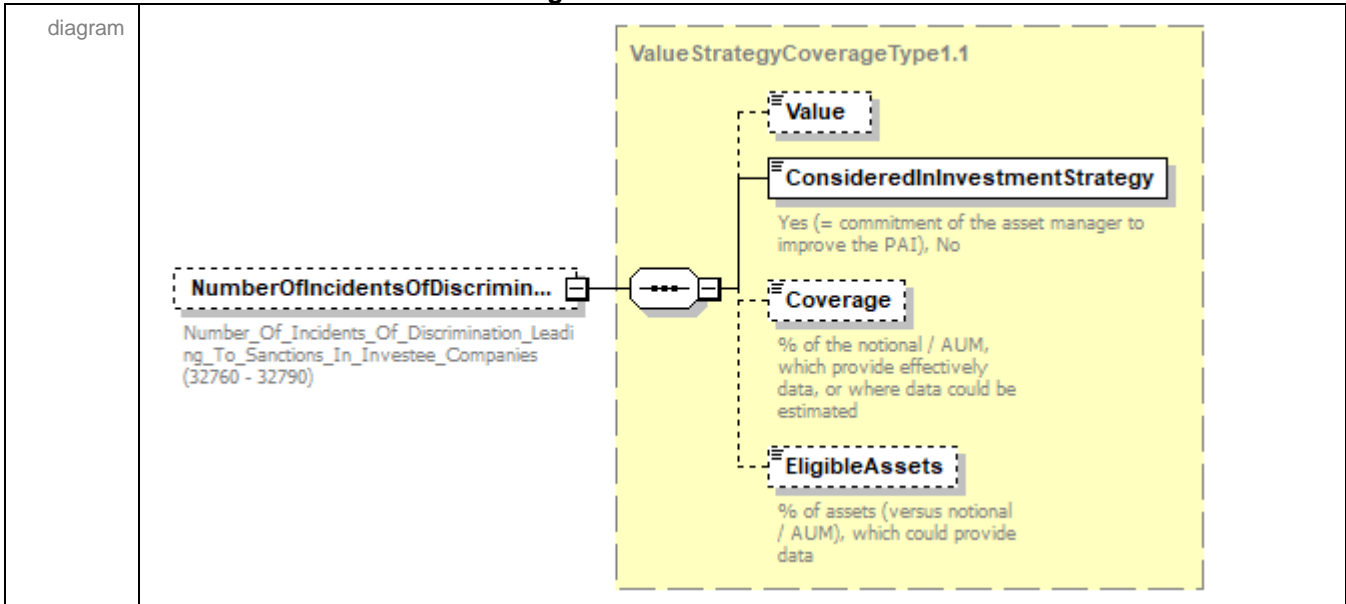

|            |  |
|------------|--|
| type       | <a href="#">ValueStrategyCoverageType1.1</a>   |
| properties | isRef 0<br>minOcc 0<br>maxOcc 1<br>content complex   |
| children   | <a href="#">Value</a> <a href="#">ConsideredInInvestmentStrategy</a> <a href="#">Coverage</a> <a href="#">EligibleAssets</a> |
| annotation | documentation<br>Number_Of_Incidents_Of_Discrimination_Leading_To_Sanctions_In_Investee_Companies (32760 - 32790)            |

element

**EETReportType1.1.2/PrincipalAdverseIndicators/MoreSocialAndEmployeeMatters/EmployeeMatters/ExcessiveCEOPayRatio**

|            |   |
|------------|---|
| diagram    | <p><b>ExcessiveCEOPayRatio</b><br/>Excessive_CEO_Pay_Ratio<br/>(32800 - 32830)</p> <p><b>ValueStrategyCoverageType1.1</b></p> <ul style="list-style-type: none"><li><b>Value</b></li><li><b>ConsideredInvestmentStrategy</b><br/>Yes (= commitment of the asset manager to improve the PAI), No</li><li><b>Coverage</b><br/>% of the notional / AUM, which provide effectively data, or where data could be estimated</li><li><b>EligibleAssets</b><br/>% of assets (versus notional / AUM), which could provide data</li></ul> |
| type       | <a href="#">ValueStrategyCoverageType1.1</a>  |
| properties | isRef 0<br>minOcc 0<br>maxOcc 1<br>content complex  |
| children   | <a href="#">Value</a> <a href="#">ConsideredInvestmentStrategy</a> <a href="#">Coverage</a> <a href="#">EligibleAssets</a>  |
| annotation | documentation<br>Excessive_CEO_Pay_Ratio (32800 - 32830)  |

element

**EETReportType1.1.2/PrincipalAdverseIndicators/MoreSocialAndEmployeeMatters/HumanRightsMatters**

|                   |   |
|-------------------|---|
| <p>diagram</p>    | <pre> classDiagram     class HumanRightsMatters {         32840 - 33070     }     class CompaniesWithoutHumanRightPolicy {         Exposure_To_Companies_Without_Human_Right_Policy (32840 - 32870)     }     class CompaniesWithLackOfDueDiligence {         Exposure_To_Companies_With_Lack_Of_Due_Diligence (32880 - 32910)     }     class CompaniesWithoutSufficientHumanTraffickingPrevention {         Exposure_To_Companies_With_Lack_Of_Processes_And_Measures_For_Preventing_Trafficking_In_Human_Beings_Local (32920 - 32950)     }     class CompaniesOperationsSuppliersSignificantRiskChildLabour {         Exposure_To_Companies_With_Operations_And_Suppliers_At_Significant_Risk_Of_Incidents_Of_Child_Labour (32960 - 32990)     }     class CompaniesOperationsSuppliersSignificantRiskForcedLabour {         Exposure_To_Companies_With_Operations_And_Suppliers_At_Significant_Risk_Of_Incidents_Of_Forced_Or_Compulsory_Labour (33000 - 33030)     }     class NumberOfCasesOfSevereHumanRightsIssues {         Number_Of_Identified_Cases_of_Severe_Human_Rights_Issues_And_Incidents (33040 - 33070)     }     HumanRightsMatters &lt; -- CompaniesWithoutHumanRightPolicy     HumanRightsMatters &lt; -- CompaniesWithLackOfDueDiligence     HumanRightsMatters &lt; -- CompaniesWithoutSufficientHumanTraffickingPrevention     HumanRightsMatters &lt; -- CompaniesOperationsSuppliersSignificantRiskChildLabour     HumanRightsMatters &lt; -- CompaniesOperationsSuppliersSignificantRiskForcedLabour     HumanRightsMatters &lt; -- NumberOfCasesOfSevereHumanRightsIssues         </pre> |
| <p>properties</p> | <p>isRef 0<br/> minOcc 0<br/> maxOcc 1<br/> content complex</p>   |
| <p>children</p>   | <p><a href="#">CompaniesWithoutHumanRightPolicy</a> <a href="#">CompaniesWithLackOfDueDiligence</a><br/> <a href="#">CompaniesWithoutSufficientHumanTraffickingPrevention</a><br/> <a href="#">CompaniesOperationsSuppliersSignificantRiskChildLabour</a><br/> <a href="#">CompaniesOperationsSuppliersSignificantRiskForcedLabour</a> <a href="#">NumberOfCasesOfSevereHumanRightsIssues</a></p>   |
| <p>annotation</p> | <p>documentation<br/> 32840 - 33070</p>   |

element

**EETReportType1.1.2/PrincipalAdverseIndicators/MoreSocialAndEmployeeMatters/HumanRightsMatters/CompaniesWithoutHumanRightPolicy**

|                   |   |
|-------------------|---|
| <p>diagram</p>    |   |
| <p>type</p>       | <p><a href="#">PercentageStrategyCoverageType1.1</a></p>  |
| <p>properties</p> | <p>isRef 0<br/>minOcc 0<br/>maxOcc 1<br/>content complex</p>  |
| <p>children</p>   | <p><a href="#">Value</a> <a href="#">ConsideredInInvestmentStrategy</a> <a href="#">Coverage</a> <a href="#">EligibleAssets</a></p> |
| <p>annotation</p> | <p>documentation<br/>Exposure_To_Companies_Without_Human_Right_Policy (32840 - 32870)</p>   |



element

**EETReportType1.1.2/PrincipalAdverseIndicators/MoreSocialAndEmployeeMatters/HumanRightsMatters/CompaniesWithLackOfDueDiligence**

|            |  |
|------------|--|
| diagram    |  |
| type       | <a href="#">PercentageStrategyCoverageType1.1</a>  |
| properties | isRef 0<br>minOcc 0<br>maxOcc 1<br>content complex   |
| children   | <a href="#">Value</a> <a href="#">ConsideredInInvestmentStrategy</a> <a href="#">Coverage</a> <a href="#">EligibleAssets</a> |
| annotation | documentation<br>Exposure_To_Companies_With_Lack_Of_Due_Diligence (32880 - 32910)  |

element

**EETReportType1.1.2/PrincipalAdverseIndicators/MoreSocialAndEmployeeMatters/HumanRightsMatters/CompaniesWithoutSufficientHumanTraffickingPrevention**

|                   |  |
|-------------------|--|
| <p>diagram</p>    | <p><b>CompaniesWithoutSufficientHu...</b><br/>         Exposure_To_Companies_With_Lack_Of_Proces<br/>         sses_And_Measures_For_Preventing_Traffickin<br/>         g_In_Human_Beings_Local (32920 - 32950)</p> <p><b>PercentageStrategyCoverageType1.1</b></p> <ul style="list-style-type: none"> <li><b>Value</b></li> <li><b>ConsideredInInvestmentStrategy</b><br/>             Yes (= commitment of the asset manager to improve the PAI), No</li> <li><b>Coverage</b><br/>             % of the notional / AUM, which provide effectively data, or where data could be estimated</li> <li><b>EligibleAssets</b><br/>             % of assets (versus notional / AUM), which could provide data</li> </ul> |
| <p>type</p>       | <p><a href="#">PercentageStrategyCoverageType1.1</a></p>   |
| <p>properties</p> | <p>isRef 0<br/>         minOcc 0<br/>         maxOcc 1<br/>         content complex</p>  |
| <p>children</p>   | <p><a href="#">Value</a> <a href="#">ConsideredInInvestmentStrategy</a> <a href="#">Coverage</a> <a href="#">EligibleAssets</a></p>  |
| <p>annotation</p> | <p>documentation<br/>         Exposure_To_Companies_With_Lack_Of_Proces<br/>         ses_And_Measures_For_Preventing_Traffickin<br/>         g_In_Human_Beings_Local (32920 - 32950)</p>   |

element

**EETReportType1.1.2/PrincipalAdverseIndicators/MoreSocialAndEmployeeMatters/HumanRightsMatters/CompaniesOperationsSuppliersSignificantRiskChildLabour**

|                   |   |
|-------------------|---|
| <p>diagram</p>    |   |
| <p>type</p>       | <p><a href="#">PercentageStrategyCoverageType1.1</a></p>  |
| <p>properties</p> | <p>isRef 0<br/>minOcc 0<br/>maxOcc 1<br/>content complex</p>  |
| <p>children</p>   | <p><a href="#">Value</a> <a href="#">ConsideredInInvestmentStrategy</a> <a href="#">Coverage</a> <a href="#">EligibleAssets</a></p>           |
| <p>annotation</p> | <p>documentation<br/>Exposure_To_Companies_With_Operations_And_Suppliers_At_Significant_Risk_Of_Incidents_Of_Child_Labour (32960 - 32990)</p> |

element

**EETReportType1.1.2/PrincipalAdverseIndicators/MoreSocialAndEmployeeMatters/HumanRightsMatters/CompaniesOperationsSuppliersSignificantRiskForcedLabour**

|                   |  |
|-------------------|--|
| <p>diagram</p>    |  |
| <p>type</p>       | <p><a href="#">PercentageStrategyCoverageType1.1</a></p>   |
| <p>properties</p> | <p>isRef 0<br/>minOcc 0<br/>maxOcc 1<br/>content complex</p>   |
| <p>children</p>   | <p><a href="#">Value</a> <a href="#">ConsideredInInvestmentStrategy</a> <a href="#">Coverage</a> <a href="#">EligibleAssets</a></p>                          |
| <p>annotation</p> | <p>documentation<br/>Exposure_To_Companies_With_Operations_And_Suppliers_At_Significant_Risk_Of_Incidents_Of_Forced_Or_Compulsory_Labour (33000 - 33030)</p> |

element

**EETReportType1.1.2/PrincipalAdverseIndicators/MoreSocialAndEmployeeMatters/HumanRightsMatters/NumberOfCasesOfSevereHumanRightsIssues**

|                   |   |
|-------------------|---|
| <p>diagram</p>    |   |
| <p>type</p>       | <p><a href="#">ValueStrategyCoverageType1.1</a></p>   |
| <p>properties</p> | <p>isRef 0<br/>minOcc 0<br/>maxOcc 1<br/>content complex</p>  |
| <p>children</p>   | <p><a href="#">Value</a> <a href="#">ConsideredInInvestmentStrategy</a> <a href="#">Coverage</a> <a href="#">EligibleAssets</a></p> |
| <p>annotation</p> | <p>documentation<br/>Number_Of_Identified_Cases_of_Severe_Human_Rights_Issues_And_Incidents (33040 - 33070)</p>                     |

element

**EETReportType1.1.2/PrincipalAdverseIndicators/MoreSocialAndEmployeeMatters/CorruptionAndBribery**

|                   |  |
|-------------------|--|
| <p>diagram</p>    |  |
| <p>properties</p> | <p>isRef 0<br/>minOcc 0<br/>maxOcc 1<br/>content complex</p>                   |
| <p>children</p>   | <p><a href="#">CompaniesWithLackOfAntiCorruptionAndAntiBriberyPolicies</a></p> |

|            |  |
|------------|--|
|            | <a href="#">CompaniesInsufficientReactionsOnCorruptionAndBribery ConvictionsOfAntiCorruptionAndAntiBriberyLaws</a> |
| annotation | documentation<br>33080 - 33180   |

element

**EETReportType1.1.2/PrincipalAdverseIndicators/MoreSocialAndEmployeeMatters/CorruptionAndBribery/CompaniesWithLackOfAntiCorruptionAndAntiBriberyPolicies**

|            |  |
|------------|--|
| diagram    |  |
| type       | <a href="#">PercentageStrategyCoverageType1.1</a>  |
| properties | isRef 0<br>minOcc 0<br>maxOcc 1<br>content complex   |
| children   | <a href="#">Value</a> <a href="#">ConsideredInInvestmentStrategy</a> <a href="#">Coverage</a> <a href="#">EligibleAssets</a> |
| annotation | documentation<br>Exposure_To_Companies_With_A_lack_Of_Anti_Corruption_And_Anti_Bribery_Policies (33080 - 33110)              |

element

**EETReportType1.1.2/PrincipalAdverseIndicators/MoreSocialAndEmployeeMatters/CorruptionAndBribery/CompaniesInsufficientReactionsOnCorruptionAndBribery**

|                   |   |
|-------------------|---|
| <p>diagram</p>    |   |
| <p>type</p>       | <p><a href="#">PercentageStrategyCoverageType1.1</a></p>  |
| <p>properties</p> | <p>isRef 0<br/>minOcc 0<br/>maxOcc 1<br/>content complex</p>  |
| <p>children</p>   | <p><a href="#">Value</a> <a href="#">CoveredInvestmentStrategy</a> <a href="#">Covered</a> <a href="#">EligibleAssets</a></p>   |
| <p>annotation</p> | <p>documentation<br/>Exposure_To_Companies_With_Cases_Of_Insufficient_Action_Taken_To_Address_Breaches_Of_Standards_Of_Anti_Corruption_And_Anti_Bribery (33120 - 33145)</p> |

element

**EETReportType1.1.2/PrincipalAdverseIndicators/MoreSocialAndEmployeeMatters/CorruptionAndBribery/ConvictionsOfAntiCorruptionAndAntiBriberyLaws**

|                   |   |
|-------------------|---|
| <p>diagram</p>    |   |
| <p>type</p>       | <p><a href="#">ValueStrategyCoverageType1.1</a></p>   |
| <p>properties</p> | <p>isRef 0<br/>minOcc 0<br/>maxOcc 1<br/>content complex</p>  |
| <p>children</p>   | <p><a href="#">Value</a> <a href="#">ConsideredInInvestmentStrategy</a> <a href="#">Coverage</a> <a href="#">EligibleAssets</a></p> |
| <p>annotation</p> | <p>documentation<br/>Number_Of_Convictions_For_Violation_Of_Anti_Corruption_And_Anti_Bribery_Laws (33150 - 33180)</p>               |



element

**EETReportType1.1.2/PrincipalAdverseIndicators/MoreSocialAndEmployeeMatters/SovereignAndSupranationalInvestments**

|                   |   |
|-------------------|---|
| <p>diagram</p>    | <p>The diagram shows a class <b>SovereignAndSupranationalInv...</b> (ID 33190 - 33440) connected to a collection of seven subclasses:</p> <ul style="list-style-type: none"> <li><b>AverageIncomeInequalityScore</b> (ID 33190 - 33220)</li> <li><b>AverageFreedomOfExpression...</b> (ID 33230 - 33260)</li> <li><b>AverageHumanRightsPerforma...</b> (ID 33265 - 33290)</li> <li><b>AverageCorruptionScore</b> (ID 33295 - 33320)</li> <li><b>NonCooperativeTaxJurisdictions</b> (ID 33330 - 33360)</li> <li><b>AveragePoliticalStabilityScore</b> (ID 33370 - 33400)</li> <li><b>AverageRuleOfLawScore</b> (ID 33410 - 33440)</li> </ul> |
| <p>properties</p> | <p>isRef 0<br/> minOcc 0<br/> maxOcc 1<br/> content complex</p>   |
| <p>children</p>   | <p><a href="#">AverageIncomeInequalityScore</a> <a href="#">AverageFreedomOfExpressionScore</a> <a href="#">AverageHumanRightsPerformance</a><br/> <a href="#">AverageCorruptionScore</a> <a href="#">NonCooperativeTaxJurisdictions</a> <a href="#">AveragePoliticalStabilityScore</a> <a href="#">AverageRuleOfLawScore</a></p>   |
| <p>annotation</p> | <p>documentation<br/> 33190 - 33440</p>   |

element

### EETReportType1.1.2/PrincipalAdverseIndicators/MoreSocialAndEmployeeMatters/SovereignAndSupranationalInvestments/AverageIncomeInequalityScore

|            |  |
|------------|--|
| diagram    |  |
| type       | <a href="#">ValueStrategyCoverageType1.1</a>   |
| properties | isRef 0<br>minOcc 0<br>maxOcc 1<br>content complex   |
| children   | <a href="#">Value</a> <a href="#">ConsideredInInvestmentStrategy</a> <a href="#">Coverage</a> <a href="#">EligibleAssets</a> |
| annotation | documentation<br>Average_Income_Inequality_Score (33190 - 33220)   |

element

### EETReportType1.1.2/PrincipalAdverseIndicators/MoreSocialAndEmployeeMatters/SovereignAndSupranationalInvestments/AverageFreedomOfExpressionScore

|         |  |
|---------|--|
| diagram |  |
|---------|--|

|            |  |
|------------|--|
| type       | <a href="#">ValueStrategyCoverageType1.1</a>   |
| properties | isRef 0<br>minOcc 0<br>maxOcc 1<br>content complex   |
| children   | <a href="#">Value</a> <a href="#">ConsideredInInvestmentStrategy</a> <a href="#">Coverage</a> <a href="#">EligibleAssets</a> |
| annotation | documentation<br>Average_Freedom_of_Expression_Score (33230 - 33260)   |

element

**EETReportType1.1.2/PrincipalAdverseIndicators/MoreSocialAndEmployeeMatters/SovereignAndSupranationalInvestments/AverageHumanRightsPerformance**

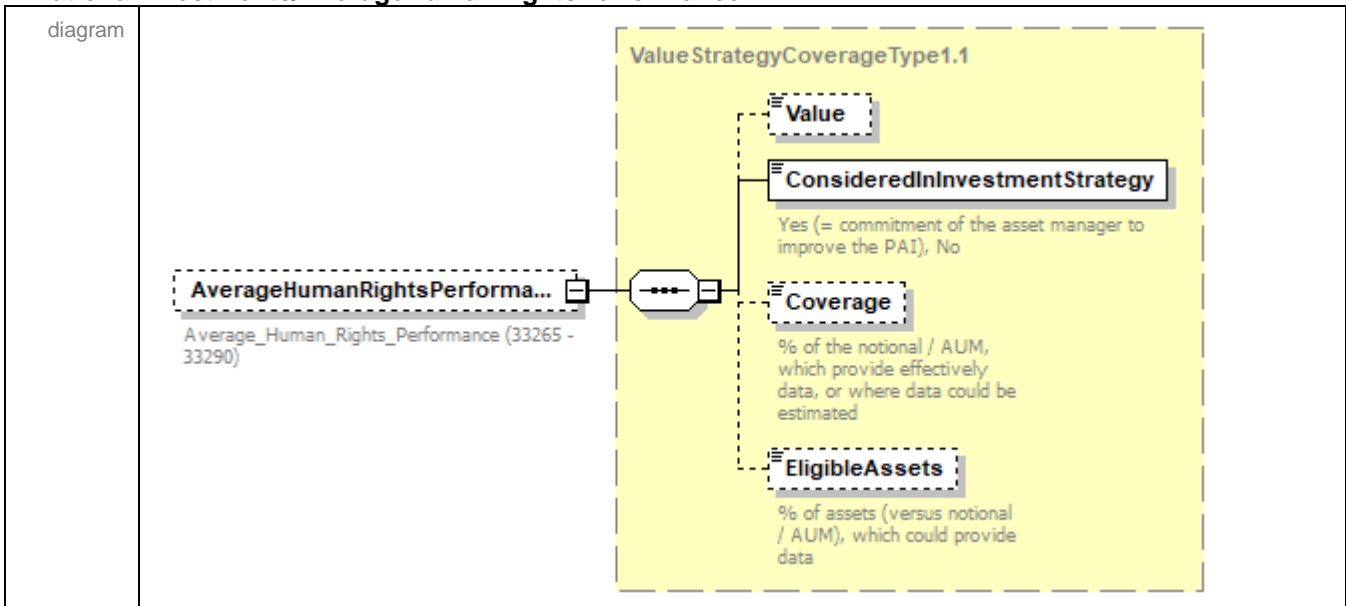

|            |  |
|------------|--|
| type       | <a href="#">ValueStrategyCoverageType1.1</a>   |
| properties | isRef 0<br>minOcc 0<br>maxOcc 1<br>content complex   |
| children   | <a href="#">Value</a> <a href="#">ConsideredInInvestmentStrategy</a> <a href="#">Coverage</a> <a href="#">EligibleAssets</a> |
| annotation | documentation<br>Average_Human_Rights_Performance (33265 - 33290)  |

element

### EETReportType1.1.2/PrincipalAdverseIndicators/MoreSocialAndEmployeeMatters/SovereignAndSupranationalInvestments/AverageCorruptionScore

|            |  |
|------------|--|
| diagram    |  |
| type       | <a href="#">ValueStrategyCoverageType1.1</a>   |
| properties | isRef 0<br>minOcc 0<br>maxOcc 1<br>content complex   |
| children   | <a href="#">Value</a> <a href="#">ConsideredInInvestmentStrategy</a> <a href="#">Coverage</a> <a href="#">EligibleAssets</a> |
| annotation | documentation<br>Average_Corruption_Score (33295 - 33320)  |

element

### EETReportType1.1.2/PrincipalAdverseIndicators/MoreSocialAndEmployeeMatters/SovereignAndSupranationalInvestments/NonCooperativeTaxJurisdictions

|         |  |
|---------|--|
| diagram |  |
|---------|--|

|            |  |
|------------|--|
| type       | <a href="#">ValueStrategyCoverageType1.1</a>   |
| properties | isRef 0<br>minOcc 0<br>maxOcc 1<br>content complex   |
| children   | <a href="#">Value</a> <a href="#">ConsideredInInvestmentStrategy</a> <a href="#">Coverage</a> <a href="#">EligibleAssets</a> |
| annotation | documentation<br>Non_Cooperative_Tax_Jurisdictions (33330 - 33360)   |

element

**EETReportType1.1.2/PrincipalAdverseIndicators/MoreSocialAndEmployeeMatters/SovereignAndSupranationalInvestments/AveragePoliticalStabilityScore**

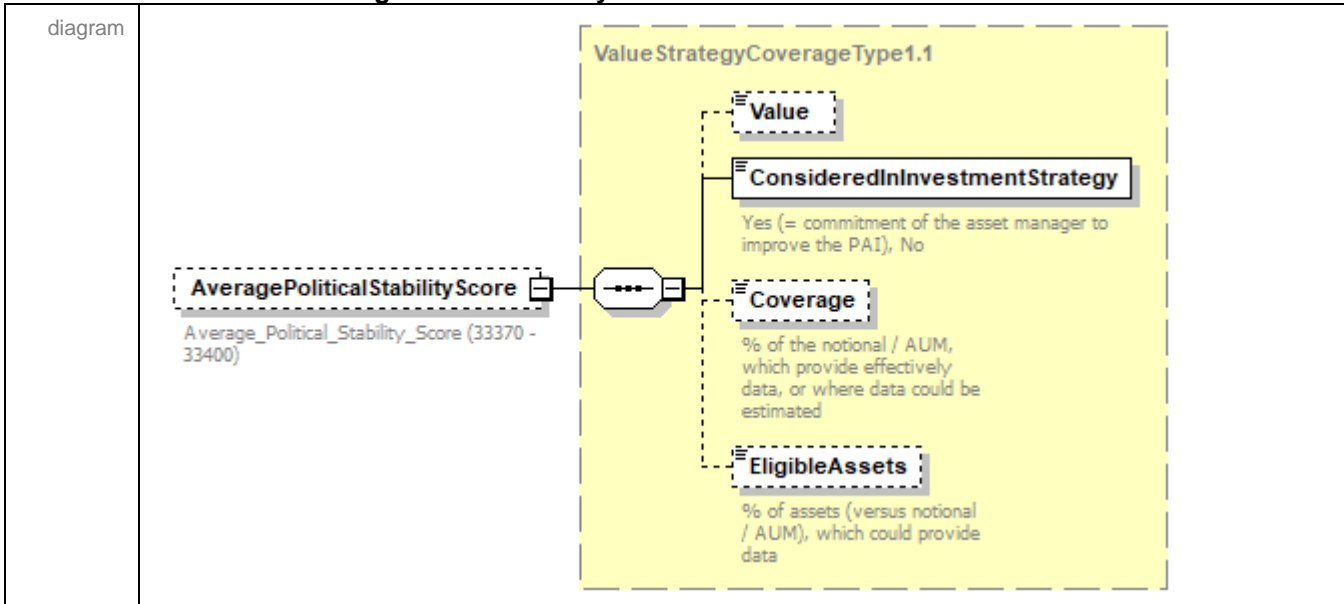

|            |  |
|------------|--|
| type       | <a href="#">ValueStrategyCoverageType1.1</a>   |
| properties | isRef 0<br>minOcc 0<br>maxOcc 1<br>content complex   |
| children   | <a href="#">Value</a> <a href="#">ConsideredInInvestmentStrategy</a> <a href="#">Coverage</a> <a href="#">EligibleAssets</a> |
| annotation | documentation<br>Average_Political_Stability_Score (33370 - 33400)   |

element

**EETReportType1.1.2/PrincipalAdverseIndicators/MoreSocialAndEmployeeMatters/SovereignAndSupranationalInvestments/AverageRuleOfLawScore**

|                   |   |
|-------------------|---|
| <p>diagram</p>    |   |
| <p>type</p>       | <p><a href="#">ValueStrategyCoverageType1.1</a></p>   |
| <p>properties</p> | <p>isRef 0<br/>minOcc 0<br/>maxOcc 1<br/>content complex</p>  |
| <p>children</p>   | <p><a href="#">Value</a> <a href="#">ConsideredInInvestmentStrategy</a> <a href="#">Coverage</a> <a href="#">EligibleAssets</a></p> |
| <p>annotation</p> | <p>documentation<br/>Average_Rule_Of_Law_Score (33410 - 33440)</p>  |

element **EETReportType1.1.2/ScreeningCriteria**

|            |  |
|------------|--|
| diagram    |  |
| properties | isRef 0<br>minOcc 0<br>maxOcc 1<br>content complex   |
| children   | <a href="#">ExistingNegativeScreeningStrategy</a> <a href="#">LinkToExclusionPolicyAndCriteria</a> <a href="#">SectorsBasedExclusions</a><br><a href="#">NormBasedExclusions</a> <a href="#">SovereignLevelExclusions</a> <a href="#">RealEstateExclusions</a> |
| annotation | documentation<br>40000 - 54070   |

element **EETReportType1.1.2/ScreeningCriteria/ExistingNegativeScreeningStrategy**

|            |  |
|------------|--|
| diagram    |  |
| type       | <a href="#">EETYesNoType</a>   |
| properties | isRef 0<br>minOcc 0<br>maxOcc 1<br>content simple  |
| facets     | Kind Value annotation<br>length 1  |
| annotation | documentation<br>40000_Financial_Instrument_Existing_Negative_Screening_Strategy<br>Yes / No |

element **EETReportType1.1.2/ScreeningCriteria/LinkToExclusionPolicyAndCriteria**

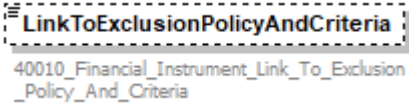
|            |   |
|------------|---|
| diagram    |  <p>40010_Financial_Instrument_Link_To_Exclusion_Policy_And_Criteria</p> |
| type       | <b>xs:anyURI</b>  |
| properties | isRef 0<br>minOcc 0<br>maxOcc 1<br>content simple   |
| annotation | documentation<br>40010_Financial_Instrument_Link_To_Exclusion_Policy_And_Criteria   |



element **EETReportType1.1.2/ScreeningCriteria/SectorsBasedExclusions**

diagram



|            |   |
|------------|---|
| properties | isRef 0<br>minOcc 0<br>maxOcc 1<br>content complex  |
| children   | <a href="#">PornographyAdultEntertainmentServicesExclusion</a> <a href="#">AlcoholExclusion</a> <a href="#">AnimalTestingExclusion</a> <a href="#">CannabisExclusion</a> <a href="#">ConventionalWeaponsExclusion</a> <a href="#">CoalExclusion</a> <a href="#">FactoryFarmingExclusion</a> <a href="#">FurExclusion</a> <a href="#">GamblingExclusion</a> <a href="#">GasExclusion</a> <a href="#">GeneticEngineeringExclusion</a> <a href="#">GeneticallyModifiedOrganismsExclusion</a> <a href="#">NuclearEnergyExclusion</a> <a href="#">NuclearWeaponsExclusion</a> <a href="#">OilExclusion</a> <a href="#">OtherFossilFuelExclusion</a> <a href="#">PalmOilExclusion</a> <a href="#">PesticidesExclusion</a> <a href="#">ResearchOnHumanEmbryosExclusion</a> <a href="#">TobaccoExclusion</a> <a href="#">UnconventionalWeaponsExclusion</a> |
| annotation | documentation<br>50100 - 52130  |

element

**EETReportType1.1.2/ScreeningCriteria/SectorsBasedExclusions/PornographyAdultEntertainmentServicesExclusion**

|            |   |
|------------|---|
| diagram    | <p>The diagram illustrates the relationship between the <b>PornographyAdultEntertainmentServicesExclusion</b> (ID: 50100 - 50130) and the <b>EETExclusionType1.1</b> class. The exclusion is represented by a dashed box on the left, connected to the EETExclusionType1.1 class on the right. The EETExclusionType1.1 class is shown in a yellow dashed box and contains the following attributes:     <ul style="list-style-type: none"> <li><b>Applied</b>: Yes (Y) or No (N)</li> <li><b>ThresholdType</b>: Revenue (R) or CaPEX (C) or Opex (O)</li> <li><b>RelativeThreshold</b></li> <li><b>PartOfValueChain</b>: 0..∞, Upstream/Production/Downstream</li> </ul> </p> |
| type       | <a href="#">EETExclusionType1.1</a>   |
| properties | isRef 0<br>minOcc 0<br>maxOcc 1<br>content complex  |
| children   | <a href="#">Applied</a> <a href="#">ThresholdType</a> <a href="#">RelativeThreshold</a> <a href="#">PartOfValueChain</a>  |
| annotation | documentation<br>50100 - 50130  |

element **EETReportType1.1.2/ScreeningCriteria/SectorsBasedExclusions/AlcoholExclusion**

|            |  |
|------------|--|
| diagram    |  |
| type       | <a href="#">EETExclusionType1.1</a>  |
| properties | isRef 0<br>minOcc 0<br>maxOcc 1<br>content complex   |
| children   | <a href="#">Applied</a> <a href="#">ThresholdType</a> <a href="#">RelativeThreshold</a> <a href="#">PartOfValueChain</a> |
| annotation | documentation<br>50200 - 50230   |

element **EETReportType1.1.2/ScreeningCriteria/SectorsBasedExclusions/AnimalTestingExclusion**

|            |  |
|------------|--|
| diagram    |  |
| type       | <a href="#">EETExclusionType1.1</a>  |
| properties | isRef 0<br>minOcc 0<br>maxOcc 1<br>content complex   |
| children   | <a href="#">Applied</a> <a href="#">ThresholdType</a> <a href="#">RelativeThreshold</a> <a href="#">PartOfValueChain</a> |
| annotation | documentation<br>50300 - 50330   |

element **EETReportType1.1.2/ScreeningCriteria/SectorsBasedExclusions/CannabisExclusion**

|            |  |
|------------|--|
| diagram    |  |
| type       | <a href="#">EETExclusionType1.1</a>  |
| properties | isRef 0<br>minOcc 0<br>maxOcc 1<br>content complex   |
| children   | <a href="#">Applied</a> <a href="#">ThresholdType</a> <a href="#">RelativeThreshold</a> <a href="#">PartOfValueChain</a> |
| annotation | documentation<br>50400 - 50430   |

element **EETReportType1.1.2/ScreeningCriteria/SectorsBasedExclusions/ConventionalWeaponsExclusion**

|            |                                     |
|------------|-------------------------------------|
| diagram    |                                     |
| type       | <a href="#">EETExclusionType1.1</a> |
| properties | isRef 0<br>minOcc 0<br>maxOcc 1     |

|            |  |
|------------|--|
|            | content complex  |
| children   | <a href="#">Applied</a> <a href="#">ThresholdType</a> <a href="#">RelativeThreshold</a> <a href="#">PartOfValueChain</a> |
| annotation | documentation<br>50500 - 50530   |

element **EETReportType1.1.2/ScreeningCriteria/SectorsBasedExclusions/CoalExclusion**

|            |   |
|------------|---|
| diagram    | <p>The diagram illustrates the structure of the <b>EETEnhancedExclusionType1.1</b> element. It is a complex type that contains several sub-elements: <b>Applied</b> (Yes (Y) or No (N)), <b>ThresholdType</b> (Revenue (R) or CaPEX (C) or Opex (O)), <b>RelativeThreshold</b>, <b>PartOfValueChain</b> (Upstream/Production/Downs tream), <b>EnergyMixAbsoluteCap</b>, <b>EnergyMixRelativeCap</b>, and <b>NewInfrastructure</b> (Yes (Y) or No (N)). The <b>CoalExclusion</b> element (50600 - 50660) is shown as a separate class that is associated with <b>EETEnhancedExclusionType1.1</b> via a composition relationship.</p> |
| type       | <a href="#">EETEnhancedExclusionType1.1</a>   |
| properties | isRef 0<br>minOcc 0<br>maxOcc 1<br>content complex  |
| children   | <a href="#">Applied</a> <a href="#">ThresholdType</a> <a href="#">RelativeThreshold</a> <a href="#">PartOfValueChain</a> <a href="#">EnergyMixAbsoluteCap</a> <a href="#">EnergyMixRelativeCap</a> <a href="#">NewInfrastructure</a>  |
| annotation | documentation<br>50600 - 50660  |

element **EETReportType1.1.2/ScreeningCriteria/SectorsBasedExclusions/FactoryFarmingExclusion**

|            |  |
|------------|--|
| diagram    |  |
| type       | <a href="#">EETExclusionType1.1</a>  |
| properties | isRef 0<br>minOcc 0<br>maxOcc 1<br>content complex   |
| children   | <a href="#">Applied</a> <a href="#">ThresholdType</a> <a href="#">RelativeThreshold</a> <a href="#">PartOfValueChain</a> |
| annotation | documentation<br>50700 - 50730   |

element **EETReportType1.1.2/ScreeningCriteria/SectorsBasedExclusions/FurExclusion**

|            |  |
|------------|--|
| diagram    |  |
| type       | <a href="#">EETExclusionType1.1</a>  |
| properties | isRef 0<br>minOcc 0<br>maxOcc 1<br>content complex   |
| children   | <a href="#">Applied</a> <a href="#">ThresholdType</a> <a href="#">RelativeThreshold</a> <a href="#">PartOfValueChain</a> |
| annotation | documentation<br>50800 - 50830   |

element **EETReportType1.1.2/ScreeningCriteria/SectorsBasedExclusions/GamblingExclusion**

|                   |  |
|-------------------|--|
| <p>diagram</p>    | <pre> classDiagram     class GamblingExclusion {         50900 - 50930     }     class EETExclusionType1.1 {         50900 - 50930         Applied : Yes (Y) or No (N)         ThresholdType : Revenue (R) or CaPEX (C) or Opex (O)         RelativeThreshold         PartOfValueChain : 0..∞, Upstream/Production/Downstream     }     GamblingExclusion "1" *-- "1" EETExclusionType1.1     </pre> |
| <p>type</p>       | <p><a href="#">EETExclusionType1.1</a></p>   |
| <p>properties</p> | <p>isRef 0<br/> minOcc 0<br/> maxOcc 1<br/> content complex</p>  |
| <p>children</p>   | <p><a href="#">Applied</a> <a href="#">ThresholdType</a> <a href="#">RelativeThreshold</a> <a href="#">PartOfValueChain</a></p>  |
| <p>annotation</p> | <p>documentation<br/> 50900 - 50930</p>  |



element **EETReportType1.1.2/ScreeningCriteria/SectorsBasedExclusions/GasExclusion**

|                   |   |
|-------------------|---|
| <p>diagram</p>    |   |
| <p>type</p>       | <p><a href="#">EETEnhancedExclusionType1.1</a></p>  |
| <p>properties</p> | <p>isRef 0<br/>minOcc 0<br/>maxOcc 1<br/>content complex</p>  |
| <p>children</p>   | <p><a href="#">Applied</a> <a href="#">ThresholdType</a> <a href="#">RelativeThreshold</a> <a href="#">PartOfValueChain</a> <a href="#">EnergyMixAbsoluteCap</a> <a href="#">EnergyMixRelativeCap</a> <a href="#">NewInfrastructure</a></p> |
| <p>annotation</p> | <p>documentation<br/>51000 - 51060</p>  |

element **EETReportType1.1.2/ScreeningCriteria/SectorsBasedExclusions/GeneticEngineeringExclusion**

|                |  |
|----------------|--|
| <p>diagram</p> |  |
|----------------|--|

|            |  |
|------------|--|
| type       | <a href="#">EETExclusionType1.1</a>  |
| properties | isRef 0<br>minOcc 0<br>maxOcc 1<br>content complex   |
| children   | <a href="#">Applied</a> <a href="#">ThresholdType</a> <a href="#">RelativeThreshold</a> <a href="#">PartOfValueChain</a> |
| annotation | documentation<br>51100 - 51130   |

element

**EETReportType1.1.2/ScreeningCriteria/SectorsBasedExclusions/GeneticallyModifiedOrganismsExclusion**

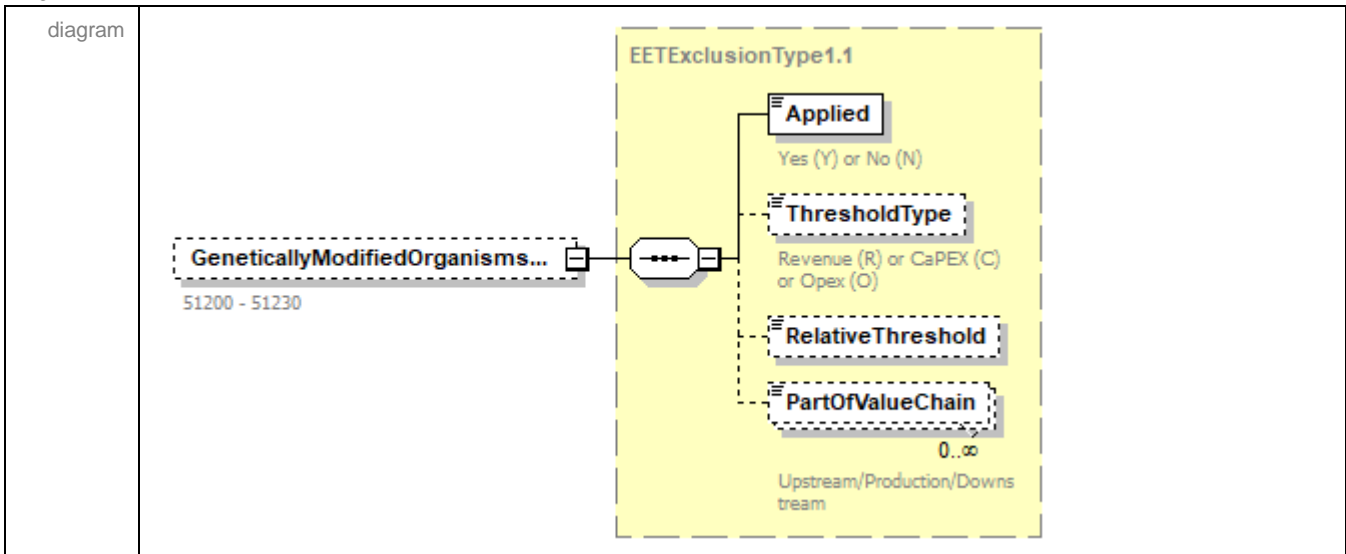

|            |  |
|------------|--|
| type       | <a href="#">EETExclusionType1.1</a>  |
| properties | isRef 0<br>minOcc 0<br>maxOcc 1<br>content complex   |
| children   | <a href="#">Applied</a> <a href="#">ThresholdType</a> <a href="#">RelativeThreshold</a> <a href="#">PartOfValueChain</a> |
| annotation | documentation<br>51200 - 51230   |

element **EETReportType1.1.2/ScreeningCriteria/SectorsBasedExclusions/NuclearEnergyExclusion**

|            |  |
|------------|--|
| diagram    |  |
| type       | <a href="#">EETExclusionType1.1</a>  |
| properties | isRef 0<br>minOcc 0<br>maxOcc 1<br>content complex   |
| children   | <a href="#">Applied</a> <a href="#">ThresholdType</a> <a href="#">RelativeThreshold</a> <a href="#">PartOfValueChain</a> |
| annotation | documentation<br>51300 - 51330   |

element **EETReportType1.1.2/ScreeningCriteria/SectorsBasedExclusions/NuclearWeaponsExclusion**

|            |  |
|------------|--|
| diagram    |  |
| type       | <a href="#">EETExclusionType1.1</a>  |
| properties | isRef 0<br>minOcc 0<br>maxOcc 1<br>content complex   |
| children   | <a href="#">Applied</a> <a href="#">ThresholdType</a> <a href="#">RelativeThreshold</a> <a href="#">PartOfValueChain</a> |
| annotation | documentation<br>51400 - 51430   |

element **EETReportType1.1.2/ScreeningCriteria/SectorsBasedExclusions/OilExclusion**

|                   |   |
|-------------------|---|
| <p>diagram</p>    | <p>The diagram illustrates the structure of the <b>OilExclusion</b> element (ID 51500 - 51560). It is associated with the <b>EETEnhancedExclusionType1.1</b> type. The <b>OilExclusion</b> class has a 1-to-many relationship with <b>EETEnhancedExclusionType1.1</b>. The <b>EETEnhancedExclusionType1.1</b> type includes the following attributes:</p> <ul style="list-style-type: none"> <li><b>Applied</b>: Yes (Y) or No (N)</li> <li><b>ThresholdType</b>: Revenue (R) or CaPEX (C) or Opex (O)</li> <li><b>RelativeThreshold</b></li> <li><b>PartOfValueChain</b>: Upstream/Production/Downstream</li> <li><b>EnergyMixAbsoluteCap</b></li> <li><b>EnergyMixRelativeCap</b></li> <li><b>NewInfrastructure</b>: Yes (Y) or No (N)</li> </ul> |
| <p>type</p>       | <p><a href="#">EETEnhancedExclusionType1.1</a></p>  |
| <p>properties</p> | <p>isRef 0<br/>minOcc 0<br/>maxOcc 1<br/>content complex</p>  |
| <p>children</p>   | <p><a href="#">Applied</a> <a href="#">ThresholdType</a> <a href="#">RelativeThreshold</a> <a href="#">PartOfValueChain</a> <a href="#">EnergyMixAbsoluteCap</a> <a href="#">EnergyMixRelativeCap</a> <a href="#">NewInfrastructure</a></p>   |
| <p>annotation</p> | <p>documentation<br/>51500 - 51560</p>  |

element **EETReportType1.1.2/ScreeningCriteria/SectorsBasedExclusions/OtherFossilFuelExclusion**

|            |  |
|------------|--|
| diagram    |  |
| type       | <a href="#">EETEnhancedExclusionType1.1</a>  |
| properties | <p>isRef 0<br/> minOcc 0<br/> maxOcc 1<br/> content complex</p>  |
| children   | <a href="#">Applied</a> <a href="#">ThresholdType</a> <a href="#">RelativeThreshold</a> <a href="#">PartOfValueChain</a> <a href="#">EnergyMixAbsoluteCap</a> <a href="#">EnergyMixRelativeCap</a> <a href="#">NewInfrastructure</a> |
| annotation | documentation<br>51600 - 51660   |

element **EETReportType1.1.2/ScreeningCriteria/SectorsBasedExclusions/PalmOilExclusion**

|         |  |
|---------|--|
| diagram |  |
|---------|--|

|            |  |
|------------|--|
| type       | <a href="#">EETExclusionType1.1</a>  |
| properties | isRef 0<br>minOcc 0<br>maxOcc 1<br>content complex   |
| children   | <a href="#">Applied</a> <a href="#">ThresholdType</a> <a href="#">RelativeThreshold</a> <a href="#">PartOfValueChain</a> |
| annotation | documentation<br>51700 - 51730   |

element **EETReportType1.1.2/ScreeningCriteria/SectorsBasedExclusions/PesticidesExclusion**

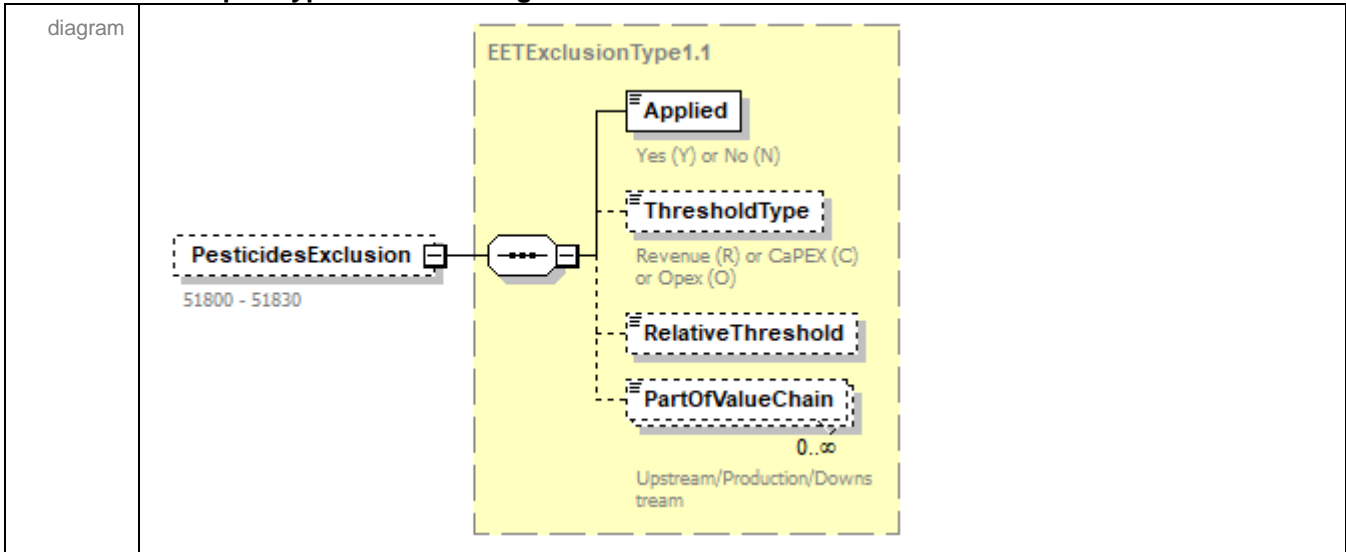

|            |  |
|------------|--|
| type       | <a href="#">EETExclusionType1.1</a>  |
| properties | isRef 0<br>minOcc 0<br>maxOcc 1<br>content complex   |
| children   | <a href="#">Applied</a> <a href="#">ThresholdType</a> <a href="#">RelativeThreshold</a> <a href="#">PartOfValueChain</a> |
| annotation | documentation<br>51800 - 51830   |

element

**EETReportType1.1.2/ScreeningCriteria/SectorsBasedExclusions/ResearchOnHumanEmbryosExclusion**

|                   |   |
|-------------------|---|
| <p>diagram</p>    |   |
| <p>type</p>       | <p><a href="#">EETExclusionType1.1</a></p>  |
| <p>properties</p> | <p>isRef 0<br/>minOcc 0<br/>maxOcc 1<br/>content complex</p>  |
| <p>children</p>   | <p><a href="#">Applied</a> <a href="#">ThresholdType</a> <a href="#">RelativeThreshold</a> <a href="#">PartOfValueChain</a></p> |
| <p>annotation</p> | <p>documentation<br/>51900 - 51930</p>  |

element **EETReportType1.1.2/ScreeningCriteria/SectorsBasedExclusions/TobaccoExclusion**

|                   |   |
|-------------------|---|
| <p>diagram</p>    |   |
| <p>type</p>       | <p><a href="#">EETExclusionType1.1</a></p>  |
| <p>properties</p> | <p>isRef 0<br/>minOcc 0<br/>maxOcc 1<br/>content complex</p>  |
| <p>children</p>   | <p><a href="#">Applied</a> <a href="#">ThresholdType</a> <a href="#">RelativeThreshold</a> <a href="#">PartOfValueChain</a></p> |

|            |                                |
|------------|--------------------------------|
| annotation | documentation<br>52000 - 52030 |
|------------|--------------------------------|

element

**EETReportType1.1.2/ScreeningCriteria/SectorsBasedExclusions/UnconventionalWeaponsExclusion**

|            |  |
|------------|--|
| diagram    |  |
| type       | <a href="#">EETExclusionType1.1</a>  |
| properties | isRef 0<br>minOcc 0<br>maxOcc 1<br>content complex   |
| children   | <a href="#">Applied</a> <a href="#">ThresholdType</a> <a href="#">RelativeThreshold</a> <a href="#">PartOfValueChain</a> |
| annotation | documentation<br>52100 - 52130   |

element **EETReportType1.1.2/ScreeningCriteria/NormBasedExclusions**

|            |  |
|------------|--|
| diagram    |  |
| properties | isRef 0<br>minOcc 0<br>maxOcc 1<br>content complex   |
| children   | <a href="#">UNGC_Exclusion</a> <a href="#">OECD_Guidelines_Exclusion</a> <a href="#">ILO_Exclusion</a> |
| annotation | documentation<br>52200 - 52220   |

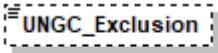

element **EETReportType1.1.2/ScreeningCriteria/NormBasedExclusions/UNGC\_Exclusion**

|            |   |
|------------|---|
| diagram    |  <p>52200_Financial_Instrument<br/>_UNGC_Exclusion</p> |
| type       | <a href="#">EETYesNoType</a>  |
| properties | isRef 0<br>minOcc 0<br>maxOcc 1<br>content simple   |
| facets     | Kind Value annotation<br>length 1   |
| annotation | documentation<br>52200_Financial_Instrument_UNGC_Exclusion  |

element **EETReportType1.1.2/ScreeningCriteria/NormBasedExclusions/OECD\_Guidelines\_Exclusion**

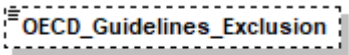
|            |  |
|------------|--|
| diagram    |  <p>52210_Financial_Instrument_OECD_G<br/>uidelines_Exclusion</p> |
| type       | <a href="#">EETYesNoType</a>   |
| properties | isRef 0<br>minOcc 0<br>maxOcc 1<br>content simple  |
| facets     | Kind Value annotation<br>length 1  |
| annotation | documentation<br>52210_Financial_Instrument_OECD_Guidelines_Exclusion  |

element **EETReportType1.1.2/ScreeningCriteria/NormBasedExclusions/ILO\_Exclusion**

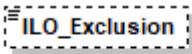
|            |  |
|------------|--|
| diagram    |  <p>52220_Financial_Instrument<br/>_ILO_Exclusion</p> |
| type       | <a href="#">EETYesNoType</a>   |
| properties | isRef 0<br>minOcc 0<br>maxOcc 1<br>content simple  |
| facets     | Kind Value annotation<br>length 1  |
| annotation | documentation<br>52220_Financial_Instrument_ILO_Exclusion  |

element **EETReportType1.1.2/ScreeningCriteria/SovereignLevelExclusions**

|            |  |
|------------|--|
| diagram    | <p>The diagram shows a container element <b>SovereignLevelExclusions</b> (ID: 53000 - 53060) connected to seven sub-exclusion elements:</p> <ul style="list-style-type: none"> <li><b>NuclearWeaponsExclusion</b> (53000_Financial_Instrument_Nuclear_Weapons_Exclusion)</li> <li><b>NonProliferationTreatyOfNuclear...</b> (53010_Financial_Instrument_Non-proliferation_Treaty_Of_Nuclear_Weapons)</li> <li><b>QualitativeExclusionOfCountries</b> (53020_Financial_Instrument_Qualitative_Exc_lusion_Of_Countries: A - Freedomhouse, I - Internal method, N - None)</li> <li><b>CorruptionExclusion</b> (53030_Financial_Instrument_Corruption_Exclusion)</li> <li><b>DeathSentenceExclusion</b> (53040_Financial_Instrument_Death_Sentence_Exclusion)</li> <li><b>WarExclusion</b> (53050_Financial_Instrument_War_Exclusion)</li> <li><b>NonRatificationOfParisAgreeme...</b> (53060_Financial_Instrument_Non_Ratification_Of_Paris_Agreement_Exclusion)</li> </ul> |
| properties | <p>isRef 0<br/> minOcc 0<br/> maxOcc 1<br/> content complex</p>  |
| children   | <p><a href="#">NuclearWeaponsExclusion</a> <a href="#">NonProliferationTreatyOfNuclearWeapons</a> <a href="#">QualitativeExclusionOfCountries</a> <a href="#">CorruptionExclusion</a> <a href="#">DeathSentenceExclusion</a> <a href="#">WarExclusion</a> <a href="#">NonRatificationOfParisAgreementExclusion</a></p>   |
| annotation | <p>documentation<br/> 53000 - 53060</p>  |

element **EETReportType1.1.2/ScreeningCriteria/SovereignLevelExclusions/NuclearWeaponsExclusion**

|            |   |
|------------|---|
| diagram    | <p>The diagram shows the <b>NuclearWeaponsExclusion</b> element (ID: 53000_Financial_Instrument_Nuclear_Weapons_Exclusion).</p> |
| type       | <p><a href="#">EETYesNoType</a></p>   |
| properties | <p>isRef 0<br/> minOcc 0<br/> maxOcc 1<br/> content simple</p>  |
| facets     | <p>Kind Value annotation<br/> length 1</p>  |
| annotation | <p>documentation<br/> 53000_Financial_Instrument_Nuclear_Weapons_Exclusion</p>  |

element

**EETReportType1.1.2/ScreeningCriteria/SovereignLevelExclusions/NonProliferationTreatyOfNuclearWeapons**

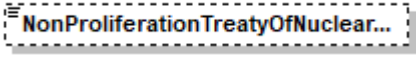
|            |   |
|------------|---|
| diagram    | <br>53010_Financial_Instrument_Non-proliferation_Treaty_Of_Nuclear_Weapons |
| type       | <a href="#">EETYesNoType</a>  |
| properties | isRef 0<br>minOcc 0<br>maxOcc 1<br>content simple   |
| facets     | Kind Value annotation<br>length 1   |
| annotation | documentation<br>53010_Financial_Instrument_Non-proliferation_Treaty_Of_Nuclear_Weapons   |

element

**EETReportType1.1.2/ScreeningCriteria/SovereignLevelExclusions/QualitativeExclusionOfCountries**

|            |   |
|------------|---|
| diagram    | <br>53020_Financial_Instrument_Qualitative_Exclusion_Of_Countries:<br>A- Freedomhouse<br>I - Internal method<br>N - None |
| type       | restriction of <b>xs:string</b>   |
| properties | isRef 0<br>minOcc 0<br>maxOcc 1<br>content simple   |
| annotation | documentation<br>53020_Financial_Instrument_Qualitative_Exclusion_Of_Countries:<br>A- Freedomhouse<br>I - Internal method<br>N - None   |

element **EETReportType1.1.2/ScreeningCriteria/SovereignLevelExclusions/CorruptionExclusion**

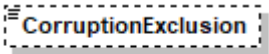
|            |  |
|------------|--|
| diagram    | <br>53030_Financial_Instrument_Corruption_Exclusion |
| type       | <a href="#">EETYesNoType</a>   |
| properties | isRef 0<br>minOcc 0<br>maxOcc 1<br>content simple  |
| facets     | Kind Value annotation<br>length 1  |
| annotation | documentation<br>53030_Financial_Instrument_Corruption_Exclusion   |

element **EETReportType1.1.2/ScreeningCriteria/SovereignLevelExclusions/DeathSentenceExclusion**

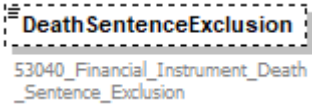
|            |  |
|------------|--|
| diagram    |  <p><b>DeathSentenceExclusion</b><br/>53040_Financial_Instrument_Death_Sentence_Exclusion</p> |
| type       | <a href="#">EETYesNoType</a>   |
| properties | isRef 0<br>minOcc 0<br>maxOcc 1<br>content simple  |
| facets     | Kind Value annotation<br>length 1  |
| annotation | documentation<br>53040_Financial_Instrument_Death_Sentence_Exclusion   |

element **EETReportType1.1.2/ScreeningCriteria/SovereignLevelExclusions/WarExclusion**

|            |   |
|------------|---|
| diagram    |  <p><b>WarExclusion</b><br/>53050_Financial_Instrument_War_Exclusion</p> |
| type       | <a href="#">EETYesNoType</a>  |
| properties | isRef 0<br>minOcc 0<br>maxOcc 1<br>content simple   |
| facets     | Kind Value annotation<br>length 1   |
| annotation | documentation<br>53050_Financial_Instrument_War_Exclusion   |

element **EETReportType1.1.2/ScreeningCriteria/SovereignLevelExclusions/NonRatificationOfParisAgreementExclusion**

|            |   |
|------------|---|
| diagram    |  <p><b>NonRatificationOfParisAgreementExclusion</b><br/>53060_Financial_Instrument_Non_Ratification_Of_Paris_Agreement_Exclusion</p> |
| type       | <a href="#">EETYesNoType</a>  |
| properties | isRef 0<br>minOcc 0<br>maxOcc 1<br>content simple   |
| facets     | Kind Value annotation<br>length 1   |
| annotation | documentation<br>53060_Financial_Instrument_Non_Ratification_Of_Paris_Agreement_Exclusion   |

element **EETReportType1.1.2/ScreeningCriteria/RealEstateExclusions**

|                   |  |
|-------------------|--|
| <p>diagram</p>    | <p>The diagram shows a container element <b>RealEstateExclusions</b> (ID: 54000 - 54070) connected to seven sub-elements, each in a dashed box:</p> <ul style="list-style-type: none"> <li><b>EnergyConsumptionMonitoring</b> (54000_Financial_Instrument_ESG_Energy_Consumption_Monitoring)</li> <li><b>GreenhouseGasEmissionMonitoring</b> (54010_Financial_Instrument_ESG_GHG_Emission_Monitoring)</li> <li><b>WaterConsumptionMonitoring</b> (54020_Financial_Instrument_ESG_Water_Consumption_Monitoring)</li> <li><b>WasteFinancialInstrumentMonitoring</b> (54030_Financial_Instrument_ESG_Waste_Financial_Instrument_Monitoring)</li> <li><b>EnvironmentalHealthMonitoring</b> (54040_Financial_Instrument_ESG_Environmental_Health_Monitoring)</li> <li><b>SupplierMonitoring</b> (54050_Financial_Instrument_ESG_Supplier_Monitoring)</li> <li><b>SafetyMonitoring</b> (54060_Financial_Instrument_ESG_Safety_Monitoring)</li> <li><b>BiodiversityMonitoring</b> (54070_Financial_Instrument_ESG_Biodiversity_Monitoring)</li> </ul> |
| <p>properties</p> | <p>isRef 0<br/>minOcc 0<br/>maxOcc 1<br/>content complex</p>   |
| <p>children</p>   | <p><a href="#">EnergyConsumptionMonitoring</a> <a href="#">GreenhouseGasEmissionMonitoring</a> <a href="#">WaterConsumptionMonitoring</a> <a href="#">WasteFinancialInstrumentMonitoring</a> <a href="#">EnvironmentalHealthMonitoring</a> <a href="#">SupplierMonitoring</a> <a href="#">SafetyMonitoring</a> <a href="#">BiodiversityMonitoring</a></p>  |
| <p>annotation</p> | <p>documentation<br/>54000 - 54070</p>   |

element **EETReportType1.1.2/ScreeningCriteria/RealEstateExclusions/EnergyConsumptionMonitoring**

|                   |  |
|-------------------|--|
| <p>diagram</p>    | <p>The diagram shows a single element <b>EnergyConsumptionMonitoring</b> (ID: 54000_Financial_Instrument_ESG_Energy_Consumption_Monitoring) in a dashed box.</p> |
| <p>type</p>       | <p><a href="#">EETYesNoType</a></p>  |
| <p>properties</p> | <p>isRef 0<br/>minOcc 0<br/>maxOcc 1<br/>content simple</p>  |
| <p>facets</p>     | <p>Kind Value annotation<br/>length 1</p>  |

|            |   |
|------------|---|
| annotation | documentation<br>54000_Financial_Instrument_ESG_Energy_Consumption_Monitoring |
|------------|---|

element

**EETReportType1.1.2/ScreeningCriteria/RealEstateExclusions/GreenhouseGasEmissionMonitoring**

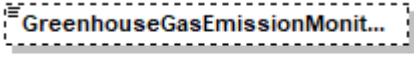
|            |   |
|------------|---|
| diagram    | <br>54010_Financial_Instrument_ESG_GHG_Emission_Monitoring |
| type       | <a href="#">EETYesNoType</a>  |
| properties | isRef 0<br>minOcc 0<br>maxOcc 1<br>content simple   |
| facets     | Kind Value annotation<br>length 1   |
| annotation | documentation<br>54010_Financial_Instrument_ESG_GHG_Emission_Monitoring   |

element **EETReportType1.1.2/ScreeningCriteria/RealEstateExclusions/WaterConsumptionMonitoring**

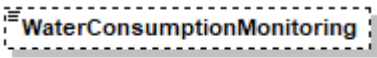
|            |  |
|------------|--|
| diagram    | <br>54020_Financial_Instrument_ESG_Water_Consumption_Monitoring |
| type       | <a href="#">EETYesNoType</a>   |
| properties | isRef 0<br>minOcc 0<br>maxOcc 1<br>content simple  |
| facets     | Kind Value annotation<br>length 1  |
| annotation | documentation<br>54020_Financial_Instrument_ESG_Water_Consumption_Monitoring   |

element

**EETReportType1.1.2/ScreeningCriteria/RealEstateExclusions/WasteFinancialInstrumentMonitoring**

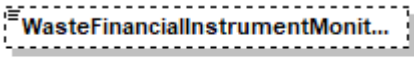
|            |   |
|------------|---|
| diagram    | <br>54030_Financial_Instrument_ESG_Waste_Financial_Instrument_Monitoring |
| type       | <a href="#">EETYesNoType</a>  |
| properties | isRef 0<br>minOcc 0<br>maxOcc 1<br>content simple   |
| facets     | Kind Value annotation<br>length 1   |
| annotation | documentation<br>54030_Financial_Instrument_ESG_Waste_Financial_Instrument_Monitoring   |

element **EETReportType1.1.2/ScreeningCriteria/RealEstateExclusions/EnvironmentalHealthMonitoring**

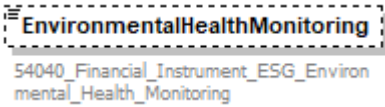
|            |   |
|------------|---|
| diagram    |  <p>54040_Financial_Instrument_ESG_Environmental_Health_Monitoring</p> |
| type       | <a href="#">EETYesNoType</a>  |
| properties | isRef 0<br>minOcc 0<br>maxOcc 1<br>content simple   |
| facets     | Kind Value annotation<br>length 1   |
| annotation | documentation<br>54040_Financial_Instrument_ESG_Environmental_Health_Monitoring   |

element **EETReportType1.1.2/ScreeningCriteria/RealEstateExclusions/SupplierMonitoring**

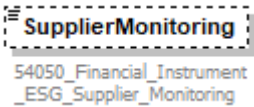
|            |   |
|------------|---|
| diagram    |  <p>54050_Financial_Instrument_ESG_Supplier_Monitoring</p> |
| type       | <a href="#">EETYesNoType</a>  |
| properties | isRef 0<br>minOcc 0<br>maxOcc 1<br>content simple   |
| facets     | Kind Value annotation<br>length 1   |
| annotation | documentation<br>54050_Financial_Instrument_ESG_Supplier_Monitoring   |

element **EETReportType1.1.2/ScreeningCriteria/RealEstateExclusions/SafetyMonitoring**

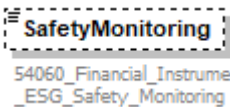
|            |   |
|------------|---|
| diagram    |  <p>54060_Financial_Instrument_ESG_Safety_Monitoring</p> |
| type       | <a href="#">EETYesNoType</a>  |
| properties | isRef 0<br>minOcc 0<br>maxOcc 1<br>content simple   |
| facets     | Kind Value annotation<br>length 1   |
| annotation | documentation<br>54060_Financial_Instrument_ESG_Safety_Monitoring   |

element **EETReportType1.1.2/ScreeningCriteria/RealEstateExclusions/BiodiversityMonitoring**

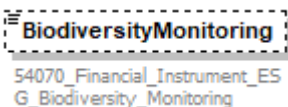
|         |   |
|---------|---|
| diagram |  <p>54070_Financial_Instrument_ESG_Biodiversity_Monitoring</p> |
| type    | <a href="#">EETYesNoType</a>  |

|            |   |
|------------|---|
| properties | isRef 0<br>minOcc 0<br>maxOcc 1<br>content simple                       |
| facets     | Kind Value annotation<br>length 1                                       |
| annotation | documentation<br>54070_Financial_Instrument_ESG_Biodiversity_Monitoring |

element **EETReportType1.1.2/CountrySpecificInformation**

|            |   |
|------------|---|
| diagram    | <p>The diagram shows a class <b>CountrySpecificInformation</b> (ID range 60400 - 60440) connected to two subclasses: <b>France</b> (ID range 60400 - 60430) and <b>Germany</b> (ID range 60440). The connection is represented by a solid line with an open arrowhead pointing to the superclass, indicating a generalization relationship.</p> |
| properties | isRef 0<br>minOcc 0<br>maxOcc 1<br>content complex  |
| children   | <a href="#">France</a> <a href="#">Germany</a>  |
| annotation | documentation<br>60400 - 60440  |



element **EETReportType1.1.2/CountrySpecificInformation/France**

|                   |   |
|-------------------|---|
| <p>diagram</p>    | <p><b>France</b><br/>60400 - 60430</p> <p><b>FrenchAMFDoctrineApproach</b><br/>60400_French_AMF_Doctrine_Approach:<br/>Which approach of the AMF position/recommendation 2020-03 does your fund comply with?<br/>1: Approach based on a significantly engaging methodology<br/>2: Non-significantly engaging methodology approach<br/>3: Approach not meeting central or limited communication standards</p> <p><b>EnvironmentalTopicOrConsideredIndicatorsForFrenchMiFIDMarket</b><br/>60410_Financial_Instrument_Environmental_Topic_Or_Considered_Indicators_For_French_MiFID_Market<br/>Description of the Environmental topics integrated in the investment process of the fund,<br/>Multiple answers field.<br/>A - Transition to low carbon economy<br/>B - Natural resources preservation or consumption<br/>C - Land and Ocean preservation<br/>D - Waste<br/>E - Biodiversity preservation<br/>F - none</p> <p><b>SocialTopicOrConsideredIndicatorsForFrenchMiFIDMarket</b><br/>60420_Financial_Instrument_Social_Topic_Or_Considered_Indicators_For_French_MiFID_Market:<br/>Description of the social topics integrated in the investment strategy,<br/>Multiple answers fields.<br/>A - Social and human rights<br/>B - labour relations<br/>C - investment in human capital (including health)<br/>D - none</p> <p><b>GovernanceTopicOrConsideredIndicatorsForFrenchMiFIDMarket</b><br/>60430_Financial_Instrument_Governance_Topic_Or_Considered_Indicators_For_French_MiFID_Market:<br/>Description of the governance topic integrated in the investment strategy,<br/>Multiple answers field<br/>A - anti bribery and corruption<br/>B - governance other<br/>C - none</p> |
| <p>properties</p> | <p>isRef 0<br/>minOcc 0<br/>maxOcc 1<br/>content complex</p>  |
| <p>children</p>   | <p><a href="#">FrenchAMFDoctrineApproach</a> <a href="#">EnvironmentalTopicOrConsideredIndicatorsForFrenchMiFIDMarket</a> <a href="#">SocialTopicOrConsideredIndicatorsForFrenchMiFIDMarket</a> <a href="#">GovernanceTopicOrConsideredIndicatorsForFrenchMiFIDMarket</a></p>   |

|            |   |
|------------|---|
|            | <a href="#">GovernanceTopicOrConsideredIndicatorsForFrenchMiFIDMarket</a> |
| annotation | documentation<br>60400 - 60430  |

element **EETReportType1.1.2/CountrySpecificInformation/France/FrenchAMFDoctrineApproach**

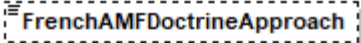
|            |  |
|------------|--|
| diagram    |  <p>60400_French_AMF_Doctrine_Approach:<br/>Which approach of the AMF position/recommendation 2020-03 does your fund comply with?<br/>1: Approach based on a significantly engaging methodology<br/>2: Non-significantly engaging methodology approach<br/>3: Approach not meeting central or limited communication standards</p> |
| type       | restriction of <b>xs:string</b>  |
| properties | isRef 0<br>minOcc 0<br>maxOcc 1<br>content simple  |
| annotation | documentation<br>60400_French_AMF_Doctrine_Approach:<br>Which approach of the AMF position/recommendation 2020-03 does your fund comply with?<br>1: Approach based on a significantly engaging methodology<br>2: Non-significantly engaging methodology approach<br>3: Approach not meeting central or limited communication standards   |

element **EETReportType1.1.2/CountrySpecificInformation/France/EnvironmentalTopicOrConsideredIndicators**

|            |   |
|------------|---|
| diagram    |  <p>0..∞</p> <p>60410_Financial_Instrument_Environmental_Topic_Or_Considered_Indicators_For_French_MiFID_Market<br/>Description of the Environmental topics integrated in the investment process of the fund.<br/>Multiple answers field.</p> <p>A - Transition to low carbon economy<br/>B - Natural resources preservation or consumption<br/>C - Land and Ocean preservation<br/>D - Waste<br/>E - Biodiversity preservation<br/>F - none</p> |
| type       | restriction of <b>xs:string</b>   |
| properties | isRef 0<br>minOcc 0<br>maxOcc unbounded<br>content simple   |
| annotation | documentation<br>60410_Financial_Instrument_Environmental_Topic_Or_Considered_Indicators_For_French_MiFID_Market<br>Description of the Environmental topics integrated in the investment process of the fund,<br>Multiple answers field.  |

|  |   |
|--|---|
|  | <p>A - Transition to low carbon economy<br/>         B - Natural resources preservation or consumption<br/>         C - Land and Ocean preservation<br/>         D - Waste<br/>         E - Biodiversity preservation<br/>         F - none</p> |
|--|---|

element

**EETReportType1.1.2/CountrySpecificInformation/France/SocialTopicOrConsideredIndicatorsForFrenchMiFIDMarket**

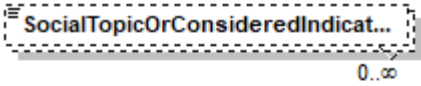
|            |  |
|------------|--|
| diagram    |  <p>60420_Financial_Instrument_Social_Topic_Or_Considered_Indicators_For_French_MiFID_Market:<br/>         Description of the social topics integrated in the investment strategy,<br/>         Multiple answers fields.</p> <p>A - Social and human rights<br/>         B - labour relations<br/>         C - investment in human capital (including health)<br/>         D - none</p> |
| type       | restriction of <b>xs:string</b>  |
| properties | <p>isRef 0<br/>         minOcc 0<br/>         maxOcc unbounded<br/>         content simple</p>   |
| annotation | <p>documentation<br/>         60420_Financial_Instrument_Social_Topic_Or_Considered_Indicators_For_French_MiFID_Market:<br/>         Description of the social topics integrated in the investment strategy,<br/>         Multiple answers fields.</p> <p>A - Social and human rights<br/>         B - labour relations<br/>         C - investment in human capital (including health)<br/>         D - none</p>  |

element

**EETReportType1.1.2/CountrySpecificInformation/France/GovernanceTopicOrConsideredIndicatorsForFrenchMiFIDMarket**

|         |   |
|---------|---|
| diagram |  <p>60430_Financial_Instrument_Governance_Topic_Or_Considered_Indicators_For_French_MiFID_Market:<br/>         Description of the governance topic integrated in the investment strategy,<br/>         Multiple answers field</p> <p>A - anti bribery and corruption<br/>         B - governance other<br/>         C - none</p> |
|---------|---|

|            |   |
|------------|---|
| type       | restriction of <b>xs:string</b>   |
| properties | isRef 0<br>minOcc 0<br>maxOcc unbounded<br>content simple   |
| annotation | documentation<br>60430_Financial_Instrument_Governance_Topic_Or_Considered_Indicators_For_French_MiFID_Market:<br>Description of the governance topic integrated in the investment strategy,<br>Multiple answers field<br>A - anti bribery and corruption<br>B - governance other<br>C - none |

element **EETReportType1.1.2/CountrySpecificInformation/Germany**

|            |  |
|------------|--|
| diagram    | <p>60440</p> <p>0..∞</p> <p>60440_Financial_Instrument_Sustainable_Indicators_For_German_MiFID_Market:<br/> O, B, E, P, Q, R, S, T, U or V</p> |
| properties | isRef 0<br>minOcc 0<br>maxOcc 1<br>content complex   |
| children   | <a href="#">SustainableIndicatorsForGermanMiFIDMarket</a>  |
| annotation | documentation<br>60440   |

element

**EETReportType1.1.2/CountrySpecificInformation/Germany/SustainableIndicatorsForGermanMiFIDMarket**

|            |   |
|------------|---|
| diagram    | <p>0..∞</p> <p>60440_Financial_Instrument_Sustainable_Indicators_For_German_MiFID_Market:<br/> O, B, E, P, Q, R, S, T, U or V</p> |
| type       | restriction of <b>xs:string</b>   |
| properties | isRef 0<br>minOcc 0<br>maxOcc unbounded<br>content simple   |
| annotation | documentation<br>60440_Financial_Instrument_Sustainable_Indicators_For_German_MiFID_Market:<br>O, B, E, P, Q, R, S, T, U or V     |

element **EETReportType1.1.2/SupplementaryFieldsV1.1**

|            |  |
|------------|--|
| diagram    | <p><b>SupplementaryFieldsV1.1</b><br/>70000-70010</p> <p><b>SustainabilityRisksDemedToBeRelevant</b><br/>70000_Financial_Instrument_Sustainability_Risk_Is_Deemed_To_Be_Relevant<br/>SFDR art 6.1<br/>Yes / No</p> <p><b>Financial_InstrumentTotalFundNAVOrNotional</b><br/>70010_Financial_Instrument_Total_Fund_NAV_Or_Notional<br/>NAV for a fund and Notional for structured products at PAI_Reference_Date in EUR</p> |
| properties | <p>isRef 0</p> <p>minOcc 0</p> <p>maxOcc 1</p> <p>content complex</p>  |
| children   | <p><a href="#">SustainabilityRisksDemedToBeRelevant</a> <a href="#">Financial_InstrumentTotalFundNAVOrNotional</a></p>   |
| annotation | <p>documentation<br/>70000-70010</p>   |

element **EETReportType1.1.2/SupplementaryFieldsV1.1/SustainabilityRisksDemedToBeRelevant**

|            |  |
|------------|--|
| diagram    | <p><b>SustainabilityRisksDemedToBeRelevant</b><br/>70000_Financial_Instrument_Sustainability_Risk_Is_Deemed_To_Be_Relevant<br/>SFDR art 6.1<br/>Yes / No</p> |
| type       | <p><a href="#">EETYesNoType</a></p>  |
| properties | <p>isRef 0</p> <p>minOcc 0</p> <p>maxOcc 1</p> <p>content simple</p>   |
| facets     | <p>Kind Value annotation</p> <p>length 1</p>   |
| annotation | <p>documentation<br/>70000_Financial_Instrument_Sustainability_Risk_Is_Deemed_To_Be_Relevant<br/>SFDR art 6.1<br/>Yes / No</p>                               |

element **EETReportType1.1.2/SupplementaryFieldsV1.1/Financial\_InstrumentTotalFundNAVOrNotional**

|            |   |
|------------|---|
| diagram    | <p><b>Financial_InstrumentTotalFundNAVOrNotional</b><br/>70010_Financial_Instrument_Total_Fund_NAV_Or_Notional<br/>NAV for a fund and Notional for structured products at PAI_Reference_Date in EUR</p> |
| type       | <p>restriction of <b>xs:decimal</b></p>   |
| properties | <p>isRef 0</p> <p>minOcc 0</p>  |

|            |  |
|------------|--|
|            | maxOcc 1<br>content simple   |
| annotation | documentation<br>70010_Financial_Instrument_Total_Fund_NAV_Or_Notional<br><br>NAV for a fund and Notional for structured products at PAI_Reference_Date in EUR |

element **EETReportType1.1.2/StructuredProductsAdditionalInformation**

|            |  |
|------------|--|
| diagram    | <p>The diagram illustrates the structure of the <b>StructuredProductsAdditionalInformation</b> element. It is represented by a dashed box containing the text "StructuredProductsAdditional..." and the range "80000 - 80050". A central connector symbol (a circle with four dots) is connected to six sub-elements, each in a dashed box with a title and a description:</p> <ul style="list-style-type: none"> <li><b>UseOfProceedsAssetPooling</b>: 80000 Defines if use of proceeds constitute<br/>S - Segregated Sustainable Asset Pool (SAP)<br/>U - Unsegregated Sustainable Asset Pool (USAP)<br/>N - Not a pooled approach (N) and therefore a general part of the balance sheet of the Issuer/Manufacturer"</li> <li><b>UseOfDerivativeExposure</b>: 80010 Defines if the derivative exposure of a Structured Product is considered part of the assessed Taxonomy Alignment and Minimum Proportion of Sustainable Investment reported.</li> <li><b>StructuredProductFundingRelat...</b>: 80020 Conditional to 20420 is filled and 80010 is set to Y. Means the percentage points reported in 20420 if only Funding component is considered.</li> <li><b>StructuredProductDerivateExpo...</b>: 80030 Conditional to 20420 is filled and 80010 is set to Y. Means the percentage points reported in 20420 related to Derivative Exposure.</li> <li><b>StructuredProductFundingRelat...</b>: 80040 Conditional to 20450 is filled and 80010 is set to Y. Means the percentage points reported in 20450 if only Funding component is considered.</li> <li><b>StructuredProductDerivateExpo...</b>: 80050 Conditional to 20450 is filled and 80010 is set to Y. Means the percentage points reported in 20450 related to Derivative Exposure.</li> </ul> |
| properties | isRef 0<br>minOcc 0<br>maxOcc 1<br>content complex   |

|            |   |
|------------|---|
| children   | <a href="#">UseOfProceedsAssetPooling</a> <a href="#">UseOfDerivativeExposure</a><br><a href="#">StructuredProductFundingRelatedEUSFDRMinimumOrPlannedInvestmentsSustainableInvestments</a><br><a href="#">StructuredProductDerivateExposureRelatedEUSFDRMinimumOrPlannedInvestmentsSustainableInvestments</a><br><a href="#">StructuredProductFundingRelatedEUSFDRMinimumOrPlannedInvestmentsSustainableInvestmentsTaxonomyAligned</a><br><a href="#">StructuredProductDerivateExposureRelatedEUSFDRMinimumOrPlannedInvestmentsSustainableInvestmentsTaxonomyAligned</a> |
| annotation | documentation<br>80000 - 80050  |

element **EETReportType1.1.2/StructuredProductsAdditionalInformation/UseOfProceedsAssetPooling**

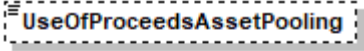
|            |   |
|------------|---|
| diagram    |  <p>80000 Defines if use of proceeds constitute<br/>S - Segregated Sustainable Asset Pool (SAP)<br/>U - Unsegregated Sustainable Asset Pool (USAP)<br/>N - Not a pooled approach (N) and therefore a general part of the balance sheet of the Issuer/Manufacturer"</p> |
| type       | restriction of <b>xs:string</b>   |
| properties | isRef 0<br>minOcc 0<br>maxOcc 1<br>content simple   |
| annotation | documentation<br>80000 Defines if use of proceeds constitute<br>S - Segregated Sustainable Asset Pool (SAP)<br>U - Unsegregated Sustainable Asset Pool (USAP)<br>N - Not a pooled approach (N) and therefore a general part of the balance sheet of the Issuer/Manufacturer"  |

element **EETReportType1.1.2/StructuredProductsAdditionalInformation/UseOfDerivativeExposure**

|            |  |
|------------|--|
| diagram    |  <p>80010 Defines if the derivative exposure of a Structured Product is considered part of the assessed Taxonomy Alignment and Minimum Proportion of Sustainable Investment reported.</p> |
| type       | <a href="#">EETYesNoType</a>   |
| properties | isRef 0<br>minOcc 0<br>maxOcc 1<br>content simple  |
| facets     | Kind Value annotation<br>length 1  |
| annotation | documentation<br>80010 Defines if the derivative exposure of a Structured Product is considered part of the assessed Taxonomy Alignment and Minimum Proportion of Sustainable Investment reported.   |

element

**EETReportType1.1.2/StructuredProductsAdditionalInformation/StructuredProductFundingRelatedEUSFDRMinimumOrPlannedInvestmentsSustainableInvestments**

|            |   |
|------------|---|
| diagram    |  <b>StructuredProductFundingRelat...</b><br>80020 Conditional to 20420 is filled and 80010 is set to Y. Means the percentage points reported in 20420 if only Funding component is considered. |
| type       | <b>xs:decimal</b>   |
| properties | isRef 0<br>minOcc 0<br>maxOcc 1<br>content simple   |
| annotation | documentation<br>80020 Conditional to 20420 is filled and 80010 is set to Y. Means the percentage points reported in 20420 if only Funding component is considered.   |

element

**EETReportType1.1.2/StructuredProductsAdditionalInformation/StructuredProductDerivateExposureRelatedEUSFDRMinimumOrPlannedInvestmentsSustainableInvestments**

|            |  |
|------------|--|
| diagram    |  <b>StructuredProductDerivateExpo...</b><br>80030 Conditional to 20420 is filled and 80010 is set to Y. Means the percentage points reported in 20420 related to Derivative Exposure. |
| type       | <b>xs:decimal</b>  |
| properties | isRef 0<br>minOcc 0<br>maxOcc 1<br>content simple  |
| annotation | documentation<br>80030 Conditional to 20420 is filled and 80010 is set to Y. Means the percentage points reported in 20420 related to Derivative Exposure.   |

element

**EETReportType1.1.2/StructuredProductsAdditionalInformation/StructuredProductFundingRelatedEUSFDRMinimumOrPlannedInvestmentsSustainableInvestmentsTaxonomyAligned**

|            |   |
|------------|---|
| diagram    |  <b>StructuredProductFundingRelat...</b><br>80040 Conditional to 20450 is filled and 80010 is set to Y. Means the percentage points reported in 20450 if only Funding component is considered. |
| type       | <b>xs:decimal</b>   |
| properties | isRef 0<br>minOcc 0<br>maxOcc 1   |



|            |   |
|------------|---|
|            | content simple  |
| annotation | documentation<br>80040 Conditional to 20450 is filled and 80010 is set to Y. Means the percentage points reported in 20450 if only Funding component is considered. |

element

**EETReportType1.1.2/StructuredProductsAdditionalInformation/StructuredProductDerivateExposureRelatedEUSFDRMinimumOrPlannedInvestmentsSustainableInvestmentsTaxonomyAligned**

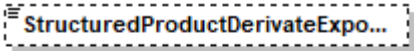
|            |  |
|------------|--|
| diagram    |  <p>80050 Conditional to 20450 is filled and 80010 is set to Y. Means the percentage points reported in 20450 related to Derivative Exposure.</p> |
| type       | <b>xs:decimal</b>  |
| properties | isRef 0<br>minOcc 0<br>maxOcc 1<br>content simple  |
| annotation | documentation<br>80050 Conditional to 20450 is filled and 80010 is set to Y. Means the percentage points reported in 20450 related to Derivative Exposure.   |



|            |  |
|------------|--|
| properties | isRef 0<br>minOcc 0<br>maxOcc 1<br>content complex   |
| children   | <a href="#">InvestingInEUTaxonomyAlignedFossilGasActivities</a><br><a href="#">MinimumPercentageInvestmentsAlignedEUTaxonomyFossilGasInclSovereignBonds</a><br><a href="#">MinimumPercentageInvestmentsAlignedEUTaxonomyFossilGasExclSovereignBonds</a><br><a href="#">InvestingInEUTaxonomyAlignedNuclearActivities</a><br><a href="#">MinimumPercentageInvestmentsAlignedEUTaxonomyNuclearInclSovereignBonds</a><br><a href="#">MinimumPercentageInvestmentsAlignedEUTaxonomyNuclearExclSovereignBonds</a><br><a href="#">MinimumPercentageInvestmentsAlignedEUTaxonomyNoFossilGasandNuclearInclSovereignBonds</a><br><a href="#">MinimumPercentageInvestmentsAlignedEUTaxonomyNoFossilGasandNuclearExclSovereignBonds</a><br><a href="#">CurrentPercentageInvestmentsAlignedEUTaxonomyFossilGasInclSovereignBondsTurnover</a><br><a href="#">CurrentPercentageInvestmentsAlignedEUTaxonomyFossilGasExclSovereignBondsTurnover</a><br><a href="#">CurrentPercentageInvestmentsAlignedEUTaxonomyNuclearInclSovereignBondsTurnover</a><br><a href="#">CurrentPercentageInvestmentsAlignedEUTaxonomyNuclearExclSovereignBondsTurnover</a><br><a href="#">CurrentPercentageInvestmentsAlignedEUTaxonomyNoFossilGasandNuclearInclSovereignBondsTurnover</a><br><a href="#">CurrentPercentageInvestmentsAlignedEUTaxonomyNoFossilGasandNuclearExclSovereignBondsTurnover</a><br><a href="#">CurrentPercentageInvestmentsAlignedEUTaxonomyFossilGasInclSovereignBondsCapex</a><br><a href="#">CurrentPercentageInvestmentsAlignedEUTaxonomyFossilGasExclSovereignBondsCapex</a><br><a href="#">CurrentPercentageInvestmentsAlignedEUTaxonomyNuclearInclSovereignBondsCapex</a><br><a href="#">CurrentPercentageInvestmentsAlignedEUTaxonomyNuclearExclSovereignBondsCapex</a><br><a href="#">CurrentPercentageInvestmentsAlignedEUTaxonomyNoFossilGasandNuclearInclSovereignBondsCapex</a><br><a href="#">CurrentPercentageInvestmentsAlignedEUTaxonomyNoFossilGasandNuclearExclSovereignBondsCapex</a><br><a href="#">CurrentPercentageInvestmentsAlignedEUTaxonomyFossilGasInclSovereignBondsOpex</a><br><a href="#">CurrentPercentageInvestmentsAlignedEUTaxonomyFossilGasExclSovereignBondsOpex</a><br><a href="#">CurrentPercentageInvestmentsAlignedEUTaxonomyNuclearInclSovereignBondsOpex</a><br><a href="#">CurrentPercentageInvestmentsAlignedEUTaxonomyNuclearExclSovereignBondsOpex</a><br><a href="#">CurrentPercentageInvestmentsAlignedEUTaxonomyNoFossilGasandNuclearInclSovereignBondsOpex</a><br><a href="#">CurrentPercentageInvestmentsAlignedEUTaxonomyNoFossilGasandNuclearExclSovereignBondsOpex</a> |
| annotation | documentation<br>90000- 90250  |

element

**EETReportType1.1.2/SupplementaryTaxonomyInformationV1.1.1/InvestingInEUTaxonomyAlignedFossil GasActivities**

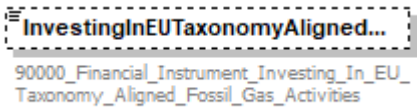
|            |  |
|------------|--|
| diagram    |                 |
| type       | <a href="#">EETYesNoType</a>   |
| properties | isRef 0<br>minOcc 0<br>maxOcc 1<br>content simple  |
| facets     | Kind Value annotation<br>length 1  |
| annotation | documentation<br>90000_Financial_Instrument_Investing_In_EU_Taxonomy_Aligned_Fossil_Gas_Activities |

element

**EETReportType1.1.2/SupplementaryTaxonomyInformationV1.1.1/MinimumPercentageInvestmentsAlignedEUTaxonomyFossilGasInclSovereignBonds**

|            |   |
|------------|---|
| diagram    |  <b>MinimumPercentageInvestmen...</b><br>90010_Financial_Instrument_Minimum_Percentage_Investments_Aligned_EU_Taxonomy_Fossil_Gas_Incl_Sovereign_Bonds |
| type       | <b>xs:decimal</b>   |
| properties | isRef 0<br>minOcc 0<br>maxOcc 1<br>content simple   |
| annotation | documentation<br>90010_Financial_Instrument_Minimum_Percentage_Investments_Aligned_EU_Taxonomy_Fossil_Gas_Incl_Sovereign_Bonds  |

element

**EETReportType1.1.2/SupplementaryTaxonomyInformationV1.1.1/MinimumPercentageInvestmentsAlignedEUTaxonomyFossilGasExclSovereignBonds**

|            |   |
|------------|---|
| diagram    |  <b>MinimumPercentageInvestmen...</b><br>90020_Financial_Instrument_Minimum_Percentage_Investments_Aligned_EU_Taxonomy_Fossil_Gas_Excl_Sovereign_Bonds |
| type       | <b>xs:decimal</b>   |
| properties | isRef 0<br>minOcc 0<br>maxOcc 1<br>content simple   |
| annotation | documentation<br>90020_Financial_Instrument_Minimum_Percentage_Investments_Aligned_EU_Taxonomy_Fossil_Gas_Excl_Sovereign_Bonds  |

element

**EETReportType1.1.2/SupplementaryTaxonomyInformationV1.1.1/InvestingInEUTaxonomyAlignedNuclearActivities**

|            |  |
|------------|--|
| diagram    |  <b>InvestingInEUTaxonomyAligned...</b><br>90030_Financial_Instrument_Investing_In_EU_Taxonomy_Aligned_Nuclear_Activities |
| type       | <a href="#">EETYesNoType</a>   |
| properties | isRef 0<br>minOcc 0<br>maxOcc 1<br>content simple  |
| facets     | Kind Value annotation<br>length 1  |

|            |   |
|------------|---|
| annotation | documentation<br>90030_Financial_Instrument_Investing_In_EU_Taxonomy_Aligned_Nuclear_Activities |
|------------|---|

element

**EETReportType1.1.2/SupplementaryTaxonomyInformationV1.1.1/MinimumPercentageInvestmentsAlignedEUTaxonomyNuclearInclSovereignBonds**

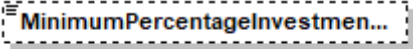
|            |   |
|------------|---|
| diagram    |  <p>90040_Financial_Instrument_Minimum_Percentage_Investments_Aligned_EU_Taxonomy_Nuclear_Incl_Sovereign_Bonds</p> |
| type       | <b>xs:decimal</b>   |
| properties | isRef 0<br>minOcc 0<br>maxOcc 1<br>content simple   |
| annotation | documentation<br>90040_Financial_Instrument_Minimum_Percentage_Investments_Aligned_EU_Taxonomy_Nuclear_Incl_Sovereign_Bonds   |

element

**EETReportType1.1.2/SupplementaryTaxonomyInformationV1.1.1/MinimumPercentageInvestmentsAlignedEUTaxonomyNuclearExclSovereignBonds**

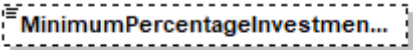
|            |  |
|------------|--|
| diagram    |  <p>90050_Financial_Instrument_Minimum_Percentage_Investments_Aligned_EU_Taxonomy_Nuclear_Excl_Sovereign_Bonds</p> |
| type       | <b>xs:decimal</b>  |
| properties | isRef 0<br>minOcc 0<br>maxOcc 1<br>content simple  |
| annotation | documentation<br>90050_Financial_Instrument_Minimum_Percentage_Investments_Aligned_EU_Taxonomy_Nuclear_Excl_Sovereign_Bonds  |

element

**EETReportType1.1.2/SupplementaryTaxonomyInformationV1.1.1/MinimumPercentageInvestmentsAlignedEUTaxonomyNoFossilGasandNuclearInclSovereignBonds**

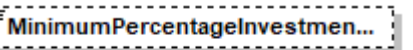
|            |   |
|------------|---|
| diagram    |  <p>90060_Financial_Instrument_Minimum_Percentage_Investments_Aligned_EU_Taxonomy_No_Fossil_Gas_and_Nuclear_Incl_Sovereign_Bonds</p> |
| type       | <b>xs:decimal</b>   |
| properties | isRef 0<br>minOcc 0<br>maxOcc 1<br>content simple   |
| annotation | documentation<br>90060_Financial_Instrument_Minimum_Percentage_Investments_Aligned_EU_Taxonomy_No_Fossil_Gas_and_Nuclear_Incl_Sovereign_Bonds   |

element

**EETReportType1.1.2/SupplementaryTaxonomyInformationV1.1.1/MinimumPercentageInvestmentsAlignedEUTaxonomyNoFossilGasandNuclearExclSovereignBonds**

|            |  |
|------------|--|
| diagram    |  <b>MinimumPercentageInvestmen...</b><br>90070_Financial_Instrument_Minimum_Percentage_Investments_Aligned_EU_Taxonomy_No_Fossil_Gas_and_Nuclear_Excl_Sovereign_Bonds |
| type       | <b>xs:decimal</b>  |
| properties | isRef 0<br>minOcc 0<br>maxOcc 1<br>content simple  |
| annotation | documentation<br>90070_Financial_Instrument_Minimum_Percentage_Investments_Aligned_EU_Taxonomy_No_Fossil_Gas_and_Nuclear_Excl_Sovereign_Bonds  |

element

**EETReportType1.1.2/SupplementaryTaxonomyInformationV1.1.1/CurrentPercentageInvestmentsAlignedEUTaxonomyFossilGasInclSovereignBondsTurnover**

|            |  |
|------------|--|
| diagram    |  <b>CurrentPercentageInvestments...</b><br>90080_Financial_Instrument_Current_Percentage_Investments_Aligned_EU_Taxonomy_Fossil_Gas_Incl_Sovereign_Bonds_Turnover |
| type       | <b>xs:decimal</b>  |
| properties | isRef 0<br>minOcc 0<br>maxOcc 1<br>content simple  |
| annotation | documentation<br>90080_Financial_Instrument_Current_Percentage_Investments_Aligned_EU_Taxonomy_Fossil_Gas_Incl_Sovereign_Bonds_Turnover  |

element

**EETReportType1.1.2/SupplementaryTaxonomyInformationV1.1.1/CurrentPercentageInvestmentsAlignedEUTaxonomyFossilGasExclSovereignBondsTurnover**

|            |  |
|------------|--|
| diagram    |  <b>CurrentPercentageInvestments...</b><br>90090_Financial_Instrument_Current_Percentage_Investments_Aligned_EU_Taxonomy_Fossil_Gas_Excl_Sovereign_Bonds_Turnover |
| type       | <b>xs:decimal</b>  |
| properties | isRef 0<br>minOcc 0<br>maxOcc 1<br>content simple  |
| annotation | documentation<br>90090_Financial_Instrument_Current_Percentage_Investments_Aligned_EU_Taxonomy_Fossil_Gas_Excl_Sovereign_Bonds_Turnover  |

element

**EETReportType1.1.2/SupplementaryTaxonomyInformationV1.1.1/CurrentPercentageInvestmentsAlignedEUTaxonomyNuclearInclSovereignBondsTurnover**

|            |  |
|------------|--|
| diagram    |  <p>90100_Financial_Instrument_Current_Percentage_Investments_Aligned_EU_Taxonomy_Nuclear_Incl_Sovereign_Bonds_Turnover</p> |
| type       | <b>xs:decimal</b>  |
| properties | isRef 0<br>minOcc 0<br>maxOcc 1<br>content simple  |
| annotation | documentation<br>90100_Financial_Instrument_Current_Percentage_Investments_Aligned_EU_Taxonomy_Nuclear_Incl_Sovereign_Bonds_Turnover   |

element

**EETReportType1.1.2/SupplementaryTaxonomyInformationV1.1.1/CurrentPercentageInvestmentsAlignedEUTaxonomyNuclearExclSovereignBondsTurnover**

|            |   |
|------------|---|
| diagram    |  <p>90110_Financial_Instrument_Current_Percentage_Investments_Aligned_EU_Taxonomy_Nuclear_Excl_Sovereign_Bonds_Turnover</p> |
| type       | <b>xs:decimal</b>   |
| properties | isRef 0<br>minOcc 0<br>maxOcc 1<br>content simple   |
| annotation | documentation<br>90110_Financial_Instrument_Current_Percentage_Investments_Aligned_EU_Taxonomy_Nuclear_Excl_Sovereign_Bonds_Turnover  |

element

**EETReportType1.1.2/SupplementaryTaxonomyInformationV1.1.1/CurrentPercentageInvestmentsAlignedEUTaxonomyNoFossilGasandNuclearInclSovereignBondsTurnover**

|            |  |
|------------|--|
| diagram    |  <p>90120_Financial_Instrument_Current_Percentage_Investments_Aligned_EU_Taxonomy_No_Fossil_Gas_and_Nuclear_Incl_Sovereign_Bonds_Turnover</p> |
| type       | <b>xs:decimal</b>  |
| properties | isRef 0<br>minOcc 0<br>maxOcc 1<br>content simple  |
| annotation | documentation  |

|    |   |
|----|---|
| on | 90120_Financial_Instrument_Current_Percentage_Investments_Aligned_EU_Taxonomy_No_Fossil_Gas_and_Nuclear_Incl_Sovereign_Bonds_Turnover |
|----|---|

element

**EETReportType1.1.2/SupplementaryTaxonomyInformationV1.1.1/CurrentPercentageInvestmentsAlignedEUTaxonomyNoFossilGasandNuclearExclSovereignBondsTurnover**

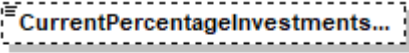
|            |  |
|------------|--|
| diagram    |  <p>90130_Financial_Instrument_Current_Percentage_Investments_Aligned_EU_Taxonomy_No_Fossil_Gas_and_Nuclear_Excl_Sovereign_Bonds_Turnover</p> |
| type       | <b>xs:decimal</b>  |
| properties | isRef 0<br>minOcc 0<br>maxOcc 1<br>content simple  |
| annotation | documentation<br>90130_Financial_Instrument_Current_Percentage_Investments_Aligned_EU_Taxonomy_No_Fossil_Gas_and_Nuclear_Excl_Sovereign_Bonds_Turnover   |

element

**EETReportType1.1.2/SupplementaryTaxonomyInformationV1.1.1/CurrentPercentageInvestmentsAlignedEUTaxonomyFossilGasInclSovereignBondsCapex**

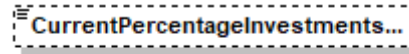
|            |   |
|------------|---|
| diagram    |  <p>90140_Financial_Instrument_Current_Percentage_Investments_Aligned_EU_Taxonomy_Fossil_Gas_Incl_Sovereign_Bonds_Capex</p> |
| type       | <b>xs:decimal</b>   |
| properties | isRef 0<br>minOcc 0<br>maxOcc 1<br>content simple   |
| annotation | documentation<br>90140_Financial_Instrument_Current_Percentage_Investments_Aligned_EU_Taxonomy_Fossil_Gas_Incl_Sovereign_Bonds_Capex  |

element

**EETReportType1.1.2/SupplementaryTaxonomyInformationV1.1.1/CurrentPercentageInvestmentsAlignedEUTaxonomyFossilGasExclSovereignBondsCapex**

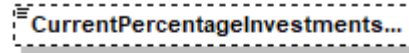
|            |  |
|------------|--|
| diagram    |  <p>90150_Financial_Instrument_Current_Percentage_Investments_Aligned_EU_Taxonomy_Fossil_Gas_Excl_Sovereign_Bonds_Capex</p> |
| type       | <b>xs:decimal</b>  |
| properties | isRef 0<br>minOcc 0<br>maxOcc 1<br>content simple  |
| annotation | documentation<br>90150_Financial_Instrument_Current_Percentage_Investments_Aligned_EU_Taxonomy_Fossil_Gas_Excl_Sovereign_Bonds_Capex   |



|  |         |
|--|---------|
|  | s_Capex |
|--|---------|

element

**EETReportType1.1.2/SupplementaryTaxonomyInformationV1.1.1/CurrentPercentageInvestmentsAlignedEUTaxonomyNuclearInclSovereignBondsCapex**

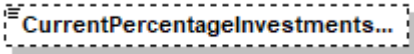
|            |   |
|------------|---|
| diagram    |  <p>90160_Financial_Instrument_Current_Percentage_Investments_Aligned_EU_Taxonomy_Nuclear_Incl_Sovereign_Bonds_Capex</p> |
| type       | <b>xs:decimal</b>   |
| properties | isRef 0<br>minOcc 0<br>maxOcc 1<br>content simple   |
| annotation | documentation<br>90160_Financial_Instrument_Current_Percentage_Investments_Aligned_EU_Taxonomy_Nuclear_Incl_Sovereign_Bonds_Capex   |

element

**EETReportType1.1.2/SupplementaryTaxonomyInformationV1.1.1/CurrentPercentageInvestmentsAlignedEUTaxonomyNuclearExclSovereignBondsCapex**

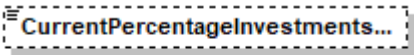
|            |  |
|------------|--|
| diagram    |  <p>90170_Financial_Instrument_Current_Percentage_Investments_Aligned_EU_Taxonomy_Nuclear_Excl_Sovereign_Bonds_Capex</p> |
| type       | <b>xs:decimal</b>  |
| properties | isRef 0<br>minOcc 0<br>maxOcc 1<br>content simple  |
| annotation | documentation<br>90170_Financial_Instrument_Current_Percentage_Investments_Aligned_EU_Taxonomy_Nuclear_Excl_Sovereign_Bonds_Capex  |

element

**EETReportType1.1.2/SupplementaryTaxonomyInformationV1.1.1/CurrentPercentageInvestmentsAlignedEUTaxonomyNoFossilGasandNuclearInclSovereignBondsCapex**

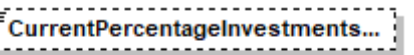
|            |   |
|------------|---|
| diagram    |  <p>90180_Financial_Instrument_Current_Percentage_Investments_Aligned_EU_Taxonomy_No_Fossil_Gas_and_Nuclear_Incl_Sovereign_Bonds_Capex</p> |
| type       | <b>xs:decimal</b>   |
| properties | isRef 0<br>minOcc 0<br>maxOcc 1<br>content simple   |
| annotation | documentation<br>90180_Financial_Instrument_Current_Percentage_Investments_Aligned_EU_Taxonomy_No_Fossil_Gas_and_Nuclear_Incl_  |

|  |                       |
|--|-----------------------|
|  | Sovereign_Bonds_Capex |
|--|-----------------------|

element

**EETReportType1.1.2/SupplementaryTaxonomyInformationV1.1.1/CurrentPercentageInvestmentsAlignedEUTaxonomyNoFossilGasandNuclearExclSovereignBondsCapex**

|            |  |
|------------|--|
| diagram    |  <b>CurrentPercentageInvestments...</b><br>90190_Financial_Instrument_Current_Percentage_Investments_Aligned_EU_Taxonomy_No_Fossil_Gas_and_Nuclear_Excl_Sovereign_Bonds_Capex |
| type       | <b>xs:decimal</b>  |
| properties | isRef 0<br>minOcc 0<br>maxOcc 1<br>content simple  |
| annotation | documentation<br>90190_Financial_Instrument_Current_Percentage_Investments_Aligned_EU_Taxonomy_No_Fossil_Gas_and_Nuclear_Excl_Sovereign_Bonds_Capex  |

element

**EETReportType1.1.2/SupplementaryTaxonomyInformationV1.1.1/CurrentPercentageInvestmentsAlignedEUTaxonomyFossilGasInclSovereignBondsOpex**

|            |  |
|------------|--|
| diagram    |  <b>CurrentPercentageInvestments...</b><br>90200_Financial_Instrument_Current_Percentage_Investments_Aligned_EU_Taxonomy_Fossil_Gas_Incl_Sovereign_Bonds_Opex |
| type       | <b>xs:decimal</b>  |
| properties | isRef 0<br>minOcc 0<br>maxOcc 1<br>content simple  |
| annotation | documentation<br>90200_Financial_Instrument_Current_Percentage_Investments_Aligned_EU_Taxonomy_Fossil_Gas_Incl_Sovereign_Bonds_Opex  |

element

**EETReportType1.1.2/SupplementaryTaxonomyInformationV1.1.1/CurrentPercentageInvestmentsAlignedEUTaxonomyFossilGasExclSovereignBondsOpex**

|            |  |
|------------|--|
| diagram    |  <b>CurrentPercentageInvestments...</b><br>90210_Financial_Instrument_Current_Percentage_Investments_Aligned_EU_Taxonomy_Fossil_Gas_Excl_Sovereign_Bonds_Opex |
| type       | <b>xs:decimal</b>  |
| properties | isRef 0<br>minOcc 0<br>maxOcc 1<br>content simple  |
| annotation | documentation<br>90210_Financial_Instrument_Current_Percentage_Investments_Aligned_EU_Taxonomy_Fossil_Gas_Excl_Sovereign_Bonds_Opex  |

element

**EETReportType1.1.2/SupplementaryTaxonomyInformationV1.1.1/CurrentPercentageInvestmentsAlignedEUTaxonomyNuclearInclSovereignBondsOpex**

|            |  |
|------------|--|
| diagram    | <br>90220_Financial_Instrument_Current_Percentage_Investments_Aligned_EU_Taxonomy_Nuclear_Incl_Sovereign_Bonds_Opex |
| type       | <b>xs:decimal</b>  |
| properties | isRef 0<br>minOcc 0<br>maxOcc 1<br>content simple  |
| annotation | documentation<br>90220_Financial_Instrument_Current_Percentage_Investments_Aligned_EU_Taxonomy_Nuclear_Incl_Sovereign_Bonds_Opex   |

element

**EETReportType1.1.2/SupplementaryTaxonomyInformationV1.1.1/CurrentPercentageInvestmentsAlignedEUTaxonomyNuclearExclSovereignBondsOpex**

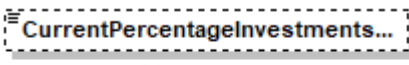
|            |  |
|------------|--|
| diagram    | <br>90230_Financial_Instrument_Current_Percentage_Investments_Aligned_EU_Taxonomy_Nuclear_Excl_Sovereign_Bonds_Opex |
| type       | <b>xs:decimal</b>  |
| properties | isRef 0<br>minOcc 0<br>maxOcc 1<br>content simple  |
| annotation | documentation<br>90230_Financial_Instrument_Current_Percentage_Investments_Aligned_EU_Taxonomy_Nuclear_Excl_Sovereign_Bonds_Opex   |

element

**EETReportType1.1.2/SupplementaryTaxonomyInformationV1.1.1/CurrentPercentageInvestmentsAlignedEUTaxonomyNoFossilGasandNuclearInclSovereignBondsOpex**

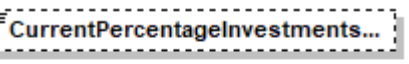
|            |  |
|------------|--|
| diagram    | <br>90240_Financial_Instrument_Current_Percentage_Investments_Aligned_EU_Taxonomy_No_Fossil_Gas_and_Nuclear_Incl_Sovereign_Bonds_Opex |
| type       | <b>xs:decimal</b>  |
| properties | isRef 0<br>minOcc 0<br>maxOcc 1<br>content simple  |
| annotation | documentation<br>90240_Financial_Instrument_Current_Percentage_Investments_Aligned_EU_Taxonomy_No_Fossil_Gas_and_Nuclear_Incl_Sovereign_Bonds_Opex   |

element

**EETReportType1.1.2/SupplementaryTaxonomyInformationV1.1.1/CurrentPercentageInvestmentsAlignedEU TaxonomyNoFossilGasandNuclearExclSovereignBondsOpex**

|            |   |
|------------|---|
| diagram    | <p>90250_Financial_Instrument_Current_Percentage_Investments_Aligned_EU_Taxonomy_No_Fossil_Gas_and_Nuclear_Excl_Sovereign_Bonds_Opex</p>                    |
| type       | <b>xs:decimal</b>   |
| properties | <p>isRef 0<br/> minOcc 0<br/> maxOcc 1<br/> content simple</p>  |
| annotation | <p>documentation<br/> 90250_Financial_Instrument_Current_Percentage_Investments_Aligned_EU_Taxonomy_No_Fossil_Gas_and_Nuclear_Excl_Sovereign_Bonds_Opex</p> |

element **EETReportType1.1.2/ComplementaryInformation**

|            |   |
|------------|---|
| diagram    | <p>100000 - 100010</p>  |
| properties | <p>isRef 0<br/> minOcc 0<br/> maxOcc 1<br/> content complex</p> |
| children   | <a href="#">Social</a>  |
| annotation | <p>documentation<br/> 100000 - 100010</p>                       |

element **EETReportType1.1.2/ComplementaryInformation/Social**

|            |  |
|------------|--|
| diagram    | <p>0..∞<br/> 100000_List_Of_Countries_Subject_To_Social_Violations. ISO 3166-1. Blank if none; conditional to 31210 &gt; 0</p> <p>0..∞<br/> 100010_List_Of_Invested_Countries ISO 3166-1. Blank if none; conditional to 31240 &gt; 0</p> |
| properties | <p>isRef 0<br/> minOcc 0<br/> maxOcc 1<br/> content complex</p>  |
| children   | <p><a href="#">ListOfCountriesSubjectToSocialViolations</a> <a href="#">ListOfInvestedCountries</a></p>  |

element

**EETReportType1.1.2/ComplementaryInformation/Social/ListOfCountriesSubjectToSocialViolations**

|            |  |
|------------|--|
| diagram    |  <p>100000_List_Of_Countries_Subject_To_Social_Violations. ISO 3166-1. Blank if none; conditional to 31210 &gt; 0</p> |
| type       | restriction of <b>xs:string</b>  |
| properties | isRef 0<br>minOcc 0<br>maxOcc unbounded<br>content simple  |
| facets     | Kind Value annotation<br>maxLength 3   |
| annotation | documentation<br>100000_List_Of_Countries_Subject_To_Social_Violations. ISO 3166-1. Blank if none; conditional to 31210 > 0  |

element **EETReportType1.1.2/ComplementaryInformation/Social/ListOfInvestedCountries**

|            |  |
|------------|--|
| diagram    |  <p>100010_List_Of_Invested_Countries ISO 3166-1. Blank if none; conditional to 31240 &gt; 0</p> |
| type       | <a href="#">ISOCountryCodeType</a>   |
| properties | isRef 0<br>minOcc 0<br>maxOcc unbounded<br>content simple  |
| facets     | Kind Value annotation<br>minLength 2<br>maxLength 2  |
| annotation | documentation<br>100010_List_Of_Invested_Countries ISO 3166-1. Blank if none; conditional to 31240 > 0   |

complexType **EETsType**

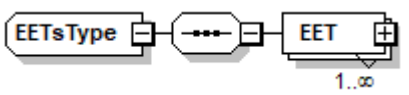
|         |   |
|---------|---|
| diagram |  |
|---------|---|

|          |  |
|----------|--|
| children | <a href="#">EET</a>                                |
| used by  | element <a href="#">DirectReportingType/EET1.0</a> |

element **EETsType/EET**

diagram

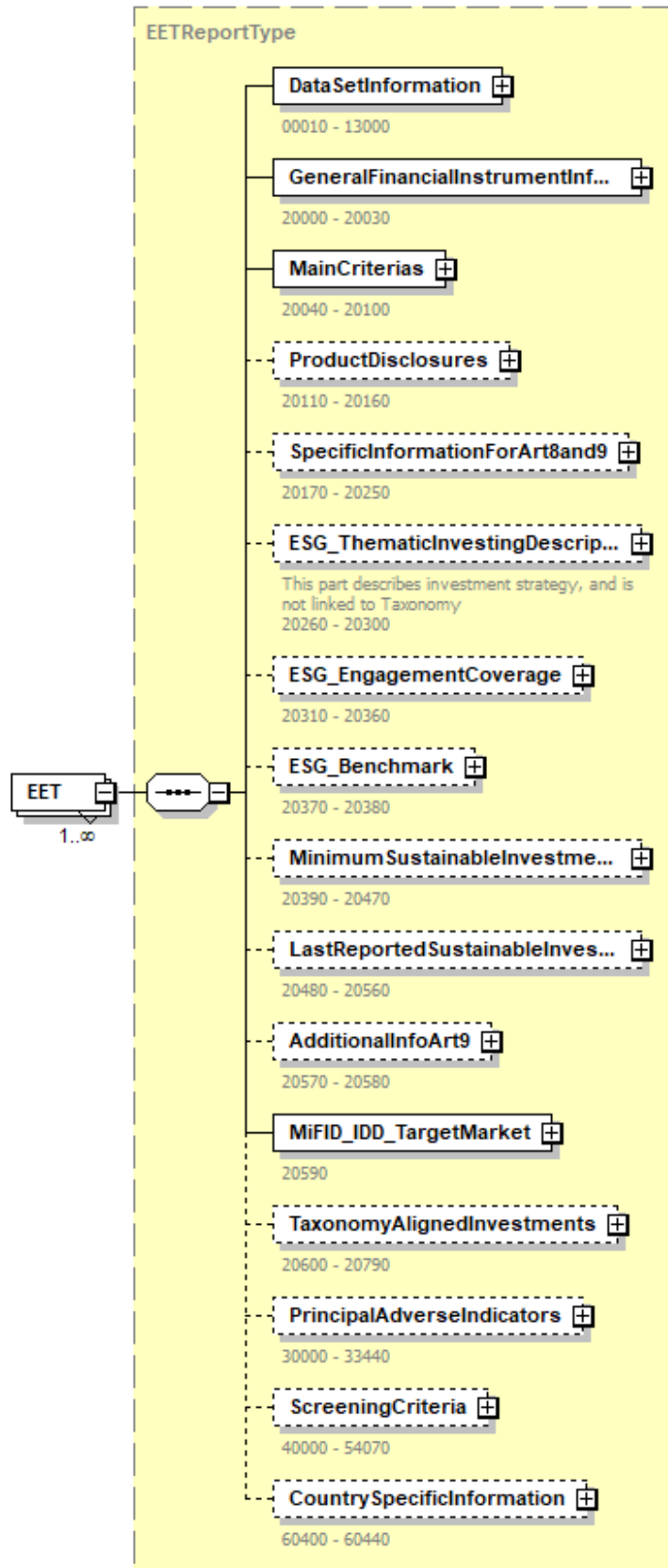



|            |  |
|------------|--|
| type       | <a href="#">EETReportType</a>  |
| properties | isRef 0<br>minOcc 1<br>maxOcc unbounded<br>content complex   |
| children   | <a href="#">DataSetInformation</a> <a href="#">GeneralFinancialInstrumentInformation</a> <a href="#">MainCriteria</a> <a href="#">ProductDisclosures</a><br><a href="#">SpecificInformationForArt8and9</a> <a href="#">ESG</a> <a href="#">ThematicInvestingDescription</a> <a href="#">ESG</a> <a href="#">EngagementCoverage</a> <a href="#">ESG</a> <a href="#">Benchmark</a><br><a href="#">MinimumSustainableInvestments</a> <a href="#">LastReportedSustainableInvestments</a> <a href="#">AdditionalInfoArt9</a> <a href="#">MiFID</a> <a href="#">IDD</a> <a href="#">TargetMarket</a><br><a href="#">TaxonomyAlignedInvestments</a> <a href="#">PrincipalAdverseIndicators</a> <a href="#">ScreeningCriteria</a> <a href="#">CountrySpecificInformation</a> |

complexType **EETsType1.1**

|          |  |
|----------|--|
| diagram  |  |
| children | <a href="#">EET1.1</a>                             |
| used by  | element <a href="#">DirectReportingType/EET1.1</a> |

element **EETsType1.1/EET1.1**

diagram

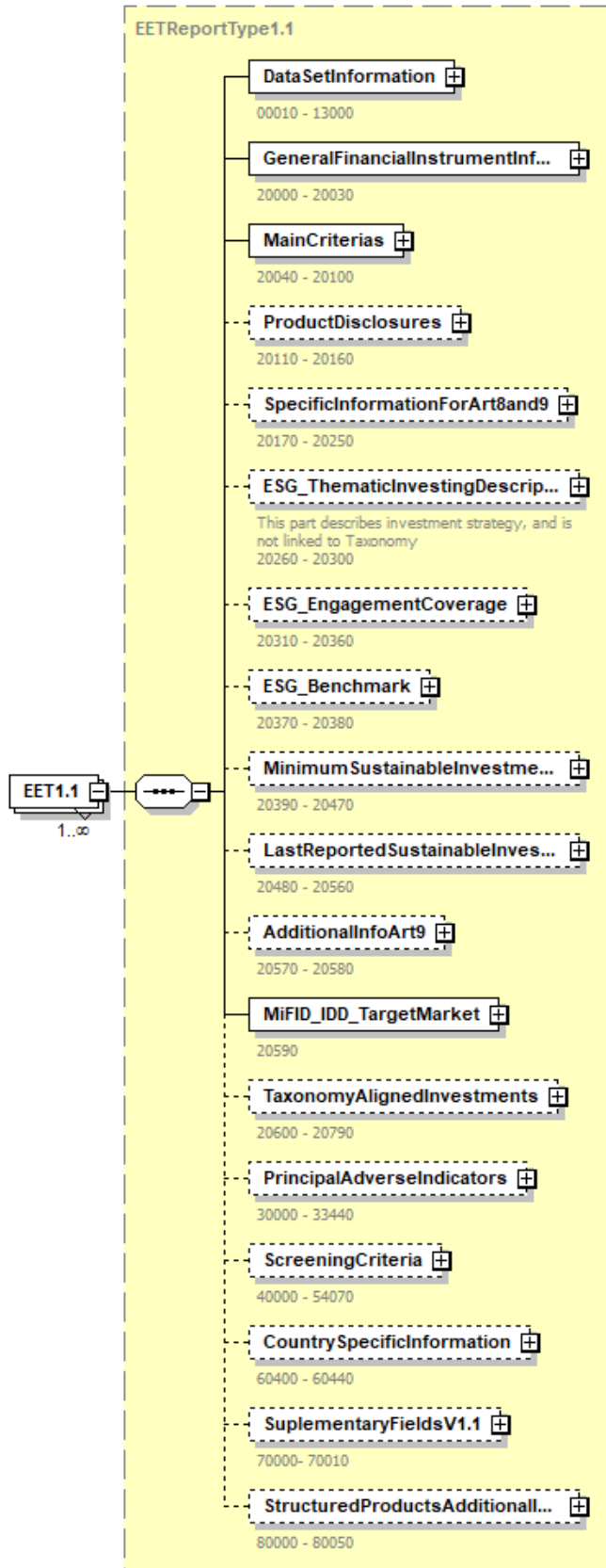

|            |   |
|------------|---|
| type       | <a href="#">EETReportType1.1</a>  |
| properties | isRef 0<br>minOcc 1<br>maxOcc unbounded<br>content complex  |
| children   | <a href="#">DataSetInformation</a> <a href="#">GeneralFinancialInstrumentInformation</a> <a href="#">MainCriteria</a> <a href="#">ProductDisclosures</a><br><a href="#">SpecificInformationForArt8and9</a> <a href="#">ESG</a> <a href="#">ThematicInvestingDescription</a> <a href="#">ESG</a> <a href="#">EngagementCoverage</a> <a href="#">ESG</a> <a href="#">Benchmark</a><br><a href="#">MinimumSustainableInvestments</a> <a href="#">LastReportedSustainableInvestments</a> <a href="#">AdditionalInfoArt9</a> <a href="#">MiFID</a> <a href="#">IDD</a> <a href="#">TargetMarket</a><br><a href="#">TaxonomyAlignedInvestments</a> <a href="#">PrincipalAdverseIndicators</a> <a href="#">ScreeningCriteria</a> <a href="#">CountrySpecificInformation</a><br><a href="#">SupplementaryFieldsV1.1</a> <a href="#">StructuredProductsAdditionalInformation</a> |

complexType **EETsType1.1.1**

|          |  |
|----------|--|
| diagram  |  |
| children | <a href="#">EET1.1.1</a>                             |
| used by  | element <a href="#">DirectReportingType/EET1.1.1</a> |

element **EETsType1.1/EET1.1.1**

diagram

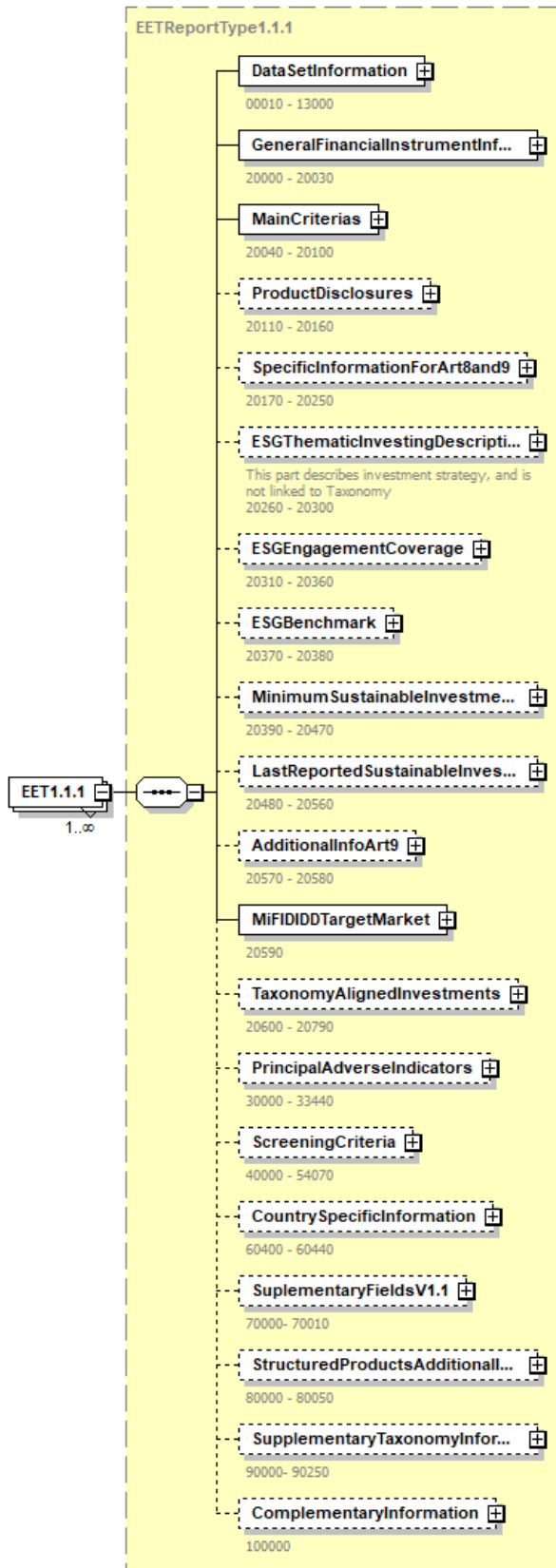

|            |   |
|------------|---|
| type       | <a href="#">EETReportType1.1.1</a>  |
| properties | isRef 0<br>minOcc 1<br>maxOcc unbounded<br>content complex  |
| children   | <a href="#">DataSetInformation</a> <a href="#">GeneralFinancialInstrumentInformation</a> <a href="#">MainCriteria</a> <a href="#">ProductDisclosures</a><br><a href="#">SpecificInformationForArt8and9</a> <a href="#">ESGThematicInvestingDescription</a> <a href="#">ESGEngagementCoverage</a> <a href="#">ESGBenchmark</a><br><a href="#">MinimumSustainableInvestments</a> <a href="#">LastReportedSustainableInvestments</a> <a href="#">AdditionalInfoArt9</a> <a href="#">MiFIDIDDTargetMarket</a><br><a href="#">TaxonomyAlignedInvestments</a> <a href="#">PrincipalAdverseIndicators</a> <a href="#">ScreeningCriteria</a> <a href="#">CountrySpecificInformation</a><br><a href="#">SupplementaryFieldsV1.1</a> <a href="#">StructuredProductsAdditionalInformation</a> <a href="#">SupplementaryTaxonomyInformationV1.1.1</a><br><a href="#">ComplementaryInformation</a> |

complexType **EETsType1.1.2**

|          |  |
|----------|--|
| diagram  | <pre> classDiagram     class EETsType1.1.2     class EET1.1.2     EETsType1.1.2 "1" -- "*" EET1.1.2 </pre> |
| children | <a href="#">EET1.1.2</a>   |
| used by  | element <a href="#">DirectReportingType/EET1.1.2</a>   |

element **EETsType1.1.2/EET1.1.2**

diagram

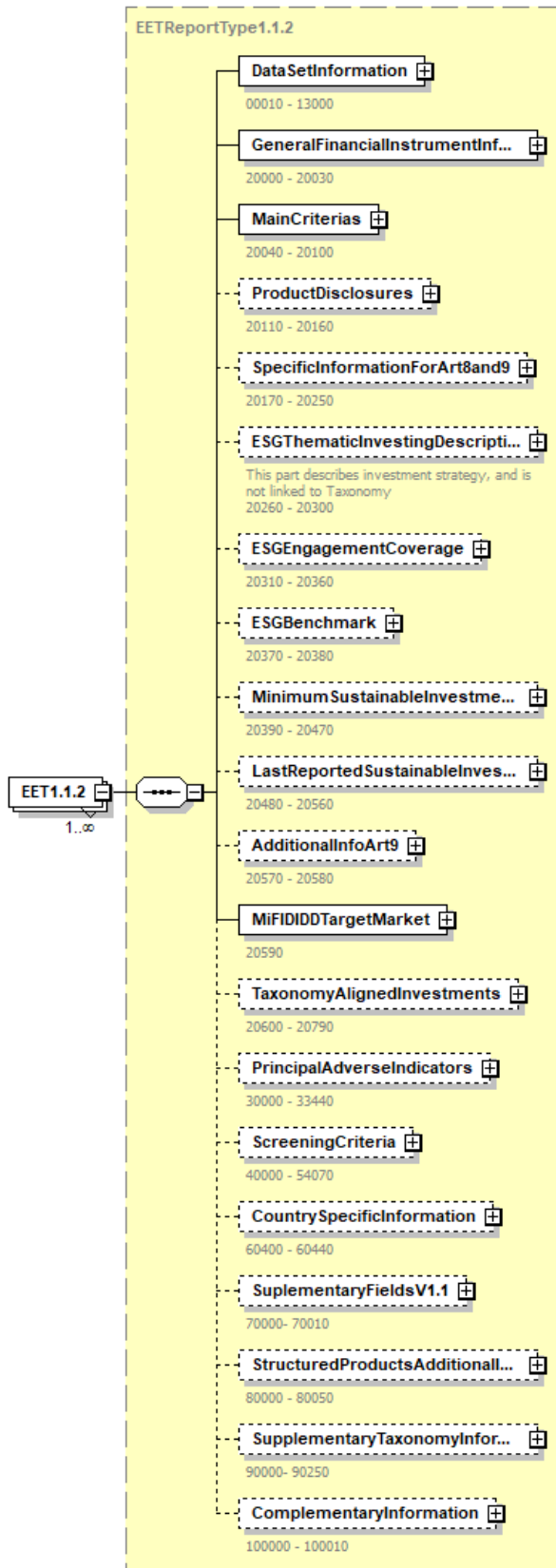

|            |   |
|------------|---|
| type       | <a href="#">EETReportType1.1.2</a>  |
| properties | isRef 0<br>minOcc 1<br>maxOcc unbounded<br>content complex  |
| children   | <a href="#">DataSetInformation</a> <a href="#">GeneralFinancialInstrumentInformation</a> <a href="#">MainCriteria</a> <a href="#">ProductDisclosures</a><br><a href="#">SpecificInformationForArt8and9</a> <a href="#">ESGThematicInvestingDescription</a> <a href="#">ESGEngagementCoverage</a> <a href="#">ESGBenchmark</a><br><a href="#">MinimumSustainableInvestments</a> <a href="#">LastReportedSustainableInvestments</a> <a href="#">AdditionalInfoArt9</a> <a href="#">MiFIDIDDTargetMarket</a><br><a href="#">TaxonomyAlignedInvestments</a> <a href="#">PrincipalAdverseIndicators</a> <a href="#">ScreeningCriteria</a> <a href="#">CountrySpecificInformation</a><br><a href="#">SupplementaryFieldsV1.1</a> <a href="#">StructuredProductsAdditionalInformation</a> <a href="#">SupplementaryTaxonomyInformationV1.1.1</a><br><a href="#">ComplementaryInformation</a> |

### complexType EETWeightNumberType

|          |   |
|----------|---|
| diagram  |   |
| children | <a href="#">Weight</a> <a href="#">Number</a>   |
| used by  | elements <a href="#">EETReportType/ESG EngagementCoverage/EligibleIssuers</a><br><a href="#">EETReportType/ESG EngagementCoverage/EngagedIssuers</a><br><a href="#">EETReportType/ESG EngagementCoverage/ESG CoveredIssuers</a> |

### element EETWeightNumberType/Weight

|            |   |
|------------|---|
| diagram    |   |
| type       | <b>xs:decimal</b>                                 |
| properties | isRef 0<br>minOcc 0<br>maxOcc 1<br>content simple |

### element EETWeightNumberType/Number

|            |   |
|------------|---|
| diagram    |   |
| type       | <b>xs:integer</b>                                 |
| properties | isRef 0<br>minOcc 0<br>maxOcc 1<br>content simple |

### complexType EETWeightNumberType1.1

|          |   |
|----------|---|
| diagram  |   |
| children | <a href="#">Weight</a> <a href="#">Number</a> |



|         |          |   |
|---------|----------|---|
| used by | elements | <a href="#">EETReportType1.1/ESG EngagementCoverage/EligibleIssuers</a><br><a href="#">EETReportType1.1.1/ESGEngagementCoverage/EligibleIssuers</a><br><a href="#">EETReportType1.1.2/ESGEngagementCoverage/EligibleIssuers</a><br><a href="#">EETReportType1.1/ESG EngagementCoverage/EngagedIssuers</a><br><a href="#">EETReportType1.1.1/ESGEngagementCoverage/EngagedIssuers</a><br><a href="#">EETReportType1.1.2/ESGEngagementCoverage/EngagedIssuers</a><br><a href="#">EETReportType1.1/ESG EngagementCoverage/ESG CoveredIssuers</a><br><a href="#">EETReportType1.1.1/ESGEngagementCoverage/ESGCoveredIssuers</a><br><a href="#">EETReportType1.1.2/ESGEngagementCoverage/ESGCoveredIssuers</a> |
|---------|----------|---|

element **EETWeightNumberType1.1/Weight**

|            |   |
|------------|---|
| diagram    |   |
| type       | <a href="#">PercentageType</a>                    |
| properties | isRef 0<br>minOcc 0<br>maxOcc 1<br>content simple |

element **EETWeightNumberType1.1/Number**

|            |   |
|------------|---|
| diagram    |   |
| type       | <b>xs:integer</b>                                 |
| properties | isRef 0<br>minOcc 0<br>maxOcc 1<br>content simple |

complexType **PercentageStrategyCoverageType**

|          |   |
|----------|---|
| diagram  |   |
| children | <a href="#">Value</a> <a href="#">ConsideredInInvestmentStrategy</a> <a href="#">Coverage</a> <a href="#">EligibleAssets</a>                                    |
| used by  | elements <a href="#">EETReportType/PrincipalAdverseIndicators/MoreClimateAndEnvironmentRelatedIndicators/WaterWasteAndLandProtection/AreasOfHighWaterStress</a> |

[EETReportType/PrincipalAdverseIndicators/MoreClimateAndEnvironmentRelatedIndicators/GreenSecurities/BondsNotCertifiedGreen](#)

[EETReportType/PrincipalAdverseIndicators/MoreClimateAndEnvironmentRelatedIndicators/EnergyConsumptionNonRenewable/Coal](#)

[EETReportType/PrincipalAdverseIndicators/MoreClimateAndEnvironmentRelatedIndicators/WaterWasteAndLandProtection/CompaniesCausingLandDegradationDesertificationSoilSealing](#)

[EETReportType/PrincipalAdverseIndicators/MoreSocialAndEmployeeMatters/CorruptionAndBribery/CompaniesInsufficientReactionsOnCorruptionAndBribery](#)

[EETReportType/PrincipalAdverseIndicators/SocialAndEmployeeMatters/CompaniesInvolvedInViolation UN GCP Or OECD ME Guidelines](#)

[EETReportType/PrincipalAdverseIndicators/MoreSocialAndEmployeeMatters/HumanRightsMatters/CompaniesOperationsSuppliersSignificantRiskChildLabour](#)

[EETReportType/PrincipalAdverseIndicators/MoreSocialAndEmployeeMatters/HumanRightsMatters/CompaniesOperationsSuppliersSignificantRiskForcedLabour](#)

[EETReportType/PrincipalAdverseIndicators/MoreClimateAndEnvironmentRelatedIndicators/WaterWasteAndLandProtection/CompaniesProducingChemicals](#)

[EETReportType/PrincipalAdverseIndicators/MoreClimateAndEnvironmentRelatedIndicators/WaterWasteAndLandProtection/CompaniesWhoseOperationsAffectThreatenedSpecies](#)

[EETReportType/PrincipalAdverseIndicators/MoreSocialAndEmployeeMatters/EmployeeMatters/CompaniesWithInsufficientWhistleblowerProtection](#)

[EETReportType/PrincipalAdverseIndicators/MoreSocialAndEmployeeMatters/CorruptionAndBribery/CompaniesWithLackOfAntiCorruptionAndAntiBriberyPolicies](#)

[EETReportType/PrincipalAdverseIndicators/MoreSocialAndEmployeeMatters/HumanRightsMatters/CompaniesWithLackOfDueDiligence](#)

[EETReportType/PrincipalAdverseIndicators/MoreSocialAndEmployeeMatters/EmployeeMatters/CompaniesWithoutAnyGrievanceOrComplaintsHandlingMechanism](#)

[EETReportType/PrincipalAdverseIndicators/MoreSocialAndEmployeeMatters/EmployeeMatters/CompaniesWithoutAnySupplierCodeOfConductAgainstUnsafeWorkingConditions](#)

[EETReportType/PrincipalAdverseIndicators/MoreClimateAndEnvironmentRelatedIndicators/WaterWasteAndLandProtection/CompaniesWithoutBiodiversityProtection](#)

[EETReportType/PrincipalAdverseIndicators/MoreClimateAndEnvironmentRelatedIndicators/EnergyEfficiency/CompaniesWithoutCarbonEmissionReductionInitiatives](#)

[EETReportType/PrincipalAdverseIndicators/MoreClimateAndEnvironmentRelatedIndicators/WaterWasteAndLandProtection/CompaniesWithoutDeforestationPolicy](#)

[EETReportType/PrincipalAdverseIndicators/MoreSocialAndEmployeeMatters/HumanRightsMatters/CompaniesWithoutHumanRightPolicy](#)

[EETReportType/PrincipalAdverseIndicators/SocialAndEmployeeMatters/CompaniesWithoutMonitoringCompliance UN GCP Or OECD ME Guidelines](#)

[EETReportType/PrincipalAdverseIndicators/MoreSocialAndEmployeeMatters/HumanRightsMatters/CompaniesWithoutSufficientHumanTraffickingPrevention](#)

[EETReportType/PrincipalAdverseIndicators/MoreClimateAndEnvironmentRelatedIndicators/WaterWasteAndLandProtection/CompaniesWithoutSustainableLandOrAgriculturePractices](#)

[EETReportType/PrincipalAdverseIndicators/MoreClimateAndEnvironmentRelatedIndicators/WaterWasteAndLandProtection/CompaniesWithoutSustainableOceansSeasPractices](#)

[EETReportType/PrincipalAdverseIndicators/MoreClimateAndEnvironmentRelatedIndicators/WaterWasteAndLandProtection/CompaniesWithoutWaterManagement](#)

[EETReportType/PrincipalAdverseIndicators/MoreSocialAndEmployeeMatters/EmployeeMatters/CompaniesWithoutWorkplaceAccidentPreventionPolicy](#)

[EETReportType/PrincipalAdverseIndicators/ClimateAndEnvironmentRelatedIndicators/EnergyConsumptionFromNonRenewableSources](#)

[EETReportType/PrincipalAdverseIndicators/RealEstateInvestments/EnergyEfficientRealEstateAssets](#)

[EETReportType/PrincipalAdverseIndicators/ClimateAndEnvironmentRelatedIndicators/EnergyProductionFromRenewableSources](#)

[EETReportType/PrincipalAdverseIndicators/ClimateAndEnvironmentRelatedIndicators/ExposureToCompaniesActiveInTheFossilFuelSector](#)

[EETReportType/PrincipalAdverseIndicators/RealEstateInvestments/FossilFuelsExtractionStorageTransportManufacture](#)

[EETReportType/PrincipalAdverseIndicators/SocialAndEmployeeMatters/InvestmentsInvolvedInControversialWeapons](#)

[EETReportType/PrincipalAdverseIndicators/MoreClimateAndEnvironmentRelatedIndicators/RealEstateInvestments/LandArtificialisation](#)

[EETReportType/PrincipalAdverseIndicators/MoreClimateAndEnvironmentRelatedIndicators/EnergyConsumptionNonRenewable/NaturalGas](#)

[EETReportType/PrincipalAdverseIndicators/MoreClimateAndEnvironmentRelatedIndicators/EnergyConsumptionNonRenewable/Oil](#)

[EETReportType/PrincipalAdverseIndicators/SovereignAndSupranationalInvestments/PercentOfCountriesSubjectToSocialViolations](#)

[EETReportType/PrincipalAdverseIndicators/MoreClimateAndEnvironmentRelatedIndicators/RealEstateInvestments/RawMaterialConsumptionForNewConstructionAndMajorRenovations](#)

[EETReportType/PrincipalAdverseIndicators/MoreClimateAndEnvironmentRelatedIndicators/GreenSecurities/Sec](#)

|  |   |
|--|---|
|  | <a href="#">uritiesNotCertifiedGreen</a><br><a href="#">EETReportType/PrincipalAdverseIndicators/SocialAndEmployeeMatters/UnadjustedGenderPayGap</a><br><a href="#">EETReportType/PrincipalAdverseIndicators/MoreClimateAndEnvironmentRelatedIndicators/RealEstateInvestments/WasteProductionInOperations</a><br><a href="#">EETReportType/PrincipalAdverseIndicators/MoreClimateAndEnvironmentRelatedIndicators/WaterWasteAndLandProtection/WaterUsageAndRecyclingPercentage</a> |
|--|---|

element **PercentageStrategyCoverageType/Value**

|            |  |
|------------|--|
| diagram    |  <p>Share of investments in this category in percentage</p> |
| type       | <b>xs:decimal</b>  |
| properties | isRef 0<br>minOcc 0<br>maxOcc 1<br>content simple  |
| annotation | documentation<br>Share of investments in this category in percentage   |

element **PercentageStrategyCoverageType/ConsideredInInvestmentStrategy**

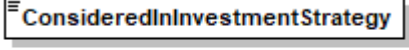
|            |   |
|------------|---|
| diagram    |  <p>Yes (= commitment of the asset manager to improve the PAI), No</p> |
| type       | <a href="#">EETYesNoType</a>  |
| properties | isRef 0<br>content simple   |
| facets     | Kind Value annotation<br>length 1   |
| annotation | documentation<br>Yes (= commitment of the asset manager to improve the PAI), No   |

element **PercentageStrategyCoverageType/Coverage**

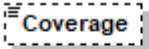
|            |  |
|------------|--|
| diagram    |  <p>% of the notional / AUM, which provide effectively data, or where data could be estimated</p> |
| type       | <b>xs:decimal</b>  |
| properties | isRef 0<br>minOcc 0<br>maxOcc 1<br>content simple  |
| annotation | documentation<br>% of the notional / AUM, which provide effectively data, or where data could be estimated   |

element **PercentageStrategyCoverageType/EligibleAssets**

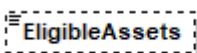
|            |  |
|------------|--|
| diagram    |  <p><b>EligibleAssets</b><br/>% of assets (versus notional / AUM), which could provide data</p> |
| type       | <b>xs:decimal</b>  |
| properties | <p>isRef 0<br/>minOcc 0<br/>maxOcc 1<br/>content simple</p>  |
| annotation | <p>documentation<br/>% of assets (versus notional / AUM), which could provide data</p>   |

complexType **PercentageStrategyCoverageType1.1**

|          |   |
|----------|---|
| diagram  |  <p><b>Value</b><br/>Yes (= commitment of the asset manager to improve the PAI), No</p> <p><b>ConsideredInInvestmentStrategy</b><br/>Yes (= commitment of the asset manager to improve the PAI), No</p> <p><b>Coverage</b><br/>% of the notional / AUM, which provide effectively data, or where data could be estimated</p> <p><b>EligibleAssets</b><br/>% of assets (versus notional / AUM), which could provide data</p>  |
| children | <a href="#">Value</a> <a href="#">ConsideredInInvestmentStrategy</a> <a href="#">Coverage</a> <a href="#">EligibleAssets</a>  |
| used by  | <p>elements</p> <p><a href="#">EETReportType1.1/PrincipalAdverseIndicators/MoreClimateAndEnvironmentRelatedIndicators/WaterWasteAndLandProtection/AreasOfHighWaterStress</a><br/> <a href="#">EETReportType1.1.2/PrincipalAdverseIndicators/MoreClimateAndEnvironmentRelatedIndicators/WaterWasteAndLandProtection/AreasOfHighWaterStress</a><br/> <a href="#">EETReportType1.1.1/PrincipalAdverseIndicators/MoreClimateAndEnvironmentRelatedIndicators/WaterWasteAndLandProtection/AreasOfHighWaterStress</a><br/> <a href="#">EETReportType1.1/PrincipalAdverseIndicators/MoreClimateAndEnvironmentRelatedIndicators/GreenSecurities/BondsNotCertifiedGreen</a><br/> <a href="#">EETReportType1.1.1/PrincipalAdverseIndicators/MoreClimateAndEnvironmentRelatedIndicators/GreenSecurities/BondsNotissuedUnderUnionLegislationOnEnvironmentallySustainableBonds</a><br/> <a href="#">EETReportType1.1.2/PrincipalAdverseIndicators/MoreClimateAndEnvironmentRelatedIndicators/GreenSecurities/BondsNotissuedUnderUnionLegislationOnEnvironmentallySustainableBonds</a><br/> <a href="#">EETReportType1.1.1/PrincipalAdverseIndicators/MoreClimateAndEnvironmentRelatedIndicators/EnergyConsumptionNonRenewable/Coal</a><br/> <a href="#">EETReportType1.1.2/PrincipalAdverseIndicators/MoreClimateAndEnvironmentRelatedIndicators/EnergyConsumptionNonRenewable/Coal</a><br/> <a href="#">EETReportType1.1.1/PrincipalAdverseIndicators/MoreClimateAndEnvironmentRelatedIndicators/EnergyConsumptionNonRenewable/Coal</a><br/> <a href="#">EETReportType1.1.2/PrincipalAdverseIndicators/MoreClimateAndEnvironmentRelatedIndicators/WaterWasteAndLandProtection/CompaniesCausingLandDegradationDesertificationSoilSealing</a><br/> <a href="#">EETReportType1.1/PrincipalAdverseIndicators/MoreClimateAndEnvironmentRelatedIndicators/WaterWasteAndLandProtection/CompaniesCausingLandDegradationDesertificationSoilSealing</a><br/> <a href="#">EETReportType1.1.1/PrincipalAdverseIndicators/MoreClimateAndEnvironmentRelatedIndicators/WaterWasteAndLandProtection/CompaniesCausingLandDegradationDesertificationSoilSealing</a><br/> <a href="#">EETReportType1.1/PrincipalAdverseIndicators/MoreSocialAndEmployeeMatters/CorruptionAndBribery/Compani</a></p> |

[esInsufficientReactionsOnCorruptionAndBribery](#)  
[EETReportType1.1.2/PrincipalAdverseIndicators/MoreSocialAndEmployeeMatters/CorruptionAndBribery/CompaniesInsufficientReactionsOnCorruptionAndBribery](#)  
[EETReportType1.1.1/PrincipalAdverseIndicators/MoreSocialAndEmployeeMatters/CorruptionAndBribery/CompaniesInsufficientReactionsOnCorruptionAndBribery](#)  
[EETReportType1.1/PrincipalAdverseIndicators/SocialAndEmployeeMatters/CompaniesInvolvedInViolation UN GCP Or OECD ME Guidelines](#)  
[EETReportType1.1.2/PrincipalAdverseIndicators/SocialAndEmployeeMatters/CompaniesInvolvedInViolation UN GCP Or OECD ME Guidelines](#)  
[EETReportType1.1.1/PrincipalAdverseIndicators/SocialAndEmployeeMatters/CompaniesInvolvedInViolation UN GCP Or OECD ME Guidelines](#)  
[EETReportType1.1/PrincipalAdverseIndicators/MoreSocialAndEmployeeMatters/HumanRightsMatters/CompaniesOperationsSuppliersSignificantRiskChildLabour](#)  
[EETReportType1.1.1/PrincipalAdverseIndicators/MoreSocialAndEmployeeMatters/HumanRightsMatters/CompaniesOperationsSuppliersSignificantRiskChildLabour](#)  
[EETReportType1.1.2/PrincipalAdverseIndicators/MoreSocialAndEmployeeMatters/HumanRightsMatters/CompaniesOperationsSuppliersSignificantRiskChildLabour](#)  
[EETReportType1.1.2/PrincipalAdverseIndicators/MoreSocialAndEmployeeMatters/HumanRightsMatters/CompaniesOperationsSuppliersSignificantRiskChildLabour](#)  
[EETReportType1.1.2/PrincipalAdverseIndicators/MoreSocialAndEmployeeMatters/HumanRightsMatters/CompaniesOperationsSuppliersSignificantRiskForcedLabour](#)  
[EETReportType1.1/PrincipalAdverseIndicators/MoreSocialAndEmployeeMatters/HumanRightsMatters/CompaniesOperationsSuppliersSignificantRiskForcedLabour](#)  
[EETReportType1.1.1/PrincipalAdverseIndicators/MoreSocialAndEmployeeMatters/HumanRightsMatters/CompaniesOperationsSuppliersSignificantRiskForcedLabour](#)  
[EETReportType1.1.1/PrincipalAdverseIndicators/MoreSocialAndEmployeeMatters/HumanRightsMatters/CompaniesOperationsSuppliersSignificantRiskForcedLabour](#)  
[EETReportType1.1.2/PrincipalAdverseIndicators/MoreClimateAndEnvironmentRelatedIndicators/WaterWasteAndLandProtection/CompaniesProducingChemicals](#)  
[EETReportType1.1/PrincipalAdverseIndicators/MoreClimateAndEnvironmentRelatedIndicators/WaterWasteAndLandProtection/CompaniesProducingChemicals](#)  
[EETReportType1.1.1/PrincipalAdverseIndicators/MoreClimateAndEnvironmentRelatedIndicators/WaterWasteAndLandProtection/CompaniesProducingChemicals](#)  
[EETReportType1.1.2/PrincipalAdverseIndicators/MoreClimateAndEnvironmentRelatedIndicators/WaterWasteAndLandProtection/CompaniesWhoseOperationsAffectThreatenedSpecies](#)  
[EETReportType1.1/PrincipalAdverseIndicators/MoreClimateAndEnvironmentRelatedIndicators/WaterWasteAndLandProtection/CompaniesWhoseOperationsAffectThreatenedSpecies](#)  
[EETReportType1.1.1/PrincipalAdverseIndicators/MoreClimateAndEnvironmentRelatedIndicators/WaterWasteAndLandProtection/CompaniesWhoseOperationsAffectThreatenedSpecies](#)  
[EETReportType1.1.1/PrincipalAdverseIndicators/MoreClimateAndEnvironmentRelatedIndicators/WaterWasteAndLandProtection/CompaniesWhoseOperationsAffectThreatenedSpecies](#)  
[EETReportType1.1.1/PrincipalAdverseIndicators/MoreSocialAndEmployeeMatters/EmployeeMatters/CompaniesWithInsufficientWhistleblowerProtection](#)  
[EETReportType1.1/PrincipalAdverseIndicators/MoreSocialAndEmployeeMatters/EmployeeMatters/CompaniesWithInsufficientWhistleblowerProtection](#)  
[EETReportType1.1.2/PrincipalAdverseIndicators/MoreSocialAndEmployeeMatters/EmployeeMatters/CompaniesWithInsufficientWhistleblowerProtection](#)  
[EETReportType1.1.2/PrincipalAdverseIndicators/MoreSocialAndEmployeeMatters/CorruptionAndBribery/CompaniesWithLackOfAntiCorruptionAndAntiBriberyPolicies](#)  
[EETReportType1.1/PrincipalAdverseIndicators/MoreSocialAndEmployeeMatters/CorruptionAndBribery/CompaniesWithLackOfAntiCorruptionAndAntiBriberyPolicies](#)  
[EETReportType1.1.1/PrincipalAdverseIndicators/MoreSocialAndEmployeeMatters/CorruptionAndBribery/CompaniesWithLackOfAntiCorruptionAndAntiBriberyPolicies](#)  
[EETReportType1.1.1/PrincipalAdverseIndicators/MoreSocialAndEmployeeMatters/CorruptionAndBribery/CompaniesWithLackOfAntiCorruptionAndAntiBriberyPolicies](#)  
[EETReportType1.1.1/PrincipalAdverseIndicators/MoreSocialAndEmployeeMatters/HumanRightsMatters/CompaniesWithLackOfDueDiligence](#)  
[EETReportType1.1/PrincipalAdverseIndicators/MoreSocialAndEmployeeMatters/HumanRightsMatters/CompaniesWithLackOfDueDiligence](#)  
[EETReportType1.1.2/PrincipalAdverseIndicators/MoreSocialAndEmployeeMatters/HumanRightsMatters/CompaniesWithLackOfDueDiligence](#)  
[EETReportType1.1.1/PrincipalAdverseIndicators/MoreSocialAndEmployeeMatters/EmployeeMatters/CompaniesWithoutAnyGrievanceOrComplaintsHandlingMechanism](#)  
[EETReportType1.1.2/PrincipalAdverseIndicators/MoreSocialAndEmployeeMatters/EmployeeMatters/CompaniesWithoutAnyGrievanceOrComplaintsHandlingMechanism](#)  
[EETReportType1.1/PrincipalAdverseIndicators/MoreSocialAndEmployeeMatters/EmployeeMatters/CompaniesWithoutAnyGrievanceOrComplaintsHandlingMechanism](#)  
[EETReportType1.1/PrincipalAdverseIndicators/MoreSocialAndEmployeeMatters/EmployeeMatters/CompaniesWithoutAnySupplierCodeOfConductAgainstUnsafeWorkingConditions](#)  
[EETReportType1.1.2/PrincipalAdverseIndicators/MoreSocialAndEmployeeMatters/EmployeeMatters/CompaniesWithoutAnySupplierCodeOfConductAgainstUnsafeWorkingConditions](#)  
[EETReportType1.1.1/PrincipalAdverseIndicators/MoreSocialAndEmployeeMatters/EmployeeMatters/CompaniesWithoutAnySupplierCodeOfConductAgainstUnsafeWorkingConditions](#)  
[EETReportType1.1.2/PrincipalAdverseIndicators/MoreClimateAndEnvironmentRelatedIndicators/WaterWasteAndLandProtection/CompaniesWithoutBiodiversityProtection](#)  
[EETReportType1.1/PrincipalAdverseIndicators/MoreClimateAndEnvironmentRelatedIndicators/WaterWasteAndLandProtection/CompaniesWithoutBiodiversityProtection](#)  
[EETReportType1.1.1/PrincipalAdverseIndicators/MoreClimateAndEnvironmentRelatedIndicators/WaterWasteAnd](#)

[LandProtection/CompaniesWithoutBiodiversityProtection](#)  
[EETReportType1.1/PrincipalAdverseIndicators/MoreClimateAndEnvironmentRelatedIndicators/EnergyEfficiency/CompaniesWithoutCarbonEmissionReductionInitiatives](#)  
[EETReportType1.1.1/PrincipalAdverseIndicators/MoreClimateAndEnvironmentRelatedIndicators/EnergyEfficiency/CompaniesWithoutCarbonEmissionReductionInitiatives](#)  
[EETReportType1.2/PrincipalAdverseIndicators/MoreClimateAndEnvironmentRelatedIndicators/EnergyEfficiency/CompaniesWithoutCarbonEmissionReductionInitiatives](#)  
[EETReportType1.1.1/PrincipalAdverseIndicators/MoreClimateAndEnvironmentRelatedIndicators/WaterWasteAndLandProtection/CompaniesWithoutDeforestationPolicy](#)  
[EETReportType1.2/PrincipalAdverseIndicators/MoreClimateAndEnvironmentRelatedIndicators/WaterWasteAndLandProtection/CompaniesWithoutDeforestationPolicy](#)  
[EETReportType1.1/PrincipalAdverseIndicators/MoreClimateAndEnvironmentRelatedIndicators/WaterWasteAndLandProtection/CompaniesWithoutDeforestationPolicy](#)  
[EETReportType1.1/PrincipalAdverseIndicators/MoreSocialAndEmployeeMatters/HumanRightsMatters/CompaniesWithoutHumanRightPolicy](#)  
[EETReportType1.1.1/PrincipalAdverseIndicators/MoreSocialAndEmployeeMatters/HumanRightsMatters/CompaniesWithoutHumanRightPolicy](#)  
[EETReportType1.1.2/PrincipalAdverseIndicators/MoreSocialAndEmployeeMatters/HumanRightsMatters/CompaniesWithoutHumanRightPolicy](#)  
[EETReportType1.1/PrincipalAdverseIndicators/SocialAndEmployeeMatters/CompaniesWithoutMonitoringCompliance UN GCP Or OECD ME Guidelines](#)  
[EETReportType1.2/PrincipalAdverseIndicators/SocialAndEmployeeMatters/CompaniesWithoutMonitoringCompliance UN GCP Or OECD ME Guidelines](#)  
[EETReportType1.1/PrincipalAdverseIndicators/SocialAndEmployeeMatters/CompaniesWithoutMonitoringCompliance UN GCP Or OECD ME Guidelines](#)  
[EETReportType1.1.1/PrincipalAdverseIndicators/MoreSocialAndEmployeeMatters/HumanRightsMatters/CompaniesWithoutSufficientHumanTraffickingPrevention](#)  
[EETReportType1.1/PrincipalAdverseIndicators/MoreSocialAndEmployeeMatters/HumanRightsMatters/CompaniesWithoutSufficientHumanTraffickingPrevention](#)  
[EETReportType1.2/PrincipalAdverseIndicators/MoreSocialAndEmployeeMatters/HumanRightsMatters/CompaniesWithoutSufficientHumanTraffickingPrevention](#)  
[EETReportType1.2/PrincipalAdverseIndicators/MoreClimateAndEnvironmentRelatedIndicators/WaterWasteAndLandProtection/CompaniesWithoutSustainableLandOrAgriculturePractices](#)  
[EETReportType1.1.1/PrincipalAdverseIndicators/MoreClimateAndEnvironmentRelatedIndicators/WaterWasteAndLandProtection/CompaniesWithoutSustainableLandOrAgriculturePractices](#)  
[EETReportType1.1/PrincipalAdverseIndicators/MoreClimateAndEnvironmentRelatedIndicators/WaterWasteAndLandProtection/CompaniesWithoutSustainableLandOrAgriculturePractices](#)  
[EETReportType1.2/PrincipalAdverseIndicators/MoreClimateAndEnvironmentRelatedIndicators/WaterWasteAndLandProtection/CompaniesWithoutSustainableOceansSeasPractices](#)  
[EETReportType1.1/PrincipalAdverseIndicators/MoreClimateAndEnvironmentRelatedIndicators/WaterWasteAndLandProtection/CompaniesWithoutSustainableOceansSeasPractices](#)  
[EETReportType1.1.1/PrincipalAdverseIndicators/MoreClimateAndEnvironmentRelatedIndicators/WaterWasteAndLandProtection/CompaniesWithoutSustainableOceansSeasPractices](#)  
[EETReportType1.1/PrincipalAdverseIndicators/MoreClimateAndEnvironmentRelatedIndicators/WaterWasteAndLandProtection/CompaniesWithoutWaterManagement](#)  
[EETReportType1.2/PrincipalAdverseIndicators/MoreClimateAndEnvironmentRelatedIndicators/WaterWasteAndLandProtection/CompaniesWithoutWaterManagement](#)  
[EETReportType1.1.1/PrincipalAdverseIndicators/MoreClimateAndEnvironmentRelatedIndicators/WaterWasteAndLandProtection/CompaniesWithoutWaterManagement](#)  
[EETReportType1.1/PrincipalAdverseIndicators/MoreSocialAndEmployeeMatters/EmployeeMatters/CompaniesWithoutWorkplaceAccidentPreventionPolicy](#)  
[EETReportType1.2/PrincipalAdverseIndicators/MoreSocialAndEmployeeMatters/EmployeeMatters/CompaniesWithoutWorkplaceAccidentPreventionPolicy](#)  
[EETReportType1.1.1/PrincipalAdverseIndicators/MoreSocialAndEmployeeMatters/EmployeeMatters/CompaniesWithoutWorkplaceAccidentPreventionPolicy](#)  
[EETReportType1.1.1/PrincipalAdverseIndicators/ClimateAndEnvironmentRelatedIndicators/EnergyConsumptionFromNonRenewableSources](#)  
[EETReportType1.2/PrincipalAdverseIndicators/ClimateAndEnvironmentRelatedIndicators/EnergyConsumptionFromNonRenewableSources](#)  
[EETReportType1.1/PrincipalAdverseIndicators/ClimateAndEnvironmentRelatedIndicators/EnergyConsumptionFromNonRenewableSources](#)  
[EETReportType1.1/PrincipalAdverseIndicators/RealEstateInvestments/EnergyEfficientRealEstateAssets](#)  
[EETReportType1.2/PrincipalAdverseIndicators/RealEstateInvestments/EnergyInefficientRealEstateAssets](#)  
[EETReportType1.1.1/PrincipalAdverseIndicators/RealEstateInvestments/EnergyInefficientRealEstateAssets](#)  
[EETReportType1.1.1/PrincipalAdverseIndicators/ClimateAndEnvironmentRelatedIndicators/EnergyProductionFromNonRenewableSources](#)  
[EETReportType1.1.2/PrincipalAdverseIndicators/ClimateAndEnvironmentRelatedIndicators/EnergyProductionFromNonRenewableSources](#)  
[EETReportType1.1/PrincipalAdverseIndicators/ClimateAndEnvironmentRelatedIndicators/EnergyProductionFromNonRenewableSources](#)

[EETReportType1.1.1/PrincipalAdverseIndicators/ClimateAndEnvironmentRelatedIndicators/ExposureToCompaniesActiveInTheFossilFuelSector](#)  
[EETReportType1.1/PrincipalAdverseIndicators/ClimateAndEnvironmentRelatedIndicators/ExposureToCompaniesActiveInTheFossilFuelSector](#)  
[EETReportType1.1.2/PrincipalAdverseIndicators/ClimateAndEnvironmentRelatedIndicators/ExposureToCompaniesActiveInTheFossilFuelSector](#)  
[EETReportType1.1.2/PrincipalAdverseIndicators/RealEstateInvestments/FossilFuelsExtractionStorageTransportManufacture](#)  
[EETReportType1.1/PrincipalAdverseIndicators/RealEstateInvestments/FossilFuelsExtractionStorageTransportManufacture](#)  
[EETReportType1.1.1/PrincipalAdverseIndicators/RealEstateInvestments/FossilFuelsExtractionStorageTransportManufacture](#)  
[EETReportType1.1.1/PrincipalAdverseIndicators/SocialAndEmployeeMatters/InvestmentsInvolvedInControversialWeapons](#)  
[EETReportType1.1.2/PrincipalAdverseIndicators/SocialAndEmployeeMatters/InvestmentsInvolvedInControversialWeapons](#)  
[EETReportType1.1/PrincipalAdverseIndicators/SocialAndEmployeeMatters/InvestmentsInvolvedInControversialWeapons](#)  
[EETReportType1.1/PrincipalAdverseIndicators/MoreClimateAndEnvironmentRelatedIndicators/RealEstateInvestments/LandArtificialisation](#)  
[EETReportType1.1.2/PrincipalAdverseIndicators/MoreClimateAndEnvironmentRelatedIndicators/RealEstateInvestments/LandArtificialisation](#)  
[EETReportType1.1.1/PrincipalAdverseIndicators/MoreClimateAndEnvironmentRelatedIndicators/RealEstateInvestments/LandArtificialisation](#)  
[EETReportType1.1.1/PrincipalAdverseIndicators/MoreClimateAndEnvironmentRelatedIndicators/EnergyConsumptionNonRenewable/NaturalGas](#)  
[EETReportType1.1.2/PrincipalAdverseIndicators/MoreClimateAndEnvironmentRelatedIndicators/EnergyConsumptionNonRenewable/NaturalGas](#)  
[EETReportType1.1/PrincipalAdverseIndicators/MoreClimateAndEnvironmentRelatedIndicators/EnergyConsumptionNonRenewable/NaturalGas](#)  
[EETReportType1.1/PrincipalAdverseIndicators/MoreClimateAndEnvironmentRelatedIndicators/EnergyConsumptionNonRenewable/Oil](#)  
[EETReportType1.1.1/PrincipalAdverseIndicators/MoreClimateAndEnvironmentRelatedIndicators/EnergyConsumptionNonRenewable/Oil](#)  
[EETReportType1.1.2/PrincipalAdverseIndicators/MoreClimateAndEnvironmentRelatedIndicators/EnergyConsumptionNonRenewable/Oil](#)  
[EETReportType1.1.2/PrincipalAdverseIndicators/SovereignAndSupranationalInvestments/PercentOfCountriesSubjectToSocialViolations](#)  
[EETReportType1.1/PrincipalAdverseIndicators/SovereignAndSupranationalInvestments/PercentOfCountriesSubjectToSocialViolations](#)  
[EETReportType1.1.1/PrincipalAdverseIndicators/SovereignAndSupranationalInvestments/PercentOfCountriesSubjectToSocialViolations](#)  
[EETReportType1.1.2/PrincipalAdverseIndicators/MoreClimateAndEnvironmentRelatedIndicators/RealEstateInvestments/RawMaterialConsumptionForNewConstructionAndMajorRenovations](#)  
[EETReportType1.1/PrincipalAdverseIndicators/MoreClimateAndEnvironmentRelatedIndicators/RealEstateInvestments/RawMaterialConsumptionForNewConstructionAndMajorRenovations](#)  
[EETReportType1.1.1/PrincipalAdverseIndicators/MoreClimateAndEnvironmentRelatedIndicators/RealEstateInvestments/RawMaterialConsumptionForNewConstructionAndMajorRenovations](#)  
[EETReportType1.1/PrincipalAdverseIndicators/MoreClimateAndEnvironmentRelatedIndicators/GreenSecurities/SecuritiesNotCertifiedGreen](#)  
[EETReportType1.1.1/PrincipalAdverseIndicators/MoreClimateAndEnvironmentRelatedIndicators/GreenSecurities/SecuritiesNotIssuedUnderUnionLegislationOnEnvironmentallySustainableBonds](#)  
[EETReportType1.1.2/PrincipalAdverseIndicators/MoreClimateAndEnvironmentRelatedIndicators/GreenSecurities/SecuritiesNotIssuedUnderUnionLegislationOnEnvironmentallySustainableBonds](#)  
[EETReportType1.1.2/PrincipalAdverseIndicators/SocialAndEmployeeMatters/UnadjustedGenderPayGap](#)  
[EETReportType1.1.1/PrincipalAdverseIndicators/SocialAndEmployeeMatters/UnadjustedGenderPayGap](#)  
[EETReportType1.1/PrincipalAdverseIndicators/SocialAndEmployeeMatters/UnadjustedGenderPayGap](#)  
[EETReportType1.1/PrincipalAdverseIndicators/MoreClimateAndEnvironmentRelatedIndicators/RealEstateInvestments/WasteProductionInOperations](#)  
[EETReportType1.1.2/PrincipalAdverseIndicators/MoreClimateAndEnvironmentRelatedIndicators/RealEstateInvestments/WasteProductionInOperations](#)  
[EETReportType1.1.1/PrincipalAdverseIndicators/MoreClimateAndEnvironmentRelatedIndicators/RealEstateInvestments/WasteProductionInOperations](#)  
[EETReportType1.1/PrincipalAdverseIndicators/MoreClimateAndEnvironmentRelatedIndicators/WaterWasteAndLandProtection/WaterUsageAndRecyclingPercentage](#)  
[EETReportType1.1.1/PrincipalAdverseIndicators/MoreClimateAndEnvironmentRelatedIndicators/WaterWasteAndLandProtection/WaterUsageAndRecyclingPercentage](#)  
[EETReportType1.1.2/PrincipalAdverseIndicators/MoreClimateAndEnvironmentRelatedIndicators/WaterWasteAndLandProtection/WaterUsageAndRecyclingPercentage](#)

element **PercentageStrategyCoverageType1.1/Value**

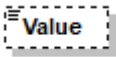
|            |   |
|------------|---|
| diagram    |  |
| type       | <b>xs:decimal</b>   |
| properties | isRef 0<br>minOcc 0<br>maxOcc 1<br>content simple                                 |
| annotation | documentation   |

element **PercentageStrategyCoverageType1.1/ConsideredInInvestmentStrategy**

|            |   |
|------------|---|
| diagram    | <br>Yes (= commitment of the asset manager to improve the PAI), No |
| type       | <a href="#">EETYesNoType</a>  |
| properties | isRef 0<br>content simple   |
| facets     | Kind Value annotation<br>length 1   |
| annotation | documentation<br>Yes (= commitment of the asset manager to improve the PAI), No   |

element **PercentageStrategyCoverageType1.1/Coverage**

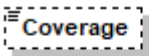
|            |  |
|------------|--|
| diagram    | <br>% of the notional / AUM, which provide effectively data, or where data could be estimated |
| type       | <b>xs:decimal</b>  |
| properties | isRef 0<br>minOcc 0<br>maxOcc 1<br>content simple  |
| annotation | documentation<br>% of the notional / AUM, which provide effectively data, or where data could be estimated   |

element **PercentageStrategyCoverageType1.1/EligibleAssets**

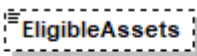
|         |  |
|---------|--|
| diagram | <br>% of assets (versus notional / AUM), which could provide data |
| type    | <b>xs:decimal</b>  |



|            |  |
|------------|--|
| properties | isRef 0<br>minOcc 0<br>maxOcc 1<br>content simple                              |
| annotation | documentation<br>% of assets (versus notional / AUM), which could provide data |

### complexType PercentageStrategyCoverageType1.1.2

|          |  |
|----------|--|
| diagram  |  |
| children | <a href="#">Value</a> <a href="#">ConsideredInInvestmentStrategy</a> <a href="#">Coverage</a> <a href="#">EligibleAssets</a> |

### element PercentageStrategyCoverageType1.1.2/Value

|            |   |
|------------|---|
| diagram    |   |
| type       | xs:decimal  |
| properties | isRef 0<br>minOcc 0<br>maxOcc 1<br>content simple |
| annotation | documentation                                     |

### element PercentageStrategyCoverageType1.1.2/ConsideredInInvestmentStrategy

|            |   |
|------------|---|
| diagram    |   |
| type       | <a href="#">EETYesNoType</a>  |
| properties | isRef 0<br>content simple   |
| facets     | Kind Value annotation<br>length 1   |
| annotation | documentation<br>Yes (= commitment of the asset manager to improve the PAI), No |

element **PercentageStrategyCoverageType1.1.2/Coverage**

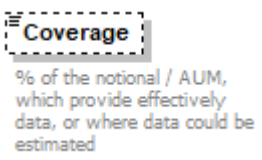
|            |  |
|------------|--|
| diagram    |  <p><b>Coverage</b><br/>% of the notional / AUM, which provide effectively data, or where data could be estimated</p> |
| type       | <b>xs:decimal</b>  |
| properties | <p>isRef 0<br/>minOcc 0<br/>maxOcc 1<br/>content simple</p>  |
| annotation | <p>documentation<br/>% of the notional / AUM, which provide effectively data, or where data could be estimated</p>   |

element **PercentageStrategyCoverageType1.1.2/EligibleAssets**

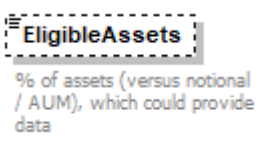
|            |  |
|------------|--|
| diagram    |  <p><b>EligibleAssets</b><br/>% of assets (versus notional / AUM), which could provide data</p> |
| type       | <b>xs:decimal</b>  |
| properties | <p>isRef 0<br/>minOcc 0<br/>maxOcc 1<br/>content simple</p>  |
| annotation | <p>documentation<br/>% of assets (versus notional / AUM), which could provide data</p>   |

complexType **ValueStrategyCoverageType**

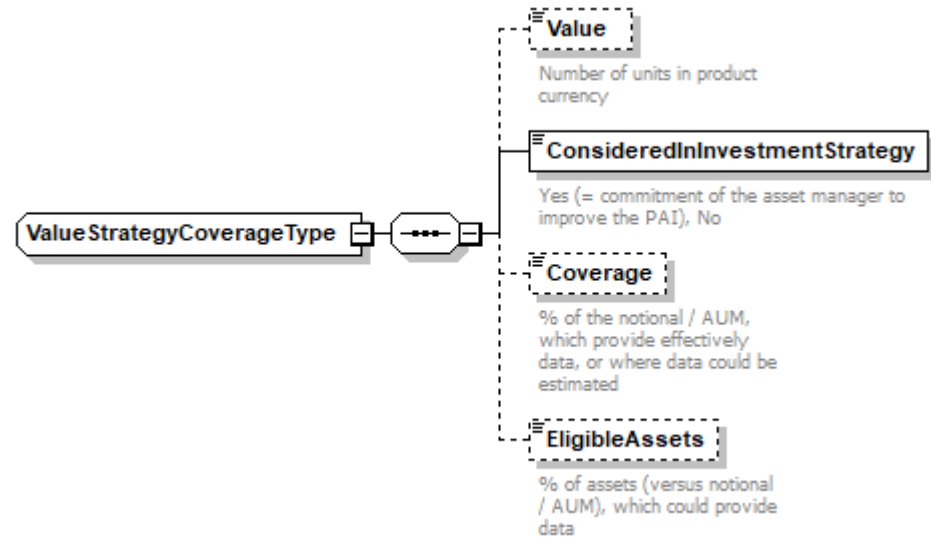
|          |  |
|----------|--|
| diagram  |  <p><b>Value</b><br/>Number of units in product currency</p> <p><b>ConsideredInvestmentStrategy</b><br/>Yes (= commitment of the asset manager to improve the PAI), No</p> <p><b>Coverage</b><br/>% of the notional / AUM, which provide effectively data, or where data could be estimated</p> <p><b>EligibleAssets</b><br/>% of assets (versus notional / AUM), which could provide data</p> |
| children | <a href="#">Value</a> <a href="#">ConsideredInvestmentStrategy</a> <a href="#">Coverage</a> <a href="#">EligibleAssets</a>   |

|         |          |   |
|---------|----------|---|
| used by | elements | <a href="#">EETReportType/PrincipalAdverseIndicators/ClimateAndEnvironmentRelatedIndicators/ActivitiesNegativelyAffectingBiodiversitySensitiveAreas</a><br><a href="#">EETReportType/PrincipalAdverseIndicators/MoreSocialAndEmployeeMatters/SovereignAndSupranationalInvestments/AverageCorruptionScore</a><br><a href="#">EETReportType/PrincipalAdverseIndicators/MoreSocialAndEmployeeMatters/SovereignAndSupranationalInvestments/AverageFreedomOfExpressionScore</a><br><a href="#">EETReportType/PrincipalAdverseIndicators/MoreSocialAndEmployeeMatters/SovereignAndSupranationalInvestments/AverageHumanRightsPerformance</a><br><a href="#">EETReportType/PrincipalAdverseIndicators/MoreSocialAndEmployeeMatters/SovereignAndSupranationalInvestments/AverageIncomeInequalityScore</a><br><a href="#">EETReportType/PrincipalAdverseIndicators/MoreSocialAndEmployeeMatters/SovereignAndSupranationalInvestments/AveragePoliticalStabilityScore</a><br><a href="#">EETReportType/PrincipalAdverseIndicators/MoreSocialAndEmployeeMatters/SovereignAndSupranationalInvestments/AverageRuleOfLawScore</a><br><a href="#">EETReportType/PrincipalAdverseIndicators/SocialAndEmployeeMatters/BoardGenderDiversity</a><br><a href="#">EETReportType/PrincipalAdverseIndicators/ClimateAndEnvironmentRelatedIndicators/CarbonFootprintScope12</a><br><a href="#">EETReportType/PrincipalAdverseIndicators/ClimateAndEnvironmentRelatedIndicators/CarbonFootprintScope123</a><br><a href="#">EETReportType/PrincipalAdverseIndicators/MoreSocialAndEmployeeMatters/CorruptionAndBribery/ConvictionsOfAntiCorruptionAndAntiBriberyLaws</a><br><a href="#">EETReportType/PrincipalAdverseIndicators/MoreClimateAndEnvironmentRelatedIndicators/EnergyEfficiency/EmissionsOfAirPollutants</a><br><a href="#">EETReportType/PrincipalAdverseIndicators/MoreClimateAndEnvironmentRelatedIndicators/EnergyEfficiency/EmissionsOfInorganicPollutants</a><br><a href="#">EETReportType/PrincipalAdverseIndicators/MoreClimateAndEnvironmentRelatedIndicators/EnergyEfficiency/EmissionsOfOzoneDepletionSubstances</a><br><a href="#">EETReportType/PrincipalAdverseIndicators/MoreClimateAndEnvironmentRelatedIndicators/RealEstateInvestments/EnergyConsumptionIntensity</a><br><a href="#">EETReportType/PrincipalAdverseIndicators/MoreSocialAndEmployeeMatters/EmployeeMatters/ExcessiveCEOPayRatio</a><br><a href="#">EETReportType/PrincipalAdverseIndicators/ClimateAndEnvironmentRelatedIndicators/GHG IntensityOfInveste</a><br><a href="#">EETReportType/PrincipalAdverseIndicators/ClimateAndEnvironmentRelatedIndicators/GHG IntensityOfInveste</a><br><a href="#">EETReportType/PrincipalAdverseIndicators/ClimateAndEnvironmentRelatedIndicators/GHG IntensityOfInveste</a><br><a href="#">EETReportType/PrincipalAdverseIndicators/SovereignAndSupranationalInvestments/GreenhouseGasIntensity</a><br><a href="#">EETReportType/PrincipalAdverseIndicators/ClimateAndEnvironmentRelatedIndicators/HazardousWaste</a><br><a href="#">EETReportType/PrincipalAdverseIndicators/MoreSocialAndEmployeeMatters/SovereignAndSupranationalInvestments/NonCooperativeTaxJurisdictions</a><br><a href="#">EETReportType/PrincipalAdverseIndicators/MoreClimateAndEnvironmentRelatedIndicators/WaterWasteAndLandProtection/NonRecycledWasteRatio</a><br><a href="#">EETReportType/PrincipalAdverseIndicators/MoreSocialAndEmployeeMatters/HumanRightsMatters/NumberOfCasesOfSevereHumanRightsIssues</a><br><a href="#">EETReportType/PrincipalAdverseIndicators/SovereignAndSupranationalInvestments/NumberOfCountriesSubjectToSocialViolations</a><br><a href="#">EETReportType/PrincipalAdverseIndicators/MoreSocialAndEmployeeMatters/EmployeeMatters/NumberOfDaysLostForInjuriesAccidentsFatalitiesIllness</a><br><a href="#">EETReportType/PrincipalAdverseIndicators/MoreSocialAndEmployeeMatters/EmployeeMatters/NumberOfIncidentsOfDiscriminationLeadingToSanctions</a><br><a href="#">EETReportType/PrincipalAdverseIndicators/MoreSocialAndEmployeeMatters/EmployeeMatters/NumberOfIncidentsOfDiscriminationReported</a><br><a href="#">EETReportType/PrincipalAdverseIndicators/MoreSocialAndEmployeeMatters/EmployeeMatters/RateOfAccidents</a><br><a href="#">EETReportType/PrincipalAdverseIndicators/MoreClimateAndEnvironmentRelatedIndicators/RealEstateInvestments/GreenhouseGasEmissions/Scope1</a><br><a href="#">EETReportType/PrincipalAdverseIndicators/ClimateAndEnvironmentRelatedIndicators/GreenhousegasEmissions/Scope1</a><br><a href="#">EETReportType/PrincipalAdverseIndicators/MoreClimateAndEnvironmentRelatedIndicators/RealEstateInvestments/GreenhouseGasEmissions/Scope2</a><br><a href="#">EETReportType/PrincipalAdverseIndicators/ClimateAndEnvironmentRelatedIndicators/GreenhousegasEmissions/Scope2</a><br><a href="#">EETReportType/PrincipalAdverseIndicators/MoreClimateAndEnvironmentRelatedIndicators/RealEstateInvestments/GreenhouseGasEmissions/Scope3</a><br><a href="#">EETReportType/PrincipalAdverseIndicators/ClimateAndEnvironmentRelatedIndicators/GreenhousegasEmissions/Scope3</a><br><a href="#">EETReportType/PrincipalAdverseIndicators/MoreClimateAndEnvironmentRelatedIndicators/RealEstateInvestments/GreenhouseGasEmissions/TotalScope12</a><br><a href="#">EETReportType/PrincipalAdverseIndicators/ClimateAndEnvironmentRelatedIndicators/GreenhousegasEmissions/TotalScope12</a><br><a href="#">EETReportType/PrincipalAdverseIndicators/MoreClimateAndEnvironmentRelatedIndicators/RealEstateInvestm</a> |
|---------|----------|---|

|  |  |
|--|--|
|  | <a href="#">ents/GreenhouseGasEmissions/TotalScope123</a><br><a href="#">EETReportType/PrincipalAdverseIndicators/ClimateAndEnvironmentRelatedIndicators/GreenhousegasEmissions/TotalScope123</a><br><a href="#">EETReportType/PrincipalAdverseIndicators/ClimateAndEnvironmentRelatedIndicators/EnergyConsumptionIntensityPerHighImpactClimateSector/NACE Values/Values</a><br><a href="#">EETReportType/PrincipalAdverseIndicators/ClimateAndEnvironmentRelatedIndicators/WaterEmissions</a><br><a href="#">EETReportType/PrincipalAdverseIndicators/MoreClimateAndEnvironmentRelatedIndicators/WaterWasteAndLandProtection/WaterUsageAndRecyclingAmount</a> |
|--|--|

element **ValueStrategyCoverageType/Value**

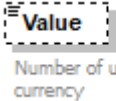
|            |   |
|------------|---|
| diagram    |  |
| type       | <b>xs:decimal</b>   |
| properties | isRef 0<br>minOcc 0<br>maxOcc 1<br>content simple                                 |
| annotation | documentation<br>Number of units in product currency                              |

element **ValueStrategyCoverageType/ConsideredInInvestmentStrategy**

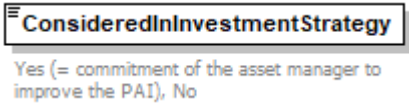
|            |  |
|------------|--|
| diagram    |  |
| type       | <a href="#">EETYesNoType</a>   |
| properties | isRef 0<br>content simple  |
| facets     | Kind Value annotation<br>length 1  |
| annotation | documentation<br>Yes (= commitment of the asset manager to improve the PAI), No    |

element **ValueStrategyCoverageType/Coverage**

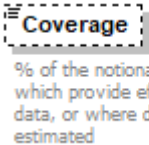
|            |  |
|------------|--|
| diagram    |                         |
| type       | <b>xs:decimal</b>  |
| properties | isRef 0<br>minOcc 0<br>maxOcc 1<br>content simple  |
| annotation | documentation<br>% of the notional / AUM, which provide effectively data, or where data could be estimated |

element **ValueStrategyCoverageType/EligibleAssets**

|            |  |
|------------|--|
| diagram    |  |
| type       | <b>xs:decimal</b>  |
| properties | isRef 0<br>minOcc 0<br>maxOcc 1<br>content simple                              |
| annotation | documentation<br>% of assets (versus notional / AUM), which could provide data |

complexType **ValueStrategyCoverageType1.1**

|          |   |
|----------|---|
| diagram  |   |
| children | <a href="#">Value</a> <a href="#">ConsideredInInvestmentStrategy</a> <a href="#">Coverage</a> <a href="#">EligibleAssets</a>  |
| used by  | elements<br><a href="#">EETReportType1.1.1/PrincipalAdverseIndicators/ClimateAndEnvironmentRelatedIndicators/ActivitiesNegatively AffectingBiodiversitySensitiveAreas</a><br><a href="#">EETReportType1.1/PrincipalAdverseIndicators/ClimateAndEnvironmentRelatedIndicators/ActivitiesNegatively AffectingBiodiversitySensitiveAreas</a><br><a href="#">EETReportType1.1.2/PrincipalAdverseIndicators/ClimateAndEnvironmentRelatedIndicators/ActivitiesNegatively AffectingBiodiversitySensitiveAreas</a><br><a href="#">EETReportType1.1.1/PrincipalAdverseIndicators/MoreSocialAndEmployeeMatters/SovereignAndSupranational Investments/AverageCorruptionScore</a><br><a href="#">EETReportType1.1/PrincipalAdverseIndicators/MoreSocialAndEmployeeMatters/SovereignAndSupranational Investments/AverageCorruptionScore</a><br><a href="#">EETReportType1.1.2/PrincipalAdverseIndicators/MoreSocialAndEmployeeMatters/SovereignAndSupranational Investments/AverageCorruptionScore</a><br><a href="#">EETReportType1.1.2/PrincipalAdverseIndicators/MoreSocialAndEmployeeMatters/SovereignAndSupranational Investments/AverageFreedomOfExpressionScore</a><br><a href="#">EETReportType1.1.1/PrincipalAdverseIndicators/MoreSocialAndEmployeeMatters/SovereignAndSupranational Investments/AverageFreedomOfExpressionScore</a><br><a href="#">EETReportType1.1/PrincipalAdverseIndicators/MoreSocialAndEmployeeMatters/SovereignAndSupranational Investments/AverageFreedomOfExpressionScore</a><br><a href="#">EETReportType1.1.1/PrincipalAdverseIndicators/MoreSocialAndEmployeeMatters/SovereignAndSupranational Investments/AverageHumanRightsPerformance</a><br><a href="#">EETReportType1.1/PrincipalAdverseIndicators/MoreSocialAndEmployeeMatters/SovereignAndSupranational Investments/AverageHumanRightsPerformance</a><br><a href="#">EETReportType1.1.2/PrincipalAdverseIndicators/MoreSocialAndEmployeeMatters/SovereignAndSupranational Investments/AverageHumanRightsPerformance</a><br><a href="#">EETReportType1.1.1/PrincipalAdverseIndicators/MoreSocialAndEmployeeMatters/SovereignAndSupranational Investments/AverageIncomeInequalityScope</a> |

[EETReportType1.1/PrincipalAdverseIndicators/MoreSocialAndEmployeeMatters/SovereignAndSupranationalInvestments/AverageIncomeInequalityScore](#)  
[EETReportType1.1.2/PrincipalAdverseIndicators/MoreSocialAndEmployeeMatters/SovereignAndSupranationalInvestments/AverageIncomeInequalityScore](#)  
[EETReportType1.1.1/PrincipalAdverseIndicators/MoreSocialAndEmployeeMatters/SovereignAndSupranationalInvestments/AveragePoliticalStabilityScore](#)  
[EETReportType1.1.2/PrincipalAdverseIndicators/MoreSocialAndEmployeeMatters/SovereignAndSupranationalInvestments/AveragePoliticalStabilityScore](#)  
[EETReportType1.1/PrincipalAdverseIndicators/MoreSocialAndEmployeeMatters/SovereignAndSupranationalInvestments/AveragePoliticalStabilityScore](#)  
[EETReportType1.1.1/PrincipalAdverseIndicators/MoreSocialAndEmployeeMatters/SovereignAndSupranationalInvestments/AverageRuleOfLawScore](#)  
[EETReportType1.1/PrincipalAdverseIndicators/MoreSocialAndEmployeeMatters/SovereignAndSupranationalInvestments/AverageRuleOfLawScore](#)  
[EETReportType1.1.2/PrincipalAdverseIndicators/MoreSocialAndEmployeeMatters/SovereignAndSupranationalInvestments/AverageRuleOfLawScore](#)  
[EETReportType1.1.2/PrincipalAdverseIndicators/SocialAndEmployeeMatters/BoardGenderDiversity](#)  
[EETReportType1.1/PrincipalAdverseIndicators/SocialAndEmployeeMatters/BoardGenderDiversity](#)  
[EETReportType1.1.1/PrincipalAdverseIndicators/SocialAndEmployeeMatters/BoardGenderDiversity](#)  
[EETReportType1.1.1/PrincipalAdverseIndicators/ClimateAndEnvironmentRelatedIndicators/CarbonFootprintScope12](#)  
[EETReportType1.1/PrincipalAdverseIndicators/ClimateAndEnvironmentRelatedIndicators/CarbonFootprintScope12](#)  
[EETReportType1.1/PrincipalAdverseIndicators/ClimateAndEnvironmentRelatedIndicators/CarbonFootprintScope123](#)  
[EETReportType1.1.1/PrincipalAdverseIndicators/ClimateAndEnvironmentRelatedIndicators/CarbonFootprintScope123](#)  
[EETReportType1.1.2/PrincipalAdverseIndicators/ClimateAndEnvironmentRelatedIndicators/CarbonFootprintScope123](#)  
[EETReportType1.1.1/PrincipalAdverseIndicators/MoreSocialAndEmployeeMatters/CorruptionAndBribery/ConvictionsOfAntiCorruptionAndAntiBriberyLaws](#)  
[EETReportType1.1.2/PrincipalAdverseIndicators/MoreSocialAndEmployeeMatters/CorruptionAndBribery/ConvictionsOfAntiCorruptionAndAntiBriberyLaws](#)  
[EETReportType1.1/PrincipalAdverseIndicators/MoreSocialAndEmployeeMatters/CorruptionAndBribery/ConvictionsOfAntiCorruptionAndAntiBriberyLaws](#)  
[EETReportType1.1.2/PrincipalAdverseIndicators/MoreClimateAndEnvironmentRelatedIndicators/EnergyEfficiency/EmissionsOfAirPollutants](#)  
[EETReportType1.1/PrincipalAdverseIndicators/MoreClimateAndEnvironmentRelatedIndicators/EnergyEfficiency/EmissionsOfAirPollutants](#)  
[EETReportType1.1.1/PrincipalAdverseIndicators/MoreClimateAndEnvironmentRelatedIndicators/EnergyEfficiency/EmissionsOfAirPollutants](#)  
[EETReportType1.1.2/PrincipalAdverseIndicators/MoreClimateAndEnvironmentRelatedIndicators/EnergyEfficiency/EmissionsOfInorganicPollutants](#)  
[EETReportType1.1.1/PrincipalAdverseIndicators/MoreClimateAndEnvironmentRelatedIndicators/EnergyEfficiency/EmissionsOfInorganicPollutants](#)  
[EETReportType1.1/PrincipalAdverseIndicators/MoreClimateAndEnvironmentRelatedIndicators/EnergyEfficiency/EmissionsOfInorganicPollutants](#)  
[EETReportType1.1/PrincipalAdverseIndicators/MoreClimateAndEnvironmentRelatedIndicators/EnergyEfficiency/EmissionsOfOzoneDepletionSubstances](#)  
[EETReportType1.1.2/PrincipalAdverseIndicators/MoreClimateAndEnvironmentRelatedIndicators/EnergyEfficiency/EmissionsOfOzoneDepletionSubstances](#)  
[EETReportType1.1.1/PrincipalAdverseIndicators/MoreClimateAndEnvironmentRelatedIndicators/EnergyEfficiency/EmissionsOfOzoneDepletionSubstances](#)  
[EETReportType1.1/PrincipalAdverseIndicators/MoreClimateAndEnvironmentRelatedIndicators/RealEstateInvestments/EnergyConsumptionIntensity](#)  
[EETReportType1.1.2/PrincipalAdverseIndicators/MoreClimateAndEnvironmentRelatedIndicators/RealEstateInvestments/EnergyConsumptionIntensity](#)  
[EETReportType1.1.1/PrincipalAdverseIndicators/MoreClimateAndEnvironmentRelatedIndicators/RealEstateInvestments/EnergyConsumptionIntensity](#)  
[EETReportType1.1/PrincipalAdverseIndicators/MoreSocialAndEmployeeMatters/EmployeeMatters/ExcessiveCEOPayRatio](#)  
[EETReportType1.1.1/PrincipalAdverseIndicators/MoreSocialAndEmployeeMatters/EmployeeMatters/ExcessiveCEOPayRatio](#)  
[EETReportType1.1.2/PrincipalAdverseIndicators/MoreSocialAndEmployeeMatters/EmployeeMatters/ExcessiveCEOPayRatio](#)  
[EETReportType1.1/PrincipalAdverseIndicators/ClimateAndEnvironmentRelatedIndicators/GHG IntensityOfInvesteeCompaniesScope12](#)  
[EETReportType1.1.1/PrincipalAdverseIndicators/ClimateAndEnvironmentRelatedIndicators/GHG IntensityOfInvesteeCompaniesScope12](#)  
[EETReportType1.1/PrincipalAdverseIndicators/ClimateAndEnvironmentRelatedIndicators/GHG IntensityOfInvesteeCompaniesScope12](#)

[steeCompaniesScope123](#)  
[EETReportType1.1.1/PrincipalAdverseIndicators/ClimateAndEnvironmentRelatedIndicators/GHG IntensityOfInvesteeCompaniesScope123](#)  
[EETReportType1.1.2/PrincipalAdverseIndicators/ClimateAndEnvironmentRelatedIndicators/GHG IntensityOfInvesteeCompaniesScope123](#)  
[EETReportType1.1.2/PrincipalAdverseIndicators/SovereignAndSupranationalInvestments/GreenhouseGasIntensity](#)  
[EETReportType1.1/PrincipalAdverseIndicators/SovereignAndSupranationalInvestments/GreenhouseGasIntensity](#)  
[EETReportType1.1.1/PrincipalAdverseIndicators/SovereignAndSupranationalInvestments/GreenhouseGasIntensity](#)  
[EETReportType1.1.2/PrincipalAdverseIndicators/ClimateAndEnvironmentRelatedIndicators/HazardousWaste](#)  
[EETReportType1.1/PrincipalAdverseIndicators/ClimateAndEnvironmentRelatedIndicators/HazardousWaste](#)  
[EETReportType1.1.1/PrincipalAdverseIndicators/ClimateAndEnvironmentRelatedIndicators/HazardousWaste](#)  
[EETReportType1.1/PrincipalAdverseIndicators/MoreSocialAndEmployeeMatters/SovereignAndSupranationalInvestments/NonCooperativeTaxJurisdictions](#)  
[EETReportType1.1.1/PrincipalAdverseIndicators/MoreSocialAndEmployeeMatters/SovereignAndSupranationalInvestments/NonCooperativeTaxJurisdictions](#)  
[EETReportType1.1.2/PrincipalAdverseIndicators/MoreSocialAndEmployeeMatters/SovereignAndSupranationalInvestments/NonCooperativeTaxJurisdictions](#)  
[EETReportType1.1.1/PrincipalAdverseIndicators/MoreClimateAndEnvironmentRelatedIndicators/WaterWasteAndLandProtection/NonRecycledWasteRatio](#)  
[EETReportType1.1.2/PrincipalAdverseIndicators/MoreClimateAndEnvironmentRelatedIndicators/WaterWasteAndLandProtection/NonRecycledWasteRatio](#)  
[EETReportType1.1/PrincipalAdverseIndicators/MoreClimateAndEnvironmentRelatedIndicators/WaterWasteAndLandProtection/NonRecycledWasteRatio](#)  
[EETReportType1.1/PrincipalAdverseIndicators/MoreSocialAndEmployeeMatters/HumanRightsMatters/NumberOfCasesOfSevereHumanRightsIssues](#)  
[EETReportType1.1.1/PrincipalAdverseIndicators/MoreSocialAndEmployeeMatters/HumanRightsMatters/NumberOfCasesOfSevereHumanRightsIssues](#)  
[EETReportType1.1.2/PrincipalAdverseIndicators/MoreSocialAndEmployeeMatters/HumanRightsMatters/NumberOfCasesOfSevereHumanRightsIssues](#)  
[EETReportType1.1.2/PrincipalAdverseIndicators/SovereignAndSupranationalInvestments/NumberOfCountriesSubjectToSocialViolations](#)  
[EETReportType1.1.1/PrincipalAdverseIndicators/SovereignAndSupranationalInvestments/NumberOfCountriesSubjectToSocialViolations](#)  
[EETReportType1.1/PrincipalAdverseIndicators/SovereignAndSupranationalInvestments/NumberOfCountriesSubjectToSocialViolations](#)  
[EETReportType1.1/PrincipalAdverseIndicators/MoreSocialAndEmployeeMatters/EmployeeMatters/NumberOfDaysLostForInjuriesAccidentsFatalitiesIllness](#)  
[EETReportType1.1.1/PrincipalAdverseIndicators/MoreSocialAndEmployeeMatters/EmployeeMatters/NumberOfDaysLostForInjuriesAccidentsFatalitiesIllness](#)  
[EETReportType1.1.2/PrincipalAdverseIndicators/MoreSocialAndEmployeeMatters/EmployeeMatters/NumberOfDaysLostForInjuriesAccidentsFatalitiesIllness](#)  
[EETReportType1.1/PrincipalAdverseIndicators/MoreSocialAndEmployeeMatters/EmployeeMatters/NumberOfIncidentsOfDiscriminationLeadingToSanctions](#)  
[EETReportType1.1.1/PrincipalAdverseIndicators/MoreSocialAndEmployeeMatters/EmployeeMatters/NumberOfIncidentsOfDiscriminationLeadingToSanctions](#)  
[EETReportType1.1.2/PrincipalAdverseIndicators/MoreSocialAndEmployeeMatters/EmployeeMatters/NumberOfIncidentsOfDiscriminationLeadingToSanctions](#)  
[EETReportType1.1/PrincipalAdverseIndicators/MoreSocialAndEmployeeMatters/EmployeeMatters/NumberOfIncidentsOfDiscriminationReported](#)  
[EETReportType1.1.2/PrincipalAdverseIndicators/MoreSocialAndEmployeeMatters/EmployeeMatters/NumberOfIncidentsOfDiscriminationReported](#)  
[EETReportType1.1.1/PrincipalAdverseIndicators/MoreSocialAndEmployeeMatters/EmployeeMatters/NumberOfIncidentsOfDiscriminationReported](#)  
[EETReportType1.1/PrincipalAdverseIndicators/MoreSocialAndEmployeeMatters/EmployeeMatters/RateOfAccidents](#)  
[EETReportType1.1.2/PrincipalAdverseIndicators/MoreSocialAndEmployeeMatters/EmployeeMatters/RateOfAccidents](#)  
[EETReportType1.1.1/PrincipalAdverseIndicators/MoreSocialAndEmployeeMatters/EmployeeMatters/RateOfAccidents](#)  
[EETReportType1.1/PrincipalAdverseIndicators/ClimateAndEnvironmentRelatedIndicators/GreenhousegasEmissions/Scope1](#)  
[EETReportType1.1.2/PrincipalAdverseIndicators/ClimateAndEnvironmentRelatedIndicators/GreenhousegasEmissions/Scope1](#)  
[EETReportType1.1.1/PrincipalAdverseIndicators/MoreClimateAndEnvironmentRelatedIndicators/RealEstateInvestments/GreenhouseGasEmissions/Scope1](#)  
[EETReportType1.1/PrincipalAdverseIndicators/MoreClimateAndEnvironmentRelatedIndicators/RealEstateInvestments/GreenhouseGasEmissions/Scope1](#)



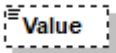

element **ValueStrategyCoverageType1.1/Value**

|            |   |
|------------|---|
| diagram    |  |
| type       | <b>xs:decimal</b>   |
| properties | isRef 0<br>minOcc 0<br>maxOcc 1<br>content simple                                 |

element **ValueStrategyCoverageType1.1/ConsideredInInvestmentStrategy**

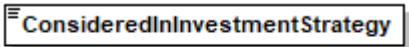
|            |   |
|------------|---|
| diagram    | <br>Yes (= commitment of the asset manager to improve the PAI), No |
| type       | <a href="#">EETYesNoType</a>  |
| properties | isRef 0<br>content simple   |
| facets     | Kind Value annotation<br>length 1   |
| annotation | documentation<br>Yes (= commitment of the asset manager to improve the PAI), No   |

element **ValueStrategyCoverageType1.1/Coverage**

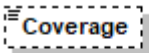
|            |  |
|------------|--|
| diagram    | <br>% of the notional / AUM, which provide effectively data, or where data could be estimated |
| type       | <b>xs:decimal</b>  |
| properties | isRef 0<br>minOcc 0<br>maxOcc 1<br>content simple  |
| annotation | documentation<br>% of the notional / AUM, which provide effectively data, or where data could be estimated   |

element **ValueStrategyCoverageType1.1/EligibleAssets**

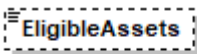
|            |  |
|------------|--|
| diagram    | <br>% of assets (versus notional / AUM), which could provide data |
| type       | <b>xs:decimal</b>  |
| properties | isRef 0<br>minOcc 0<br>maxOcc 1<br>content simple  |
| annotation | documentation<br>% of assets (versus notional / AUM), which could provide data   |

complexType **ValueStrategyCoverageType1.1.2**

|          |  |
|----------|--|
| diagram  |  |
| children | <a href="#">Value</a> <a href="#">ConsideredInInvestmentStrategy</a> <a href="#">Coverage</a> <a href="#">EligibleAssets</a>   |
| used by  | <p>elements</p> <p><a href="#">EETReportType1.1.2/PrincipalAdverseIndicators/ClimateAndEnvironmentRelatedIndicators/CarbonFootprintScope12</a><br/> <a href="#">EETReportType1.1.2/PrincipalAdverseIndicators/ClimateAndEnvironmentRelatedIndicators/GHG_IntensityOfInvesteeCompaniesScope12</a><br/> <a href="#">EETReportType1.1.2/PrincipalAdverseIndicators/ClimateAndEnvironmentRelatedIndicators/GreenhousegasEmissions/TotalScope12</a></p> |

element **ValueStrategyCoverageType1.1.2/Value**

|            |  |
|------------|--|
| diagram    |  |
| type       | <b>xs:decimal</b>  |
| properties | <p>isRef 0<br/> minOcc 0<br/> maxOcc 1<br/> content simple</p> |

element **ValueStrategyCoverageType1.1.2/ConsideredInInvestmentStrategy**

|            |  |
|------------|--|
| diagram    |  |
| type       | <a href="#">EETYesNoType</a>   |
| properties | <p>isRef 0<br/> minOcc 0<br/> maxOcc 1<br/> content simple</p>                           |
| facets     | <p>Kind Value annotation<br/> length 1</p>   |
| annotation | <p>documentation<br/> Yes (= commitment of the asset manager to improve the PAI), No</p> |

element **ValueStrategyCoverageType1.1.2/Coverage**

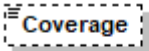
|            |  |
|------------|--|
| diagram    |  <p>% of the notional / AUM, which provide effectively data, or where data could be estimated</p> |
| type       | <b>xs:decimal</b>  |
| properties | isRef 0<br>minOcc 0<br>maxOcc 1<br>content simple  |
| annotation | documentation<br>% of the notional / AUM, which provide effectively data, or where data could be estimated   |

element **ValueStrategyCoverageType1.1.2/EligibleAssets**

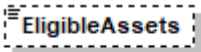
|            |  |
|------------|--|
| diagram    |  <p>% of assets (versus notional / AUM), which could provide data</p> |
| type       | <b>xs:decimal</b>  |
| properties | isRef 0<br>minOcc 0<br>maxOcc 1<br>content simple  |
| annotation | documentation<br>% of assets (versus notional / AUM), which could provide data   |

simpleType **EETYesNeutralType**

|            |  |
|------------|--|
| type       | restriction of <b>xs:string</b>  |
| properties | base xs:string   |
| used by    | elements <a href="#">EETReportType/MiFID IDD TargetMarket/End Client Sustainability Preferences Considered</a><br><a href="#">EETReportType1.1/MiFID IDD TargetMarket/End Client Sustainability Preferences Considered</a><br><a href="#">EETReportType1.1.1/MiFIDIDDTargetMarket/EndClientSustainabilityPreferences Considered</a><br><a href="#">EETReportType1.1.2/MiFIDIDDTargetMarket/EndClientSustainabilityPreferences Considered</a> |
| facets     | Kind Value annotation<br>minLength 1<br>maxLength 7  |

simpleType **EETYesNoNeutralType**

|            |   |
|------------|---|
| type       | restriction of <b>xs:string</b>                     |
| properties | base xs:string                                      |
| facets     | Kind Value annotation<br>minLength 1<br>maxLength 7 |

simpleType **EETYesNoType**

|      |                                 |
|------|---------------------------------|
| type | restriction of <b>xs:string</b> |
|------|---------------------------------|

|            |   |
|------------|---|
| properties | base xs:string  |
| used by    | <p>elements</p> <p> <a href="#">EETReportType1.1.1/AdditionalInfoArt9/AlignedWithParisAgreement</a><br/> <a href="#">EETReportType1.1.2/AdditionalInfoArt9/AlignedWithParisAgreement</a><br/> <a href="#">EETReportType1.1/AdditionalInfoArt9/AlignedWithParisAgreement</a><br/> <a href="#">EETReportType/AdditionalInfoArt9/AlignedWithParisAgreement</a> <a href="#">EETExclusionType1.1/Applied</a><br/> <a href="#">EETEnhancedExclusionType1.1/Applied</a> <a href="#">EETEnhancedExclusionType/Applied</a> <a href="#">EETExclusionType/Applied</a><br/> <a href="#">EETReportType1.1.1/ScreeningCriteria/RealEstateExclusions/BiodiversityMonitoring</a><br/> <a href="#">EETReportType1.1/ScreeningCriteria/RealEstateExclusions/BiodiversityMonitoring</a><br/> <a href="#">EETReportType/ScreeningCriteria/RealEstateExclusions/BiodiversityMonitoring</a><br/> <a href="#">EETReportType1.1.2/ScreeningCriteria/RealEstateExclusions/BiodiversityMonitoring</a><br/> <a href="#">EETReportType/TaxonomyAlignedInvestments/ClimateChangeAdaptation</a><br/> <a href="#">EETReportType1.1/TaxonomyAlignedInvestments/ClimateChangeAdaptationPercentage</a><br/> <a href="#">EETReportType/TaxonomyAlignedInvestments/ClimateChangeMitigation</a><br/> <a href="#">EETReportType1.1/TaxonomyAlignedInvestments/ClimateChangeMitigationPercentage</a><br/> <a href="#">ValueStrategyCoverageType1.1.2/ConsideredInInvestmentStrategy</a><br/> <a href="#">PercentageStrategyCoverageType/ConsideredInInvestmentStrategy</a><br/> <a href="#">PercentageStrategyCoverageType1.1.2/ConsideredInInvestmentStrategy</a><br/> <a href="#">ValueStrategyCoverageType1.1/ConsideredInInvestmentStrategy</a><br/> <a href="#">ValueStrategyCoverageType/ConsideredInInvestmentStrategy</a><br/> <a href="#">PercentageStrategyCoverageType1.1/ConsideredInInvestmentStrategy</a><br/> <a href="#">EETReportType/MainCriterias/ConsidersPrincipleAdverseImpact</a><br/> <a href="#">EETReportType1.1.2/MainCriterias/ConsidersPrincipleAdverseImpact</a><br/> <a href="#">EETReportType1.1.1/MainCriterias/ConsidersPrincipleAdverseImpact</a><br/> <a href="#">EETReportType1.1/MainCriterias/ConsidersPrincipleAdverseImpact</a><br/> <a href="#">EETReportType1.1.2/ScreeningCriteria/SovereignLevelExclusions/CorruptionExclusion</a><br/> <a href="#">EETReportType1.1/ScreeningCriteria/SovereignLevelExclusions/CorruptionExclusion</a><br/> <a href="#">EETReportType/ScreeningCriteria/SovereignLevelExclusions/CorruptionExclusion</a><br/> <a href="#">EETReportType1.1.1/ScreeningCriteria/SovereignLevelExclusions/CorruptionExclusion</a><br/> <a href="#">EETReportType/ScreeningCriteria/SovereignLevelExclusions/DeathSentenceExclusion</a><br/> <a href="#">EETReportType1.1/ScreeningCriteria/SovereignLevelExclusions/DeathSentenceExclusion</a><br/> <a href="#">EETReportType1.2/ScreeningCriteria/SovereignLevelExclusions/DeathSentenceExclusion</a><br/> <a href="#">EETReportType1.1.1/ScreeningCriteria/SovereignLevelExclusions/DeathSentenceExclusion</a><br/> <a href="#">EETReportType1.1/ScreeningCriteria/RealEstateExclusions/EnergyConsumptionMonitoring</a><br/> <a href="#">EETReportType/ScreeningCriteria/RealEstateExclusions/EnergyConsumptionMonitoring</a><br/> <a href="#">EETReportType1.1.1/ScreeningCriteria/RealEstateExclusions/EnergyConsumptionMonitoring</a><br/> <a href="#">EETReportType1.1.2/ScreeningCriteria/RealEstateExclusions/EnergyConsumptionMonitoring</a><br/> <a href="#">EETReportType1.1.1/ScreeningCriteria/RealEstateExclusions/EnvironmentalHealthMonitoring</a><br/> <a href="#">EETReportType/ScreeningCriteria/RealEstateExclusions/EnvironmentalHealthMonitoring</a><br/> <a href="#">EETReportType1.1.2/ScreeningCriteria/RealEstateExclusions/EnvironmentalHealthMonitoring</a><br/> <a href="#">EETReportType1.1/ScreeningCriteria/RealEstateExclusions/EnvironmentalHealthMonitoring</a><br/> <a href="#">EETReportType1.1.1/SpecificInformationForArt8and9/EnvironmentallySustainableInvestmentEUTaxonomyArt9</a><br/> <a href="#">EETReportType1.1/SpecificInformationForArt8and9/EnvironmentallySustainableInvestmentEUTaxonomyArt9</a><br/> <a href="#">EETReportType/SpecificInformationForArt8and9/EnvironmentallySustainableInvestmentEUTaxonomyArt9</a><br/> <a href="#">EETReportType1.1.2/SpecificInformationForArt8and9/EnvironmentallySustainableInvestmentEUTaxonomyArt9</a><br/> <a href="#">EETReportType1.1/SpecificInformationForArt8and9/EnvironmentallySustainableInvestmentNotEUTaxonomyArt9</a><br/> <a href="#">EETReportType1.1.2/SpecificInformationForArt8and9/EnvironmentallySustainableInvestmentNotEUTaxonomyArt9</a><br/> <a href="#">EETReportType1.1.1/SpecificInformationForArt8and9/EnvironmentallySustainableInvestmentNotEUTaxonomyArt9</a><br/> <a href="#">EETReportType/SpecificInformationForArt8and9/EnvironmentallySustainableInvestmentNotEUTaxonomyArt9</a> <a href="#">EETReportType/ESG ThematicInvestingDescription/ESG ExistingThematic</a><br/> <a href="#">EETReportType1.1.1/ESGThematicInvestingDescription/ESGExistingThematicCharacteristics</a><br/> <a href="#">EETReportType1.1.2/ESGThematicInvestingDescription/ESGExistingThematicCharacteristics</a><br/> <a href="#">EETReportType1.1/ESG ThematicInvestingDescription/ESGExistingThematicCharacteristics</a><br/> <a href="#">EETReportType1.1.2/ScreeningCriteria/ExistingNegativeScreeningStrategy</a><br/> <a href="#">EETReportType1.1/ScreeningCriteria/ExistingNegativeScreeningStrategy</a><br/> <a href="#">EETReportType/ScreeningCriteria/ExistingNegativeScreeningStrategy</a><br/> <a href="#">EETReportType1.1.1/ScreeningCriteria/ExistingNegativeScreeningStrategy</a><br/> <a href="#">EETReportType/ScreeningCriteria/RealEstateExclusions/GreenhouseGasEmissionMonitoring</a><br/> <a href="#">EETReportType1.1/ScreeningCriteria/RealEstateExclusions/GreenhouseGasEmissionMonitoring</a><br/> <a href="#">EETReportType1.1.2/ScreeningCriteria/RealEstateExclusions/GreenhouseGasEmissionMonitoring</a><br/> <a href="#">EETReportType1.1.1/ScreeningCriteria/RealEstateExclusions/GreenhouseGasEmissionMonitoring</a><br/> <a href="#">EETReportType/ESG Benchmark/HasReference</a> <a href="#">ESG Benchmark</a><br/> <a href="#">EETReportType1.1/ESG Benchmark/HasReference</a> <a href="#">ESG Benchmark</a> </p> |

[EETReportType1.1.2/ESGBenchmark/HasReferenceESGBenchmark](#)  
[EETReportType1.1.1/ESGBenchmark/HasReferenceESGBenchmark](#)  
[EETReportType/DataSetInformation/DataSetInformation/DataReporting/IDD](#)  
[EETReportType1.1.2/DataSetInformation/DataSetInformation/DataReporting/IDD](#)  
[EETReportType1.1.1/DataSetInformation/DataSetInformation/DataReporting/IDD](#)  
[EETReportType1.1/DataSetInformation/DataSetInformation/DataReporting/IDD](#)  
[EETReportType1.1.1/ScreeningCriteria/NormBasedExclusions/ILO Exclusion](#)  
[EETReportType1.1/ScreeningCriteria/NormBasedExclusions/ILO Exclusion](#)  
[EETReportType/ScreeningCriteria/NormBasedExclusions/ILO Exclusion](#)  
[EETReportType1.1.2/ScreeningCriteria/NormBasedExclusions/ILO Exclusion](#)  
[EETReportType1.1.1/SupplementaryTaxonomyInformationV1.1.1/InvestingInEUTaxonomyAlignedFossilGasActivities](#)  
[EETReportType1.1.2/SupplementaryTaxonomyInformationV1.1.1/InvestingInEUTaxonomyAlignedFossilGasActivities](#)  
[EETReportType1.1.1/SupplementaryTaxonomyInformationV1.1.1/InvestingInEUTaxonomyAlignedNuclearActivities](#)  
[EETReportType1.1.2/SupplementaryTaxonomyInformationV1.1.1/InvestingInEUTaxonomyAlignedNuclearActivities](#)  
[EETReportType/DataSetInformation/DataSetInformation/DataReporting/MiFID](#)  
[EETReportType1.1.1/DataSetInformation/DataSetInformation/DataReporting/MiFID](#)  
[EETReportType1.1.2/DataSetInformation/DataSetInformation/DataReporting/MiFID](#)  
[EETReportType1.1/DataSetInformation/DataSetInformation/DataReporting/MiFID](#)  
[EETEnhancedExclusionType/NewInfrastructure](#)  
[EETEnhancedExclusionType1.1/NewInfrastructure](#)  
[EETReportType/ScreeningCriteria/SovereignLevelExclusions/NonProliferationTreatyOfNuclearWeapons](#)  
[EETReportType1.1.2/ScreeningCriteria/SovereignLevelExclusions/NonProliferationTreatyOfNuclearWeapons](#)  
[EETReportType1.1.1/ScreeningCriteria/SovereignLevelExclusions/NonProliferationTreatyOfNuclearWeapons](#)  
[EETReportType1.1/ScreeningCriteria/SovereignLevelExclusions/NonProliferationTreatyOfNuclearWeapons](#)  
[EETReportType/ScreeningCriteria/SovereignLevelExclusions/NonRatificationOfParisAgreementExclusion](#)  
[EETReportType1.1.1/ScreeningCriteria/SovereignLevelExclusions/NonRatificationOfParisAgreementExclusion](#)  
[EETReportType1.1/ScreeningCriteria/SovereignLevelExclusions/NonRatificationOfParisAgreementExclusion](#)  
[EETReportType1.1.2/ScreeningCriteria/SovereignLevelExclusions/NonRatificationOfParisAgreementExclusion](#)  
[EETReportType1.1.1/ScreeningCriteria/SovereignLevelExclusions/NuclearWeaponsExclusion](#)  
[EETReportType/ScreeningCriteria/SovereignLevelExclusions/NuclearWeaponsExclusion](#)  
[EETReportType1.1.2/ScreeningCriteria/SovereignLevelExclusions/NuclearWeaponsExclusion](#)  
[EETReportType1.1/ScreeningCriteria/SovereignLevelExclusions/NuclearWeaponsExclusion](#)  
[EETReportType1.1/AdditionalInfoArt9/ObjectiveReductionInCarbonEmissions](#)  
[EETReportType/AdditionalInfoArt9/ObjectiveReductionInCarbonEmissions](#)  
[EETReportType1.1.2/AdditionalInfoArt9/ObjectiveReductionInCarbonEmissions](#)  
[EETReportType1.1.1/AdditionalInfoArt9/ObjectiveReductionInCarbonEmissions](#)  
[EETReportType1.1.2/ScreeningCriteria/NormBasedExclusions/OECD Guidelines Exclusion](#)  
[EETReportType1.1/ScreeningCriteria/NormBasedExclusions/OECD Guidelines Exclusion](#)  
[EETReportType/ScreeningCriteria/NormBasedExclusions/OECD Guidelines Exclusion](#)  
[EETReportType1.1.1/ScreeningCriteria/NormBasedExclusions/OECD Guidelines Exclusion](#)  
[EETReportType/TaxonomyAlignedInvestments/PollutionPreventionAndControl](#)  
[EETReportType1.1/TaxonomyAlignedInvestments/PollutionPreventionAndControlPercentage](#)  
[EETReportType/DataSetInformation/ManufacturerCommitmentToResponsibleInvestment/PRI Or PRB Compliant](#)  
[EETReportType/DataSetInformation/ManufacturerCommitmentToResponsibleInvestment/PRI Or PRB Like](#)  
[EETReportType1.1/DataSetInformation/ManufacturerCommitmentToResponsibleInvestment/PRI Or PRB Like](#)  
[EETReportType/DataSetInformation/ManufacturerCommitmentToResponsibleInvestment/PRI Or PRB Signatory](#)  
[EETReportType1.1.2/DataSetInformation/ManufacturerCommitmentToResponsibleInvestment/PRIOrPRBCompliant](#)  
[EETReportType1.1/DataSetInformation/ManufacturerCommitmentToResponsibleInvestment/PRIOrPRBCompliant](#)  
[EETReportType1.1.1/DataSetInformation/ManufacturerCommitmentToResponsibleInvestment/PRIOrPRBCompliant](#)  
[EETReportType1.1.1/DataSetInformation/ManufacturerCommitmentToResponsibleInvestment/PRIOrPRBLike](#)  
[EETReportType1.1.2/DataSetInformation/ManufacturerCommitmentToResponsibleInvestment/PRIOrPRBLike](#)  
[EETReportType1.1/DataSetInformation/ManufacturerCommitmentToResponsibleInvestment/PRIOrPRBSignatory](#)  
[EETReportType1.1.2/DataSetInformation/ManufacturerCommitmentToResponsibleInvestment/PRIOrPRBSignatory](#)

[ignatory](#)  
[EETReportType1.1.1/DataSetInformation/ManufacturerCommitmentToResponsibleInvestment/PRIOrPRBS](#)  
[ignatory](#)  
[EETReportType/TaxonomyAlignedInvestments/ProtectionAndRestorationOfBiodiversityAndEcosystems](#)  
[EETReportType1.1/TaxonomyAlignedInvestments/ProtectionAndRestorationOfBiodiversityAndEcosystem](#)  
[sPercentage](#) [EETReportType1.1/ScreeningCriteria/RealEstateExclusions/SafetyMonitoring](#)  
[EETReportType1.1.1/ScreeningCriteria/RealEstateExclusions/SafetyMonitoring](#)  
[EETReportType1.1.2/ScreeningCriteria/RealEstateExclusions/SafetyMonitoring](#)  
[EETReportType/ScreeningCriteria/RealEstateExclusions/SafetyMonitoring](#)  
[EETReportType/DataSetInformation/DataSetInformation/DataReporting/SFDR\\_EntityLevel](#)  
[EETReportType1.1/DataSetInformation/DataSetInformation/DataReporting/SFDR\\_EntityLevel](#)  
[EETReportType/DataSetInformation/DataSetInformation/DataReporting/SFDR\\_Periodic](#)  
[EETReportType1.1/DataSetInformation/DataSetInformation/DataReporting/SFDR\\_Periodic](#)  
[EETReportType1.1/DataSetInformation/DataSetInformation/DataReporting/SFDR\\_PreContractual](#)  
[EETReportType/DataSetInformation/DataSetInformation/DataReporting/SFDR\\_PreContractual](#)  
[EETReportType1.1.2/DataSetInformation/DataSetInformation/DataReporting/SFDREntityLevel](#)  
[EETReportType1.1.1/DataSetInformation/DataSetInformation/DataReporting/SFDREntityLevel](#)  
[EETReportType1.1.1/DataSetInformation/DataSetInformation/DataReporting/SFDRPeriodic](#)  
[EETReportType1.1.2/DataSetInformation/DataSetInformation/DataReporting/SFDRPeriodic](#)  
[EETReportType1.1.2/DataSetInformation/DataSetInformation/DataReporting/SFDRPreContractual](#)  
[EETReportType1.1.1/DataSetInformation/DataSetInformation/DataReporting/SFDRPreContractual](#)  
[EETReportType1.1.1/TaxonomyAlignedInvestments/SubjectToExternalReviewByThirdParty](#)  
[EETReportType1.1.2/TaxonomyAlignedInvestments/SubjectToExternalReviewByThirdParty](#)  
[EETReportType/TaxonomyAlignedInvestments/SubjectToExternalReviewByThirdParty](#)  
[EETReportType1.1/TaxonomyAlignedInvestments/SubjectToExternalReviewByThirdParty](#)  
[EETReportType1.1/ScreeningCriteria/RealEstateExclusions/SupplierMonitoring](#)  
[EETReportType1.1.2/ScreeningCriteria/RealEstateExclusions/SupplierMonitoring](#)  
[EETReportType1.1.1/ScreeningCriteria/RealEstateExclusions/SupplierMonitoring](#)  
[EETReportType/ScreeningCriteria/RealEstateExclusions/SupplierMonitoring](#)  
[EETReportType1.1/SupplementaryFieldsV1.1/SustainabilityRisksDemedToBeRelevant](#)  
[EETReportType1.1.1/SupplementaryFieldsV1.1/SustainabilityRisksDemedToBeRelevant](#)  
[EETReportType1.1.2/SupplementaryFieldsV1.1/SustainabilityRisksDemedToBeRelevant](#)  
[EETReportType/SpecificInformationForArt8and9/SustainableInvestmentEnvironmentalNotEUTaxonomyAr](#)  
[t8](#)  
[EETReportType1.1.1/SpecificInformationForArt8and9/SustainableInvestmentEnvironmentalNotEUTaxono](#)  
[myArt8](#)  
[EETReportType1.1.2/SpecificInformationForArt8and9/SustainableInvestmentEnvironmentalNotEUTaxono](#)  
[myArt8](#)  
[EETReportType1.1/SpecificInformationForArt8and9/SustainableInvestmentEnvironmentalNotEUTaxonom](#)  
[yArt8](#) [EETReportType/SpecificInformationForArt8and9/SustainableInvestmentEUTaxonomyArt8](#)  
[EETReportType1.1.1/SpecificInformationForArt8and9/SustainableInvestmentEUTaxonomyArt8](#)  
[EETReportType1.1.2/SpecificInformationForArt8and9/SustainableInvestmentEUTaxonomyArt8](#)  
[EETReportType1.1/SpecificInformationForArt8and9/SustainableInvestmentEUTaxonomyArt8](#)  
[EETReportType/SpecificInformationForArt8and9/SustainableInvestmentsArt8](#)  
[EETReportType1.1.2/SpecificInformationForArt8and9/SustainableInvestmentsArt8](#)  
[EETReportType1.1.1/SpecificInformationForArt8and9/SustainableInvestmentsArt8](#)  
[EETReportType/SpecificInformationForArt8and9/SustainableInvestmentSocialObjectiveArt8](#)  
[EETReportType1.1.2/SpecificInformationForArt8and9/SustainableInvestmentSocialObjectiveArt8](#)  
[EETReportType1.1.1/SpecificInformationForArt8and9/SustainableInvestmentSocialObjectiveArt8](#)  
[EETReportType1.1/SpecificInformationForArt8and9/SustainableInvestmentSocialObjectiveArt8](#)  
[EETReportType/TaxonomyAlignedInvestments/SustainableUseAndProtectionOfWaterAndMarineResource](#)  
[s](#)  
[EETReportType1.1/TaxonomyAlignedInvestments/SustainableUseAndProtectionOfWaterAndMarineResou](#)  
[rcesPercentage](#) [EETReportType/TaxonomyAlignedInvestments/TransitionToCircularEconomy](#)  
[EETReportType1.1/TaxonomyAlignedInvestments/TransitionToCircularEconomyPercentage](#)  
[EETReportType1.1.1/ScreeningCriteria/NormBasedExclusions/UNGC\\_Exclusion](#)  
[EETReportType1.1/ScreeningCriteria/NormBasedExclusions/UNGC\\_Exclusion](#)  
[EETReportType1.1.2/ScreeningCriteria/NormBasedExclusions/UNGC\\_Exclusion](#)  
[EETReportType/ScreeningCriteria/NormBasedExclusions/UNGC\\_Exclusion](#)  
[EETReportType1.1.2/StructuredProductsAdditionalInformation/UseOfDerivativeExposure](#)  
[EETReportType1.1.1/StructuredProductsAdditionalInformation/UseOfDerivativeExposure](#)  
[EETReportType1.1/StructuredProductsAdditionalInformation/UseOfDerivativeExposure](#)  
[EETReportType1.1.1/ScreeningCriteria/SovereignLevelExclusions/WarExclusion](#)  
[EETReportType/ScreeningCriteria/SovereignLevelExclusions/WarExclusion](#)  
[EETReportType1.1/ScreeningCriteria/SovereignLevelExclusions/WarExclusion](#)  
[EETReportType1.1.2/ScreeningCriteria/SovereignLevelExclusions/WarExclusion](#)  
[EETReportType/ScreeningCriteria/RealEstateExclusions/WasteFinancialInstrumentationMonitoring](#)  
[EETReportType1.1/ScreeningCriteria/RealEstateExclusions/WasteFinancialInstrumentationMonitoring](#)  
[EETReportType1.1.1/ScreeningCriteria/RealEstateExclusions/WasteFinancialInstrumentMonitoring](#)

|            |   |
|------------|---|
|            | <a href="#">EETReportType1.1.2/ScreeningCriteria/RealEstateExclusions/WasteFinancialInstrumentMonitoring</a><br><a href="#">EETReportType1.1.1/ScreeningCriteria/RealEstateExclusions/WaterConsumptionMonitoring</a><br><a href="#">EETReportType1.1.2/ScreeningCriteria/RealEstateExclusions/WaterConsumptionMonitoring</a><br><a href="#">EETReportType1.1/ScreeningCriteria/RealEstateExclusions/WaterConsumptionMonitoring</a><br><a href="#">EETReportType/ScreeningCriteria/RealEstateExclusions/WaterConsumptionMonitoring</a> |
| facets     | Kind Value annotation<br>length 1   |
| annotation | documentation<br>Y or N   |

### complexType CountrySpecificAssetMasterDataAType

|          |  |
|----------|--|
| diagram  |  |
| children | <a href="#">OeKBStammdatenblatt</a>                      |
| used by  | element <a href="#">AssetType/CountrySpecificData/AT</a> |

### element CountrySpecificAssetMasterDataAType/OeKBStammdatenblatt

|            |   |
|------------|---|
| diagram    |   |
| properties | isRef 0<br>minOcc 0<br>maxOcc 1<br>content complex  |
| children   | <a href="#">Block1</a> <a href="#">Block2</a> <a href="#">Block3</a> <a href="#">Block4</a> |
| annotation | documentation<br>Enthält die Felder des OeKB Stammdatenblatts lt. Beschreibungen der OeKB   |

element **CountrySpecificAssetMasterDataATType/OeKBStammdatenblatt/Block1**

|            |  |
|------------|--|
| diagram    |  |
| properties | isRef 0<br>content complex   |
| children   | <a href="#">ISIN</a> <a href="#">BestehendeTranchen</a> <a href="#">Art</a> <a href="#">Fondsbezeichnung</a> <a href="#">Kapitalanlagegesellschaft</a> <a href="#">Depotbank</a> <a href="#">SteuerlicherVertreter</a> <a href="#">GueltigAb</a> |

element **CountrySpecificAssetMasterDataATType/OeKBStammdatenblatt/Block1/ISIN**

|            |   |
|------------|---|
| diagram    |   |
| type       | <a href="#">ISINType</a>  |
| properties | isRef 0<br>content simple   |
| facets     | Kind Value annotation<br>length 12<br>pattern [A-Z]{2}[A-Z0-9]{9}[0-9]{1} |

element **CountrySpecificAssetMasterDataATType/OeKBStammdatenblatt/Block1/BestehendeTranchen**

|            |  |
|------------|--|
| diagram    |  |
| properties | isRef 0<br>minOcc 0<br>maxOcc 1<br>content complex |
| children   | <a href="#">ISIN</a>                               |



element

**CountrySpecificAssetMasterDataAType/OeKBStammdatenblatt/Block1/BestehendeTranchen/ISIN**

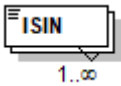
|            |   |
|------------|---|
| diagram    |  |
| type       | <a href="#">ISINType</a>  |
| properties | isRef 0<br>minOcc 1<br>maxOcc unbounded<br>content simple                         |
| facets     | Kind Value annotation<br>length 12<br>pattern [A-Z]{2}[A-Z0-9]{9}[0-9]{1}         |

element **CountrySpecificAssetMasterDataAType/OeKBStammdatenblatt/Block1/Art**

|            |   |
|------------|---|
| diagram    |  |
| type       | restriction of <b>xs:string</b>   |
| properties | isRef 0<br>content simple   |

element **CountrySpecificAssetMasterDataAType/OeKBStammdatenblatt/Block1/Fondsbezeichnung**

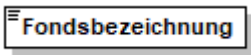
|            |   |
|------------|---|
| diagram    |  |
| type       | <b>xs:string</b>  |
| properties | isRef 0<br>content simple   |

element

**CountrySpecificAssetMasterDataAType/OeKBStammdatenblatt/Block1/Kapitalanlagegesellschaft**

|            |   |
|------------|---|
| diagram    |  |
| type       | restriction of <b>xs:string</b>   |
| properties | isRef 0<br>content simple   |
| annotation | documentation<br>Data Supplier Code lt. Liste OeKB                                  |

element **CountrySpecificAssetMasterDataAType/OeKBStammdatenblatt/Block1/Depotbank**

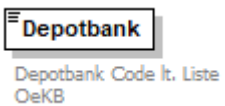
|         |   |
|---------|---|
| diagram |  |
| type    | restriction of <b>xs:string</b>   |

|            |  |
|------------|--|
| properties | isRef 0<br>content simple                      |
| annotation | documentation<br>Depotbank Code lt. Liste OeKB |

element **CountrySpecificAssetMasterDataAType/OeKBStammdatenblatt/Block1/SteuerlicherVertreter**

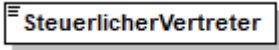
|            |   |
|------------|---|
| diagram    |  The diagram shows a rectangular box with the text "SteuerlicherVertreter" inside. To the left of the box is a small icon consisting of three horizontal lines, representing a list or menu. |
| type       | <b>xs:string</b>  |
| properties | isRef 0<br>content simple   |

element **CountrySpecificAssetMasterDataAType/OeKBStammdatenblatt/Block1/GueltigAb**

|            |   |
|------------|---|
| diagram    |  The diagram shows a rectangular box with the text "GueltigAb" inside. To the left of the box is a small icon consisting of three horizontal lines, representing a list or menu. |
| type       | <b>xs:date</b>  |
| properties | isRef 0<br>content simple   |

element **CountrySpecificAssetMasterDataAType/OeKBStammdatenblatt/Block2**

|            |   |
|------------|---|
| diagram    |   |
| properties | isRef 0<br>content complex  |
| children   | <a href="#">Fondswaehrung</a> <a href="#">KleinsteStueckelung</a> <a href="#">DatumErsterRechenwert</a> <a href="#">Fondsende</a> <a href="#">Anlageschwerpunkt</a><br><a href="#">GeschaeftsjahrBeginn</a> <a href="#">GeschaeftsjahrEnde</a> <a href="#">Ausschuettingsdatum</a> <a href="#">Ausgabeaufschlag</a> <a href="#">VerwaltungsgebuehrPA</a><br><a href="#">StaffelungVerwaltungsgebuehr</a> <a href="#">Ruecknahmespesen</a> <a href="#">RuecknahmeAbrundung</a> |

element **CountrySpecificAssetMasterDataAType/OeKBStammdatenblatt/Block2/Fondswaehrung**

|            |   |            |       |            |           |   |  |           |   |  |         |          |  |
|------------|---|------------|-------|------------|-----------|---|--|-----------|---|--|---------|----------|--|
| diagram    |   |            |       |            |           |   |  |           |   |  |         |          |  |
| type       | restriction of <a href="#">ISOCurrencyCodeType</a>  |            |       |            |           |   |  |           |   |  |         |          |  |
| properties | isRef 0<br>content simple   |            |       |            |           |   |  |           |   |  |         |          |  |
| facets     | <table border="0"> <tr> <td>Kind</td> <td>Value</td> <td>annotation</td> </tr> <tr> <td>minLength</td> <td>3</td> <td></td> </tr> <tr> <td>maxLength</td> <td>3</td> <td></td> </tr> <tr> <td>pattern</td> <td>[A-Z]{3}</td> <td></td> </tr> </table> | Kind       | Value | annotation | minLength | 3 |  | maxLength | 3 |  | pattern | [A-Z]{3} |  |
| Kind       | Value   | annotation |       |            |           |   |  |           |   |  |         |          |  |
| minLength  | 3   |            |       |            |           |   |  |           |   |  |         |          |  |
| maxLength  | 3   |            |       |            |           |   |  |           |   |  |         |          |  |
| pattern    | [A-Z]{3}  |            |       |            |           |   |  |           |   |  |         |          |  |

element **CountrySpecificAssetMasterDataAType/OeKBStammdatenblatt/Block2/KleinsteStueckelung**

|            |   |
|------------|---|
| diagram    |   |
| type       | restriction of <b>xs:decimal</b>        |
| properties | isRef 0<br>content simple               |
| facets     | Kind Value annotation<br>minInclusive 0 |

element **CountrySpecificAssetMasterDataAType/OeKBStammdatenblatt/Block2/DatumErsterRechenwert**

|            |                           |
|------------|---------------------------|
| diagram    |                           |
| type       | <b>xs:date</b>            |
| properties | isRef 0<br>content simple |

element **CountrySpecificAssetMasterDataAType/OeKBStammdatenblatt/Block2/Fondsende**

|            |   |
|------------|---|
| diagram    |   |
| type       | <b>xs:date</b>                                    |
| properties | isRef 0<br>minOcc 0<br>maxOcc 1<br>content simple |

element **CountrySpecificAssetMasterDataAType/OeKBStammdatenblatt/Block2/Anlageschwerpunkt**

|            |   |
|------------|---|
| diagram    |   |
| type       | <b>xs:string</b>                                  |
| properties | isRef 0<br>minOcc 0<br>maxOcc 1<br>content simple |

element **CountrySpecificAssetMasterDataAType/OeKBStammdatenblatt/Block2/GeschaeftsjahrBeginn**

|            |   |
|------------|---|
| diagram    |   |
| properties | isRef 0<br>content complex                |
| children   | <a href="#">Day</a> <a href="#">Month</a> |

|            |                         |
|------------|-------------------------|
| annotation | documentation<br>TT.MM. |
|------------|-------------------------|

element

**CountrySpecificAssetMasterDataAType/OeKBStammdatenblatt/Block2/GeschaeftsjahrBeginn/Day**

|            |   |
|------------|---|
| diagram    |  |
| type       | restriction of <b>xs:positiveInteger</b>  |
| properties | isRef 0<br>content simple   |
| facets     | Kind Value annotation<br>minInclusive 1<br>maxInclusive 31                        |
| annotation | documentation<br>Day between 1 and 31   |

element

**CountrySpecificAssetMasterDataAType/OeKBStammdatenblatt/Block2/GeschaeftsjahrBeginn/Month**

|            |   |
|------------|---|
| diagram    |  |
| type       | restriction of <b>xs:positiveInteger</b>  |
| properties | isRef 0<br>content simple   |
| facets     | Kind Value annotation<br>minInclusive 1<br>maxInclusive 12                        |
| annotation | documentation<br>Month between 1 and 12   |

element **CountrySpecificAssetMasterDataAType/OeKBStammdatenblatt/Block2/GeschaeftsjahrEnde**

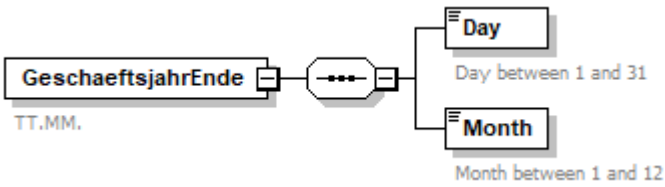
|            |   |
|------------|---|
| diagram    |  |
| properties | isRef 0<br>content complex  |
| children   | <a href="#">Day</a> <a href="#">Month</a>   |
| annotation | documentation<br>TT.MM.   |

element

**CountrySpecificAssetMasterDataATType/OeKBStammdatenblatt/Block2/GeschaeftsjahrEnde/Day**

|              |  |            |       |            |              |   |  |              |    |  |
|--------------|--|------------|-------|------------|--------------|---|--|--------------|----|--|
| diagram      |   |            |       |            |              |   |  |              |    |  |
| type         | restriction of <b>xs:positiveInteger</b>   |            |       |            |              |   |  |              |    |  |
| properties   | isRef 0<br>content simple  |            |       |            |              |   |  |              |    |  |
| facets       | <table border="0"> <tr> <td>Kind</td> <td>Value</td> <td>annotation</td> </tr> <tr> <td>minInclusive</td> <td>1</td> <td></td> </tr> <tr> <td>maxInclusive</td> <td>31</td> <td></td> </tr> </table> | Kind       | Value | annotation | minInclusive | 1 |  | maxInclusive | 31 |  |
| Kind         | Value  | annotation |       |            |              |   |  |              |    |  |
| minInclusive | 1  |            |       |            |              |   |  |              |    |  |
| maxInclusive | 31   |            |       |            |              |   |  |              |    |  |
| annotation   | documentation<br>Day between 1 and 31  |            |       |            |              |   |  |              |    |  |

element

**CountrySpecificAssetMasterDataATType/OeKBStammdatenblatt/Block2/GeschaeftsjahrEnde/Month**

|              |  |            |       |            |              |   |  |              |    |  |
|--------------|--|------------|-------|------------|--------------|---|--|--------------|----|--|
| diagram      |   |            |       |            |              |   |  |              |    |  |
| type         | restriction of <b>xs:positiveInteger</b>   |            |       |            |              |   |  |              |    |  |
| properties   | isRef 0<br>content simple  |            |       |            |              |   |  |              |    |  |
| facets       | <table border="0"> <tr> <td>Kind</td> <td>Value</td> <td>annotation</td> </tr> <tr> <td>minInclusive</td> <td>1</td> <td></td> </tr> <tr> <td>maxInclusive</td> <td>12</td> <td></td> </tr> </table> | Kind       | Value | annotation | minInclusive | 1 |  | maxInclusive | 12 |  |
| Kind         | Value  | annotation |       |            |              |   |  |              |    |  |
| minInclusive | 1  |            |       |            |              |   |  |              |    |  |
| maxInclusive | 12   |            |       |            |              |   |  |              |    |  |
| annotation   | documentation<br>Month between 1 and 12  |            |       |            |              |   |  |              |    |  |

element **CountrySpecificAssetMasterDataATType/OeKBStammdatenblatt/Block2/Ausschuettungsdatum**

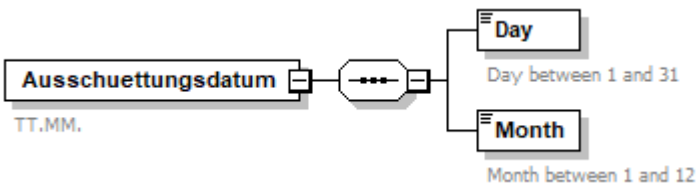
|            |   |
|------------|---|
| diagram    |  |
| properties | isRef 0<br>content complex  |
| children   | <a href="#">Day</a> <a href="#">Month</a>   |
| annotation | documentation<br>TT.MM.   |

element

**CountrySpecificAssetMasterDataATType/OeKBStammdatenblatt/Block2/Ausschuettungsdatum/Day**

|         |   |
|---------|---|
| diagram |  |
| type    | restriction of <b>xs:positiveInteger</b>  |

|            |  |
|------------|--|
| properties | isRef 0<br>content simple                                  |
| facets     | Kind Value annotation<br>minInclusive 1<br>maxInclusive 31 |
| annotation | documentation<br>Day between 1 and 31                      |

element

**CountrySpecificAssetMasterDataATType/OeKBStammdatenblatt/Block2/Ausschuettungsdatum/Month**

|            |   |
|------------|---|
| diagram    |  |
| type       | restriction of <b>xs:positiveInteger</b>  |
| properties | isRef 0<br>content simple   |
| facets     | Kind Value annotation<br>minInclusive 1<br>maxInclusive 12                        |
| annotation | documentation<br>Month between 1 and 12   |

element **CountrySpecificAssetMasterDataATType/OeKBStammdatenblatt/Block2/Ausgabeaufschlag**

|            |   |
|------------|---|
| diagram    |  |
| type       | <a href="#">PercentageType</a>  |
| properties | isRef 0<br>content simple   |

element

**CountrySpecificAssetMasterDataATType/OeKBStammdatenblatt/Block2/VerwaltungsgebuehrPA**

|            |   |
|------------|---|
| diagram    |  |
| type       | <a href="#">PercentageType</a>  |
| properties | isRef 0<br>content simple   |

element

**CountrySpecificAssetMasterDataATType/OeKBStammdatenblatt/Block2/StaffelungVerwaltungsgebuehr**

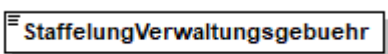
|            |   |
|------------|---|
| diagram    |  |
| type       | <b>xs:boolean</b>   |
| properties | isRef 0<br>content simple   |

element **CountrySpecificAssetMasterDataAType/OeKBStammdatenblatt/Block2/Ruecknahmespesen**

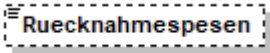
|            |   |       |   |        |   |        |   |         |        |
|------------|---|-------|---|--------|---|--------|---|---------|--------|
| diagram    |  <b>Ruecknahmespesen</b>   |       |   |        |   |        |   |         |        |
| type       | <a href="#">PercentageType</a>  |       |   |        |   |        |   |         |        |
| properties | <table> <tr><td>isRef</td><td>0</td></tr> <tr><td>minOcc</td><td>0</td></tr> <tr><td>maxOcc</td><td>1</td></tr> <tr><td>content</td><td>simple</td></tr> </table> | isRef | 0 | minOcc | 0 | maxOcc | 1 | content | simple |
| isRef      | 0   |       |   |        |   |        |   |         |        |
| minOcc     | 0   |       |   |        |   |        |   |         |        |
| maxOcc     | 1   |       |   |        |   |        |   |         |        |
| content    | simple  |       |   |        |   |        |   |         |        |

element

**CountrySpecificAssetMasterDataAType/OeKBStammdatenblatt/Block2/RuecknahmeAbrundung**

|            |   |       |   |        |   |        |   |         |        |
|------------|---|-------|---|--------|---|--------|---|---------|--------|
| diagram    |  <b>RuecknahmeAbrundung</b>  |       |   |        |   |        |   |         |        |
| type       | <b>xs:decimal</b>   |       |   |        |   |        |   |         |        |
| properties | <table> <tr><td>isRef</td><td>0</td></tr> <tr><td>minOcc</td><td>0</td></tr> <tr><td>maxOcc</td><td>1</td></tr> <tr><td>content</td><td>simple</td></tr> </table> | isRef | 0 | minOcc | 0 | maxOcc | 1 | content | simple |
| isRef      | 0   |       |   |        |   |        |   |         |        |
| minOcc     | 0   |       |   |        |   |        |   |         |        |
| maxOcc     | 1   |       |   |        |   |        |   |         |        |
| content    | simple  |       |   |        |   |        |   |         |        |



element CountrySpecificAssetMasterDataAType/OeKBStammdatenblatt/Block3

diagram

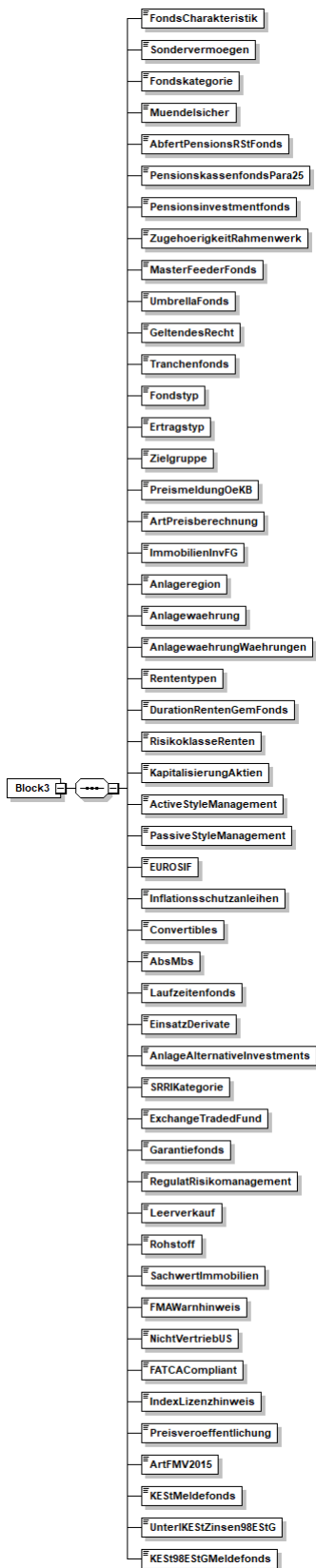

|            |  |
|------------|--|
| properties | isRef 0<br>content complex   |
| children   | <a href="#">FondsCharakteristik</a> <a href="#">Sondervermoegen</a> <a href="#">Fondskategorie</a> <a href="#">Muendelsicher</a> <a href="#">AbfertPensionsRStFonds</a> <a href="#">PensionskassenfondsPara25</a> <a href="#">Pensionsinvestmentfonds</a> <a href="#">ZugehoerigkeitRahmenwerk</a> <a href="#">MasterFeederFonds</a> <a href="#">UmbrellaFonds</a> <a href="#">GeltendesRecht</a> <a href="#">Tranchenfonds</a> <a href="#">Fondstyp</a> <a href="#">Ertragstyp</a> <a href="#">Zielgruppe</a> <a href="#">PreismeldungOeKB</a> <a href="#">ArtPreisberechnung</a> <a href="#">ImmobilienInvFG</a> <a href="#">Anlageregion</a> <a href="#">Anlagewaehrung</a> <a href="#">AnlagewaehrungWaehrungen</a> <a href="#">Rententypen</a> <a href="#">DurationRentenGemFonds</a> <a href="#">RisikoklasseRenten</a> <a href="#">KapitalisierungAktien</a> <a href="#">ActiveStyleManagement</a> <a href="#">PassiveStyleManagement</a> <a href="#">EUROSIF</a> <a href="#">Inflationsschutzanleihen</a> <a href="#">Convertibles</a> <a href="#">AbsMbs</a> <a href="#">Laufzeitenfonds</a> <a href="#">EinsatzDerivate</a> <a href="#">AnlageAlternativInvestments</a> <a href="#">SRRIKategorie</a> <a href="#">ExchangeTradedFund</a> <a href="#">Garantiefonds</a> <a href="#">RegulatRisikomanagement</a> <a href="#">Leerverkauf</a> <a href="#">Rohstoff</a> <a href="#">SachwertImmobilien</a> <a href="#">FMAWarnhinweis</a> <a href="#">NichtVertriebUS</a> <a href="#">FATCACompliant</a> <a href="#">IndexLizenzhinweis</a> <a href="#">Preisveroeffentlichung</a> <a href="#">ArtFMV2015</a> <a href="#">KEStMeldefonds</a> <a href="#">UnterIKESTZinsen98EStG</a> <a href="#">KESt98EStGMeldefonds</a> |

element **CountrySpecificAssetMasterDataATType/OeKBStammdatenblatt/Block3/FondsCharakteristik**

|            |                                 |
|------------|---------------------------------|
| diagram    |                                 |
| type       | restriction of <b>xs:string</b> |
| properties | isRef 0<br>content simple       |

element **CountrySpecificAssetMasterDataATType/OeKBStammdatenblatt/Block3/Sondervermoegen**

|            |                           |
|------------|---------------------------|
| diagram    |                           |
| type       | <b>xs:boolean</b>         |
| properties | isRef 0<br>content simple |

element **CountrySpecificAssetMasterDataATType/OeKBStammdatenblatt/Block3/Fondskategorie**

|            |                                 |
|------------|---------------------------------|
| diagram    |                                 |
| type       | restriction of <b>xs:string</b> |
| properties | isRef 0<br>content simple       |

element **CountrySpecificAssetMasterDataATType/OeKBStammdatenblatt/Block3/Muendelsicher**

|            |                           |
|------------|---------------------------|
| diagram    |                           |
| type       | <b>xs:boolean</b>         |
| properties | isRef 0<br>content simple |

element **CountrySpecificAssetMasterDataATType/OeKBStammdatenblatt/Block3/AbfertPensionsRStFonds**

|         |  |
|---------|--|
| diagram |  |
|---------|--|

|            |                           |
|------------|---------------------------|
| type       | <b>xs:boolean</b>         |
| properties | isRef 0<br>content simple |

element

**CountrySpecificAssetMasterDataATType/OeKBStammdatenblatt/Block3/PensionskassenfondsPara25**

|            |  |
|------------|--|
| diagram    |  <b>PensionskassenfondsPara25</b> |
| type       | <b>xs:boolean</b>  |
| properties | isRef 0<br>content simple  |

element

**CountrySpecificAssetMasterDataATType/OeKBStammdatenblatt/Block3/Pensionsinvestmentfonds**

|            |  |
|------------|--|
| diagram    |  <b>Pensionsinvestmentfonds</b> |
| type       | restriction of <b>xs:string</b>  |
| properties | isRef 0<br>content simple  |

element

**CountrySpecificAssetMasterDataATType/OeKBStammdatenblatt/Block3/ZugehoerigkeitRahmenwerk**

|            |   |
|------------|---|
| diagram    |  <b>ZugehoerigkeitRahmenwerk</b> |
| type       | restriction of <b>xs:string</b>   |
| properties | isRef 0<br>content simple   |

element **CountrySpecificAssetMasterDataATType/OeKBStammdatenblatt/Block3/MasterFeederFonds**

|            |  |
|------------|--|
| diagram    |  <b>MasterFeederFonds</b> |
| type       | restriction of <b>xs:string</b>  |
| properties | isRef 0<br>content simple  |

element **CountrySpecificAssetMasterDataATType/OeKBStammdatenblatt/Block3/UmbrellaFonds**

|            |  |
|------------|--|
| diagram    |  <b>UmbrellaFonds</b> |
| type       | <b>xs:boolean</b>  |
| properties | isRef 0<br>content simple  |

element **CountrySpecificAssetMasterDataAType/OeKBStammdatenblatt/Block3/GeltendesRecht**

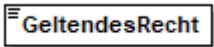
|            |   |
|------------|---|
| diagram    |  |
| type       | restriction of <b>xs:string</b>   |
| properties | isRef 0<br>content simple   |

element **CountrySpecificAssetMasterDataAType/OeKBStammdatenblatt/Block3/Tranchenfonds**

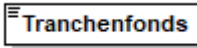
|            |   |
|------------|---|
| diagram    |  |
| type       | <b>xs:boolean</b>   |
| properties | isRef 0<br>content simple   |

element **CountrySpecificAssetMasterDataAType/OeKBStammdatenblatt/Block3/Fondstyp**

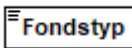
|            |   |
|------------|---|
| diagram    |  |
| type       | restriction of <b>xs:string</b>   |
| properties | isRef 0<br>content simple   |

element **CountrySpecificAssetMasterDataAType/OeKBStammdatenblatt/Block3/Ertragstyp**

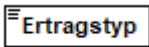
|            |   |
|------------|---|
| diagram    |  |
| type       | restriction of <b>xs:string</b>   |
| properties | isRef 0<br>content simple   |

element **CountrySpecificAssetMasterDataAType/OeKBStammdatenblatt/Block3/Zielgruppe**

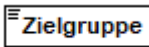
|            |   |
|------------|---|
| diagram    |  |
| type       | restriction of <b>xs:string</b>   |
| properties | isRef 0<br>content simple   |

element **CountrySpecificAssetMasterDataAType/OeKBStammdatenblatt/Block3/PreismeldungOeKB**

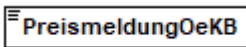
|            |   |
|------------|---|
| diagram    |  |
| type       | restriction of <b>xs:string</b>   |
| properties | isRef 0<br>content simple   |

element **CountrySpecificAssetMasterDataATType/OeKBStammdatenblatt/Block3/ArtPreisberechnung**

|            |   |
|------------|---|
| diagram    |  <b>ArtPreisberechnung</b> |
| type       | restriction of <b>xs:string</b>   |
| properties | isRef 0<br>content simple   |

element **CountrySpecificAssetMasterDataATType/OeKBStammdatenblatt/Block3/ImmobilienInvFG**

|            |  |
|------------|--|
| diagram    |  <b>ImmobilienInvFG</b> |
| type       | restriction of <b>xs:string</b>  |
| properties | isRef 0<br>content simple  |

element **CountrySpecificAssetMasterDataATType/OeKBStammdatenblatt/Block3/Anlageregion**

|            |   |
|------------|---|
| diagram    |  <b>Anlageregion</b> |
| type       | restriction of <b>xs:string</b>   |
| properties | isRef 0<br>content simple   |

element **CountrySpecificAssetMasterDataATType/OeKBStammdatenblatt/Block3/Anlagewaehrung**

|            |   |
|------------|---|
| diagram    |  <b>Anlagewaehrung</b> |
| type       | restriction of <b>xs:string</b>   |
| properties | isRef 0<br>content simple   |

element

**CountrySpecificAssetMasterDataATType/OeKBStammdatenblatt/Block3/AnlagewaehrungWaehrungen**

|            |   |
|------------|---|
| diagram    |  <b>AnlagewaehrungWaehrungen</b> |
| type       | restriction of <b>xs:string</b>   |
| properties | isRef 0<br>content simple   |

element **CountrySpecificAssetMasterDataATType/OeKBStammdatenblatt/Block3/Rententypen**

|         |  |
|---------|--|
| diagram |  <b>Rententypen</b> |
|---------|--|

|            |                                 |
|------------|---------------------------------|
| type       | restriction of <b>xs:string</b> |
| properties | isRef 0<br>content simple       |

element

**CountrySpecificAssetMasterDataAType/OeKBStammdatenblatt/Block3/DurationRentenGemFonds**

|            |   |
|------------|---|
| diagram    |  <b>DurationRentenGemFonds</b> |
| type       | restriction of <b>xs:string</b>   |
| properties | isRef 0<br>content simple   |

element **CountrySpecificAssetMasterDataAType/OeKBStammdatenblatt/Block3/RisikoklasseRenten**

|            |   |
|------------|---|
| diagram    |  <b>RisikoklasseRenten</b> |
| type       | restriction of <b>xs:string</b>   |
| properties | isRef 0<br>content simple   |

element **CountrySpecificAssetMasterDataAType/OeKBStammdatenblatt/Block3/KapitalisierungAktien**

|            |  |
|------------|--|
| diagram    |  <b>KapitalisierungAktien</b> |
| type       | restriction of <b>xs:string</b>  |
| properties | isRef 0<br>content simple  |

element

**CountrySpecificAssetMasterDataAType/OeKBStammdatenblatt/Block3/ActiveStyleManagement**

|            |  |
|------------|--|
| diagram    |  <b>Active Style Management</b> |
| type       | restriction of <b>xs:string</b>  |
| properties | isRef 0<br>content simple  |

element

**CountrySpecificAssetMasterDataAType/OeKBStammdatenblatt/Block3/PassiveStyleManagement**

|            |   |
|------------|---|
| diagram    |  <b>Passive Style Management</b> |
| type       | <b>xs:boolean</b>   |
| properties | isRef 0<br>content simple   |

element **CountrySpecificAssetMasterDataAType/OeKBStammdatenblatt/Block3/EUROSIF**

|            |   |
|------------|---|
| diagram    |  |
| type       | <b>xs:boolean</b>   |
| properties | isRef 0<br>content simple   |

element **CountrySpecificAssetMasterDataAType/OeKBStammdatenblatt/Block3/Inflationsschutzanleihen**

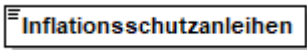
|            |   |
|------------|---|
| diagram    |  |
| type       | <b>xs:boolean</b>   |
| properties | isRef 0<br>content simple   |

element **CountrySpecificAssetMasterDataAType/OeKBStammdatenblatt/Block3/Convertibles**

|            |   |
|------------|---|
| diagram    |  |
| type       | <b>xs:boolean</b>   |
| properties | isRef 0<br>content simple   |

element **CountrySpecificAssetMasterDataAType/OeKBStammdatenblatt/Block3/AbsMbs**

|            |   |
|------------|---|
| diagram    |  |
| type       | <b>xs:boolean</b>   |
| properties | isRef 0<br>content simple   |

element **CountrySpecificAssetMasterDataAType/OeKBStammdatenblatt/Block3/Laufzeitenfonds**

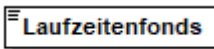
|            |   |
|------------|---|
| diagram    |  |
| type       | <b>xs:boolean</b>   |
| properties | isRef 0<br>content simple   |

element **CountrySpecificAssetMasterDataAType/OeKBStammdatenblatt/Block3/EinsatzDerivate**

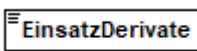
|         |   |
|---------|---|
| diagram |  |
| type    | restriction of <b>xs:string</b>   |

|            |                           |
|------------|---------------------------|
| properties | isRef 0<br>content simple |
|------------|---------------------------|

element

**CountrySpecificAssetMasterDataAType/OeKBStammdatenblatt/Block3/AnlageAlternativeInvestments**

|            |   |
|------------|---|
| diagram    |  <b>AnlageAlternativeInvestments</b> |
| type       | restriction of <b>xs:string</b>   |
| properties | isRef 0<br>content simple   |

element **CountrySpecificAssetMasterDataAType/OeKBStammdatenblatt/Block3/SRRIKategorie**

|            |  |
|------------|--|
| diagram    |  <b>SRRIKategorie</b> |
| type       | restriction of <b>xs:string</b>  |
| properties | isRef 0<br>content simple  |

element **CountrySpecificAssetMasterDataAType/OeKBStammdatenblatt/Block3/ExchangeTradedFund**

|            |   |
|------------|---|
| diagram    |  <b>ExchangeTradedFund</b> |
| type       | <b>xs:boolean</b>   |
| properties | isRef 0<br>content simple   |

element **CountrySpecificAssetMasterDataAType/OeKBStammdatenblatt/Block3/Garantiefonds**

|            |  |
|------------|--|
| diagram    |  <b>Garantiefonds</b> |
| type       | <b>xs:boolean</b>  |
| properties | isRef 0<br>content simple  |

element

**CountrySpecificAssetMasterDataAType/OeKBStammdatenblatt/Block3/RegulatRisikomanagement**

|            |  |
|------------|--|
| diagram    |  <b>RegulatRisikomanagement</b> |
| type       | restriction of <b>xs:string</b>  |
| properties | isRef 0<br>content simple  |



element **CountrySpecificAssetMasterDataAType/OeKBStammdatenblatt/Block3/Leerverkauf**

|            |   |
|------------|---|
| diagram    |  |
| type       | <b>xs:boolean</b>   |
| properties | isRef 0<br>content simple   |

element **CountrySpecificAssetMasterDataAType/OeKBStammdatenblatt/Block3/Rohstoff**

|            |   |
|------------|---|
| diagram    |  |
| type       | <b>xs:boolean</b>   |
| properties | isRef 0<br>content simple   |

element **CountrySpecificAssetMasterDataAType/OeKBStammdatenblatt/Block3/SachwertImmobilien**

|            |   |
|------------|---|
| diagram    |  |
| type       | <b>xs:boolean</b>   |
| properties | isRef 0<br>content simple   |

element **CountrySpecificAssetMasterDataAType/OeKBStammdatenblatt/Block3/FMAWarnhinweis**

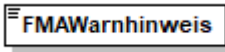
|            |   |
|------------|---|
| diagram    |  |
| type       | <b>xs:boolean</b>   |
| properties | isRef 0<br>content simple   |

element **CountrySpecificAssetMasterDataAType/OeKBStammdatenblatt/Block3/NichtVertriebUS**

|            |   |
|------------|---|
| diagram    |  |
| type       | <b>xs:boolean</b>   |
| properties | isRef 0<br>content simple   |

element **CountrySpecificAssetMasterDataAType/OeKBStammdatenblatt/Block3/FATCACompliant**

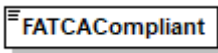
|            |   |
|------------|---|
| diagram    |  |
| type       | <b>xs:boolean</b>   |
| properties | isRef 0<br>content simple   |

element **CountrySpecificAssetMasterDataAType/OeKBStammdatenblatt/Block3/IndexLizenzhinweis**

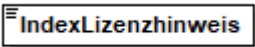
|            |   |
|------------|---|
| diagram    |  |
| type       | <b>xs:boolean</b>   |
| properties | isRef 0<br>content simple   |

element **CountrySpecificAssetMasterDataAType/OeKBStammdatenblatt/Block3/Preisveroeffentlichung**

|            |   |
|------------|---|
| diagram    |  |
| type       | restriction of <b>xs:string</b>   |
| properties | isRef 0<br>content simple   |

element **CountrySpecificAssetMasterDataAType/OeKBStammdatenblatt/Block3/ArtFMV2015**

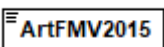
|            |   |
|------------|---|
| diagram    |  |
| type       | restriction of <b>xs:string</b>   |
| properties | isRef 0<br>content simple   |

element **CountrySpecificAssetMasterDataAType/OeKBStammdatenblatt/Block3/KEStMeldefonds**

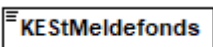
|            |   |
|------------|---|
| diagram    |  |
| type       | <b>xs:boolean</b>   |
| properties | isRef 0<br>content simple   |

element **CountrySpecificAssetMasterDataAType/OeKBStammdatenblatt/Block3/UnterKEStZinsen98EstG**

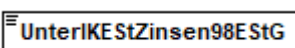
|            |   |
|------------|---|
| diagram    |  |
| type       | <b>xs:boolean</b>   |
| properties | isRef 0<br>content simple   |

element **CountrySpecificAssetMasterDataAType/OeKBStammdatenblatt/Block3/KESt98EstGMeldefonds**

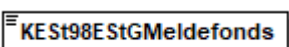
|         |   |
|---------|---|
| diagram |  |
|---------|---|

|            |                           |
|------------|---------------------------|
| type       | <b>xs:boolean</b>         |
| properties | isRef 0<br>content simple |

element **CountrySpecificAssetMasterDataAType/OeKBStammdatenblatt/Block4**

|            |  |
|------------|--|
| diagram    | <p>The diagram shows a box labeled 'Block4' connected to a container box containing three dots. From this container, five dashed boxes branch out, each containing one of the following labels: 'Rueckfragen', 'EMail', 'Telefon', 'Anmerkungen', and 'Datum'.</p> |
| properties | isRef 0<br>content complex   |
| children   | <a href="#">Rueckfragen</a> <a href="#">EMail</a> <a href="#">Telefon</a> <a href="#">Anmerkungen</a> <a href="#">Datum</a>  |

element **CountrySpecificAssetMasterDataAType/OeKBStammdatenblatt/Block4/Rueckfragen**

|            |   |
|------------|---|
| diagram    | <p>The diagram shows a dashed box containing the label 'Rueckfragen'.</p> |
| type       | <b>xs:string</b>  |
| properties | isRef 0<br>minOcc 0<br>maxOcc 1<br>content simple                         |

element **CountrySpecificAssetMasterDataAType/OeKBStammdatenblatt/Block4/EMail**

|            |   |
|------------|---|
| diagram    | <p>The diagram shows a dashed box containing the label 'EMail'.</p> |
| type       | <b>xs:string</b>  |
| properties | isRef 0<br>minOcc 0<br>maxOcc 1<br>content simple                   |

element **CountrySpecificAssetMasterDataAType/OeKBStammdatenblatt/Block4/Telefon**

|            |   |
|------------|---|
| diagram    | <p>The diagram shows a dashed box containing the label 'Telefon'.</p> |
| type       | <b>xs:string</b>  |
| properties | isRef 0<br>minOcc 0<br>maxOcc 1<br>content simple                     |

element **CountrySpecificAssetMasterDataAType/OeKBStammdatenblatt/Block4/Anmerkungen**

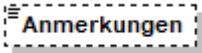
|            |  |       |   |        |   |        |   |         |        |
|------------|--|-------|---|--------|---|--------|---|---------|--------|
| diagram    |   |       |   |        |   |        |   |         |        |
| type       | <b>xs:string</b>   |       |   |        |   |        |   |         |        |
| properties | <table border="0"> <tr><td>isRef</td><td>0</td></tr> <tr><td>minOcc</td><td>0</td></tr> <tr><td>maxOcc</td><td>1</td></tr> <tr><td>content</td><td>simple</td></tr> </table> | isRef | 0 | minOcc | 0 | maxOcc | 1 | content | simple |
| isRef      | 0  |       |   |        |   |        |   |         |        |
| minOcc     | 0  |       |   |        |   |        |   |         |        |
| maxOcc     | 1  |       |   |        |   |        |   |         |        |
| content    | simple   |       |   |        |   |        |   |         |        |

element **CountrySpecificAssetMasterDataAType/OeKBStammdatenblatt/Block4/Datum**

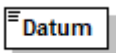
|            |  |       |   |         |        |
|------------|--|-------|---|---------|--------|
| diagram    |                       |       |   |         |        |
| type       | <b>xs:date</b>   |       |   |         |        |
| properties | <table border="0"> <tr><td>isRef</td><td>0</td></tr> <tr><td>content</td><td>simple</td></tr> </table> | isRef | 0 | content | simple |
| isRef      | 0  |       |   |         |        |
| content    | simple   |       |   |         |        |

complexType **CountrySpecificControlDataAType**

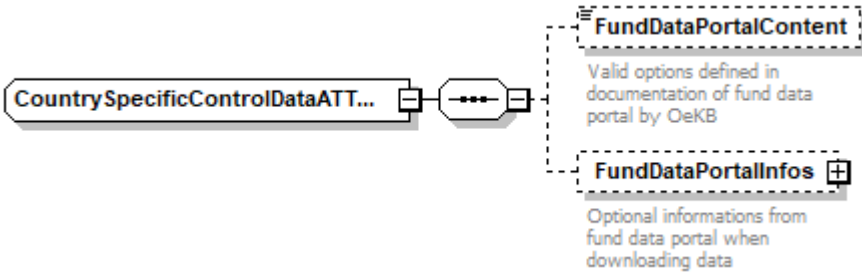
|          |   |
|----------|---|
| diagram  |  |
| children | <a href="#">FundDataPortalContent</a> <a href="#">FundDataPortalInfos</a>           |
| used by  | element <a href="#">ControlDataType/CountrySpecificData/AT</a>                      |

element **CountrySpecificControlDataAType/FundDataPortalContent**

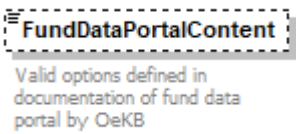
|            |  |       |   |        |   |        |   |         |        |
|------------|--|-------|---|--------|---|--------|---|---------|--------|
| diagram    |   |       |   |        |   |        |   |         |        |
| type       | <b>xs:string</b>   |       |   |        |   |        |   |         |        |
| properties | <table border="0"> <tr><td>isRef</td><td>0</td></tr> <tr><td>minOcc</td><td>0</td></tr> <tr><td>maxOcc</td><td>1</td></tr> <tr><td>content</td><td>simple</td></tr> </table> | isRef | 0 | minOcc | 0 | maxOcc | 1 | content | simple |
| isRef      | 0  |       |   |        |   |        |   |         |        |
| minOcc     | 0  |       |   |        |   |        |   |         |        |
| maxOcc     | 1  |       |   |        |   |        |   |         |        |
| content    | simple   |       |   |        |   |        |   |         |        |
| annotation | documentation<br>Valid options defined in documentation of fund data portal by OeKB  |       |   |        |   |        |   |         |        |

element **CountrySpecificControlDataAType/FundDataPortallInfos**

|            |  |
|------------|--|
| diagram    | <p>Optional informations from fund data portal when downloading data</p>           |
| properties | isRef 0<br>minOcc 0<br>maxOcc 1<br>content complex                                 |
| children   | <a href="#">Info</a>   |
| annotation | documentation<br>Optional informations from fund data portal when downloading data |

element **CountrySpecificControlDataAType/FundDataPortallInfos/Info**

|            |  |
|------------|--|
| diagram    |  |
| type       | extension of <b>xs:string</b>                              |
| properties | isRef 0<br>minOcc 1<br>maxOcc unbounded<br>content complex |

attribute **CountrySpecificControlDataAType/FundDataPortallInfos/Info/@type**

|            |                  |
|------------|------------------|
| type       | <b>xs:string</b> |
| properties | isRef 0          |

complexType **CountrySpecificDataAType**

|            |  |
|------------|--|
| diagram    |  |
| type       | extension of <b>xs:anyType</b>                     |
| properties | base <b>xs:anyType</b>                             |
| used by    | element <a href="#">CountrySpecificDataType/AT</a> |

### complexType CountrySpecificEMTATType

|            |  |
|------------|--|
| diagram    |  |
| type       | extension of <b>xs:anyType</b>   |
| properties | base <b>xs:anyType</b>   |
| used by    | elements <a href="#">CountrySpecificEMTDataType/AT</a> <a href="#">CountrySpecificEMT41DataType/AT</a> |

### complexType CountrySpecificFundDataATType

|            |  |
|------------|--|
| diagram    |  |
| children   | <a href="#">OeNB</a> <a href="#">PKG2012</a> <a href="#">FundDataPortalInfos</a> |
| used by    | element <a href="#">CountrySpecificFundDataType/AT</a>                           |
| annotation | documentation<br>Country specific data for Austria                               |

element **CountrySpecificFundDataATType/OeNB**

|                   |  |
|-------------------|--|
| <p>diagram</p>    |  |
| <p>properties</p> | <p>isRef 0<br/>minOcc 0<br/>maxOcc 1<br/>content complex</p>   |
| <p>children</p>   | <p><a href="#">Subscription</a> <a href="#">Redemption</a> <a href="#">Distribution</a> <a href="#">TotalNetAssetPreviousMonth</a> <a href="#">Meldungstyp</a></p> |
| <p>annotation</p> | <p>documentation<br/>Zusatzfelder fuer die monatliche OFI Meldung</p>  |

element **CountrySpecificFundDataATType/OeNB/Subscription**

|                   |  |
|-------------------|--|
| <p>diagram</p>    |  |
| <p>type</p>       | <p><a href="#">AmountType</a></p>  |
| <p>properties</p> | <p>isRef 0<br/>minOcc 0<br/>maxOcc 1<br/>content complex</p>                                 |
| <p>children</p>   | <p><a href="#">Amount</a></p>  |
| <p>annotation</p> | <p>documentation<br/>Mittelzufluesse aus Ausgabe von Anteilsrechten fuer den Gesamtfonds</p> |

element **CountrySpecificFundDataATType/OeNB/Redemption**

|            |  |
|------------|--|
| diagram    | <p><b>Redemption</b><br/>Mittelabflüsse aus Rücknahme von Anteilsrechten fuer den Gesamtfonds</p> <p><b>AmountType</b><br/>Amounts in currency as defined in attribute</p> <p>1..∞</p> |
| type       | <a href="#">AmountType</a>   |
| properties | <ul style="list-style-type: none"> <li>isRef 0</li> <li>minOcc 0</li> <li>maxOcc 1</li> <li>content complex</li> </ul>   |
| children   | <a href="#">Amount</a>   |
| annotation | <p>documentation<br/>Mittelabflüsse aus Rücknahme von Anteilsrechten fuer den Gesamtfonds</p>  |

element **CountrySpecificFundDataATType/OeNB/Distribution**

|            |   |
|------------|---|
| diagram    | <p><b>Distribution</b><br/>Mittelabfluss aus Ausschüttung zum Ex-Tag</p> <p><b>AmountType</b><br/>Amounts in currency as defined in attribute</p> <p>1..∞</p> |
| type       | <a href="#">AmountType</a>  |
| properties | <ul style="list-style-type: none"> <li>isRef 0</li> <li>minOcc 0</li> <li>maxOcc 1</li> <li>content complex</li> </ul>  |
| children   | <a href="#">Amount</a>  |
| annotation | <p>documentation<br/>Mittelabfluss aus Ausschüttung zum Ex-Tag</p>  |

element **CountrySpecificFundDataATType/OeNB/TotalNetAssetPreviousMonth**

|            |   |
|------------|---|
| diagram    | <p><b>TotalNetAssetPreviousMonth</b><br/>Fondsvermoegen des Vormonats (ultimo) des Gesamtfonds (sollte dem Wert der letzten Meldung entsprechen; wenns geht)</p> <p><b>AmountType</b><br/>Amounts in currency as defined in attribute</p> <p>1..∞</p> |
| type       | <a href="#">AmountType</a>  |
| properties | <ul style="list-style-type: none"> <li>isRef 0</li> <li>minOcc 0</li> <li>maxOcc 1</li> <li>content complex</li> </ul>  |
| children   | <a href="#">Amount</a>  |



|            |  |
|------------|--|
| annotation | documentation<br>Fondsvermoegen des Vormonats (ultimo) des Gesamtfonds (sollte dem Wert der letzten Meldung entsprechen; wenns geht) |
|------------|--|

### element CountrySpecificFundDataATType/OeNB/Meldungstyp

|            |   |
|------------|---|
| diagram    |   |
| type       | restriction of <b>xs:string</b>                   |
| properties | isRef 0<br>content simple                         |
| annotation | documentation<br>"OFI" ... OFI/IF Meldung an OeNB |

### element CountrySpecificFundDataATType/PKG2012

|            |  |
|------------|--|
| diagram    |  |
| properties | isRef 0<br>minOcc 0<br>maxOcc 1<br>content complex   |
| children   | <a href="#">Details</a> <a href="#">Summary</a>  |
| annotation | documentation<br>Daten für die Quartalsmeldeverordnung 2012 der FMA auf der Basis des neuen Pensionskassengesetzes |

### element CountrySpecificFundDataATType/PKG2012/Details

|            |  |
|------------|--|
| diagram    |  |
| properties | isRef 0<br>minOcc 0<br>maxOcc 1<br>content complex |
| children   | <a href="#">Position</a>                           |
| annotation | documentation<br>Einzelpositionsdaten              |

element **CountrySpecificFundDataAType/PKG2012/Details/Position**

|                   |  |
|-------------------|--|
| <p>diagram</p>    | <p><b>Position</b> 1..∞<br/>Je Position zumindest ein Knoten mit einer UniqueID und der QMV-Kategorie und/oder dem zuzurechnenden Betrag. Bei Derivaten sollten hier zwei Knoten je Position angegeben werden (Bewertung + Exposure).</p> <p><b>Identifiers</b> +<br/>Bezug zur Position bzw. Bezug zum Wertpapier, Derivat oder Geld</p> <p><b>Category</b> =<br/>PKG/QMV-Kategorie (dreistellige Nummer) laut Vermögensausweis</p> <p><b>Value</b> +<br/>Betrag, der aufgrund der oben genannten Position einer Kategorie zugerechnet wird</p> |
| <p>properties</p> | <p>isRef 0<br/>minOcc 1<br/>maxOcc unbounded<br/>content complex</p>   |
| <p>children</p>   | <p><a href="#">Identifiers</a> <a href="#">Category</a> <a href="#">Value</a></p>  |
| <p>annotation</p> | <p>documentation<br/>Je Position zumindest ein Knoten mit einer UniqueID und der QMV-Kategorie und/oder dem zuzurechnenden Betrag. Bei Derivaten sollten hier zwei Knoten je Position angegeben werden (Bewertung + Exposure).</p>   |

element **CountrySpecificFundDataATType/PKG2012/Details/Position/Identifiers**

diagram

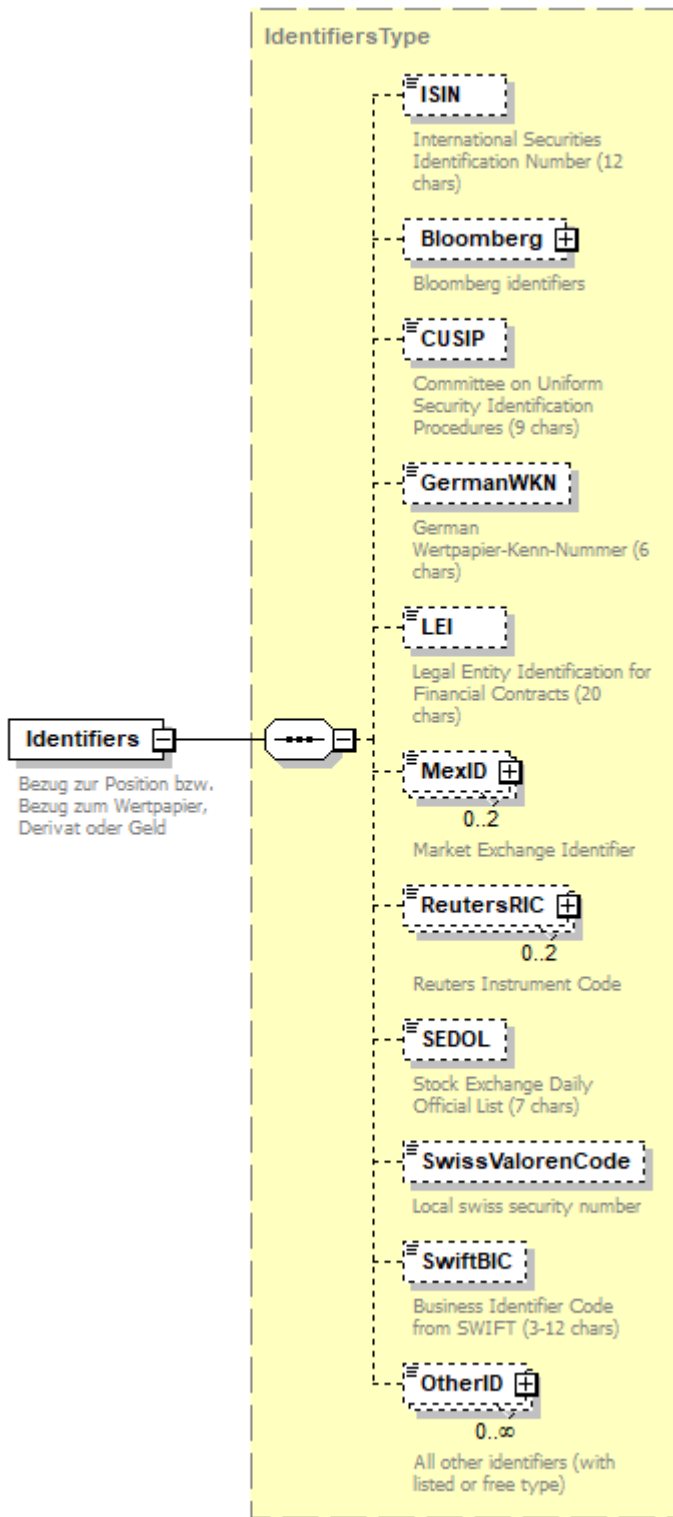

|            |   |
|------------|---|
| type       | <a href="#">IdentifiersType</a>   |
| properties | isRef 0<br>content complex  |
| children   | <a href="#">ISIN</a> <a href="#">Bloomberg</a> <a href="#">CUSIP</a> <a href="#">GermanWKN</a> <a href="#">LEI</a> <a href="#">MexID</a> <a href="#">ReutersRIC</a> <a href="#">SEDOL</a> <a href="#">SwissValorenCode</a> <a href="#">SwiftBIC</a> <a href="#">OtherID</a> |

|            |  |
|------------|--|
| annotation | documentation<br>Bezug zur Position bzw. Bezug zum Wertpapier, Derivat oder Geld |
|------------|--|

element **CountrySpecificFundDataATType/PKG2012/Details/Position/Category**

|            |  |
|------------|--|
| diagram    |  |
| type       | restriction of <b>xs:decimal</b>   |
| properties | isRef 0<br>content simple  |
| facets     | Kind Value annotation<br>totalDigits 3   |
| annotation | documentation<br>PKG/QMV-Kategorie (dreistellige Nummer) laut Vermögensausweis |

element **CountrySpecificFundDataATType/PKG2012/Details/Position/Value**

|            |  |
|------------|--|
| diagram    |  |
| type       | <a href="#">AmountType</a>   |
| properties | isRef 0<br>content complex   |
| children   | <a href="#">Amount</a>   |
| annotation | documentation<br>Betrag, der aufgrund der oben genannten Position einer Kategorie zugerechnet wird |

element **CountrySpecificFundDataATType/PKG2012/Summary**

|            |   |
|------------|---|
| diagram    |   |
| properties | isRef 0<br>minOcc 0<br>maxOcc 1<br>content complex                  |
| children   | <a href="#">Position</a>  |
| annotation | documentation<br>Summen je Kategorie (entspricht dem Meldeformular) |

element **CountrySpecificFundDataAType/PKG2012/Summary/Position**

|            |   |
|------------|---|
| diagram    | <p>Position<br/>1..∞<br/>Je Kategorie ein Knoten</p> <p>Category<br/>PKG/QMV-Kategorie (dreistellige Nummer) laut Vermögensausweis</p> <p>Value<br/>Summe für obige Kategorie</p> |
| properties | isRef 0<br>minOcc 1<br>maxOcc unbounded<br>content complex  |
| children   | <a href="#">Category</a> <a href="#">Value</a>  |
| annotation | documentation<br>Je Kategorie ein Knoten  |

element **CountrySpecificFundDataAType/PKG2012/Summary/Position/Category**

|            |   |
|------------|---|
| diagram    | <p>Category<br/>PKG/QMV-Kategorie (dreistellige Nummer) laut Vermögensausweis</p> |
| type       | restriction of <b>xs:decimal</b>  |
| properties | isRef 0<br>content simple   |
| facets     | Kind Value annotation<br>totalDigits 3  |
| annotation | documentation<br>PKG/QMV-Kategorie (dreistellige Nummer) laut Vermögensausweis    |

element **CountrySpecificFundDataAType/PKG2012/Summary/Position/Value**

|            |   |
|------------|---|
| diagram    | <p>Value<br/>Summe für obige Kategorie</p> <p>AmountType</p> <p>Amount<br/>1..∞<br/>Amounts in currency as defined in attribute</p> |
| type       | <a href="#">AmountType</a>  |
| properties | isRef 0<br>content complex  |
| children   | <a href="#">Amount</a>  |
| annotation | documentation<br>Summe für obige Kategorie  |

element **CountrySpecificFundDataATType/FundDataPortallInfos**

|            |   |
|------------|---|
| diagram    | <p>Optional informations from fund data portal when downloading data</p>                    |
| properties | <p>isRef 0<br/> minOcc 0<br/> maxOcc 1<br/> content complex</p>                             |
| children   | <a href="#">Info</a>  |
| annotation | <p>documentation<br/> Optional informations from fund data portal when downloading data</p> |

element **CountrySpecificFundDataATType/FundDataPortallInfos/Info**

|            |   |
|------------|---|
| diagram    |   |
| type       | extension of <b>xs:string</b>   |
| properties | <p>isRef 0<br/> minOcc 1<br/> maxOcc unbounded<br/> content complex</p> |

attribute **CountrySpecificFundDataATType/FundDataPortallInfos/Info/@type**

|            |                  |
|------------|------------------|
| type       | <b>xs:string</b> |
| properties | isRef 0          |

complexType **CountrySpecificShareClassDataATType**

|          |   |
|----------|---|
| diagram  | <p>OeKB Stammdatenblatt<br/> Enthält die Felder des OeKB Stammdatenblatts lt. Beschreibungen der OeKB</p> <p>TotalNetAssetValue</p> |
| children | <a href="#">OeKB Stammdatenblatt</a> <a href="#">TotalNetAssetValue</a>   |
| used by  | element <a href="#">CountrySpecificShareClassDataType/AT</a>  |

element **CountrySpecificShareClassDataATType/OeKBStammdatenblatt**

diagram



|            |   |
|------------|---|
| properties | isRef 0<br>minOcc 0<br>maxOcc 1<br>content complex  |
| children   | <a href="#">GueltigAb</a> <a href="#">FMA</a> <a href="#">Fondsname</a> <a href="#">LEI</a> <a href="#">Tranchenfonds</a> <a href="#">ISIN</a> <a href="#">ISIN_Typ</a> <a href="#">ISIN</a> <a href="#">Bezeichnung</a> <a href="#">Wrappernummer</a> <a href="#">OeNB-ID</a> <a href="#">Umbrella</a> <a href="#">Flag</a> <a href="#">ETF</a> <a href="#">Flag</a> <a href="#">Verwaltungsgesellschaft</a> <a href="#">LEI</a> <a href="#">Depotbank</a> <a href="#">LEI</a> <a href="#">SteuerlicherVertreter</a> <a href="#">Tranchenzusatz_vorne</a> <a href="#">Tranchenzusatz_hinten</a> <a href="#">GeschaeftsjahrBeginn</a> <a href="#">GeschaeftsjahrEnde</a> <a href="#">Ausschuettungsdatum</a> <a href="#">ISIN-Waerung</a> <a href="#">DatumErsterNav</a> <a href="#">Zielgruppe</a> <a href="#">Ertragstyp</a> <a href="#">MaxAusgabeaufschlag</a> <a href="#">MaxRuecknahmespesen</a> <a href="#">MindVerwaltungsgebuehrFlag</a> <a href="#">MaxVerwaltungsgebuehr</a> <a href="#">PerformanceFeeFlag</a> <a href="#">KleinsteStueckelung</a> <a href="#">MindestinvestmentErsterwerb</a> <a href="#">MindeststueckelungErsterwerb</a> <a href="#">FondsCharakteristik</a> <a href="#">Sondervermoegen</a> <a href="#">Fondskategorie</a> <a href="#">ActiveStyleManagement</a> <a href="#">PassiveStyleManagement</a> <a href="#">RegulatorRisikomanagement</a> <a href="#">EinsatzDerivate</a> <a href="#">ZugehoerigkeitRahmenwerk</a> <a href="#">Anlageregion</a> <a href="#">Anlagewaehrung</a> <a href="#">SRRIKategorie</a> <a href="#">GeltendesRecht</a> <a href="#">SchwerpunktAnlagewaehrung</a> <a href="#">Leerverkauf</a> <a href="#">Fondstyp</a> <a href="#">Rententypen</a> <a href="#">DurationRentenGemischteFonds</a> <a href="#">RisikoklasseRenten</a> <a href="#">SachwertImmobilien</a> <a href="#">NichtVertriebUS</a> <a href="#">Muendelsicher</a> <a href="#">AbfertPensionsRStFonds</a> <a href="#">FATCACompliant</a> <a href="#">PensionskassenFondsParagraf25</a> <a href="#">Inflationsschutzanleihen</a> <a href="#">Pensionsinvestmentfonds</a> <a href="#">Convertible</a> <a href="#">AbsMbs</a> <a href="#">NachhaltigkeitsfondsUZ49</a> <a href="#">IndexLizenzhinweis</a> <a href="#">MasterFeederFonds</a> <a href="#">ArtFMV2015</a> <a href="#">KEStMeldefonds</a> <a href="#">KapitalisierungAktien</a> <a href="#">UnterIKEStZinsen98EStG</a> <a href="#">Industrieschwerpunkt</a> <a href="#">AnlageAlternativeInvestments</a> <a href="#">Laufzeitenfonds</a> <a href="#">LaufzeitEnde</a> <a href="#">Garantiefonds</a> <a href="#">ImmobilienInvFG</a> <a href="#">Rohstoff</a> <a href="#">PreismeldungOeKB</a> <a href="#">ArtPreisberechnung</a> <a href="#">Preisveroeffentlichung</a> <a href="#">Rueckfragen</a> <a href="#">EMail</a> <a href="#">Telefon</a> <a href="#">Anmerkungen</a> <a href="#">Datum</a> |
| annotation | documentation<br>Enthaelt die Felder des OeKB Stammdatenblatts lt. Beschreibungen der OeKB  |

#### element CountrySpecificShareClassDataATType/OeKBStammdatenblatt/GueltigAb

|            |  |
|------------|--|
| diagram    |               |
| type       | <b>xs:date</b>   |
| properties | isRef 0<br>content simple  |
| annotation | documentation<br>Datum ab wann das Stammdatenblatt gueltig ist<br>documentation<br>valid since |

#### element CountrySpecificShareClassDataATType/OeKBStammdatenblatt/FMA\_Fondsname

|            |   |
|------------|---|
| diagram    |                      |
| type       | restriction of <b>xs:normalizedString</b>   |
| properties | isRef 0<br>content simple   |
| facets     | Kind Value annotation<br>maxLength 255  |
| annotation | documentation<br>Fondsname laut FMP<br>documentation<br>official fund name according to legal authority |

#### element CountrySpecificShareClassDataATType/OeKBStammdatenblatt/LEI

|         |   |
|---------|---|
| diagram |  |
|---------|---|



|            |  |
|------------|--|
| type       | <a href="#">LEICodeType</a>  |
| properties | isRef 0<br>minOcc 0<br>maxOcc 1<br>content simple  |
| facets     | Kind Value annotation<br>minLength 20<br>maxLength 20<br>pattern ([0-9a-zA-Z]{18}[0-9]{2}) |
| annotation | documentation<br>Legal Entit Identifier<br>documentation<br>Legal Entit Identifier         |

element **CountrySpecificShareClassDataAType/OeKBStammdatenblatt/Tranchenfonds**

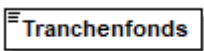
|            |   |
|------------|---|
| diagram    |  <p>Tranchenfonds</p> <p>Flag, ob es sich um einen Tranchenfonds (Gebühren, Währungen, etc.) handelt</p> |
| type       | <b>xs:boolean</b>   |
| properties | isRef 0<br>content simple   |
| annotation | documentation<br>Flag, ob es sich um einen Tranchenfonds (Gebühren, Währungen, etc.) handelt<br>documentation<br>Indicates a hedged or currency tranche                                   |

element **CountrySpecificShareClassDataAType/OeKBStammdatenblatt/ISIN**

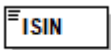
|            |   |
|------------|---|
| diagram    |  <p>ISIN</p> |
| type       | <a href="#">ISINType</a>  |
| properties | isRef 0<br>content simple   |
| facets     | Kind Value annotation<br>length 12<br>pattern [A-Z]{2}[A-Z0-9]{9}[0-9]{1}                       |

element **CountrySpecificShareClassDataAType/OeKBStammdatenblatt/ISIN\_Typ**

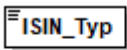
|            |   |
|------------|---|
| diagram    |  <p>ISIN_Typ</p> <p>FONDS<br/>TECHNISCHE_ISIN<br/>C-PLAN</p> |
| type       | restriction of <b>xs:normalizedString</b>   |
| properties | isRef 0<br>content simple   |
| annotation | documentation<br>FONDS<br>TECHNISCHE_ISIN<br>C-PLAN<br>documentation  |

|  |  |
|--|--|
|  | Indicates a regular fund, internal (technical) ISIN or a saving plan |
|--|--|

element **CountrySpecificShareClassDataATType/OeKBStammdatenblatt/ISIN\_Bezeichnung**

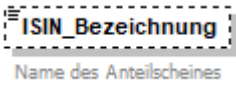
|            |   |
|------------|---|
| diagram    |  |
| type       | restriction of <b>xs:normalizedString</b>   |
| properties | isRef 0<br>minOcc 0<br>maxOcc 1<br>content simple                                 |
| facets     | Kind Value annotation<br>maxLength 255  |
| annotation | documentation<br>Name des Anteilscheines<br>documentation<br>Name of Shareclass   |

element **CountrySpecificShareClassDataATType/OeKBStammdatenblatt/Wrappernummer**

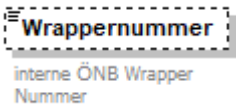
|            |  |
|------------|--|
| diagram    |             |
| type       | <b>xs:unsignedInt</b>  |
| properties | isRef 0<br>minOcc 0<br>maxOcc 1<br>content simple  |
| annotation | documentation<br>interne ÖNB Wrapper Nummer<br>documentation<br>internal OeNB wrapper number |

element **CountrySpecificShareClassDataATType/OeKBStammdatenblatt/OeNB-ID**

|            |   |
|------------|---|
| diagram    |  |
| type       | <a href="#">IdentnummerType</a>   |
| properties | isRef 0<br>minOcc 0<br>maxOcc 1<br>content simple                                   |
| facets     | Kind Value annotation<br>minLength 2<br>maxLength 8<br>pattern [0-9]{2,8}           |
| annotation | documentation<br>OeNB ID des Fonds<br>documentation<br>OeNB ID of the fund          |

element **CountrySpecificShareClassDataAType/OeKBStammdatenblatt/Umbrella\_Flag**

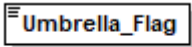
|            |  |
|------------|--|
| diagram    |  <p>Handelt es sich um einen Umbrella Fonds</p> |
| type       | <b>xs:boolean</b>  |
| properties | isRef 0<br>content simple  |
| annotation | documentation<br>Handelt es sich um einen Umbrella Fonds<br>documentation<br>Indicates an umbrealla fund                         |

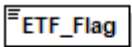

element **CountrySpecificShareClassDataAType/OeKBStammdatenblatt/ETF\_Flag**

|            |   |
|------------|---|
| diagram    |  <p>Handelt es sich um einen börsengehandelten Fonds</p> |
| type       | <b>xs:boolean</b>   |
| properties | isRef 0<br>content simple   |
| annotation | documentation<br>Handelt es sich um einen börsengehandelten Fonds<br>documentation<br>Indicates an ETF                                    |

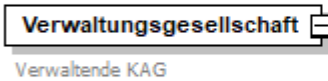
element **CountrySpecificShareClassDataAType/OeKBStammdatenblatt/Verwaltungsgesellschaft**

|            |  |
|------------|--|
| diagram    |  <p>Verwaltende KAG</p> |
| type       | <a href="#">DataSupplierType</a>   |
| properties | isRef 0<br>content complex   |

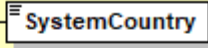
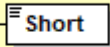
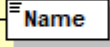
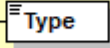
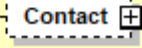
**DataSupplierType**

-  **SystemCountry**  
Country of authority defining the list of valid data suppliers (e.g. AT, DE, ...)
-  **Short**  
Code of supplier (unique per country)
-  **Name**  
Name of data supplier
-  **Type**  
Type of data supplier (e.g. IC, CB, NB, Vendor, ...)
-  **Contact**   
Contact details (name, phone, email)

|            |   |
|------------|---|
| children   | <a href="#">SystemCountry</a> <a href="#">Short Name</a> <a href="#">Type</a> <a href="#">Contact</a> |
| annotation | documentation<br>Verwaltende KAG<br>documentation<br>Asset Manager Company                            |

element **CountrySpecificShareClassDataAType/OeKBStammdatenblatt/LEI\_Depotbank**

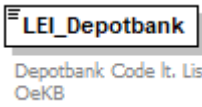
|            |  |
|------------|--|
| diagram    |             |
| type       | <a href="#">LEICodeType</a>  |
| properties | isRef 0<br>content simple  |
| facets     | Kind Value annotation<br>minLength 20<br>maxLength 20<br>pattern (([0-9a-zA-Z]{18}[0-9]{2})) |
| annotation | documentation<br>Depotbank Code lt. Liste OeKB<br>documentation<br>LEI of the Custodian      |

element **CountrySpecificShareClassDataAType/OeKBStammdatenblatt/LEI\_SteuerlicherVertreter**

|            |  |
|------------|--|
| diagram    |           |
| type       | <a href="#">LEICodeType</a>  |
| properties | isRef 0<br>content simple  |
| facets     | Kind Value annotation<br>minLength 20<br>maxLength 20<br>pattern (([0-9a-zA-Z]{18}[0-9]{2})) |
| annotation | documentation<br>LEI des steuerlichen Vertreters<br>documentation<br>LEI of the tax proxy    |

element **CountrySpecificShareClassDataAType/OeKBStammdatenblatt/Tranchenzusatz\_vorne**

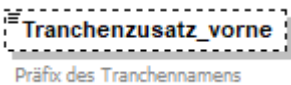
|            |   |
|------------|---|
| diagram    |  |
| type       | restriction of <code>xs:normalizedString</code>                                     |
| properties | isRef 0<br>minOcc 0<br>maxOcc 1<br>content simple                                   |
| facets     | Kind Value annotation<br>maxLength 50   |

|            |  |
|------------|--|
| annotation | documentation<br>Präfix des Tranchennamens<br>documentation<br>präfix of the tranch name |
|------------|--|

element **CountrySpecificShareClassDataATType/OeKBStammdatenblatt/Tranchenzusatz\_hinten**

|            |   |
|------------|---|
| diagram    | <p>The diagram shows a rectangular box representing the element <b>Tranchenzusatz_hinten</b>. The text "Tranchenzusatz_hinten" is enclosed in a dashed-line border, and "Postfix des Tranchennamens" is written below it.</p> |
| type       | restriction of <b>xs:normalizedString</b>   |
| properties | isRef 0<br>minOcc 0<br>maxOcc 1<br>content simple   |
| facets     | Kind Value annotation<br>maxLength 50   |
| annotation | documentation<br>Postfix des Tranchennamens<br>documentation<br>Postfix of the tranch name  |

element **CountrySpecificShareClassDataATType/OeKBStammdatenblatt/GeschaeftsjahrBeginn**

|            |   |
|------------|---|
| diagram    | <p>The diagram shows the <b>GeschaeftsjahrBeginn</b> element (represented by a box with a small square icon) connected to a dashed-line box labeled <b>DayMonthType</b>. Inside this box, a circle with three dots is connected to two sub-elements: <b>Day</b> (with a small square icon) and <b>Month</b> (with a small square icon). Below <b>Day</b> is the text "Day between 1 and 31", and below <b>Month</b> is "Month between 1 and 12". Below the main element box is the text "Geschäftsjahresbeginn TT.MM.".</p> |
| type       | <a href="#">DayMonthType</a>  |
| properties | isRef 0<br>content complex  |
| children   | <a href="#">Day</a> <a href="#">Month</a>   |
| annotation | documentation<br>Geschäftsjahresbeginn TT.MM.<br>documentation<br>Start Of Fiscal Year DD.MM.   |

element **CountrySpecificShareClassDataATType/OeKBStammdatenblatt/GeschaeftsjahrEnde**

|         |   |
|---------|---|
| diagram | <p>The diagram shows the <b>GeschaeftsjahrEnde</b> element (represented by a box with a small square icon) connected to a dashed-line box labeled <b>DayMonthType</b>. Inside this box, a circle with three dots is connected to two sub-elements: <b>Day</b> (with a small square icon) and <b>Month</b> (with a small square icon). Below <b>Day</b> is the text "Day between 1 and 31", and below <b>Month</b> is "Month between 1 and 12". Below the main element box is the text "Geschäftsjahresende TT.MM.".</p> |
|---------|---|

|            |   |
|------------|---|
| type       | <a href="#">DayMonthType</a>  |
| properties | isRef 0<br>content complex  |
| children   | <a href="#">Day</a> <a href="#">Month</a>   |
| annotation | documentation<br>Geschäftsjahresende TT.MM.<br>documentation<br>End of fiscal year DD.MM. |

element **CountrySpecificShareClassDataAType/OeKBStammdatenblatt/Ausschuettungsdatum**

|            |  |
|------------|--|
| diagram    |  |
| type       | <a href="#">DayMonthType</a>   |
| properties | isRef 0<br>content complex   |
| children   | <a href="#">Day</a> <a href="#">Month</a>  |
| annotation | documentation<br>Datum der jährlichen Ausschüttung TT.MM.<br>documentation<br>Date of yearly distribution DD.MM. |

element **CountrySpecificShareClassDataAType/OeKBStammdatenblatt/ISIN-Währung**

| diagram    |   |            |       |            |           |   |  |           |   |  |         |          |  |
|------------|---|------------|-------|------------|-----------|---|--|-----------|---|--|---------|----------|--|
| type       | restriction of <a href="#">ISOCurrencyCodeType</a>  |            |       |            |           |   |  |           |   |  |         |          |  |
| properties | isRef 0<br>content simple   |            |       |            |           |   |  |           |   |  |         |          |  |
| facets     | <table border="1"> <thead> <tr> <th>Kind</th> <th>Value</th> <th>annotation</th> </tr> </thead> <tbody> <tr> <td>minLength</td> <td>3</td> <td></td> </tr> <tr> <td>maxLength</td> <td>3</td> <td></td> </tr> <tr> <td>pattern</td> <td>[A-Z]{3}</td> <td></td> </tr> </tbody> </table> | Kind       | Value | annotation | minLength | 3 |  | maxLength | 3 |  | pattern | [A-Z]{3} |  |
| Kind       | Value   | annotation |       |            |           |   |  |           |   |  |         |          |  |
| minLength  | 3   |            |       |            |           |   |  |           |   |  |         |          |  |
| maxLength  | 3   |            |       |            |           |   |  |           |   |  |         |          |  |
| pattern    | [A-Z]{3}  |            |       |            |           |   |  |           |   |  |         |          |  |
| annotation | documentation<br>Währung des Anteilscheines<br>documentation<br>Currency of the shareclass  |            |       |            |           |   |  |           |   |  |         |          |  |

element **CountrySpecificShareClassDataAType/OeKBStammdatenblatt/DatumErsterNav**

|         |  |
|---------|--|
| diagram |  |
|---------|--|

|            |   |
|------------|---|
| type       | <b>xs:date</b>  |
| properties | isRef 0<br>content simple   |
| annotation | documentation<br>Datum des ersten Fondsvolumens<br>documentation<br>Date of the first NAV |

element **CountrySpecificShareClassDataAType/OeKBStammdatenblatt/Zielgruppe**

|            |  |
|------------|--|
| diagram    | <br>Zielgruppe laut ÖKB |
| type       | restriction of <b>xs:string</b>  |
| properties | isRef 0<br>content simple  |
| annotation | documentation<br>Zielgruppe laut ÖKB<br>documentation<br>investor target group according to ÖKB          |

element **CountrySpecificShareClassDataAType/OeKBStammdatenblatt/Ertragstyp**

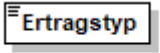
|            |   |
|------------|---|
| diagram    | <br>Anteilscheinsertagstyp |
| type       | restriction of <b>xs:string</b>   |
| properties | isRef 0<br>content simple   |
| annotation | documentation<br>Anteilscheinsertagstyp<br>documentation<br>Shareclass revenue type                         |

element **CountrySpecificShareClassDataAType/OeKBStammdatenblatt/MaxAusgabeaufschlag**

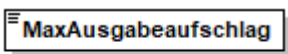
|            |  |
|------------|--|
| diagram    | <br>Max. Ausgabeaufschlag laut<br>Fondsprospekt |
| type       | <a href="#">PercentageType</a>   |
| properties | isRef 0<br>content simple  |
| annotation | documentation<br>Max. Ausgabeaufschlag laut Fondsprospekt<br>documentation<br>max. AGIO according to prospect                      |

element **CountrySpecificShareClassDataAType/OeKBStammdatenblatt/MaxRuecknahmespesen**

|         |  |
|---------|--|
| diagram | <br>Max. Rücknahmegebühr laut<br>Prospekt |
|---------|--|

|            |  |
|------------|--|
| type       | <a href="#">PercentageType</a>   |
| properties | isRef 0<br>content simple  |
| annotation | documentation<br>Max. Rücknahmegebühr laut Prospekt<br>documentation<br>Max. disagio according to prospect |

element **CountrySpecificShareClassDataAType/OeKBStammdatenblatt/MindVerwaltungsgebuehrFlag**

|            |   |
|------------|---|
| diagram    |                  |
| type       | <b>xs:boolean</b>   |
| properties | isRef 0<br>content simple   |
| annotation | documentation<br>gibt es eine Mindestverwaltungsgebühr<br>documentation<br>minimum admin fee flag |

element **CountrySpecificShareClassDataAType/OeKBStammdatenblatt/MaxVerwaltungsgebuehr**

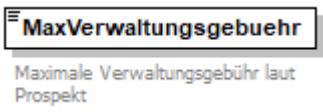
|            |  |
|------------|--|
| diagram    |            |
| type       | <a href="#">PercentageType</a>   |
| properties | isRef 0<br>content simple  |
| annotation | documentation<br>Maximale Verwaltungsgebühr laut Prospekt<br>documentation<br>max. admin fee |

element **CountrySpecificShareClassDataAType/OeKBStammdatenblatt/PerformanceFeeFlag**

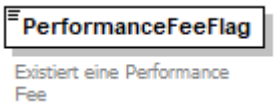
|            |  |
|------------|--|
| diagram    |           |
| type       | <b>xs:boolean</b>  |
| properties | isRef 0<br>content simple  |
| annotation | documentation<br>Existiert eine Performance Fee<br>documentation<br>performance fee existing |

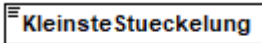

element **CountrySpecificShareClassDataAType/OeKBStammdatenblatt/KleinsteStueckelung**

|            |  |
|------------|--|
| diagram    |  <p>die kleinste Stückelung der Ausgabe</p> |
| type       | restriction of <b>xs:decimal</b>   |
| properties | isRef 0<br>content simple  |
| facets     | Kind Value annotation<br>minInclusive 0  |
| annotation | documentation<br>die kleinste Stückelung der Ausgabe<br>documentation<br>minimum denomination                                |

element **CountrySpecificShareClassDataAType/OeKBStammdatenblatt/MindestinvestmentErsterwerb**

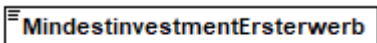
|            |   |
|------------|---|
| diagram    |  <p>Mindestivnest bei Ersterwerb</p> |
| type       | <b>xs:positiveInteger</b>   |
| properties | isRef 0<br>content simple   |
| annotation | documentation<br>Mindestivnest bei Ersterwerb<br>documentation<br>minimum investment first invest                     |

element **CountrySpecificShareClassDataAType/OeKBStammdatenblatt/MindeststueckelungErsterwerb**

|            |  |
|------------|--|
| diagram    |  <p>Mindeststück bei Ersterwerb</p> |
| type       | <b>xs:positiveInteger</b>  |
| properties | isRef 0<br>content simple  |
| annotation | documentation<br>Mindeststück bei Ersterwerb<br>documentation<br>smallest amount of units                              |

element **CountrySpecificShareClassDataAType/OeKBStammdatenblatt/FondsCharakteristik**

|            |   |
|------------|---|
| diagram    |  <b>FondsCharakteristik</b><br>0.1 - Allgemeine<br>Charakteristik des Fonds<br>OGAW OGAW = UCITS<br>AIFRO AIF Privatkunde -<br>offen<br>AIFRG AIF Privatkunde -<br>geschlossen<br>AIFIO AIF professioneller<br>Kunde - offen<br>AIFIG AIF professioneller<br>Kunde - geschlossen<br>EUSEO EUSEF - offen<br>EUSEG EUSEF -<br>geschlossen<br>EUVEO EUVECA - offen<br>EUVEG EUVECA -<br>geschlossen<br>ELTIO ELTIF - offen<br>ELTIG ELTIF - geschlossen |
| type       | restriction of <b>xs:string</b>   |
| properties | isRef 0<br>content simple   |
| annotation | documentation<br>0.1 - Allgemeine Charakteristik des Fonds<br>OGAW OGAW = UCITS<br>AIFRO AIF Privatkunde - offen<br>AIFRG AIF Privatkunde - geschlossen<br>AIFIO AIF professioneller Kunde - offen<br>AIFIG AIF professioneller Kunde - geschlossen<br>EUSEO EUSEF - offen<br>EUSEG EUSEF - geschlossen<br>EUVEO EUVECA - offen<br>EUVEG EUVECA - geschlossen<br>ELTIO ELTIF - offen<br>ELTIG ELTIF - geschlossen<br>documentation<br>legal fund type   |

element **CountrySpecificShareClassDataAType/OeKBStammdatenblatt/Sondervermoegen**

|            |  |
|------------|--|
| diagram    |  <b>Sondervermoegen</b><br>0.2 - Sondervermögen |
| type       | <b>xs:boolean</b>  |
| properties | isRef 0<br>content simple  |
| annotation | documentation<br>0.2 - Sondervermögen<br>documentation<br>separate property  |

element **CountrySpecificShareClassDataAType/OeKBStammdatenblatt/Fondskategorie**

diagram

**Fondskategorie**

- 1.0 - Fondskategorie
- 1.1. Rentenfonds (mind. 51% Rentenanteil)
  - RSHT Short (Duration 0-3 Jahre)
  - RMED Medium (Duration 3-7 Jahre)
  - RLONG Long (Duration ab 7 Jahre)
  - RFLEX Flexibel (Duration flexibel)
- 1.2. Geldmarktfonds
  - MMFST Kurzfristige Geldmarktfonds (Short Term MMF)
  - MMF standard Geldmarktfonds (standard MMF)
- 1.3. Gemischte Fonds
  - GKON Konservativ  
Richtwert: GAU5 Ausgewogen
  - GDYN Dynamisch-Flexibel  
Richtwert:
- 1.4. Aktienfonds
  - AKT Aktien (direkt und/oder indirekt)
- 1.5. Spezifische Ausprägung (mind. 51%)
  - DHF Dachhedgefonds
  - DERF Derivatefonds
- 1.6. Hedge Fonds
  - HLGBS Equity: Long Bias
  - HLGST Equity: Long/Short
  - HMTNL Equity: Market neutral
  - HSTBS Equity: Short Bias
  - HFXIA Relative Value: Fixed Income Arbitrage
  - HCBAR Relative Value: Convertible Bond Arbitrage
  - HVLAR Relative Value: Volatility Arbitrage
  - HDSRS Event Driven: Distressed/Restructuring
  - HRAMA Event Driven: Risk Arbitrage/Merger Arbitrage
  - HEYSS Event Driven: Equity Special Situations
  - HCLST Credit Long/Short
  - HABLG Credit Asset Based Lending
  - HMACR Macro
  - HCTAF Managed
  - HCTAQ Managed
  - Futures/CTA: Quantitative
  - HHFND Multi-strategy hedge fund
  - HOFND Other hedge fund strategy
- 1.7. Private Equity Fonds
  - PVENT Venture Capital
  - PGRTH Growth Capital
  - PMZNE Mezzanine Capital
  - PMULT Multi-strategy private equity fund
  - POTHR Other private equity fund strategy
- 1.8. Real Estate Fonds
  - IRESL Wohnimmobilien
  - ICOML Gewerbeimmobilien
  - IINDL Industrieimmobilien
  - IMULT Gemischte Nutzung

|            |  |
|------------|--|
| type       | restriction of <b>xs:string</b>  |
| properties | isRef 0<br>content simple  |
| annotation | <p>documentation</p> <p>1.0 - Fondskategorie</p> <p>1.1. Rentenfonds (mind. 51% Rentenanteil)</p> <p>RSHT Short (Duration 0-3 Jahre)</p> <p>RMED Medium (Duration 3-7 Jahre)</p> <p>RLONG Long (Duration ab 7 Jahre)</p> <p>RFLEX Flexibel (Duration flexibel)</p> <p>1.2. Geldmarktfonds</p> <p>MMFST Kurzfristige Geldmarktfonds (Short Term MMF)</p> <p>MMF standard Geldmarktfonds (standard MMF)</p> <p>1.3. Gemischte Fonds</p> <p>GKON Konservativ Richtwert:</p> <p>GAUS Ausgewogen Richtwert:</p> <p>GDYN Dynamisch-Flexibel Richtwert:</p> <p>1.4. Aktienfonds</p> <p>AKT Aktien (direkt und/oder indirekt)</p> <p>1.5. Spezifische Ausprägung (mind. 51%)</p> <p>DHF Dachhedgefonds</p> <p>DERF Derivatefonds</p> <p>1.6. Hedge Fonds</p> <p>HLGBS Equity: Long Bias</p> <p>HLGST Equity: Long/Short</p> <p>HMTNL Equity: Market neutral</p> <p>HSTBS Equity: Short Bias</p> <p>HFXIA Relative Value: Fixed Income Arbitrage</p> <p>HCBAR Relative Value: Convertible Bond Arbitrage</p> <p>HVLAR Relative Value: Volatility Arbitrage</p> <p>HDSRS Event Driven: Distressed/Restructuring</p> <p>HARAMA Event Driven: Risk Arbitrage/Merger Arbitrage</p> <p>HEYSS Event Driven: Equity Special Situations</p> <p>HCLST Credit Long/Short</p> <p>HABLG Credit Asset Based Lending</p> <p>HMACR Macro</p> <p>HCTAF Managed Futures/CTA: Fundamental</p> <p>HCTAQ Managed Futures/CTA: Quantitative</p> <p>HHFND Multi-strategy hedge fund</p> <p>HOFND Other hedge fund strategy</p> <p>1.7. Private Equity Fonds</p> <p>PVENT Venture Capital</p> <p>PGRTH Growth Capital</p> <p>PMZNE Mezzanine Capital</p> <p>PMULT Multi-strategy private equity fund</p> <p>POTHR Other private equity fund strategy</p> <p>1.8. Real Estate Fonds</p> <p>IRESL Wohnimmobilien</p> <p>ICOML Gewerbeimmobilien</p> <p>IINDL Industrieimmobilien</p> <p>IMULT Gemischte Nutzung</p> <p>documentation</p> <p>fund investment type</p> |

element **CountrySpecificShareClassDataAType/OeKBStammdatenblatt/ActiveStyleManagement**

|            |   |
|------------|---|
| diagram    |   |
| type       | restriction of <b>xs:string</b>   |
| properties | isRef 0<br>content simple   |
| annotation | documentation<br>5.5. Active Style Management<br>GRWTH Growth<br>VALUE Value<br>BLEND Blend<br>documentation<br>type of active style management |

element **CountrySpecificShareClassDataAType/OeKBStammdatenblatt/PassiveStyleManagement**

|            |  |
|------------|--|
| diagram    |  |
| type       | <b>xs:boolean</b>  |
| properties | isRef 0<br>content simple  |
| annotation | documentation<br>5.6. Passive Style Management - Indextracking<br>documentation<br>passive fund (indextracking) flag |

element **CountrySpecificShareClassDataAType/OeKBStammdatenblatt/RegulatorRisikomanagement**

|            |  |
|------------|--|
| diagram    |  |
| type       | restriction of <b>xs:string</b>  |
| properties | isRef 0<br>content simple  |
| annotation | documentation<br>6.4. Regulatorisches Risikomanagement<br>COMMA Commitment Approach gemäß DerVO<br>VARAB VaR absolut gemäß DerVO<br>VARRE VaR relativ gemäß DerVO<br>documentation<br>regulatory risk management |

element **CountrySpecificShareClassDataAType/OeKBStammdatenblatt/EinsatzDerivate**

|            |  |
|------------|--|
| diagram    |  <b>EinsatzDerivate</b><br>5.12. Einsatz von Derivaten<br>DERH Derivate nur zur Absicherung<br>DERHS Derivate zur Absicherung und als Teil der Anlagestrategie<br>NEIN keine Derivate |
| type       | restriction of <b>xs:string</b>  |
| properties | isRef 0<br>content simple  |
| annotation | documentation<br>5.12. Einsatz von Derivaten<br>DERH Derivate nur zur Absicherung<br>DERHS Derivate zur Absicherung und als Teil der Anlagestrategie<br>NEIN keine Derivate<br>documentation<br>usage of derivatives   |

element **CountrySpecificShareClassDataAType/OeKBStammdatenblatt/ZugehoerigkeitRahmenwerk**

|         |   |
|---------|---|
| diagram |  <b>ZugehoerigkeitRahmenwerk</b><br>2.6. Zugehörigkeit zu Rahmenwerk<br>RK46 OGAW (Publikumsfonds mit Veranlagung gemäß § 46 iVm § 66ff InvFG 2011)<br>RK75 OGAW (Publikumsfonds mit Veranlagung gemäß § 46 iVm § 75 InvFG 2011)<br>NK166 AIF (Publikumsfonds mit Veranlagung gemäß § 166 f InvFG 2011 iVm AIFMG)<br>NKSP AIF (Spezialfonds mit Veranlagung gemäß § 163 ff iVm InvFG 2011 iVm AIFMG)<br>NKSPA AIF (Spezialfonds mit Veranlagung gemäß § 163 iVm § 166f InvFG 2011 iVm AIFMG)<br>NKSPI AIF (Spezialfonds mit Veranlagung gemäß § 163 iVm § 75 InvFG 2011 iVm AIFMG)<br>NKPIF AIF (PIF gemäß § 168ff InvFG 2011)<br>NKPZV AIF (PIF und ZVE gemäß § 168 ff InvFG 2011 iVm § 108 h EStG)<br>NKZVE AIF (ZVE gemäß § 108h EStG)<br>EUSEF EuSEF (gemäß Verordnung (EU) 346/2013 des Europäischen Parlaments und des Rates über Europäische Fonds für soziales Unternehmertum)<br>EUVEC EuVECA (gemäß Verordnung (EU) 345/2013 des Europäischen Parlaments und des Rates über Europäische Risikokapitalfonds)<br>ELTIF ELTIF (gemäß Kommissionsvorschlag)<br>IMMO Immobilieninvestmentfonds gemäß ImmoInvFG iVm AIFMG<br>IMMOG Immobilieninvestmentfonds gemäß AIFMG<br>SONST Sonstige AIF gemäß AIFMG |
|---------|---|

|            |   |
|------------|---|
| type       | restriction of <b>xs:string</b>   |
| properties | isRef 0<br>content simple   |
| annotation | <p>documentation</p> <p>2.6. Zugehörigkeit zu Rahmenwerk</p> <p>RK46 OGAW (Publikumsfonds mit Veranlagung gemäß § 46 iVm § 66ff InvFG 2011)</p> <p>RK75 OGAW (Publikumsfonds mit Veranlagung gemäß § 46 iVm § 75 InvFG 2011)</p> <p>NK166 AIF (Publikumsfonds mit Veranlagung gemäß § 166 f InvFG 2011 iVm AIFMG )</p> <p>NKSP AIF (Spezialfonds mit Veranlagung gemäß § 163 ff iVm InvFG 2011 iVm AIFMG)</p> <p>NKSPA AIF (Spezialfonds mit Veranlagung gemäß § 163 iVm § 166f InvFG 2011 iVm AIFMG)</p> <p>NKSPI AIF (Spezialfonds mit Veranlagung gemäß § 163 iVm § 75 InvFG 2011 iVm AIFMG)</p> <p>NKPIF AIF (PIF gemäß § 168ff InvFG 2011)</p> <p>NKPZV AIF (PIF und ZVE gemäß § 168 ff InvFG 2011 iVm § 108 h EStG)</p> <p>NKZVE AIF (ZVE gemäß § 108h EStG)</p> <p>EUSEF EuSEF (gemäß Verordnung (EU) 346/2013 des Europäischen Parlaments und des Rates über Europäische Fonds für soziales Unternehmertum)</p> <p>EUVEC EuVECA (gemäß Verordnung (EU) 345/2013 des Europäischen Parlaments und des Rates über Europäische Risikokapitalfonds)</p> <p>ELTIF ELTIF (gemäß Kommissionsvorschlag)</p> <p>IMMO Immobilieninvestmentfonds gemäß ImmoInvFG iVm AIFMG</p> <p>IMMOG Immobilieninvestmentfonds gemäß AIFMG</p> <p>SONST Sonstige AIF gemäß AIFMG</p> <p>documentation</p> <p>legal framework</p> |

element **CountrySpecificShareClassDataATType/OeKBStammdatenblatt/Anlageregion**

|         |  |
|---------|--|
| diagram | <div style="border: 1px solid black; padding: 5px; margin-bottom: 10px;"> <b>Anlageregion</b> </div> <p>4.1. Anlageregion</p> <p>AT Österreich</p> <p>NAM Nordamerika</p> <p>LAM Latein Amerika</p> <p>AP Asien/Pazifischer Raum</p> <p>APX Asien/Pazifischer Raum (ausgenommen Japan)</p> <p>JPN Japan</p> <p>SASIA Südasien - Asia Sub Continent</p> <p>EURGE Europa gesamt</p> <p>EU Europa (EU)</p> <p>EURO Euroland - Euro area</p> <p>EUXUK Europa (ausgenommen UK)</p> <p>ME Mittlerer Osten</p> <p>AFR Afrika</p> <p>MEAEM Mittlerer Osten und Afrika, emerging markets</p> <p>LAMEM Latein Amerika, emerging markets</p> <p>APEM Asien/Pazifischer Raum, emerging markets</p> <p>CEE Mittel- und Osteuropa, emerging markets</p> <p>COMM "Commonwealth of Independent States, emerging markets</p> <p>Gemeinschaft unabhängiger Staaten"</p> <p>GLDM Global, developed markets</p> <p>GLEM Global, emerging markets</p> <p>GLAC Global, all countries</p> |
|---------|--|

|            |   |
|------------|---|
| type       | restriction of <b>xs:string</b>   |
| properties | isRef 0<br>content simple   |
| annotation | documentation<br>4.1. Anlageregion<br>AT Österreich<br>NAM Nordamerika<br>LAM Latein Amerika<br>AP Asien/Pazifischer Raum<br>APXJ Asien/Pazifischer Raum (ausgenommen Japan)<br>JPN Japan<br>SASIA Südasien - Asia Sub Continent<br>EURGE Europa gesamt<br>EU Europa (EU)<br>EURO Euroland - Euro area<br>EUXUK Europa (ausgenommen UK)<br>ME Mittlerer Osten<br>AFR Afrika<br>MEAEM Mittlerer Osten und Afrika, emerging markets<br>LAMEM Latein Amerika, emerging markets<br>APEM Asien/Pazifischer Raum, emerging markets<br>CEE Mittel- und Osteuropa, emerging markets<br>COMM "Commonwealth of Independent States, emerging markets<br>Gemeinschaft unabhängiger Staaten"<br>GLDM Global, developed markets<br>GLEM Global, emerging markets<br>GLAC Global, all countries<br>documentation<br>main investment region |

element **CountrySpecificShareClassDataATType/OeKBStammdatenblatt/Anlagewaehrung**

|            |   |
|------------|---|
| diagram    | <p>4.2. Anlagewährung<br/>EUR EUR (ausschließlich)<br/>EURVW EUR (überwiegend)<br/>EURHG EUR hedged (überwiegend)<br/>SICUR Single Currency<br/>GLDOM Global mit dominanter Währung<br/>GL Global</p>   |
| type       | restriction of <b>xs:string</b>   |
| properties | isRef 0<br>content simple   |
| annotation | documentation<br>4.2. Anlagewährung<br>EUR EUR (ausschließlich)<br>EURVW EUR (überwiegend)<br>EURHG EUR hedged (überwiegend)<br>SICUR Single Currency<br>GLDOM Global mit dominanter Währung<br>GL Global<br>documentation<br>investment currency |



element **CountrySpecificShareClassDataAType/OeKBStammdatenblatt/SRRIKategorie**

|            |  |
|------------|--|
| diagram    |  <p>6.1. SRRI Kategorie<br/> MARKT Market Fund<br/> AR Absolute Return Fund<br/> TR Total Return Fund<br/> STRUC Structural Fund<br/> LIFCY Life Cycle Fund</p> |
| type       | restriction of <b>xs:string</b>  |
| properties | isRef 0<br>content simple  |
| annotation | documentation<br>6.1. SRRI Kategorie<br>MARKT Market Fund<br>AR Absolute Return Fund<br>TR Total Return Fund<br>STRUC Structural Fund<br>LIFCY Life Cycle Fund<br>documentation<br>SRRI category   |

element **CountrySpecificShareClassDataAType/OeKBStammdatenblatt/GeltendesRecht**

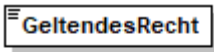
|            |  |
|------------|--|
| diagram    |  <p>2.10. geltendes Recht<br/> AT österr. InvFG oder<br/> österr. ImmoInvFG 2011<br/> und/oder österr. AIFMG<br/> XXX ISO Codes</p> |
| type       | <a href="#">ISOCountryCodeType</a>   |
| properties | isRef 0<br>content simple  |
| facets     | Kind Value annotation<br>minLength 2<br>maxLength 2  |
| annotation | documentation<br>2.10. geltendes Recht<br>AT österr. InvFG oder österr. ImmoInvFG 2011 und/oder österr. AIFMG<br>XXX ISO Codes<br>documentation<br>applicable law  |

element **CountrySpecificShareClassDataAType/OeKBStammdatenblatt/SchwerpunktAnlagewaehrung**

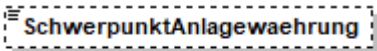
|            |   |
|------------|---|
| diagram    |  <p>ISO-Code darf nur bei Anlagewährung<br/> 'SICUR' oder 'GLDOM' angegeben<br/> werden.</p> |
| type       | <a href="#">ISOCurrencyCodeType</a>   |
| properties | isRef 0<br>minOcc 0<br>maxOcc 1<br>content simple   |
| facets     | Kind Value annotation   |

|            |  |
|------------|--|
|            | minLength 3<br>maxLength 3<br>pattern [A-Z]{3}   |
| annotation | documentation<br>ISO-Code darf nur bei Anlagewährung 'SICUR' oder 'GLDOM' angegeben werden.<br>documentation<br>main investment currency |

element **CountrySpecificShareClassDataAType/OeKBStammdatenblatt/Leerverkauf**

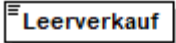
|            |   |
|------------|---|
| diagram    |  <p>- Wenn 'JA' dann darf Allgem. Charakteristik des Fonds nicht 'OGAW' sein. Weiters darf bei 'JA' die Zugehörigkeit zu Rahmenwerk nicht 'RK46', 'RK75', 'NK166', 'NKSP', 'NKSPA', 'NKSPI', 'NKPIF', 'NKPZV', 'NKZVE', 'EUSEF', 'EUVEC', 'ELTIF', 'IMMO' oder 'IMMOG' sein.</p> |
| type       | <b>xs:boolean</b>   |
| properties | isRef 0<br>content simple   |
| annotation | documentation<br>- Wenn 'JA' dann darf Allgem. Charakteristik des Fonds nicht 'OGAW' sein. Weiters darf bei 'JA' die Zugehörigkeit zu Rahmenwerk nicht 'RK46', 'RK75', 'NK166', 'NKSP', 'NKSPA', 'NKSPI', 'NKPIF', 'NKPZV', 'NKZVE', 'EUSEF', 'EUVEC', 'ELTIF', 'IMMO' oder 'IMMOG' sein.<br>documentation<br>short selling allowed                               |

element **CountrySpecificShareClassDataAType/OeKBStammdatenblatt/Fondstyp**

|            |  |
|------------|--|
| diagram    |  <p>3.1. Fondstyp<br/> FOF Dachfonds (mind. 51% Subfonds)<br/> ZIELF Zielfonds (bis max. 10% Subfonds)<br/> INVF Investmentfonds<br/> IMMO Immobilien-Investmentfonds (gemäß ImmoInvFG)<br/> SONST sonstige AIF</p> |
| type       | restriction of <b>xs:string</b>  |
| properties | isRef 0<br>content simple  |
| annotation | documentation<br>3.1. Fondstyp<br>FOF Dachfonds (mind. 51% Subfonds)<br>ZIELF Zielfonds (bis max. 10% Subfonds)<br>INVF Investmentfonds<br>IMMO Immobilien-Investmentfonds (gemäß ImmoInvFG)<br>SONST sonstige AIF<br><br>documentation<br>fund investment type (fund of fund)                         |

element **CountrySpecificShareClassDataAType/OeKBStammdatenblatt/Rententypen**

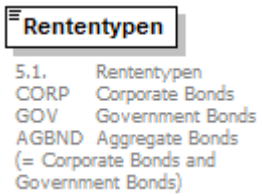
|            |   |
|------------|---|
| diagram    |  <p>5.1. Rententypen<br/> CORP Corporate Bonds<br/> GOV Government Bonds<br/> AGBND Aggregate Bonds<br/> (= Corporate Bonds and<br/> Government Bonds)</p> |
| type       | restriction of <b>xs:string</b>   |
| properties | isRef 0<br>content simple   |
| annotation | documentation<br>5.1. Rententypen<br>CORP Corporate Bonds<br>GOV Government Bonds<br>AGBND Aggregate Bonds (= Corporate Bonds and Government Bonds)<br>documentation<br>Bond type   |

element **CountrySpecificShareClassDataAType/OeKBStammdatenblatt/DurationRentenGemischteFonds**

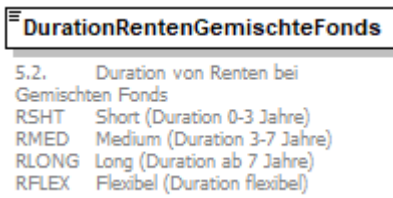
|            |   |
|------------|---|
| diagram    |  <p>5.2. Duration von Renten bei<br/> Gemischten Fonds<br/> RSHT Short (Duration 0-3 Jahre)<br/> RMED Medium (Duration 3-7 Jahre)<br/> RLONG Long (Duration ab 7 Jahre)<br/> RFLEX Flexibel (Duration flexibel)</p> |
| type       | restriction of <b>xs:string</b>   |
| properties | isRef 0<br>content simple   |
| annotation | documentation<br>5.2. Duration von Renten bei Gemischten Fonds<br>RSHT Short (Duration 0-3 Jahre)<br>RMED Medium (Duration 3-7 Jahre)<br>RLONG Long (Duration ab 7 Jahre)<br>RFLEX Flexibel (Duration flexibel)<br>documentation<br>duration of balanced funds  |

element **CountrySpecificShareClassDataAType/OeKBStammdatenblatt/RisikoklasseRenten**

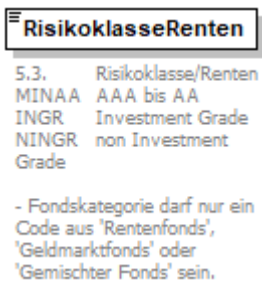
|         |  |
|---------|--|
| diagram |  <p>5.3. Risikoklasse/Renten<br/> MINAA AAA bis AA<br/> INGR Investment Grade<br/> NINGR non Investment<br/> Grade</p> <p>- Fondskategorie darf nur ein<br/> Code aus 'Rentenfonds',<br/> 'Geldmarktfonds' oder<br/> 'Gemischter Fonds' sein.</p> |
| type    | restriction of <b>xs:string</b>  |

|            |   |
|------------|---|
| properties | isRef 0<br>content simple   |
| annotation | documentation<br>5.3. Risikoklasse/Renten<br>MINAA AAA bis AA<br>INGR Investment Grade<br>NINGR non Investment Grade<br><br>- Fondskategorie darf nur ein Code aus 'Rentenfonds', 'Geldmarktfonds' oder 'Gemischter Fonds' sein.<br>documentation<br>bonds rating |

element **CountrySpecificShareClassDataATType/OeKBStammdatenblatt/SachwertImmobilien**

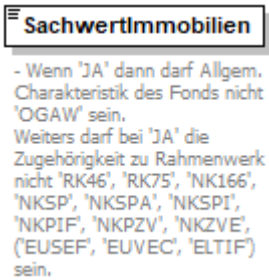
|            |  |
|------------|--|
| diagram    |  <p>- Wenn 'JA' dann darf Allgem. Charakteristik des Fonds nicht 'OGAW' sein.<br/>Weiters darf bei 'JA' die Zugehörigkeit zu Rahmenwerk nicht 'RK46', 'RK75', 'NK166', 'NKSP', 'NKSPA', 'NKSPI', 'NKPIF', 'NKPZV', 'NKZVE', ('EUSEF', 'EUVEC', 'ELTIF') sein.</p> |
| type       | <b>xs:boolean</b>  |
| properties | isRef 0<br>content simple  |
| annotation | documentation<br>- Wenn 'JA' dann darf Allgem. Charakteristik des Fonds nicht 'OGAW' sein.<br>Weiters darf bei 'JA' die Zugehörigkeit zu Rahmenwerk nicht 'RK46', 'RK75', 'NK166', 'NKSP', 'NKSPA', 'NKSPI', 'NKPIF', 'NKPZV', 'NKZVE', ('EUSEF', 'EUVEC', 'ELTIF') sein.<br>documentation<br>commodities / real estate                            |

element **CountrySpecificShareClassDataATType/OeKBStammdatenblatt/NichtVertriebUS**

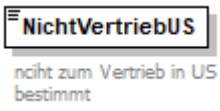
|            |  |
|------------|--|
| diagram    |  <p>nicht zum Vertrieb in US bestimmt</p> |
| type       | <b>xs:boolean</b>  |
| properties | isRef 0<br>content simple  |
| annotation | documentation<br>nicht zum Vertrieb in US bestimmt<br>documentation<br>not distributed in US                                 |

element **CountrySpecificShareClassDataATType/OeKBStammdatenblatt/Muendelsicher**

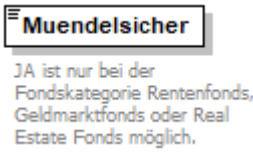
|         |  |
|---------|--|
| diagram |  <p>JA ist nur bei der Fondskategorie Rentenfonds, Geldmarktfonds oder Real Estate Fonds möglich.</p> |
| type    | <b>xs:boolean</b>  |

|            |  |
|------------|--|
| properties | isRef 0<br>content simple  |
| annotation | documentation<br>JA ist nur bei der Fondskategorie Rentenfonds, Geldmarktfonds oder Real Estate Fonds möglich.<br>documentation<br>financial security fund |

element **CountrySpecificShareClassDataAType/OeKBStammdatenblatt/AbfertPensionsRStFonds**

|            |   |
|------------|---|
| diagram    |  <p>JA ist nur bei der Fondskategorie Rentenfonds, Geldmarktfonds, Gemischte Fonds oder Real Estate Fonds möglich.</p> |
| type       | <b>xs:boolean</b>   |
| properties | isRef 0<br>content simple   |
| annotation | documentation<br>JA ist nur bei der Fondskategorie Rentenfonds, Geldmarktfonds, Gemischte Fonds oder Real Estate Fonds möglich.<br>documentation<br>cash reserves fund                                  |

element **CountrySpecificShareClassDataAType/OeKBStammdatenblatt/FATCACompliant**

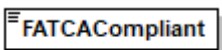
|            |   |
|------------|---|
| diagram    |  <p>FATCA compliant Flag</p> |
| type       | <b>xs:boolean</b>   |
| properties | isRef 0<br>content simple   |
| annotation | documentation<br>FATCA compliant Flag<br>documentation<br>FATCA compliant                                     |

element **CountrySpecificShareClassDataAType/OeKBStammdatenblatt/PensionskassenFondsParagraf25**

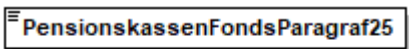
|            |   |
|------------|---|
| diagram    |  <p>JA ist nur bei der Fondskategorie Rentenfonds, Geldmarktfonds, Gemischte Fonds oder Real Estate Fonds möglich.</p> |
| type       | <b>xs:boolean</b>   |
| properties | isRef 0<br>content simple   |
| annotation | documentation<br>JA ist nur bei der Fondskategorie Rentenfonds, Geldmarktfonds, Gemischte Fonds oder Real Estate Fonds möglich.<br>documentation<br>pension fund flag                                     |

element **CountrySpecificShareClassDataAType/OeKBStammdatenblatt/Inflationsschutzanleihen**

|            |  |
|------------|--|
| diagram    |  <p><b>Inflationsschutzanleihen</b></p> <p>Fondskategorie ein 'Rentenfonds' oder 'Gemischter Fonds' sein.</p> |
| type       | <b>xs:boolean</b>  |
| properties | isRef 0<br>content simple  |
| annotation | documentation<br>Fondskategorie ein 'Rentenfonds' oder 'Gemischter Fonds' sein.<br>documentation<br>inflation protectedflag  |

element **CountrySpecificShareClassDataAType/OeKBStammdatenblatt/Pensionsinvestmentfonds**

|            |   |
|------------|---|
| diagram    |  <p><b>Pensionsinvestmentfonds</b></p> <p>2.5. Pensionsinvestmentfonds</p> <p>PIF Pensionsinvestmentfonds</p> <p>ZVE Zukunftsvorsorge-PIF (reine Fondslösung)</p> <p>NEIN Nein</p> <p>Bei PIF und ZVE kann die Allg. Charakteristik des Fonds nicht 'OGAW' sein und die Fondskategorie muss 'Gemischter Fonds' sein.</p> |
| type       | restriction of <b>xs:string</b>   |
| properties | isRef 0<br>content simple   |
| annotation | documentation<br>2.5. Pensionsinvestmentfonds<br>PIF Pensionsinvestmentfonds<br>ZVE Zukunftsvorsorge-PIF (reine Fondslösung)<br>NEIN Nein   |
|            | Bei PIF und ZVE kann die Allg. Charakteristik des Fonds nicht 'OGAW' sein und die Fondskategorie muss 'Gemischter Fonds' sein.<br>documentation<br>pension fund type  |

element **CountrySpecificShareClassDataAType/OeKBStammdatenblatt/Convertibles**

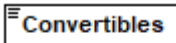
|            |  |
|------------|--|
| diagram    |  <p><b>Convertibles</b></p> <p>- Bei 'JA' muss die Fondskategorie ein 'Rentenfonds' oder 'Gemischter Fonds' sein.</p> |
| type       | <b>xs:boolean</b>  |
| properties | isRef 0<br>content simple  |
| annotation | documentation<br>- Bei 'JA' muss die Fondskategorie ein 'Rentenfonds' oder 'Gemischter Fonds' sein.<br>documentation<br>Convertibles allowed flag  |

element **CountrySpecificShareClassDataATType/OeKBStammdatenblatt/AbsMbs**

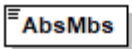
|            |   |
|------------|---|
| diagram    |  <p>- Bei 'JA' muss die Fondskategorie ein 'Rentenfonds' oder 'Gemischter Fonds' sein.</p> |
| type       | <b>xs:boolean</b>   |
| properties | isRef 0<br>content simple   |
| annotation | documentation<br>- Bei 'JA' muss die Fondskategorie ein 'Rentenfonds' oder 'Gemischter Fonds' sein.<br>documentation<br>ABS / MBS flag                                      |

element **CountrySpecificShareClassDataATType/OeKBStammdatenblatt/NachhaltigkeitsfondsUZ49**

|            |  |
|------------|--|
| diagram    |  <p>- Bei 'JA' darf die Fondskategorie nicht 'Geldmarktfonds' sein.</p> |
| type       | <b>xs:boolean</b>  |
| properties | isRef 0<br>content simple  |
| annotation | documentation<br>- Bei 'JA' darf die Fondskategorie nicht 'Geldmarktfonds' sein.<br>documentation<br>sustainable fund                                    |

element **CountrySpecificShareClassDataATType/OeKBStammdatenblatt/IndexLizenzhinweis**

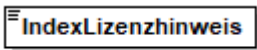
|            |   |
|------------|---|
| diagram    |  <p>Lizenz Hinweis notwendig</p> |
| type       | <b>xs:boolean</b>   |
| properties | isRef 0<br>content simple   |
| annotation | documentation<br>Lizenz Hinweis notwendig<br>documentation<br>license notice required                               |

element **CountrySpecificShareClassDataATType/OeKBStammdatenblatt/MasterFeederFonds**

|         |  |
|---------|--|
| diagram |  <p>2.8. Master Feeder<br/>Fonds<br/>MSTER Master<br/>FDER Feeder<br/>NEIN Nein</p> <p>- Bei FDER muss Fondstyp 'FOF' sein.</p> |
|---------|--|

|            |   |
|------------|---|
| type       | restriction of <b>xs:string</b>   |
| properties | isRef 0<br>content simple   |
| annotation | documentation<br>2.8. Master Feeder Fonds<br>MSTER Master<br>FDER Feeder<br>NEIN Nein<br><br>- Bei FDER muss Fondstyp 'FOF' sein.<br>documentation<br>master or feeder fund |

element **CountrySpecificShareClassDataAType/OeKBStammdatenblatt/ArtFMV2015**

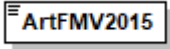
|            |   |
|------------|---|
| diagram    |  |
| type       | restriction of <b>xs:string</b>   |
| properties | isRef 0<br>content simple   |

element **CountrySpecificShareClassDataAType/OeKBStammdatenblatt/KEStMeldefonds**

|            |  |
|------------|--|
| diagram    |  |
| type       | <b>xs:boolean</b>  |
| properties | isRef 0<br>content simple  |
| annotation | documentation<br>KEST Meldefonds Flag<br>documentation<br>capital gains tax flag   |

element **CountrySpecificShareClassDataAType/OeKBStammdatenblatt/KapitalisierungAktien**

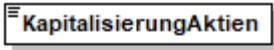
|            |   |
|------------|---|
| diagram    |    |
| type       | restriction of <b>xs:string</b>   |
| properties | isRef 0<br>content simple   |
| annotation | documentation<br>5.4. Kapitalisierung/Aktien<br>SMCAP Small Caps<br>LMCAP Large Caps/Mid Caps<br><br>- Fondskategorie darf nur ein Code aus 'Gemischter Fonds', 'Aktienfonds' oder 'Private Equity Fonds' sein.<br>documentation<br>equity capitalization |



element **CountrySpecificShareClassDataAType/OeKBStammdatenblatt/UnterIKEstZinsen98EstG**

|            |   |
|------------|---|
| diagram    |  <p>Unterliegt dem KEst Zinesen §98 EstG</p> |
| type       | <b>xs:boolean</b>   |
| properties | isRef 0<br>content simple   |
| annotation | documentation<br>Unterliegt dem KEst Zinesen §98 EstG<br>documentation<br>§98 EstG applicapable                               |

element **CountrySpecificShareClassDataAType/OeKBStammdatenblatt/Industrieschwerpunkt**

|            |  |
|------------|--|
| diagram    |  <p>5.14 Industrieschwerpunkt</p> |
| type       | restriction of <b>xs:string</b>  |
| properties | isRef 0<br>content simple  |
| facets     | Kind Value annotation<br>maxLength 255   |
| annotation | documentation<br>5.14 Industrieschwerpunkt<br><br>documentation<br>industry focus                                  |

element **CountrySpecificShareClassDataAType/OeKBStammdatenblatt/AnlageAlternativeInvestments**

|            |   |
|------------|---|
| diagram    |  <p>5.13 Anlage in alternativen Investments (gemäß § 166 Abs 1 Z 3 InvFG 2011)<br/>NEIN keine<br/>AIK10 bis 10%<br/>AIM10 mehr als 10%</p> <p>- 'NEIN' ist zwingend bei Allgem. Charakteristik des Fonds 'OGAW' zu verwenden.<br/>- Bei 'AIK10' und 'AIM10' darf Allgem. Charakteristik des Fonds nicht 'OGAW' sein. (Beachte § 166 Abs. 1 Z 3 InvFG 2011)</p> |
| type       | restriction of <b>xs:string</b>   |
| properties | isRef 0<br>content simple   |
| annotation | documentation<br>5.13 Anlage in alternativen Investments (gemäß § 166 Abs 1 Z 3 InvFG 2011)<br>NEIN keine<br>AIK10 bis 10%<br>AIM10 mehr als 10%  |

|  |  |
|--|--|
|  | <p>- 'NEIN' ist zwingend bei Allgem. Charakteristik des Fonds 'OGAW' zu verwenden.<br/> - Bei 'AIK10' und 'AIM10' darf Allgem. Charakteristik des Fonds nicht 'OGAW' sein. (Beachte § 166 Abs. 1 Z 3 InvFG 2011)</p> <p>documentation<br/> alternative investment percentage allowed</p> |
|--|--|

element **CountrySpecificShareClassDataAType/OeKBStammdatenblatt/Laufzeitenfonds**

|            |   |
|------------|---|
| diagram    |  |
| type       | <b>xs:boolean</b>   |
| properties | isRef 0<br>content simple   |
| annotation | documentation<br>Laufzeitenfonds Flag<br>documentation<br>closed ended fund flag  |

element **CountrySpecificShareClassDataAType/OeKBStammdatenblatt/LaufzeitEnde**

|            |   |
|------------|---|
| diagram    |  |
| type       | <b>xs:date</b>  |
| properties | isRef 0<br>minOcc 0<br>maxOcc 1<br>content simple                                 |
| annotation | documentation<br>Laufzeitenede<br>documentation<br>maturity                       |

element **CountrySpecificShareClassDataAType/OeKBStammdatenblatt/Garantiefonds**

|            |  |
|------------|--|
| diagram    |     |
| type       | <b>xs:boolean</b>  |
| properties | isRef 0<br>content simple  |
| annotation | documentation<br>Garantiefonds Flag<br>documentation<br>investment protected fund flag |

element **CountrySpecificShareClassDataAType/OeKBStammdatenblatt/ImmobilienInvFG**

|            |   |
|------------|---|
| diagram    |  <p>3.7. Immobilien/InvFG<br/> IMM10<br/> Anteil/Immobilienfonds bis zu 10%<br/> IMM20<br/> Anteil/Immobilienfonds bis zu 20%</p> <p>- IMM10 und IMM20 dürfen bei Allgem. Charakteristik des Fonds nicht 'OGAW' haben und als Fondskategorie keinen der 'Real Estate Fonds'. (Beachte § 166 Abs. 1 Z 4 InvFG 2011)</p> |
| type       | restriction of <b>xs:string</b>   |
| properties | isRef 0<br>content simple   |
| annotation | documentation<br>3.7. Immobilien/InvFG<br>IMM10 Anteil/Immobilienfonds bis zu 10%<br>IMM20 Anteil/Immobilienfonds bis zu 20%  |
|            | <p>- IMM10 und IMM20 dürfen bei Allgem. Charakteristik des Fonds nicht 'OGAW' haben und als Fondskategorie keinen der 'Real Estate Fonds'. (Beachte § 166 Abs. 1 Z 4 InvFG 2011)</p> documentation<br>type of real estate fund  |

element **CountrySpecificShareClassDataAType/OeKBStammdatenblatt/Rohstoff**

|            |   |
|------------|---|
| diagram    |  <p>- Wenn 'JA' dann darf Allgem. Charakteristik des Fonds nicht 'OGAW' sein. Weiters darf bei 'JA' die Zugehörigkeit zu Rahmenwerk nicht 'RK46', 'RK75', 'NK166', 'NKSP', 'NKSPA', 'NKSPI', 'NKPIF', 'NKPZV', 'NKZVE', ('EUSEF', 'EUVEC', 'ELTIF'), 'IMMO' oder 'IMMOG' sein.</p> |
| type       | <b>xs:boolean</b>   |
| properties | isRef 0<br>content simple   |
| annotation | documentation<br>- Wenn 'JA' dann darf Allgem. Charakteristik des Fonds nicht 'OGAW' sein. Weiters darf bei 'JA' die Zugehörigkeit zu Rahmenwerk nicht 'RK46', 'RK75', 'NK166', 'NKSP', 'NKSPA', 'NKSPI', 'NKPIF', 'NKPZV', 'NKZVE', ('EUSEF', 'EUVEC', 'ELTIF'), 'IMMO' oder 'IMMOG' sein.   |
|            | documentation<br>Commodity allowed flag   |

element **CountrySpecificShareClassDataAType/OeKBStammdatenblatt/PreismeldungOeKB**

|            |   |
|------------|---|
| diagram    | <p>3.5. Preismeldung an OeKB<br/>TGL tägliche Preismeldung<br/>NTGL nicht tägliche Preismeldung<br/>NEIN keine Preismeldung</p>   |
| type       | restriction of <b>xs:string</b>   |
| properties | isRef 0<br>content simple   |
| annotation | <p>documentation<br/>3.5. Preismeldung an OeKB<br/>TGL tägliche Preismeldung<br/>NTGL nicht tägliche Preismeldung<br/>NEIN keine Preismeldung</p> <p>documentation<br/>daily price delivery to OeKB</p> |

element **CountrySpecificShareClassDataAType/OeKBStammdatenblatt/ArtPreisberechnung**

|            |   |
|------------|---|
| diagram    | <p>3.6. Art der Preisberechnung<br/>DAT+1 Datum Fondspreis = Bewertungsdatum plus 1 Tag<br/>DAT Datum Fondspreis = Bewertungsdatum</p>  |
| type       | restriction of <b>xs:string</b>   |
| properties | isRef 0<br>content simple   |
| annotation | <p>documentation<br/>3.6. Art der Preisberechnung<br/>DAT+1 Datum Fondspreis = Bewertungsdatum plus 1 Tag<br/>DAT Datum Fondspreis = Bewertungsdatum</p> <p>documentation<br/>price day is eod assets (T / T+1)</p> |

element **CountrySpecificShareClassDataAType/OeKBStammdatenblatt/Preisveroeffentlichung**

|            |   |
|------------|---|
| diagram    | <p>Art der Preisveroeffentlichung der ÖKB</p>   |
| type       | restriction of <b>xs:string</b>   |
| properties | isRef 0<br>content simple   |
| annotation | <p>documentation<br/>Art der Preisveroeffentlichung der ÖKB<br/>documentation<br/>Price distribution OeKB</p> |

element **CountrySpecificShareClassDataAType/OeKBStammdatenblatt/Rueckfragen**

|            |   |
|------------|---|
| diagram    |  |
| type       | restriction of <b>xs:string</b>   |
| properties | isRef 0<br>minOcc 0<br>maxOcc 1<br>content simple                                 |
| facets     | Kind Value annotation<br>maxLength 255  |
| annotation | documentation<br>Kontaktname für Rückfragen<br>documentation<br>contact name      |

element **CountrySpecificShareClassDataAType/OeKBStammdatenblatt/EMail**

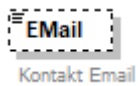
|            |   |
|------------|---|
| diagram    |              |
| type       | <a href="#">EmailAddressType</a>  |
| properties | isRef 0<br>minOcc 0<br>maxOcc 1<br>content simple   |
| facets     | Kind Value annotation<br>pattern [_\a-zA-Z0-9\.\+]+\@[a-zA-Z0-9](\.[\a-zA-Z0-9]*[a-zA-Z0-9])* |
| annotation | documentation<br>Kontakt Email<br>documentation<br>contacts email address                     |

element **CountrySpecificShareClassDataAType/OeKBStammdatenblatt/Telefon**

|            |   |
|------------|---|
| diagram    |  |
| type       | restriction of <b>xs:string</b>   |
| properties | isRef 0<br>minOcc 0<br>maxOcc 1<br>content simple                                   |
| facets     | Kind Value annotation<br>maxLength 50   |
| annotation | documentation<br>Kontakt Telefonnummer<br>documentation<br>contat telephone number  |

element **CountrySpecificShareClassDataAType/OeKBStammdatenblatt/Anmerkungen**

|            |   |
|------------|---|
| diagram    |  |
| type       | restriction of <b>xs:string</b>   |
| properties | isRef 0<br>minOcc 0<br>maxOcc 1<br>content simple                                 |
| facets     | Kind Value annotation<br>maxLength 500  |
| annotation | documentation<br>Anmerkungen<br>documentation<br>comments                         |

element **CountrySpecificShareClassDataAType/OeKBStammdatenblatt/Datum**

|            |   |
|------------|---|
| diagram    |  |
| type       | <b>xs:date</b>  |
| properties | isRef 0<br>content simple   |
| annotation | documentation<br>aktuelles Datum<br>documentation<br>actual date                  |

element **CountrySpecificShareClassDataAType/TotalNetAssetValue**

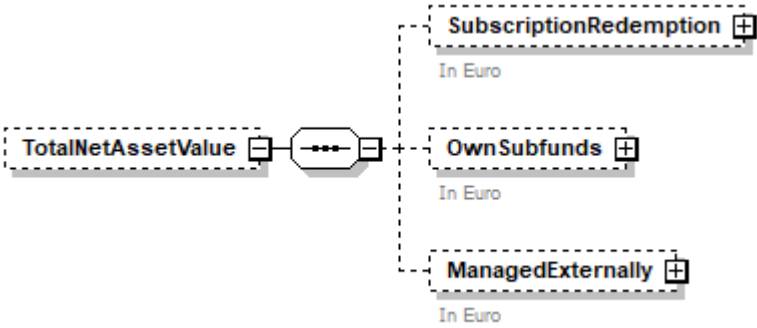
|            |  |
|------------|--|
| diagram    |                  |
| properties | isRef 0<br>minOcc 0<br>maxOcc 1<br>content complex   |
| children   | <a href="#">SubscriptionRedemption</a> <a href="#">OwnSubfunds</a> <a href="#">ManagedExternally</a> |

element **CountrySpecificShareClassDataAType/TotalNetAssetValue/SubscriptionRedemption**

|            |  |
|------------|--|
| diagram    |  |
| type       | <a href="#">FundAmountType</a>   |
| properties | <ul style="list-style-type: none"> <li>isRef 0</li> <li>minOcc 0</li> <li>maxOcc 1</li> <li>content complex</li> </ul> |
| children   | <a href="#">Amount</a>   |
| annotation | <ul style="list-style-type: none"> <li>documentation</li> <li>In Euro</li> </ul>                                       |

element **CountrySpecificShareClassDataAType/TotalNetAssetValue/OwnSubfunds**

|            |  |
|------------|--|
| diagram    |  |
| type       | <a href="#">FundAmountType</a>   |
| properties | <ul style="list-style-type: none"> <li>isRef 0</li> <li>minOcc 0</li> <li>maxOcc 1</li> <li>content complex</li> </ul> |
| children   | <a href="#">Amount</a>   |
| annotation | <ul style="list-style-type: none"> <li>documentation</li> <li>In Euro</li> </ul>                                       |

element **CountrySpecificShareClassDataAType/TotalNetAssetValue/ManagedExternally**

|            |   |
|------------|---|
| diagram    |   |
| type       | <a href="#">FundAmountType</a>  |
| properties | <ul style="list-style-type: none"> <li>isRef 0</li> <li>minOcc 0</li> <li>maxOcc 1</li> </ul> |

|            |                          |
|------------|--------------------------|
|            | content complex          |
| children   | <a href="#">Amount</a>   |
| annotation | documentation<br>In Euro |

### simpleType IdentnummerType

| type       | restriction of <b>xs:string</b>   |            |       |            |           |   |  |           |   |  |         |            |  |
|------------|---|------------|-------|------------|-----------|---|--|-----------|---|--|---------|------------|--|
| properties | final restriction<br>base xs:string   |            |       |            |           |   |  |           |   |  |         |            |  |
| used by    | element <a href="#">CountrySpecificShareClassDataATType/OeKBStammdatenblatt/OeNB-ID</a>   |            |       |            |           |   |  |           |   |  |         |            |  |
| facets     | <table border="1"> <thead> <tr> <th>Kind</th> <th>Value</th> <th>annotation</th> </tr> </thead> <tbody> <tr> <td>minLength</td> <td>2</td> <td></td> </tr> <tr> <td>maxLength</td> <td>8</td> <td></td> </tr> <tr> <td>pattern</td> <td>[0-9]{2,8}</td> <td></td> </tr> </tbody> </table> | Kind       | Value | annotation | minLength | 2 |  | maxLength | 8 |  | pattern | [0-9]{2,8} |  |
| Kind       | Value   | annotation |       |            |           |   |  |           |   |  |         |            |  |
| minLength  | 2   |            |       |            |           |   |  |           |   |  |         |            |  |
| maxLength  | 8   |            |       |            |           |   |  |           |   |  |         |            |  |
| pattern    | [0-9]{2,8}  |            |       |            |           |   |  |           |   |  |         |            |  |
| annotation | documentation<br>Identnummer der Oesterreichischen Nationalbank: maximal 8 stellig numerisch mit Prüziffer  |            |       |            |           |   |  |           |   |  |         |            |  |

### complexType CountrySpecificAssetMasterDataDEType

|            |  |
|------------|--|
| diagram    |  |
| type       | extension of <b>xs:anyType</b>                           |
| properties | base xs:anyType  |
| used by    | element <a href="#">AssetType/CountrySpecificData/DE</a> |

### complexType CountrySpecificControlDataDEType

|         |                                |
|---------|--------------------------------|
| diagram |                                |
| type    | extension of <b>xs:anyType</b> |



|            |  |
|------------|--|
| properties | base <a href="#">xs:anyType</a>                                |
| used by    | element <a href="#">ControlDataType/CountrySpecificData/DE</a> |

### complexType CountrySpecificDataDEType

|            |   |
|------------|---|
| diagram    |   |
| type       | extension of <a href="#">PRIIPS_DE_EPT_PiaType</a>                  |
| properties | base <a href="#">PRIIPS_DE_EPT_PiaType</a>                          |
| children   | <a href="#">Characteristics</a> <a href="#">CapitalPreservation</a> |
| used by    | element <a href="#">CountrySpecificDataType/DE</a>                  |

### complexType CountrySpecificEMTDEType

|          |  |
|----------|--|
| diagram  |  |
| children | <a href="#">EMT_Additional</a>   |
| used by  | elements <a href="#">CountrySpecificEMTDataType/DE</a> <a href="#">CountrySpecificEMT41DataType/DE</a> |

### element CountrySpecificEMTDEType/EMT\_Additional

|            |  |
|------------|--|
| diagram    |  |
| properties | isRef 0<br>content complex   |
| children   | <a href="#">TargetMarketInformation</a> <a href="#">CostTransparency</a> |

element **CountrySpecificEMTDEType/EMT\_Additional/TargetMarketInformation**

diagram

**TargetMarketInformation**

**ModusApproval**

A = Zielmarkt ohne  
Produktgenehmigung B =  
Zielmarkt mit  
Produktgenehmigung C =  
Kein Zielmarkt nur  
Produktgenehmigung

**SpecialRequirementsDescription**

Alphanumerischer Freitext bis zu 140 Zeichen.  
Es ist kein „#“ erlaubt!

**NatureProductCategory**

A = Aktien B = Alternative  
Investmentfonds - Fonds analog  
UCITS mit physischer  
Rohstoffkomponente C =  
Alternative Investmentfonds -  
Closed end funds D = Alternative  
Investmentfonds - Offene  
Immobilien-fonds E = Alternative  
Investmentfonds - Single  
Hedgefonds F = Alternative  
Investmentfonds - Sonstige (inkl.  
Dach-Hedgefonds) G = Anleihen  
(unstrukturiert) H = Anleihen mit  
Zusatzrechten bzw. besonderer  
Besicherung I = Anleihen mit  
Optionsschein J = Contingent  
convertibles K = Genussrechte L  
= Gehebelte Produkte  
(Faktorzertifikate und ETFs mit  
Hebel > 2 gem. Verlustreporting,  
Optionsscheine, Knock-outs) M =  
Investmentfonds (unstrukturiert,  
inkl. ETF: Ak-N  
© WM Datenservice Erstellt von:  
V.Dinges Stand:17.08.2017  
Zielmarkt\_Fonds.Docx Seite 9  
von 15  
Spaltenheader csv-Datei Inhalt  
Zulässige Werte Multi Value J/N  
tien-, Renten-, Geldmarkt-,  
Mischfonds) N = Kuxe O =  
Non-lineare CLNs P =  
Reverse-Produkte (Zertifikate und  
ETFs) Q = Strukturierte  
Anlageprodukte (Zertifikate,  
strukturierte Anleihen, ETCs) R  
= Strukturierte UCITS bzw.  
Investmentfonds S =  
Swap-basierte Fonds T =  
Worst-of-Zertifikate U =  
Zertifikate mit Delta1-Abbildung  
von bekannten Finanzindices

**ApprovalProcess**

A =  
Produktgenehmigungsprozess  
nach MiFIDII B =  
Produktgenehmigungsprozess  
vergleichbar MiFIDII C =  
Produktgenehmigungsprozess  
nicht nach MiFIDII D =  
keine Angabe des  
Emittenten gewünscht

properties

isRef 0  
content complex

|          |  |
|----------|--|
| children | <a href="#">ModusApproval</a> <a href="#">SpecialRequirementsDescription</a> <a href="#">NatureProductCategory</a> <a href="#">ApprovalProcess</a> |
|----------|--|

element **CountrySpecificEMTDEType/EMT\_Additional/TargetMarketInformation/ModusApproval**

|            |   |
|------------|---|
| diagram    | <p><b>ModusApproval</b></p> <p>A = Zielmarkt ohne Produktgenehmigung B = Zielmarkt mit Produktgenehmigung C = Kein Zielmarkt nur Produktgenehmigung</p> |
| type       | restriction of <b>xs:string</b>   |
| properties | isRef 0<br>content <b>simple</b>  |
| facets     | Kind Value annotation<br>pattern [A-C]  |
| annotation | documentation<br>A = Zielmarkt ohne Produktgenehmigung B = Zielmarkt mit Produktgenehmigung C = Kein Zielmarkt nur Produktgenehmigung                   |

element **CountrySpecificEMTDEType/EMT\_Additional/TargetMarketInformation/SpecialRequirementsDescription**

|            |  |
|------------|--|
| diagram    | <p><b>SpecialRequirementsDescription</b></p> <p>Alphanumerischer Freitext bis zu 140 Zeichen.<br/>Es ist kein „#“ erlaubt!</p> |
| type       | restriction of <b>xs:string</b>  |
| properties | isRef 0<br>minOcc 0<br>maxOcc 1<br>content <b>simple</b>   |
| facets     | Kind Value annotation<br>maxLength 140   |
| annotation | documentation<br>Alphanumerischer Freitext bis zu 140 Zeichen. Es ist kein „#“ erlaubt!  |

element **CountrySpecificEMTDEType/EMT\_Additional/TargetMarketInformation/NatureProductCategory**

|                   |   |
|-------------------|---|
| <p>diagram</p>    | <div style="border: 1px solid black; padding: 5px; margin-bottom: 10px;"> <p><b>NatureProductCategory</b></p> </div> <p>A = Aktien B = Alternative Investmentfonds - Fonds analog UCITS mit physischer Rohstoffkomponente C = Alternative Investmentfonds - Closed end funds D = Alternative Investmentfonds - Offene Immobilien-fonds E = Alternative Investmentfonds - Single Hedgefonds F = Alternative Investmentfonds - Sonstige (inkl. Dach-Hedgefonds) G = Anleihen (unstrukturiert) H = Anleihen mit Zusatzrechten bzw. besonderer Besicherung I = Anleihen mit Optionsschein J = Contingent convertibles K = Genussrechte L = Gehebelte Produkte (Faktorzertifikate und ETFs mit Hebel &gt; 2 gem. Verlustreporting, Optionsscheine, Knock-outs) M = Investmentfonds (unstrukturiert, inkl. ETF; Ak-N</p> <p>© WM Datenservice Erstellt von: V.Dinges Stand:17.08.2017 Zielmarkt_Fonds.Docx Seite 9 von 15</p> <p>Spaltenheader csv-Datei Inhalt Zulässige Werte Multi Value J/N tien-, Renten-, Geldmarkt-, Mischfonds) N = Kuxe O = Non-lineare CLNs P = Reverse-Produkte (Zertifikate und ETFs) Q = Strukturierte Anlageprodukte (Zertifikate, strukturierte Anleihen, ETCs) R = Strukturierte UCITS bzw. Investmentfonds S = Swap-basierte Fonds T = Worst-of-Zertifikate U = Zertifikate mit Delta1-Abbildung von bekannten Finanzindizes</p> |
| <p>type</p>       | <p>restriction of xs:string</p>   |
| <p>properties</p> | <p>isRef 0<br/>content simple</p>   |
| <p>facets</p>     | <p>Kind Value annotation<br/>length 1<br/>pattern [A-U]</p>   |
| <p>annotation</p> | <p>documentation</p> <p>A = Aktien B = Alternative Investmentfonds - Fonds analog UCITS mit physischer Rohstoffkomponente C = Alternative Investmentfonds - Closed end funds D = Alternative Investmentfonds - Offene Immobilien-fonds E = Alternative Investmentfonds - Single Hedgefonds F = Alternative Investmentfonds - Sonstige (inkl. Dach-Hedgefonds) G = Anleihen (unstrukturiert) H = Anleihen mit Zusatzrechten bzw. besonderer Besicherung I = Anleihen mit Optionsschein J = Contingent convertibles K = Genussrechte L = Gehebelte Produkte (Faktorzertifikate und ETFs mit Hebel &gt; 2 gem. Verlustreporting, Optionsscheine, Knock-outs) M = Investmentfonds (unstrukturiert, inkl. ETF; Ak-N</p> <p>© WM Datenservice Erstellt von: V.Dinges Stand:17.08.2017 Zielmarkt_Fonds.Docx Seite 9 von 15</p> <p>Spaltenheader csv-Datei Inhalt Zulässige Werte Multi Value J/N tien-, Renten-, Geldmarkt-, Mischfonds) N = Kuxe O = Non-lineare CLNs P = Reverse-Produkte (Zertifikate und ETFs) Q = Strukturierte Anlageprodukte (Zertifikate, strukturierte Anleihen, ETCs) R = Strukturierte UCITS bzw. Investmentfonds S = Swap-basierte Fonds T = Worst-of-Zertifikate U = Zertifikate mit Delta1-Abbildung von bekannten Finanzindizes</p>   |

element **CountrySpecificEMTDEType/EMT\_Additional/TargetMarketInformation/ApprovalProcess**

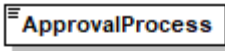
|            |   |
|------------|---|
| diagram    |  <p>A =<br/>Produktgenehmigungsprozess nach MiFIDII B =<br/>Produktgenehmigungsprozess vergleichbar MiFIDII C =<br/>Produktgenehmigungsprozess nicht nach MiFI-DII D =<br/>keine Angabe des Emittenten gewünscht</p> |
| type       | restriction of <b>xs:string</b>   |
| properties | isRef 0<br>content simple   |
| facets     | Kind Value annotation<br>length 1<br>pattern [A-D]  |
| annotation | documentation<br>A = Produktgenehmigungsprozess nach MiFIDII B = Produktgenehmigungsprozess vergleichbar MiFIDII C =<br>Produktgenehmigungsprozess nicht nach MiFI-DII D = keine Angabe des Emittenten gewünscht  |

element **CountrySpecificEMTDEType/EMT\_Additional/CostTransparency**

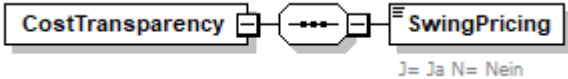
|            |  |
|------------|--|
| diagram    |  <p>J= Ja N= Nein</p> |
| properties | isRef 0<br>content complex   |
| children   | <a href="#">SwingPricing</a>   |

element **CountrySpecificEMTDEType/EMT\_Additional/CostTransparency/SwingPricing**

|            |  |
|------------|--|
| diagram    |  <p>J= Ja N= Nein</p> |
| type       | restriction of <b>xs:string</b>  |
| properties | isRef 0<br>content simple  |
| annotation | documentation<br>J= Ja N= Nein   |

complexType **CountrySpecificFundDataDEType**

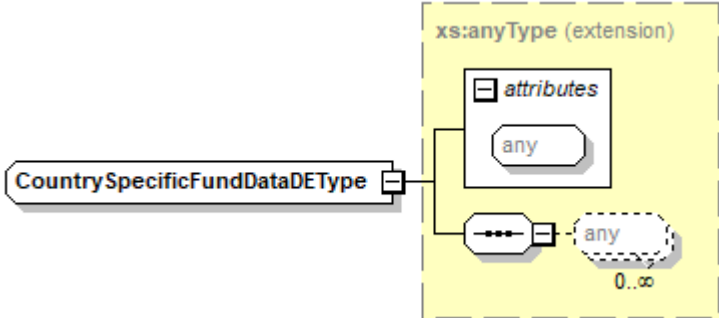
|            |  |
|------------|--|
| diagram    |  |
| type       | extension of <b>xs:anyType</b>   |
| properties | base <b>xs:anyType</b>   |
| used by    | element <a href="#">CountrySpecificFundDataDEType/DE</a>                           |

complexType **CountrySpecificShareClassDataDEType**

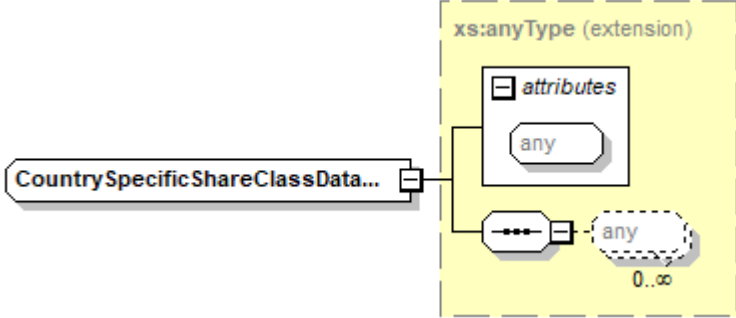
|            |   |
|------------|---|
| diagram    |  |
| type       | extension of <b>xs:anyType</b>  |
| properties | base <b>xs:anyType</b>  |
| used by    | element <a href="#">CountrySpecificShareClassDataDEType/DE</a>                      |

complexType **PRIIPS\_DE\_EPT\_PiaType**

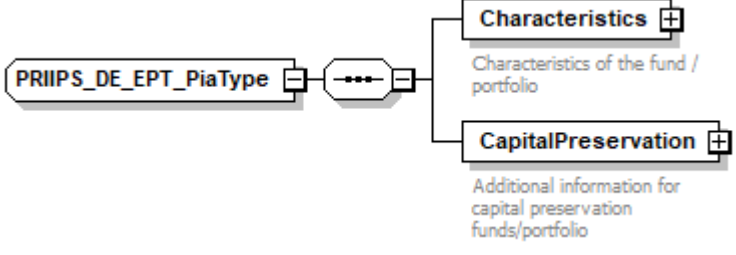
|          |   |
|----------|---|
| diagram  |                                       |
| children | <a href="#">Characteristics</a> <a href="#">CapitalPreservation</a>   |
| used by  | element <a href="#">PRIIPS_ReportType/CountrySpecificData/DE</a><br>complexType <a href="#">CountrySpecificDataDEType</a> |

element **PRIIPS\_DE\_EPT\_PiaType/Characteristics**

|            |  |
|------------|--|
| diagram    |  |
| properties | isRef 0<br>content complex   |
| children   | <a href="#">BondsWeight</a> <a href="#">AnnualizedReturnVolatility</a> <a href="#">DurationBonds</a> |
| annotation | documentation<br>Characteristics of the fund / portfolio   |

element **PRIIPS\_DE\_EPT\_PiaType/Characteristics/BondsWeight**

|            |   |
|------------|---|
| diagram    |   |
| type       | <b>xs:decimal</b>   |
| properties | isRef 0<br>content simple   |
| annotation | documentation<br>06010-Proportion (weight) of bonds within the fund/portfolio measured in percentage of market value. |

element **PRIIPS\_DE\_EPT\_PiaType/Characteristics/AnnualizedReturnVolatility**

|            |  |
|------------|--|
| diagram    |  |
| type       | <b>xs:decimal</b>  |
| properties | isRef 0<br>content simple  |
| annotation | documentation<br>06020-Annualized daily volatility of the fund / portfolio based on the last 250 trading days or, if valuation frequency is lower than daily, the volatility is based on the valuation frequency and annualized. |

element **PRIIPS\_DE\_EPT\_PiaType/Characteristics/DurationBonds**

|            |  |
|------------|--|
| diagram    | <p><b>DurationBonds</b><br/>06030-Asset prices weighted Macaulay-Duration in years of the fund / portfolio</p> |
| type       | <b>xs:decimal</b>  |
| properties | isRef 0<br>content simple  |
| annotation | documentation<br>06030-Asset prices weighted Macaulay-Duration in years of the fund / portfolio                |

element **PRIIPS\_DE\_EPT\_PiaType/CapitalPreservation**

|            |  |
|------------|--|
| diagram    | <p><b>CapitalPreservation</b><br/>Additional information for capital preservation funds/portfolio</p> <ul style="list-style-type: none"> <li><b>Existing_Capital_Preservation</b><br/>06040-Identifies if a capital preservation method is used (Y) or not (N).</li> <li><b>CapitalPreservationLevel</b><br/>06050-100% minus the maximum possible loss in percentage of its market value.</li> <li><b>TimeIntervalMaximumLoss</b><br/>06060-The time period in which a possible loss of a capital preservation funds is measured.<br/>"1"= annual<br/>"2"= biannual<br/>"4"= quarterly<br/>"12"= monthly<br/>"24"= bimonthly<br/>"52"= weekly<br/>"104"= biweekly<br/>"252"= daily</li> <li><b>UsesPI</b><br/>06070-Identifies if PI (Portfolio Insurance including CPPI Constant Proportion Portfolio Insurance) is used (Y) or not (N) for capital preservation.</li> <li><b>MultiplierPI</b><br/>06080-Gives the maximum multiplier value if PI algorithm is us</li> </ul> |
| properties | isRef 0<br>content complex   |
| children   | <a href="#">Existing_Capital_Preservation</a> <a href="#">CapitalPreservationLevel</a> <a href="#">TimeIntervalMaximumLoss</a> <a href="#">UsesPI</a> <a href="#">MultiplierPI</a>   |
| annotation | documentation<br>Additional information for capital preservation funds/portfolio   |



element **PRIIPS\_DE\_EPT\_PiaType/CapitalPreservation/Existing\_Capital\_Preservation**

|            |  |
|------------|--|
| diagram    |  <p>06040-Identifies if a capital preservation method is used (Y) or not (N).</p> |
| type       | <a href="#">YesNoType</a>  |
| properties | isRef 0<br>content simple  |
| annotation | documentation<br>06040-Identifies if a capital preservation method is used (Y) or not (N).   |

element **PRIIPS\_DE\_EPT\_PiaType/CapitalPreservation/CapitalPreservationLevel**

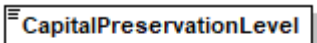
|            |  |
|------------|--|
| diagram    |  <p>06050-100% minus the maximum possible loss in percentage of its market value.</p> |
| type       | <b>xs:decimal</b>  |
| properties | isRef 0<br>content simple  |
| annotation | documentation<br>06050-100% minus the maximum possible loss in percentage of its market value.   |

element **PRIIPS\_DE\_EPT\_PiaType/CapitalPreservation/TimeIntervalMaximumLoss**

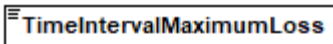
|            |   |
|------------|---|
| diagram    |  <p>06060-The time period in which a possible loss of a capital preservation funds is measured.<br/> "1"= annual<br/> "2"= biannual<br/> "4"= quarterly<br/> "12"= monthly<br/> "24"= bimonthly<br/> "52"= weekly<br/> "104"= biweekly<br/> "252"= daily</p> |
| type       | restriction of <b>xs:integer</b>  |
| properties | isRef 0<br>content simple   |
| annotation | documentation<br>06060-The time period in which a possible loss of a capital preservation funds is measured.<br>"1"= annual<br>"2"= biannual<br>"4"= quarterly<br>"12"= monthly<br>"24"= bimonthly<br>"52"= weekly<br>"104"= biweekly<br>"252"= daily   |

element **PRIIPS\_DE\_EPT\_PiaType/CapitalPreservation/UsesPI**

|            |   |
|------------|---|
| diagram    |  <p>06070-Identifies if PI (Portfolio Insurance including CPPI Constant Proportion Portfolio Insurance) is used (Y) or not (N) for capital preservation.</p> |
| type       | <a href="#">YesNoType</a>   |
| properties | isRef 0<br>content simple   |
| annotation | documentation<br>06070-Identifies if PI (Portfolio Insurance including CPPI Constant Proportion Portfolio Insurance) is used (Y) or not (N) for capital preservation.   |

element **PRIIPS\_DE\_EPT\_PiaType/CapitalPreservation/MultiplierPI**

|            |   |
|------------|---|
| diagram    |  <p>06080-Gives the maximum multiplier value if PI algorithm is us</p> |
| type       | <b>xs:decimal</b>   |
| properties | isRef 0<br>content simple   |
| annotation | documentation<br>06080-Gives the maximum multiplier value if PI algorithm is us   |

complexType **PRIIPS\_V2\_Country\_Specific\_DE**

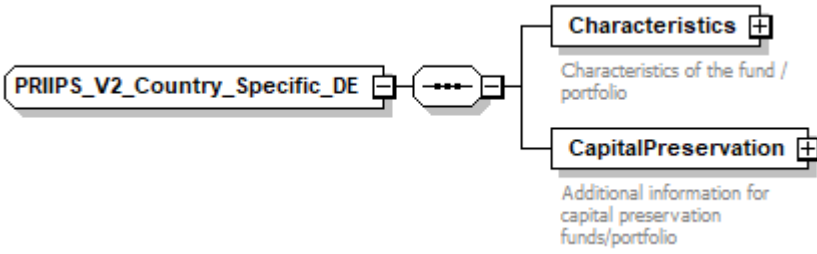
|          |  |
|----------|--|
| diagram  |  <p>The diagram shows a complex type <b>PRIIPS_V2_Country_Specific_DE</b> containing two child elements: <b>Characteristics</b> and <b>CapitalPreservation</b>. The <b>Characteristics</b> element is described as "Characteristics of the fund / portfolio" and the <b>CapitalPreservation</b> element is described as "Additional information for capital preservation funds/portfolio".</p> |
| children | <a href="#">Characteristics</a> <a href="#">CapitalPreservation</a>  |
| used by  | element <a href="#">PRIIPSType_V20/EPTV2/CountrySpecificData/DE</a>  |

element **PRIIPS\_V2\_Country\_Specific\_DE/Characteristics**

|            |   |
|------------|---|
| diagram    | <p>The diagram shows a central box labeled 'Characteristics' with the text 'Characteristics of the fund / portfolio' below it. To its right, a horizontal line with a dashed circle in the middle connects to four stacked boxes, each representing a sub-element:</p> <ul style="list-style-type: none"> <li><b>GermanMOPsReferenceDate</b>: 06005 - Date to which the specific data for underlying options within German MOPs of category 4 refer</li> <li><b>BondsWeight</b>: 06010-Proportion (weight) of bonds within the fund/portfolio measured in percentage of market value.</li> <li><b>AnnualizedReturnVolatility</b>: 06020-Annualized daily volatility of the fund / portfolio based on the last 1250 trading days or, if valuation frequency is lower than daily, the volatility is based on the valuation frequency and annualized.</li> <li><b>DurationBonds</b>: 06030-Asset prices weighted Macaulay-Duration in years of the fund / portfolio</li> </ul> |
| properties | isRef 0<br>content complex  |
| children   | <a href="#">GermanMOPsReferenceDate</a> <a href="#">BondsWeight</a> <a href="#">AnnualizedReturnVolatility</a> <a href="#">DurationBonds</a>  |
| annotation | documentation<br>Characteristics of the fund / portfolio  |

element **PRIIPS\_V2\_Country\_Specific\_DE/Characteristics/GermanMOPsReferenceDate**

|            |  |
|------------|--|
| diagram    | <p>The diagram shows a box labeled 'GermanMOPsReferenceDate' with the text '06005 - Date to which the specific data for underlying options within German MOPs of category 4 refer' below it.</p> |
| type       | <b>xs:date</b>   |
| properties | isRef 0<br>content simple  |
| annotation | documentation<br>06005 - Date to which the specific data for underlying options within German MOPs of category 4 refer   |

element **PRIIPS\_V2\_Country\_Specific\_DE/Characteristics/BondsWeight**

|            |   |
|------------|---|
| diagram    | <p>The diagram shows a box labeled 'BondsWeight' with the text '06010-Proportion (weight) of bonds within the fund/portfolio measured in percentage of market value.' below it.</p> |
| type       | <b>xs:decimal</b>   |
| properties | isRef 0<br>content simple   |
| annotation | documentation<br>06010-Proportion (weight) of bonds within the fund/portfolio measured in percentage of market value.   |

element **PRIIPS\_V2\_Country\_Specific\_DE/Characteristics/AnnualizedReturnVolatility**

|            |   |
|------------|---|
| diagram    |  <b>AnnualizedReturnVolatility</b><br>06020-Annualized daily volatility of the fund / portfolio based on the last 1250 trading days or, if valuation frequency is lower than daily, the volatility is based on the valuation frequency and annualized. |
| type       | <b>xs:decimal</b>   |
| properties | isRef 0<br>content simple   |
| annotation | documentation<br>06020-Annualized daily volatility of the fund / portfolio based on the last 1250 trading days or, if valuation frequency is lower than daily, the volatility is based on the valuation frequency and annualized.   |

element **PRIIPS\_V2\_Country\_Specific\_DE/Characteristics/DurationBonds**

|            |  |
|------------|--|
| diagram    |  <b>DurationBonds</b><br>06030-Asset prices weighted Macaulay-Duration in years of the fund / portfolio |
| type       | <b>xs:decimal</b>  |
| properties | isRef 0<br>content simple  |
| annotation | documentation<br>06030-Asset prices weighted Macaulay-Duration in years of the fund / portfolio  |

element **PRIIPS\_V2\_Country\_Specific\_DE/CapitalPreservation**

|                   |   |
|-------------------|---|
| <p>diagram</p>    | <p><b>CapitalPreservation</b><br/>Additional information for capital preservation funds/portfolio</p> <p><b>Existing_Capital_Preservation</b><br/>06040-Identifies if a capital preservation method is used (Y) or not (N).</p> <p><b>CapitalPreservationLevel</b><br/>06050-100% minus the maximum possible loss in percentage of its market value.</p> <p><b>TimeIntervalMaximumLoss</b><br/>06060-The time period in which a possible loss of a capital preservation funds is measured.<br/>"1" = annual<br/>"2" = biannual<br/>"4" = quarterly<br/>"12" = monthly<br/>"24" = bimonthly<br/>"52" = weekly<br/>"104" = biweekly<br/>"252" = daily</p> <p><b>UsesPI</b><br/>06070-Identifies if PI (Portfolio Insurance including CPPI Constant Proportion Portfolio Insurance) is used (Y) or not (N) for capital preservation.</p> <p><b>MultiplierPI</b><br/>06080-Gives the maximum multiplier value if PI algorithm is us</p> |
| <p>properties</p> | <p>isRef 0<br/>content complex</p>  |
| <p>children</p>   | <p><a href="#">Existing_Capital_Preservation</a> <a href="#">CapitalPreservationLevel</a> <a href="#">TimeIntervalMaximumLoss</a> <a href="#">UsesPI</a> <a href="#">MultiplierPI</a></p>   |
| <p>annotation</p> | <p>documentation<br/>Additional information for capital preservation funds/portfolio</p>  |

element **PRIIPS\_V2\_Country\_Specific\_DE/CapitalPreservation/Existing\_Capital\_Preservation**

|                   |   |
|-------------------|---|
| <p>diagram</p>    | <p><b>Existing_Capital_Preservation</b><br/>06040-Identifies if a capital preservation method is used (Y) or not (N).</p> |
| <p>type</p>       | <p><a href="#">YesNoType</a></p>  |
| <p>properties</p> | <p>isRef 0<br/>content simple</p>   |
| <p>annotation</p> | <p>documentation<br/>06040-Identifies if a capital preservation method is used (Y) or not (N).</p>                        |

element **PRIIPS\_V2\_Country\_Specific\_DE/CapitalPreservation/CapitalPreservationLevel**

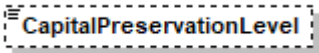
|            |  |
|------------|--|
| diagram    |  <p>06050-100% minus the maximum possible loss in percentage of its market value.</p> |
| type       | <b>xs:decimal</b>  |
| properties | <p>isRef 0<br/> minOcc 0<br/> maxOcc 1<br/> content simple</p>   |
| annotation | <p>documentation<br/> 06050-100% minus the maximum possible loss in percentage of its market value.</p>  |

element **PRIIPS\_V2\_Country\_Specific\_DE/CapitalPreservation/TimeIntervalMaximumLoss**

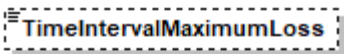
|            |   |
|------------|---|
| diagram    |  <p>06060-The time period in which a possible loss of a capital preservation funds is measured.<br/> "1"= annual<br/> "2"= biannual<br/> "4"= quarterly<br/> "12"= monthly<br/> "24"= bimonthly<br/> "52"= weekly<br/> "104"= biweekly<br/> "252"= daily</p> |
| type       | restriction of <b>xs:integer</b>  |
| properties | <p>isRef 0<br/> minOcc 0<br/> maxOcc 1<br/> content simple</p>  |
| annotation | <p>documentation<br/> 06060-The time period in which a possible loss of a capital preservation funds is measured.<br/> "1"= annual<br/> "2"= biannual<br/> "4"= quarterly<br/> "12"= monthly<br/> "24"= bimonthly<br/> "52"= weekly<br/> "104"= biweekly<br/> "252"= daily</p>  |

element **PRIIPS\_V2\_Country\_Specific\_DE/CapitalPreservation/UsesPI**

|            |   |
|------------|---|
| diagram    |  <p>06070-Identifies if PI (Portfolio Insurance including CPPI Constant Proportion Portfolio Insurance) is used (Y) or not (N) for capital preservation.</p> |
| type       | <a href="#">YesNoType</a>   |
| properties | <p>isRef 0<br/> content simple</p>  |
| annotation | <p>documentation<br/> 06070-Identifies if PI (Portfolio Insurance including CPPI Constant Proportion Portfolio Insurance) is used (Y) or not (N)</p>  |

|  |                           |
|--|---------------------------|
|  | for capital preservation. |
|--|---------------------------|

element **PRIIPS\_V2\_Country\_Specific\_DE/CapitalPreservation/MultiplierPI**

|            |   |
|------------|---|
| diagram    |  <p><b>MultiplierPI</b><br/>06080-Gives the maximum multiplier value if PI algorithm is us</p> |
| type       | <b>xs:decimal</b>   |
| properties | isRef 0<br>minOcc 0<br>maxOcc 1<br>content simple   |
| annotation | documentation<br>06080-Gives the maximum multiplier value if PI algorithm is us   |

complexType **CountrySpecificAssetMasterDataDKType**

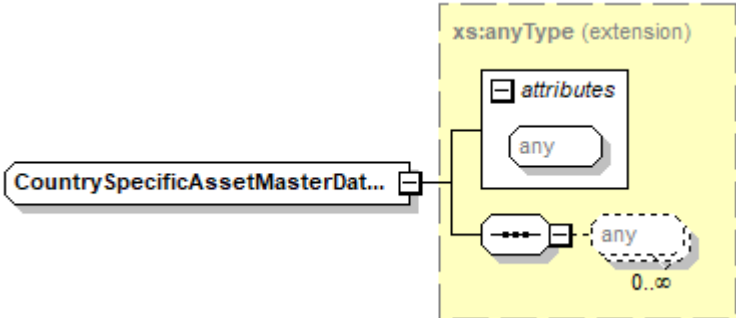
|            |  |
|------------|--|
| diagram    |  <p>The diagram shows a complex type <b>CountrySpecificAssetMasterDataDKType</b> extending <b>xs:anyType</b>. The extension is highlighted in a yellow dashed box. Inside the extension, there is an <b>attributes</b> container with an <b>any</b> attribute. Below the attributes container, there is a sequence of elements: a <b>any</b> element (indicated by a dashed border) and another <b>any</b> element (indicated by a solid border) with a cardinality of <b>0..∞</b>.</p> |
| type       | extension of <b>xs:anyType</b>   |
| properties | base <b>xs:anyType</b>   |
| used by    | element <a href="#">AssetType/CountrySpecificData/DK</a>   |

complexType **CountrySpecificControlDataDKType**

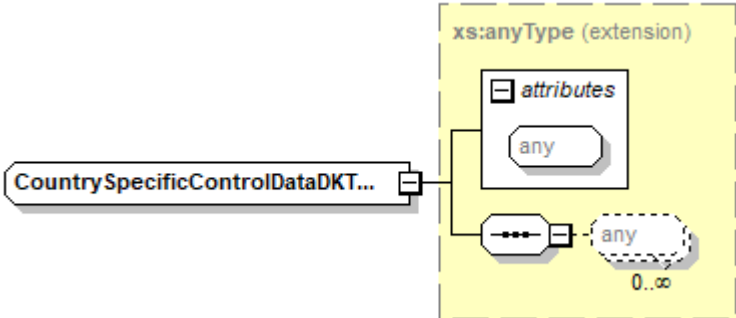
|            |   |
|------------|---|
| diagram    |  <p>The diagram shows a complex type <b>CountrySpecificControlDataDKType</b> extending <b>xs:anyType</b>. The extension is highlighted in a yellow dashed box. Inside the extension, there is an <b>attributes</b> container with an <b>any</b> attribute. Below the attributes container, there is a sequence of elements: a <b>any</b> element (indicated by a dashed border) and another <b>any</b> element (indicated by a solid border) with a cardinality of <b>0..∞</b>.</p> |
| type       | extension of <b>xs:anyType</b>  |
| properties | base <b>xs:anyType</b>  |
| used by    | element <a href="#">ControlDataType/CountrySpecificData/DK</a>  |

complexType **CountrySpecificDataDKType**

|            |  |
|------------|--|
| diagram    |  |
| type       | extension of <b>xs:anyType</b>                     |
| properties | base <b>xs:anyType</b>                             |
| used by    | element <a href="#">CountrySpecificDataType/DK</a> |

complexType **CountrySpecificEMTDKType**

|            |  |
|------------|--|
| diagram    |  |
| type       | extension of <b>xs:anyType</b>   |
| properties | base <b>xs:anyType</b>   |
| used by    | elements <a href="#">CountrySpecificEMTDataType/DK</a> <a href="#">CountrySpecificEMT41DataType/DK</a> |

complexType **CountrySpecificFundDataDKType**

|            |                                |
|------------|--------------------------------|
| diagram    |                                |
| type       | extension of <b>xs:anyType</b> |
| properties | base <b>xs:anyType</b>         |



|         |  |
|---------|--|
| used by | element <a href="#">CountrySpecificFundDataType/DK</a> |
|---------|--|

**complexType CountrySpecificShareClassDataDKType**

|            |  |
|------------|--|
| diagram    |  |
| type       | extension of <b>xs:anyType</b>                               |
| properties | base <b>xs:anyType</b>                                       |
| used by    | element <a href="#">CountrySpecificShareClassDataType/DK</a> |

**complexType CountrySpecificAssetMasterDataFRType**

|            |  |
|------------|--|
| diagram    |  |
| type       | extension of <b>xs:anyType</b>                           |
| properties | base <b>xs:anyType</b>                                   |
| used by    | element <a href="#">AssetType/CountrySpecificData/FR</a> |

**complexType CountrySpecificControlDataFRType**

|         |  |
|---------|--|
| diagram |  |
|---------|--|

|            |  |
|------------|--|
| type       | extension of <b>xs:anyType</b>                                 |
| properties | base <b>xs:anyType</b>   |
| used by    | element <a href="#">ControlDataType/CountrySpecificData/FR</a> |

### complexType **CountrySpecificDataFRType**

|            |  |
|------------|--|
| diagram    |  |
| type       | extension of <b>xs:anyType</b>                     |
| properties | base <b>xs:anyType</b>                             |
| used by    | element <a href="#">CountrySpecificDataType/FR</a> |

### complexType **CountrySpecificEMTFRType**

|            |  |
|------------|--|
| diagram    |  |
| type       | extension of <b>xs:anyType</b>   |
| properties | base <b>xs:anyType</b>   |
| used by    | elements <a href="#">CountrySpecificEMTDataType/FR</a> <a href="#">CountrySpecificEMT41DataType/FR</a> |

### complexType CountrySpecificFundDataFRType

|            |  |
|------------|--|
| diagram    | <p>The diagram illustrates the structure of the <code>CountrySpecificFundDataFRType</code> complex type. It is an extension of the base type <code>xs:anyType</code>. The extension is shown in a yellow dashed box. It contains an <code>attributes</code> container with an <code>any</code> attribute. Additionally, it contains a sequence of <code>any</code> elements, indicated by a dashed oval with a cardinality of <code>0..∞</code>.</p> |
| type       | extension of <code>xs:anyType</code>   |
| properties | base <code>xs:anyType</code>   |
| used by    | element <a href="#">CountrySpecificFundDataType/FR</a>   |

### complexType CountrySpecificShareClassDataFRType

|            |  |
|------------|--|
| diagram    | <p>The diagram illustrates the structure of the <code>CountrySpecificShareClassDataFRType</code> complex type. It is an extension of the base type <code>xs:anyType</code>. The extension is shown in a yellow dashed box. It contains an <code>attributes</code> container with an <code>any</code> attribute. Additionally, it contains a sequence of <code>any</code> elements, indicated by a dashed oval with a cardinality of <code>0..∞</code>.</p> |
| type       | extension of <code>xs:anyType</code>   |
| properties | base <code>xs:anyType</code>   |
| used by    | element <a href="#">CountrySpecificShareClassDataType/FR</a>   |

### complexType CountrySpecificAssetMasterDataLUType

|            |   |
|------------|---|
| diagram    | <p>The diagram illustrates the structure of the <code>CountrySpecificAssetMasterDataLUType</code> complex type. It is an extension of the base type <code>xs:anyType</code>. The extension is shown in a yellow dashed box. It contains an <code>attributes</code> container with an <code>any</code> attribute. Additionally, it contains a sequence of <code>any</code> elements, indicated by a dashed oval with a cardinality of <code>0..∞</code>.</p> |
| type       | extension of <code>xs:anyType</code>  |
| properties | base <code>xs:anyType</code>  |
| used by    | element <a href="#">AssetType/CountrySpecificData/LU</a>  |

**complexType CountrySpecificControlDataLUType**

|            |  |
|------------|--|
| diagram    |  |
| type       | extension of <b>xs:anyType</b>                                 |
| properties | base <b>xs:anyType</b>   |
| used by    | element <a href="#">ControlDataType/CountrySpecificData/LU</a> |

**complexType CountrySpecificDataLUType**

|            |  |
|------------|--|
| diagram    |  |
| type       | extension of <b>xs:anyType</b>                     |
| properties | base <b>xs:anyType</b>                             |
| used by    | element <a href="#">CountrySpecificDataType/LU</a> |

**complexType CountrySpecificEMTLUType**

|         |                                |
|---------|--------------------------------|
| diagram |                                |
| type    | extension of <b>xs:anyType</b> |

|            |  |
|------------|--|
| properties | base <code>xs:anyType</code>   |
| used by    | elements <a href="#">CountrySpecificEMTDataType/LU</a> <a href="#">CountrySpecificEMT41DataType/LU</a> |

### complexType **CountrySpecificFundDataLUType**

|            |  |
|------------|--|
| diagram    | <p>The diagram illustrates the structure of the <code>CountrySpecificFundDataLUType</code> complex type. It is shown as an extension of the base type <code>xs:anyType</code>. The extension is highlighted in a yellow dashed box and contains two main components:     <ul style="list-style-type: none"> <li>An <code>attributes</code> container (represented by a box with a minus sign) containing an <code>any</code> element (represented by a rounded rectangle).</li> <li>A sequence container (represented by a rounded rectangle with a plus sign and a dashed border) containing an <code>any</code> element (represented by a dashed rounded rectangle) with a cardinality of <code>0..∞</code>.</li> </ul>     A line connects the <code>CountrySpecificFundDataLUType</code> box to the extension box.</p> |
| type       | extension of <code>xs:anyType</code>   |
| properties | base <code>xs:anyType</code>   |
| used by    | element <a href="#">CountrySpecificFundDataType/LU</a>   |

### complexType **CountrySpecificShareClassDataLUType**

|            |  |
|------------|--|
| diagram    | <p>The diagram illustrates the structure of the <code>CountrySpecificShareClassDataLUType</code> complex type. It is shown as an extension of the base type <code>xs:anyType</code>. The extension is highlighted in a yellow dashed box and contains two main components:     <ul style="list-style-type: none"> <li>An <code>attributes</code> container (represented by a box with a minus sign) containing an <code>any</code> element (represented by a rounded rectangle).</li> <li>A sequence container (represented by a rounded rectangle with a plus sign and a dashed border) containing an <code>any</code> element (represented by a dashed rounded rectangle) with a cardinality of <code>0..∞</code>.</li> </ul>     A line connects the <code>CountrySpecificShareClassDataLUType</code> box to the extension box.</p> |
| type       | extension of <code>xs:anyType</code>   |
| properties | base <code>xs:anyType</code>   |
| used by    | element <a href="#">CountrySpecificShareClassDataType/LU</a>   |

complexType **CountrySpecificAssetMasterDataNLType**

|            |  |
|------------|--|
| diagram    |  |
| type       | extension of <b>xs:anyType</b>                           |
| properties | base <b>xs:anyType</b>                                   |
| used by    | element <a href="#">AssetType/CountrySpecificData/NL</a> |

complexType **CountrySpecificControlDataNLType**

|            |  |
|------------|--|
| diagram    |  |
| type       | extension of <b>xs:anyType</b>                                 |
| properties | base <b>xs:anyType</b>   |
| used by    | element <a href="#">ControlDataType/CountrySpecificData/NL</a> |

complexType **CountrySpecificDataNLType**

|            |  |
|------------|--|
| diagram    |  |
| type       | extension of <b>xs:anyType</b>                     |
| properties | base <b>xs:anyType</b>                             |
| used by    | element <a href="#">CountrySpecificDataType/NL</a> |

**complexType CountrySpecificEMTNLType**

|            |  |
|------------|--|
| diagram    | <p>The diagram illustrates the structure of the <code>CountrySpecificEMTNLType</code> complex type. It is an extension of the base type <code>xs:anyType</code>. The extension is shown in a yellow dashed box. Inside this box, there is an <code>attributes</code> container (represented by a rectangle with a minus sign) containing an <code>any</code> element (represented by an octagon). Below the <code>attributes</code> container, there is a sequence of <code>any</code> elements (represented by octagons) with a cardinality of <code>0..∞</code>.</p> |
| type       | extension of <code>xs:anyType</code>   |
| properties | base <code>xs:anyType</code>   |
| used by    | elements <a href="#">CountrySpecificEMTDataType/NL</a> <a href="#">CountrySpecificEMT41DataType/NL</a>   |

**complexType CountrySpecificFundDataNLType**

|            |   |
|------------|---|
| diagram    | <p>The diagram illustrates the structure of the <code>CountrySpecificFundDataNLType</code> complex type. It is an extension of the base type <code>xs:anyType</code>. The extension is shown in a yellow dashed box. Inside this box, there is an <code>attributes</code> container (represented by a rectangle with a minus sign) containing an <code>any</code> element (represented by an octagon). Below the <code>attributes</code> container, there is a sequence of <code>any</code> elements (represented by octagons) with a cardinality of <code>0..∞</code>.</p> |
| type       | extension of <code>xs:anyType</code>  |
| properties | base <code>xs:anyType</code>  |
| used by    | element <a href="#">CountrySpecificFundDataType/NL</a>  |

**complexType CountrySpecificShareClassDataNLType**

|         |   |
|---------|---|
| diagram | <p>The diagram illustrates the structure of the <code>CountrySpecificShareClassDataNLType</code> complex type. It is an extension of the base type <code>xs:anyType</code>. The extension is shown in a yellow dashed box. Inside this box, there is an <code>attributes</code> container (represented by a rectangle with a minus sign) containing an <code>any</code> element (represented by an octagon). Below the <code>attributes</code> container, there is a sequence of <code>any</code> elements (represented by octagons) with a cardinality of <code>0..∞</code>.</p> |
| type    | extension of <code>xs:anyType</code>  |

|            |  |
|------------|--|
| properties | base <code>xs:anyType</code>                                 |
| used by    | element <a href="#">CountrySpecificShareClassDataType/NL</a> |

### complexType BreakDownsType

|          |  |
|----------|--|
| diagram  |  |
| children | <a href="#">BreakDown</a>  |
| used by  | elements <a href="#">PortfolioType/BreakDowns</a> <a href="#">BreakDownsType/BreakDown/Values/Value/BreakDowns</a> |

### element BreakDownsType/BreakDown

|            |   |
|------------|---|
| diagram    |   |
| properties | isRef 0<br>minOcc 1<br>maxOcc unbounded<br>content complex                          |
| children   | <a href="#">Dimensions</a> <a href="#">CalculationMethod</a> <a href="#">Values</a> |

### element BreakDownsType/BreakDown/Dimensions

|            |  |
|------------|--|
| diagram    |  |
| properties | isRef 0<br>content complex   |
| children   | <a href="#">Dimension</a>  |
| annotation | documentation<br>Combination of dimensions (e.g. Currency+AssetType) |

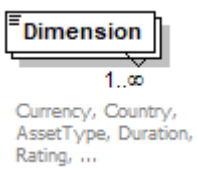

element **BreakDownsType/BreakDown/Dimensions/Dimension**

|            |   |
|------------|---|
| diagram    |  |
| type       | <b>xs:string</b>  |
| properties | isRef 0<br>minOcc 1<br>maxOcc unbounded<br>content simple                         |
| annotation | documentation<br>Currency, Country, AssetType, Duration, Rating, ...              |

element **BreakDownsType/BreakDown/CalculationMethod**

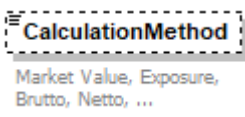
|            |   |
|------------|---|
| diagram    |  |
| type       | <b>xs:string</b>  |
| properties | isRef 0<br>minOcc 0<br>maxOcc 1<br>content simple                                 |
| annotation | documentation<br>Market Value, Exposure, Brutto, Netto, ...                       |

element **BreakDownsType/BreakDown/Values**

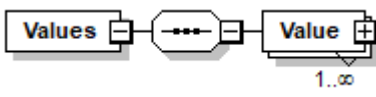
|            |   |
|------------|---|
| diagram    |  |
| properties | isRef 0<br>content complex  |
| children   | <a href="#">Value</a>   |

element **BreakDownsType/BreakDown/Values/Value**

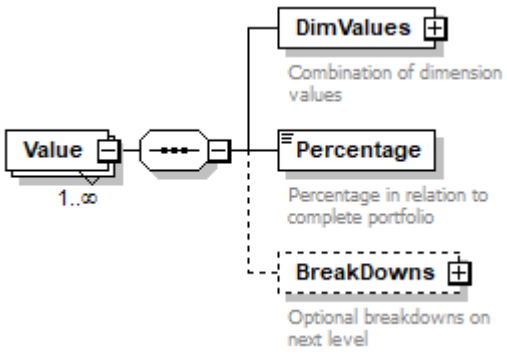
|            |   |
|------------|---|
| diagram    |  |
| properties | isRef 0   |

|          |   |
|----------|---|
|          | minOcc 1<br>maxOcc unbounded<br>content complex                                 |
| children | <a href="#">DimValues</a> <a href="#">Percentage</a> <a href="#">BreakDowns</a> |

element **BreakDownsType/BreakDown/Values/Value/DimValues**

|            |  |
|------------|--|
| diagram    |  |
| properties | isRef 0<br>content complex                       |
| children   | <a href="#">DimValue</a>                         |
| annotation | documentation<br>Combination of dimension values |

element **BreakDownsType/BreakDown/Values/Value/DimValues/DimValue**

|            |  |
|------------|--|
| diagram    |  |
| type       | extension of <b>xs:string</b>                              |
| properties | isRef 0<br>minOcc 1<br>maxOcc unbounded<br>content complex |

attribute **BreakDownsType/BreakDown/Values/Value/DimValues/DimValue/@dim**

|            |                  |
|------------|------------------|
| type       | <b>xs:string</b> |
| properties | isRef 0          |

element **BreakDownsType/BreakDown/Values/Value/Percentage**

|            |   |
|------------|---|
| diagram    |   |
| type       | <a href="#">PercentageType</a>                                |
| properties | isRef 0<br>content simple                                     |
| annotation | documentation<br>Percentage in relation to complete portfolio |

element **BreakDownsType/BreakDown/Values/Value/BreakDowns**

|            |  |
|------------|--|
| diagram    | <p>Optional breakdowns on next level</p>           |
| type       | <a href="#">BreakDownsType</a>                     |
| properties | isRef 0<br>minOcc 0<br>maxOcc 1<br>content complex |
| children   | <a href="#">BreakDown</a>                          |
| annotation | documentation<br>Optional breakdowns on next level |

complexType **ExposureType**

|          |  |
|----------|--|
| diagram  |  |
| children | <a href="#">Exposure</a>                       |
| used by  | element <a href="#">PositionType/Exposures</a> |

element **ExposureType/Exposure**

|            |  |
|------------|--|
| diagram    |  |
| properties | isRef 0<br>minOcc 1<br>maxOcc unbounded<br>content complex |
| children   | <a href="#">Type</a> <a href="#">Value</a>                 |

element **ExposureType/Exposure/Type**

|            |   |
|------------|---|
| diagram    | <p>Type of exposure (commitment approach, AIFMD, ...)</p>           |
| type       | <b>xs:string</b>  |
| properties | isRef 0<br>content simple   |
| annotation | documentation<br>Type of exposure (commitment approach, AIFMD, ...) |

element **ExposureType/Exposure/Value**

|            |                                |
|------------|--------------------------------|
| diagram    |                                |
| type       | <a href="#">FundAmountType</a> |
| properties | isRef 0<br>content complex     |
| children   | <a href="#">Amount</a>         |

complexType **OtherTotalValueType**

|          |   |
|----------|---|
| diagram  |   |
| children | <a href="#">Type</a> <a href="#">Value</a>                            |
| used by  | element <a href="#">PositionType/OtherTotalValues/OtherTotalValue</a> |

element **OtherTotalValueType/Type**

|            |  |
|------------|--|
| diagram    |  |
| type       | <b>xs:string</b>   |
| properties | isRef 0<br>content simple                                    |
| annotation | documentation<br>Type of total value (e.g. Hold-To-Maturity) |

element **OtherTotalValueType/Value**

|         |  |
|---------|--|
| diagram |  |
|---------|--|

|            |                                |
|------------|--------------------------------|
| type       | <a href="#">FundAmountType</a> |
| properties | isRef 0<br>content complex     |
| children   | <a href="#">Amount</a>         |

### complexType PortfolioType

|          |  |
|----------|--|
| diagram  | <p><b>NavDate</b><br/>NavDate for all data within this section</p> <p><b>Positions</b><br/>All positions/holdings of fund/portfolio (including accounts, earnings and fees)</p> <p><b>Transactions</b><br/>Transactions within the portfolio (securities and other assets bought or sold)</p> <p><b>Earnings</b><br/>Earnings data (coupons, dividends, distributions) resulting from security positions</p> <p><b>PositionsDecomposed</b><br/>Decomposed positions (holdings of share classes are replaced by the scaled down positions of the subfund)</p> <p><b>BreakDowns</b><br/>All kind of break down data (including currency exposure)</p> <p><b>RiskCodes</b><br/>List of risk codes (risk indicators, key risk figures)</p> |
| children | <a href="#">NavDate</a> <a href="#">Positions</a> <a href="#">Transactions</a> <a href="#">Earnings</a> <a href="#">PositionsDecomposed</a> <a href="#">BreakDowns</a> <a href="#">RiskCodes</a>   |
| used by  | elements <a href="#">SegmentDynamicDataType/Portfolios/Portfolio</a> <a href="#">FundDynamicDataType/Portfolios/Portfolio</a> <a href="#">ShareClassType/Portfolios/Portfolio</a>  |

### element PortfolioType/NavDate

|            |  |
|------------|--|
| diagram    | <p><b>NavDate</b><br/>NavDate for all data within this section</p> |
| type       | xs:date  |
| properties | isRef 0<br>content simple  |

|            |   |
|------------|---|
| annotation | documentation<br>NavDate for all data within this section |
|------------|---|

element **PortfolioType/Positions**

|            |  |
|------------|--|
| diagram    | <p>PositionsType</p> <p>Positions</p> <p>All positions/holdings of fund/portfolio (including accounts, earnings and fees)</p> <p>Position 1..∞</p> |
| type       | <a href="#">PositionsType</a>  |
| properties | isRef 0<br>minOcc 0<br>maxOcc 1<br>content complex   |
| children   | <a href="#">Position</a>   |
| annotation | documentation<br>All positions/holdings of fund/portfolio (including accounts, earnings and fees)  |

element **PortfolioType/Transactions**

| diagram              | <p>TransactionsType</p> <p>Transactions</p> <p>Transactions within the portfolio (securities and other assets bought or sold)</p> <p>Transaction 1..∞</p> <p>attributes</p> <p>from</p> <p>to</p> <p>constraints</p> <p>key transactionID</p> <p>selector Transaction</p> <p>field TransactionID</p> |       |             |               |          |          |  |               |  |             |               |
|----------------------|--|-------|-------------|---------------|----------|----------|--|---------------|--|-------------|---------------|
| type                 | <a href="#">TransactionsType</a>   |       |             |               |          |          |  |               |  |             |               |
| properties           | isRef 0<br>minOcc 0<br>maxOcc 1<br>content complex   |       |             |               |          |          |  |               |  |             |               |
| children             | <a href="#">Transaction</a>  |       |             |               |          |          |  |               |  |             |               |
| identity constraints | <table border="1"> <thead> <tr> <th>key</th> <th>Name</th> <th>Refer</th> <th>Selector</th> <th>Field(s)</th> </tr> </thead> <tbody> <tr> <td></td> <td>transactionID</td> <td></td> <td>Transaction</td> <td>TransactionID</td> </tr> </tbody> </table>   | key   | Name        | Refer         | Selector | Field(s) |  | transactionID |  | Transaction | TransactionID |
| key                  | Name   | Refer | Selector    | Field(s)      |          |          |  |               |  |             |               |
|                      | transactionID  |       | Transaction | TransactionID |          |          |  |               |  |             |               |

|            |   |
|------------|---|
| annotation | documentation<br>Transactions within the portfolio (securities and other assets bought or sold) |
|------------|---|

element **PortfolioType/Earnings**

|            |  |
|------------|--|
| diagram    | <p>The diagram shows a class <b>Earnings</b> (dashed border) with the description "Earnings data (coupons, dividends, distributions) resulting from security positions". It is connected to a class <b>EarningsType (extension)</b> (yellow background, dashed border). Inside <b>EarningsType</b>, there is a class <b>Earning</b> (solid border) with the description "Earning data (single coupon, dividend or distribution) resulting from a security position" and a multiplicity of <b>1..∞</b>. Below <b>EarningsType</b> is an <b>attributes</b> section containing two attributes: <b>from</b> and <b>to</b>, both in dashed boxes.</p> |
| type       | extension of <a href="#">EarningsType</a>  |
| properties | isRef 0<br>minOcc 0<br>maxOcc 1<br>content complex   |
| children   | <a href="#">Earning</a>  |
| annotation | documentation<br>Earnings data (coupons, dividends, distributions) resulting from security positions   |

attribute **PortfolioType/Earnings/@from**

|            |                |
|------------|----------------|
| type       | <b>xs:date</b> |
| properties | isRef 0        |

attribute **PortfolioType/Earnings/@to**

|            |                |
|------------|----------------|
| type       | <b>xs:date</b> |
| properties | isRef 0        |

element **PortfolioType/PositionsDecomposed**

|            |  |
|------------|--|
| diagram    |  |
| type       | <a href="#">PositionsDecomposedType</a>  |
| properties | <ul style="list-style-type: none"> <li>isRef 0</li> <li>minOcc 0</li> <li>maxOcc 1</li> <li>content complex</li> </ul>   |
| children   | <a href="#">LookThroughLevels</a> <a href="#">LookThroughLimit</a> <a href="#">Positions</a>   |
| annotation | <p>documentation<br/>Decomposed positions (holdings of share classes are replaced by the scaled down positions of the subfund)</p> <p>documentation<br/>Aufgelöste Bestände (Anteilscheinbestände werden durch die anteiligen Bestände des Subfonds ersetzt)</p> |

element **PortfolioType/BreakDowns**

|            |  |
|------------|--|
| diagram    |  |
| type       | <a href="#">BreakDownsType</a>   |
| properties | <ul style="list-style-type: none"> <li>isRef 0</li> <li>minOcc 0</li> <li>maxOcc 1</li> <li>content complex</li> </ul> |
| children   | <a href="#">BreakDown</a>  |
| annotation | <p>documentation<br/>All kind of break down data (including currency exposure)</p>                                     |

element **PortfolioType/RiskCodes**

|            |   |
|------------|---|
| diagram    |   |
| properties | <ul style="list-style-type: none"> <li>isRef 0</li> <li>minOcc 0</li> </ul> |



|            |   |
|------------|---|
|            | maxOcc 1<br>content complex   |
| children   | <a href="#">RiskCode</a>  |
| annotation | documentation<br>List of risk codes (risk indicators, key risk figures)<br>documentation<br>Risiko-Kennzahlen |

element **PortfolioType/RiskCodes/RiskCode**

diagram

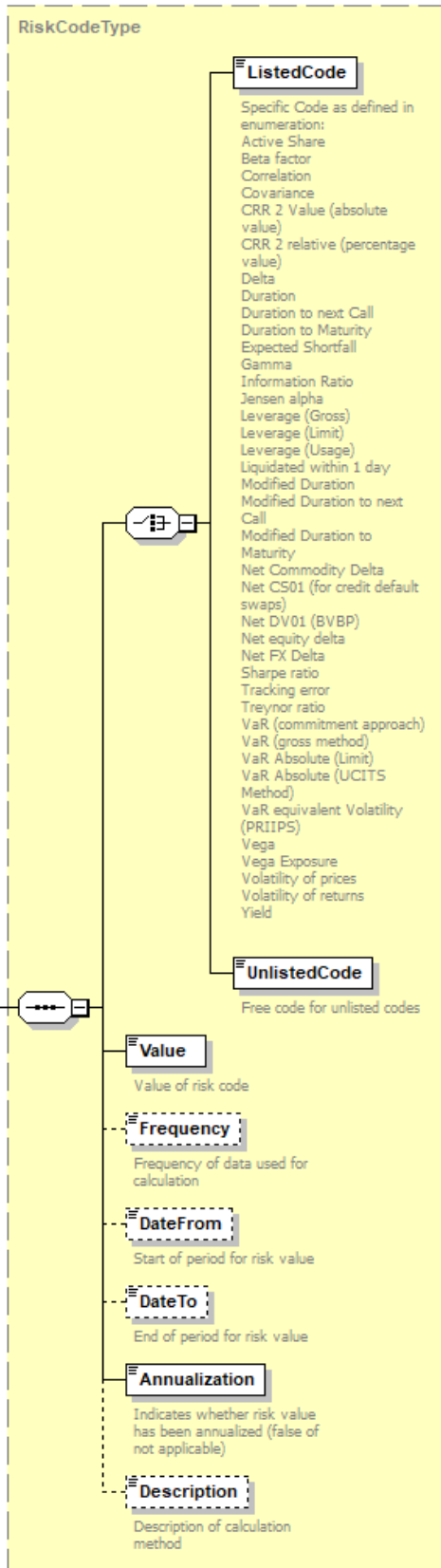

|            |   |
|------------|---|
| type       | <a href="#">RiskCodeType</a>  |
| properties | isRef 0<br>minOcc 1<br>maxOcc unbounded<br>content complex  |
| children   | <a href="#">ListedCode</a> <a href="#">UnlistedCode</a> <a href="#">Value</a> <a href="#">Frequency</a> <a href="#">DateFrom</a> <a href="#">DateTo</a> <a href="#">Annualization</a> <a href="#">Description</a> |
| annotation | documentation<br>Risk code value  |

### complexType **PositionsDecomposedType**

|          |  |
|----------|--|
| diagram  |  |
| children | <a href="#">LookThroughLevels</a> <a href="#">LookThroughLimit</a> <a href="#">Positions</a> |
| used by  | element <a href="#">PortfolioType/PositionsDecomposed</a>                                    |

### element **PositionsDecomposedType/LookThroughLevels**

|            |  |
|------------|--|
| diagram    |  |
| type       | <b>xs:positiveInteger</b>                      |
| properties | isRef 0<br>content simple                      |
| annotation | documentation<br>Number of look-through levels |

### element **PositionsDecomposedType/LookThroughLimit**

|            |   |
|------------|---|
| diagram    |   |
| type       | <a href="#">PercentageType</a>  |
| properties | isRef 0<br>minOcc 0<br>maxOcc 1<br>content simple                                     |
| annotation | documentation<br>All share class positions above this percentage limit are decomposed |

element **PositionsDecomposedType/Positions**

|            |   |
|------------|---|
| diagram    | <p>All positions/holdings of fund/portfolio (including accounts and fees)</p>           |
| type       | <a href="#">PositionsType</a>   |
| properties | isRef 0<br>content complex  |
| children   | <a href="#">Position</a>  |
| annotation | documentation<br>All positions/holdings of fund/portfolio (including accounts and fees) |

complexType **PositionsType**

|          |  |
|----------|--|
| diagram  |  |
| children | <a href="#">Position</a>   |
| used by  | elements <a href="#">PortfolioType/Positions</a> <a href="#">PositionsDecomposedType/Positions</a> |

# element PositionsType/Position

diagram

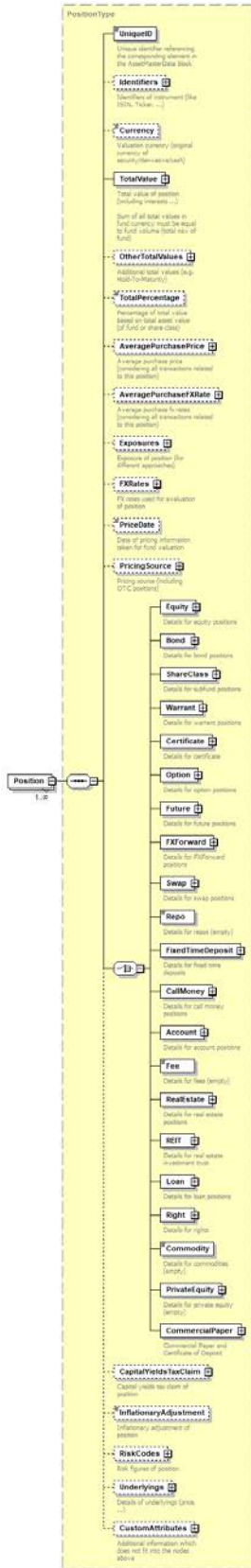

|            |   |
|------------|---|
| type       | <a href="#">PositionType</a>  |
| properties | isRef 0<br>minOcc 1<br>maxOcc unbounded<br>content complex  |
| children   | <a href="#">UniqueID</a> <a href="#">Identifiers</a> <a href="#">Currency</a> <a href="#">TotalValue</a> <a href="#">OtherTotalValues</a> <a href="#">TotalPercentage</a> <a href="#">AveragePurchasePrice</a><br><a href="#">AveragePurchaseFXRate</a> <a href="#">Exposures</a> <a href="#">FXRates</a> <a href="#">PriceDate</a> <a href="#">PricingSource</a> <a href="#">Equity</a> <a href="#">Bond</a> <a href="#">ShareClass</a> <a href="#">Warrant</a> <a href="#">Certificate</a><br><a href="#">Option</a> <a href="#">Future</a> <a href="#">FXForward</a> <a href="#">Swap</a> <a href="#">Repo</a> <a href="#">FixedTimeDeposit</a> <a href="#">CallMoney</a> <a href="#">Account</a> <a href="#">Fee</a> <a href="#">RealEstate</a> <a href="#">REIT</a> <a href="#">Loan</a> <a href="#">Right</a><br><a href="#">Commodity</a> <a href="#">PrivateEquity</a> <a href="#">CommercialPaper</a> <a href="#">CapitalYieldsTaxClaim</a> <a href="#">InflationaryAdjustment</a> <a href="#">RiskCodes</a> <a href="#">Underlyings</a><br><a href="#">CustomAttributes</a> |

# complexType PositionType

diagram

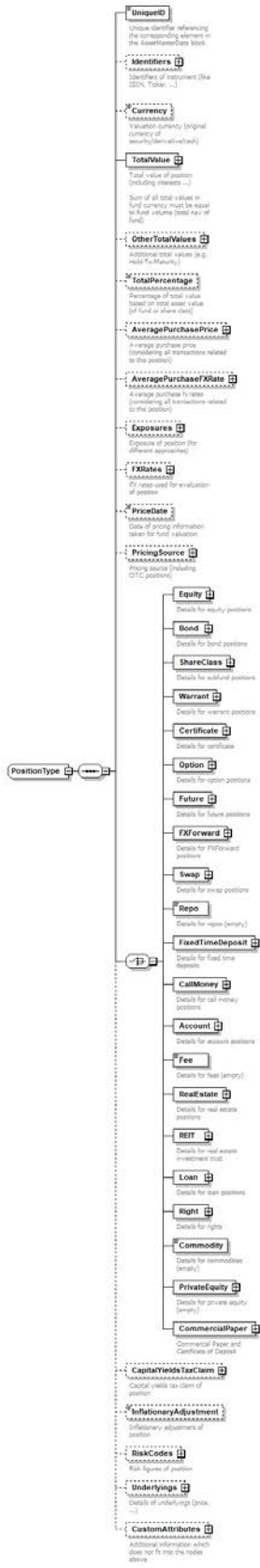

|          |   |
|----------|---|
| children | <a href="#">UniqueID</a> <a href="#">Identifiers</a> <a href="#">Currency</a> <a href="#">TotalValue</a> <a href="#">OtherTotalValues</a> <a href="#">TotalPercentage</a> <a href="#">AveragePurchasePrice</a> <a href="#">AveragePurchaseFXRate</a> <a href="#">Exposures</a> <a href="#">FXRates</a> <a href="#">PriceDate</a> <a href="#">PricingSource</a> <a href="#">Equity</a> <a href="#">Bond</a> <a href="#">ShareClass</a> <a href="#">Warrant</a> <a href="#">Certificate</a> <a href="#">Option</a> <a href="#">Future</a> <a href="#">FXForward</a> <a href="#">Swap</a> <a href="#">Repo</a> <a href="#">FixedTimeDeposit</a> <a href="#">CallMoney</a> <a href="#">Account</a> <a href="#">Fee</a> <a href="#">RealEstate</a> <a href="#">REIT</a> <a href="#">Loan</a> <a href="#">Right</a> <a href="#">Commodity</a> <a href="#">PrivateEquity</a> <a href="#">CommercialPaper</a> <a href="#">CapitalYieldsTaxClaim</a> <a href="#">InflationaryAdjustment</a> <a href="#">RiskCodes</a> <a href="#">Underlyings</a> <a href="#">CustomAttributes</a> |
| used by  | element <a href="#">PositionsType/Position</a>  |

element **PositionType/UniqueID**

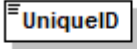
|            |   |
|------------|---|
| diagram    |  <p>Unique identifier referencing the corresponding element in the AssetMasterData block</p>   |
| type       | restriction of <b>xs:IDREF</b>  |
| properties | isRef 0<br>content simple   |
| facets     | Kind Value annotation<br>maxLength 256  |
| annotation | documentation<br>Unique identifier referencing the corresponding element in the AssetMasterData block<br>documentation<br>Eindeutige Referenznummer der Stammdaten der Position (muss unter /AssetMasterData/Asset/UniqueID vorhanden sein) |



element **PositionType/Identifiers**

diagram

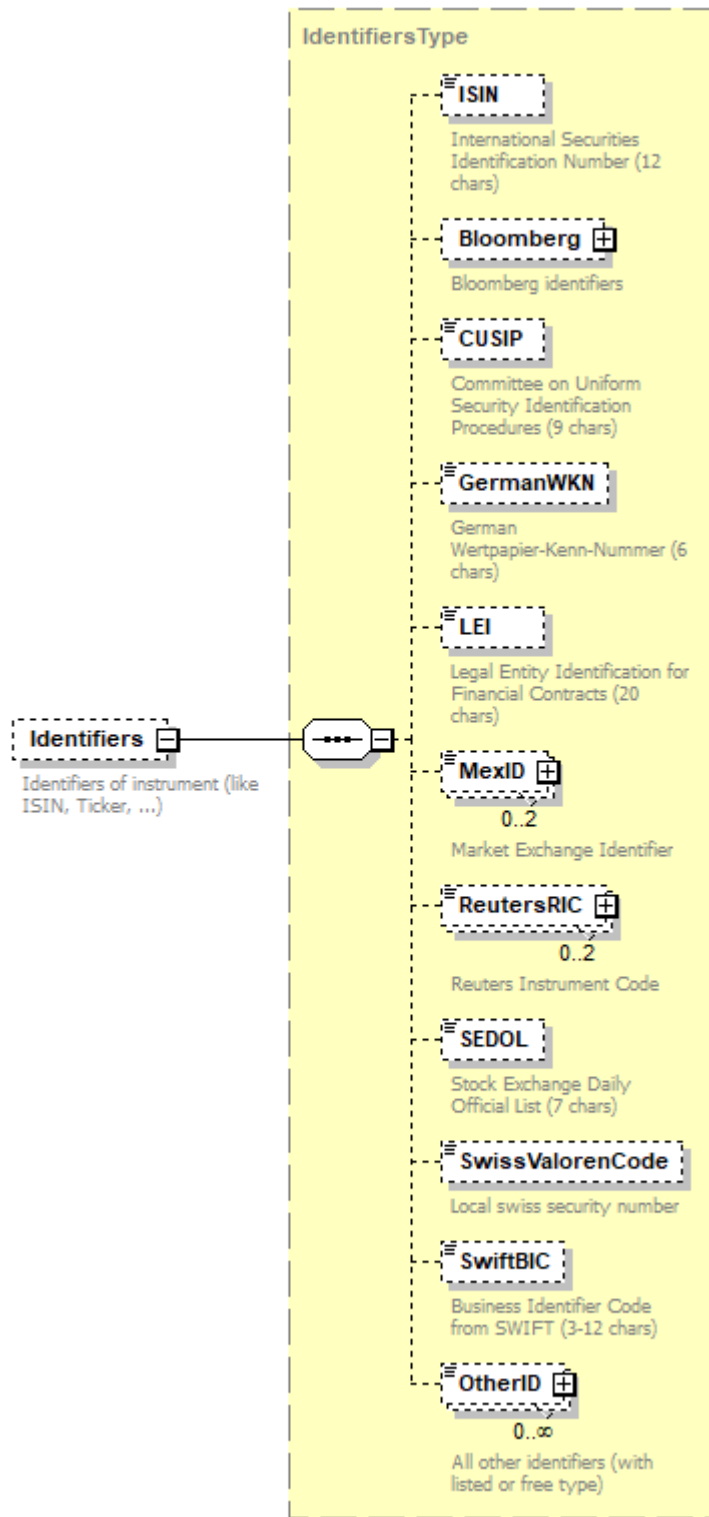

type [IdentifiersType](#)

properties  
 isRef 0  
 minOcc 0  
 maxOcc 1

|            |   |
|------------|---|
|            | content complex   |
| children   | <a href="#">ISIN</a> <a href="#">Bloomberg</a> <a href="#">CUSIP</a> <a href="#">GermanWKN</a> <a href="#">LEI</a> <a href="#">MexID</a> <a href="#">ReutersRIC</a> <a href="#">SEDOL</a> <a href="#">SwissValorenCode</a> <a href="#">SwiftBIC</a> <a href="#">OtherID</a> |
| annotation | documentation<br>Identifiers of instrument (like ISIN, Ticker, ...)<br><br>documentation<br>Kennnummer des im Portfolio enthaltenen Instrumentes (ISIN, Ticker, ...)  |

### element **PositionType/Currency**

|            |  |
|------------|--|
| diagram    |   |
| type       | <a href="#">ISOCurrencyCodeType</a>  |
| properties | isRef 0<br>minOcc 0<br>maxOcc 1<br>content simple  |
| facets     | Kind Value annotation<br>minLength 3<br>maxLength 3<br>pattern [A-Z]{3}  |
| annotation | documentation<br>Valuation currency (original currency of security/derivative/cash)<br>documentation<br>Bewertungswahrung (Wahrung des Wertpapiers/Derivates/Geldes) |

### element **PositionType/TotalValue**

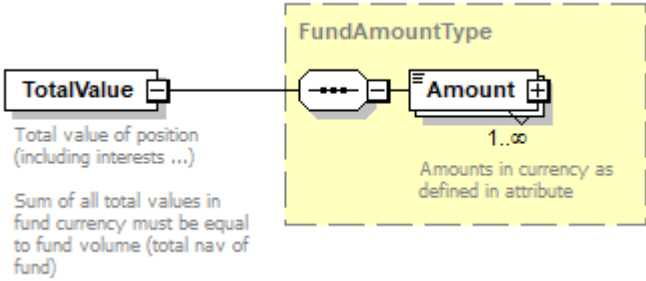
|            |   |
|------------|---|
| diagram    |    |
| type       | <a href="#">FundAmountType</a>  |
| properties | isRef 0<br>content complex  |
| children   | <a href="#">Amount</a>  |
| annotation | documentation<br>Total value of position (including interests ...)<br><br>Sum of all total values in fund currency must be equal to fund volume (total nav of fund) |

element **PositionType/OtherTotalValues**

|            |   |
|------------|---|
| diagram    | <p>Additional total values (e.g. Hold-To-Maturity)</p>                    |
| properties | <p>isRef 0<br/> minOcc 0<br/> maxOcc 1<br/> content complex</p>           |
| children   | <a href="#">OtherTotalValue</a>   |
| annotation | <p>documentation<br/> Additional total values (e.g. Hold-To-Maturity)</p> |

element **PositionType/OtherTotalValues/OtherTotalValue**

|            |   |
|------------|---|
| diagram    | <p>Type of total value (e.g. Hold-To-Maturity)</p>                      |
| type       | <a href="#">OtherTotalValueType</a>                                     |
| properties | <p>isRef 0<br/> minOcc 1<br/> maxOcc unbounded<br/> content complex</p> |
| children   | <a href="#">Type</a> <a href="#">Value</a>                              |

element **PositionType/TotalPercentage**

|            |   |
|------------|---|
| diagram    | <p>Percentage of total value based on total asset value (of fund or share class)</p>                    |
| type       | <a href="#">PercentageType</a>  |
| properties | <p>isRef 0<br/> minOcc 0<br/> maxOcc 1<br/> content simple</p>  |
| annotation | <p>documentation<br/> Percentage of total value based on total asset value (of fund or share class)</p> |

element **PositionType/AveragePurchasePrice**

|            |  |
|------------|--|
| diagram    | <p>Average purchase price (considering all transactions related to this position)</p> <p>FundAmountType</p> <p>Amount</p> <p>1..∞</p> <p>Amounts in currency as defined in attribute</p> |
| type       | <a href="#">FundAmountType</a>   |
| properties | <ul style="list-style-type: none"> <li>isRef 0</li> <li>minOcc 0</li> <li>maxOcc 1</li> <li>content complex</li> </ul>   |
| children   | <a href="#">Amount</a>   |
| annotation | <p>documentation<br/>Average purchase price (considering all transactions related to this position)</p> <p>documentation<br/>Mischeinstands-Preis</p>                                    |

element **PositionType/AveragePurchaseFXRate**

|            |  |
|------------|--|
| diagram    | <p>Average purchase fx rates (considering all transactions related to this position)</p> <p>FXRatesType</p> <p>FXRate</p> <p>1..∞</p>                          |
| type       | <a href="#">FXRatesType</a>  |
| properties | <ul style="list-style-type: none"> <li>isRef 0</li> <li>minOcc 0</li> <li>maxOcc 1</li> <li>content complex</li> </ul>   |
| children   | <a href="#">FXRate</a>   |
| annotation | <p>documentation<br/>Average purchase fx rates (considering all transactions related to this position)</p> <p>documentation<br/>Mischeinstands-Devisenkurs</p> |

element **PositionType/Exposures**

|            |  |
|------------|--|
| diagram    | <p>Exposure of position (for different approaches)</p> <p>ExposureType</p> <p>Exposure</p> <p>1..∞</p>                 |
| type       | <a href="#">ExposureType</a>   |
| properties | <ul style="list-style-type: none"> <li>isRef 0</li> <li>minOcc 0</li> <li>maxOcc 1</li> <li>content complex</li> </ul> |
| children   | <a href="#">Exposure</a>   |

|            |  |
|------------|--|
| annotation | documentation<br>Exposure of position (for different approaches) |
|------------|--|

element **PositionType/FXRates**

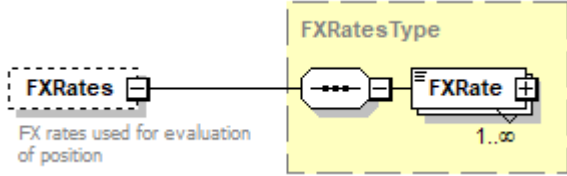
|            |  |
|------------|--|
| diagram    |  <p>The diagram shows a dashed box labeled <b>FXRates</b> with the text "FX rates used for evaluation of position" below it. A line connects this box to a larger dashed box labeled <b>FXRatesType</b>. Inside <b>FXRatesType</b>, there is a box with three dots and a line connecting to a box labeled <b>FXRate</b> with the cardinality "1..∞" below it.</p> |
| type       | <a href="#">FXRatesType</a>  |
| properties | isRef 0<br>minOcc 0<br>maxOcc 1<br>content complex   |
| children   | <a href="#">FXRate</a>   |
| annotation | documentation<br>FX rates used for evaluation of position  |

element **PositionType/PriceDate**

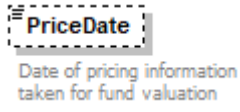
|            |  |
|------------|--|
| diagram    |  <p>The diagram shows a dashed box labeled <b>PriceDate</b> with the text "Date of pricing information taken for fund valuation" below it.</p> |
| type       | <b>xs:date</b>   |
| properties | isRef 0<br>minOcc 0<br>maxOcc 1<br>content simple  |
| annotation | documentation<br>Date of pricing information taken for fund valuation  |

element **PositionType/PricingSource**

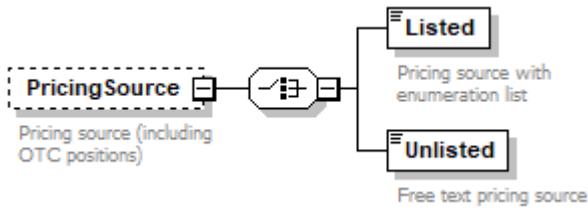
|            |   |
|------------|---|
| diagram    |  <p>The diagram shows a dashed box labeled <b>PricingSource</b> with the text "Pricing source (including OTC positions)" below it. A line connects this box to a box with a list icon. From this box, two lines branch out to boxes labeled <b>Listed</b> and <b>Unlisted</b>. Below <b>Listed</b> is the text "Pricing source with enumeration list", and below <b>Unlisted</b> is the text "Free text pricing source".</p> |
| properties | isRef 0<br>minOcc 0<br>maxOcc 1<br>content complex  |
| children   | <a href="#">Listed</a> <a href="#">Unlisted</a>   |
| annotation | documentation<br>Pricing source (including OTC positions)<br>documentation<br>Gibt die Kursquelle an (auch für OTC-Positionen)  |

element **PositionType/PricingSource/Listed**

|            |   |
|------------|---|
| diagram    |  |
| type       | restriction of <b>xs:string</b>   |
| properties | isRef 0<br>content <b>simple</b>  |
| annotation | documentation<br>Pricing source with enumeration list                             |

element **PositionType/PricingSource/Unlisted**

|            |   |
|------------|---|
| diagram    |  |
| type       | <a href="#">Text200Type</a>   |
| properties | isRef 0<br>content <b>simple</b>  |
| facets     | Kind Value annotation<br>maxLength 200  |
| annotation | documentation<br>Free text pricing source   |

element **PositionType/Equity**

|                   |  |
|-------------------|--|
| <p>diagram</p>    |  |
| <p>properties</p> | <p>isRef 0<br/>content complex</p>   |
| <p>children</p>   | <p><a href="#">Units</a> <a href="#">Price</a> <a href="#">OtherPrices</a> <a href="#">MarketValue</a> <a href="#">BookRate</a> <a href="#">PurchaseValue</a> <a href="#">DividendsDue</a> <a href="#">LendedFlag</a> <a href="#">LendedUnits</a> <a href="#">IndicatorRaffled</a></p> |
| <p>annotation</p> | <p>documentation<br/>Details for equity positions<br/>documentation<br/>documentation<br/>Details für Aktienpositionen</p>   |

element **PositionType/Equity/Units**

|                   |  |
|-------------------|--|
| <p>diagram</p>    |  |
| <p>type</p>       | <p><b>xs:decimal</b></p>                 |
| <p>properties</p> | <p>isRef 0<br/>content simple</p>        |
| <p>annotation</p> | <p>documentation<br/>Units of equity</p> |

|  |  |
|--|--|
|  | documentation<br>Stücke der Aktie im Bestand |
|--|--|

element **PositionType/Equity/Price**

|            |   |
|------------|---|
| diagram    |   |
| type       | <a href="#">FundAmountType</a>  |
| properties | isRef 0<br>minOcc 0<br>maxOcc 1<br>content complex  |
| children   | <a href="#">Amount</a>  |
| annotation | documentation<br>Price (in different currencies)<br>documentation<br>Preis der Aktie (in verschiedenen Währungen) |

element **PositionType/Equity/OtherPrices**

|            |  |
|------------|--|
| diagram    |  |
| type       | <a href="#">OtherPricesType</a>                            |
| properties | isRef 0<br>minOcc 0<br>maxOcc 1<br>content complex         |
| children   | <a href="#">Price</a>                                      |
| annotation | documentation<br>Additional prices (e.g. hold to maturity) |



element **PositionType/Equity/MarketValue**

|            |   |
|------------|---|
| diagram    |   |
| type       | <a href="#">FundAmountType</a>  |
| properties | isRef 0<br>minOcc 0<br>maxOcc 1<br>content complex  |
| children   | <a href="#">Amount</a>  |
| annotation | documentation<br>Market value of position (excluding dividends)<br>documentation<br>Kurswert der Aktienposition (exklusive Ansprüche) |

element **PositionType/Equity/BookRate**

|            |   |
|------------|---|
| diagram    |   |
| type       | <a href="#">FundAmountType</a>                          |
| properties | isRef 0<br>minOcc 0<br>maxOcc 1<br>content complex      |
| children   | <a href="#">Amount</a>                                  |
| annotation | documentation<br>Book rate<br>documentation<br>Buchkurs |

element **PositionType/Equity/PurchaseValue**

|            |                                |
|------------|--------------------------------|
| diagram    |                                |
| type       | <a href="#">FundAmountType</a> |
| properties | isRef 0<br>minOcc 0            |

|            |  |
|------------|--|
|            | maxOcc 1<br>content complex  |
| children   | <a href="#">Amount</a>   |
| annotation | documentation<br>Purchase value of position<br>documentation<br>Einstandswert der Position |

#### element **PositionType/Equity/DividendsDue**

|            |   |
|------------|---|
| diagram    |   |
| type       | <a href="#">FundAmountType</a>  |
| properties | isRef 0<br>minOcc 0<br>maxOcc 1<br>content complex  |
| children   | <a href="#">Amount</a>  |
| annotation | documentation<br>Dividends due of position<br>documentation<br>Dividendenforderungen fuer Aktienbestaende |

#### element **PositionType/Equity/LendedFlag**

|            |   |
|------------|---|
| diagram    |   |
| type       | <b>xs:boolean</b>   |
| properties | isRef 0<br>minOcc 0<br>maxOcc 1<br>content simple   |
| annotation | documentation<br>Flag indicating that part of position is lended<br>documentation<br>Kennzeichen, dass Teile des Bestandes verliehen wurden |

#### element **PositionType/Equity/LendedUnits**

|            |   |
|------------|---|
| diagram    |   |
| type       | <b>xs:decimal</b>                                 |
| properties | isRef 0<br>minOcc 0<br>maxOcc 1<br>content simple |

|            |  |
|------------|--|
| annotation | documentation<br>Number of lended equities<br>documentation<br>Anzahl der verliehenen Stücke |
|------------|--|

element **PositionType/Equity/IndicatorRaffled**

|            |   |
|------------|---|
| diagram    |    |
| type       | <b>xs:boolean</b>   |
| properties | isRef 0<br>minOcc 0<br>maxOcc 1<br>content simple   |
| annotation | documentation<br>Indicates whether security has been raffled<br>documentation<br>Gibt an, ob das Wertpapier verlost wurde |

# element PositionType/Bond

diagram

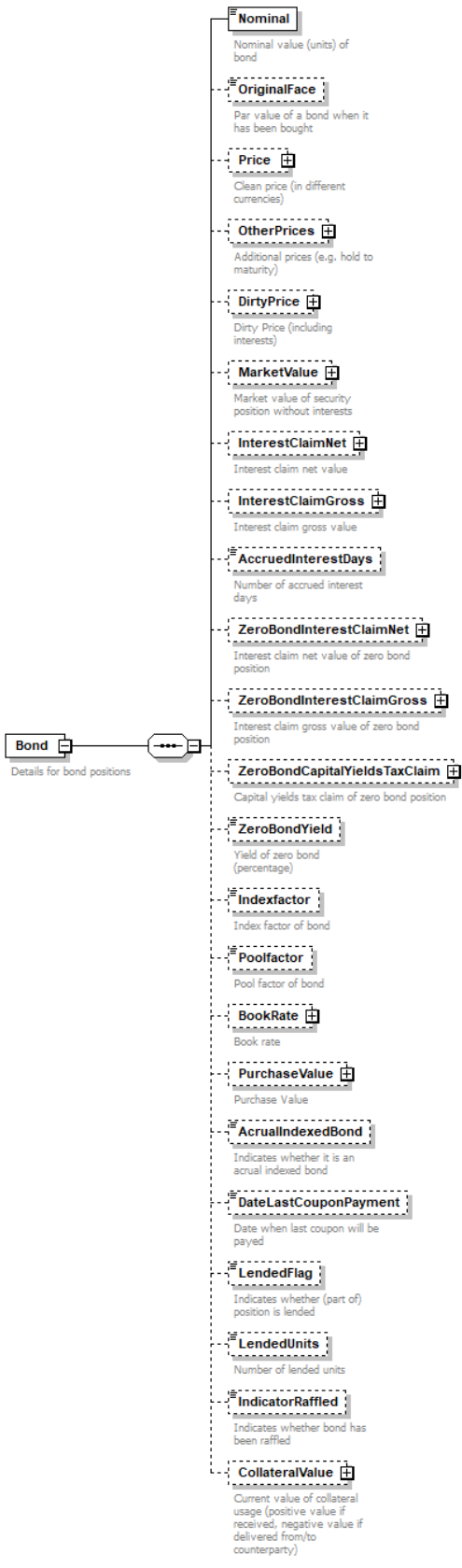

|            |  |
|------------|--|
| properties | isRef 0<br>content complex   |
| children   | <a href="#">Nominal</a> <a href="#">OriginalFace</a> <a href="#">Price</a> <a href="#">OtherPrices</a> <a href="#">DirtyPrice</a> <a href="#">MarketValue</a> <a href="#">InterestClaimNet</a> <a href="#">InterestClaimGross</a> <a href="#">AccruedInterestDays</a> <a href="#">ZeroBondInterestClaimNet</a> <a href="#">ZeroBondInterestClaimGross</a> <a href="#">ZeroBondCapitalYieldsTaxClaim</a> <a href="#">ZeroBondYield</a> <a href="#">Indexfactor</a> <a href="#">Poolfactor</a> <a href="#">BookRate</a> <a href="#">PurchaseValue</a> <a href="#">AcruaIndexedBond</a> <a href="#">DateLastCouponPayment</a> <a href="#">LendedFlag</a> <a href="#">LendedUnits</a> <a href="#">IndicatorRaffled</a> <a href="#">CollateralValue</a> |
| annotation | documentation<br>Details for bond positions  |

### element **PositionType/Bond/Nominal**

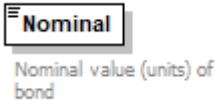
|            |  |
|------------|--|
| diagram    |                         |
| type       | <b>xs:decimal</b>  |
| properties | isRef 0<br>content simple  |
| annotation | documentation<br>Nominal value (units) of bond<br>documentation<br>Nominale/Stückzahl der Rentenposition |

### element **PositionType/Bond/OriginalFace**

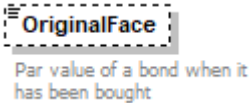
|            |  |
|------------|--|
| diagram    |  |
| type       | <b>xs:decimal</b>  |
| properties | isRef 0<br>minOcc 0<br>maxOcc 1<br>content simple                                  |
| annotation | documentation<br>Par value of a bond when it has been bought                       |

### element **PositionType/Bond/Price**

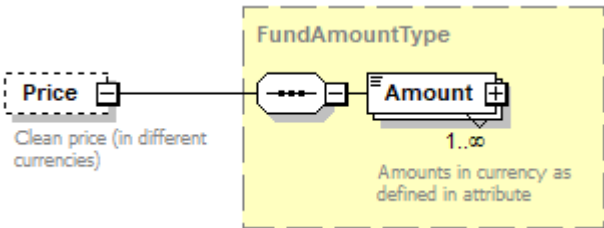
|            |   |
|------------|---|
| diagram    |  |
| type       | <a href="#">FundAmountType</a>  |
| properties | isRef 0<br>minOcc 0<br>maxOcc 1<br>content complex                                  |
| children   | <a href="#">Amount</a>  |
| annotation | documentation<br>Clean price (in different currencies)                              |

|  |  |
|--|--|
|  | documentation<br>Bewertungskurs (in verschiedenen Währungen) |
|--|--|

element **PositionType/Bond/OtherPrices**

|            |  |
|------------|--|
| diagram    |  |
| type       | <a href="#">OtherPricesType</a>                            |
| properties | isRef 0<br>minOcc 0<br>maxOcc 1<br>content complex         |
| children   | <a href="#">Price</a>                                      |
| annotation | documentation<br>Additional prices (e.g. hold to maturity) |

element **PositionType/Bond/DirtyPrice**

|            |  |
|------------|--|
| diagram    |  |
| type       | <a href="#">FundAmountType</a>                     |
| properties | isRef 0<br>minOcc 0<br>maxOcc 1<br>content complex |
| children   | <a href="#">Amount</a>                             |
| annotation | documentation<br>Dirty Price (including interests) |

element **PositionType/Bond/MarketValue**

|            |  |
|------------|--|
| diagram    |  |
| type       | <a href="#">FundAmountType</a>                                       |
| properties | isRef 0<br>minOcc 0<br>maxOcc 1<br>content complex                   |
| children   | <a href="#">Amount</a>   |
| annotation | documentation<br>Market value of security position without interests |

|            |  |
|------------|--|
| type       | <a href="#">FundAmountType</a>                                       |
| properties | isRef 0<br>minOcc 0<br>maxOcc 1<br>content complex                   |
| children   | <a href="#">Amount</a>   |
| annotation | documentation<br>Market value of security position without interests |

element **PositionType/Bond/InterestClaimNet**

|            |   |
|------------|---|
| diagram    |   |
| type       | <a href="#">FundAmountType</a>  |
| properties | isRef 0<br>minOcc 0<br>maxOcc 1<br>content complex  |
| children   | <a href="#">Amount</a>  |
| annotation | documentation<br>Interest claim net value<br>documentation<br>Netto-Zinsanspruch der Rentenposition |

element **PositionType/Bond/InterestClaimGross**

|            |  |
|------------|--|
| diagram    |  |
| type       | <a href="#">FundAmountType</a>   |
| properties | isRef 0<br>minOcc 0<br>maxOcc 1<br>content complex   |
| children   | <a href="#">Amount</a>   |
| annotation | documentation<br>Interest claim gross value<br>documentation<br>Brutto-Zinsanspruch der Rentenposition |

element **PositionType/Bond/AccruedInterestDays**

|            |  |
|------------|--|
| diagram    |  |
| type       | <b>xs:integer</b>  |
| properties | isRef 0<br>minOcc 0<br>maxOcc 1<br>content simple  |
| annotation | documentation<br>Number of accrued interest days<br>documentation<br>Anzahl der Stueckzins Tage an |

element **PositionType/Bond/ZeroBondInterestClaimNet**

|            |   |
|------------|---|
| diagram    |   |
| type       | <a href="#">FundAmountType</a>  |
| properties | isRef 0<br>minOcc 0<br>maxOcc 1<br>content complex  |
| children   | <a href="#">Amount</a>  |
| annotation | documentation<br>Interest claim net value of zero bond position<br>documentation<br>Netto-Zinsanspruch der Null-Coupon-Anleihenposition |

element **PositionType/Bond/ZeroBondInterestClaimGross**

|            |  |
|------------|--|
| diagram    |  |
| type       | <a href="#">FundAmountType</a>   |
| properties | isRef 0<br>minOcc 0<br>maxOcc 1<br>content complex                                 |
| children   | <a href="#">Amount</a>   |
| annotation | documentation<br>Interest claim gross value of zero bond position<br>documentation |



|  |                                     |
|--|-------------------------------------|
|  | Brutto Zinsanspruch des Zerobond an |
|--|-------------------------------------|

element **PositionType/Bond/ZeroBondCapitalYieldsTaxClaim**

|            |  |
|------------|--|
| diagram    |  |
| type       | <a href="#">FundAmountType</a>   |
| properties | isRef 0<br>minOcc 0<br>maxOcc 1<br>content complex   |
| children   | <a href="#">Amount</a>   |
| annotation | documentation<br>Capital yields tax claim of zero bond position<br>documentation<br>KEST-Anspruch der Null-Coupon-Anleihenposition |

element **PositionType/Bond/ZeroBondYield**

|            |   |
|------------|---|
| diagram    |   |
| type       | <b>xs:decimal</b>   |
| properties | isRef 0<br>minOcc 0<br>maxOcc 1<br>content simple   |
| annotation | documentation<br>Yield of zero bond (percentage)<br>documentation<br>Null-Coupon-Anleihenrendite (in Prozent) |

element **PositionType/Bond/Indexfactor**

|            |   |
|------------|---|
| diagram    |   |
| type       | <b>xs:decimal</b>   |
| properties | isRef 0<br>minOcc 0<br>maxOcc 1<br>content simple                                 |
| annotation | documentation<br>Index factor of bond<br>documentation<br>Indexfaktor der Anleihe |

element **PositionType/Bond/Poolfactor**

|            |   |
|------------|---|
| diagram    |              |
| type       | <b>xs:decimal</b>   |
| properties | isRef 0<br>minOcc 0<br>maxOcc 1<br>content simple   |
| annotation | documentation<br><b>Pool factor of bond</b><br>documentation<br><b>Poolfaktor der Anleihe</b> |

element **PositionType/Bond/BookRate**

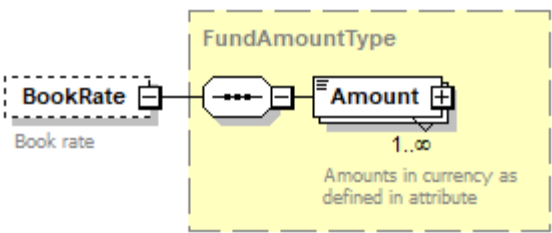
|            |   |
|------------|---|
| diagram    |  |
| type       | <a href="#">FundAmountType</a>  |
| properties | isRef 0<br>minOcc 0<br>maxOcc 1<br>content complex                                |
| children   | <a href="#">Amount</a>  |
| annotation | documentation<br><b>Book rate</b><br>documentation<br><b>Buchkurs</b>             |

element **PositionType/Bond/PurchaseValue**

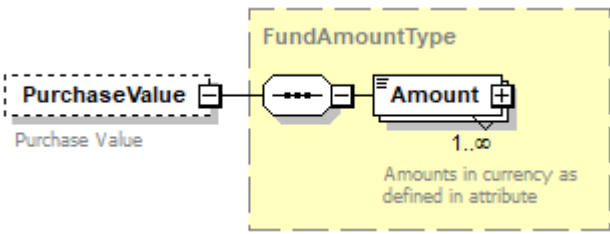
|            |   |
|------------|---|
| diagram    |  |
| type       | <a href="#">FundAmountType</a>  |
| properties | isRef 0<br>minOcc 0<br>maxOcc 1<br>content complex                                  |
| children   | <a href="#">Amount</a>  |
| annotation | documentation<br><b>Purchase Value</b><br>documentation<br><b>Einstandswert</b>     |

element **PositionType/Bond/AcruallIndexedBond**

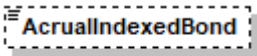
|            |  |
|------------|--|
| diagram    |  <p>Indicates whether it is an acruall indexed bond</p> |
| type       | <b>xs:boolean</b>  |
| properties | isRef 0<br>minOcc 0<br>maxOcc 1<br>content simple  |
| annotation | documentation<br>Indicates whether it is an acruall indexed bond<br>documentation<br>Gibt an ob die Abgrenzung der Indexanleihe erfolgt  |

element **PositionType/Bond/DateLastCouponPayment**

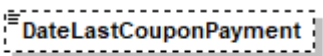
|            |  |
|------------|--|
| diagram    |  <p>Date when last coupon will be payed</p> |
| type       | <b>xs:date</b>   |
| properties | isRef 0<br>minOcc 0<br>maxOcc 1<br>content simple  |
| annotation | documentation<br>Date when last coupon will be payed<br>documentation<br>Datum an dem der letzte Kupon gezahlt wird          |

element **PositionType/Bond/LendedFlag**

|            |   |
|------------|---|
| diagram    |  <p>Indicates whether (part of) position is lended</p> |
| type       | <b>xs:boolean</b>   |
| properties | isRef 0<br>minOcc 0<br>maxOcc 1<br>content simple   |
| annotation | documentation<br>Indicates whether (part of) position is lended<br>documentation<br>Gibt an, ob Bestand (teilweise) verliehen ist         |

element **PositionType/Bond/LendedUnits**

|         |   |
|---------|---|
| diagram |  <p>Number of lended units</p> |
|---------|---|

|            |  |
|------------|--|
| type       | <b>xs:decimal</b>  |
| properties | isRef 0<br>minOcc 0<br>maxOcc 1<br>content simple                                      |
| annotation | documentation<br><b>Number of lendend units</b><br>documentation<br>Verleihende Stücke |

element **PositionType/Bond/IndicatorRaffled**

|            |   |
|------------|---|
| diagram    |                                      |
| type       | <b>xs:boolean</b>   |
| properties | isRef 0<br>minOcc 0<br>maxOcc 1<br>content simple   |
| annotation | documentation<br>Indicates whether bond has been raffled<br>documentation<br>Gibt an, ob das Wertpapier verlost wurde |

element **PositionType/Bond/CollateralValue**

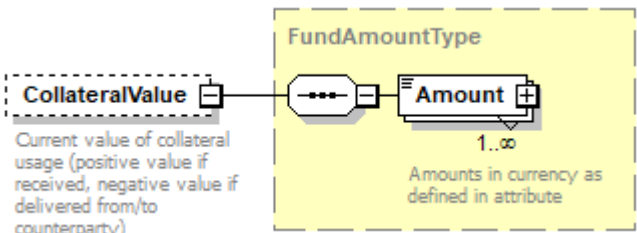
|            |   |
|------------|---|
| diagram    |    |
| type       | <a href="#">FundAmountType</a>  |
| properties | isRef 0<br>minOcc 0<br>maxOcc 1<br>content complex  |
| children   | <a href="#">Amount</a>  |
| annotation | documentation<br>Current value of collateral usage (positive value if received, negative value if delivered from/to counterparty) |

element **PositionType/ShareClass**

|                   |   |
|-------------------|---|
| <p>diagram</p>    | <p><b>ShareClass</b><br/>Details for subfund positions</p> <p><b>Shares</b><br/>Number of shares</p> <p><b>Price</b><br/>Clean price (in different currencies)</p> <p><b>OtherPrices</b><br/>Additional prices (e.g. hold to maturity)</p> <p><b>BookRate</b><br/>Book rate</p> <p><b>PurchaseValue</b><br/>Purchase Value</p> <p><b>DividendsDue</b><br/>Dividends due of position</p> <p><b>LendedFlag</b><br/>Indicates whether (part of) position is lended</p> <p><b>LendedUnits</b><br/>Number of lended units</p> <p><b>IndicatorRaffled</b><br/>Indicates whether bond has been raffled</p> |
| <p>properties</p> | <p>isRef 0<br/>content complex</p>  |
| <p>children</p>   | <p><a href="#">Shares</a> <a href="#">Price</a> <a href="#">OtherPrices</a> <a href="#">BookRate</a> <a href="#">PurchaseValue</a> <a href="#">DividendsDue</a> <a href="#">LendedFlag</a> <a href="#">LendedUnits</a> <a href="#">IndicatorRaffled</a></p>   |
| <p>annotation</p> | <p>documentation<br/>Details for subfund positions</p>  |

element **PositionType/ShareClass/Shares**

|                   |  |
|-------------------|--|
| <p>diagram</p>    | <p><b>Shares</b><br/>Number of shares</p>  |
| <p>type</p>       | <p><b>xs:decimal</b></p>   |
| <p>properties</p> | <p>isRef 0<br/>content simple</p>  |
| <p>annotation</p> | <p>documentation<br/>Number of shares<br/>documentation<br/>Anzahl der Anteilscheine</p> |

element **PositionType/ShareClass/Price**

|            |  |
|------------|--|
| diagram    | <p>The diagram shows a dashed box labeled 'FundAmountType' containing an 'Amount' element with a multiplicity of 1..∞ and the text 'Amounts in currency as defined in attribute'. To the left, a 'Price' element is shown with the text 'Clean price (in different currencies)'. A line connects the 'Price' element to the 'Amount' element, indicating a relationship.</p> |
| type       | <a href="#">FundAmountType</a>   |
| properties | <ul style="list-style-type: none"> <li>isRef 0</li> <li>minOcc 0</li> <li>maxOcc 1</li> <li>content complex</li> </ul>   |
| children   | <a href="#">Amount</a>   |
| annotation | <ul style="list-style-type: none"> <li>documentation Clean price (in different currencies)</li> <li>documentation Bewertungskurs (in verschiedenen Währungen)</li> </ul>   |

element **PositionType/ShareClass/OtherPrices**

|            |   |
|------------|---|
| diagram    | <p>The diagram shows a dashed box labeled 'OtherPricesType' containing a 'Price' element with a multiplicity of 1..∞ and the text 'Inform on the price type (different from the official NAV) used for other price communication'. To the left, an 'OtherPrices' element is shown with the text 'Additional prices (e.g. hold to maturity)'. A line connects the 'OtherPrices' element to the 'Price' element, indicating a relationship.</p> |
| type       | <a href="#">OtherPricesType</a>   |
| properties | <ul style="list-style-type: none"> <li>isRef 0</li> <li>minOcc 0</li> <li>maxOcc 1</li> <li>content complex</li> </ul>  |
| children   | <a href="#">Price</a>   |
| annotation | <ul style="list-style-type: none"> <li>documentation Additional prices (e.g. hold to maturity)</li> </ul>   |

element **PositionType/ShareClass/BookRate**

|            |  |
|------------|--|
| diagram    | <p>The diagram shows a dashed box labeled 'FundAmountType' containing an 'Amount' element with a multiplicity of 1..∞ and the text 'Amounts in currency as defined in attribute'. To the left, a 'BookRate' element is shown with the text 'Book rate'. A line connects the 'BookRate' element to the 'Amount' element, indicating a relationship.</p> |
| type       | <a href="#">FundAmountType</a>   |
| properties | <ul style="list-style-type: none"> <li>isRef 0</li> <li>minOcc 0</li> </ul>  |

|            |   |
|------------|---|
|            | maxOcc 1<br>content complex   |
| children   | <a href="#">Amount</a>  |
| annotation | documentation<br><b>Book rate</b><br>documentation<br><b>Buchkurs</b> |

element **PositionType/ShareClass/PurchaseValue**

|            |   |
|------------|---|
| diagram    |   |
| type       | <a href="#">FundAmountType</a>  |
| properties | isRef 0<br>minOcc 0<br>maxOcc 1<br>content complex                              |
| children   | <a href="#">Amount</a>  |
| annotation | documentation<br><b>Purchase Value</b><br>documentation<br><b>Einstandswert</b> |

element **PositionType/ShareClass/DividendsDue**

|            |   |
|------------|---|
| diagram    |   |
| type       | <a href="#">FundAmountType</a>  |
| properties | isRef 0<br>minOcc 0<br>maxOcc 1<br>content complex  |
| children   | <a href="#">Amount</a>  |
| annotation | documentation<br><b>Dividends due of position</b><br>documentation<br><b>Dividendenforderungen fuer Aktienbestaende</b> |

element **PositionType/ShareClass/LendedFlag**

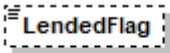
|            |   |
|------------|---|
| diagram    |  <p>Indicates whether (part of) position is lended</p> |
| type       | <b>xs:boolean</b>   |
| properties | isRef 0<br>minOcc 0<br>maxOcc 1<br>content simple   |
| annotation | documentation<br>Indicates whether (part of) position is lended<br>documentation<br>Gibt an, ob Bestand (teilweise) verliehen ist       |

element **PositionType/ShareClass/LendedUnits**

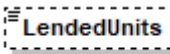
|            |   |
|------------|---|
| diagram    |  <p>Number of lended units</p> |
| type       | <b>xs:decimal</b>   |
| properties | isRef 0<br>minOcc 0<br>maxOcc 1<br>content simple   |
| annotation | documentation<br>Number of lended units<br>documentation<br>Verleihende Stücke                                  |

element **PositionType/ShareClass/IndicatorRaffled**

|            |  |
|------------|--|
| diagram    |  <p>Indicates whether bond has been raffled</p> |
| type       | <b>xs:boolean</b>  |
| properties | isRef 0<br>minOcc 0<br>maxOcc 1<br>content simple  |
| annotation | documentation<br>Indicates whether bond has been raffled<br>documentation<br>Gibt an, ob das Wertpapier verlost wurde              |



element **PositionType/Warrant**

|            |  |
|------------|--|
| diagram    |  |
| properties | isRef 0<br>content complex   |
| children   | <a href="#">Units</a> <a href="#">Price</a> <a href="#">OtherPrices</a> <a href="#">BookRate</a> <a href="#">PurchaseValue</a> |
| annotation | documentation<br>Details for warrant positions   |

element **PositionType/Warrant/Units**

|            |  |
|------------|--|
| diagram    |  |
| type       | <b>xs:decimal</b>  |
| properties | isRef 0<br>content simple  |
| annotation | documentation<br>Units of warrant<br>documentation<br>Stücke des Optionsscheines |

element **PositionType/Warrant/Price**

|            |  |
|------------|--|
| diagram    |  |
| type       | <a href="#">FundAmountType</a>                     |
| properties | isRef 0<br>minOcc 0<br>maxOcc 1<br>content complex |
| children   | <a href="#">Amount</a>                             |

|            |  |
|------------|--|
| annotation | documentation<br>Price (in different currencies)<br>documentation<br>Bewertungskurs (in verschiedenen Währungen) |
|------------|--|

element **PositionType/Warrant/OtherPrices**

|            |  |
|------------|--|
| diagram    |  |
| type       | <a href="#">OtherPricesType</a>                            |
| properties | isRef 0<br>minOcc 0<br>maxOcc 1<br>content complex         |
| children   | <a href="#">Price</a>                                      |
| annotation | documentation<br>Additional prices (e.g. hold to maturity) |

element **PositionType/Warrant/BookRate**

|            |   |
|------------|---|
| diagram    |   |
| type       | <a href="#">FundAmountType</a>                          |
| properties | isRef 0<br>minOcc 0<br>maxOcc 1<br>content complex      |
| children   | <a href="#">Amount</a>                                  |
| annotation | documentation<br>Book rate<br>documentation<br>Buchkurs |

element **PositionType/Warrant/PurchaseValue**

|            |   |
|------------|---|
| diagram    |   |
| type       | <a href="#">FundAmountType</a>                                    |
| properties | isRef 0<br>minOcc 0<br>maxOcc 1<br>content complex                |
| children   | <a href="#">Amount</a>  |
| annotation | documentation<br>Purchase Value<br>documentation<br>Einstandswert |

element **PositionType/Certificate**

|            |  |
|------------|--|
| diagram    |  |
| properties | isRef 0<br>content complex   |
| children   | <a href="#">Units</a> <a href="#">LendedFlag</a> <a href="#">LendedUnits</a> <a href="#">Price</a> |
| annotation | documentation<br>Details for certificate   |

element **PositionType/Certificate/Units**

|            |   |
|------------|---|
| diagram    |   |
| type       | <b>xs:decimal</b>   |
| properties | isRef 0<br>content simple   |
| annotation | documentation<br>Units of certificate<br>documentation<br>Stücke der Aktie im Bestand |

element **PositionType/Certificate/LendedFlag**

|            |   |
|------------|---|
| diagram    |    |
| type       | <b>xs:boolean</b>   |
| properties | isRef 0<br>minOcc 0<br>maxOcc 1<br>content simple   |
| annotation | documentation<br>Indicates whether (part of) position is lended<br>documentation<br>Gibt an, ob Bestand (teilweise) verliehen ist |

element **PositionType/Certificate/LendedUnits**

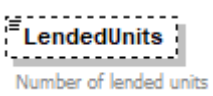
|            |   |
|------------|---|
| diagram    |  |
| type       | <b>xs:decimal</b>   |
| properties | isRef 0<br>minOcc 0<br>maxOcc 1<br>content simple                                 |
| annotation | documentation<br>Number of lended units<br>documentation<br>Verleihende Stücke    |

element **PositionType/Certificate/Price**

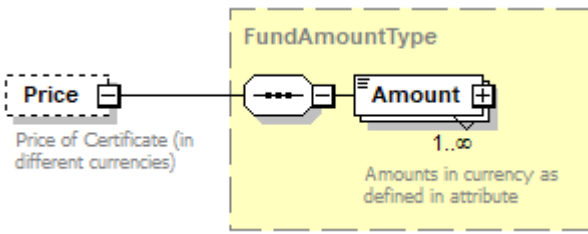
|            |   |
|------------|---|
| diagram    |    |
| type       | <a href="#">FundAmountType</a>  |
| properties | isRef 0<br>minOcc 0<br>maxOcc 1<br>content complex  |
| children   | <a href="#">Amount</a>  |
| annotation | documentation<br>Price of Certificate (in different currencies)<br>documentation<br>Preis des Zertifikates (in verschiedenen Währungen) |

element **PositionType/Option**

|            |   |
|------------|---|
| diagram    |   |
| properties | isRef 0<br>content complex  |
| children   | <a href="#">Contracts</a> <a href="#">Price</a> <a href="#">OtherPrices</a> <a href="#">BookRate</a> <a href="#">PurchaseValue</a> <a href="#">HedgeRatio</a> |
| annotation | documentation<br>Details for option positions   |

element **PositionType/Option/Contracts**

|            |  |
|------------|--|
| diagram    |  |
| type       | <b>xs:decimal</b>                                      |
| properties | isRef 0<br>content simple                              |
| annotation | documentation<br>Number of contracts (may be negative) |

element **PositionType/Option/Price**

|            |                                 |
|------------|---------------------------------|
| diagram    |                                 |
| type       | <a href="#">FundAmountType</a>  |
| properties | isRef 0<br>minOcc 0<br>maxOcc 1 |

|            |  |
|------------|--|
|            | content complex  |
| children   | <a href="#">Amount</a>   |
| annotation | documentation<br>Price (in different currencies)<br>documentation<br>Bewertungskurs (in verschiedenen Währungen) |

element **PositionType/Option/OtherPrices**

|            |  |
|------------|--|
| diagram    |  |
| type       | <a href="#">OtherPricesType</a>                            |
| properties | isRef 0<br>minOcc 0<br>maxOcc 1<br>content complex         |
| children   | <a href="#">Price</a>                                      |
| annotation | documentation<br>Additional prices (e.g. hold to maturity) |

element **PositionType/Option/BookRate**

|            |   |
|------------|---|
| diagram    |   |
| type       | <a href="#">FundAmountType</a>                          |
| properties | isRef 0<br>minOcc 0<br>maxOcc 1<br>content complex      |
| children   | <a href="#">Amount</a>                                  |
| annotation | documentation<br>Book rate<br>documentation<br>Buchkurs |

element **PositionType/Option/PurchaseValue**

|            |   |
|------------|---|
| diagram    |   |
| type       | <a href="#">FundAmountType</a>                                    |
| properties | isRef 0<br>minOcc 0<br>maxOcc 1<br>content complex                |
| children   | <a href="#">Amount</a>  |
| annotation | documentation<br>Purchase Value<br>documentation<br>Einstandswert |

element **PositionType/Option/HedgeRatio**

|            |  |
|------------|--|
| diagram    |  |
| type       | <a href="#">PercentageType</a>   |
| properties | isRef 0<br>minOcc 0<br>maxOcc 1<br>content simple  |
| annotation | documentation<br>Hedging ratio (percentage)<br>documentation<br>Anteil der Position zur Absicherung in Prozent |

element **PositionType/Future**

|                   |  |
|-------------------|--|
| <p>diagram</p>    | <p><b>Future</b><br/>Details for future positions</p> <ul style="list-style-type: none"> <li><b>Contracts</b><br/>Number of contracts (may be negative)</li> <li><b>Price</b><br/>Price (in different currencies)</li> <li><b>OtherPrices</b><br/>Additional prices (e.g. hold to maturity)</li> <li><b>PrelProfitLoss</b><br/>Preliminary Profit/Loss (current valuation of future position)</li> <li><b>BookRate</b><br/>Book rate</li> <li><b>VariationMarginDaily</b><br/>Daily variation margin</li> <li><b>VariationMarginOverall</b><br/>Overall value of variation margin</li> <li><b>HedgeRatio</b><br/>Hedging ratio (percentage)</li> </ul> |
| <p>properties</p> | <p>isRef 0<br/>content complex</p>   |
| <p>children</p>   | <p><a href="#">Contracts</a> <a href="#">Price</a> <a href="#">OtherPrices</a> <a href="#">PrelProfitLoss</a> <a href="#">BookRate</a> <a href="#">VariationMarginDaily</a> <a href="#">VariationMarginOverall</a> <a href="#">HedgeRatio</a></p>  |
| <p>annotation</p> | <p>documentation<br/>Details for future positions</p>  |

element **PositionType/Future/Contracts**

|                   |   |
|-------------------|---|
| <p>diagram</p>    | <p><b>Contracts</b><br/>Number of contracts (may be negative)</p>   |
| <p>type</p>       | <p><b>xs:decimal</b></p>  |
| <p>properties</p> | <p>isRef 0<br/>content simple</p>   |
| <p>annotation</p> | <p>documentation<br/>Number of contracts (may be negative)<br/>documentation<br/>Anzahl der Kontrakte (kann negativ sein)</p> |



element **PositionType/Future/Price**

|            |  |
|------------|--|
| diagram    |  |
| type       | <a href="#">FundAmountType</a>   |
| properties | isRef 0<br>minOcc 0<br>maxOcc 1<br>content complex   |
| children   | <a href="#">Amount</a>   |
| annotation | documentation<br>Price (in different currencies)<br>documentation<br>Bewertungskurs (in verschiedenen Währungen) |

element **PositionType/Future/OtherPrices**

|            |  |
|------------|--|
| diagram    |  |
| type       | <a href="#">OtherPricesType</a>                            |
| properties | isRef 0<br>minOcc 0<br>maxOcc 1<br>content complex         |
| children   | <a href="#">Price</a>                                      |
| annotation | documentation<br>Additional prices (e.g. hold to maturity) |

element **PositionType/Future/PrelProfitLoss**

|            |                                |
|------------|--------------------------------|
| diagram    |                                |
| type       | <a href="#">FundAmountType</a> |
| properties | isRef 0<br>minOcc 0            |

|            |   |
|------------|---|
|            | maxOcc 1<br>content complex   |
| children   | <a href="#">Amount</a>  |
| annotation | documentation<br>Preliminary Profit/Loss (current valuation of future position)<br>documentation<br>Vorläufiger Gewinn/Verlust (aktuelle Bewertung der Future-Position) |

element **PositionType/Future/BookRate**

|            |   |
|------------|---|
| diagram    |   |
| type       | <a href="#">FundAmountType</a>                          |
| properties | isRef 0<br>minOcc 0<br>maxOcc 1<br>content complex      |
| children   | <a href="#">Amount</a>                                  |
| annotation | documentation<br>Book rate<br>documentation<br>Buchkurs |

element **PositionType/Future/VariationMarginDaily**

|            |   |
|------------|---|
| diagram    |   |
| type       | <a href="#">FundAmountType</a>  |
| properties | isRef 0<br>minOcc 0<br>maxOcc 1<br>content complex  |
| children   | <a href="#">Amount</a>  |
| annotation | documentation<br>Daily variation margin<br>documentation<br>Zeigt taeglich den Wert der Variation Margin an |

element **PositionType/Future/VariationMarginOverall**

|            |   |
|------------|---|
| diagram    | <p>The diagram shows a dashed box containing the element <b>VariationMarginOverall</b> with the description "Overall value of variation margin". This is connected to a solid box labeled <b>FundAmountType</b> which contains the element <b>Amount</b> with the cardinality "1..∞" and the description "Amounts in currency as defined in attribute".</p> |
| type       | <a href="#">FundAmountType</a>  |
| properties | <ul style="list-style-type: none"> <li>isRef 0</li> <li>minOcc 0</li> <li>maxOcc 1</li> <li>content complex</li> </ul>  |
| children   | <a href="#">Amount</a>  |
| annotation | <ul style="list-style-type: none"> <li>documentation Overall value of variation margin</li> <li>documentation Zeigt den Wert der Variation Margin an</li> </ul>   |

element **PositionType/Future/HedgeRatio**

|            |  |
|------------|--|
| diagram    | <p>The diagram shows a dashed box containing the element <b>HedgeRatio</b> with the description "Hedging ratio (percentage)".</p>                                |
| type       | <a href="#">PercentageType</a>   |
| properties | <ul style="list-style-type: none"> <li>isRef 0</li> <li>minOcc 0</li> <li>maxOcc 1</li> <li>content simple</li> </ul>  |
| annotation | <ul style="list-style-type: none"> <li>documentation Hedging ratio (percentage)</li> <li>documentation Anteil der Position zur Absicherung in Prozent</li> </ul> |

element **PositionType/FXForward**

|            |   |
|------------|---|
| diagram    | <p>The diagram shows a solid box labeled <b>FXForward</b> with the description "Details for FXForward positions". This is connected to a dashed box containing two elements: <b>HedgeRatio</b> (Hedging ratio (percentage)) and <b>FxRateForEvaluation</b> (FX-Rate used for evaluation).</p> |
| properties | <ul style="list-style-type: none"> <li>isRef 0</li> <li>content complex</li> </ul>  |
| children   | <a href="#">HedgeRatio</a> <a href="#">FxRateForEvaluation</a>  |
| annotation | <ul style="list-style-type: none"> <li>documentation Details for FXForward positions</li> </ul>   |

element **PositionType/FXForward/HedgeRatio**

|            |  |
|------------|--|
| diagram    |                               |
| type       | <a href="#">PercentageType</a>   |
| properties | isRef 0<br>minOcc 0<br>maxOcc 1<br>content simple  |
| annotation | documentation<br>Hedging ratio (percentage)<br>documentation<br>Anteil der Position zur Absicherung in Prozent |

element **PositionType/FXForward/FxRateForEvaluation**

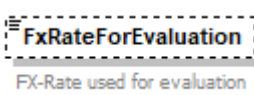
|            |   |
|------------|---|
| diagram    |  |
| type       | <b>xs:decimal</b>   |
| properties | isRef 0<br>minOcc 0<br>maxOcc 1<br>content simple                                 |
| annotation | documentation<br>FX-Rate used for evaluation                                      |

element **PositionType/Swap**

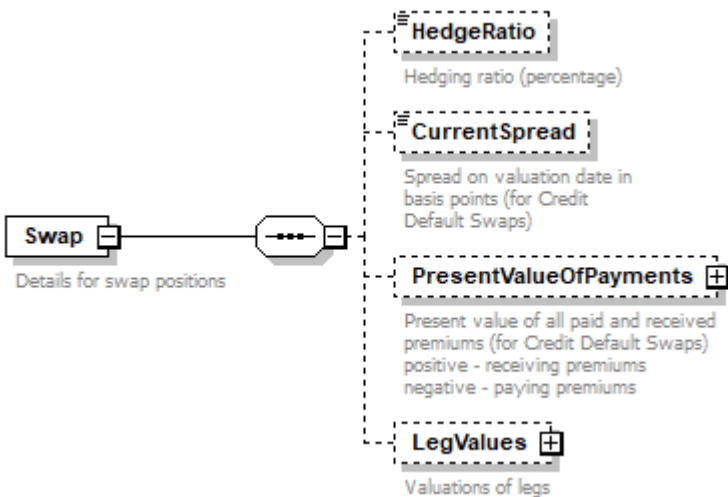
|            |   |
|------------|---|
| diagram    |                                       |
| properties | isRef 0<br>content complex  |
| children   | <a href="#">HedgeRatio</a> <a href="#">CurrentSpread</a> <a href="#">PresentValueOfPayments</a> <a href="#">LegValues</a> |
| annotation | documentation<br>Details for swap positions   |

element **PositionType/Swap/HedgeRatio**

|            |  |
|------------|--|
| diagram    |  |
| type       | <a href="#">PercentageType</a>   |
| properties | isRef 0<br>minOcc 0<br>maxOcc 1<br>content simple  |
| annotation | documentation<br>Hedging ratio (percentage)<br>documentation<br>Anteil der Position zur Absicherung in Prozent |

element **PositionType/Swap/CurrentSpread**

|            |  |
|------------|--|
| diagram    |  |
| type       | <b>xs:decimal</b>  |
| properties | isRef 0<br>minOcc 0<br>maxOcc 1<br>content simple                                    |
| annotation | documentation<br>Spread on valuation date in basis points (for Credit Default Swaps) |

element **PositionType/Swap/PresentValueOfPayments**

|            |  |
|------------|--|
| diagram    |  |
| type       | <a href="#">FundAmountType</a>   |
| properties | isRef 0<br>minOcc 0<br>maxOcc 1<br>content complex   |
| children   | <a href="#">Amount</a>   |
| annotation | documentation<br>Present value of all paid and received premiums (for Credit Default Swaps)<br>positive - receiving premiums<br>negative - paying premiums |

element **PositionType/Swap/LegValues**

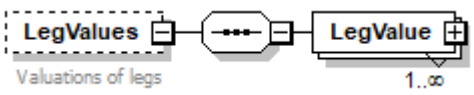
|            |   |
|------------|---|
| diagram    |  <p>The diagram shows a dashed box labeled 'LegValues' containing a sequence of elements: a 'LegValues' box with a minus sign, a sequence container (hexagon with three dots), and a 'LegValue' box with a plus sign. Below the dashed box is the text 'Valuations of legs'. Below the 'LegValue' box is the cardinality '1..∞'.</p> |
| properties | <p>isRef 0<br/> minOcc 0<br/> maxOcc 1<br/> content complex</p>   |
| children   | <a href="#">LegValue</a>  |
| annotation | <p>documentation<br/> Valuations of legs</p>  |

element **PositionType/Swap/LegValues/LegValue**

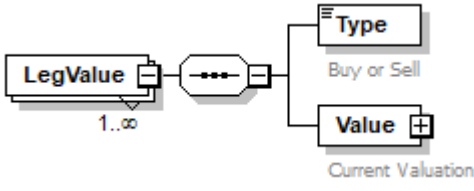
|            |   |
|------------|---|
| diagram    |  <p>The diagram shows a 'LegValue' box with a plus sign and cardinality '1..∞' connected to a sequence container (hexagon with three dots). This container is connected to two child elements: a 'Type' box with a plus sign and text 'Buy or Sell', and a 'Value' box with a plus sign and text 'Current Valuation of Leg'.</p> |
| properties | <p>isRef 0<br/> minOcc 1<br/> maxOcc unbounded<br/> content complex</p>   |
| children   | <a href="#">Type</a> <a href="#">Value</a>  |

element **PositionType/Swap/LegValues/LegValue/Type**

|            |  |
|------------|--|
| diagram    |  <p>The diagram shows a 'Type' box with a plus sign and text 'Buy or Sell'.</p> |
| type       | restriction of <code>xs:string</code>  |
| properties | <p>isRef 0<br/> content simple</p>   |
| annotation | <p>documentation<br/> Buy or Sell</p>  |

element **PositionType/Swap/LegValues/LegValue/Value**

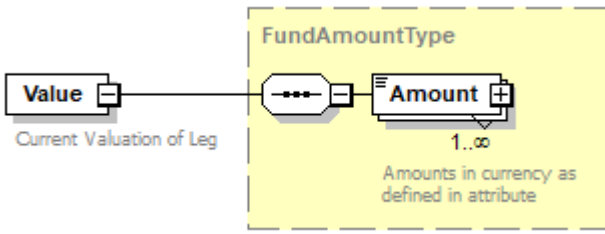
|            |  |
|------------|--|
| diagram    |  <p>The diagram shows a 'Value' box with a plus sign and text 'Current Valuation of Leg' connected to a sequence container (hexagon with three dots). This container is connected to an 'Amount' box with a plus sign and cardinality '1..∞'. The 'Amount' box is highlighted in a yellow dashed box labeled 'FundAmountType' with the text 'Amounts in currency as defined in attribute' below it.</p> |
| type       | <a href="#">FundAmountType</a>   |
| properties | <p>isRef 0<br/> content complex</p>  |
| children   | <a href="#">Amount</a>   |

|            |   |
|------------|---|
| annotation | documentation<br>Current Valuation of Leg |
|------------|---|

### element PositionType/Repo

|            |  |
|------------|--|
| diagram    |  |
| type       | restriction of <b>xs:string</b>            |
| properties | isRef 0<br>content simple                  |
| facets     | Kind Value annotation<br>maxLength 0       |
| annotation | documentation<br>Details for repos (empty) |

### element PositionType/FixedTimeDeposit

|            |   |
|------------|---|
| diagram    |   |
| properties | isRef 0<br>content complex                            |
| children   | <a href="#">MarketValue</a> <a href="#">Interests</a> |
| annotation | documentation<br>Details for fixed time deposits      |

### element PositionType/FixedTimeDeposit/MarketValue

|            |   |
|------------|---|
| diagram    |   |
| type       | <a href="#">FundAmountType</a>                                |
| properties | isRef 0<br>minOcc 0<br>maxOcc 1<br>content complex            |
| children   | <a href="#">Amount</a>  |
| annotation | documentation<br>Market value of position (without interests) |

element **PositionType/FixedTimeDeposit/Interests**

|            |  |
|------------|--|
| diagram    | <p>The diagram shows an <b>Interests</b> element (Value of interests) connected to a <b>FundAmountType</b> container. Inside the container is an <b>Amount</b> element (Amounts in currency as defined in attribute) with a cardinality of 1..∞.</p> |
| type       | <a href="#">FundAmountType</a>   |
| properties | <ul style="list-style-type: none"> <li>isRef 0</li> <li>minOcc 0</li> <li>maxOcc 1</li> <li>content complex</li> </ul>   |
| children   | <a href="#">Amount</a>   |
| annotation | documentation<br>Value of interests  |

element **PositionType/CallMoney**

|            |   |
|------------|---|
| diagram    | <p>The diagram shows a <b>CallMoney</b> element (Details for call money positions) connected to a container. The container includes three elements: <b>MarketValue</b> (Market value of position (without interests)), <b>Interests</b> (Value of interests), and <b>CollateralValue</b> (Current value of collateral position paid (negative value) or received from counterparty (positive value)).</p> |
| properties | <ul style="list-style-type: none"> <li>isRef 0</li> <li>content complex</li> </ul>  |
| children   | <a href="#">MarketValue</a> <a href="#">Interests</a> <a href="#">CollateralValue</a>   |
| annotation | documentation<br>Details for call money positions   |

element **PositionType/CallMoney/MarketValue**

|            |   |
|------------|---|
| diagram    | <p>The diagram shows a <b>MarketValue</b> element (Market value of position (without interests)) connected to a <b>FundAmountType</b> container. Inside the container is an <b>Amount</b> element (Amounts in currency as defined in attribute) with a cardinality of 1..∞.</p> |
| type       | <a href="#">FundAmountType</a>  |
| properties | <ul style="list-style-type: none"> <li>isRef 0</li> <li>minOcc 0</li> <li>maxOcc 1</li> <li>content complex</li> </ul>  |



|            |   |
|------------|---|
| children   | <a href="#">Amount</a>  |
| annotation | documentation<br>Market value of position (without interests) |

### element **PositionType/CallMoney/Interests**

|            |  |
|------------|--|
| diagram    |  |
| type       | <a href="#">FundAmountType</a>                     |
| properties | isRef 0<br>minOcc 0<br>maxOcc 1<br>content complex |
| children   | <a href="#">Amount</a>                             |
| annotation | documentation<br>Value of interests                |

### element **PositionType/CallMoney/CollateralValue**

|            |  |
|------------|--|
| diagram    |  |
| type       | <a href="#">FundAmountType</a>   |
| properties | isRef 0<br>minOcc 0<br>maxOcc 1<br>content complex   |
| children   | <a href="#">Amount</a>   |
| annotation | documentation<br>Current value of collateral position paid (negative value) or received from counterparty (positive value) |

### element **PositionType/Account**

|            |                            |
|------------|----------------------------|
| diagram    |                            |
| properties | isRef 0<br>content complex |

|            |  |
|------------|--|
| children   | <a href="#">MarketValue Interests</a>          |
| annotation | documentation<br>Details for account positions |

element **PositionType/Account/MarketValue**

|            |   |
|------------|---|
| diagram    | <p>The diagram shows a dashed box labeled <b>MarketValue</b> with the text "Market value of position (without interests)" below it. A line connects this box to a yellow box labeled <b>FundAmountType</b>. Inside the yellow box, there is a sequence of elements: a dashed box containing three dots, followed by a box labeled <b>Amount</b> with a multiplicity of <b>1..∞</b> and the text "Amounts in currency as defined in attribute" below it.</p> |
| type       | <a href="#">FundAmountType</a>  |
| properties | isRef 0<br>minOcc 0<br>maxOcc 1<br>content complex  |
| children   | <a href="#">Amount</a>  |
| annotation | documentation<br>Market value of position (without interests)   |

element **PositionType/Account/Interests**

|            |   |
|------------|---|
| diagram    | <p>The diagram shows a dashed box labeled <b>Interests</b> with the text "Value of interests" below it. A line connects this box to a yellow box labeled <b>FundAmountType</b>. Inside the yellow box, there is a sequence of elements: a dashed box containing three dots, followed by a box labeled <b>Amount</b> with a multiplicity of <b>1..∞</b> and the text "Amounts in currency as defined in attribute" below it.</p> |
| type       | <a href="#">FundAmountType</a>  |
| properties | isRef 0<br>minOcc 0<br>maxOcc 1<br>content complex  |
| children   | <a href="#">Amount</a>  |
| annotation | documentation<br>Value of interests   |

element **PositionType/Fee**

|            |  |
|------------|--|
| diagram    | <p>The diagram shows a box labeled <b>Fee</b> with the text "Details for fees (empty)" below it.</p> |
| type       | restriction of <b>xs:string</b>  |
| properties | isRef 0<br>content simple  |
| facets     | Kind Value annotation<br>maxLength 0   |

|            |   |
|------------|---|
| annotation | documentation<br>Details for fees (empty) |
|------------|---|

element **PositionType/RealEstate**

diagram



- MarketValue**   
Market value of position
- RentIncome**   
Rent income
- RentAccruals**   
Rent accruals
- MaintenanceReserve**   
Maintenance reserve (20%) for the real estate asset
- MaintenanceProvision**   
Maintenance provision for the real estate asset
- AncillaryCosts**   
Ancillary costs of the real estate asset
- RentDeposit**   
Rent deposit for the real estate asset
- RentReceivables**   
Outstanding rent receivables
- TaxLiabilities**   
Consolidated tax liabilities for the real estate asset
- VacancyCosts**   
Vacancy costs of the real estate asset
- PlannedMaintenanceCosts**   
Yearly planned costs of maintenance
- OtherIncome**   
Other income of the real estate asset; e.g. building lease charges etc.
- OtherAssets**   
Other assets corresponding to the real estate asset
- OtherLiabilities**   
Other liabilities corresponding to the real estate asset
- OtherNonFinancialAssetValue**   
Current market value of other non financial assets corresponding to the real estate asset

|            |   |
|------------|---|
| properties | isRef 0<br>content complex  |
| children   | <a href="#">MarketValue</a> <a href="#">RentIncome</a> <a href="#">RentAccruals</a> <a href="#">MaintenanceReserve</a> <a href="#">MaintenanceProvision</a> <a href="#">AncillaryCosts</a> <a href="#">RentDeposit</a> <a href="#">RentReceivables</a> <a href="#">TaxLiabilities</a> <a href="#">VacancyCosts</a> <a href="#">PlannedMaintenanceCosts</a> <a href="#">OtherIncome</a> <a href="#">OtherAssets</a> <a href="#">OtherLiabilities</a> <a href="#">OtherNonFinancialAssetValue</a> |
| annotation | documentation<br>Details for real estate positions  |

element **PositionType/RealEstate/MarketValue**

|            |  |
|------------|--|
| diagram    |  |
| type       | <a href="#">FundAmountType</a>   |
| properties | isRef 0<br>minOcc 0<br>maxOcc 1<br>content complex                                   |
| children   | <a href="#">Amount</a>   |
| annotation | documentation<br>Market value of position<br>documentation<br>Aktueller Verkehrswert |

element **PositionType/RealEstate/RentIncome**

|            |   |
|------------|---|
| diagram    |   |
| type       | <a href="#">FundAmountType</a>  |
| properties | isRef 0<br>minOcc 0<br>maxOcc 1<br>content complex                                  |
| children   | <a href="#">Amount</a>  |
| annotation | documentation<br>Rent income<br>documentation<br>Miete (80%) inkl. Abschlagszahlung |

element **PositionType/RealEstate/RentAccruals**

|            |  |
|------------|--|
| diagram    |  |
| type       | <a href="#">FundAmountType</a>   |
| properties | <ul style="list-style-type: none"> <li>isRef 0</li> <li>minOcc 0</li> <li>maxOcc 1</li> <li>content complex</li> </ul>                         |
| children   | <a href="#">Amount</a>   |
| annotation | <ul style="list-style-type: none"> <li>documentation</li> <li>Rent accruals</li> <li>documentation</li> <li>Aktuelle Mietabgrenzung</li> </ul> |

element **PositionType/RealEstate/MaintenanceReserve**

|            |  |
|------------|--|
| diagram    |  |
| type       | <a href="#">FundAmountType</a>   |
| properties | <ul style="list-style-type: none"> <li>isRef 0</li> <li>minOcc 0</li> <li>maxOcc 1</li> <li>content complex</li> </ul>   |
| children   | <a href="#">Amount</a>   |
| annotation | <ul style="list-style-type: none"> <li>documentation</li> <li>Maintenance reserve (20%) for the real estate asset</li> <li>documentation</li> <li>Instandhaltungsrücklage (20%)</li> </ul> |

element **PositionType/RealEstate/MaintenanceProvision**

|            |   |
|------------|---|
| diagram    |   |
| type       | <a href="#">FundAmountType</a>  |
| properties | <ul style="list-style-type: none"> <li>isRef 0</li> <li>minOcc 0</li> </ul> |

|            |  |
|------------|--|
|            | maxOcc 1<br>content complex  |
| children   | <a href="#">Amount</a>   |
| annotation | documentation<br>Maintenance provision for the real estate asset<br>documentation<br>Instandhaltungsrückstellung |

element **PositionType/RealEstate/AncillaryCosts**

|            |   |
|------------|---|
| diagram    |   |
| properties | isRef 0<br>minOcc 0<br>maxOcc 1<br>content complex  |
| children   | <a href="#">Outstanding</a> <a href="#">Accrued</a>   |
| annotation | documentation<br>Ancillary costs of the real estate asset<br>documentation<br>Anschaffungsnebenkosten |

element **PositionType/RealEstate/AncillaryCosts/Outstanding**

|            |   |
|------------|---|
| diagram    |   |
| type       | <a href="#">FundAmountType</a>  |
| properties | isRef 0<br>minOcc 0<br>maxOcc 1<br>content complex                          |
| children   | <a href="#">Amount</a>  |
| annotation | documentation<br>Ancillary costs outstanding<br>documentation<br>offene ANK |

element **PositionType/RealEstate/AncillaryCosts/Accrued**

|            |  |
|------------|--|
| diagram    |  |
| type       | <a href="#">FundAmountType</a>   |
| properties | isRef 0<br>minOcc 0<br>maxOcc 1<br>content complex   |
| children   | <a href="#">Amount</a>   |
| annotation | documentation<br>Ancillary costs already accrued<br>documentation<br>bereits abgegrenzte ANK |

element **PositionType/RealEstate/RentDeposit**

|            |   |
|------------|---|
| diagram    |   |
| type       | <a href="#">FundAmountType</a>  |
| properties | isRef 0<br>minOcc 0<br>maxOcc 1<br>content complex                                    |
| children   | <a href="#">Amount</a>  |
| annotation | documentation<br>Rent deposit for the real estate asset<br>documentation<br>Kautionen |

element **PositionType/RealEstate/RentReceivables**

|            |                                |
|------------|--------------------------------|
| diagram    |                                |
| type       | <a href="#">FundAmountType</a> |
| properties | isRef 0<br>minOcc 0            |



|            |  |
|------------|--|
|            | maxOcc 1<br>content complex  |
| children   | <a href="#">Amount</a>   |
| annotation | documentation<br>Outstanding rent receivables<br>documentation<br>offene Mietforderungen |

### element **PositionType/RealEstate/TaxLiabilities**

|            |  |
|------------|--|
| diagram    |  |
| type       | <a href="#">FundAmountType</a>   |
| properties | isRef 0<br>minOcc 0<br>maxOcc 1<br>content complex   |
| children   | <a href="#">Amount</a>   |
| annotation | documentation<br>Consolidated tax liabilities for the real estate asset<br>documentation<br>Steuerverbindlichkeiten (Sammelposition) |

### element **PositionType/RealEstate/VacancyCosts**

|            |   |
|------------|---|
| diagram    |   |
| type       | <a href="#">FundAmountType</a>  |
| properties | isRef 0<br>minOcc 0<br>maxOcc 1<br>content complex  |
| children   | <a href="#">Amount</a>  |
| annotation | documentation<br>Vacancy costs of the real estate asset<br>documentation<br>Leerstands-Betriebskosten |

element **PositionType/RealEstate/PlannedMaintenanceCosts**

|            |   |
|------------|---|
| diagram    | <p>The diagram shows a dashed box labeled 'PlannedMaintenanceCosts' with the description 'Yearly planned costs of maintenance'. This box is connected to a larger dashed box labeled 'FundAmountType'. Inside the 'FundAmountType' box, there is a box labeled 'Amount' with the cardinality '1..∞' and the description 'Amounts in currency as defined in attribute'. The connection between the two boxes is a line with a small square at the end of the 'PlannedMaintenanceCosts' box and a small square with a plus sign at the end of the 'Amount' box.</p> |
| type       | <a href="#">FundAmountType</a>  |
| properties | <ul style="list-style-type: none"> <li>isRef 0</li> <li>minOcc 0</li> <li>maxOcc 1</li> <li>content complex</li> </ul>  |
| children   | <a href="#">Amount</a>  |
| annotation | <p>documentation<br/>Yearly planned costs of maintenance</p> <p>documentation<br/>Enthaelt die jährlich geplanten Instandhaltungskosten</p>   |

element **PositionType/RealEstate/OtherIncome**

|            |   |
|------------|---|
| diagram    | <p>The diagram shows a dashed box labeled 'OtherIncome' with the description 'Other income of the real estate asset; e.g. building lease charges etc.'. This box is connected to a larger dashed box labeled 'FundAmountType'. Inside the 'FundAmountType' box, there is a box labeled 'Amount' with the cardinality '1..∞' and the description 'Amounts in currency as defined in attribute'. The connection between the two boxes is a line with a small square at the end of the 'OtherIncome' box and a small square with a plus sign at the end of the 'Amount' box.</p> |
| type       | <a href="#">FundAmountType</a>  |
| properties | <ul style="list-style-type: none"> <li>isRef 0</li> <li>minOcc 0</li> <li>maxOcc 1</li> <li>content complex</li> </ul>  |
| children   | <a href="#">Amount</a>  |
| annotation | <p>documentation<br/>Other income of the real estate asset; e.g. building lease charges etc.</p> <p>documentation<br/>Pacht/Baurechtzins etc.</p>   |

element **PositionType/RealEstate/OtherAssets**

|            |   |
|------------|---|
| diagram    | <p>The diagram shows a dashed box labeled 'OtherAssets' with the description 'Other assets corresponding to the real estate asset'. This box is connected to a larger dashed box labeled 'FundAmountType'. Inside the 'FundAmountType' box, there is a box labeled 'Amount' with the cardinality '1..∞' and the description 'Amounts in currency as defined in attribute'. The connection between the two boxes is a line with a small square at the end of the 'OtherAssets' box and a small square with a plus sign at the end of the 'Amount' box.</p> |
| type       | <a href="#">FundAmountType</a>  |
| properties | <ul style="list-style-type: none"> <li>isRef 0</li> <li>minOcc 0</li> </ul>   |

|            |  |
|------------|--|
|            | maxOcc 1<br>content complex  |
| children   | <a href="#">Amount</a>   |
| annotation | documentation<br>Other assets corresponding to the real estate asset<br>documentation<br>Sonstige Aktiva |

element **PositionType/RealEstate/OtherLiabilities**

|            |  |
|------------|--|
| diagram    |  |
| type       | <a href="#">FundAmountType</a>   |
| properties | isRef 0<br>minOcc 0<br>maxOcc 1<br>content complex   |
| children   | <a href="#">Amount</a>   |
| annotation | documentation<br>Other liabilities corresponding to the real estate asset<br>documentation<br>Sonstige Passiva |

element **PositionType/RealEstate/OtherNonFinancialAssetValue**

|            |  |
|------------|--|
| diagram    |  |
| type       | <a href="#">FundAmountType</a>   |
| properties | isRef 0<br>minOcc 0<br>maxOcc 1<br>content complex   |
| children   | <a href="#">Amount</a>   |
| annotation | documentation<br>Current market value of other non financial assets corresponding to the real estate asset<br>documentation<br>Sonstige Bewirtschaftungsgüter; Zeitwert zum Stichtag |

element **PositionType/REIT**

|            |  |
|------------|--|
| diagram    | <p>The diagram shows a box labeled 'REIT' with the text 'Details for real estate investment trust' below it. A line connects this box to a complex container box (a rectangle with a dashed border and a small square on the right side). From this container box, a vertical dashed line leads to a list of six child elements, each in a dashed box with a plus sign icon:</p> <ul style="list-style-type: none"> <li><b>Units</b>: Units of REIT</li> <li><b>Price</b>: Price (in different currencies)</li> <li><b>OtherPrices</b>: Additional prices (e.g. hold to maturity)</li> <li><b>MarketValue</b>: Market value of position (excluding dividends)</li> <li><b>PurchaseValue</b>: Purchase value of position</li> <li><b>DividendsDue</b>: Dividends due of position</li> </ul> |
| properties | isRef 0<br>content complex   |
| children   | <a href="#">Units</a> <a href="#">Price</a> <a href="#">OtherPrices</a> <a href="#">MarketValue</a> <a href="#">PurchaseValue</a> <a href="#">DividendsDue</a>   |
| annotation | documentation<br>Details for real estate investment trust  |

element **PositionType/REIT/Units**

|            |   |
|------------|---|
| diagram    | <p>The diagram shows a dashed box labeled 'Units' with the text 'Units of REIT' below it.</p> |
| type       | <b>xs:decimal</b>   |
| properties | isRef 0<br>minOcc 0<br>maxOcc 1<br>content simple   |
| annotation | documentation<br>Units of REIT<br>documentation<br>Stücke der Aktie im Bestand                |

element **PositionType/REIT/Price**

|         |  |
|---------|--|
| diagram | <p>The diagram shows a box labeled 'Price' with the text 'Price (in different currencies)' below it. A line connects this box to a larger box labeled 'FundAmountType' with a yellow background. Inside the 'FundAmountType' box, there is a box labeled 'Amount' with the text 'Amounts in currency as defined in attribute' below it. The 'Amount' box has a plus sign icon and the cardinality '1..∞' below it.</p> |
| type    | <a href="#">FundAmountType</a>   |

|            |   |
|------------|---|
| properties | isRef 0<br>minOcc 0<br>maxOcc 1<br>content complex  |
| children   | <a href="#">Amount</a>  |
| annotation | documentation<br>Price (in different currencies)<br>documentation<br>Preis der Aktie (in verschiedenen Währungen) |

element **PositionType/REIT/OtherPrices**

|            |  |
|------------|--|
| diagram    | <p>The diagram shows a dashed box labeled 'OtherPricesType' containing two elements: 'OtherPrices' and 'Price'. 'OtherPrices' is connected to 'Price' by a line. 'OtherPrices' has a dashed border and is annotated with 'Additional prices (e.g. hold to maturity)'. 'Price' is connected to a multiplicity '1..∞' and is annotated with 'Inform on the price type (different from the official NAV) used for other price communication'.</p> |
| type       | <a href="#">OtherPricesType</a>  |
| properties | isRef 0<br>minOcc 0<br>maxOcc 1<br>content complex   |
| children   | <a href="#">Price</a>  |
| annotation | documentation<br>Additional prices (e.g. hold to maturity)   |

element **PositionType/REIT/MarketValue**

|            |   |
|------------|---|
| diagram    | <p>The diagram shows a dashed box labeled 'FundAmountType' containing two elements: 'MarketValue' and 'Amount'. 'MarketValue' is connected to 'Amount' by a line. 'MarketValue' has a dashed border and is annotated with 'Market value of position (excluding dividends)'. 'Amount' is connected to a multiplicity '1..∞' and is annotated with 'Amounts in currency as defined in attribute'.</p> |
| type       | <a href="#">FundAmountType</a>  |
| properties | isRef 0<br>minOcc 0<br>maxOcc 1<br>content complex  |
| children   | <a href="#">Amount</a>  |
| annotation | documentation<br>Market value of position (excluding dividends)<br>documentation<br>Kurswert der Aktienposition (exklusive Ansprüche)   |

element **PositionType/REIT/PurchaseValue**

|            |  |
|------------|--|
| diagram    | <p>The diagram shows a dashed box labeled 'PurchaseValue' with the text 'Purchase value of position' below it. A line connects this box to a central octagonal connector. From the connector, a line goes to a box labeled 'Amount' with the text 'Amounts in currency as defined in attribute' below it and '1..∞' to its right. The entire 'Amount' box and its multiplicity are enclosed in a yellow dashed box labeled 'FundAmountType'.</p> |
| type       | <a href="#">FundAmountType</a>   |
| properties | <ul style="list-style-type: none"> <li>isRef 0</li> <li>minOcc 0</li> <li>maxOcc 1</li> <li>content complex</li> </ul>   |
| children   | <a href="#">Amount</a>   |
| annotation | <ul style="list-style-type: none"> <li>documentation</li> <li>Purchase value of position</li> <li>documentation</li> <li>Einstandswert der Position</li> </ul>   |

element **PositionType/REIT/DividendsDue**

|            |  |
|------------|--|
| diagram    | <p>The diagram shows a dashed box labeled 'DividendsDue' with the text 'Dividends due of position' below it. A line connects this box to a central octagonal connector. From the connector, a line goes to a box labeled 'Amount' with the text 'Amounts in currency as defined in attribute' below it and '1..∞' to its right. The entire 'Amount' box and its multiplicity are enclosed in a yellow dashed box labeled 'FundAmountType'.</p> |
| type       | <a href="#">FundAmountType</a>   |
| properties | <ul style="list-style-type: none"> <li>isRef 0</li> <li>minOcc 0</li> <li>maxOcc 1</li> <li>content complex</li> </ul>   |
| children   | <a href="#">Amount</a>   |
| annotation | <ul style="list-style-type: none"> <li>documentation</li> <li>Dividends due of position</li> <li>documentation</li> <li>Dividendenforderungen fuer Aktienbestaende</li> </ul>  |

element **PositionType/Loan**

|         |   |
|---------|---|
| diagram | <p>The diagram shows a box labeled 'Loan' with the text 'Details for loan positions' below it. A line connects this box to a central octagonal connector. From the connector, three dashed lines branch out to three separate boxes: 'Price' with 'Price (in different currencies)' below it, 'MarketValue' with 'Market value of position (without interests)' below it, and 'InterestAccruals' with 'Interest accruals' below it. Each of these three boxes has a small square icon with a plus sign in the top right corner.</p> |
|---------|---|

|            |  |
|------------|--|
| properties | isRef 0<br>content complex   |
| children   | <a href="#">Price</a> <a href="#">MarketValue</a> <a href="#">InterestAccruals</a> |
| annotation | documentation<br>Details for loan positions  |

element **PositionType/Loan/Price**

|            |   |
|------------|---|
| diagram    |   |
| type       | <a href="#">FundAmountType</a>  |
| properties | isRef 0<br>minOcc 0<br>maxOcc 1<br>content complex  |
| children   | <a href="#">Amount</a>  |
| annotation | documentation<br>Price (in different currencies)<br>documentation<br>Preis der Aktie (in verschiedenen Währungen) |

element **PositionType/Loan/MarketValue**

|            |   |
|------------|---|
| diagram    |   |
| type       | <a href="#">FundAmountType</a>                                |
| properties | isRef 0<br>minOcc 0<br>maxOcc 1<br>content complex            |
| children   | <a href="#">Amount</a>  |
| annotation | documentation<br>Market value of position (without interests) |

element **PositionType/Loan/InterestAccruals**

|            |   |
|------------|---|
| diagram    |   |
| type       | <a href="#">FundAmountType</a>  |
| properties | isRef 0<br>minOcc 0<br>maxOcc 1<br>content complex                    |
| children   | <a href="#">Amount</a>  |
| annotation | documentation<br>Interest accruals<br>documentation<br>Zinsabgrenzung |

element **PositionType/Right**

|            |   |
|------------|---|
| diagram    |   |
| properties | isRef 0<br>content complex  |
| children   | <a href="#">Units</a> <a href="#">Price</a> <a href="#">OtherPrices</a> <a href="#">MarketValue</a> <a href="#">PurchaseValue</a> |
| annotation | documentation<br>Details for rights   |

element **PositionType/Right/Units**

|            |                     |
|------------|---------------------|
| diagram    |                     |
| type       | <b>xs:decimal</b>   |
| properties | isRef 0<br>minOcc 0 |



|            |   |
|------------|---|
|            | maxOcc 1<br>content simple  |
| annotation | documentation<br>Units of right<br>documentation<br>Stücke der Aktie im Bestand |

element **PositionType/Right/Price**

|            |   |
|------------|---|
| diagram    |   |
| type       | <a href="#">FundAmountType</a>  |
| properties | isRef 0<br>minOcc 0<br>maxOcc 1<br>content complex  |
| children   | <a href="#">Amount</a>  |
| annotation | documentation<br>Price (in different currencies)<br>documentation<br>Preis der Aktie (in verschiedenen Währungen) |

element **PositionType/Right/OtherPrices**

|            |  |
|------------|--|
| diagram    |  |
| type       | <a href="#">OtherPricesType</a>                            |
| properties | isRef 0<br>minOcc 0<br>maxOcc 1<br>content complex         |
| children   | <a href="#">Price</a>                                      |
| annotation | documentation<br>Additional prices (e.g. hold to maturity) |

element **PositionType/Right/MarketValue**

|            |   |
|------------|---|
| diagram    | <p>The diagram shows a dashed box labeled 'MarketValue' containing the text 'Market value of position (excluding dividends)'. This box is connected to a larger dashed box labeled 'FundAmountType'. Inside 'FundAmountType', there is a box labeled 'Amount' with '1..∞' below it and the text 'Amounts in currency as defined in attribute' below that.</p> |
| type       | <a href="#">FundAmountType</a>  |
| properties | isRef 0<br>minOcc 0<br>maxOcc 1<br>content complex  |
| children   | <a href="#">Amount</a>  |
| annotation | documentation<br>Market value of position (excluding dividends)<br>documentation<br>Kurswert der Aktienposition (exklusive Ansprüche)   |

element **PositionType/Right/PurchaseValue**

|            |   |
|------------|---|
| diagram    | <p>The diagram shows a dashed box labeled 'PurchaseValue' containing the text 'Purchase value of position'. This box is connected to a larger dashed box labeled 'FundAmountType'. Inside 'FundAmountType', there is a box labeled 'Amount' with '1..∞' below it and the text 'Amounts in currency as defined in attribute' below that.</p> |
| type       | <a href="#">FundAmountType</a>  |
| properties | isRef 0<br>minOcc 0<br>maxOcc 1<br>content complex  |
| children   | <a href="#">Amount</a>  |
| annotation | documentation<br>Purchase value of position<br>documentation<br>Einstandswert der Position  |

element **PositionType/Commodity**

|            |  |
|------------|--|
| diagram    | <p>The diagram shows a box labeled 'Commodity' with the text 'Details for commodities (empty)' below it.</p> |
| type       | restriction of <b>xs:string</b>  |
| properties | isRef 0<br>content simple  |
| facets     | Kind Value annotation<br>maxLength 0   |
| annotation | documentation<br>Details for commodities (empty)<br>documentation  |

|  |
|--|
| Details zu Bewertung von Rohstoff (leer) |
|--|

element **PositionType/PrivateEquity**

|            |  |
|------------|--|
| diagram    | <p><b>PrivateEquity</b><br/>Details for private equity (empty)</p> <p><b>OwnershipPercentage</b><br/>How many percent of the Company (SPV) is owned by this position</p> |
| properties | isRef 0<br>content complex   |
| children   | <a href="#">OwnershipPercentage</a>  |
| annotation | documentation<br>Details for private equity (empty)<br>documentation<br>Details zur Bewertung von Unternehmensbeteiligung (leer)   |

element **PositionType/PrivateEquity/OwnershipPercentage**

|            |  |
|------------|--|
| diagram    | <p><b>OwnershipPercentage</b><br/>How many percent of the Company (SPV) is owned by this position</p>  |
| type       | <a href="#">PercentageType</a>   |
| properties | isRef 0<br>minOcc 0<br>maxOcc 1<br>content simple  |
| annotation | documentation<br>How many percent of the Company (SPV) is owned by this position<br>documentation<br>Wie viel Prozent des Unternehmens besitzt der Fonds |

element **PositionType/CommercialPaper**

|                   |   |
|-------------------|---|
| <p>diagram</p>    |   |
| <p>properties</p> | <p>isRef 0<br/>content complex</p>  |
| <p>children</p>   | <p><a href="#">Nominal</a> <a href="#">Price</a> <a href="#">DirtyPrice</a> <a href="#">MarketValue</a> <a href="#">InterestClaimNet</a> <a href="#">InterestClaimGross</a> <a href="#">AccruedInterestDays</a> <a href="#">PurchaseValue</a></p> |
| <p>annotation</p> | <p>documentation<br/>Commercial Paper and Certificate of Deposit</p>  |

element **PositionType/CommercialPaper/Nominal**

|                   |  |
|-------------------|--|
| <p>diagram</p>    |  |
| <p>type</p>       | <p><b>xs:decimal</b></p>   |
| <p>properties</p> | <p>isRef 0<br/>content simple</p>  |
| <p>annotation</p> | <p>documentation<br/>Nominal value (units) of CP or CD<br/>documentation<br/>Nominale/Stückzahl der Rentenposition</p> |

element **PositionType/CommercialPaper/Price**

|            |  |
|------------|--|
| diagram    |  |
| type       | <a href="#">FundAmountType</a>   |
| properties | <ul style="list-style-type: none"> <li>isRef 0</li> <li>minOcc 0</li> <li>maxOcc 1</li> <li>content complex</li> </ul>   |
| children   | <a href="#">Amount</a>   |
| annotation | <ul style="list-style-type: none"> <li>documentation<br/>Clean price (in different currencies)</li> <li>documentation<br/>Bewertungskurs (in verschiedenen Währungen)</li> </ul> |

element **PositionType/CommercialPaper/DirtyPrice**

|            |  |
|------------|--|
| diagram    |  |
| type       | <a href="#">FundAmountType</a>   |
| properties | <ul style="list-style-type: none"> <li>isRef 0</li> <li>minOcc 0</li> <li>maxOcc 1</li> <li>content complex</li> </ul> |
| children   | <a href="#">Amount</a>   |
| annotation | <ul style="list-style-type: none"> <li>documentation<br/>Dirty Price (including interests)</li> </ul>                  |

element **PositionType/CommercialPaper/MarketValue**

|            |  |
|------------|--|
| diagram    |  |
| type       | <a href="#">FundAmountType</a>   |
| properties | <ul style="list-style-type: none"> <li>isRef 0</li> <li>minOcc 0</li> <li>maxOcc 1</li> <li>content complex</li> </ul> |

|            |  |
|------------|--|
| children   | <a href="#">Amount</a>   |
| annotation | documentation<br>Market value of security position without interests |

element **PositionType/CommercialPaper/InterestClaimNet**

|            |   |
|------------|---|
| diagram    |   |
| type       | <a href="#">FundAmountType</a>  |
| properties | isRef 0<br>minOcc 0<br>maxOcc 1<br>content complex  |
| children   | <a href="#">Amount</a>  |
| annotation | documentation<br>Interest claim net value<br>documentation<br>Netto-Zinsanspruch der Rentenposition |

element **PositionType/CommercialPaper/InterestClaimGross**

|            |  |
|------------|--|
| diagram    |  |
| type       | <a href="#">FundAmountType</a>   |
| properties | isRef 0<br>minOcc 0<br>maxOcc 1<br>content complex   |
| children   | <a href="#">Amount</a>   |
| annotation | documentation<br>Interest claim gross value<br>documentation<br>Brutto-Zinsanspruch der Rentenposition |

element **PositionType/CommercialPaper/AccruedInterestDays**

|         |                   |
|---------|-------------------|
| diagram |                   |
| type    | <b>xs:integer</b> |

|            |  |
|------------|--|
| properties | isRef 0<br>minOcc 0<br>maxOcc 1<br>content simple  |
| annotation | documentation<br>Number of accrued interest days<br>documentation<br>Anzahl der Stueckzins Tage an |

element **PositionType/CommercialPaper/PurchaseValue**

|            |   |
|------------|---|
| diagram    |   |
| type       | <a href="#">FundAmountType</a>                                    |
| properties | isRef 0<br>minOcc 0<br>maxOcc 1<br>content complex                |
| children   | <a href="#">Amount</a>  |
| annotation | documentation<br>Purchase Value<br>documentation<br>Einstandswert |

element **PositionType/CapitalYieldsTaxClaim**

|            |  |
|------------|--|
| diagram    |  |
| type       | <a href="#">FundAmountType</a>   |
| properties | isRef 0<br>minOcc 0<br>maxOcc 1<br>content complex   |
| children   | <a href="#">Amount</a>   |
| annotation | documentation<br>Capital yields tax claim of position<br>documentation<br>KESt-Betrag der Position |

element **PositionType/InflationaryAdjustment**

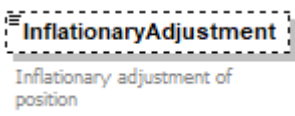
|            |   |
|------------|---|
| diagram    |                          |
| type       | <a href="#">PercentageType</a>  |
| properties | isRef 0<br>minOcc 0<br>maxOcc 1<br>content simple   |
| annotation | documentation<br>Inflationary adjustment of position<br>documentation<br>Inflationsausgleich der Position |

element **PositionType/RiskCodes**

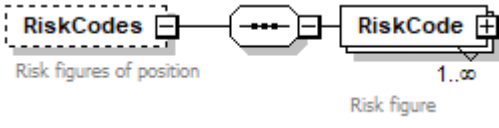
|            |   |
|------------|---|
| diagram    |            |
| properties | isRef 0<br>minOcc 0<br>maxOcc 1<br>content complex  |
| children   | <a href="#">RiskCode</a>  |
| annotation | documentation<br>Risk figures of position<br>documentation<br>Risikokennzahlen der Position |



element **PositionType/RiskCodes/RiskCode**

diagram

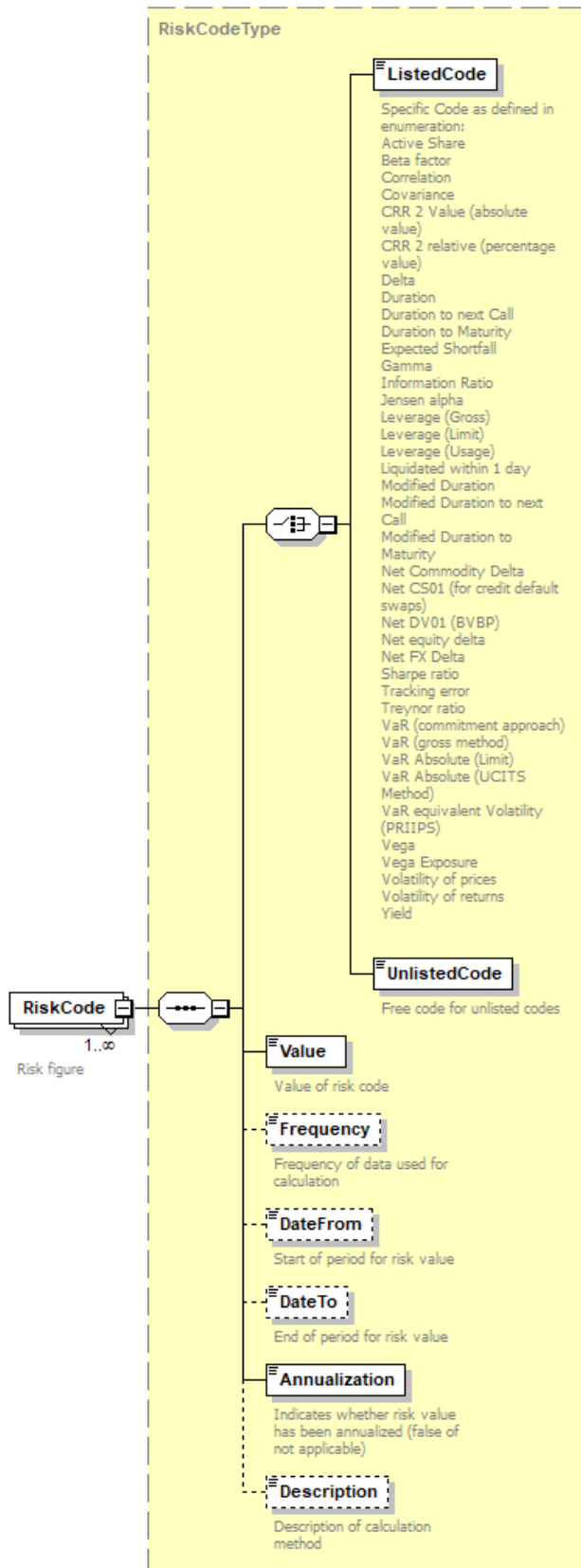

|            |   |
|------------|---|
| type       | <a href="#">RiskCodeType</a>  |
| properties | isRef 0<br>minOcc 1<br>maxOcc unbounded<br>content complex  |
| children   | <a href="#">ListedCode</a> <a href="#">UnlistedCode</a> <a href="#">Value</a> <a href="#">Frequency</a> <a href="#">DateFrom</a> <a href="#">DateTo</a> <a href="#">Annualization</a> <a href="#">Description</a> |
| annotation | documentation<br>Risk figure<br>documentation<br>Risikokennzahl   |

element **PositionType/Underlyings**

|            |  |
|------------|--|
| diagram    | <p>UML diagram showing a container named <b>Underlyings</b> (with a dashed border and a minus sign icon) connected to a container named <b>Underlying</b> (with a plus sign icon). The <b>Underlyings</b> container has a multiplicity of 1..* and the <b>Underlying</b> container has a multiplicity of 1..∞. Below the <b>Underlyings</b> container is the text "Details of underlyings (price, ...)".</p> |
| properties | isRef 0<br>minOcc 0<br>maxOcc 1<br>content complex   |
| children   | <a href="#">Underlying</a>   |
| annotation | documentation<br>Details of underlyings (price, ...)   |

element **PositionType/Underlyings/Underlying**

|            |   |
|------------|---|
| diagram    | <p>UML diagram showing a container named <b>Underlying</b> (with a plus sign icon) connected to a container named <b>PositionUnderlyingType</b> (with a dashed border and a plus sign icon). The <b>Underlying</b> container has a multiplicity of 1..∞. The <b>PositionUnderlyingType</b> container contains several attributes: <b>UniqueID</b>, <b>Identifiers</b> (+), <b>Currency</b>, <b>Issuer</b>, <b>Price</b>, <b>Delta</b>, <b>Solvability</b>, <b>Weight</b>, and <b>FXRates</b> (+).</p> |
| type       | <a href="#">PositionUnderlyingType</a>  |
| properties | isRef 0<br>minOcc 1<br>maxOcc unbounded<br>content complex  |

|          |   |
|----------|---|
| children | <a href="#">UniqueID</a> <a href="#">Identifiers</a> <a href="#">Currency</a> <a href="#">Issuer</a> <a href="#">Price</a> <a href="#">Delta</a> <a href="#">Solvability</a> <a href="#">Weight</a> <a href="#">FXRates</a> |
|----------|---|

element **PositionType/CustomAttributes**

|            |   |
|------------|---|
| diagram    |   |
| type       | <a href="#">AttributesType</a>  |
| properties | isRef 0<br>minOcc 0<br>maxOcc 1<br>content complex                              |
| children   | <a href="#">Attribute</a>   |
| annotation | documentation<br>Additional information which does not fit into the nodes above |

complexType **PositionUnderlyingType**

|            |   |
|------------|---|
| diagram    |   |
| children   | <a href="#">UniqueID</a> <a href="#">Identifiers</a> <a href="#">Currency</a> <a href="#">Issuer</a> <a href="#">Price</a> <a href="#">Delta</a> <a href="#">Solvability</a> <a href="#">Weight</a> <a href="#">FXRates</a> |
| used by    | element <a href="#">PositionType/Underlyings/Underlying</a>   |
| annotation | documentation<br>Position underlying details  |

element **PositionUnderlyingType/UniqueID**

|         |  |
|---------|--|
| diagram |  |
|---------|--|

|            |   |
|------------|---|
| type       | <b>xs:IDREF</b>                                   |
| properties | isRef 0<br>minOcc 0<br>maxOcc 1<br>content simple |

element **PositionUnderlyingType/Identifiers**

diagram

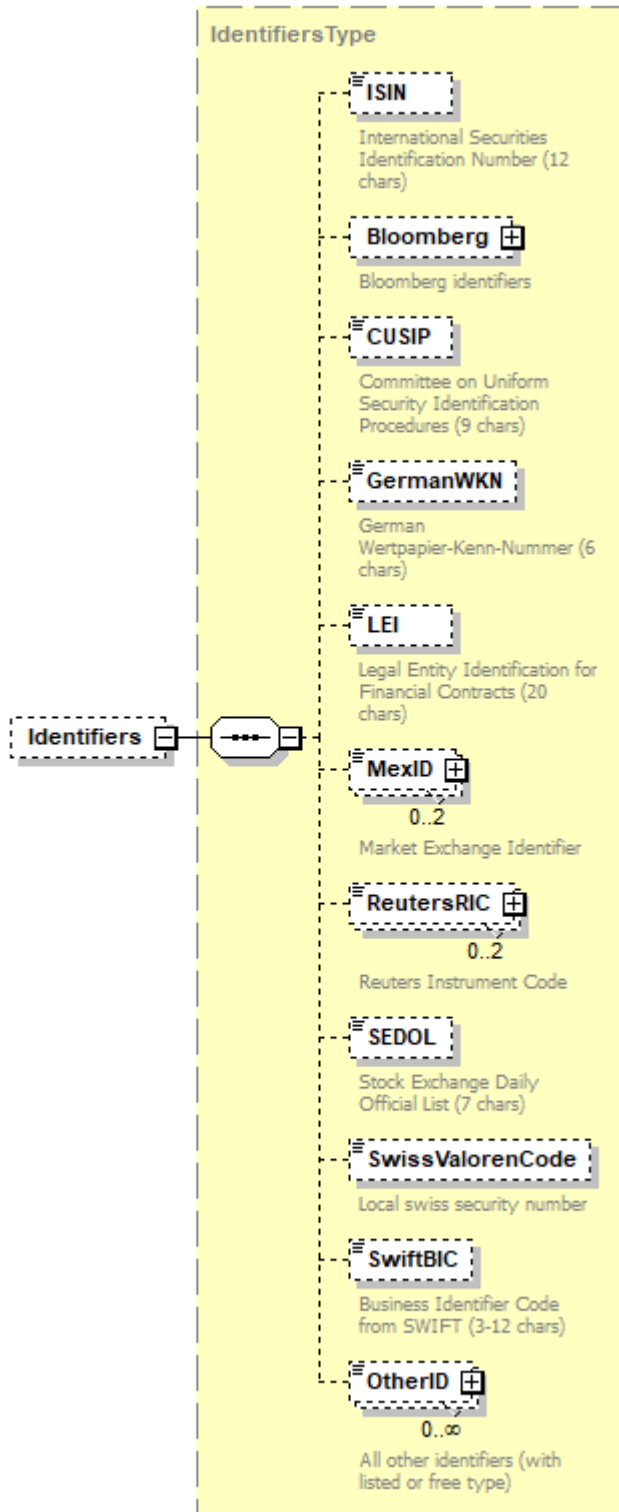

type [IdentifiersType](#)

properties  
 isRef 0  
 minOcc 0  
 maxOcc 1

|          |   |
|----------|---|
|          | content complex   |
| children | <a href="#">ISIN</a> <a href="#">Bloomberg</a> <a href="#">CUSIP</a> <a href="#">GermanWKN</a> <a href="#">LEI</a> <a href="#">MexID</a> <a href="#">ReutersRIC</a> <a href="#">SEDOL</a> <a href="#">SwissValorenCode</a> <a href="#">SwiftBIC</a> <a href="#">OtherID</a> |

element **PositionUnderlyingType/Currency**

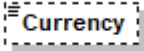
|            |   |
|------------|---|
| diagram    |  |
| type       | <a href="#">ISOCurrencyCodeType</a>   |
| properties | isRef 0<br>minOcc 0<br>maxOcc 1<br>content simple                                 |
| facets     | Kind Value annotation<br>minLength 3<br>maxLength 3<br>pattern [A-Z]{3}           |

element **PositionUnderlyingType/Issuer**

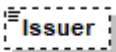
|            |   |
|------------|---|
| diagram    |  |
| type       | <b>xs:string</b>  |
| properties | isRef 0<br>minOcc 0<br>maxOcc 1<br>content simple                                 |

element **PositionUnderlyingType/Price**

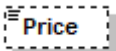
|            |   |
|------------|---|
| diagram    |  |
| type       | <b>xs:decimal</b>   |
| properties | isRef 0<br>minOcc 0<br>maxOcc 1<br>content simple                                   |

element **PositionUnderlyingType/Delta**

|            |   |
|------------|---|
| diagram    |  |
| type       | <b>xs:decimal</b>   |
| properties | isRef 0<br>minOcc 0<br>maxOcc 1<br>content simple                                   |

element **PositionUnderlyingType/Solvability**

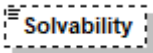
|            |   |
|------------|---|
| diagram    |  |
| type       | <b>xs:decimal</b>   |
| properties | isRef 0<br>minOcc 0<br>maxOcc 1<br>content simple                                 |

element **PositionUnderlyingType/Weight**

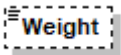
|            |   |
|------------|---|
| diagram    |  |
| type       | <a href="#">PercentageType</a>  |
| properties | isRef 0<br>minOcc 0<br>maxOcc 1<br>content simple                                 |

element **PositionUnderlyingType/FXRates**

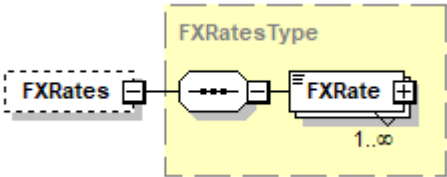
|            |  |
|------------|--|
| diagram    |  |
| type       | <a href="#">FXRatesType</a>  |
| properties | isRef 0<br>minOcc 0<br>maxOcc 1<br>content complex                                 |
| children   | <a href="#">FXRate</a>   |

complexType **PositionValuationType**

|         |   |
|---------|---|
| diagram |  |
|---------|---|

complexType RiskCodeType

diagram

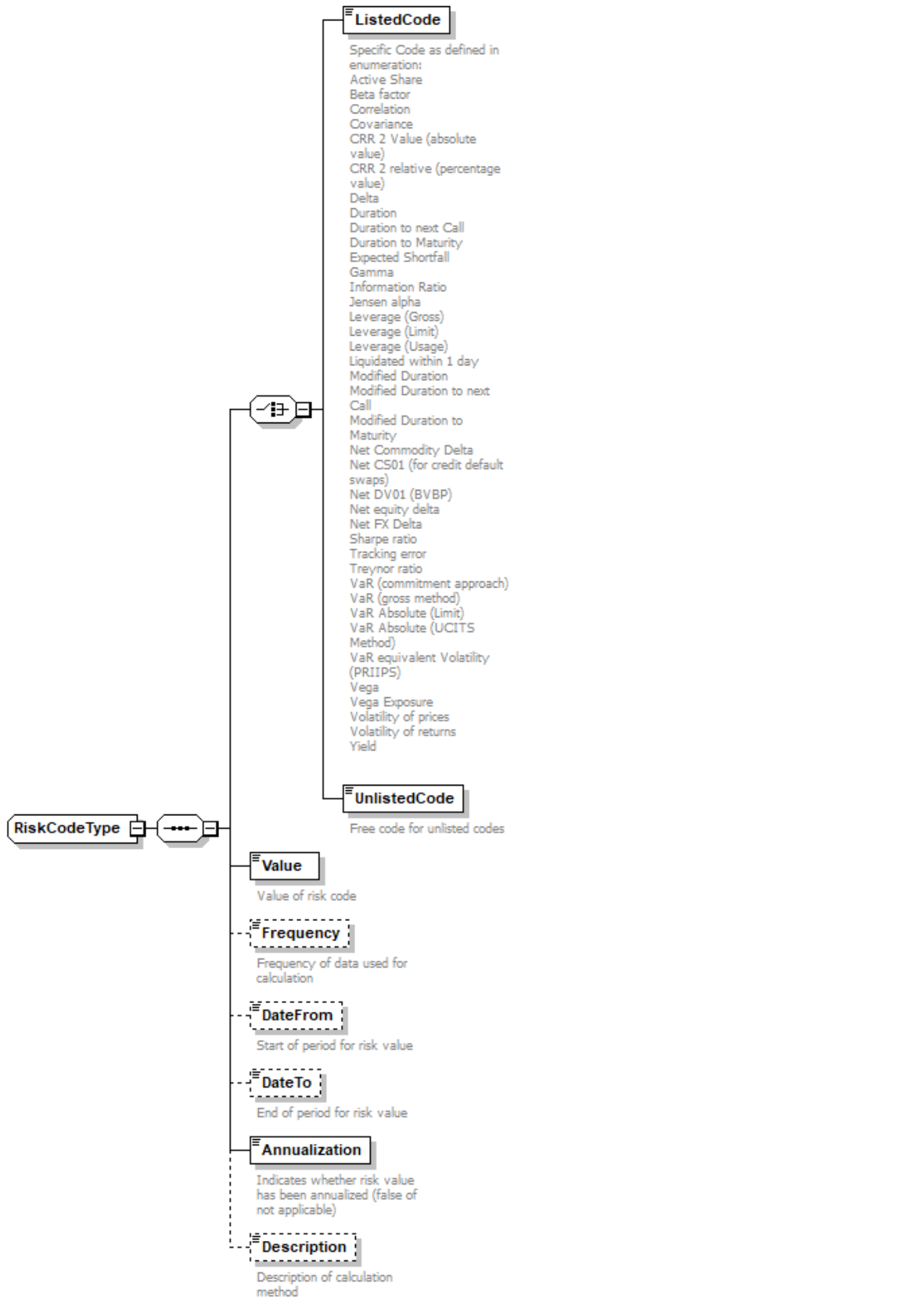



|          |   |
|----------|---|
| children | <a href="#">ListedCode</a> <a href="#">UnlistedCode</a> <a href="#">Value</a> <a href="#">Frequency</a> <a href="#">DateFrom</a> <a href="#">DateTo</a> <a href="#">Annualization</a> <a href="#">Description</a> |
| used by  | elements <a href="#">PortfolioType/RiskCodes/RiskCode</a> <a href="#">PositionType/RiskCodes/RiskCode</a>   |

element **RiskCodeType/ListedCode**

|            |  |
|------------|--|
| diagram    |  <p><b>ListedCode</b></p> <p>Specific Code as defined in enumeration:</p> <ul style="list-style-type: none"> <li>Active Share</li> <li>Beta factor</li> <li>Correlation</li> <li>Covariance</li> <li>CRR 2 Value (absolute value)</li> <li>CRR 2 relative (percentage value)</li> <li>Delta</li> <li>Duration</li> <li>Duration to next Call</li> <li>Duration to Maturity</li> <li>Expected Shortfall</li> <li>Gamma</li> <li>Information Ratio</li> <li>Jensen alpha</li> <li>Leverage (Gross)</li> <li>Leverage (Limit)</li> <li>Leverage (Usage)</li> <li>Liquidated within 1 day</li> <li>Modified Duration</li> <li>Modified Duration to next Call</li> <li>Modified Duration to Maturity</li> <li>Net Commodity Delta</li> <li>Net CS01 (for credit default swaps)</li> <li>Net DV01 (BVBP)</li> <li>Net equity delta</li> <li>Net FX Delta</li> <li>Sharpe ratio</li> <li>Tracking error</li> <li>Treynor ratio</li> <li>VaR (commitment approach)</li> <li>VaR (gross method)</li> <li>VaR Absolute (Limit)</li> <li>VaR Absolute (UCITS Method)</li> <li>VaR equivalent Volatility (PRIIPS)</li> <li>Vega</li> <li>Vega Exposure</li> <li>Volatility of prices</li> <li>Volatility of returns</li> <li>Yield</li> </ul> |
| type       | restriction of <b>xs:string</b>  |
| properties | isRef 0<br>content simple  |
| annotation | documentation<br>Specific Code as defined in enumeration:<br>Active Share<br>Beta factor<br>Correlation<br>Covariance<br>CRR 2 Value (absolute value)<br>CRR 2 relative (percentage value)<br>Delta<br>Duration  |

|  |   |
|--|---|
|  | Duration to next Call<br>Duration to Maturity<br>Expected Shortfall<br>Gamma<br>Information Ratio<br>Jensen alpha<br>Leverage (Gross)<br>Leverage (Limit)<br>Leverage (Usage)<br>Liquidated within 1 day<br>Modified Duration<br>Modified Duration to next Call<br>Modified Duration to Maturity<br>Net Commodity Delta<br>Net CS01 (for credit default swaps)<br>Net DV01 (BVBP)<br>Net equity delta<br>Net FX Delta<br>Sharpe ratio<br>Tracking error<br>Treydor ratio<br>VaR (commitment approach)<br>VaR (gross method)<br>VaR Absolute (Limit)<br>VaR Absolute (UCITS Method)<br>VaR equivalent Volatility (PRIIPS)<br>Vega<br>Vega Exposure<br>Volatility of prices<br>Volatility of returns<br>Yield |
|--|---|

**element RiskCodeType/UnlistedCode**

|            |   |
|------------|---|
| diagram    |  |
| type       | restriction of <b>xs:string</b>   |
| properties | isRef 0<br>content simple   |
| facets     | Kind Value annotation<br>maxLength 100  |
| annotation | documentation<br>Free code for unlisted codes                                       |

**element RiskCodeType/Value**

|            |   |
|------------|---|
| diagram    |  |
| type       | <b>xs:decimal</b>   |
| properties | isRef 0<br>content simple   |
| annotation | documentation<br>Value of risk code<br>documentation<br>Wert der Risikokennzahl     |

element **RiskCodeType/Frequency**

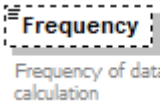
|            |   |
|------------|---|
| diagram    |  <p>Frequency of data used for calculation</p>       |
| type       | <a href="#">FrequencyType</a>   |
| properties | isRef 0<br>minOcc 0<br>maxOcc 1<br>content simple   |
| annotation | documentation<br>Frequency of data used for calculation<br>documentation<br>Bezieht sich auf die zur Berechnung verwendete Datenbasis |

element **RiskCodeType/DateFrom**

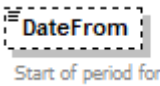
|            |   |
|------------|---|
| diagram    |  <p>Start of period for risk value</p> |
| type       | <b>xs:date</b>  |
| properties | isRef 0<br>minOcc 0<br>maxOcc 1<br>content simple   |
| annotation | documentation<br>Start of period for risk value<br>documentation<br>Beginn des Kennzahl - Intervalles                   |

element **RiskCodeType/DateTo**

|            |   |
|------------|---|
| diagram    |  <p>End of period for risk value</p> |
| type       | <b>xs:date</b>  |
| properties | isRef 0<br>minOcc 0<br>maxOcc 1<br>content simple   |
| annotation | documentation<br>End of period for risk value<br>documentation<br>Ende des Kennzahl - Intervalles                       |

element **RiskCodeType/Annualization**

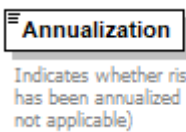
|            |   |
|------------|---|
| diagram    |  <p>Indicates whether risk value has been annualized (false of not applicable)</p> |
| type       | <b>xs:boolean</b>   |
| properties | isRef 0<br>content simple   |

|            |  |
|------------|--|
|            | default false  |
| annotation | documentation<br>Indicates whether risk value has been annualized (false of not applicable)<br>documentation<br>true - annualisiert<br>false - nicht annualisiert bzw. nicht anwendbar |

**element RiskCodeType/Description**

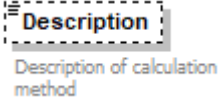
|            |  |
|------------|--|
| diagram    |                           |
| type       | <a href="#">Text1000Type</a>   |
| properties | isRef 0<br>minOcc 0<br>maxOcc 1<br>content simple  |
| facets     | Kind Value annotation<br>maxLength 1000  |
| annotation | documentation<br>Description of calculation method<br>documentation<br>Beschreibung der Berechnungsmethode |

**complexType EarningsType**

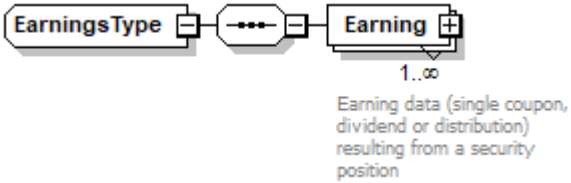
|          |   |
|----------|---|
| diagram  |  |
| children | <a href="#">Earning</a>   |
| used by  | element <a href="#">PortfolioType/Earnings</a>                                      |

# element EarningsType/Earning

diagram

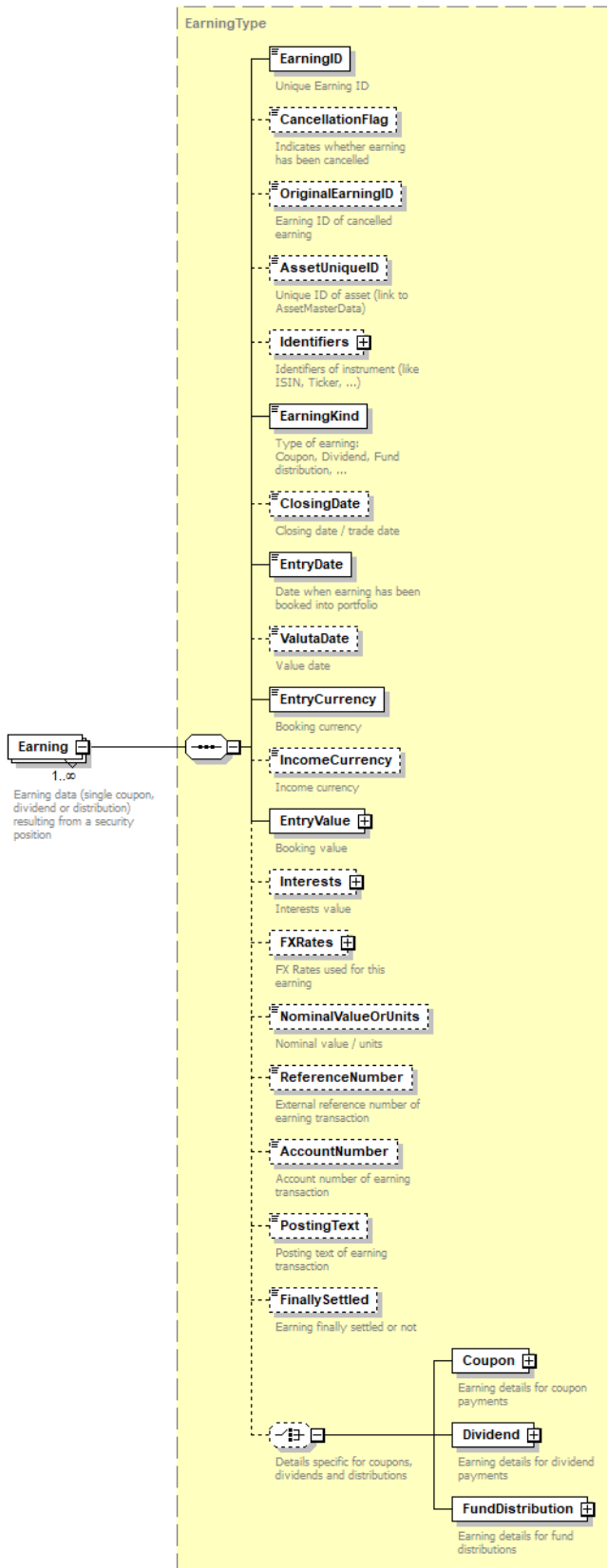

|            |   |
|------------|---|
| type       | <a href="#">EarningType</a>   |
| properties | isRef 0<br>minOcc 1<br>maxOcc unbounded<br>content complex  |
| children   | <a href="#">EarningID</a> <a href="#">CancellationFlag</a> <a href="#">OriginalEarningID</a> <a href="#">AssetUniqueID</a> <a href="#">Identifiers</a> <a href="#">EarningKind</a> <a href="#">ClosingDate</a> <a href="#">EntryDate</a><br><a href="#">ValutaDate</a> <a href="#">EntryCurrency</a> <a href="#">IncomeCurrency</a> <a href="#">EntryValue</a> <a href="#">Interests</a> <a href="#">FXRates</a> <a href="#">NominalValueOrUnits</a> <a href="#">ReferenceNumber</a><br><a href="#">AccountNumber</a> <a href="#">PostingText</a> <a href="#">FinallySettled</a> <a href="#">Coupon</a> <a href="#">Dividend</a> <a href="#">FundDistribution</a> |
| annotation | documentation<br>Earning data (single coupon, dividend or distribution) resulting from a security position  |

complexType **EarningType**

diagram

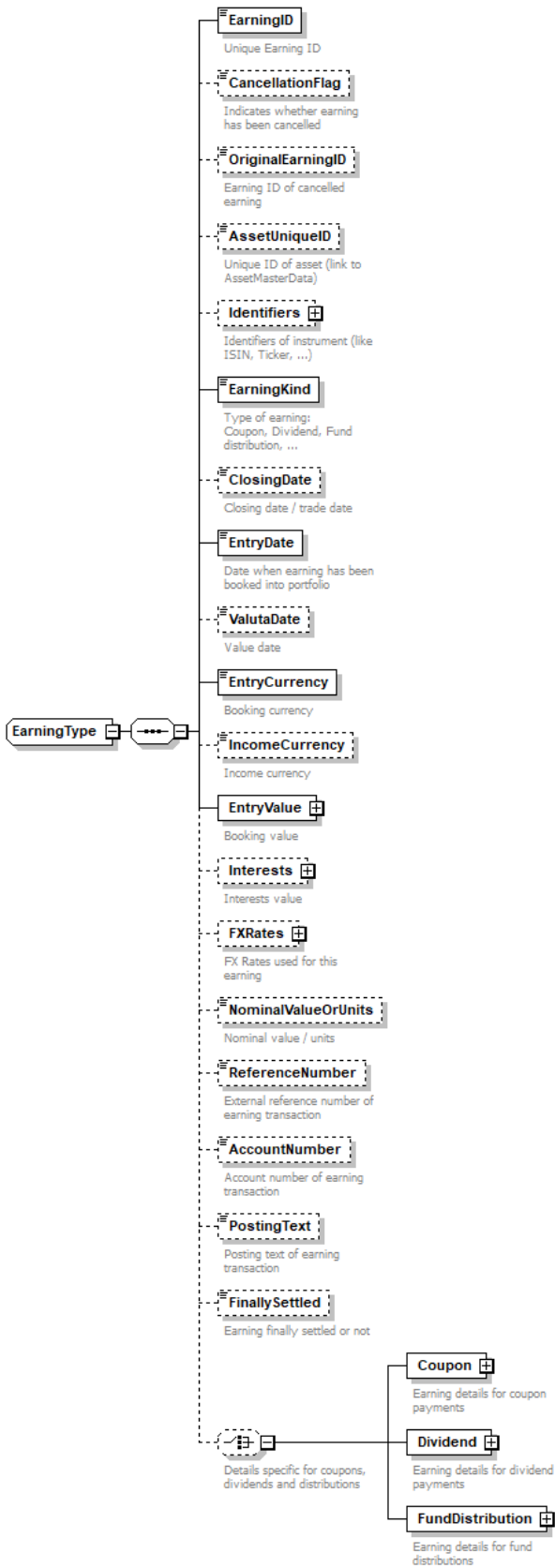



|          |   |
|----------|---|
| children | <a href="#">EarningID</a> <a href="#">CancellationFlag</a> <a href="#">OriginalEarningID</a> <a href="#">AssetUniqueID</a> <a href="#">Identifiers</a> <a href="#">EarningKind</a> <a href="#">ClosingDate</a> <a href="#">EntryDate</a> <a href="#">ValutaDate</a> <a href="#">EntryCurrency</a> <a href="#">IncomeCurrency</a> <a href="#">EntryValue</a> <a href="#">Interests</a> <a href="#">FXRates</a> <a href="#">NominalValueOrUnits</a> <a href="#">ReferenceNumber</a> <a href="#">AccountNumber</a> <a href="#">PostingText</a> <a href="#">FinallySettled</a> <a href="#">Coupon</a> <a href="#">Dividend</a> <a href="#">FundDistribution</a> |
| used by  | element <a href="#">EarningsType/Earning</a>  |

#### element [EarningType/EarningID](#)

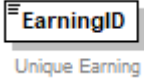
|            |   |
|------------|---|
| diagram    |                      |
| type       | <a href="#">Text256Type</a>   |
| properties | isRef 0<br>content simple   |
| facets     | Kind Value annotation<br>maxLength 256  |
| annotation | documentation<br>Unique Earning ID<br>documentation<br>Eindeutige Transaktionsnummer (Auftragsnummer) |

#### element [EarningType/CancellationFlag](#)

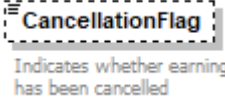
|            |  |
|------------|--|
| diagram    |    |
| type       | xs:boolean   |
| properties | isRef 0<br>minOcc 0<br>maxOcc 1<br>content simple  |
| annotation | documentation<br>Indicates whether earning has been cancelled<br>documentation<br>Kennzeichen ob das Erträgnis storniert wurde |

#### element [EarningType/OriginalEarningID](#)

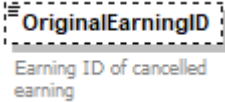
|            |   |
|------------|---|
| diagram    |  |
| type       | <a href="#">Text256Type</a>   |
| properties | isRef 0<br>minOcc 0<br>maxOcc 1<br>content simple                                   |
| facets     | Kind Value annotation<br>maxLength 256  |
| annotation | documentation<br>Earning ID of cancelled earning                                    |

element **EarningType/AssetUniqueID**

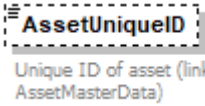
|            |   |
|------------|---|
| diagram    |  <p>Unique ID of asset (link to AssetMasterData)</p> |
| type       | restriction of <b>xs:IDREF</b>  |
| properties | isRef 0<br>minOcc 0<br>maxOcc 1<br>content simple   |
| facets     | Kind Value annotation<br>maxLength 256  |
| annotation | documentation<br>Unique ID of asset (link to AssetMasterData)<br>documentation<br>Referenz zu den Wertpapierstammdaten                |

element **EarningType/Identifiers**

diagram

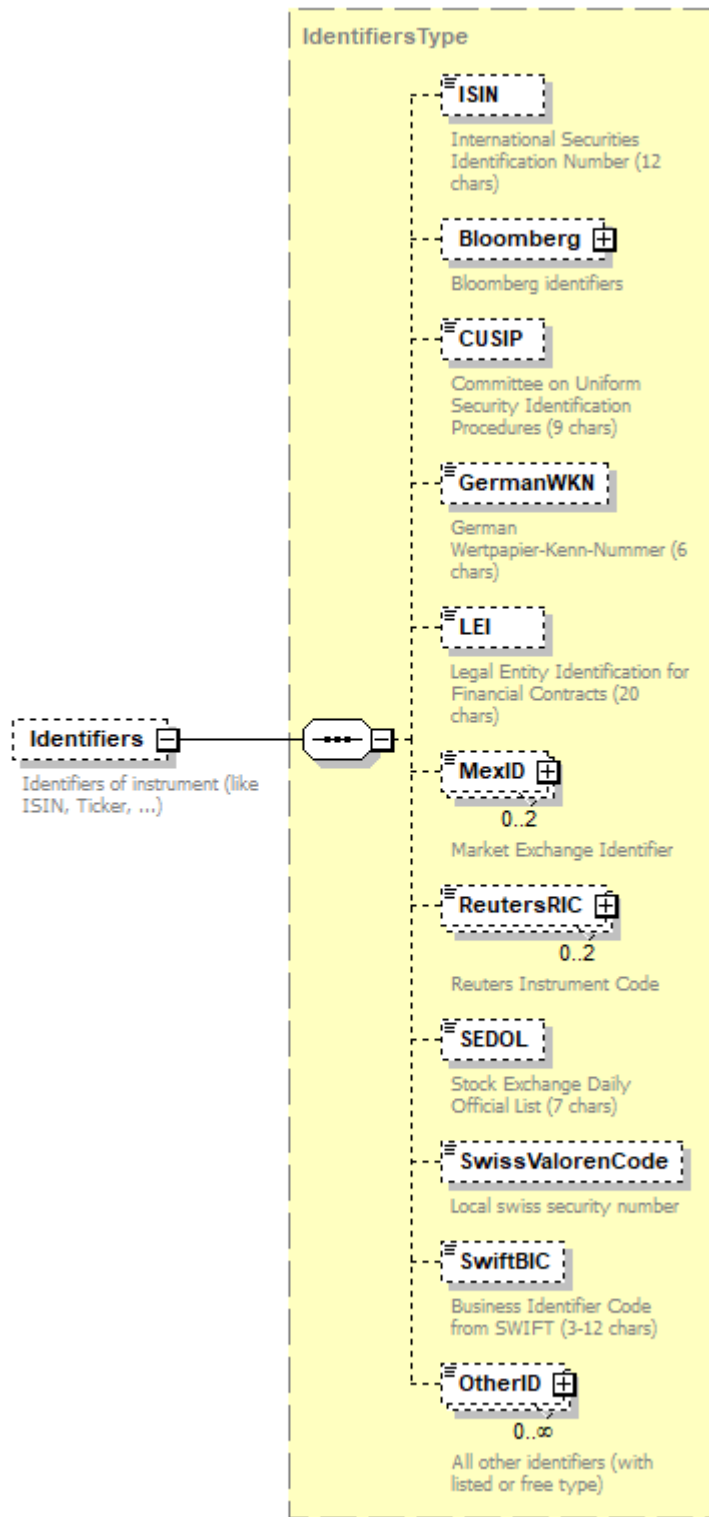

type [IdentifiersType](#)

properties  
 isRef 0  
 minOcc 0  
 maxOcc 1

|            |   |
|------------|---|
|            | content complex   |
| children   | <a href="#">ISIN</a> <a href="#">Bloomberg</a> <a href="#">CUSIP</a> <a href="#">GermanWKN</a> <a href="#">LEI</a> <a href="#">MexID</a> <a href="#">ReutersRIC</a> <a href="#">SEDOL</a> <a href="#">SwissValorenCode</a> <a href="#">SwiftBIC</a> <a href="#">OtherID</a> |
| annotation | documentation<br>Identifiers of instrument (like ISIN, Ticker, ...)<br>documentation<br>Kennnummern des Instrumentes (ISIN, Ticker, ...)  |

#### element **EarningType/EarningKind**

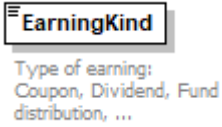
|            |  |
|------------|--|
| diagram    |   |
| type       | restriction of <b>xs:string</b>  |
| properties | isRef 0<br>content simple  |
| annotation | documentation<br>Type of earning:<br>Coupon, Dividend, Fund distribution, ...<br>documentation<br>Diese Bezeichnung ist aus dem Dictionary zu entnehmen. Gibt die Ertragsart an: z.B Coupon, Dividend, Fund distribution |

#### element **EarningType/ClosingDate**

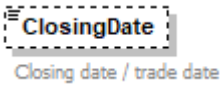
|            |  |
|------------|--|
| diagram    |                              |
| type       | <b>xs:date</b>   |
| properties | isRef 0<br>minOcc 0<br>maxOcc 1<br>content simple  |
| annotation | documentation<br>Closing date / trade date<br>documentation<br>Datum, an dem das Geschaeft abgeschlossen wurde |

#### element **EarningType/EntryDate**

|            |   |
|------------|---|
| diagram    |  |
| type       | <b>xs:date</b>  |
| properties | isRef 0<br>content simple   |
| annotation | documentation<br>Date when earning has been booked into portfolio                   |

element **EarningType/ValutaDate**

|            |   |
|------------|---|
| diagram    |  |
| type       | <b>xs:date</b>  |
| properties | isRef 0<br>minOcc 0<br>maxOcc 1<br>content simple                                 |
| annotation | documentation<br>Value date   |

element **EarningType/EntryCurrency**

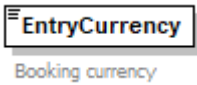
|            |   |
|------------|---|
| diagram    |  |
| type       | <a href="#">ISOCurrencyCodeType</a>   |
| properties | isRef 0<br>content simple   |
| facets     | Kind Value annotation<br>minLength 3<br>maxLength 3<br>pattern [A-Z]{3}           |
| annotation | documentation<br>Booking currency<br>documentation<br>Buchungswährung             |

element **EarningType/IncomeCurrency**

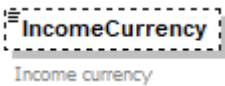
|            |   |
|------------|---|
| diagram    |  |
| type       | <a href="#">ISOCurrencyCodeType</a>   |
| properties | isRef 0<br>minOcc 0<br>maxOcc 1<br>content simple                                   |
| facets     | Kind Value annotation<br>minLength 3<br>maxLength 3<br>pattern [A-Z]{3}             |
| annotation | documentation<br>Income currency<br>documentation<br>Etragniswährung                |

element **EarningType/EntryValue**

|            |  |
|------------|--|
| diagram    | <p>The diagram shows an 'EntryValue' element with the text 'Booking value' below it. A line connects it to a dashed box labeled 'FundAmountType'. Inside this box, there is an 'Amount' element with '1..∞' below it and the text 'Amounts in currency as defined in attribute' below that. A connector symbol is between 'EntryValue' and the 'FundAmountType' box.</p> |
| type       | <a href="#">FundAmountType</a>   |
| properties | isRef 0<br>content complex   |
| children   | <a href="#">Amount</a>   |
| annotation | documentation<br>Booking value<br>documentation<br>Buchungsbetrag  |

element **EarningType/Interests**

|            |  |
|------------|--|
| diagram    | <p>The diagram shows an 'Interests' element with the text 'Interests value' below it. A line connects it to a dashed box labeled 'FundAmountType'. Inside this box, there is an 'Amount' element with '1..∞' below it and the text 'Amounts in currency as defined in attribute' below that. A connector symbol is between 'Interests' and the 'FundAmountType' box.</p> |
| type       | <a href="#">FundAmountType</a>   |
| properties | isRef 0<br>minOcc 0<br>maxOcc 1<br>content complex   |
| children   | <a href="#">Amount</a>   |
| annotation | documentation<br>Interests value   |

element **EarningType/FXRates**

|            |   |
|------------|---|
| diagram    | <p>The diagram shows an 'FXRates' element with the text 'FX Rates used for this earning' below it. A line connects it to a dashed box labeled 'FXRatesType'. Inside this box, there is an 'FXRate' element with '1..∞' below it. A connector symbol is between 'FXRates' and the 'FXRatesType' box.</p> |
| type       | <a href="#">FXRatesType</a>   |
| properties | isRef 0<br>minOcc 0<br>maxOcc 1<br>content complex  |
| children   | <a href="#">FXRate</a>  |
| annotation | documentation<br>FX Rates used for this earning   |

element **EarningType/NominalValueOrUnits**

|            |   |
|------------|---|
| diagram    |            |
| type       | <b>xs:decimal</b>   |
| properties | isRef 0<br>minOcc 0<br>maxOcc 1<br>content simple   |
| annotation | documentation<br><b>Nominal value / units</b><br>documentation<br><b>Stuecke / Nominale</b> |

element **EarningType/ReferenceNumber**

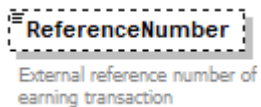
|            |   |
|------------|---|
| diagram    |    |
| type       | <a href="#">Text100Type</a>   |
| properties | isRef 0<br>minOcc 0<br>maxOcc 1<br>content simple   |
| facets     | Kind Value annotation<br>maxLength 100  |
| annotation | documentation<br><b>External reference number of earning transaction</b><br>documentation<br><b>Externe Referenznummer der Erträgnisbuchung</b> |

element **EarningType/AccountNumber**

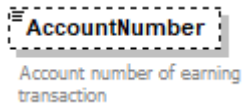
|            |   |
|------------|---|
| diagram    |                                        |
| type       | <b>xs:integer</b>   |
| properties | isRef 0<br>minOcc 0<br>maxOcc 1<br>content simple   |
| annotation | documentation<br><b>Account number of earning transaction</b><br>documentation<br><b>Kontonummer der Erträgnisbuchung</b> |

element **EarningType/PostingText**

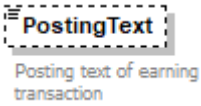
|            |  |
|------------|--|
| diagram    |                           |
| type       | <a href="#">Text1000Type</a>   |
| properties | isRef 0<br>minOcc 0<br>maxOcc 1<br>content simple  |
| facets     | Kind Value annotation<br>maxLength 1000  |
| annotation | documentation<br>Posting text of earning transaction<br>documentation<br>Buchungstext der Ertr gnisbuchung |

element **EarningType/FinallySettled**

|            |   |
|------------|---|
| diagram    |  |
| type       | <b>xs:boolean</b>   |
| properties | isRef 0<br>minOcc 0<br>maxOcc 1<br>content simple                                 |
| annotation | documentation<br>Earning finally settled or not                                   |

element **EarningType/Coupon**

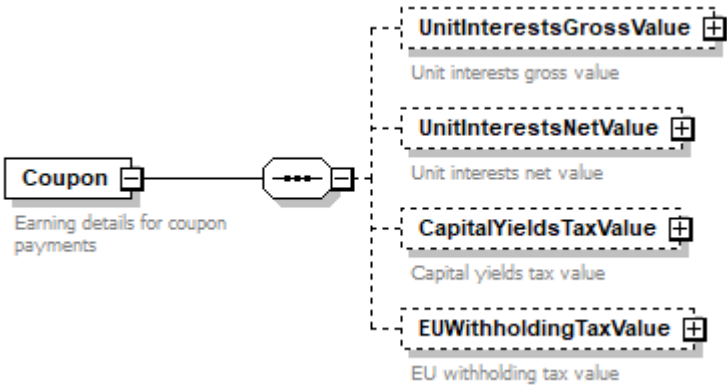
|            |   |
|------------|---|
| diagram    |   |
| properties | isRef 0<br>content complex  |
| children   | <a href="#">UnitInterestsGrossValue</a> <a href="#">UnitInterestsNetValue</a> <a href="#">CapitalYieldsTaxValue</a> <a href="#">EUWithholdingTaxValue</a> |
| annotation | documentation<br>Earning details for coupon payments<br>documentation<br>Ertr gnis vom Typ Kuponzahlung   |



element **EarningType/Coupon/UnitInterestsGrossValue**

|            |  |
|------------|--|
| diagram    | <p>The diagram illustrates the structure of the <b>UnitInterestsGrossValue</b> element. It is shown as a dashed box containing the text "Unit interests gross value". This element is connected to a <b>FundAmountType</b> container (yellow dashed box). Inside <b>FundAmountType</b>, there is an <b>Amount</b> element (white box with a plus sign) with the cardinality "1..∞" and the text "Amounts in currency as defined in attribute".</p> |
| type       | <a href="#">FundAmountType</a>   |
| properties | <ul style="list-style-type: none"> <li>isRef 0</li> <li>minOcc 0</li> <li>maxOcc 1</li> <li>content complex</li> </ul>   |
| children   | <a href="#">Amount</a>   |
| annotation | <ul style="list-style-type: none"> <li>documentation</li> <li>Unit interests gross value</li> <li>documentation</li> <li>Bruttostueckzinsen der Transaktion</li> </ul>   |

element **EarningType/Coupon/UnitInterestsNetValue**

|            |  |
|------------|--|
| diagram    | <p>The diagram illustrates the structure of the <b>UnitInterestsNetValue</b> element. It is shown as a dashed box containing the text "Unit interests net value". This element is connected to a <b>FundAmountType</b> container (yellow dashed box). Inside <b>FundAmountType</b>, there is an <b>Amount</b> element (white box with a plus sign) with the cardinality "1..∞" and the text "Amounts in currency as defined in attribute".</p> |
| type       | <a href="#">FundAmountType</a>   |
| properties | <ul style="list-style-type: none"> <li>isRef 0</li> <li>minOcc 0</li> <li>maxOcc 1</li> <li>content complex</li> </ul>   |
| children   | <a href="#">Amount</a>   |
| annotation | <ul style="list-style-type: none"> <li>documentation</li> <li>Unit interests net value</li> <li>documentation</li> <li>Nettostueckzinsen der Transaktion</li> </ul>  |

element **EarningType/Coupon/CapitalYieldsTaxValue**

|            |  |
|------------|--|
| diagram    | <p>The diagram illustrates the structure of the <b>CapitalYieldsTaxValue</b> element. It is shown as a dashed box containing the text "Capital yields tax value". This element is connected to a <b>FundAmountType</b> container (yellow dashed box). Inside <b>FundAmountType</b>, there is an <b>Amount</b> element (white box with a plus sign) with the cardinality "1..∞" and the text "Amounts in currency as defined in attribute".</p> |
| type       | <a href="#">FundAmountType</a>   |
| properties | <ul style="list-style-type: none"> <li>isRef 0</li> <li>minOcc 0</li> </ul>  |

|            |   |
|------------|---|
|            | maxOcc 1<br>content complex   |
| children   | <a href="#">Amount</a>  |
| annotation | documentation<br>Capital yields tax value<br>documentation<br>KESt-Betrag der Wertpapiertransaktion |

element **EarningType/Coupon/EUWithholdingTaxValue**

|            |   |
|------------|---|
| diagram    |   |
| type       | <a href="#">FundAmountType</a>  |
| properties | isRef 0<br>minOcc 0<br>maxOcc 1<br>content complex                                |
| children   | <a href="#">Amount</a>  |
| annotation | documentation<br>EU withholding tax value<br>documentation<br>Betrag der EU Quest |

element **EarningType/Dividend**

|         |  |
|---------|--|
| diagram |  |
|---------|--|

|            |  |
|------------|--|
| properties | isRef 0<br>content complex   |
| children   | <a href="#">DividendPerUnitValue</a> <a href="#">DividendGrossValue</a> <a href="#">DividendNetValue</a> <a href="#">WithholdingTaxValue</a> <a href="#">ExDay</a> <a href="#">PayDay</a><br><a href="#">WithholdingTaxQuota</a> |
| annotation | documentation<br>Earning details for dividend payments<br>documentation<br>Ertragnis vom Typ Dividendenzahlung  |

element **EarningType/Dividend/DividendPerUnitValue**

|            |   |
|------------|---|
| diagram    |   |
| type       | <a href="#">FundAmountType</a>  |
| properties | isRef 0<br>minOcc 0<br>maxOcc 1<br>content complex                                  |
| children   | <a href="#">Amount</a>  |
| annotation | documentation<br>Dividend value (per unit)<br>documentation<br>Dividende pro Stuck |

element **EarningType/Dividend/DividendGrossValue**

|            |  |
|------------|--|
| diagram    |  |
| type       | <a href="#">FundAmountType</a>   |
| properties | isRef 0<br>minOcc 0<br>maxOcc 1<br>content complex                                   |
| children   | <a href="#">Amount</a>   |
| annotation | documentation<br>Dividend gross value<br>documentation<br>Bruttobetrag der Dividende |

element **EarningType/Dividend/DividendNetValue**

|            |   |
|------------|---|
| diagram    |   |
| type       | <a href="#">FundAmountType</a>  |
| properties | isRef 0<br>minOcc 0<br>maxOcc 1<br>content complex                                |
| children   | <a href="#">Amount</a>  |
| annotation | documentation<br>Dividend net value<br>documentation<br>Nettobetrag der Dividende |

element **EarningType/Dividend/WithholdingTaxValue**

|            |   |
|------------|---|
| diagram    |   |
| type       | <a href="#">FundAmountType</a>  |
| properties | isRef 0<br>minOcc 0<br>maxOcc 1<br>content complex                      |
| children   | <a href="#">Amount</a>  |
| annotation | documentation<br>Withholding tax value<br>documentation<br>Quest Betrag |

element **EarningType/Dividend/ExDay**

|            |   |
|------------|---|
| diagram    |   |
| type       | <b>xs:date</b>  |
| properties | isRef 0<br>minOcc 0<br>maxOcc 1<br>content simple                           |
| annotation | documentation<br>Ex day of dividend<br>documentation<br>Extag der Dividende |

element **EarningType/Dividend/PayDay**

|            |  |
|------------|--|
| diagram    |             |
| type       | <b>xs:date</b>   |
| properties | isRef 0<br>minOcc 0<br>maxOcc 1<br>content simple  |
| annotation | documentation<br><b>Pay day of dividend</b><br>documentation<br>Auszahlungstag der Dividende |

element **EarningType/Dividend/WithholdingTaxQuota**

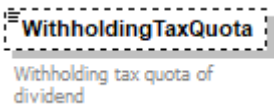
|            |  |
|------------|--|
| diagram    |                       |
| type       | <a href="#">PercentageType</a>   |
| properties | isRef 0<br>minOcc 0<br>maxOcc 1<br>content simple  |
| annotation | documentation<br><b>Withholding tax quota of dividend</b><br>documentation<br>Quest-Satz der Dividende |

element **EarningType/FundDistribution**

|                   |   |
|-------------------|---|
| <p>diagram</p>    |   |
| <p>properties</p> | <p>isRef 0<br/>content complex</p>  |
| <p>children</p>   | <p><a href="#">PayoutPerUnitValue</a> <a href="#">PayoutGrossValue</a> <a href="#">CapitalYieldsTaxUnitValue</a> <a href="#">CapitalYieldsTaxOverallValue</a> <a href="#">EUWithholdingTaxUnitValue</a> <a href="#">EUWithholdingTaxOverallValue</a> <a href="#">PayoutIdenticEarningsValue</a> <a href="#">ExDay</a></p> |
| <p>annotation</p> | <p>documentation<br/>Earning details for fund distributions<br/>documentation<br/>Erträgnis vom Typ Fondsausschüttung</p>   |

element **EarningType/FundDistribution/PayoutPerUnitValue**

|                   |  |
|-------------------|--|
| <p>diagram</p>    |  |
| <p>type</p>       | <p><a href="#">FundAmountType</a></p>                              |
| <p>properties</p> | <p>isRef 0<br/>minOcc 0<br/>maxOcc 1<br/>content complex</p>       |
| <p>children</p>   | <p><a href="#">Amount</a></p>                                      |
| <p>annotation</p> | <p>documentation<br/>Payout value (per unit)<br/>documentation</p> |

|  |                         |
|--|-------------------------|
|  | Ausschüttung pro Stueck |
|--|-------------------------|

element **EarningType/FundDistribution/PayoutGrossValue**

|            |   |
|------------|---|
| diagram    | <p>The diagram shows a dashed box labeled 'PayoutGrossValue' with the text 'Payout gross value of distribution' below it. This box is connected to a larger dashed box labeled 'FundAmountType'. Inside the 'FundAmountType' box, there is a box labeled 'Amount' with '1..∞' below it and 'Amounts in currency as defined in attribute' below that. The connection between the two boxes is a line with a small square on the 'PayoutGrossValue' side and a small circle with three dots on the 'FundAmountType' side.</p> |
| type       | <a href="#">FundAmountType</a>  |
| properties | isRef 0<br>minOcc 0<br>maxOcc 1<br>content complex  |
| children   | <a href="#">Amount</a>  |
| annotation | documentation<br>Payout gross value of distribution<br>documentation<br>Brutto-Ausschüttungsbetrag  |

element **EarningType/FundDistribution/CapitalYieldsTaxUnitValue**

|            |  |
|------------|--|
| diagram    | <p>The diagram shows a dashed box labeled 'CapitalYieldsTaxUnitValue' with the text 'Capital yields tax value (per unit)' below it. This box is connected to a larger dashed box labeled 'FundAmountType'. Inside the 'FundAmountType' box, there is a box labeled 'Amount' with '1..∞' below it and 'Amounts in currency as defined in attribute' below that. The connection between the two boxes is a line with a small square on the 'CapitalYieldsTaxUnitValue' side and a small circle with three dots on the 'FundAmountType' side.</p> |
| type       | <a href="#">FundAmountType</a>   |
| properties | isRef 0<br>minOcc 0<br>maxOcc 1<br>content complex   |
| children   | <a href="#">Amount</a>   |
| annotation | documentation<br>Capital yields tax value (per unit)<br>documentation<br>KEST-Betrag der Ausschüttung (pro Stück)  |

element **EarningType/FundDistribution/CapitalYieldsTaxOverallValue**

|         |  |
|---------|--|
| diagram | <p>The diagram shows a dashed box labeled 'CapitalYieldsTaxOverallValue' with the text 'Total capital yields tax value (per unit)' below it. This box is connected to a larger dashed box labeled 'FundAmountType'. Inside the 'FundAmountType' box, there is a box labeled 'Amount' with '1..∞' below it and 'Amounts in currency as defined in attribute' below that. The connection between the two boxes is a line with a small square on the 'CapitalYieldsTaxOverallValue' side and a small circle with three dots on the 'FundAmountType' side.</p> |
|---------|--|

|            |   |
|------------|---|
| type       | <a href="#">FundAmountType</a>  |
| properties | isRef 0<br>minOcc 0<br>maxOcc 1<br>content complex  |
| children   | <a href="#">Amount</a>  |
| annotation | documentation<br>Total capital yields tax value (per unit)<br>documentation<br>KESt-Gesamtbetrag der Ausschüttung (pro Stück) |

element **EarningType/FundDistribution/EUWithholdingTaxUnitValue**

|            |  |
|------------|--|
| diagram    |  |
| type       | <a href="#">FundAmountType</a>   |
| properties | isRef 0<br>minOcc 0<br>maxOcc 1<br>content complex   |
| children   | <a href="#">Amount</a>   |
| annotation | documentation<br>EU withholding tax value (per unit)<br>documentation<br>EU-Quest Betrag pro Stück |

element **EarningType/FundDistribution/EUWithholdingTaxOverallValue**

|            |   |
|------------|---|
| diagram    |   |
| type       | <a href="#">FundAmountType</a>  |
| properties | isRef 0<br>minOcc 0<br>maxOcc 1<br>content complex  |
| children   | <a href="#">Amount</a>  |
| annotation | documentation<br>Total EU withholding tax value<br>documentation<br>EU Quest Gesamtbetrag |



element **EarningType/FundDistribution/PayoutIdenticEarningsValue**

|            |   |
|------------|---|
| diagram    |   |
| type       | <a href="#">FundAmountType</a>  |
| properties | isRef 0<br>minOcc 0<br>maxOcc 1<br>content complex  |
| children   | <a href="#">Amount</a>  |
| annotation | documentation<br>Payout identic earnings value<br>documentation<br>Ausschüttungsgleicher Ertrag |

element **EarningType/FundDistribution/ExDay**

|            |  |
|------------|--|
| diagram    |  |
| type       | <b>xs:date</b>   |
| properties | isRef 0<br>minOcc 0<br>maxOcc 1<br>content simple                                  |
| annotation | documentation<br>Ex day of distribution<br>documentation<br>Extag der Ausschüttung |

complexType **TransactionsType**

|          |  |
|----------|--|
| diagram  |  |
| children | <a href="#">Transaction</a>                        |
| used by  | element <a href="#">PortfolioType/Transactions</a> |

attribute **TransactionsType/@from**

|      |                |
|------|----------------|
| type | <b>xs:date</b> |
|------|----------------|

|            |         |
|------------|---------|
| properties | isRef 0 |
|------------|---------|

attribute **TransactionsType/@to**

|            |                |
|------------|----------------|
| type       | <b>xs:date</b> |
| properties | isRef 0        |

# element TransactionsType/Transaction

diagram

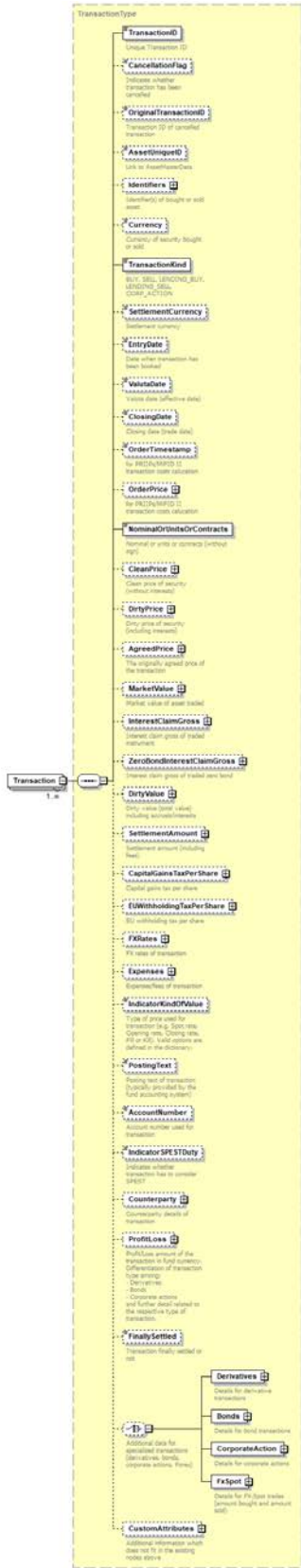

|            |   |
|------------|---|
| type       | <a href="#"><u>TransactionType</u></a>  |
| properties | isRef 0<br>minOcc 1<br>maxOcc unbounded<br>content complex  |
| children   | <a href="#"><u>TransactionID</u></a> <a href="#"><u>CancellationFlag</u></a> <a href="#"><u>OriginalTransactionID</u></a> <a href="#"><u>AssetUniqueID</u></a> <a href="#"><u>Identifiers</u></a> <a href="#"><u>Currency</u></a> <a href="#"><u>TransactionKind</u></a><br><a href="#"><u>SettlementCurrency</u></a> <a href="#"><u>EntryDate</u></a> <a href="#"><u>ValutaDate</u></a> <a href="#"><u>ClosingDate</u></a> <a href="#"><u>OrderTimestamp</u></a> <a href="#"><u>OrderPrice</u></a> <a href="#"><u>NominalOrUnitsOrContracts</u></a><br><a href="#"><u>CleanPrice</u></a> <a href="#"><u>DirtyPrice</u></a> <a href="#"><u>AgreedPrice</u></a> <a href="#"><u>MarketValue</u></a> <a href="#"><u>InterestClaimGross</u></a> <a href="#"><u>ZeroBondInterestClaimGross</u></a> <a href="#"><u>DirtyValue</u></a><br><a href="#"><u>SettlementAmount</u></a> <a href="#"><u>CapitalGainsTaxPerShare</u></a> <a href="#"><u>EUWithholdingTaxPerShare</u></a> <a href="#"><u>FXRates</u></a> <a href="#"><u>Expenses</u></a> <a href="#"><u>IndicatorKindOfValue</u></a><br><a href="#"><u>PostingText</u></a> <a href="#"><u>AccountNumber</u></a> <a href="#"><u>IndicatorSPESTDuty</u></a> <a href="#"><u>Counterparty</u></a> <a href="#"><u>ProfitLoss</u></a> <a href="#"><u>FinallySettled</u></a> <a href="#"><u>Derivatives</u></a> <a href="#"><u>Bonds</u></a><br><a href="#"><u>CorporateAction</u></a> <a href="#"><u>FxSpot</u></a> <a href="#"><u>CustomAttributes</u></a> |

complexType **TransactionType**

diagram

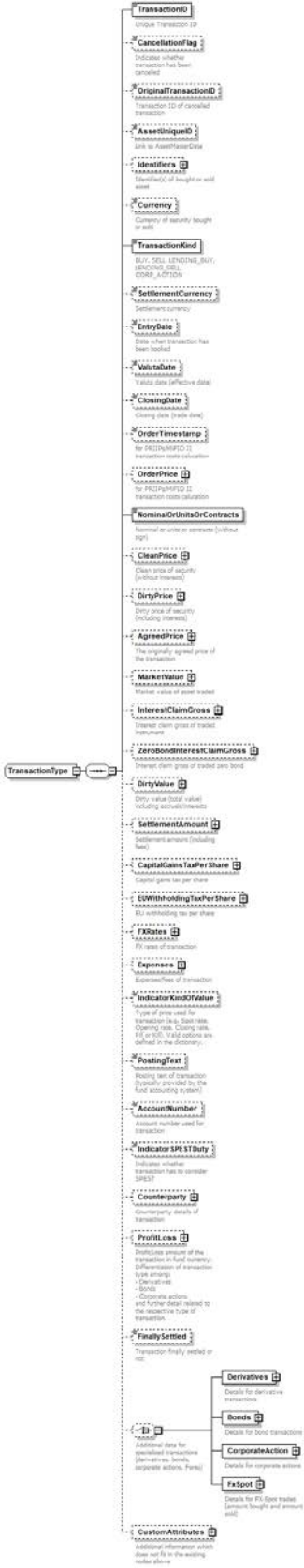

|          |  |
|----------|--|
| children | <a href="#">TransactionID</a> <a href="#">CancellationFlag</a> <a href="#">OriginalTransactionID</a> <a href="#">AssetUniqueID</a> <a href="#">Identifiers</a> <a href="#">Currency</a> <a href="#">TransactionKind</a> <a href="#">SettlementCurrency</a> <a href="#">EntryDate</a> <a href="#">ValutaDate</a> <a href="#">ClosingDate</a> <a href="#">OrderTimestamp</a> <a href="#">OrderPrice</a> <a href="#">NominalOrUnitsOrContracts</a> <a href="#">CleanPrice</a> <a href="#">DirtyPrice</a> <a href="#">AgreedPrice</a> <a href="#">MarketValue</a> <a href="#">InterestClaimGross</a> <a href="#">ZeroBondInterestClaimGross</a> <a href="#">DirtyValue</a> <a href="#">SettlementAmount</a> <a href="#">CapitalGainsTaxPerShare</a> <a href="#">EUWithholdingTaxPerShare</a> <a href="#">FXRates</a> <a href="#">Expenses</a> <a href="#">IndicatorKindOfValue</a> <a href="#">PostingText</a> <a href="#">AccountNumber</a> <a href="#">IndicatorSPESTDuty</a> <a href="#">Counterparty</a> <a href="#">ProfitLoss</a> <a href="#">FinallySettled</a> <a href="#">Derivatives</a> <a href="#">Bonds</a> <a href="#">CorporateAction</a> <a href="#">FxSpot</a> <a href="#">CustomAttributes</a> |
| used by  | element <a href="#">TransactionsType/Transaction</a>   |

#### element [TransactionType/TransactionID](#)

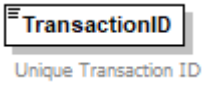
|            |  |
|------------|--|
| diagram    |         |
| type       | <a href="#">Text256Type</a>  |
| properties | isRef 0<br>content simple  |
| facets     | Kind Value annotation<br>maxLength 256   |
| annotation | documentation<br>Unique Transaction ID<br>documentation<br>Eindeutige Transaktionsnummer |

#### element [TransactionType/CancellationFlag](#)

|            |  |
|------------|--|
| diagram    |   |
| type       | <b>xs:boolean</b>  |
| properties | isRef 0<br>minOcc 0<br>maxOcc 1<br>content simple  |
| annotation | documentation<br>Indicates whether transaction has been cancelled<br>documentation<br>Kennzeichen ob die Transaktion storniert wurde |

#### element [TransactionType/OriginalTransactionID](#)

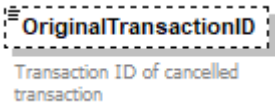
|            |   |
|------------|---|
| diagram    |  |
| type       | <a href="#">Text256Type</a>   |
| properties | isRef 0<br>minOcc 0<br>maxOcc 1<br>content simple                                   |
| facets     | Kind Value annotation<br>maxLength 256  |
| annotation | documentation<br>Transaction ID of cancelled transaction                            |

element **TransactionType/AssetUniqueID**

|            |  |
|------------|--|
| diagram    |                         |
| type       | restriction of <b>xs:IDREF</b>   |
| properties | isRef 0<br>minOcc 0<br>maxOcc 1<br>content simple  |
| facets     | Kind Value annotation<br><b>maxLength</b> 256  |
| annotation | documentation<br><b>Link to AssetMasterData</b><br>documentation<br>Referenz zu den Wertpapierstammdaten |



element **TransactionType/Identifiers**

diagram

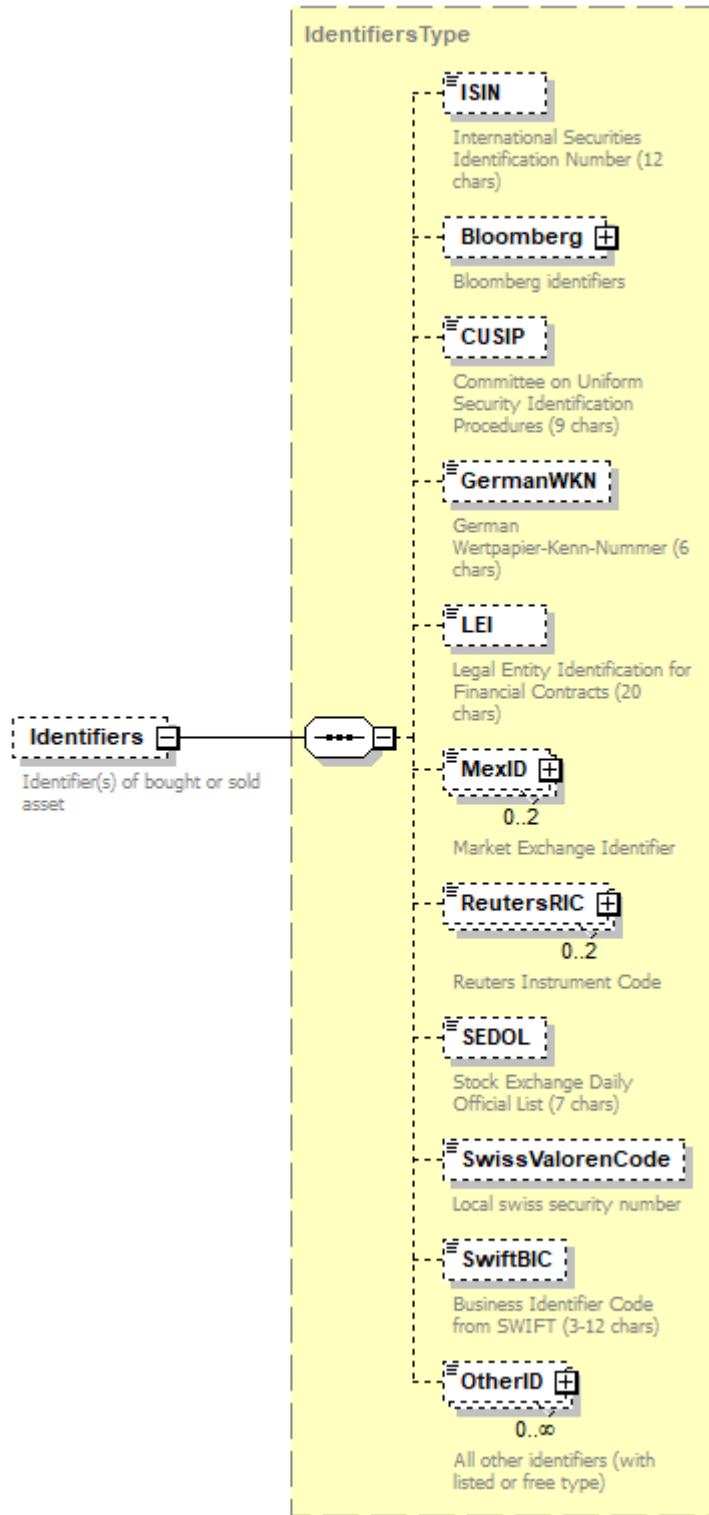

type [IdentifiersType](#)

properties  
 isRef 0  
 minOcc 0  
 maxOcc 1

|            |   |
|------------|---|
|            | content complex   |
| children   | <a href="#">ISIN</a> <a href="#">Bloomberg</a> <a href="#">CUSIP</a> <a href="#">GermanWKN</a> <a href="#">LEI</a> <a href="#">MexID</a> <a href="#">ReutersRIC</a> <a href="#">SEDOL</a> <a href="#">SwissValorenCode</a> <a href="#">SwiftBIC</a> <a href="#">OtherID</a> |
| annotation | documentation<br>Identifier(s) of bought or sold asset  |

#### element **TransactionType/Currency**

|            |   |            |       |            |           |   |  |           |   |  |         |          |  |
|------------|---|------------|-------|------------|-----------|---|--|-----------|---|--|---------|----------|--|
| diagram    |   |            |       |            |           |   |  |           |   |  |         |          |  |
| type       | <a href="#">ISOCurrencyCodeType</a>   |            |       |            |           |   |  |           |   |  |         |          |  |
| properties | isRef 0<br>minOcc 0<br>maxOcc 1<br>content simple   |            |       |            |           |   |  |           |   |  |         |          |  |
| facets     | <table border="0"> <tr> <td>Kind</td> <td>Value</td> <td>annotation</td> </tr> <tr> <td>minLength</td> <td>3</td> <td></td> </tr> <tr> <td>maxLength</td> <td>3</td> <td></td> </tr> <tr> <td>pattern</td> <td>[A-Z]{3}</td> <td></td> </tr> </table> | Kind       | Value | annotation | minLength | 3 |  | maxLength | 3 |  | pattern | [A-Z]{3} |  |
| Kind       | Value   | annotation |       |            |           |   |  |           |   |  |         |          |  |
| minLength  | 3   |            |       |            |           |   |  |           |   |  |         |          |  |
| maxLength  | 3   |            |       |            |           |   |  |           |   |  |         |          |  |
| pattern    | [A-Z]{3}  |            |       |            |           |   |  |           |   |  |         |          |  |
| annotation | documentation<br>Currency of security bought or sold  |            |       |            |           |   |  |           |   |  |         |          |  |

#### element **TransactionType/TransactionKind**

|            |   |
|------------|---|
| diagram    |   |
| type       | restriction of <b>xs:string</b>   |
| properties | isRef 0<br>content simple   |
| annotation | documentation<br>BUY, SELL, LENDING_BUY, LENDING_SELL, CORP_ACTION<br>documentation<br>BUY, SELL, LENDING_BUY, LENDING_SELL |

#### element **TransactionType/SettlementCurrency**

|            |   |            |       |            |           |   |  |           |   |  |         |          |  |
|------------|---|------------|-------|------------|-----------|---|--|-----------|---|--|---------|----------|--|
| diagram    |   |            |       |            |           |   |  |           |   |  |         |          |  |
| type       | <a href="#">ISOCurrencyCodeType</a>   |            |       |            |           |   |  |           |   |  |         |          |  |
| properties | isRef 0<br>minOcc 0<br>maxOcc 1<br>content simple   |            |       |            |           |   |  |           |   |  |         |          |  |
| facets     | <table border="0"> <tr> <td>Kind</td> <td>Value</td> <td>annotation</td> </tr> <tr> <td>minLength</td> <td>3</td> <td></td> </tr> <tr> <td>maxLength</td> <td>3</td> <td></td> </tr> <tr> <td>pattern</td> <td>[A-Z]{3}</td> <td></td> </tr> </table> | Kind       | Value | annotation | minLength | 3 |  | maxLength | 3 |  | pattern | [A-Z]{3} |  |
| Kind       | Value   | annotation |       |            |           |   |  |           |   |  |         |          |  |
| minLength  | 3   |            |       |            |           |   |  |           |   |  |         |          |  |
| maxLength  | 3   |            |       |            |           |   |  |           |   |  |         |          |  |
| pattern    | [A-Z]{3}  |            |       |            |           |   |  |           |   |  |         |          |  |
| annotation | documentation<br>Settlement currency  |            |       |            |           |   |  |           |   |  |         |          |  |

|  |                                     |
|--|-------------------------------------|
|  | documentation<br>Abrechnungswährung |
|--|-------------------------------------|

### element **TransactionType/EntryDate**

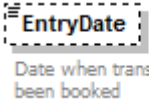
|            |  |
|------------|--|
| diagram    |         |
| type       | <b>xs:date</b>   |
| properties | isRef 0<br>minOcc 0<br>maxOcc 1<br>content simple  |
| annotation | documentation<br>Date when transaction has been booked<br>documentation<br>Buchungsdatum |

### element **TransactionType/ValutaDate**

|            |   |
|------------|---|
| diagram    |          |
| type       | <b>xs:date</b>  |
| properties | isRef 0<br>minOcc 0<br>maxOcc 1<br>content simple   |
| annotation | documentation<br>Valuta date (effective date)<br>documentation<br>Gibt das Valutadatum an |

### element **TransactionType/ClosingDate**

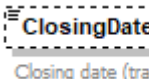
|            |   |
|------------|---|
| diagram    |    |
| type       | <b>xs:date</b>  |
| properties | isRef 0<br>minOcc 0<br>maxOcc 1<br>content simple   |
| annotation | documentation<br>Closing date (trade date)<br>documentation<br>Gibt das Datum an, an dem das Geschaefts abgeschlossen wurde |

### element **TransactionType/OrderTimestamp**

|         |   |
|---------|---|
| diagram |  |
|---------|---|

|            |  |
|------------|--|
| type       | <b>xs:dateTime</b>   |
| properties | isRef 0<br>minOcc 0<br>maxOcc 1<br>content simple                  |
| annotation | documentation<br>for PRIIPs/MiFID II transaction costs calculation |

### element TransactionType/OrderPrice

|            |  |
|------------|--|
| diagram    |  |
| type       | <a href="#">AmountType</a>   |
| properties | isRef 0<br>minOcc 0<br>maxOcc 1<br>content complex                 |
| children   | <a href="#">Amount</a>   |
| annotation | documentation<br>for PRIIPs/MiFID II transaction costs calculation |

### element TransactionType/NominalOrUnitsOrContracts

|            |   |
|------------|---|
| diagram    |   |
| type       | <b>xs:decimal</b>   |
| properties | isRef 0<br>content simple   |
| annotation | documentation<br>Nominal or units or contracts (without sign)<br>documentation<br>Gibt die Stuecke oder Nominale oder Kontraktzahl an (ohne Vorzeichen) |

### element TransactionType/CleanPrice

|            |                                |
|------------|--------------------------------|
| diagram    |                                |
| type       | <a href="#">FundAmountType</a> |
| properties | isRef 0<br>minOcc 0            |

|            |  |
|------------|--|
|            | maxOcc 1<br>content complex                                  |
| children   | <a href="#">Amount</a>                                       |
| annotation | documentation<br>Clean price of security (without interests) |

element **TransactionType/DirtyPrice**

|            |  |
|------------|--|
| diagram    |  |
| type       | <a href="#">FundAmountType</a>                                 |
| properties | isRef 0<br>minOcc 0<br>maxOcc 1<br>content complex             |
| children   | <a href="#">Amount</a>   |
| annotation | documentation<br>Dirty price of security (including interests) |

element **TransactionType/AgreedPrice**

|            |   |
|------------|---|
| diagram    |   |
| type       | <a href="#">FundAmountType</a>                                  |
| properties | isRef 0<br>minOcc 0<br>maxOcc 1<br>content complex              |
| children   | <a href="#">Amount</a>  |
| annotation | documentation<br>The originally agreed price of the transaction |

element **TransactionType/MarketValue**

|            |   |
|------------|---|
| diagram    | <p>The diagram shows a dashed box labeled 'MarketValue' with the text 'Market value of asset traded' below it. A line connects this box to a larger dashed box labeled 'FundAmountType'. Inside the 'FundAmountType' box, there is a smaller box labeled 'Amount' with '1..∞' below it and 'Amounts in currency as defined in attribute' below that. The 'FundAmountType' box also contains a small diagram of a connector.</p> |
| type       | <a href="#">FundAmountType</a>  |
| properties | isRef 0<br>minOcc 0<br>maxOcc 1<br>content complex  |
| children   | <a href="#">Amount</a>  |
| annotation | documentation<br>Market value of asset traded<br>documentation<br>Kurswert des gehandelten Instruments  |

element **TransactionType/InterestClaimGross**

|            |   |
|------------|---|
| diagram    | <p>The diagram shows a dashed box labeled 'InterestClaimGross' with the text 'Interest claim gross of traded instrument' below it. A line connects this box to a larger dashed box labeled 'FundAmountType'. Inside the 'FundAmountType' box, there is a smaller box labeled 'Amount' with '1..∞' below it and 'Amounts in currency as defined in attribute' below that. The 'FundAmountType' box also contains a small diagram of a connector.</p> |
| type       | <a href="#">FundAmountType</a>  |
| properties | isRef 0<br>minOcc 0<br>maxOcc 1<br>content complex  |
| children   | <a href="#">Amount</a>  |
| annotation | documentation<br>Interest claim gross of traded instrument<br>documentation<br>Brutto-Zinsanspruch des gehandelten Wertpapiers/Derivates/Geldes   |

element **TransactionType/ZeroBondInterestClaimGross**

|            |  |
|------------|--|
| diagram    | <p>The diagram shows a dashed box labeled 'ZeroBondInterestClaimGross' with the text 'Interest claim gross of traded zero bond' below it. A line connects this box to a larger dashed box labeled 'FundAmountType'. Inside the 'FundAmountType' box, there is a smaller box labeled 'Amount' with '1..∞' below it and 'Amounts in currency as defined in attribute' below that. The 'FundAmountType' box also contains a small diagram of a connector.</p> |
| type       | <a href="#">FundAmountType</a>   |
| properties | isRef 0<br>minOcc 0  |

|            |   |
|------------|---|
|            | maxOcc 1<br>content complex   |
| children   | <a href="#">Amount</a>  |
| annotation | documentation<br>Interest claim gross of traded zero bond<br>documentation<br>Brutto-Zinsanspruch der Null-Coupon-Anleihe |

### element TransactionType/DirtyValue

|            |  |
|------------|--|
| diagram    |  |
| type       | <a href="#">FundAmountType</a>   |
| properties | isRef 0<br>minOcc 0<br>maxOcc 1<br>content complex   |
| children   | <a href="#">Amount</a>   |
| annotation | documentation<br>Dirty value (total value) including accruals/interests<br>documentation<br>Gesamtwert des gehandelten Instrumentes (Kurswert plus Ansprüche/Zinsen) |

### element TransactionType/SettlementAmount

|            |  |
|------------|--|
| diagram    |  |
| type       | <a href="#">FundAmountType</a>   |
| properties | isRef 0<br>minOcc 0<br>maxOcc 1<br>content complex   |
| children   | <a href="#">Amount</a>   |
| annotation | documentation<br>Settlement amount (including fees)<br>documentation<br>Buchungsbetrag (enthält auch die Spesen) |

element **TransactionType/CapitalGainsTaxPerShare**

|            |   |
|------------|---|
| diagram    |   |
| type       | <a href="#">FundAmountType</a>  |
| properties | <ul style="list-style-type: none"> <li>isRef 0</li> <li>minOcc 0</li> <li>maxOcc 1</li> <li>content complex</li> </ul>  |
| children   | <a href="#">Amount</a>  |
| annotation | <ul style="list-style-type: none"> <li>documentation</li> <li>Capital gains tax per share</li> <li>documentation</li> <li>Gibt die KEST pro Stueck des Subfonds an</li> </ul> |

element **TransactionType/EUWithholdingTaxPerShare**

|            |   |
|------------|---|
| diagram    |   |
| type       | <a href="#">FundAmountType</a>  |
| properties | <ul style="list-style-type: none"> <li>isRef 0</li> <li>minOcc 0</li> <li>maxOcc 1</li> <li>content complex</li> </ul>  |
| children   | <a href="#">Amount</a>  |
| annotation | <ul style="list-style-type: none"> <li>documentation</li> <li>EU withholding tax per share</li> <li>documentation</li> <li>Gibt die EU Quest pro Stueck an</li> </ul> |

element **TransactionType/FXRates**

|            |  |
|------------|--|
| diagram    |  |
| type       | <a href="#">FXRatesType</a>  |
| properties | <ul style="list-style-type: none"> <li>isRef 0</li> <li>minOcc 0</li> <li>maxOcc 1</li> <li>content complex</li> </ul> |



|            |   |
|------------|---|
| children   | <a href="#">FXRate</a>  |
| annotation | documentation<br>FX rates of transaction<br>documentation<br>Devisenkurse der Transaktion |

### element **TransactionType/Expenses**

|            |  |
|------------|--|
| diagram    |  |
| type       | <a href="#">FundAmountType</a>   |
| properties | isRef 0<br>minOcc 0<br>maxOcc 1<br>content complex                                       |
| children   | <a href="#">Amount</a>   |
| annotation | documentation<br>Expenses/fees of transaction<br>documentation<br>Spesen der Transaktion |

### element **TransactionType/IndicatorKindOfValue**

|            |   |
|------------|---|
| diagram    |   |
| type       | <b>xs:string</b>  |
| properties | isRef 0<br>minOcc 0<br>maxOcc 1<br>content simple   |
| annotation | documentation<br>Type of price used for transaction (e.g. Spot rate, Opening rate, Closing rate, Fill or Kill). Valid options are defined in the dictionary.<br>documentation<br>Gibt die Art des Kurses an der bei der Wertpapiertransaktion verwendet wurde(wie z.B. Spot rate, Opening rate, Closing rate, Fill or Kill). Diese Bezeichnung ist aus dem Dictionary zu entnehmen. |

### element **TransactionType/PostingText**

|         |                             |
|---------|-----------------------------|
| diagram |                             |
| type    | <a href="#">Text256Type</a> |

|            |   |
|------------|---|
| properties | isRef 0<br>minOcc 0<br>maxOcc 1<br>content simple   |
| facets     | Kind Value annotation<br>maxLength 256  |
| annotation | documentation<br>Posting text of transaction (typically provided by the fund accounting system)<br>documentation<br>Buchungstext der Transaktion (üblicherweise vom Fondsbuchhaltungssystem zur Verfügung gestellt) |

#### element TransactionType/AccountNumber

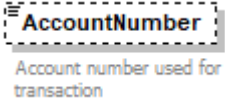
|            |   |
|------------|---|
| diagram    |    |
| type       | <b>xs:integer</b>   |
| properties | isRef 0<br>minOcc 0<br>maxOcc 1<br>content simple   |
| annotation | documentation<br>Account number used for transaction<br>documentation<br>Gibt das bei der Transaktion verwendete Konto an |

#### element TransactionType/IndicatorSPESTDuty

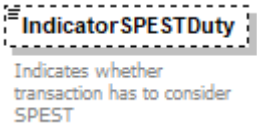
|            |   |
|------------|---|
| diagram    |    |
| type       | <b>xs:boolean</b>   |
| properties | isRef 0<br>minOcc 0<br>maxOcc 1<br>content simple   |
| annotation | documentation<br>Indicates whether transaction has to consider SPEST<br>documentation<br>Gibt an ob das Geschaefit SPEST-Pflichtig ist<br>(Boolean: true / false) |

element **TransactionType/Counterparty**

|                   |   |
|-------------------|---|
| <p>diagram</p>    | <p>The diagram illustrates the structure of the <b>Counterparty</b> element. On the left, a dashed box labeled <b>Counterparty</b> contains the text "Counterparty details of transaction". A line connects this to a central connector box, which in turn connects to a large yellow dashed box labeled <b>CompanyType</b>. Inside <b>CompanyType</b>, the following elements are listed:</p> <ul style="list-style-type: none"> <li><b>Identifiers</b> (+): Identifiers of company</li> <li><b>Name</b>: Name of company</li> <li><b>LegalName</b> (-): Legal (full) name of company</li> <li><b>LegalForm</b> (-): Legal form of company</li> <li><b>Address</b> (+): Address of company</li> <li><b>BusinessCountry</b> (-): Country code of main business of company</li> <li><b>ParentCompany</b> (+): Parent company (if applicable)</li> <li><b>OtherClassification</b> (+): All other identifiers (with listed or free type) 0..∞</li> </ul> |
| <p>type</p>       | <p><a href="#">CompanyType</a></p>  |
| <p>properties</p> | <p>isRef 0<br/> minOcc 0<br/> maxOcc 1<br/> content complex</p>   |
| <p>children</p>   | <p><a href="#">Identifiers</a> <a href="#">Name</a> <a href="#">LegalName</a> <a href="#">LegalForm</a> <a href="#">Address</a> <a href="#">BusinessCountry</a> <a href="#">ParentCompany</a> <a href="#">OtherClassification</a></p>   |
| <p>annotation</p> | <p>documentation<br/> Counterparty details of transaction<br/> documentation<br/> Kontrahent der Transaktion</p>  |

### element TransactionType/ProfitLoss

|            |   |
|------------|---|
| diagram    | <p><b>ProfitLoss</b><br/>Profit/Loss amount of the transaction in fund currency. Differentiation of transaction type among:<br/>- Derivatives<br/>- Bonds<br/>- Corporate actions<br/>and further detail related to the respective type of transaction.</p> <p><b>FundAmountType</b><br/>Amounts in currency as defined in attribute<br/>1..∞</p> |
| type       | <a href="#">FundAmountType</a>  |
| properties | isRef 0<br>minOcc 0<br>maxOcc 1<br>content complex  |
| children   | <a href="#">Amount</a>  |
| annotation | documentation<br>Profit/Loss amount of the transaction in fund currency. Differentiation of transaction type among:<br>- Derivatives<br>- Bonds<br>- Corporate actions<br>and further detail related to the respective type of transaction.<br>documentation<br>Zeigt den Gewinn/Verlust der Transaktion in Fondswaehrung                         |

### element TransactionType/FinallySettled

|            |   |
|------------|---|
| diagram    | <p><b>FinallySettled</b><br/>Transaction finally settled or not</p> |
| type       | <b>xs:boolean</b>   |
| properties | isRef 0<br>minOcc 0<br>maxOcc 1<br>content simple                   |
| annotation | documentation<br>Transaction finally settled or not                 |

### element TransactionType/Derivatives

|         |  |
|---------|--|
| diagram | <p><b>Derivatives</b><br/>Details for derivative transactions</p> <p><b>HedgingFlag</b><br/>Enthaelt das Kennzeichen, ob das Geschaefit zur Absicherung oder zur Spekulationszwecken gemacht wurde</p> <p><b>OpenCloseCash</b><br/>Enthaelt das Kennzeichen, ob es sich bei dem Geschaefit um ein Opening, Closing oder Barausgleich handelt</p> |
|---------|--|

|            |   |
|------------|---|
| properties | isRef 0<br>content complex                                |
| children   | <a href="#">HedgingFlag</a> <a href="#">OpenCloseCash</a> |
| annotation | documentation<br>Details for derivative transactions      |

element **TransactionType/Derivatives/HedgingFlag**

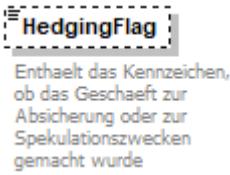
|            |   |
|------------|---|
| diagram    |                                        |
| type       | <b>xs:boolean</b>   |
| properties | isRef 0<br>minOcc 0<br>maxOcc 1<br>content simple   |
| annotation | documentation<br>Enthaelt das Kennzeichen, ob das Geschaefit zur Absicherung oder zur Spekulationszwecken gemacht wurde |

element **TransactionType/Derivatives/OpenCloseCash**

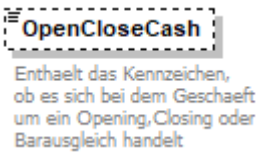
|            |   |
|------------|---|
| diagram    |   |
| type       | restriction of <b>xs:string</b>   |
| properties | isRef 0<br>minOcc 0<br>maxOcc 1<br>content simple   |
| annotation | documentation<br>Enthaelt das Kennzeichen, ob es sich bei dem Geschaefit um ein Opening,Closing oder Barausgleich handelt |

## element TransactionType/Bonds

diagram



### UnitInterests +

Zeigt die BruttostueckZinsen der Transaktion

### UnitInterestsDays

Zeigt die StueckZinstage der Transaktion

### CapitalYieldsTaxValue +

Gibt die KESSt Betrag der Transaktion an

### CapitalYieldsTaxZeroValue +

Gibt den KESSt-Betrag fuer Zerobonds an

### EUWithholdingTaxValue +

Gibt den EU Quest Betrag an

### EUWithholdingTaxZeroValue +

Gibt den EU Quest Zero Bond Betrag an

### EUWithholdingTaxInterests +

Gibt den EU Quest Zinsanteil an

### Poolfactor

Gibt den Poolfaktor der Wertpapiertransaktion

### IndexRatio

Gibt die Hoehe des Index-Ratio der Rente an

### IndexBondAccrual +

Gibt den Buchungsbedingten Abgrenzungsbetrag fuer Indexanleihen an

### InflationaryAdjustment +

Gibt den Inflationsausgleich an

### EntryConditionalInflationaryAdj... +

Buchungsbedingter Inflationsausgleich

### EntryConditionalIndexBondAccr...

Gibt den Buchungsbedingten Abgrenzungsbetrag fuer Indexanleihen an

### ExCouponFlag

Enthaelt das Kennzeichen, ob die Wertpapiertransaktion ohne Kupon abgerechnet wird

|            |  |
|------------|--|
| properties | isRef 0<br>content complex   |
| children   | <a href="#">UnitInterests</a> <a href="#">UnitInterestsDays</a> <a href="#">CapitalYieldsTaxValue</a> <a href="#">CapitalYieldsTaxZeroValue</a> <a href="#">EUWithholdingTaxValue</a> <a href="#">EUWithholdingTaxZeroValue</a> <a href="#">EUWithholdingTaxInterests</a> <a href="#">Poolfactor</a> <a href="#">IndexRatio</a> <a href="#">IndexBondAccrual</a> <a href="#">InflationaryAdjustment</a> <a href="#">EntryConditionalInflationaryAdjustment</a> <a href="#">EntryConditionalIndexBondAccrual</a> <a href="#">ExCouponFlag</a> |
| annotation | documentation<br>Details for bond transactions   |

### element TransactionType/Bonds/UnitInterests

|            |   |
|------------|---|
| diagram    |   |
| type       | <a href="#">FundAmountType</a>                                |
| properties | isRef 0<br>minOcc 0<br>maxOcc 1<br>content complex            |
| children   | <a href="#">Amount</a>  |
| annotation | documentation<br>Zeigt die BruttostueckZinsen der Transaktion |

### element TransactionType/Bonds/UnitInterestsDays

|            |   |
|------------|---|
| diagram    |   |
| type       | <b>xs:integer</b>   |
| properties | isRef 0<br>minOcc 0<br>maxOcc 1<br>content simple         |
| annotation | documentation<br>Zeigt die StueckZinstage der Transaktion |

### element TransactionType/Bonds/CapitalYieldsTaxValue

|            |                                |
|------------|--------------------------------|
| diagram    |                                |
| type       | <a href="#">FundAmountType</a> |
| properties | isRef 0<br>minOcc 0            |

|            |  |
|------------|--|
|            | maxOcc 1<br>content complex                              |
| children   | <a href="#">Amount</a>                                   |
| annotation | documentation<br>Gibt die KEST Betrag der Transaktion an |

element **TransactionType/Bonds/CapitalYieldsTaxZeroValue**

|            |   |
|------------|---|
| diagram    |   |
| type       | <a href="#">FundAmountType</a>                          |
| properties | isRef 0<br>minOcc 0<br>maxOcc 1<br>content complex      |
| children   | <a href="#">Amount</a>                                  |
| annotation | documentation<br>Gibt den KEST-Betrag fuer Zerobonds an |

element **TransactionType/Bonds/EUWithholdingTaxValue**

|            |  |
|------------|--|
| diagram    |  |
| type       | <a href="#">FundAmountType</a>                     |
| properties | isRef 0<br>minOcc 0<br>maxOcc 1<br>content complex |
| children   | <a href="#">Amount</a>                             |
| annotation | documentation<br>Gibt den EU Quest Betrag an       |



element **TransactionType/Bonds/EUWithholdingTaxZeroValue**

|            |  |
|------------|--|
| diagram    |  |
| type       | <a href="#">FundAmountType</a>                         |
| properties | isRef 0<br>minOcc 0<br>maxOcc 1<br>content complex     |
| children   | <a href="#">Amount</a>                                 |
| annotation | documentation<br>Gibt den EU Quest Zero Bond Betrag an |

element **TransactionType/Bonds/EUWithholdingTaxInterests**

|            |  |
|------------|--|
| diagram    |  |
| type       | <a href="#">FundAmountType</a>                     |
| properties | isRef 0<br>minOcc 0<br>maxOcc 1<br>content complex |
| children   | <a href="#">Amount</a>                             |
| annotation | documentation<br>Gibt den EU Quest Zinsanteil an   |

element **TransactionType/Bonds/Poolfactor**

|            |  |
|------------|--|
| diagram    |  |
| type       | <b>xs:decimal</b>  |
| properties | isRef 0<br>minOcc 0<br>maxOcc 1<br>content simple              |
| annotation | documentation<br>Gibt den Poolfaktor der Wertpapiertransaktion |

element **TransactionType/Bonds/IndexRatio**

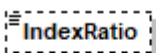
|            |  |
|------------|--|
| diagram    |  <p><b>IndexRatio</b><br/>Gibt die Hoehe des Index-Ratio der Rente an</p> |
| type       | <b>xs:decimal</b>  |
| properties | isRef 0<br>minOcc 0<br>maxOcc 1<br>content simple  |
| annotation | documentation<br>Gibt die Hoehe des Index-Ratio der Rente an   |

element **TransactionType/Bonds/IndexBondAccrual**

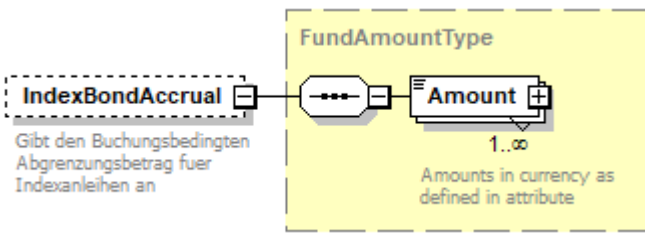
|            |  |
|------------|--|
| diagram    |  <p><b>IndexBondAccrual</b><br/>Gibt den Buchungsbedingten Abgrenzungsbetrag fuer Indexanleihen an</p> <p><b>FundAmountType</b></p> <p><b>Amount</b><br/>1..∞<br/>Amounts in currency as defined in attribute</p> |
| type       | <a href="#">FundAmountType</a>   |
| properties | isRef 0<br>minOcc 0<br>maxOcc 1<br>content complex   |
| children   | <a href="#">Amount</a>   |
| annotation | documentation<br>Gibt den Buchungsbedingten Abgrenzungsbetrag fuer Indexanleihen an  |

element **TransactionType/Bonds/InflationaryAdjustment**

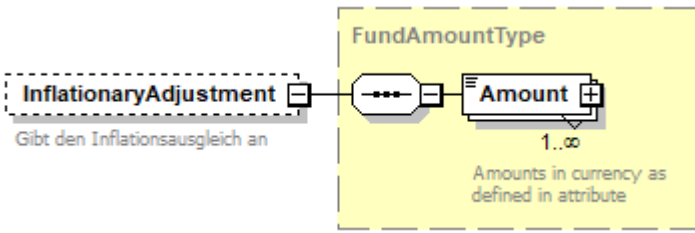
|            |   |
|------------|---|
| diagram    |  <p><b>InflationaryAdjustment</b><br/>Gibt den Inflationsausgleich an</p> <p><b>FundAmountType</b></p> <p><b>Amount</b><br/>1..∞<br/>Amounts in currency as defined in attribute</p> |
| type       | <a href="#">FundAmountType</a>  |
| properties | isRef 0<br>minOcc 0<br>maxOcc 1<br>content complex  |
| children   | <a href="#">Amount</a>  |
| annotation | documentation<br>Gibt den Inflationsausgleich an  |

element **TransactionType/Bonds/EntryConditionalInflationaryAdjustment**

|            |   |
|------------|---|
| diagram    |   |
| type       | <a href="#">FundAmountType</a>                        |
| properties | isRef 0<br>minOcc 0<br>maxOcc 1<br>content complex    |
| children   | <a href="#">Amount</a>                                |
| annotation | documentation<br>Buchungbedingter Inflationsausgleich |

element **TransactionType/Bonds/EntryConditionalIndexBondAccrual**

|            |   |
|------------|---|
| diagram    |   |
| type       | <b>xs:decimal</b>   |
| properties | isRef 0<br>minOcc 0<br>maxOcc 1<br>content simple                                   |
| annotation | documentation<br>Gibt den Buchungsbedingten Abgrenzungsbetrag fuer Indexanleihen an |

element **TransactionType/Bonds/ExCouponFlag**

|            |   |
|------------|---|
| diagram    |   |
| type       | <b>xs:boolean</b>   |
| properties | isRef 0<br>minOcc 0<br>maxOcc 1<br>content simple   |
| annotation | documentation<br>Enthaelt das Kennzeichen, ob die Wertpapiertransaktion ohne Kupon abgerechnet wird |

element **TransactionType/CorporateAction**

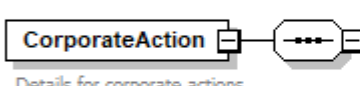
|                   |   |
|-------------------|---|
| <p>diagram</p>    |  <p><b>CorporateAction</b><br/>Details for corporate actions</p> <ul style="list-style-type: none"> <li><b>from</b> <math>0..∞</math><br/>Source security of corporate action</li> <li><b>to</b> <math>0..∞</math><br/>Destination securities of corporate action</li> <li><b>CorporateActionKind</b><br/>S = Split<br/>RS = Reversesplit<br/>M = Merger<br/>SD = Stock dividend<br/>NSinS = New Shares in Shares<br/>DEM = Demerger<br/>RI = Rights issue<br/>ESC = Exchange of share certificate<br/>CD = Capital Decrease<br/>GenM = General Meetings</li> <li><b>ExDividendDate</b><br/>Ex dividend day of the corporate action</li> <li><b>ExpensesValutaDate</b><br/>Valuta day of expenses</li> <li><b>ExpensesExchangeRate</b><br/>Exchange rate applied for expenses</li> <li><b>Expenses</b> <br/>Expenses in fund and/or foreign currency</li> <li><b>AccountNumberExpenses</b><br/>Account number used for booking of expenses</li> <li><b>UnitInterestEUWithholdingTax</b> <br/>Unit interests to be used for calculating EU withholding tax</li> <li><b>CorporateActionDocument</b> <br/>Text document describing details of corporate action</li> </ul> |
| <p>properties</p> | <p>isRef 0<br/>content complex</p>  |
| <p>children</p>   | <p><a href="#">from</a> <a href="#">to</a> <a href="#">CorporateActionKind</a> <a href="#">ExDividendDate</a> <a href="#">ExpensesValutaDate</a> <a href="#">ExpensesExchangeRate</a> <a href="#">Expenses</a> <a href="#">AccountNumberExpenses</a> <a href="#">UnitInterestEUWithholdingTax</a> <a href="#">CorporateActionDocument</a></p>   |
| <p>annotation</p> | <p>documentation<br/>Details for corporate actions</p>  |



# element TransactionType/CorporateAction/from

diagram

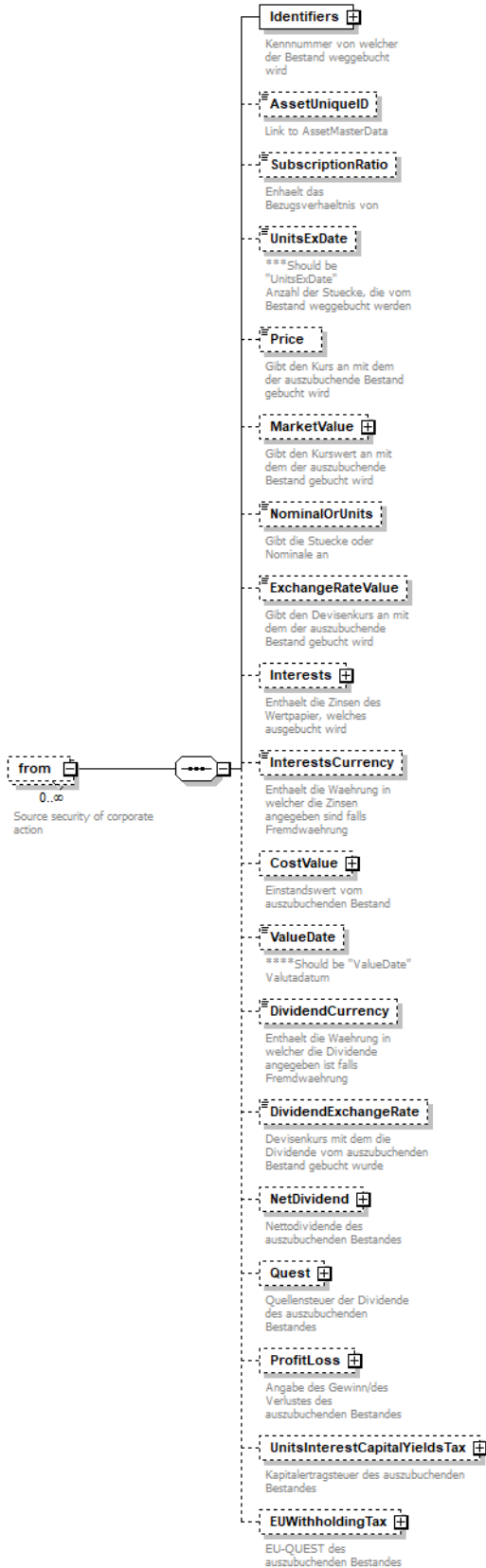

|            |  |
|------------|--|
| properties | isRef 0<br>minOcc 0<br>maxOcc unbounded<br>content complex   |
| children   | <a href="#">Identifiers</a> <a href="#">AssetUniqueID</a> <a href="#">SubscriptionRatio</a> <a href="#">UnitsExDate</a> <a href="#">Price</a> <a href="#">MarketValue</a> <a href="#">NominalOrUnits</a> <a href="#">ExchangeRateValue</a><br><a href="#">Interests</a> <a href="#">InterestsCurrency</a> <a href="#">CostValue</a> <a href="#">ValueDate</a> <a href="#">DividendCurrency</a> <a href="#">DividendExchangeRate</a> <a href="#">NetDividend</a> <a href="#">Quest</a><br><a href="#">ProfitLoss</a> <a href="#">UnitsInterestCapitalYieldsTax</a> <a href="#">EUWithholdingTax</a> |
| annotation | documentation<br>Source security of corporate action   |

element **TransactionType/CorporateAction/from/Identifiers**

diagram

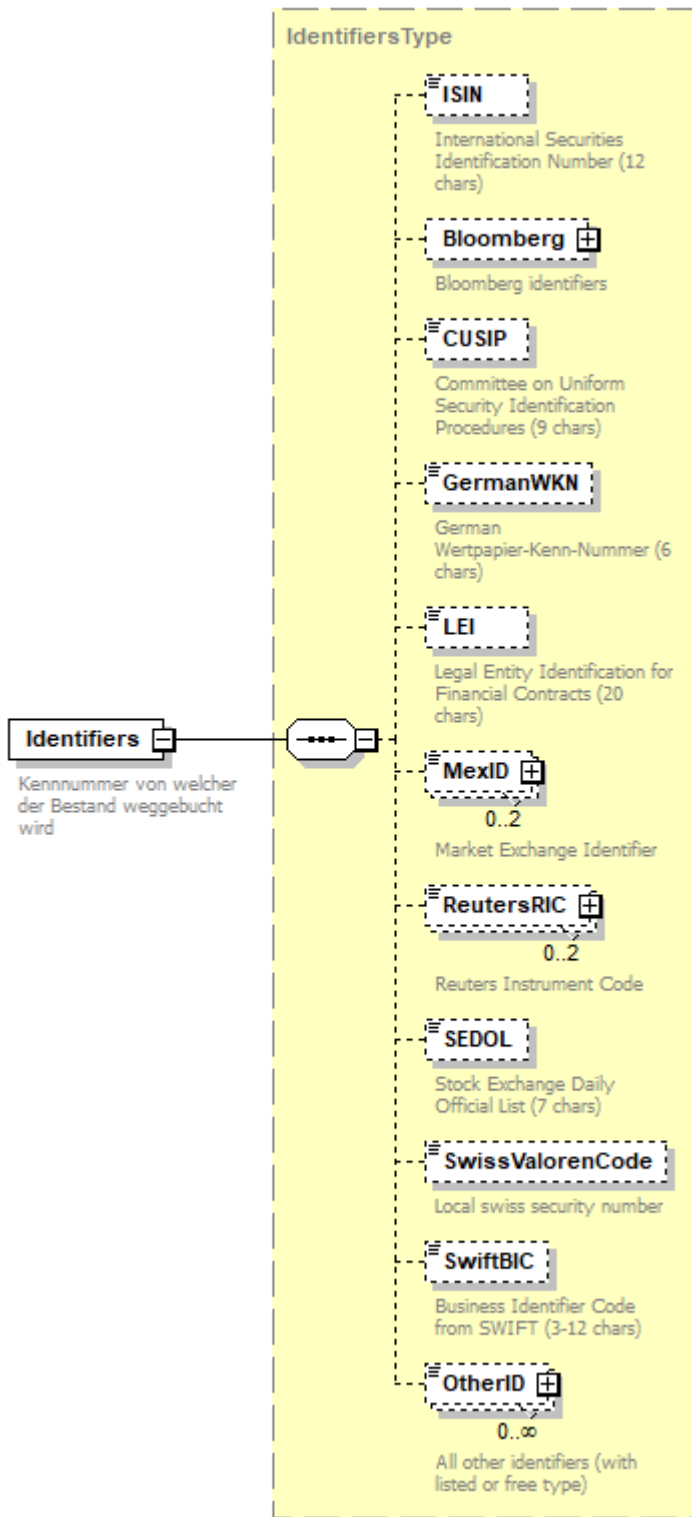

|            |   |
|------------|---|
| type       | <a href="#">IdentifiersType</a>   |
| properties | isRef 0<br>content complex  |
| children   | <a href="#">ISIN</a> <a href="#">Bloomberg</a> <a href="#">CUSIP</a> <a href="#">GermanWKN</a> <a href="#">LEI</a> <a href="#">MexID</a> <a href="#">ReutersRIC</a> <a href="#">SEDOL</a> <a href="#">SwissValorenCode</a> <a href="#">SwiftBIC</a> <a href="#">OtherID</a> |



|            |   |
|------------|---|
| annotation | documentation<br>Kennnummer von welcher der Bestand weggebucht wird |
|------------|---|

element **TransactionType/CorporateAction/from/AssetUniqueID**

|            |   |
|------------|---|
| diagram    |                  |
| type       | restriction of <b>xs:IDREF</b>  |
| properties | isRef 0<br>minOcc 0<br>maxOcc 1<br>content simple   |
| facets     | Kind Value annotation<br>maxLength 256  |
| annotation | documentation<br>Link to AssetMasterData<br>documentation<br>Referenz zu den Wertpapierstammdaten |

element **TransactionType/CorporateAction/from/SubscriptionRatio**

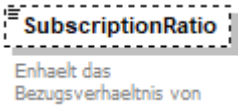
|            |   |
|------------|---|
| diagram    |  |
| type       | <b>xs:decimal</b>   |
| properties | isRef 0<br>minOcc 0<br>maxOcc 1<br>content simple                                 |
| annotation | documentation<br>Enhaelt das Bezugsverhaeltnis von                                |

element **TransactionType/CorporateAction/from/UnitsExDate**

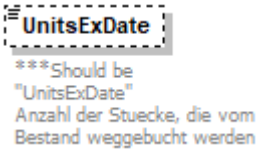
|            |  |
|------------|--|
| diagram    |                   |
| type       | <b>xs:decimal</b>  |
| properties | isRef 0<br>minOcc 0<br>maxOcc 1<br>content simple  |
| annotation | documentation<br>***Should be "UnitsExDate"<br>Anzahl der Stuecke, die vom Bestand weggebucht werden |

element **TransactionType/CorporateAction/from/Price**

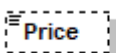
|            |  |
|------------|--|
| diagram    |  <p>Gibt den Kurs an mit dem der auszubuchende Bestand gebucht wird</p> |
| type       | <b>xs:decimal</b>  |
| properties | isRef 0<br>minOcc 0<br>maxOcc 1<br>content simple  |
| annotation | documentation<br>Gibt den Kurs an mit dem der auszubuchende Bestand gebucht wird   |

element **TransactionType/CorporateAction/from/MarketValue**

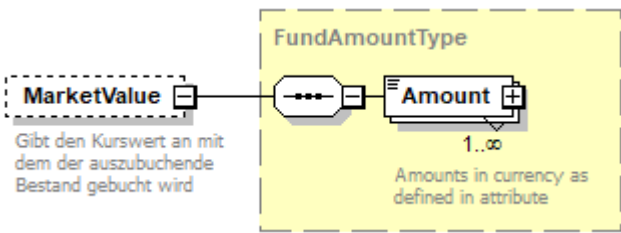
|            |  |
|------------|--|
| diagram    |     |
| type       | <a href="#">FundAmountType</a>   |
| properties | isRef 0<br>minOcc 0<br>maxOcc 1<br>content complex                                   |
| children   | <a href="#">Amount</a>   |
| annotation | documentation<br>Gibt den Kurswert an mit dem der auszubuchende Bestand gebucht wird |

element **TransactionType/CorporateAction/from/NominalOrUnits**

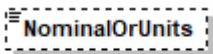
|            |  |
|------------|--|
| diagram    |  <p>Gibt die Stuecke oder Nominale an</p> |
| type       | <b>xs:decimal</b>  |
| properties | isRef 0<br>minOcc 0<br>maxOcc 1<br>content simple  |
| annotation | documentation<br>Gibt die Stuecke oder Nominale an   |

element **TransactionType/CorporateAction/from/ExchangeRateValue**

|         |   |
|---------|---|
| diagram |  <p>Gibt den Devisenkurs an mit dem der auszubuchende Bestand gebucht wird</p> |
|---------|---|

|            |   |
|------------|---|
| type       | <b>xs:decimal</b>   |
| properties | isRef 0<br>minOcc 0<br>maxOcc 1<br>content simple                                       |
| annotation | documentation<br>Gibt den Devisenkurs an mit dem der auszubuchende Bestand gebucht wird |

**element TransactionType/CorporateAction/from/Interests**

|            |   |
|------------|---|
| diagram    |   |
| type       | <a href="#">FundAmountType</a>  |
| properties | isRef 0<br>minOcc 0<br>maxOcc 1<br>content complex                          |
| children   | <a href="#">Amount</a>  |
| annotation | documentation<br>Enthält die Zinsen des Wertpapier, welches ausgebucht wird |

**element TransactionType/CorporateAction/from/InterestsCurrency**

|            |   |
|------------|---|
| diagram    |   |
| type       | <a href="#">ISOCurrencyCodeType</a>   |
| properties | isRef 0<br>minOcc 0<br>maxOcc 1<br>content simple   |
| facets     | Kind Value annotation<br>minLength 3<br>maxLength 3<br>pattern [A-Z]{3}                       |
| annotation | documentation<br>Enthält die Waehrung in welcher die Zinsen angegeben sind falls Fremdwahrung |

element **TransactionType/CorporateAction/from/CostValue**

|            |  |
|------------|--|
| diagram    | <p>The diagram shows a dashed box labeled <b>CostValue</b> with the text "Einstandswert vom auszubuchenden Bestand" below it. To its right is a solid box labeled <b>Amount</b> with "1..∞" below it and "Amounts in currency as defined in attribute" below that. Both boxes are connected to a central box labeled <b>FundAmountType</b> which is highlighted in yellow.</p> |
| type       | <a href="#">FundAmountType</a>   |
| properties | <ul style="list-style-type: none"> <li>isRef 0</li> <li>minOcc 0</li> <li>maxOcc 1</li> <li>content complex</li> </ul>   |
| children   | <a href="#">Amount</a>   |
| annotation | <ul style="list-style-type: none"> <li>documentation</li> <li>Einstandswert vom auszubuchenden Bestand</li> </ul>  |

element **TransactionType/CorporateAction/from/ValueDate**

|            |  |
|------------|--|
| diagram    | <p>The diagram shows a dashed box labeled <b>ValueDate</b> with the text "****Should be "ValueDate" Valutadatum" below it.</p> |
| type       | <b>xs:date</b>   |
| properties | <ul style="list-style-type: none"> <li>isRef 0</li> <li>minOcc 0</li> <li>maxOcc 1</li> <li>content simple</li> </ul>          |
| annotation | <ul style="list-style-type: none"> <li>documentation</li> <li>****Should be "ValueDate"</li> <li>Valutadatum</li> </ul>        |

element **TransactionType/CorporateAction/from/DividendCurrency**

|            |   |
|------------|---|
| diagram    | <p>The diagram shows a dashed box labeled <b>DividendCurrency</b> with the text "Enthaelt die Waehrung in welcher die Dividende angegeben ist falls Fremdwahrung" below it.</p> |
| type       | <a href="#">ISOCurrencyCodeType</a>   |
| properties | <ul style="list-style-type: none"> <li>isRef 0</li> <li>minOcc 0</li> <li>maxOcc 1</li> <li>content simple</li> </ul>   |
| facets     | <ul style="list-style-type: none"> <li>Kind Value annotation</li> <li>minLength 3</li> <li>maxLength 3</li> <li>pattern [A-Z]{3}</li> </ul>                                     |
| annotation | <ul style="list-style-type: none"> <li>documentation</li> <li>Enthaelt die Waehrung in welcher die Dividende angegeben ist falls Fremdwahrung</li> </ul>                        |

element **TransactionType/CorporateAction/from/DividendExchangeRate**

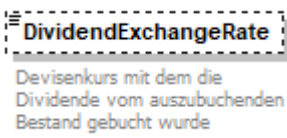
|            |   |
|------------|---|
| diagram    |  <p><b>DividendExchangeRate</b><br/>Devisenkurs mit dem die Dividende vom auszubuchenden Bestand gebucht wurde</p> |
| type       | <b>xs:decimal</b>   |
| properties | isRef 0<br>minOcc 0<br>maxOcc 1<br>content simple   |
| annotation | documentation<br>Devisenkurs mit dem die Dividende vom auszubuchenden Bestand gebucht wurde   |

element **TransactionType/CorporateAction/from/NetDividend**

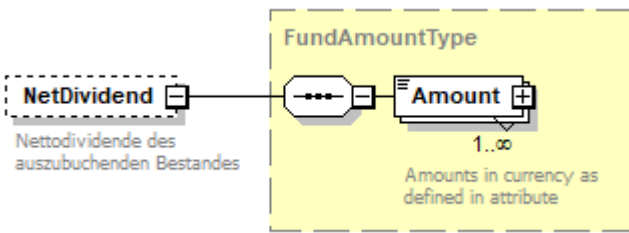
|            |  |
|------------|--|
| diagram    |  <p><b>NetDividend</b><br/>Nettodividende des auszubuchenden Bestandes</p> <p><b>FundAmountType</b></p> <p><b>Amount</b><br/>1..∞<br/>Amounts in currency as defined in attribute</p> |
| type       | <a href="#">FundAmountType</a>   |
| properties | isRef 0<br>minOcc 0<br>maxOcc 1<br>content complex   |
| children   | <a href="#">Amount</a>   |
| annotation | documentation<br>Nettodividende des auszubuchenden Bestandes   |

element **TransactionType/CorporateAction/from/Quest**

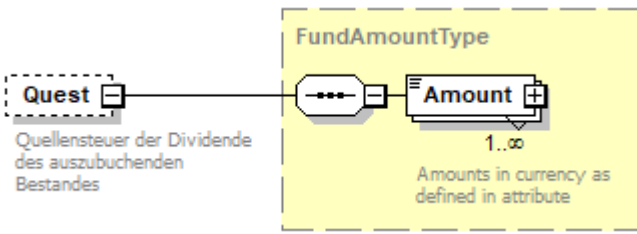
|            |   |
|------------|---|
| diagram    |  <p><b>Quest</b><br/>Quellensteuer der Dividende des auszubuchenden Bestandes</p> <p><b>FundAmountType</b></p> <p><b>Amount</b><br/>1..∞<br/>Amounts in currency as defined in attribute</p> |
| type       | <a href="#">FundAmountType</a>  |
| properties | isRef 0<br>minOcc 0<br>maxOcc 1<br>content complex  |
| children   | <a href="#">Amount</a>  |
| annotation | documentation<br>Quellensteuer der Dividende des auszubuchenden Bestandes   |

element **TransactionType/CorporateAction/from/ProfitLoss**

|            |  |
|------------|--|
| diagram    | <p>The diagram shows a dashed box labeled 'ProfitLoss' with the text 'Angabe des Gewinn/des Verlustes des auszubuchenden Bestandes'. A line connects it to a 'FundAmountType' box. Inside 'FundAmountType', there is an 'Amount' element with a multiplicity of '1..∞' and the text 'Amounts in currency as defined in attribute'.</p> |
| type       | <a href="#">FundAmountType</a>   |
| properties | <ul style="list-style-type: none"> <li>isRef 0</li> <li>minOcc 0</li> <li>maxOcc 1</li> <li>content complex</li> </ul>   |
| children   | <a href="#">Amount</a>   |
| annotation | <p>documentation<br/>Angabe des Gewinn/des Verlustes des auszubuchenden Bestandes</p>  |

element **TransactionType/CorporateAction/from/UnitsInterestCapitalYieldsTax**

|            |   |
|------------|---|
| diagram    | <p>The diagram shows a dashed box labeled 'UnitsInterestCapitalYieldsTax' with the text 'Kapitalertragsteuer des auszubuchenden Bestandes'. A line connects it to a 'FundAmountType' box. Inside 'FundAmountType', there is an 'Amount' element with a multiplicity of '1..∞' and the text 'Amounts in currency as defined in attribute'.</p> |
| type       | <a href="#">FundAmountType</a>  |
| properties | <ul style="list-style-type: none"> <li>isRef 0</li> <li>minOcc 0</li> <li>maxOcc 1</li> <li>content complex</li> </ul>  |
| children   | <a href="#">Amount</a>  |
| annotation | <p>documentation<br/>Kapitalertragsteuer des auszubuchenden Bestandes</p>   |

element **TransactionType/CorporateAction/from/EUWithholdingTax**

|            |   |
|------------|---|
| diagram    | <p>The diagram shows a dashed box labeled 'EUWithholdingTax' with the text 'EU-QUEST des auszubuchenden Bestandes'. A line connects it to a 'FundAmountType' box. Inside 'FundAmountType', there is an 'Amount' element with a multiplicity of '1..∞' and the text 'Amounts in currency as defined in attribute'.</p> |
| type       | <a href="#">FundAmountType</a>  |
| properties | <ul style="list-style-type: none"> <li>isRef 0</li> <li>minOcc 0</li> <li>maxOcc 1</li> <li>content complex</li> </ul>  |
| children   | <a href="#">Amount</a>  |

annotation

documentation

EU-QUEST des auszubuchenden Bestandes

element **TransactionType/CorporateAction/to**

diagram

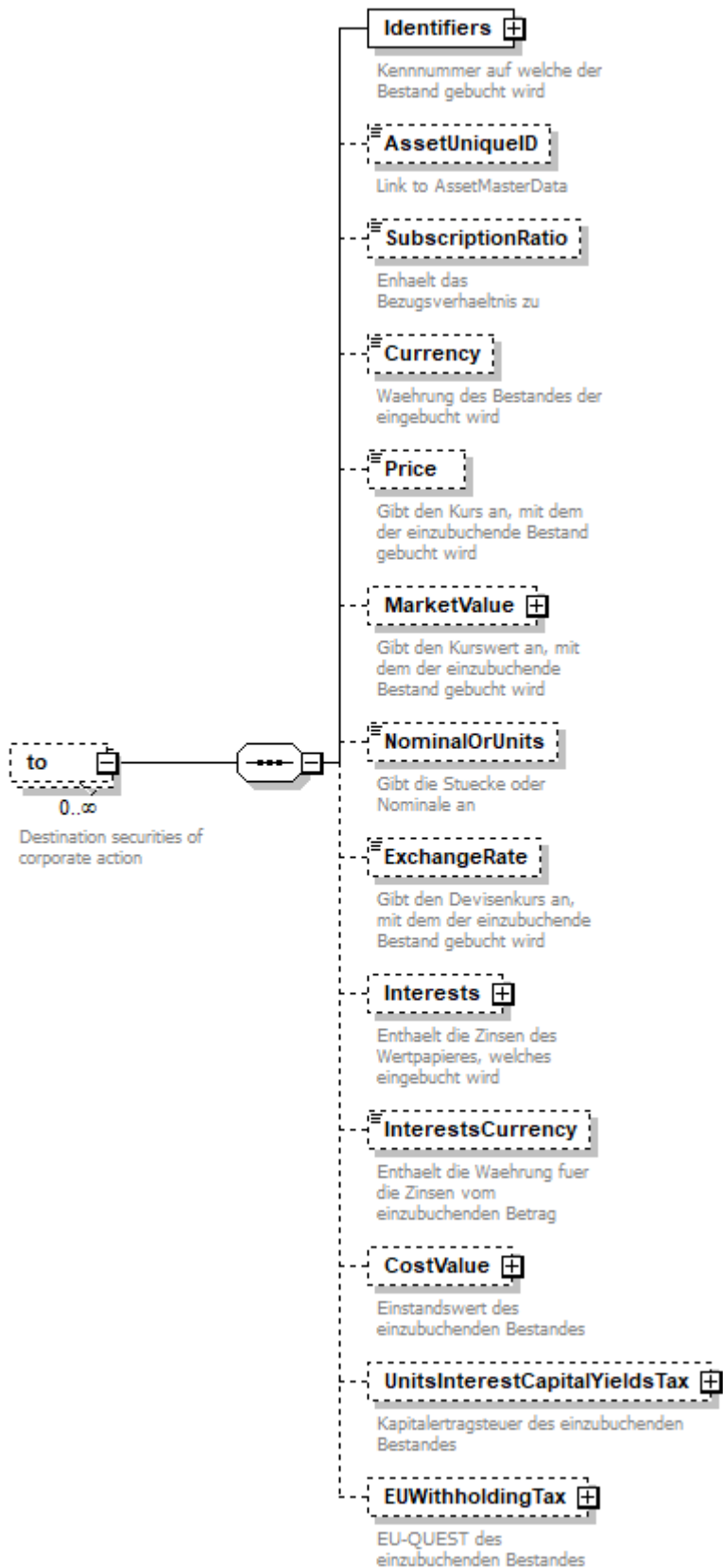



|            |  |
|------------|--|
| properties | isRef 0<br>minOcc 0<br>maxOcc unbounded<br>content complex   |
| children   | <a href="#">Identifiers</a> <a href="#">AssetUniqueID</a> <a href="#">SubscriptionRatio</a> <a href="#">Currency</a> <a href="#">Price</a> <a href="#">MarketValue</a> <a href="#">NominalOrUnits</a> <a href="#">ExchangeRate</a> <a href="#">Interests</a><br><a href="#">InterestsCurrency</a> <a href="#">CostValue</a> <a href="#">UnitsInterestCapitalYieldsTax</a> <a href="#">EUWithholdingTax</a> |
| annotation | documentation<br>Destination securities of corporate action  |

element **TransactionType/CorporateAction/to/Identifiers**

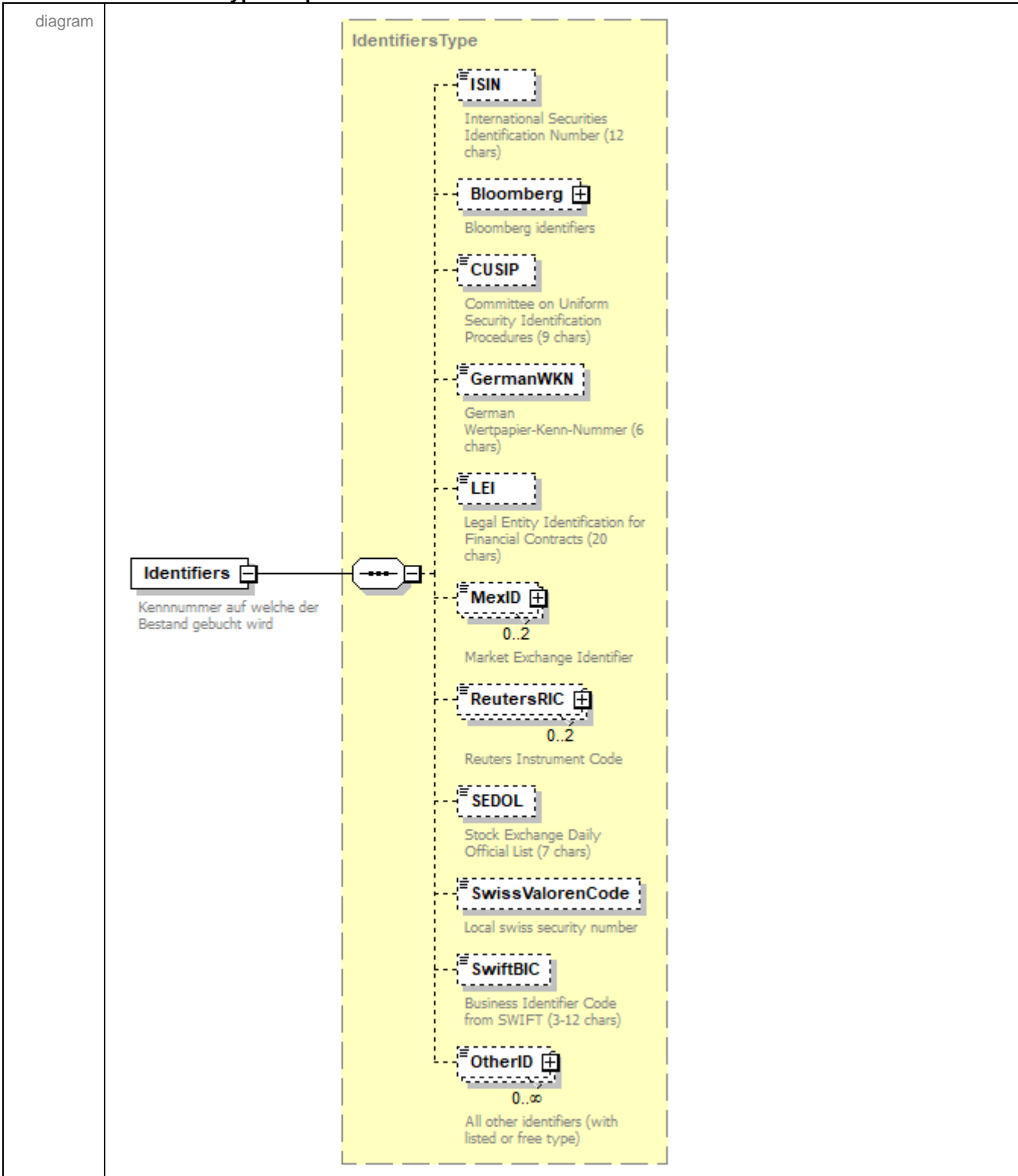

|            |   |
|------------|---|
| type       | <a href="#">IdentifiersType</a>   |
| properties | isRef 0<br>content complex  |
| children   | <a href="#">ISIN</a> <a href="#">Bloomberg</a> <a href="#">CUSIP</a> <a href="#">GermanWKN</a> <a href="#">LEI</a> <a href="#">MexID</a> <a href="#">ReutersRIC</a> <a href="#">SEDOL</a> <a href="#">SwissValorenCode</a> <a href="#">SwiftBIC</a> <a href="#">OtherID</a> |

|            |   |
|------------|---|
| annotation | documentation<br>Kennnummer auf welche der Bestand gebucht wird |
|------------|---|

element **TransactionType/CorporateAction/to/AssetUniqueID**

|            |   |
|------------|---|
| diagram    |                  |
| type       | restriction of <b>xs:IDREF</b>  |
| properties | isRef 0<br>minOcc 0<br>maxOcc 1<br>content simple   |
| facets     | Kind Value annotation<br>maxLength 256  |
| annotation | documentation<br>Link to AssetMasterData<br>documentation<br>Referenz zu den Wertpapierstammdaten |

element **TransactionType/CorporateAction/to/SubscriptionRatio**

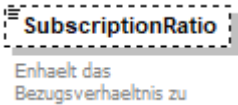
|            |   |
|------------|---|
| diagram    |  |
| type       | <b>xs:decimal</b>   |
| properties | isRef 0<br>minOcc 0<br>maxOcc 1<br>content simple                                 |
| annotation | documentation<br>Enhaelt das Bezugsverhaeltnis zu                                 |

element **TransactionType/CorporateAction/to/Currency**

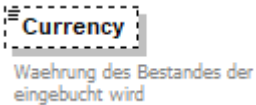
|            |   |
|------------|---|
| diagram    |  |
| type       | <a href="#">ISOCurrencyCodeType</a>   |
| properties | isRef 0<br>minOcc 0<br>maxOcc 1<br>content simple                                   |
| facets     | Kind Value annotation<br>minLength 3<br>maxLength 3<br>pattern [A-Z]{3}             |
| annotation | documentation<br>Waehrung des Bestandes der eingebucht wird                         |

element **TransactionType/CorporateAction/to/Price**

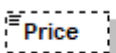
|            |   |
|------------|---|
| diagram    |  <p>Gibt den Kurs an, mit dem der einzubuchende Bestand gebucht wird</p> |
| type       | <b>xs:decimal</b>   |
| properties | isRef 0<br>minOcc 0<br>maxOcc 1<br>content simple   |
| annotation | documentation<br>Gibt den Kurs an, mit dem der einzubuchende Bestand gebucht wird   |

element **TransactionType/CorporateAction/to/MarketValue**

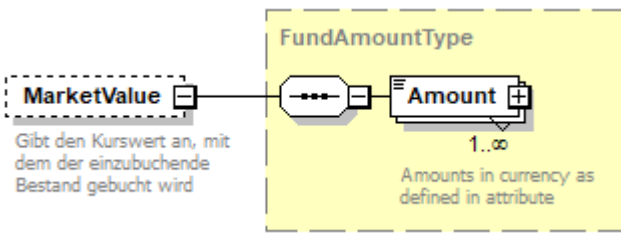
|            |  |
|------------|--|
| diagram    |  <p>Gibt den Kurswert an, mit dem der einzubuchende Bestand gebucht wird</p> <p>Amounts in currency as defined in attribute</p> |
| type       | <a href="#">FundAmountType</a>   |
| properties | isRef 0<br>minOcc 0<br>maxOcc 1<br>content complex   |
| children   | <a href="#">Amount</a>   |
| annotation | documentation<br>Gibt den Kurswert an, mit dem der einzubuchende Bestand gebucht wird  |

element **TransactionType/CorporateAction/to/NominalOrUnits**

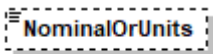
|            |  |
|------------|--|
| diagram    |  <p>Gibt die Stuecke oder Nominale an</p> |
| type       | <b>xs:decimal</b>  |
| properties | isRef 0<br>minOcc 0<br>maxOcc 1<br>content simple  |
| annotation | documentation<br>Gibt die Stuecke oder Nominale an   |

element **TransactionType/CorporateAction/to/ExchangeRate**

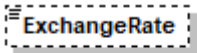
|         |  |
|---------|--|
| diagram |  <p>Gibt den Devisenkurs an, mit dem der einzubuchende Bestand gebucht wird</p> |
|---------|--|

|            |  |
|------------|--|
| type       | <b>xs:decimal</b>  |
| properties | isRef 0<br>minOcc 0<br>maxOcc 1<br>content simple  |
| annotation | documentation<br>Gibt den Devisenkurs an, mit dem der einzubuchende Bestand gebucht wird |

**element TransactionType/CorporateAction/to/Interests**

|            |   |
|------------|---|
| diagram    | <p>The diagram shows a dashed box labeled 'Interests' containing the text 'Enthaelt die Zinsen des Wertpapiers, welches eingebucht wird'. To its right is a yellow box labeled 'FundAmountType' containing an 'Amount' element with a multiplicity of '1..∞' and the text 'Amounts in currency as defined in attribute'. A line connects the 'Interests' box to the 'Amount' box.</p> |
| type       | <a href="#">FundAmountType</a>  |
| properties | isRef 0<br>minOcc 0<br>maxOcc 1<br>content complex  |
| children   | <a href="#">Amount</a>  |
| annotation | documentation<br>Enthaelt die Zinsen des Wertpapiers, welches eingebucht wird   |

**element TransactionType/CorporateAction/to/InterestsCurrency**

| diagram    | <p>The diagram shows a dashed box labeled 'InterestsCurrency' containing the text 'Enthaelt die Waehrung fuer die Zinsen vom einzubuchenden Betrag'.</p>  |            |       |            |           |   |  |           |   |  |         |          |  |
|------------|---|------------|-------|------------|-----------|---|--|-----------|---|--|---------|----------|--|
| type       | <a href="#">ISOCurrencyCodeType</a>   |            |       |            |           |   |  |           |   |  |         |          |  |
| properties | isRef 0<br>minOcc 0<br>maxOcc 1<br>content simple   |            |       |            |           |   |  |           |   |  |         |          |  |
| facets     | <table border="1"> <thead> <tr> <th>Kind</th> <th>Value</th> <th>annotation</th> </tr> </thead> <tbody> <tr> <td>minLength</td> <td>3</td> <td></td> </tr> <tr> <td>maxLength</td> <td>3</td> <td></td> </tr> <tr> <td>pattern</td> <td>[A-Z]{3}</td> <td></td> </tr> </tbody> </table> | Kind       | Value | annotation | minLength | 3 |  | maxLength | 3 |  | pattern | [A-Z]{3} |  |
| Kind       | Value   | annotation |       |            |           |   |  |           |   |  |         |          |  |
| minLength  | 3   |            |       |            |           |   |  |           |   |  |         |          |  |
| maxLength  | 3   |            |       |            |           |   |  |           |   |  |         |          |  |
| pattern    | [A-Z]{3}  |            |       |            |           |   |  |           |   |  |         |          |  |
| annotation | documentation<br>Enthaelt die Waehrung fuer die Zinsen vom einzubuchenden Betrag  |            |       |            |           |   |  |           |   |  |         |          |  |

element **TransactionType/CorporateAction/to/CostValue**

|            |  |
|------------|--|
| diagram    |  |
| type       | <a href="#">FundAmountType</a>   |
| properties | <ul style="list-style-type: none"> <li>isRef 0</li> <li>minOcc 0</li> <li>maxOcc 1</li> <li>content complex</li> </ul> |
| children   | <a href="#">Amount</a>   |
| annotation | <ul style="list-style-type: none"> <li>documentation</li> <li>Einstandswert des einzubuchenden Bestandes</li> </ul>    |

element **TransactionType/CorporateAction/to/UnitsInterestCapitalYieldsTax**

|            |   |
|------------|---|
| diagram    |   |
| type       | <a href="#">FundAmountType</a>  |
| properties | <ul style="list-style-type: none"> <li>isRef 0</li> <li>minOcc 0</li> <li>maxOcc 1</li> <li>content complex</li> </ul>    |
| children   | <a href="#">Amount</a>  |
| annotation | <ul style="list-style-type: none"> <li>documentation</li> <li>Kapitalertragsteuer des einzubuchenden Bestandes</li> </ul> |

element **TransactionType/CorporateAction/to/EUWithholdingTax**

|            |  |
|------------|--|
| diagram    |  |
| type       | <a href="#">FundAmountType</a>   |
| properties | <ul style="list-style-type: none"> <li>isRef 0</li> <li>minOcc 0</li> <li>maxOcc 1</li> <li>content complex</li> </ul> |
| children   | <a href="#">Amount</a>   |

|            |  |
|------------|--|
| annotation | documentation<br>EU-QUEST des einzubuchenden Bestandes |
|------------|--|

element **TransactionType/CorporateAction/CorporateActionKind**

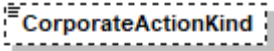
|            |  |
|------------|--|
| diagram    |  <p>S = Split<br/>RS = Reversesplit<br/>M = Merger<br/>SD = Stock dividend<br/>NSinS = New Shares in Shares<br/>DEM = Demerger<br/>RI = Rights issue<br/>ESC = Exchange of share certificate<br/>CD = Capital Decrease<br/>GenM= General Meetings</p> |
| type       | restriction of <b>xs:string</b>  |
| properties | isRef 0<br>minOcc 0<br>maxOcc 1<br>content simple  |
| annotation | documentation<br>S = Split<br>RS = Reversesplit<br>M = Merger<br>SD = Stock dividend<br>NSinS = New Shares in Shares<br>DEM = Demerger<br>RI = Rights issue<br>ESC = Exchange of share certificate<br>CD = Capital Decrease<br>GenM= General Meetings  |

element **TransactionType/CorporateAction/ExDividendDate**

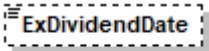
|            |  |
|------------|--|
| diagram    |  <p>Ex dividend day of the corporate action</p> |
| type       | <b>xs:date</b>   |
| properties | isRef 0<br>minOcc 0<br>maxOcc 1<br>content simple  |
| annotation | documentation<br>Ex dividend day of the corporate action<br>documentation<br>Extag   |

element **TransactionType/CorporateAction/ExpensesValutaDate**

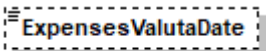
|         |   |
|---------|---|
| diagram |  <p>Valuta day of expenses</p> |
| type    | <b>xs:date</b>  |

|            |  |
|------------|--|
| properties | isRef 0<br>minOcc 0<br>maxOcc 1<br>content simple  |
| annotation | documentation<br>Valuta day of expenses<br>documentation<br>Gibt das Valutadatum der Spesen an |

element **TransactionType/CorporateAction/ExpensesExchangeRate**

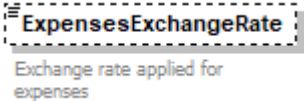
|            |  |
|------------|--|
| diagram    |  <p>Exchange rate applied for expenses</p>                |
| type       | <b>xs:decimal</b>  |
| properties | isRef 0<br>minOcc 0<br>maxOcc 1<br>content simple  |
| annotation | documentation<br>Exchange rate applied for expenses<br>documentation<br>Enthaelt den Devisenkurs der fuer die Spesenbuchung verwendet wird |

element **TransactionType/CorporateAction/Expenses**

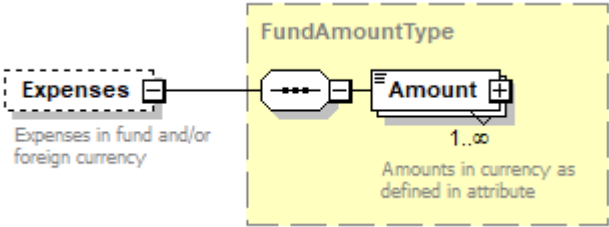
|            |   |
|------------|---|
| diagram    |  <p>Expenses in fund and/or foreign currency</p> <p>FundAmountType</p> <p>Amount<br/>1..∞<br/>Amounts in currency as defined in attribute</p> |
| type       | <a href="#">FundAmountType</a>  |
| properties | isRef 0<br>minOcc 0<br>maxOcc 1<br>content complex  |
| children   | <a href="#">Amount</a>  |
| annotation | documentation<br>Expenses in fund and/or foreign currency<br>documentation<br>Enthaelt den Spesenbetrag in Fonds- und Fremdwahrung  |

element **TransactionType/CorporateAction/AccountNumberExpenses**

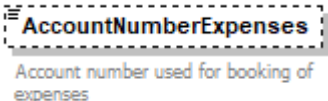
|            |  |
|------------|--|
| diagram    |  <p>Account number used for booking of expenses</p> |
| type       | <b>xs:integer</b>  |
| properties | isRef 0<br>minOcc 0<br>maxOcc 1  |



|            |  |
|------------|--|
|            | content simple   |
| annotation | documentation<br>Account number used for booking of expenses<br>documentation<br>Gibt das Spesenkonto an |

element **TransactionType/CorporateAction/UnitInterestEUWithholdingTax**

|            |   |
|------------|---|
| diagram    |   |
| type       | <a href="#">FundAmountType</a>  |
| properties | isRef 0<br>minOcc 0<br>maxOcc 1<br>content complex  |
| children   | <a href="#">Amount</a>  |
| annotation | documentation<br>Unit interests to be used for calculating EU withholding tax<br>documentation<br>Gibt die StueckZinsen fuer die Berechnung der EU-QUEST an |

element **TransactionType/CorporateAction/CorporateActionDocument**

|            |   |
|------------|---|
| diagram    |   |
| properties | isRef 0<br>minOcc 0<br>maxOcc 1<br>content complex                            |
| children   | <a href="#">Format</a> <a href="#">DocumentURL</a> <a href="#">BinaryData</a> |
| annotation | documentation<br>Text document describing details of corporate action         |

element **TransactionType/CorporateAction/CorporateActionDocument/Format**

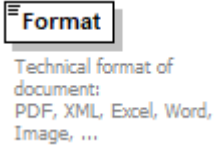
|            |   |
|------------|---|
| diagram    |    |
| type       | <a href="#">Text256Type</a>   |
| properties | isRef 0<br>content simple   |
| facets     | Kind Value annotation<br>maxLength 256  |
| annotation | documentation<br>Technical format of document:<br>PDF, XML, Excel, Word, Image, ... |

element **TransactionType/CorporateAction/CorporateActionDocument/DocumentURL**

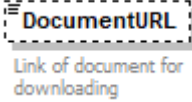
|            |   |
|------------|---|
| diagram    |  |
| type       | <a href="#">Text1000Type</a>  |
| properties | isRef 0<br>minOcc 0<br>maxOcc 1<br>content simple                                 |
| facets     | Kind Value annotation<br>maxLength 1000   |
| annotation | documentation<br>Link of document for downloading                                 |

element **TransactionType/CorporateAction/CorporateActionDocument/BinaryData**

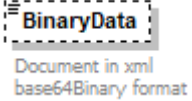
|            |   |
|------------|---|
| diagram    |  |
| type       | <b>xs:base64Binary</b>  |
| properties | isRef 0<br>minOcc 0<br>maxOcc 1<br>content simple                                   |
| annotation | documentation<br>Document in xml base64Binary format                                |

element **TransactionType/FxSpot**

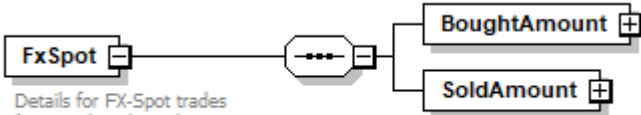
|            |   |
|------------|---|
| diagram    |  |
| annotation | documentation<br>Details for FX-Spot trades<br>(amount bought and amount sold)      |

|            |   |
|------------|---|
| properties | isRef 0<br>content complex  |
| children   | <a href="#">BoughtAmount</a> <a href="#">SoldAmount</a>                     |
| annotation | documentation<br>Details for FX-Spot trades (amount bought and amount sold) |

element **TransactionType/FxSpot/BoughtAmount**

|            |  |
|------------|--|
| diagram    | <p>The diagram shows a box labeled 'BoughtAmount' connected to a container (represented by a rounded rectangle with three dots) which is enclosed in a dashed yellow box labeled 'SingleAmountType'. Inside this container, there are two smaller boxes: 'Currency' and 'Value'.</p> |
| type       | <a href="#">SingleAmountType</a>   |
| properties | isRef 0<br>content complex   |
| children   | <a href="#">Currency</a> <a href="#">Value</a>   |

element **TransactionType/FxSpot/SoldAmount**

|            |  |
|------------|--|
| diagram    | <p>The diagram shows a box labeled 'SoldAmount' connected to a container (represented by a rounded rectangle with three dots) which is enclosed in a dashed yellow box labeled 'SingleAmountType'. Inside this container, there are two smaller boxes: 'Currency' and 'Value'.</p> |
| type       | <a href="#">SingleAmountType</a>   |
| properties | isRef 0<br>content complex   |
| children   | <a href="#">Currency</a> <a href="#">Value</a>   |

element **TransactionType/CustomAttributes**

|            |  |
|------------|--|
| diagram    | <p>The diagram shows a dashed box labeled 'CustomAttributes' connected to a container (represented by a rounded rectangle with three dots) which is enclosed in a dashed yellow box labeled 'AttributesType'. Inside this container, there is one box labeled 'Attribute' with a '1..∞' cardinality indicator below it.</p> <p>Additional information which does not fit in the existing nodes above</p> |
| type       | <a href="#">AttributesType</a>   |
| properties | isRef 0<br>minOcc 0<br>maxOcc 1<br>content complex   |
| children   | <a href="#">Attribute</a>  |
| annotation | documentation<br>Additional information which does not fit in the existing nodes above   |

XML Schema documentation generated by [XMLSpy](http://www.altova.com/xmlspy) Schema Editor <http://www.altova.com/xmlspy>